



FCC TEST REPORT

**Test report
On Behalf of
MOVEON TECHNOLOGY LIMITED
For
Smart Phone
Model No.: LitePro**

FCC ID: 2AFD9LITEPRO

Prepared for : MOVEON TECHNOLOGY LIMITED
World Trade Plaza-A block #3201-3202 Fuhong Road, Futian, Shenzhen, China

Prepared By : Shenzhen HUAKE Testing Technology Co., Ltd.
1F, B2 Building, Junfeng Zhongcheng Zhizao Innovation Park, Fuhai Street, Bao'an District, Shenzhen City, China

Date of Test: Sep. 26, 2018~Oct, 17, 2018

Date of Report: Oct. 17, 2018

Report Number: HK1809271161E



TEST RESULT CERTIFICATION

Applicant's name : MOVEON TECHNOLOGY LIMITED
Address : World Trade Plaza-A block #3201-3202 Fuhong Road, Futian, Shenzhen, China
Manufacture's Name..... : MOVEON TECHNOLOGY LIMITED
Address : World Trade Plaza-A block #3201-3202 Fuhong Road, Futian, Shenzhen, China
Product description : Smart Phone
Brand Name : ZOOM
Mode Name : LitePro
Standards : FCC Rules and Regulations Part 15 Subpart C Section 15.247
KDB 558074 D01 15.247 Meas Guidance v05

This publication may be reproduced in whole or in part for non-commercial purposes as long as the Shenzhen HUAKE Testing Technology Co., Ltd. is acknowledged as copyright owner and source of the material. Shenzhen HUAKE Testing Technology Co., Ltd. takes no responsibility for and will not assume liability for damages resulting from the reader's interpretation of the reproduced material due to its placement and context.

Date of Test :
Date (s) of performance of tests : **Sep. 26, 2018~Oct. 17, 2018**
Date of Issue..... : **Oct. 17, 2018**
Test Result..... : **Pass**

Testing Engineer : 

(Gary Qian)

Technical Manager : 

(Eden Hu)

Authorized Signatory : 

(Jason Zhou)



TABLE OF CONTENTS

1. GENERAL INFORMATION	6
1.1 PRODUCT DESCRIPTION	6
1.2 RELATED SUBMITTAL(S)/GRANT(S)	7
1.3 TEST METHODOLOGY	7
1.4 TEST FACILITY	8
1.5 SPECIAL ACCESSORIES	8
1.6 EQUIPMENT MODIFICATIONS	8
2. MEASUREMENT UNCERTAINTY	9
4. SYSTEM TEST CONFIGURATION	10
4.1 CONFIGURATION OF TESTED SYSTEM	10
4.2 EQUIPMENT USED IN TESTED SYSTEM	10
5. SUMMARY OF TEST RESULTS	12
6. DESCRIPTION OF TEST MODES	13
7. RADIATED EMISSION	14
7.1 MEASUREMENT PROCEDURE	14
7.2 TEST SETUP	15
7.3 LIMITS AND MEASUREMENT RESULT	16
7.4 TEST RESULT	17
8. BAND EDGE EMISSION	20
8.1. MEASUREMENT PROCEDURE	20
8.2. TEST SET-UP	20
8.3. RADIATED TEST RESULT	21
8.4. CONDUCTED TEST RESULT	22
9.6DB BANDWIDTH	23
9.1. TEST PROCEDURE	23
9.2. SUMMARY OF TEST RESULTS/PLOTS	23
10. CONDUCTED OUTPUT POWER	24
10.1. MEASUREMENT PROCEDURE	24
10.2. TEST SET-UP (BLOCK DIAGRAM OF CONFIGURATION)	24
10.3. LIMITS AND MEASUREMENT RESULT	25
11. MAXIMUM CONDUCTED OUTPUT POWER SPECTRAL DENSITY	26
11.1 MEASUREMENT PROCEDURE	26
11.2 TEST SET-UP (BLOCK DIAGRAM OF CONFIGURATION)	26



11.3 LIMITS AND MEASUREMENT RESULT	27
12. FCC LINE CONDUCTED EMISSION TEST	28
12.1 LIMITS	28
12.2 TEST SETUP.....	28
12.3 PRELIMINARY PROCEDURE	29
12.4 FINAL TEST PROCEDURE	29
12.5 TEST RESULT OF POWER LINE	30
13. CONDUCTED SPURIOUS EMISSION	32
13.1. MEASUREMENT PROCEDURE	32
13.2. TEST SET-UP (BLOCK DIAGRAM OF CONFIGURATION)	33
13.3. MEASUREMENT EQUIPMENT USED	33
13.4. LIMITS AND MEASUREMENT RESULT.....	33
APPENDIX A: PHOTOGRAPHS OF TEST SETUP	36



Revision	Issue Date	Revisions	Revised By
V1.0	Oct. 17, 2018	Initial Issue	Jason Zhou



1. GENERAL INFORMATION

1.1 PRODUCT DESCRIPTION

The EUT is designed as "Smart Phone". It is designed by way of utilizing the GFSK technology to achieve the system operation.

A major technical description of EUT is described as following:

Operation Frequency	2.402 GHz to 2.480GHz
Bluetooth Version	BLE
Modulation	GFSK
Number of channels	40 Channel(37 Hopping Channel,3 advertising Channel)
Antenna Designation	PIFA Antenna
Antenna Gain	1.0dBi
Hardware Version	7130D-MMI-V10
Software Version	Zoom_LitePro_001_20180903
Power Supply	DC3.7V by Battery



1.2 RELATED SUBMITTAL(S)/GRANT(S)

This submittal(s) (test report) is intended for **FCC ID: 2AFD9LITEPRO** filing to comply with Section 15.247 of the FCC Part 15, Subpart C Rules.

1.3 TEST METHODOLOGY

All measurements contained in this report were conducted with KDB 558074, American National Standard for Methods of Measurement of Radio-Noise Emissions from Low-Voltage Electrical and Electronic Equipment in the range of 9 kHz to 40 GHz.

The equipment under test (EUT) was configured to measure its highest possible emission level. The test modes were adapted accordingly in reference to the Operating Instructions. The EUT was tested in all three orthogonal planes and the worse case was showed.

**1.4 TEST FACILITY**

Site	Shenzhen HUAK Testing Technology Co., Ltd.
Location	1F, B2 Building, Junfeng Zhongcheng Zhizao Innovation Park, Fuhai Street, Bao'an District, Shenzhen City, China
Designation Number	CN1229
Test Firm Registration Number : 616276	

1.5 SPECIAL ACCESSORIES

Refer to section 2.2.

1.6 EQUIPMENT MODIFICATIONS

Not available for this EUT intended for grant.



2. MEASUREMENT UNCERTAINTY

Test	Measurement Uncertainty	Notes
Transmitter power conducted	± 0.57 dB	(1)
Transmitter power Radiated	± 2.20 dB	(1)
Conducted spurious emission 9KHz-40 GHz	± 2.20 dB	(1)
Occupied Bandwidth	± 0.01 ppm	(1)
Radiated Emission 30~1000MHz	± 4.10 dB	(1)
Radiated Emission Above 1GHz	± 4.32 dB	(1)
Conducted Disturbance 0.15~30MHz	± 3.20 dB	(1)

Note: This uncertainty represents an expanded uncertainty expressed at approximately the 95% confidence level using a coverage factor of $k=2$.



4. SYSTEM TEST CONFIGURATION

4.1 CONFIGURATION OF TESTED SYSTEM

Configuration:

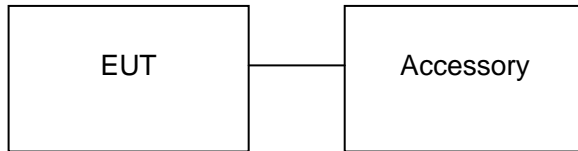

4.2 EQUIPMENT USED IN TESTED SYSTEM

Item	Equipment	Model No.	ID or Specification	Remark
1	Smart Phone	LitePro	2AFD9LITEPRO	EUT
2	Adapter	LitePro	DC 5.0V 1A	Accessory
3	Battery	LitePro	DC 3.7V/2500mAh	Accessory
4	Earphone	N/A	N/A	Accessory
5	USB	N/A	N/A	Accessory

**ALL TEST EQUIPMENT LIST**

RF Test Room				
Equipment	Manufacturer	Model	Serial Number	Calibration Due
Power Sensor	Agilent	E9327A	HKE-113	Dec. 28, 2018
RF cable	Times	1-40G	HKE-034	Dec. 28, 2018
RF automatic control unit	Tonscend	JS0806-2	HKE-060	Dec. 28, 2018
Spectrum analyzer	Agilent	N9020A	HKE-048	Dec. 28, 2018
RF Cable (9KHz-26.5GHz)	Tonscend	170660	N/A	Dec. 28, 2018
Signal generator	Agilent	N5183A	HKE-071	Dec. 28, 2018
Receiver	R&S	ESCI-7	HKE-010	Dec. 28, 2018
Spectrum analyzer	Agilent	N9020A	HKE-048	Dec. 28, 2018
Preamplifier	EMCI	EMC051845SE	HKE-015	Dec. 28, 2018
Preamplifier	Agilent	83051A	HKE-016	Dec. 28, 2018
Loop antenna	Schwarzbeck	FMZB 1519 B	HKE-014	Dec. 28, 2018
Broadband antenna	Schwarzbeck	VULB 9163	HKE-012	Dec. 28, 2018
Horn antenna	Schwarzbeck	9120D	HKE-013	Dec. 28, 2018
Antenna Mast	Keleto	CC-A-4M	N/A	N/A
Position controller	Taiwan MF	MF7802	HKE-011	Dec. 28, 2018
Radiated test software	Tonscend	TS+ Rev 2.5.0.0	HKE-082	N/A
RF cable (9KHz-1GHz)	Times	381806-001	N/A	N/A
RF cable	Times	1-40G	HKE-034	Dec. 28, 2018

**5. SUMMARY OF TEST RESULTS**

FCC RULES	DESCRIPTION OF TEST	RESULT
§15.203	Antenna Requirement	Compliant
§15.209 §15.247(d)	Radiated Emission	Compliant
§15.247(d)	Band Edges	Compliant
§15.247	6 dB Bandwidth	Compliant
§15.247(b)	Conducted Power	Compliant
§15.247(e)	Maximum Conducted Output Power SPECTRAL Density	Compliant
§15.207	Line Conduction Emission	Compliant
§15.207	Conduction Emission	Compliant



6. DESCRIPTION OF TEST MODES

The EUT has been operated in three modulations: GFSK independently.

NO.	TEST MODE DESCRIPTION
1	Low channel TX
2	Middle channel TX
3	High channel TX
4	Normal Operating (BT)

Note:

1. All the test modes can be supply by Built-in Li-ion battery, only the result of the worst case was recorded in the report if no any records.
2. For Radiated Emission, 3axis were chosen for testing for each applicable mode.
3. EUT is operating at its maximum duty cycle>or equal 98%



7. RADIATED EMISSION

7.1 MEASUREMENT PROCEDURE

1. The EUT was placed on the top of the turntable 0.8 or 1.5 meter above ground. The phase center of the receiving antenna mounted on the top of a height-variable antenna tower was placed 3 meters far away from the turntable.
2. Power on the EUT and all the supporting units. The turntable was rotated by 360 degrees to determine the position of the highest radiation.
3. The height of the broadband receiving antenna was varied between one meter and four meters above ground to find the maximum emissions field strength of both horizontal and vertical polarization.
4. For each suspected emissions, the antenna tower was scan (from 1 M to 4 M) and then the turntable was rotated (from 0 degree to 360 degrees) to find the maximum reading.
5. Set the test-receiver system to Peak or CISPR quasi-peak Detect Function with specified bandwidth under Maximum Hold Mode.
6. For emissions above 1GHz, use 1MHz VBW and RBW for peak reading. Then 1MHz RBW and 10Hz VBW for average reading in spectrum analyzer. Place the measurement antenna away from each area of the EUT determined to be a source of emissions at the specified measurement distance, while keeping the measurement antenna aimed at the source of emissions at each frequency of significant emissions, with polarization oriented for maximum response. The measurement antenna may have to be higher or lower than the EUT, depending on the radiation pattern of the emission and staying aimed at the emission source for receiving the maximum signal. The final measurement antenna elevation shall be that which maximizes the emissions. The measurement antenna elevation for maximum emissions shall be restricted to a range of heights of from 1 m to 4 m above the ground or reference ground plane.
7. When the radiated emissions limits are expressed in terms of the average value of the emissions, and pulsed operation is employed, the measurement field strength shall be determined by averaging over one complete pulse train, including blanking intervals, as long as the pulse train does not exceed 0.1 seconds. As an alternative (provided the transmitter operates for longer than 0.1 seconds) or in cases where the pulse train exceeds 0.1 seconds, the measured field strength shall be determined from the average absolute voltage during a 0.1 second interval during which the field strength is at its maximum values.
8. If the emissions level of the EUT in peak mode was 3 dB lower than the average limit specified, then testing will be stopped and peak values of EUT will be reported, otherwise, the emissions which do not have 3 dB margin will be repeated one by one using the quasi-peak method for below 1GHz.
9. For testing above 1GHz, the emissions level of the EUT in peak mode was lower than average limit (that means the emissions level in peak mode also complies with the limit in average mode), then testing will be stopped and peak values of EUT will be reported, otherwise, the emissions will be measured in average mode again and reported.
10. In case the emission is lower than 30MHz, loop antenna has to be used for measurement and the recorded data should be QP measured by receiver. High - Low scan is not required in this case.



7.2 TEST SETUP

Radiated Emission Test-Setup Frequency Below 30MHz

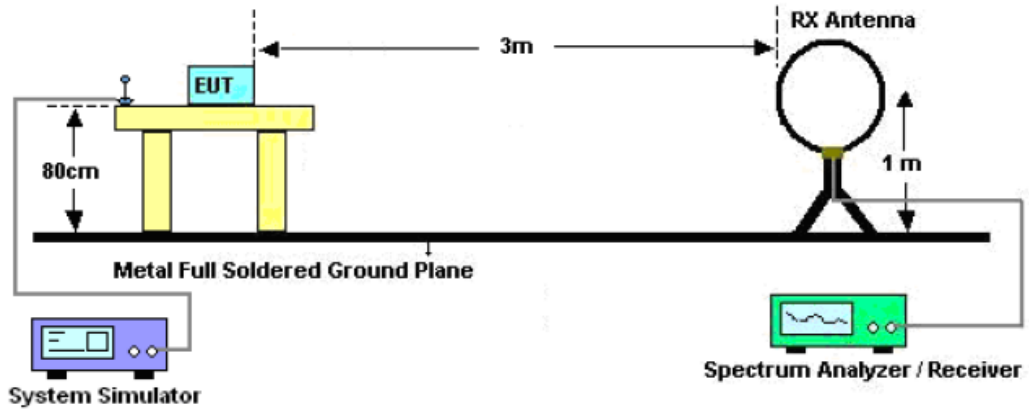

RADIATED EMISSION TEST SETUP 30MHz-1000MHz

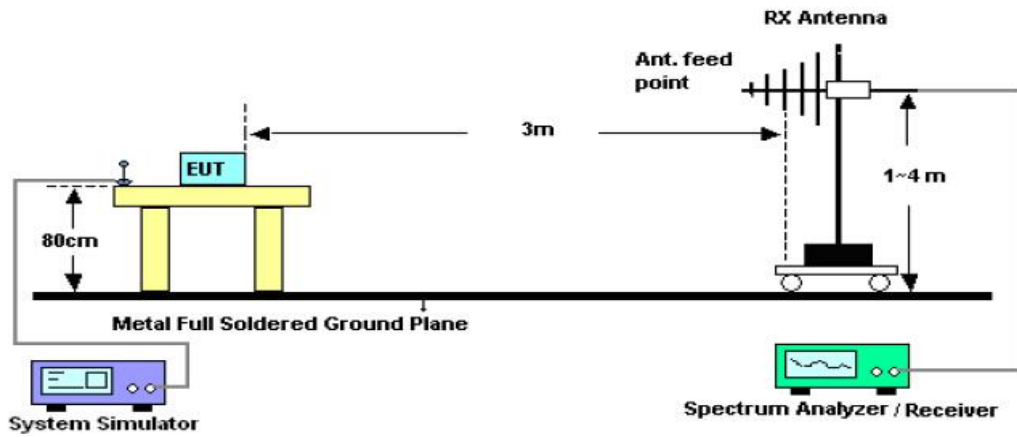

RADIATED EMISSION TEST SETUP ABOVE 1000MHz

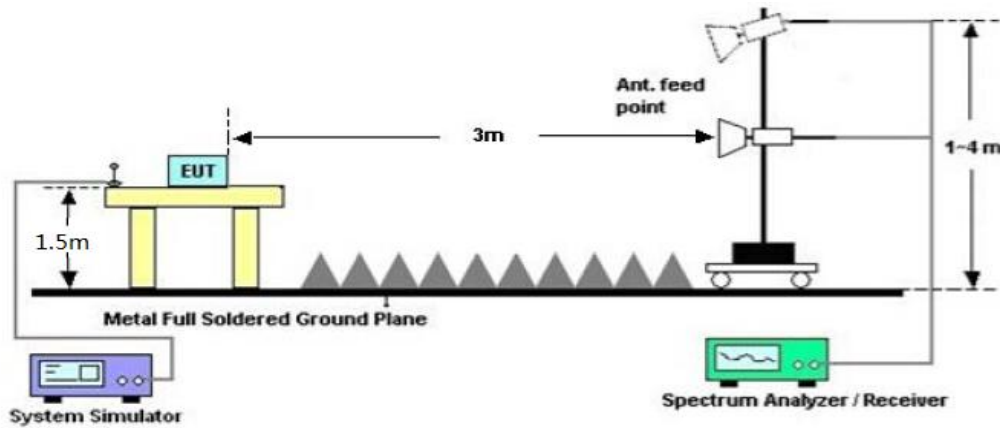



7.3 LIMITS AND MEASUREMENT RESULT

15.209 Limit in the below table has to be followed

Frequencies (MHz)	Field Strength (micorvolts/meter)	Measurement Distance (meters)
0.009~0.490	2400/F(KHz)	300
0.490~1.705	24000/F(KHz)	30
1.705~30.0	30	30
30~88	100	3
88~216	150	3
216~960	200	3
Above 960	500	3

Note: All modes were tested For restricted band radiated emission,
the test records reported below are the worst result compared to other modes.



7.4 TEST RESULT

RADIATED EMISSION BELOW 30MHZ

No emission found between lowest internal used/generated frequencies to 30MHz.

RADIATED EMISSION BELOW 1GHZ

RADIATED EMISSION TEST- (30MHZ-1GHZ) -HORIZONTAL

66.9 dBuV/m

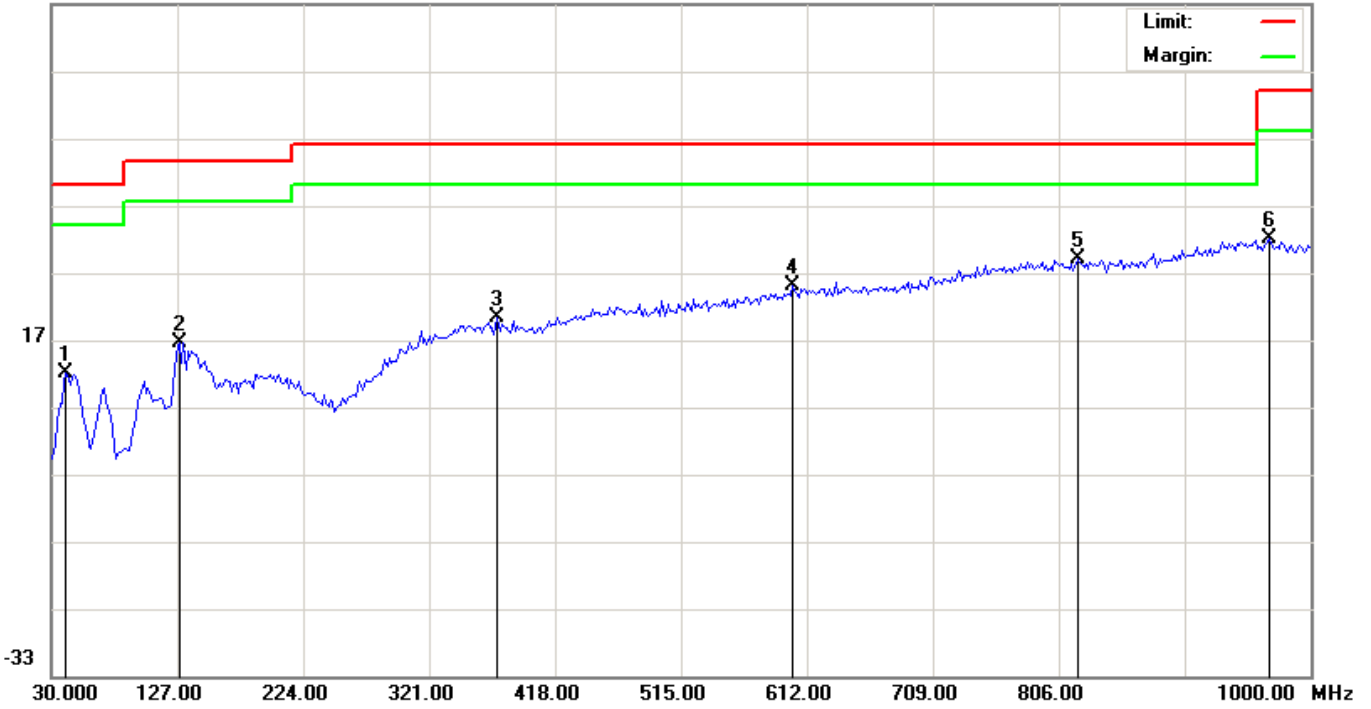

No.	Mk	Freq.	Reading	Factor	Measurement	Limit	Over	Detector	Antenna Height	Table Degree	Comment
		MHz	dBuV	dB/m	dBuV/m	dBuV/m	dB		cm	degree	
1		41.3167	0.14	11.81	11.95	40.00	-28.05	peak			
2		128.6167	6.73	9.88	16.61	43.50	-26.89	peak			
3		372.7333	1.44	18.89	20.33	46.00	-25.67	peak			
4		600.6833	1.29	23.73	25.02	46.00	-20.98	peak			
5	*	820.5500	1.69	27.32	29.01	46.00	-16.99	peak			
6		967.6667	2.14	29.83	31.97	54.00	-22.03	peak			

RESULT: PASS



RADIATED EMISSION TEST- (30MHZ-1GHZ) -VERTICAL

66.9 dBuV/m

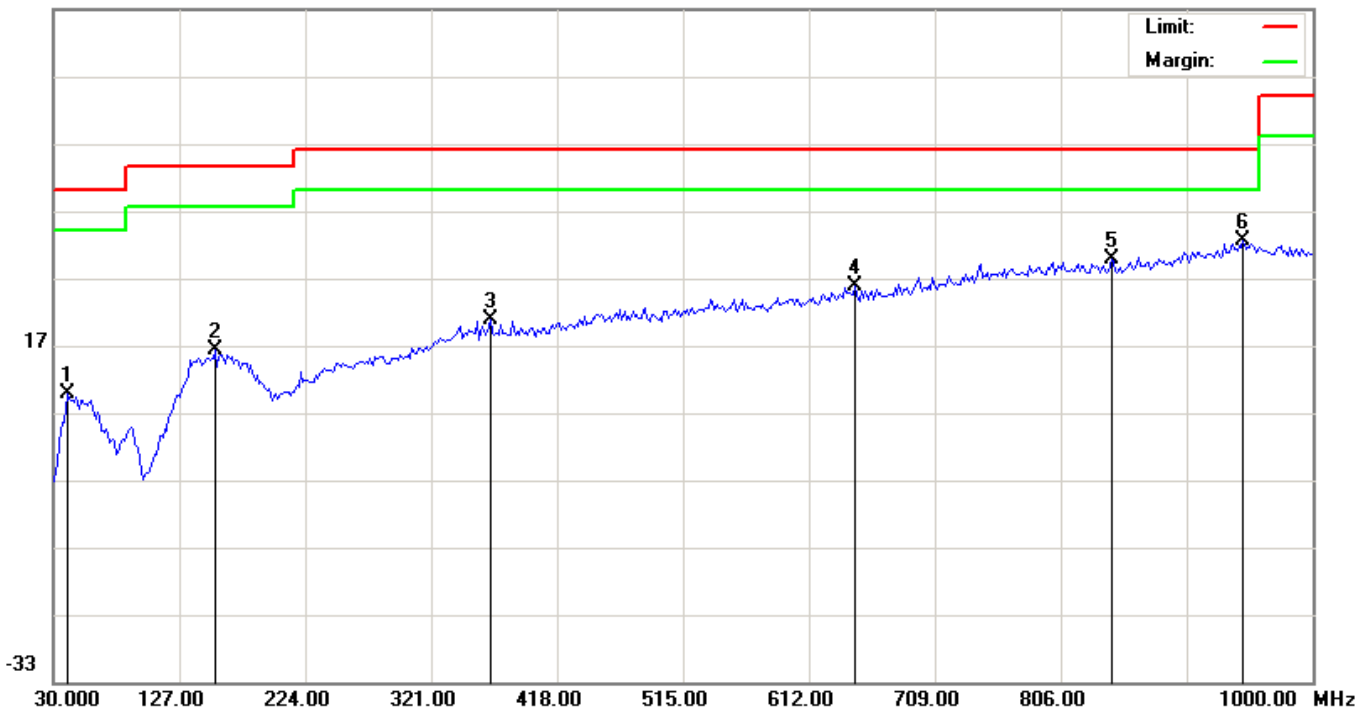

No.	Mk	Freq.	Reading	Factor	Measurement	Limit	Over	Detector	Antenna Height	Table Degree	Comment
		MHz	dBuV	dB/m	dBuV/m	dBuV/m	dB		cm	degree	
1		41.3167	0.95	8.81	9.76	40.00	-30.24	peak			
2		154.4833	0.91	15.29	16.20	43.50	-27.30	peak			
3		366.2667	1.97	18.85	20.82	46.00	-25.18	peak			
4		647.5667	1.94	23.80	25.74	46.00	-20.26	peak			
5		844.8000	2.54	27.31	29.85	46.00	-16.15	peak			
6	*	946.6500	2.59	29.91	32.50	46.00	-13.50	peak			

RESULT: PASS

Note: 1. Factor=Antenna Factor + Cable loss, Margin=Measurement-Limit.

2. The "Factor" value can be calculated automatically by software of measurement system.

3. All test modes for different EUT are pre-tested. The low channel for GFSK mode is the worst case and recorded in the report.

**RADIATED EMISSION ABOVE 1GHZ**

Frequency (MHz)	Emission Level (dB μ V/m)	Limits (dB μ V/m)	Margin (dB)	Detector Type	Comment
Low Channel (2402 MHz)					
4804	50.20	74	-23.8	Pk	Vertical
4804	40.48	54	-13.52	AV	Vertical
4804	53.35	74	-20.65	Pk	Horizontal
4804	37.27	54	-16.73	AV	Horizontal
Mid Channel (2440 MHz)					
4880	51.08	74	-22.92	Pk	Vertical
4880	39.39	54	-14.61	AV	Vertical
4880	49.78	74	-24.22	Pk	Horizontal
4880	38.75	54	-15.25	AV	Horizontal
High Channel (2480 MHz)					
4960	50.39	74	-23.61	pk	Vertical
4960	39.05	54	-14.95	AV	Vertical
4960	48.97	74	-25.03	pk	Horizontal
4960	39.33	54	-14.67	AV	Horizontal

RESULT: PASS

Note: 1~25GHz scan with GFSK. No recording in the test report at least have 20dB margin.

Factor = Antenna Factor + Cable Loss – Pre-amplifier.

Emission Level = Meter Reading + Factor

Margin = Emission - Level Limit



8. BAND EDGE EMISSION

8.1. MEASUREMENT PROCEDURE

1) Radiated restricted band edge measurements

The radiated restricted band edge measurements are measured with an EMI test receiver connected to the receive antenna while the EUT is transmitting

2) Conducted Emissions at the bang edge

a) The transmitter output was connected to the spectrum analyzer

b) Set RBW=100kHz, VBW=300kHz

c) Suitable frequency span including 100kHz bandwidth from band edge

8.2. TEST SET-UP

Radiated same as 6.2

Conducted set up

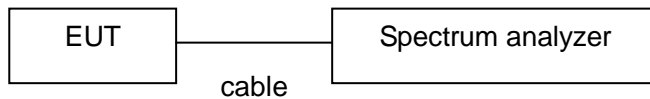

**8.3. RADIATED TEST RESULT**

Frequency	Emission Level	Limits	Margin	Detector	Comment
(MHz)	(dB μ V/m)	(dB μ V/m)	(dB)	Type	
GFSK					
2399.9	53.47	74	-20.53	peak	Vertical
2399.9	40.36	54	-13.64	AVG	Vertical
2399.9	51.42	74	-22.58	peak	Horizontal
2399.9	38.28	54	-15.72	AVG	Horizontal
2483.6	50.38	74	-23.62	peak	Vertical
2483.6	39.49	54	-14.51	AVG	Vertical
2483.6	49.36	74	-24.64	peak	Horizontal
2483.6	37.27	54	-16.73	AVG	Horizontal

RESULT: PASS

Note: Factor=Antenna Factor + Cable loss - Amplifier gain,

Emission Level = Meter Reading + Factor

Margin= Emission Level -Limit.

The "Factor" value can be calculated automatically by software of measurement system.



8.4. CONDUCTED TEST RESULT Test Graph

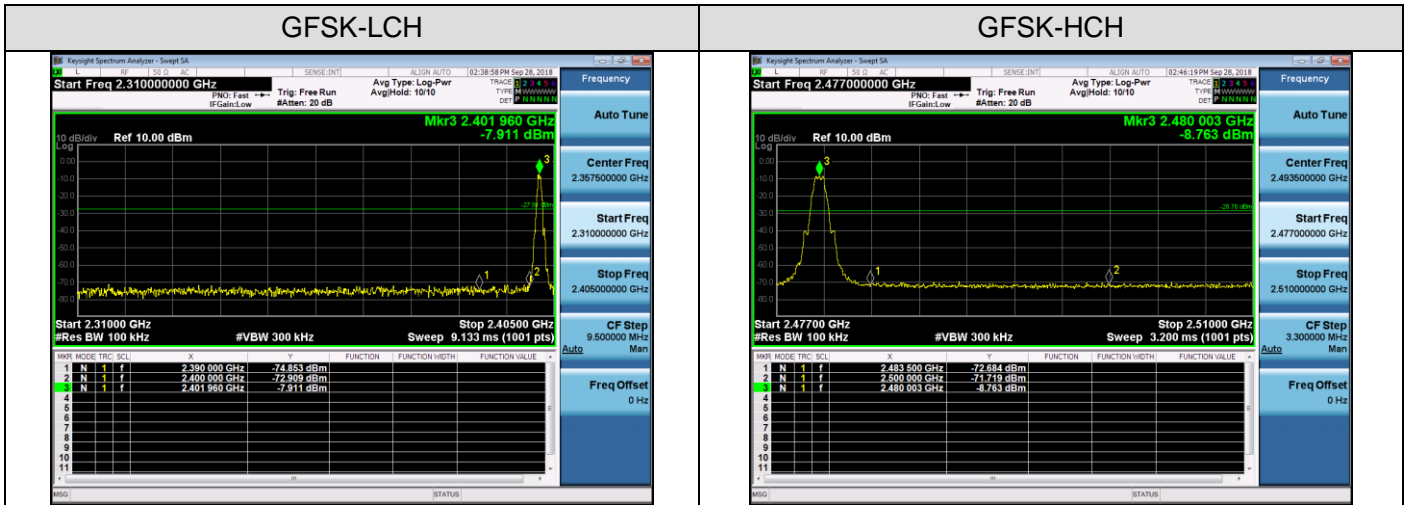



9.6DB BANDWIDTH

9.1. TEST PROCEDURE

1. Connect EUT RF output port to the Spectrum Analyzer through an RF attenuator
2. Set the EUT Work on the top, the middle and the bottom operation frequency individually.
3. Set SPA Centre Frequency = Operation Frequency, RBW= 100 KHz, VBW ≥ RBW.
4. Set SPA Trace 1 Max hold, then View.

9.2. SUMMARY OF TEST RESULTS/PLOTS

Mode	Channel	6dB Bandwidth [KHz]	Verdict
BLE	LCH	712.8	PASS
BLE	MCH	714.6	PASS
BLE	HCH	714.0	PASS

Test Graph





10. CONDUCTED OUTPUT POWER

10.1. MEASUREMENT PROCEDURE

1. Connect EUT RF output port to the Spectrum Analyzer through an RF attenuator
 2. Set the EUT Work on the top, middle and the bottom operation frequency individually.
 3. Use the following spectrum analyzer settings:
 - Set the RBW \geq DTS bandwidth
 - Set the VBW \geq 3 x RBW
 - Set the span \geq 3 x RBW
 - Detector = peak
 - Sweep time = auto couple
 - Trace mode = max hold
 4. Allow the trace to stabilize. Use peak marker function to determine the peak amplitude level
 5. Record the result form the Spectrum Analyzer.
- Note:** The EUT was tested according to KDB 558074 for compliance to FCC 47CFR 15.247 requirements.

10.2. TEST SET-UP (BLOCK DIAGRAM OF CONFIGURATION)

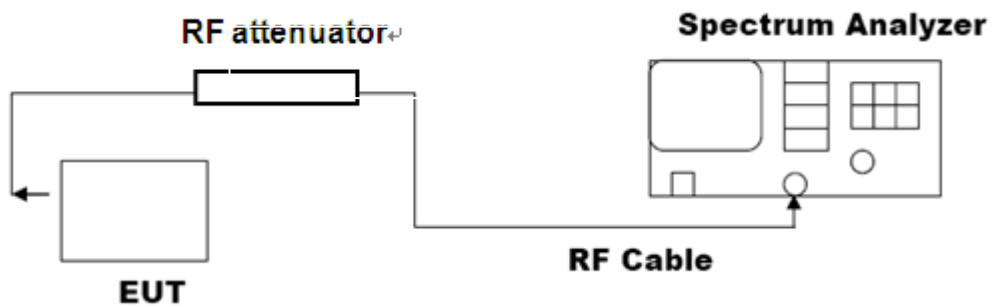



10.3. LIMITS AND MEASUREMENT RESULT

Channel	Peak Power (dBm)	Applicable Limits (dBm)	Pass/Fail
Low Channel	-6.058	30	Pass
Middle Channel	-6.551	30	Pass
High Channel	-7.904	30	Pass

Test Graph

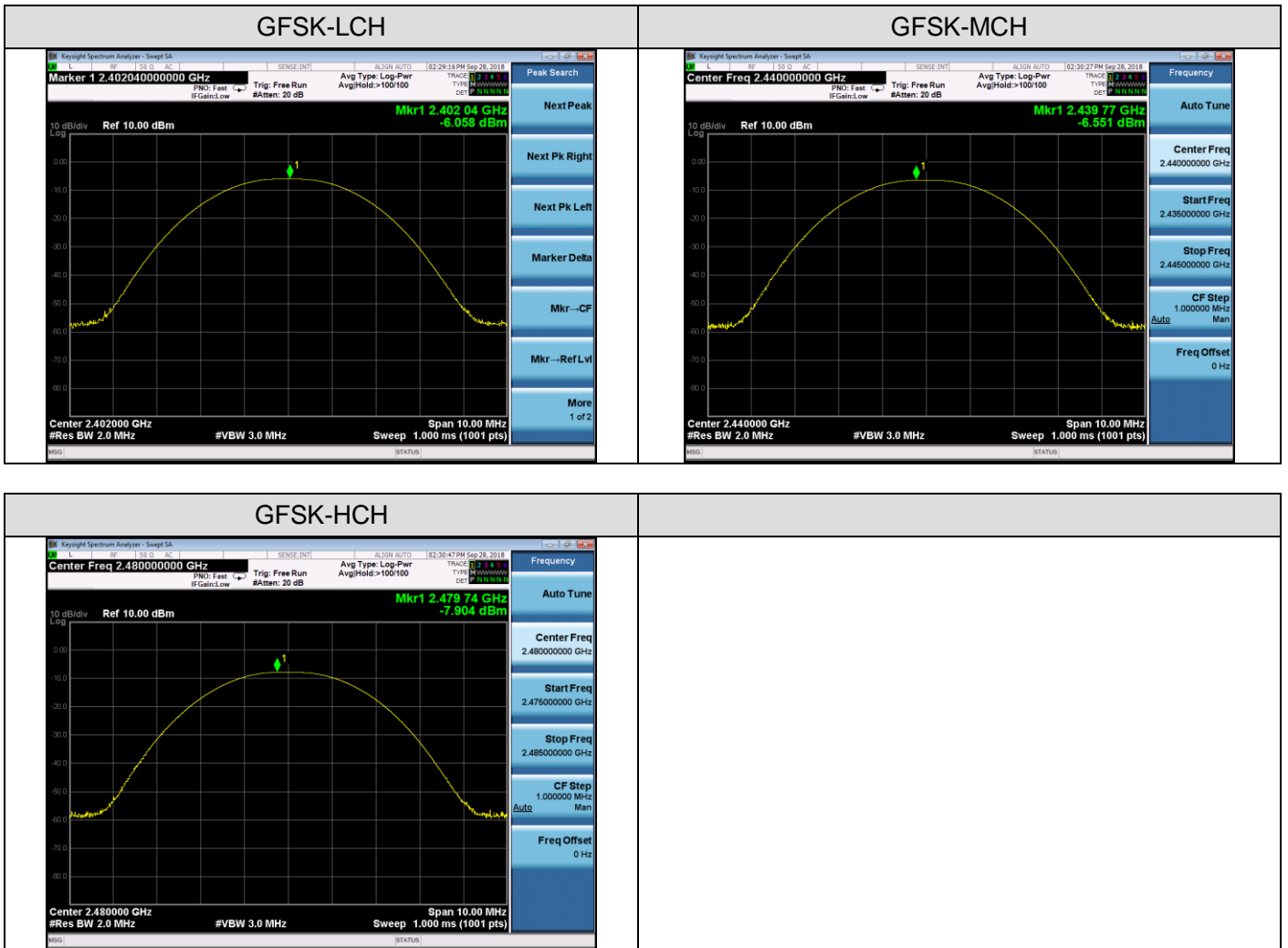



11. MAXIMUM CONDUCTED OUTPUT POWER SPECTRAL DENSITY

11.1 MEASUREMENT PROCEDURE

- (1). Connect EUT RF output port to the Spectrum Analyzer through an RF attenuator
- (2). Set the EUT Work on the top, the middle and the bottom operation frequency individually.
- (3). Set SPA Trace 1 Max hold, then View.

Note: The EUT was tested according to KDB 558074 for compliance to FCC 47CFR 15.247 requirements.

11.2 TEST SET-UP (BLOCK DIAGRAM OF CONFIGURATION)

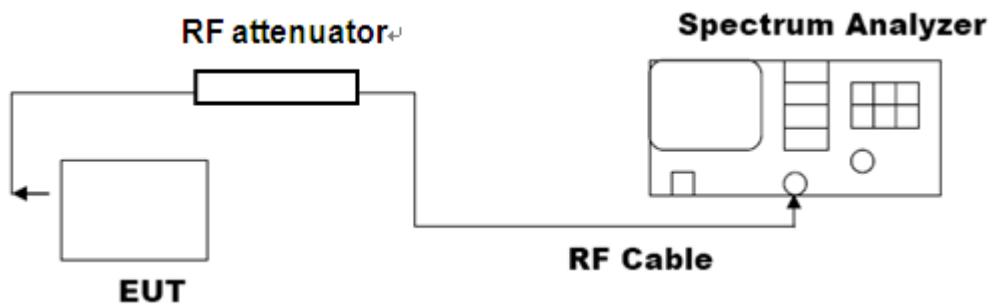



11.3 LIMITS AND MEASUREMENT RESULT

Mode	Channel	PSD [dBm/3kHz]	Limit[dBm/3kHz]	Verdict
BLE	LCH	-21.169	8	PASS
BLE	MCH	-22.139	8	PASS
BLE	HCH	-23.268	8	PASS

Test Graph

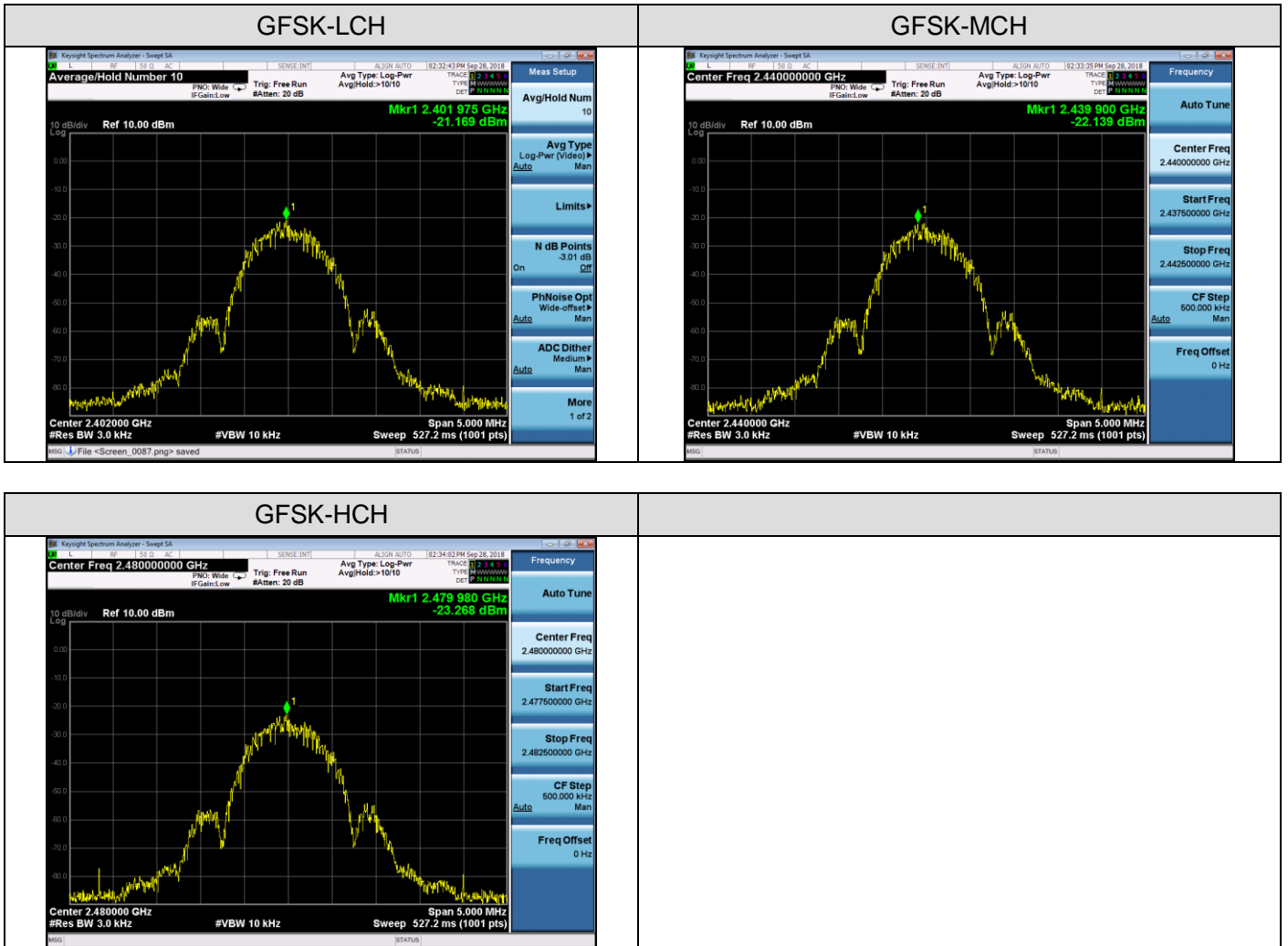



12. FCC LINE CONDUCTED EMISSION TEST

12.1 LIMITS

Frequency	Maximum RF Line Voltage	
	Q.P.(dBuV)	Average(dBuV)
150kHz~500kHz	66-56	56-46
500kHz~5MHz	56	46
5MHz~30MHz	60	50

****Note:** 1. The lower limit shall apply at the transition frequency.

2. The limit decreases linearly with the logarithm of the frequency in the range 0.15 MHz to 0.50 MHz

12.2 TEST SETUP

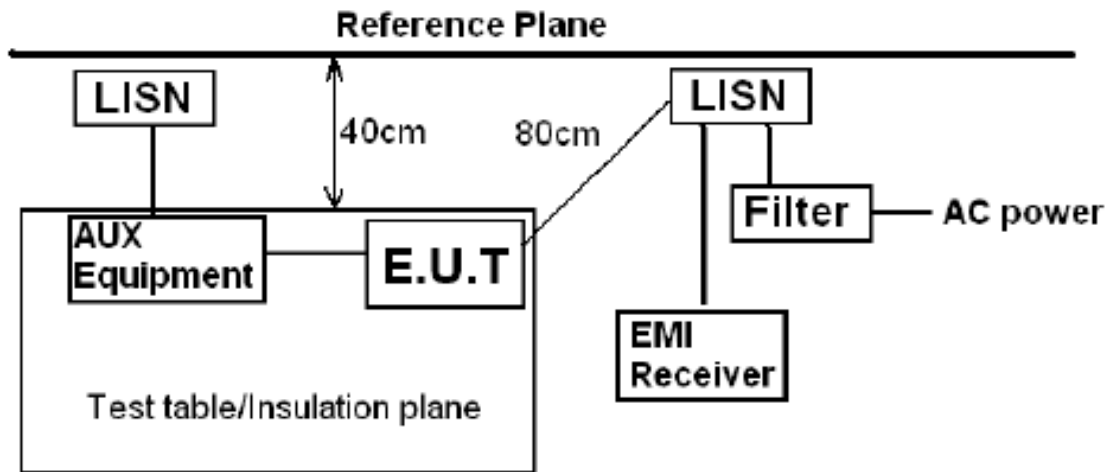

Remark

E.U.T: Equipment Under Test

LISN: Line Impedance Stabilization Network

Test table height=0.8m



12.3 PRELIMINARY PROCEDURE

- 1) The equipment was set up as per the test configuration to simulate typical actual usage per the user's manual. When the EUT is a tabletop system, a wooden table with a height of 0.8 meters is used and is placed on the ground plane as per ANSI C63.10 (see Test Facility for the dimensions of the ground plane used). When the EUT is a floor-standing equipment, it is placed on the ground plane which has a 3-12 mm non-conductive covering to insulate the EUT from the ground plane.
- 2) Support equipment, if needed, was placed as per ANSI C63.10.
- 3) All I/O cables were positioned to simulate typical actual usage as per ANSI C63.10.
- 4) All support equipments received AC120V/60Hz power from a LISN, if any.
- 5) The EUT received power by adapter which received power by a LISN.
- 6) The test program was started. Emissions were measured on each current carrying line of the EUT using a spectrum Analyzer / Receiver connected to the LISN powering the EUT. The LISN has two monitoring points: Line 1 (Hot Side) and Line 2 (Neutral Side). Two scans were taken: one with Line 1 connected to Analyzer / Receiver and Line 2 connected to a 50 ohm load; the second scan had Line 1 connected to a 50 ohm load and Line 2 connected to the Analyzer / Receiver.
- 7) Analyzer / Receiver scanned from 150 kHz to 30MHz for emissions in each of the test modes.
- 8) During the above scans, the emissions were maximized by cable manipulation.
- 9) The following test mode(s) were scanned during the preliminary test.
Then, the EUT configuration and cable configuration of the above highest emission level were recorded for reference of final testing.

12.4 FINAL TEST PROCEDURE

- 1) EUT and support equipment was set up on the test bench as per step 2 of the preliminary test.
- 2) A scan was taken on both power lines, Line 1 and Line 2, recording at least the six highest emissions. Emission frequency and amplitude were recorded into a computer in which correction factors were used to calculate the emission level and compare reading to the applicable limit. If EUT emission level was less -2dB to the A.V. limit in Peak mode, then the emission signal was re-checked using Q.P and Average detector.
- 3) The test data of the worst case condition(s) was reported on the Summary Data page.



12.5 TEST RESULT OF POWER LINE

Line Conducted Emission Test Line 1-L

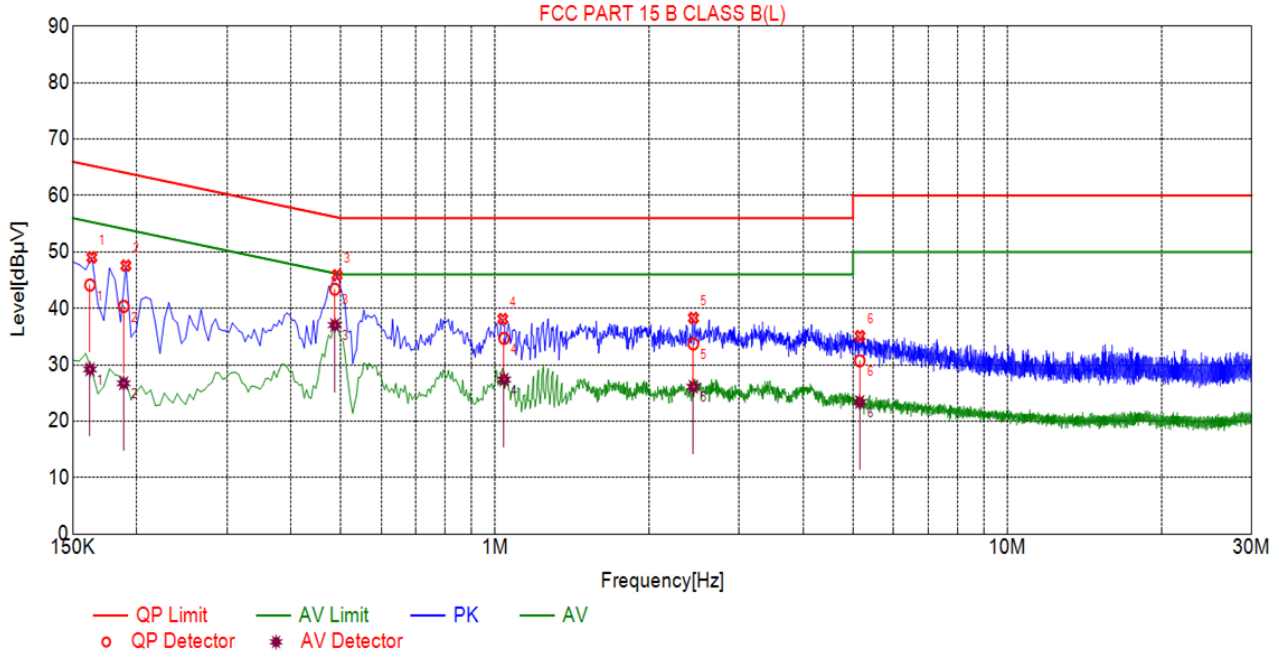

Suspected List						
NO.	Freq. [MHz]	Level [dBµV]	Factor [dB]	Limit [dBµV]	Margin [dB]	Detector
1	0.1635	49.03	9.98	65.28	16.25	PK
2	0.1905	47.58	10.04	64.02	16.44	PK
3	0.4920	45.88	10.04	56.13	10.25	PK
4	1.0365	38.11	10.07	56.00	17.89	PK
5	2.4405	38.30	10.18	56.00	17.70	PK
6	5.1585	35.08	10.26	60.00	24.92	PK

Final Data List								
NO.	Freq. [MHz]	Factor [dB]	QP Value [dBµV]	QP Limit [dBµV]	QP Margin [dB]	AV Value [dBµV]	AV Limit [dBµV]	AV Margin [dB]
1	0.1621	9.99	44.14	65.36	21.22	29.19	55.36	26.17
2	0.1886	10.04	40.36	64.10	23.74	26.71	54.10	27.39
3	0.4871	10.04	43.40	56.22	12.82	37.04	46.22	9.18
4	1.0421	10.07	34.68	56.00	21.32	27.37	46.00	18.63
5	2.4389	10.18	33.69	56.00	22.31	26.10	46.00	19.90
6	5.1524	10.26	30.71	60.00	29.29	23.39	50.00	26.61



Line Conducted Emission Test Line 1-N

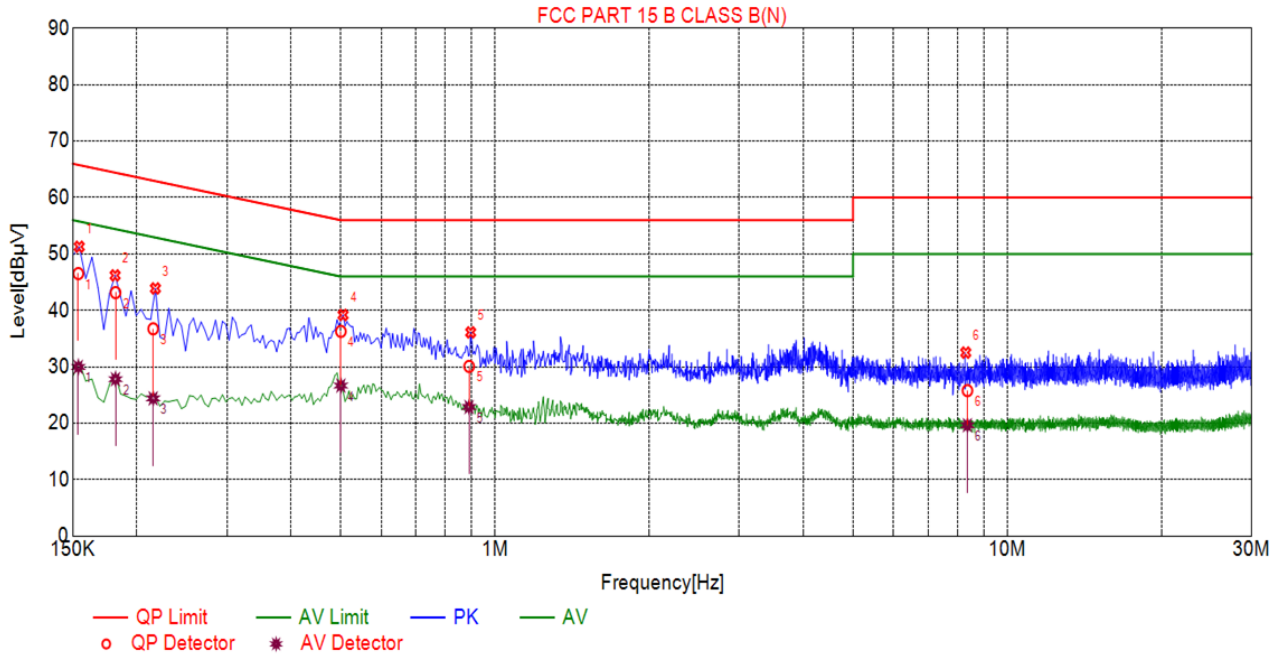

Suspected List						
NO.	Freq. [MHz]	Level [dBµV]	Factor [dB]	Limit [dBµV]	Margin [dB]	Detector
1	0.1545	51.28	10.03	65.75	14.47	PK
2	0.1815	48.20	10.06	64.42	18.22	PK
3	0.2175	43.89	10.05	62.91	19.02	PK
4	0.5055	39.18	10.04	56.00	16.82	PK
5	0.8970	36.10	10.06	56.00	19.90	PK
6	8.2995	32.51	10.13	60.00	27.49	PK

Final Data List								
NO.	Freq. [MHz]	Factor [dB]	QP Value [dBµV]	QP Limit [dBµV]	QP Margin [dB]	AV Value [dBµV]	AV Limit [dBµV]	AV Margin [dB]
1	0.1538	10.03	46.53	65.79	19.26	29.97	55.79	25.82
2	0.1818	10.06	43.15	64.40	21.25	27.80	54.40	26.60
3	0.2153	10.05	36.74	63.00	26.26	24.40	53.00	28.60
4	0.5005	10.04	36.28	56.00	19.72	26.67	46.00	19.33
5	0.8904	10.06	30.07	56.00	25.93	22.87	46.00	23.13
6	8.3596	10.13	25.78	60.00	34.22	19.64	50.00	30.36



13. CONDUCTED SPURIOUS EMISSION

13.1. MEASUREMENT PROCEDURE

1. Connect EUT RF output port to the Spectrum Analyzer through an RF attenuator
2. Set the EUT Work on the top, the Middle and the bottom operation frequency individually.
3. Set the Span = wide enough to capture the peak level of the in-band emission and all spurious emissions from the lowest frequency generated in the EUT up through the 10th harmonic.
RBW = 100 kHz; VBW \geq RBW; Sweep = auto; Detector function = peak.
4. Set SPA Trace 1 Max hold, then View.

Note: The EUT was tested according to DA000705 for compliance to FCC 47CFR 15.247 requirements. Owing to satisfy the requirements of the number of measurement points, we set the RBW=1MHz, VBW > RBW, scan up through 10th harmonic, and consider the tested results as the worst case, if the tested results conform to the requirement, we can deem that the real tested results(set the RBW=100KHz, VBW > RBW) are conform to the requirement.

**13.2. TEST SET-UP (BLOCK DIAGRAM OF CONFIGURATION)**

The same as described in section 8.2

13.3. MEASUREMENT EQUIPMENT USED

The same as described in section 6

13.4. LIMITS AND MEASUREMENT RESULT

LIMITS AND MEASUREMENT RESULT		
Applicable Limits	Measurement Result	
	Test Data	Criteria
<p>In any 100 KHz Bandwidth Outside the frequency band in which the spread spectrum intentional radiator is operating, the radio frequency power that is produce by the intentional radiator shall be at least 20 dB below that in 100KHz bandwidth within the band that contains the highest level of the desired power.</p> <p>In addition, radiation emissions which fall in the restricted bands, as defined in §15.205(a), must also comply with the radiated emission limits specified in§15.209(a)</p>	Refer Test Graph	PASS



Test Graph

GFSK-LCH

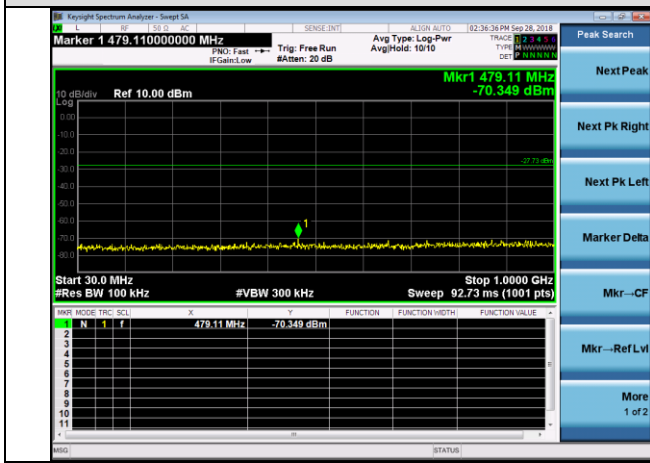

GFSK-LCH

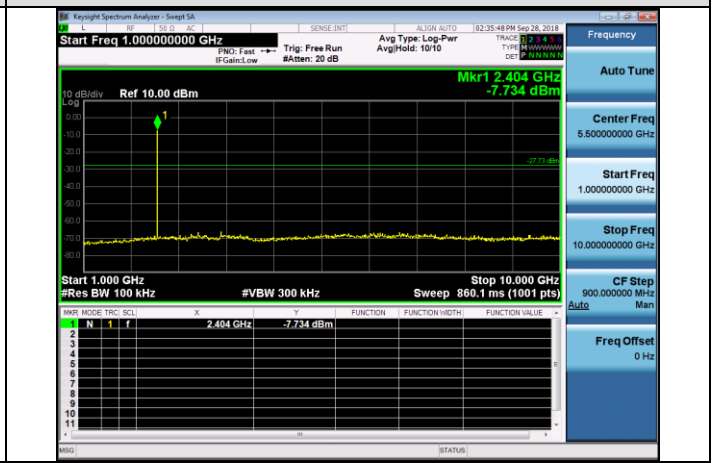

GFSK-LCH

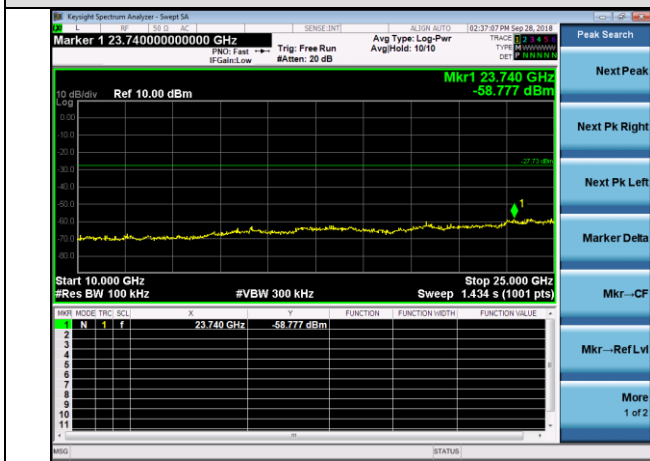

GFSK-MCH

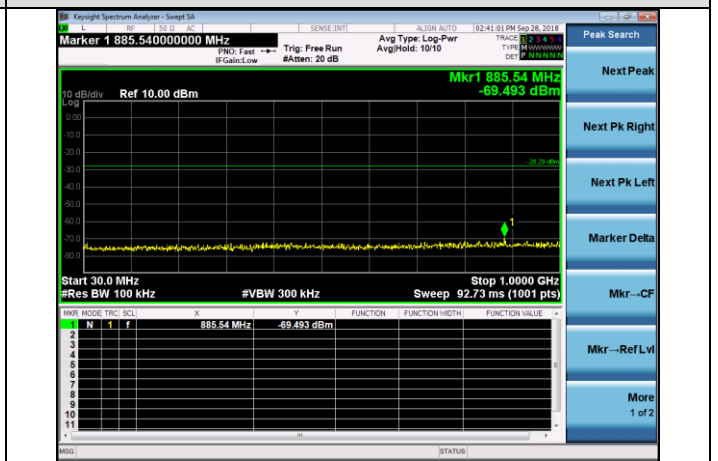

GFSK-MCH

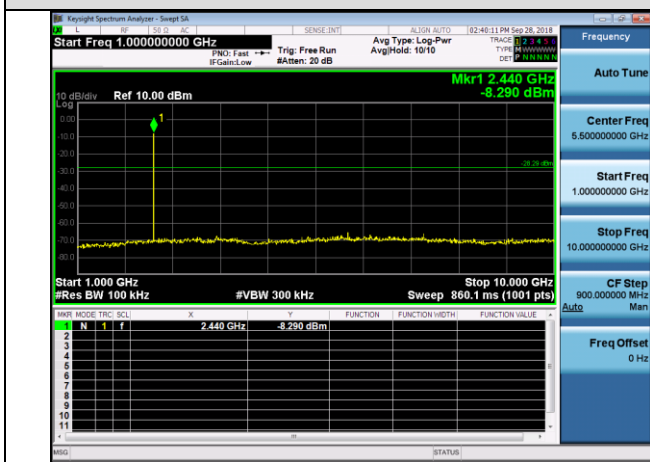

GFSK-MCH

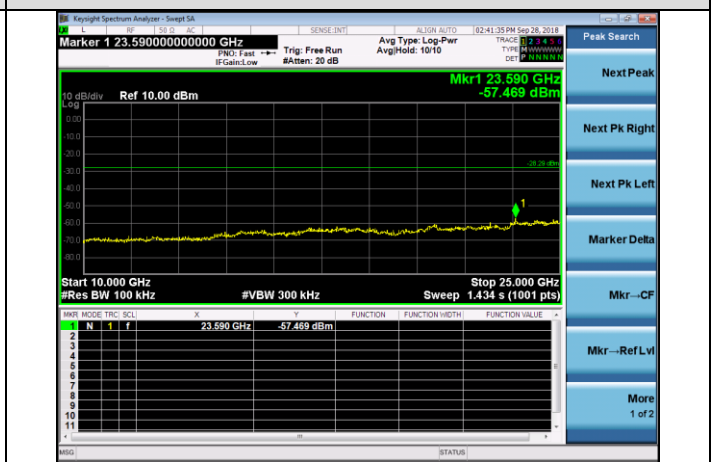



GFSK-HCH

GFSK-HCH

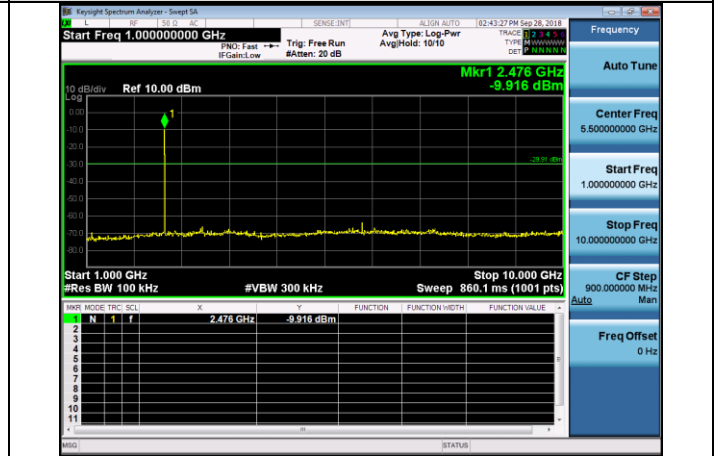
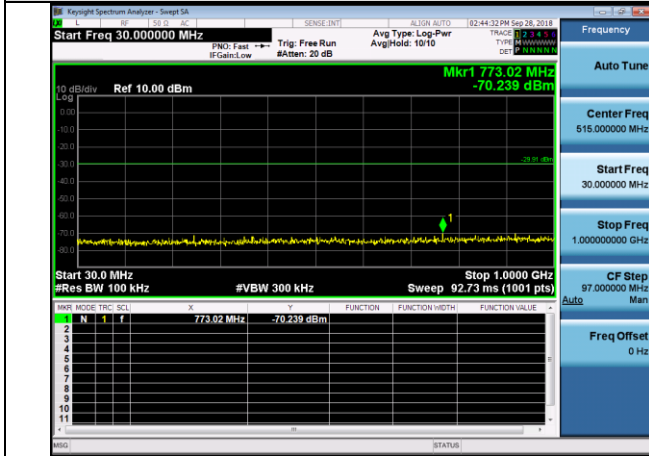

GFSK-HCH

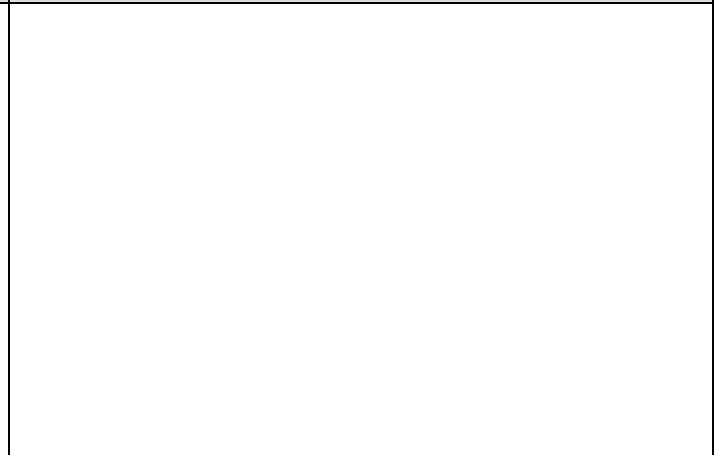
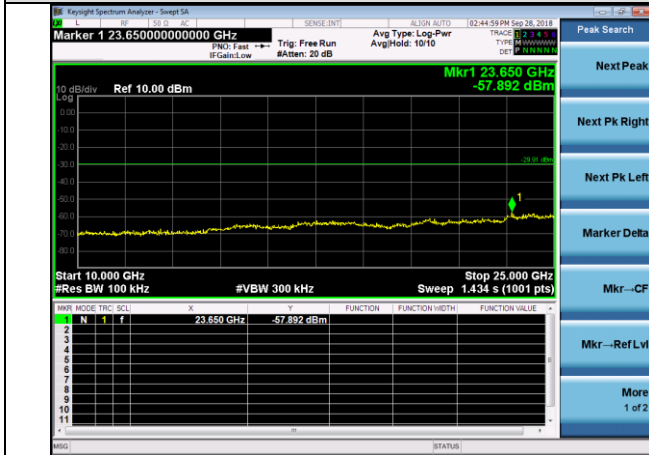



APPENDIX A: PHOTOGRAPHS OF TEST SETUP
LINE CONDUCTED EMISSION TEST SETUP



RADIATED EMISSION TEST SETUP

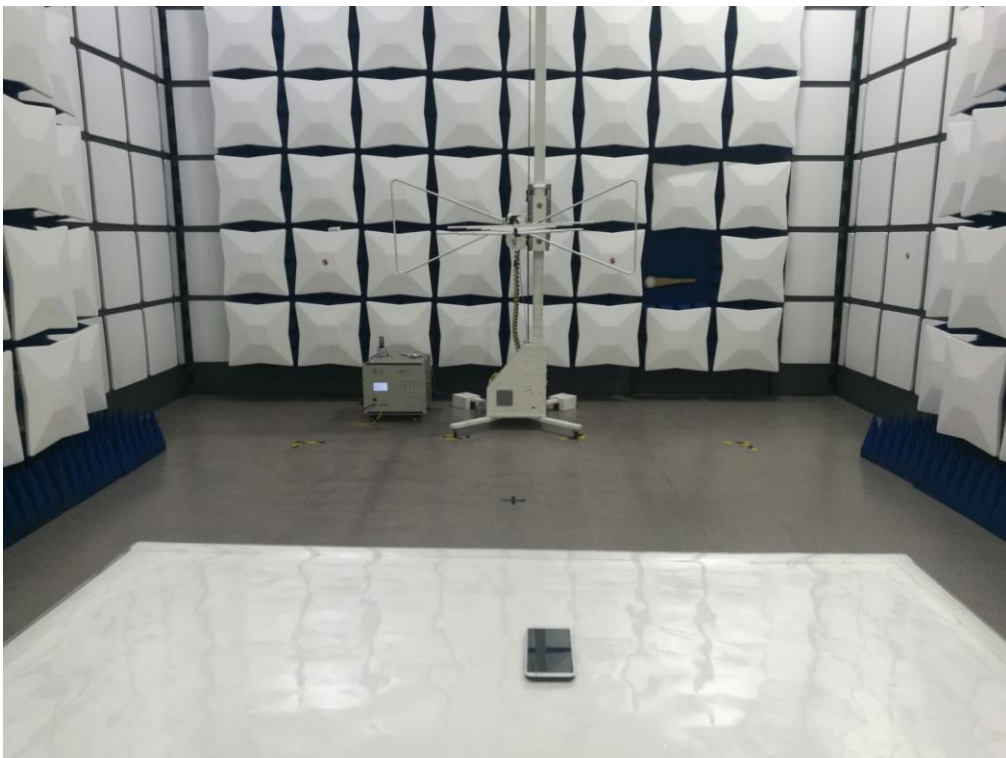



RADIATED EMISSION ABOVE 1G TEST SETUP



----END OF REPORT----