

---

# FCC Test Report

---

Report No.: AGC00653160502FE03

**FCC ID** : 2AFD9K4GOLD  
**APPLICATION PURPOSE** : Original Equipment  
**PRODUCT DESIGNATION** : MOBILE PHONE  
**BRAND NAME** : KRONO  
**MODEL NAME** : K4 GOLD  
**CLIENT** : MOVEON TECHNOLOGY LIMITED  
**DATE OF ISSUE** : June 02, 2016  
**STANDARD(S)** : FCC Part 15 Rules  
**TEST PROCEDURE(S)** : DA 00-705  
**REPORT VERSION** : V1.0

Attestation of Global Compliance (Shenzhen) Co., Ltd



**CAUTION:**

This report shall not be reproduced except in full without the written permission of the test laboratory and shall not be quoted out of context.



**Report Revise Record**

Report Version	Revise Time	Issued Date	Valid Version	Notes
V1.0	/	June 02, 2016	Valid	Original Report

## TABLE OF CONTENTS

<b>1. VERIFICATION OF CONFORMITY .....</b>	<b>5</b>
<b>2. GENERAL INFORMATION .....</b>	<b>6</b>
2.1. PRODUCT DESCRIPTION.....	6
2.2. TABLE OF CARRIER FREQUENCIES.....	6
2.3. RECEIVER INPUT BANDWIDTH.....	7
2.4. EXAMPLE OF A HOPPING SEQUENCY IN DATA MODE .....	7
2.5. EQUALLY AVERAGE USE OF FREQUENCIES AND BEHAVIOUR .....	7
2.6. RELATED SUBMITTAL(S) / GRANT (S).....	8
2.7. TEST METHODOLOGY.....	8
2.8. SPECIAL ACCESSORIES .....	8
2.9. EQUIPMENT MODIFICATIONS .....	8
<b>3. MEASUREMENT UNCERTAINTY.....</b>	<b>9</b>
<b>4. DESCRIPTION OF TEST MODES.....</b>	<b>9</b>
<b>5. SYSTEM TEST CONFIGURATION .....</b>	<b>10</b>
5.1. CONFIGURATION OF EUT SYSTEM .....	10
5.2. EQUIPMENT USED IN EUT SYSTEM .....	10
5.3. SUMMARY OF TEST RESULTS .....	10
<b>6. TEST FACILITY .....</b>	<b>11</b>
<b>7. PEAK OUTPUT POWER .....</b>	<b>13</b>
7.1. MEASUREMENT PROCEDURE .....	13
7.2. TEST SET-UP (BLOCK DIAGRAM OF CONFIGURATION).....	13
7.3. LIMITS AND MEASUREMENT RESULT .....	14
<b>8. 20DB BANDWIDTH.....</b>	<b>18</b>
8.1. MEASUREMENT PROCEDURE .....	18
8.2. TEST SET-UP (BLOCK DIAGRAM OF CONFIGURATION).....	18
8.3. LIMITS AND MEASUREMENT RESULTS.....	18
<b>9. CONDUCTED SPURIOUS EMISSION .....</b>	<b>22</b>
9.1. MEASUREMENT PROCEDURE .....	22
9.2. TEST SET-UP (BLOCK DIAGRAM OF CONFIGURATION).....	22
9.3. MEASUREMENT EQUIPMENT USED.....	22
9.4. LIMITS AND MEASUREMENT RESULT .....	22
<b>10. RADIATED EMISSION .....</b>	<b>41</b>
10.1. MEASUREMENT PROCEDURE .....	41
10.2. TEST SETUP.....	43

- 10.3. TEST RESULT .....44
- 11. BAND EDGE EMISSION ..... 51**
  - 11.1. MEASUREMENT PROCEDURE .....51
  - 11.2. TEST SET-UP .....51
  - 11.3. Radiated TEST RESULT .....52
  - 11.4 Conducted TEST RESULT .....53
- 12. NUMBER OF HOPPING FREQUENCY..... 57**
  - 12.1. MEASUREMENT PROCEDURE .....57
  - 12.2. TEST SETUP (BLOCK DIAGRAM OF CONFIGURATION).....57
  - 12.3. MEASUREMENT EQUIPMENT USED .....57
  - 12.4. LIMITS AND MEASUREMENT RESULT .....57
- 13. TIME OF OCCUPANCY (DWELL TIME)..... 58**
  - 13.1. MEASUREMENT PROCEDURE .....58
  - 13.2. TEST SETUP (BLOCK DIAGRAM OF CONFIGURATION).....58
  - 13.3. MEASUREMENT EQUIPMENT USED .....58
  - 13.4. LIMITS AND MEASUREMENT RESULT .....58
  - Test Graph .....59
- 14. FREQUENCY SEPARATION ..... 61**
  - 14.1. MEASUREMENT PROCEDURE .....61
  - 14.2. TEST SETUP (BLOCK DIAGRAM OF CONFIGURATION).....61
  - 14.3. MEASUREMENT EQUIPMENT USED .....61
  - 14.4. LIMITS AND MEASUREMENT RESULT .....61
- 15. FCC LINE CONDUCTED EMISSION TEST ..... 62**
  - 15.1. LIMITS OF LINE CONDUCTED EMISSION TEST .....62
  - 15.2. BLOCK DIAGRAM OF LINE CONDUCTED EMISSION TEST .....62
  - 15.3. PRELIMINARY PROCEDURE OF LINE CONDUCTED EMISSION TEST .....63
  - 15.4. FINAL PROCEDURE OF LINE CONDUCTED EMISSION TEST .....63
  - 15.5. TEST RESULT OF LINE CONDUCTED EMISSION TEST .....64
- APPENDIX A: PHOTOGRAPHS OF TEST SETUP ..... 66**
- APPENDIX B: PHOTOGRAPHS OF EUT ..... 68**

## 1. VERIFICATION OF CONFORMITY

<b>Applicant</b>	MOVEON TECHNOLOGY LIMITED
<b>Address</b>	world trade plaza-A block #3201-3202 Fuhong Road, Futian
<b>Manufacturer</b>	MOVEON TECHNOLOGY LIMITED
<b>Address</b>	world trade plaza-A block #3201-3202 Fuhong Road, Futian
<b>Product Designation</b>	MOBILE PHONE
<b>Brand Name</b>	KRONO
<b>Test Model</b>	K4 GOLD
<b>Date of test</b>	May 18, 2016 to May 20, 2016
<b>Deviation</b>	None
<b>Condition of Test Sample</b>	Normal
<b>Report Template</b>	AGCRT-US-BR/RF

We hereby certify that:

The above equipment was tested by Dongguan Precise Testing Service Co., Ltd. The test data, data evaluation, test procedures, and equipment configurations shown in this report were made in accordance with the procedures given in ANSI C63.10 (2013) and the energy emitted by the sample EUT tested as described in this report is in compliance with radiated emission limits of FCC Rules Part 15.247.

Tested By

*Dota Zhang*

Dota Zhang(Zhang Jianfeng)

June 02, 2016

Reviewed By

*Bart Xie*

Bart Xie(Xie Xiaobin)

June 02, 2016

Approved By

*Solger Zhang*

Solger Zhang(Zhang Hongyi)  
Authorized Officer

June 02, 2016

## 2. GENERAL INFORMATION

### 2.1. PRODUCT DESCRIPTION

The EUT is “MOBILE PHONE ” designed as a “Communication Device”. It is designed by way of utilizing the FHSS technology to achieve the system operation.

A major technical description of EUT is described as following

<b>Operation Frequency</b>	2.402 GHz to 2.480GHz
<b>RF Output Power</b>	3.06dBm(Max)
<b>Bluetooth Version</b>	V 3.0
<b>Modulation</b>	GFSK, π /4-DQPSK, 8DPSK
<b>Number of channels</b>	79(For BR/EDR)
<b>Hardware Version</b>	HCT_G662MB_A2
<b>Software Version</b>	K4_GOLD_20160511
<b>Antenna Designation</b>	PIFA Antenna
<b>Antenna Gain</b>	1.1dBi
<b>Power Supply</b>	DC3.8V by Battery

### 2.2. TABLE OF CARRIER FREQUENCIES

Frequency Band	Channel Number	Frequency
2400~2483.5MHZ	0	2402MHZ
	1	2403MHZ
	:	:
	38	2440 MHZ
	39	2441 MHZ
	40	2442 MHZ
	:	:
	77	2479 MHZ
	78	2480 MHZ

### 2.3. RECEIVER INPUT BANDWIDTH

The input bandwidth of the receiver is 1.3MHz. In every connection one Bluetooth device is the master and the other one is slave. The master determines the hopping sequence. The slave follows this sequence. Both devices shift between RX and TX time slot according to the clock of the master. Additionally the type of connection (e.g. single or multislotted packet) is set up at the beginning of the connection. The master adapts its hopping frequency and its TX/RX timing according to the packet type of the connection. Also the slave of the connection will use these settings.

Repeating of a packet has no influence on the hopping sequence. The hopping sequence generated by the master of the connection will be followed in any case. That means, a repeated packet will not be sent on the same frequency, it is sent on the next frequency of the hopping sequence.

### 2.4. EXAMPLE OF A HOPPING SEQUENCE IN DATA MODE

Example of a 79 hopping sequence in data mode:

40,21,44,23,42,53,46,55,48,33,52,35,50,65,54,67  
56,37,60,39,58,69,62,71,64,25,68,27,66,57,70,59  
72,29,76,31,74,61,78,63,01,41,05,43,03,73,07,75  
09,45,13,47,11,77,15,00,64,49,66,53,68,02,70,06  
01, 51, 03, 55, 05, 04

### 2.5. EQUALLY AVERAGE USE OF FREQUENCIES AND BEHAVIOUR

The generation of the hopping sequence in connection mode depends essentially on two input values:

1. LAP/UAP of the master of the connection.
2. Internal master clock

The LAP (lower address part) are the 24 LSB's of the 48 BD\_ADDRESS. The BD\_ADDRESS is an unambiguous number of every Bluetooth unit. The UAP (upper address part) are the 24 MSB's of the 48 BD\_ADDRESS

The internal clock of a Bluetooth unit is derived from a free running clock which is never adjusted and is never turned off. For synchronization with other units only offsets are used. It has no relation to the time of the day. Its resolution is at least half the RX/TX slot length of 312.5µs. The clock has a cycle of about one day (23h30). In most cases it is implemented as a 28-bit counter. For the deriving of the hopping sequence the entire LAP (24 bits), 4 LSB's (4 bits) (Input 1) and the 27 MSB's of the clock (Input 2) are used. With these input values different mathematical procedures (permutations, additions, XOR-operations) are performed to generate the sequence. This will be done at the beginning of every new transmission.

Regarding short transmissions the Bluetooth system has the following behavior:

The first connection between the two devices is established, a hopping sequence was generated. For transmitting the wanted data the complete hopping sequence was not used. The connection ended.

The second connection will be established. A new hopping sequence is generated. Due to the fact the Bluetooth clock has a different value, because the period between the two transmissions is longer (and it cannot be shorter) than the minimum resolution of the clock (312.5µs). The hopping sequence will always differ from the first one.

## **2.6. RELATED SUBMITTAL(S) / GRANT (S)**

This submittal(s) (test report) is intended for **FCC ID: 2AFD9K4GOLD** filing to comply with Section 15.247 of the FCC Part 15, Subpart C Rules.

## **2.7. TEST METHODOLOGY**

Both conducted and radiated testing was performed according to the procedures in FCC DA 00-705. Radiated testing was performed at an antenna to EUT distance 3 meters.

## **2.8. SPECIAL ACCESSORIES**

Refer to section 5.2.

## **2.9. EQUIPMENT MODIFICATIONS**

Not available for this EUT intended for grant.



### 3. MEASUREMENT UNCERTAINTY

Conducted measurement: +/- 2.75dB

Radiated measurement: +/- 3.2dB

### 4. DESCRIPTION OF TEST MODES

NO.	TEST MODE DESCRIPTION
1	Low channel GFSK
2	Middle channel GFSK
3	High channel GFSK
4	Low channel $\pi/4$ -DQPSK
5	Middle channel $\pi/4$ -DQPSK
6	High channel $\pi/4$ -DQPSK
7	Low channel 8DPSK
8	Middle channel 8DPSK
9	High channel 8DPSK
10	Normal Hopping

Note:

1. All the test modes can be supply by Built-in Li-ion battery, only the result of the worst case was recorded in the report, if no other cases.
2. For Radiated Emission, 3axis were chosen for testing for each applicable mode.

## 5. SYSTEM TEST CONFIGURATION

### 5.1. CONFIGURATION OF EUT SYSTEM

Configuration:

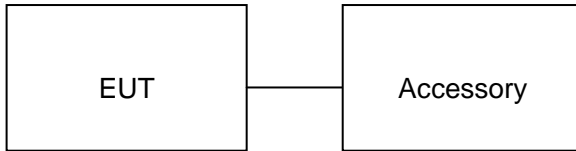

### 5.2. EQUIPMENT USED IN EUT SYSTEM

Item	Equipment	Model No.	ID or Specification	Remark
1	MOBILE PHONE	K4 GOLD	2AFD9K4GOLD	EUT
2	Adapter	K4 GOLD	DC5V/1000mA	Accessory
	Battery	K4 GOLD	DC 3.8V/1600 mAh	Accessory
3	USB Cable	N/A	N/A	Accessory
4	Laptop	Dell	INSPIRON	A.E

### 5.3. SUMMARY OF TEST RESULTS

FCC RULES	DESCRIPTION OF TEST	RESULT
§15.247	Peak Output Power	Compliant
§15.247	20 dB Bandwidth	Compliant
§15.247	Spurious Emission	Compliant
§15.209	Radiated Emission	Compliant
§15.247	Band Edges	Compliant
§15.207	Conduction Emission	Compliant
§15.247	Number of Hopping Frequency	Compliant
§15.247	Time of Occupancy	Compliant
§15.247	Frequency Separation	Compliant

## 6. TEST FACILITY

<b>Site</b>	Dongguan Precise Testing Service Co., Ltd.
<b>Location</b>	Building D,Baoding Technology Park,Guangming Road2,Dongcheng District, Dongguan, Guangdong, China,
<b>FCC Registration No.</b>	371540
<b>Description</b>	The test site is constructed and calibrated to meet the FCC requirements in documents ANSI C63.10:2013.

### ALL TEST EQUIPMENT LIST

FOR RADIATED EMISSION TEST (BELOW 1GHZ)

Radiated Emission Test Site					
Name of Equipment	Manufacturer	Model Number	Serial Number	Last Calibration	Due Calibration
EMI Test Receiver	Rohde & Schwarz	ESCI	101417	July 4, 2015	July 3, 2016
Trilog Broadband Antenna (25M-1GHz)	SCHWARZBECK	VULB9160	9160-3355	July 4, 2015	July 3, 2016
Signal Amplifier	SCHWARZBECK	BBV 9475	9745-0013	July 4, 2015	July 3, 2016
RF Cable	SCHWARZBECK	AK9515E	96221	July 4, 2015	July 3, 2016
3m Anechoic Chamber	CHENGYU	966	PTS-001	June 6, 2015	June 5, 2016
MULTI-DEVICE Positioning Controller	Max-Full	MF-7802	MF780208339	N/A	N/A
Active loop antenna (9K-30MHz)	Schwarzbeck	FMZB1519	1519-038	June 6, 2015	June 5, 2016
Spectrum analyzer	Agilent	E4407B	MY46185649	June 6, 2015	June 5, 2016
Power Probe	R&S	NRP-Z23	100323	July 25,2015	July 24,2016
RF attenuator	N/A	RFA20db	68	N/A	N/A

FOR RADIATED EMISSION TEST (1GHZ ABOVE)

Radiated Emission Test Site					
Name of Equipment	Manufacturer	Model Number	Serial Number	Last Calibration	Due Calibration
EMI Test Receiver	Rohde & Schwarz	ESCI	101417	July 4, 2015	July 3, 2016
Horn Antenna (1G-18GHz)	SCHWARZBECK	BBHA9120D	9120D-1246	July 11, 2015	July 10, 2016
Spectrum Analyzer	Agilent	E4411B	MY4511453	July 4, 2015	July 3, 2016
Signal Amplifier	SCHWARZBECK	BBV 9718	9718-269	July 7, 2015	July 6, 2016
RF Cable	SCHWARZBECK	AK9515H	96220	July 8, 2015	July 7, 2016
3m Anechoic Chamber	CHENGYU	966	PTS-001	June 6, 2015	June 5, 2016

MULTI-DEVICE Positioning Controller	Max-Full	MF-7802	MF780208339	N/A	N/A
Horn Ant (18G-40GHz)	Schwarzbeck	BBHA 9170	9170-181	June 6, 2015	June 5, 2016
Power Probe	R&S	NRP-Z23	100323	July 25,2015	July 24,2016
RF attenuator	N/A	RFA20db	68	N/A	N/A
Conducted Emission Test Site					
Name of Equipment	Manufacturer	Model Number	Serial Number	Last Calibration	Due Calibration
EMI Test Receiver	Rohde & Schwarz	ESCI	101417	July 4, 2015	July 3, 2016
Artificial Mains Network	Narda	L2-16B	000WX31025	July 8, 2015	July 7, 2016
Artificial Mains Network (AUX)	Narda	L2-16B	000WX31026	July 8, 2015	July 7, 2016
RF Cable	SCHWARZBECK	AK9515E	96222	July 4, 2015	July 3, 2016
Shielded Room	CHENGYU	843	PTS-002	June 6,2015	June 5,2016

## 7. PEAK OUTPUT POWER

### 7.1. MEASUREMENT PROCEDURE

For peak power test:

1. Connect EUT RF output port to the Spectrum Analyzer through an RF attenuator
2. Set the EUT Work on the top, middle and the bottom operation frequency individually.
3.  $RBW >$  the 20 dB bandwidth of the emission being measured,  $VBW \geq RBW$ .
4. Record the maximum power from the Spectrum Analyzer.

For average power test:

1. Connect EUT RF output port to power probe through an RF attenuator.
2. Connect the power probe to the PC.
3. Set the EUT Work on the top, the middle and the bottom operation frequency individually.
4. Record the maximum power from the software.
5. The maximum peak power shall be less 125mW (21dBm).

**Note :** The EUT was tested according to DA000705 for compliance to FCC 47CFR 15.247 requirements.

### 7.2. TEST SET-UP (BLOCK DIAGRAM OF CONFIGURATION)

#### PEAK POWER TEST SETUP

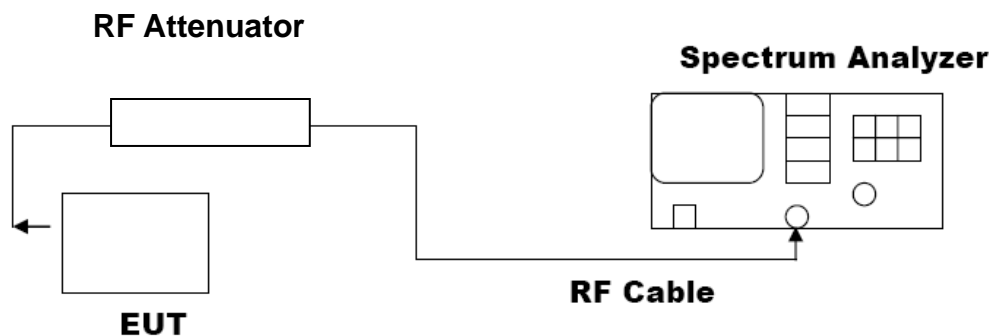

#### AVERAGE POWER SETUP

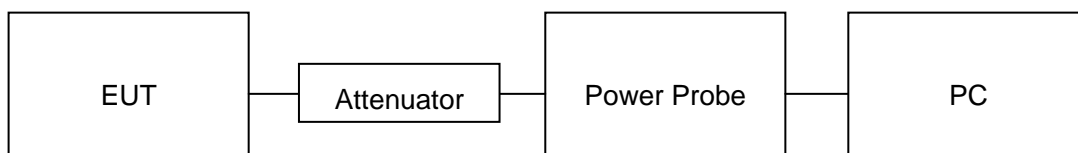

**7.3. LIMITS AND MEASUREMENT RESULT**

<b>PEAK OUTPUT POWER MEASUREMENT RESULT FOR GFSK MODULATION</b>				
<b>Frequency (GHz)</b>	<b>Average Power (dBm)</b>	<b>Peak Power (dBm)</b>	<b>Applicable Limits (dBm)</b>	<b>Pass or Fail</b>
2.402	0.09	2.05	21	Pass
2.441	0.11	3.06	21	Pass
2.480	0.14	2.93	21	Pass

<b>PEAK OUTPUT POWER MEASUREMENT RESULT FOR <math>\pi/4</math>-DQPSK MODULATION</b>				
<b>Frequency (GHz)</b>	<b>Average Power (dBm)</b>	<b>Peak Power (dBm)</b>	<b>Applicable Limits (dBm)</b>	<b>Pass or Fail</b>
2.402	-1.34	0.23	21	Pass
2.441	-1.53	0.84	21	Pass
2.480	-1.45	0.50	21	Pass

<b>PEAK OUTPUT POWER MEASUREMENT RESULT FOR 8-DPSK MODULATION</b>				
<b>Frequency (GHz)</b>	<b>Average Power (dBm)</b>	<b>Peak Power (dBm)</b>	<b>Applicable Limits (dBm)</b>	<b>Pass or Fail</b>
2.402	-1.47	0.27	21	Pass
2.441	-1.11	0.86	21	Pass
2.480	-1.93	-0.17	21	Pass

Test Graph

Graphs															
GFSK/LCH	<div style="border: 1px solid black; padding: 5px;"> <p>Agilent 06:54:51 Jan 24, 1987 <span style="float: right;">R T</span></p> <p>Ref 20.9 dBm #Atten 30 dB <span style="float: right;">Mkr1 2.401 875 GHz 2.05 dBm</span></p> <p>#Peak Log 10 dB/ Offst 0.9 dB</p> <p>LgAv</p> <p>M1 S2 S3 FS</p> <p>Ⓐ(f): FTun Swp</p> <p style="text-align: right;">Span 5 MHz</p> <p>Center 2.402 000 GHz #Res BW 1.5 MHz #VBW 3 MHz Sweep 1.067 ms (3001 pts)</p> <p style="color: red;">File name error</p> <table border="1" style="width: 100%; border-collapse: collapse;"> <tr><th colspan="2">Freq/Channel</th></tr> <tr><td>Center Freq</td><td>2.40200000 GHz</td></tr> <tr><td>Start Freq</td><td>2.39950000 GHz</td></tr> <tr><td>Stop Freq</td><td>2.40450000 GHz</td></tr> <tr><td>CF Step</td><td>500.000000 kHz Auto Man</td></tr> <tr><td>Freq Offset</td><td>0.00000000 Hz</td></tr> <tr><td>Signal Track</td><td>On Off</td></tr> </table> </div>	Freq/Channel		Center Freq	2.40200000 GHz	Start Freq	2.39950000 GHz	Stop Freq	2.40450000 GHz	CF Step	500.000000 kHz Auto Man	Freq Offset	0.00000000 Hz	Signal Track	On Off
Freq/Channel															
Center Freq	2.40200000 GHz														
Start Freq	2.39950000 GHz														
Stop Freq	2.40450000 GHz														
CF Step	500.000000 kHz Auto Man														
Freq Offset	0.00000000 Hz														
Signal Track	On Off														
GFSK/MCH	<div style="border: 1px solid black; padding: 5px;"> <p>Agilent 06:56:30 Jan 24, 1987 <span style="float: right;">R L</span></p> <p>Ref 20.9 dBm #Atten 30 dB <span style="float: right;">Mkr1 2.440 964 GHz 3.06 dBm</span></p> <p>#Peak Log 10 dB/ Offst 0.9 dB</p> <p>LgAv</p> <p>M1 S2 S3 FS</p> <p>Ⓐ(f): FTun Swp</p> <p style="text-align: right;">Span 5 MHz</p> <p>Center 2.441 000 GHz #Res BW 1.5 MHz #VBW 3 MHz Sweep 1.067 ms (3001 pts)</p> <p style="color: red;">File name error</p> <table border="1" style="width: 100%; border-collapse: collapse;"> <tr><th colspan="2">Freq/Channel</th></tr> <tr><td>Center Freq</td><td>2.44100000 GHz</td></tr> <tr><td>Start Freq</td><td>2.43850000 GHz</td></tr> <tr><td>Stop Freq</td><td>2.44350000 GHz</td></tr> <tr><td>CF Step</td><td>500.000000 kHz Auto Man</td></tr> <tr><td>Freq Offset</td><td>0.00000000 Hz</td></tr> <tr><td>Signal Track</td><td>On Off</td></tr> </table> </div>	Freq/Channel		Center Freq	2.44100000 GHz	Start Freq	2.43850000 GHz	Stop Freq	2.44350000 GHz	CF Step	500.000000 kHz Auto Man	Freq Offset	0.00000000 Hz	Signal Track	On Off
Freq/Channel															
Center Freq	2.44100000 GHz														
Start Freq	2.43850000 GHz														
Stop Freq	2.44350000 GHz														
CF Step	500.000000 kHz Auto Man														
Freq Offset	0.00000000 Hz														
Signal Track	On Off														
GFSK/HCH	<div style="border: 1px solid black; padding: 5px;"> <p>Agilent 06:57:52 Jan 24, 1987 <span style="float: right;">R L</span></p> <p>Ref 20.9 dBm #Atten 30 dB <span style="float: right;">Mkr1 2.480 041 GHz 2.93 dBm</span></p> <p>#Peak Log 10 dB/ Offst 0.9 dB</p> <p>LgAv</p> <p>M1 S2 S3 FS</p> <p>Ⓐ(f): FTun Swp</p> <p style="text-align: right;">Span 5 MHz</p> <p>Center 2.480 000 GHz #Res BW 1.5 MHz #VBW 3 MHz Sweep 1.067 ms (3001 pts)</p> <p style="color: red;">File name error</p> <table border="1" style="width: 100%; border-collapse: collapse;"> <tr><th colspan="2">Freq/Channel</th></tr> <tr><td>Center Freq</td><td>2.48000000 GHz</td></tr> <tr><td>Start Freq</td><td>2.47750000 GHz</td></tr> <tr><td>Stop Freq</td><td>2.48250000 GHz</td></tr> <tr><td>CF Step</td><td>500.000000 kHz Auto Man</td></tr> <tr><td>Freq Offset</td><td>0.00000000 Hz</td></tr> <tr><td>Signal Track</td><td>On Off</td></tr> </table> </div>	Freq/Channel		Center Freq	2.48000000 GHz	Start Freq	2.47750000 GHz	Stop Freq	2.48250000 GHz	CF Step	500.000000 kHz Auto Man	Freq Offset	0.00000000 Hz	Signal Track	On Off
Freq/Channel															
Center Freq	2.48000000 GHz														
Start Freq	2.47750000 GHz														
Stop Freq	2.48250000 GHz														
CF Step	500.000000 kHz Auto Man														
Freq Offset	0.00000000 Hz														
Signal Track	On Off														

<p><math>\pi</math> /4DQPSK/LCH</p>	<p>Agilent 07:07:46 Jan 24, 1987 R L</p> <p>Ref 20.9 dBm #Atten 30 dB Mkr1 2.401 909 GHz 0.23 dBm</p> <p>#Peak Log 10 dB/Offst 0.9 dB</p> <p>LgAv M1 S2 S3 FS</p> <p><math>\mathcal{E}(f)</math>: FTun Swp</p> <p>Center 2.402 000 GHz Span 5 MHz #Res BW 1.5 MHz #VBW 3 MHz Sweep 1.067 ms (8001 pts)</p> <p>File name error</p> <table border="1"> <thead> <tr> <th colspan="2">Freq/Channel</th> </tr> </thead> <tbody> <tr> <td>Center Freq</td> <td>2.40200000 GHz</td> </tr> <tr> <td>Start Freq</td> <td>2.39950000 GHz</td> </tr> <tr> <td>Stop Freq</td> <td>2.40450000 GHz</td> </tr> <tr> <td>CF Step</td> <td>500.000000 kHz Auto Man</td> </tr> <tr> <td>Freq Offset</td> <td>0.00000000 Hz</td> </tr> <tr> <td>Signal Track</td> <td>On Off</td> </tr> </tbody> </table>	Freq/Channel		Center Freq	2.40200000 GHz	Start Freq	2.39950000 GHz	Stop Freq	2.40450000 GHz	CF Step	500.000000 kHz Auto Man	Freq Offset	0.00000000 Hz	Signal Track	On Off
Freq/Channel															
Center Freq	2.40200000 GHz														
Start Freq	2.39950000 GHz														
Stop Freq	2.40450000 GHz														
CF Step	500.000000 kHz Auto Man														
Freq Offset	0.00000000 Hz														
Signal Track	On Off														
<p><math>\pi</math> /4DQPSK/MCH</p>	<p>Agilent 07:10:17 Jan 24, 1987 R L</p> <p>Ref 20.9 dBm #Atten 30 dB Mkr1 2.440 947 GHz 0.84 dBm</p> <p>#Peak Log 10 dB/Offst 0.9 dB</p> <p>LgAv M1 S2 S3 FS</p> <p><math>\mathcal{E}(f)</math>: FTun Swp</p> <p>Center 2.441 000 GHz Span 5 MHz #Res BW 1.5 MHz #VBW 3 MHz Sweep 1.067 ms (8001 pts)</p> <p>File name error</p> <table border="1"> <thead> <tr> <th colspan="2">Freq/Channel</th> </tr> </thead> <tbody> <tr> <td>Center Freq</td> <td>2.44100000 GHz</td> </tr> <tr> <td>Start Freq</td> <td>2.43850000 GHz</td> </tr> <tr> <td>Stop Freq</td> <td>2.44350000 GHz</td> </tr> <tr> <td>CF Step</td> <td>500.000000 kHz Auto Man</td> </tr> <tr> <td>Freq Offset</td> <td>0.00000000 Hz</td> </tr> <tr> <td>Signal Track</td> <td>On Off</td> </tr> </tbody> </table>	Freq/Channel		Center Freq	2.44100000 GHz	Start Freq	2.43850000 GHz	Stop Freq	2.44350000 GHz	CF Step	500.000000 kHz Auto Man	Freq Offset	0.00000000 Hz	Signal Track	On Off
Freq/Channel															
Center Freq	2.44100000 GHz														
Start Freq	2.43850000 GHz														
Stop Freq	2.44350000 GHz														
CF Step	500.000000 kHz Auto Man														
Freq Offset	0.00000000 Hz														
Signal Track	On Off														
<p><math>\pi</math> /4DQPSK/HCH</p>	<p>Agilent 07:11:45 Jan 24, 1987 R L</p> <p>Ref 20.9 dBm #Atten 30 dB Mkr1 2.479 845 GHz 0.50 dBm</p> <p>#Peak Log 10 dB/Offst 0.9 dB</p> <p>LgAv M1 S2 S3 FS</p> <p><math>\mathcal{E}(f)</math>: FTun Swp</p> <p>Center 2.480 000 GHz Span 5 MHz #Res BW 1.5 MHz #VBW 3 MHz Sweep 1.067 ms (8001 pts)</p> <p>File name error</p> <table border="1"> <thead> <tr> <th colspan="2">Freq/Channel</th> </tr> </thead> <tbody> <tr> <td>Center Freq</td> <td>2.48000000 GHz</td> </tr> <tr> <td>Start Freq</td> <td>2.47750000 GHz</td> </tr> <tr> <td>Stop Freq</td> <td>2.48250000 GHz</td> </tr> <tr> <td>CF Step</td> <td>500.000000 kHz Auto Man</td> </tr> <tr> <td>Freq Offset</td> <td>0.00000000 Hz</td> </tr> <tr> <td>Signal Track</td> <td>On Off</td> </tr> </tbody> </table>	Freq/Channel		Center Freq	2.48000000 GHz	Start Freq	2.47750000 GHz	Stop Freq	2.48250000 GHz	CF Step	500.000000 kHz Auto Man	Freq Offset	0.00000000 Hz	Signal Track	On Off
Freq/Channel															
Center Freq	2.48000000 GHz														
Start Freq	2.47750000 GHz														
Stop Freq	2.48250000 GHz														
CF Step	500.000000 kHz Auto Man														
Freq Offset	0.00000000 Hz														
Signal Track	On Off														

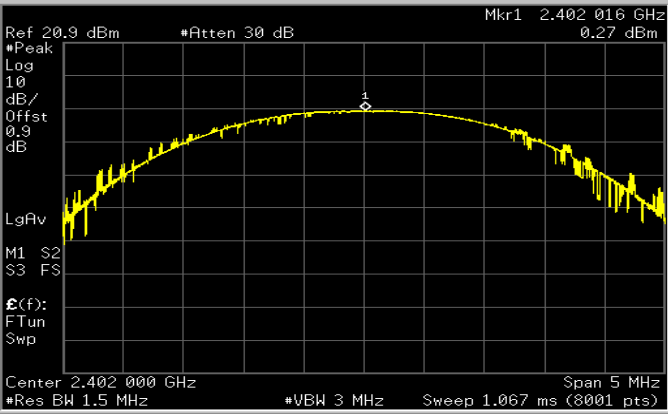
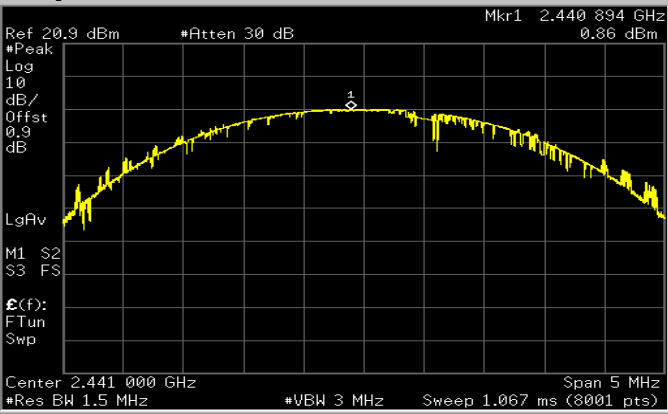
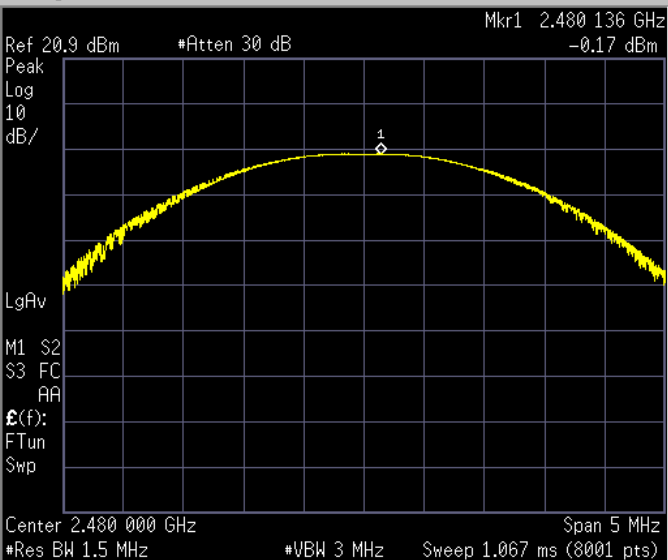

<p>8DPSK/LCH</p>	 <p>Agilent 07:17:06 Jan 24, 1987 R L</p> <p>Ref 20.9 dBm #Atten 30 dB Mkr1 2.402 016 GHz 0.27 dBm</p> <p>Center 2.402 000 GHz Span 5 MHz          #Res BW 1.5 MHz #VBW 3 MHz Sweep 1.067 ms (8001 pts)</p> <p><b>File name error</b></p> <p><b>Freq/Channel</b>          Center Freq 2.40200000 GHz          Start Freq 2.39950000 GHz          Stop Freq 2.40450000 GHz          CF Step 500.000000 kHz Auto Man          Freq Offset 0.00000000 Hz          Signal Track On Off</p>
<p>8DPSK/MCH</p>	 <p>Agilent 07:15:16 Jan 24, 1987 R L</p> <p>Ref 20.9 dBm #Atten 30 dB Mkr1 2.440 894 GHz 0.86 dBm</p> <p>Center 2.441 000 GHz Span 5 MHz          #Res BW 1.5 MHz #VBW 3 MHz Sweep 1.067 ms (8001 pts)</p> <p><b>File name error</b></p> <p><b>Freq/Channel</b>          Center Freq 2.44100000 GHz          Start Freq 2.43850000 GHz          Stop Freq 2.44350000 GHz          CF Step 500.000000 kHz Auto Man          Freq Offset 0.00000000 Hz          Signal Track On Off</p>
<p>8DPSK/HCH</p>	 <p>Agilent 20:11:19 Jan 23, 1987 R T</p> <p>Ref 20.9 dBm #Atten 30 dB Mkr1 2.480 136 GHz -0.17 dBm</p> <p>Center 2.480 000 GHz Span 5 MHz          #Res BW 1.5 MHz #VBW 3 MHz Sweep 1.067 ms (8001 pts)</p> <p><b>Copyright 2000-2005 Agilent Technologies</b></p> <p><b>Amplitude</b>          Ref Level 20.90 dBm          Attenuation 40.00 dB Auto Man          Scale/Div 10.00 dB          Scale Type Log Lin          Presel Center          Presel Adjust [3-26 GHz] 0.000 Hz          More 1 of 3</p>

## 8. 20DB BANDWIDTH

### 8.1. MEASUREMENT PROCEDURE

1. Connect EUT RF output port to the Spectrum Analyzer through an RF attenuator
2. Set the EUT Work on the top, the middle and the bottom operation frequency individually.
3. Set Span = approximately 2 to 3 times the 20 dB bandwidth, centered on a hopping channel  
RBW  $\geq$  1% of the 20 dB bandwidth, VBW  $\geq$  RBW; Sweep = auto; Detector function = peak
4. Set SPA Trace 1 Max hold, then View.

### 8.2. TEST SET-UP (BLOCK DIAGRAM OF CONFIGURATION)

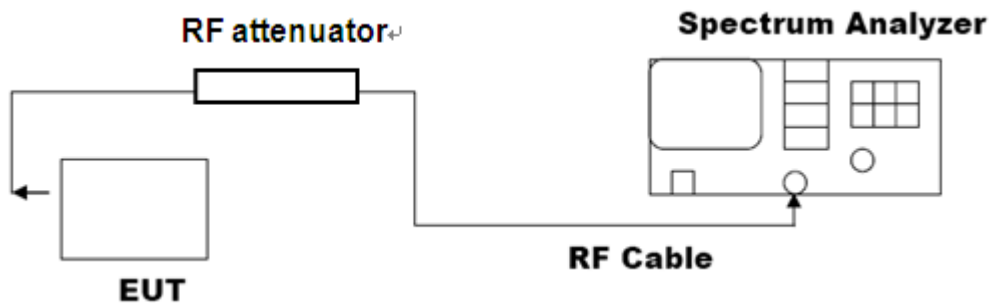

### 8.3. LIMITS AND MEASUREMENT RESULTS

Mode	Channel.	EBW [MHz]	OBW [MHz]	Verdict
GFSK	LCH	0.7591	0.8244	PASS
GFSK	MCH	0.8232	0.8220	PASS
GFSK	HCH	0.8086	0.8382	PASS
$\pi/4$ DQPSK	LCH	1.1344	1.0727	PASS
$\pi/4$ DQPSK	MCH	1.0968	1.0466	PASS
$\pi/4$ DQPSK	HCH	1.1096	1.0442	PASS
8DPSK	LCH	1.1288	1.0816	PASS
8DPSK	MCH	1.1576	1.0421	PASS
8DPSK	HCH	1.1545	1.0756	PASS

Test Graph

Graphs	
GFSK/LCH	<div style="border: 1px solid black; padding: 5px;"> <p>Agilent 06:54:44 Jan 24, 1987 <span style="float: right;">R T</span></p> <hr/> <p style="text-align: center;"><b>Ch Freq</b> 2.402 GHz <span style="float: right;"><b>Trig</b> Free</span></p> <p>Occupied Bandwidth <span style="float: right;">█</span></p> <hr/> <p>Ref 20.9 dBm #Atten 30 dB</p> <p>#Peak Log 10 dB/Offst 0.9 dB</p> <p style="text-align: center;">Center 2.402 000 GHz <span style="float: right;">Span 3 MHz</span></p> <p>#Res BW 30 kHz #VBW 100 kHz Sweep 3.2 ms (601 pts)</p> <div style="border: 1px solid green; padding: 2px;"> <p><b>Occupied Bandwidth</b> <span style="float: right;"><b>Occ BW % Pwr</b> 99.00 %</span></p> <p style="text-align: center;"><b>824.3958 kHz</b> <span style="float: right;"><b>x dB</b> -20.00 dB</span></p> <p><b>Transmit Freq Error</b> -8.225 kHz</p> <p><b>x dB Bandwidth</b> 759.061 kHz</p> </div> <p style="color: red; font-size: small;">File name error</p> </div>
GFSK/MCH	<div style="border: 1px solid black; padding: 5px;"> <p>Agilent 06:56:23 Jan 24, 1987 <span style="float: right;">R T</span></p> <hr/> <p style="text-align: center;"><b>Ch Freq</b> 2.441 GHz <span style="float: right;"><b>Trig</b> Free</span></p> <p>Occupied Bandwidth <span style="float: right;">█</span></p> <hr/> <p>Ref 20.9 dBm #Atten 30 dB</p> <p>#Peak Log 10 dB/Offst 0.9 dB</p> <p style="text-align: center;">Center 2.441 000 GHz <span style="float: right;">Span 3 MHz</span></p> <p>#Res BW 30 kHz #VBW 100 kHz Sweep 3.2 ms (601 pts)</p> <div style="border: 1px solid green; padding: 2px;"> <p><b>Occupied Bandwidth</b> <span style="float: right;"><b>Occ BW % Pwr</b> 99.00 %</span></p> <p style="text-align: center;"><b>821.9668 kHz</b> <span style="float: right;"><b>x dB</b> -20.00 dB</span></p> <p><b>Transmit Freq Error</b> -8.720 kHz</p> <p><b>x dB Bandwidth</b> 823.166 kHz</p> </div> <p style="color: red; font-size: small;">File name error</p> </div>
GFSK/HCH	<div style="border: 1px solid black; padding: 5px;"> <p>Agilent 06:57:46 Jan 24, 1987 <span style="float: right;">R L</span></p> <hr/> <p style="text-align: center;"><b>Ch Freq</b> 2.48 GHz <span style="float: right;"><b>Trig</b> Free</span></p> <p>Occupied Bandwidth <span style="float: right;">█</span></p> <hr/> <p>Ref 20.9 dBm #Atten 30 dB</p> <p>#Peak Log 10 dB/Offst 0.9 dB</p> <p style="text-align: center;">Center 2.480 000 GHz <span style="float: right;">Span 3 MHz</span></p> <p>#Res BW 30 kHz #VBW 100 kHz Sweep 3.2 ms (601 pts)</p> <div style="border: 1px solid green; padding: 2px;"> <p><b>Occupied Bandwidth</b> <span style="float: right;"><b>Occ BW % Pwr</b> 99.00 %</span></p> <p style="text-align: center;"><b>838.2459 kHz</b> <span style="float: right;"><b>x dB</b> -20.00 dB</span></p> <p><b>Transmit Freq Error</b> -3.947 kHz</p> <p><b>x dB Bandwidth</b> 808.537 kHz</p> </div> <p style="color: red; font-size: small;">File name error</p> </div>

<p><math>\pi</math> /4DQPSK/LCH</p>	<p>Agilent 07:07:39 Jan 24, 1987 R L</p> <p>Ch Freq 2.402 GHz Trig Free</p> <p>Center 2.402 000 GHz Span 3 MHz</p> <p>Occupied Bandwidth 1.0727 MHz Occ BW % Pwr 99.00 % x dB -20.00 dB</p> <p>Transmit Freq Error -4.306 kHz x dB Bandwidth 1.134 MHz</p> <p>File name error</p>
<p><math>\pi</math> /4DQPSK/MCH</p>	<p>Agilent 07:10:11 Jan 24, 1987 R T</p> <p>Ch Freq 2.441 GHz Trig Free</p> <p>Center 2.441 000 GHz Span 3 MHz</p> <p>Occupied Bandwidth 1.0466 MHz Occ BW % Pwr 99.00 % x dB -20.00 dB</p> <p>Transmit Freq Error 311.271 Hz x dB Bandwidth 1.097 MHz</p> <p>File name error</p>
<p><math>\pi</math> /4DQPSK/HCH</p>	<p>Agilent 07:11:38 Jan 24, 1987 R L</p> <p>Ch Freq 2.48 GHz Trig Free</p> <p>Center 2.480 000 GHz Span 3 MHz</p> <p>Occupied Bandwidth 1.0442 MHz Occ BW % Pwr 99.00 % x dB -20.00 dB</p> <p>Transmit Freq Error 1.038 kHz x dB Bandwidth 1.110 MHz</p> <p>File name error</p>

<p>8DPSK/LCH</p>	<p>Agilent 07:16:59 Jan 24, 1987 R L</p> <p>Ch Freq 2.402 GHz Trig Free</p> <p>Center Freq 2.4020000 GHz</p> <p>Start Freq 2.4005000 GHz</p> <p>Stop Freq 2.4035000 GHz</p> <p>CF Step 300.00000 kHz Auto Man</p> <p>Freq Offset 0.0000000 Hz</p> <p>Signal Track On Off</p> <p>Ref 20.9 dBm #Atten 30 dB</p> <p>#Peak Log 10 dB/Offst 0.9 dB</p> <p>Center 2.402 000 GHz Span 3 MHz</p> <p>#Res BW 30 kHz #VBW 100 kHz Sweep 3.2 ms (601 pts)</p> <p><b>Occupied Bandwidth 1.0816 MHz</b> Occ BW % Pwr 99.00 % x dB -20.00 dB</p> <p>Transmit Freq Error 4.098 kHz</p> <p>x dB Bandwidth 1.129 MHz</p> <p>File name error</p>
<p>8DPSK/MCH</p>	<p>Agilent 07:15:09 Jan 24, 1987 R T</p> <p>Ch Freq 2.441 GHz Trig Free</p> <p>Center Freq 2.4410000 GHz</p> <p>Start Freq 2.4395000 GHz</p> <p>Stop Freq 2.4425000 GHz</p> <p>CF Step 300.00000 kHz Auto Man</p> <p>Freq Offset 0.0000000 Hz</p> <p>Signal Track On Off</p> <p>Ref 20.9 dBm #Atten 30 dB</p> <p>#Peak Log 10 dB/Offst 0.9 dB</p> <p>Center 2.441 000 GHz Span 3 MHz</p> <p>#Res BW 30 kHz #VBW 100 kHz Sweep 3.2 ms (601 pts)</p> <p><b>Occupied Bandwidth 1.0421 MHz</b> Occ BW % Pwr 99.00 % x dB -20.00 dB</p> <p>Transmit Freq Error 11.336 kHz</p> <p>x dB Bandwidth 1.158 MHz</p> <p>File name error</p>
<p>8DPSK/HCH</p>	<p>Agilent 07:13:19 Jan 24, 1987 R T</p> <p>Ch Freq 2.48 GHz Trig Free</p> <p>Center Freq 2.4800000 GHz</p> <p>Start Freq 2.4785000 GHz</p> <p>Stop Freq 2.4815000 GHz</p> <p>CF Step 300.00000 kHz Auto Man</p> <p>Freq Offset 0.0000000 Hz</p> <p>Signal Track On Off</p> <p>Ref 20.9 dBm #Atten 30 dB</p> <p>#Peak Log 10 dB/Offst 0.9 dB</p> <p>Center 2.480 000 GHz Span 3 MHz</p> <p>#Res BW 30 kHz #VBW 100 kHz Sweep 3.2 ms (601 pts)</p> <p><b>Occupied Bandwidth 1.0756 MHz</b> Occ BW % Pwr 99.00 % x dB -20.00 dB</p> <p>Transmit Freq Error -965.861 Hz</p> <p>x dB Bandwidth 1.154 MHz</p> <p>File name error</p>

## 9. CONDUCTED SPURIOUS EMISSION

### 9.1. MEASUREMENT PROCEDURE

1. Connect EUT RF output port to the Spectrum Analyzer through an RF attenuator
2. Set the EUT Work on the top, the Middle and the bottom operation frequency individually.
3. Set the Span = wide enough to capture the peak level of the in-band emission and all spurious emissions from the lowest frequency generated in the EUT up through the 10th harmonic.  
RBW = 100 kHz; VBW  $\geq$  RBW; Sweep = auto; Detector function = peak.
4. Set SPA Trace 1 Max hold, then View.

**Note:** The EUT was tested according to DA000705 for compliance to FCC 47CFR 15.247 requirements. Owing to satisfy the requirements of the number of measurement points, we set the RBW=1MHz, VBW > RBW, scan up through 10th harmonic, and consider the tested results as the worst case, if the tested results conform to the requirement, we can deem that the real tested results(set the RBW=100KHz, VBW > RBW) are conform to the requirement.

### 9.2. TEST SET-UP (BLOCK DIAGRAM OF CONFIGURATION)

The same as described in section 8.2

### 9.3. MEASUREMENT EQUIPMENT USED

The same as described in section 6

### 9.4. LIMITS AND MEASUREMENT RESULT

LIMITS AND MEASUREMENT RESULT		
Applicable Limits	Measurement Result	
	Test Data	Criteria
In any 100 KHz Bandwidth Outside the frequency band in which the spread spectrum intentional radiator is operating, the radio frequency power that is produce by the intentional radiator shall be at least 20 dB below that in 100KHz bandwidth within the band that contains the highest level of the desired power. In addition, radiation emissions which fall in the restricted bands, as defined in §15.205(a), must also comply with the radiated emission limits specified in§15.209(a))	At least -20dBc than the limit Specified on the BOTTOM Channel	PASS
	At least -20dBc than the limit Specified on the TOP Channel	PASS

Test Graph

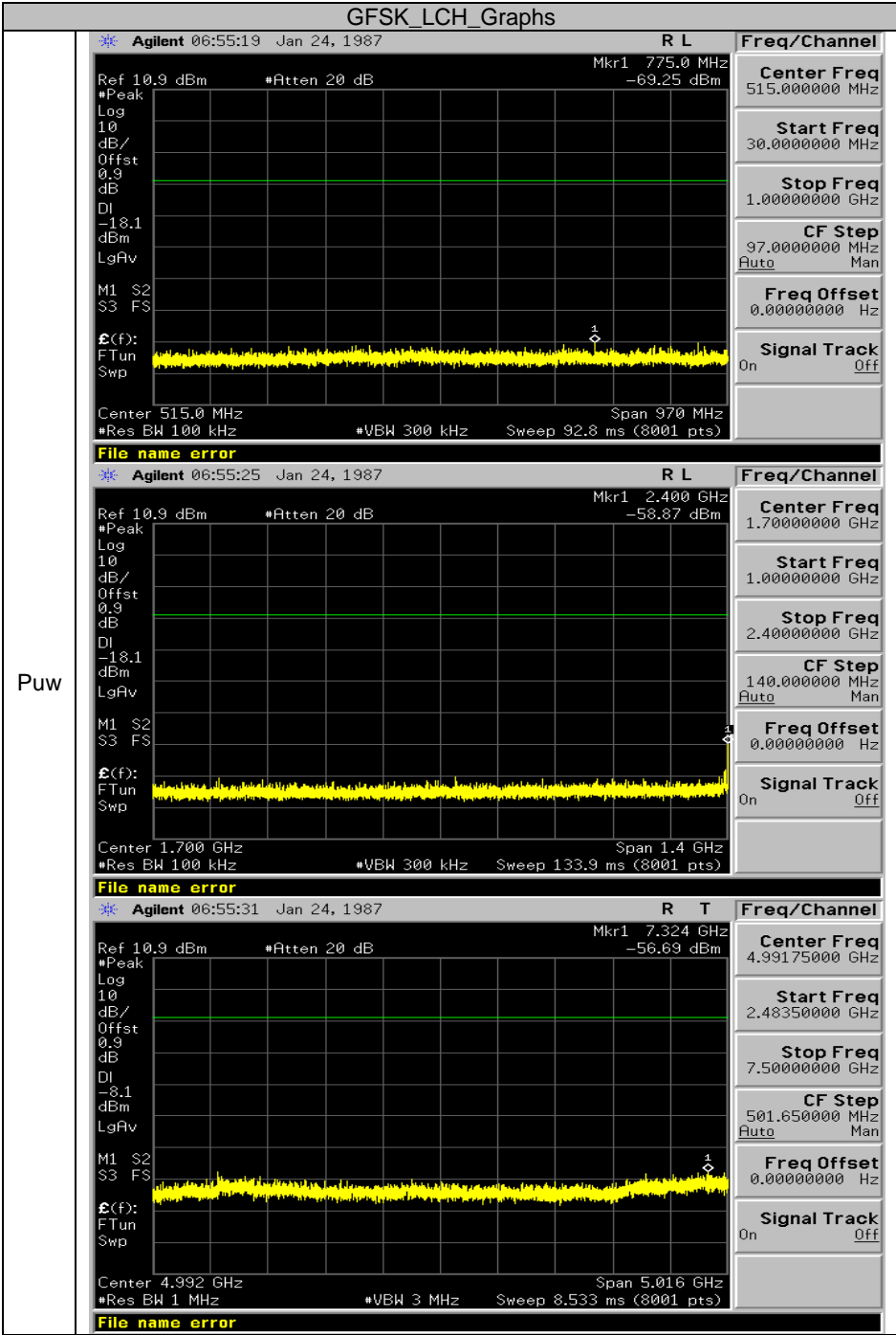

Puw

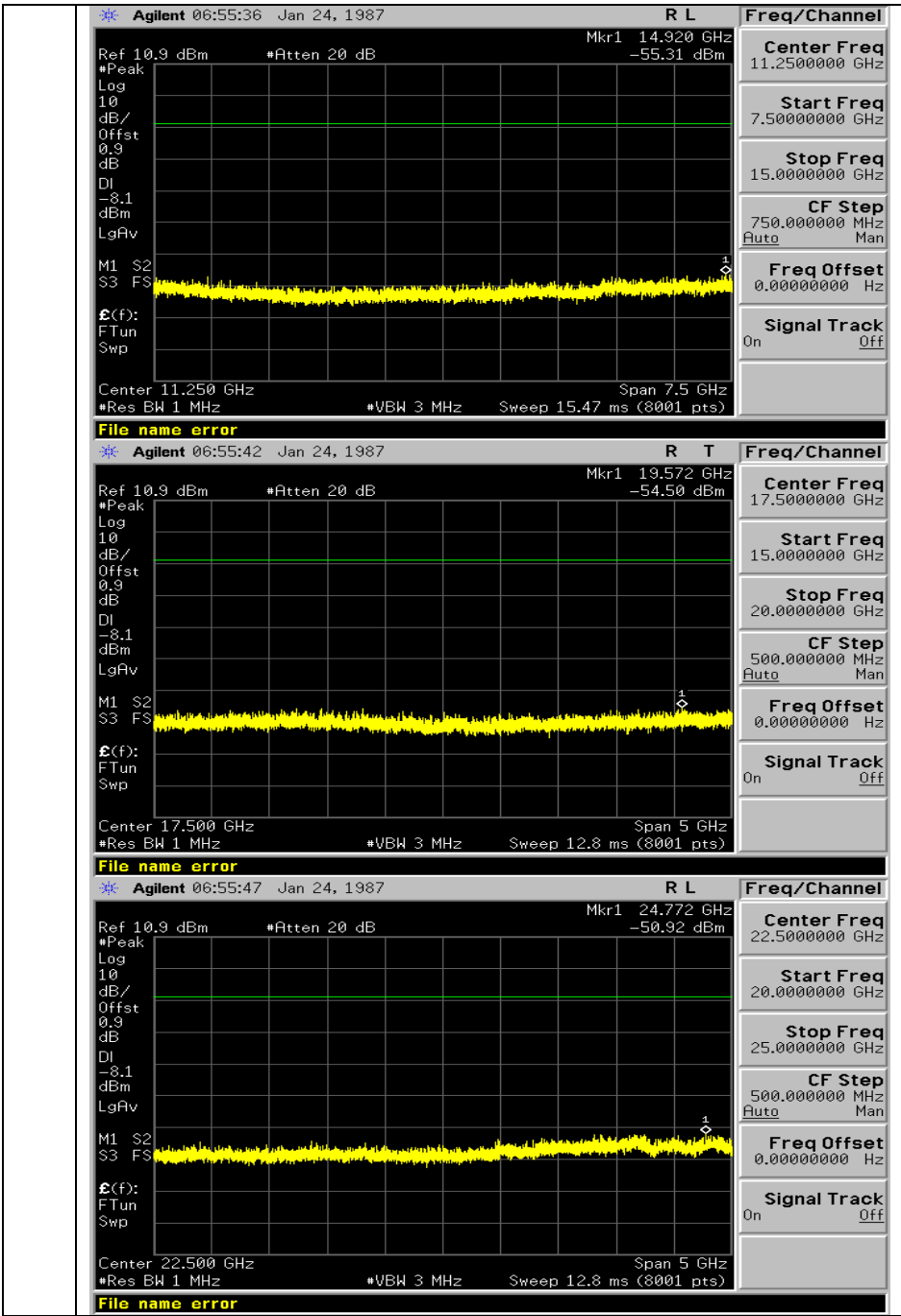



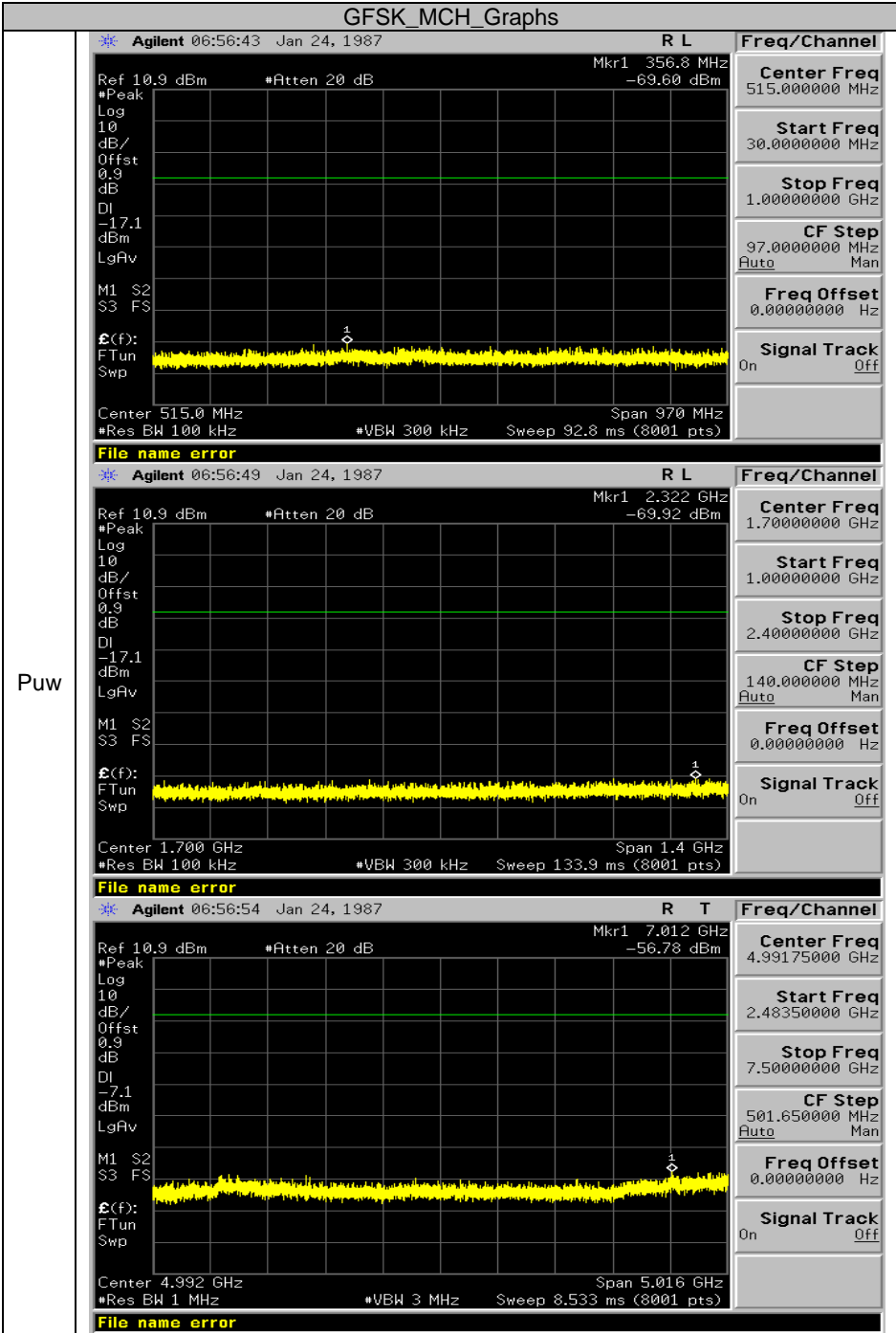

Puw

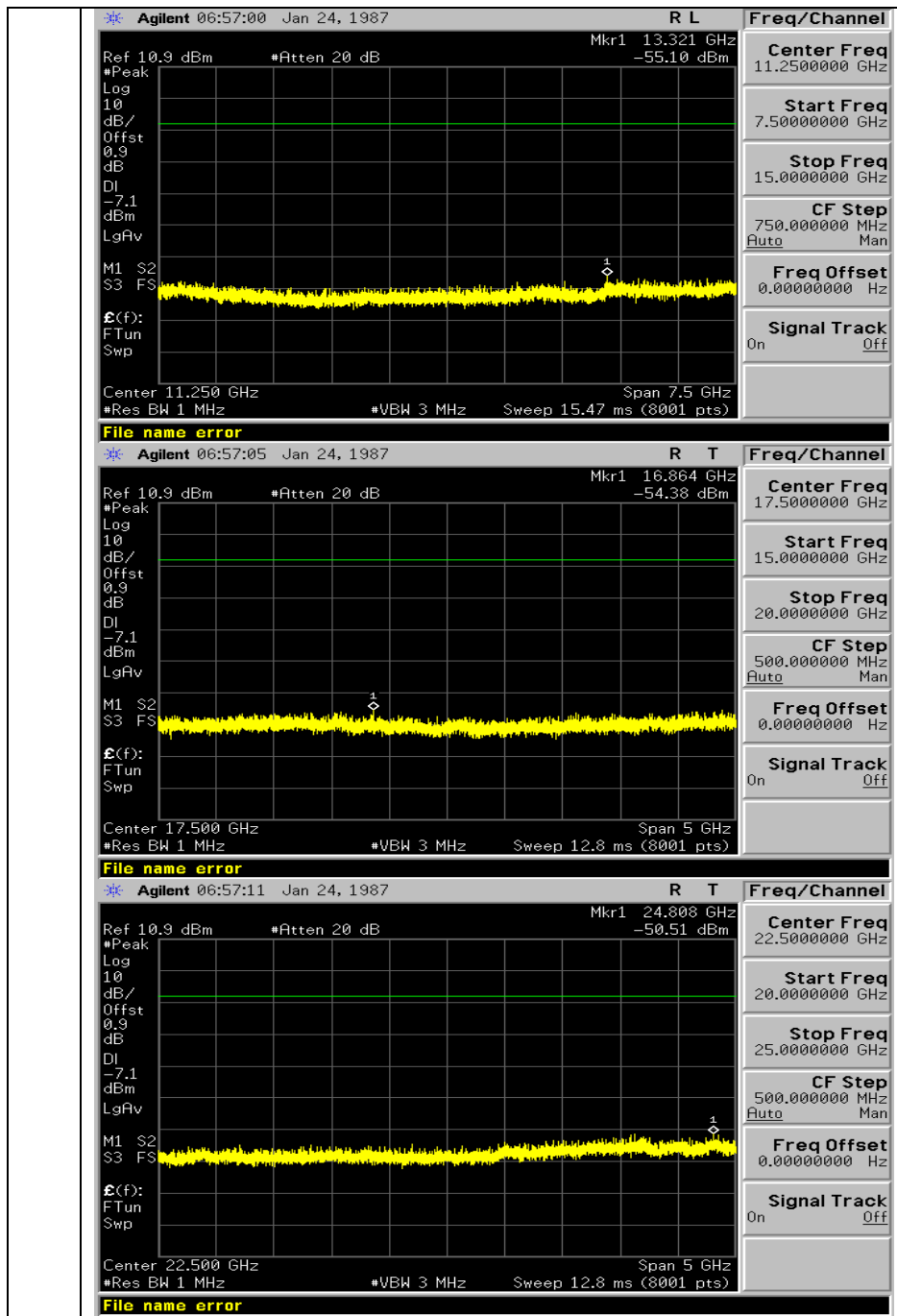

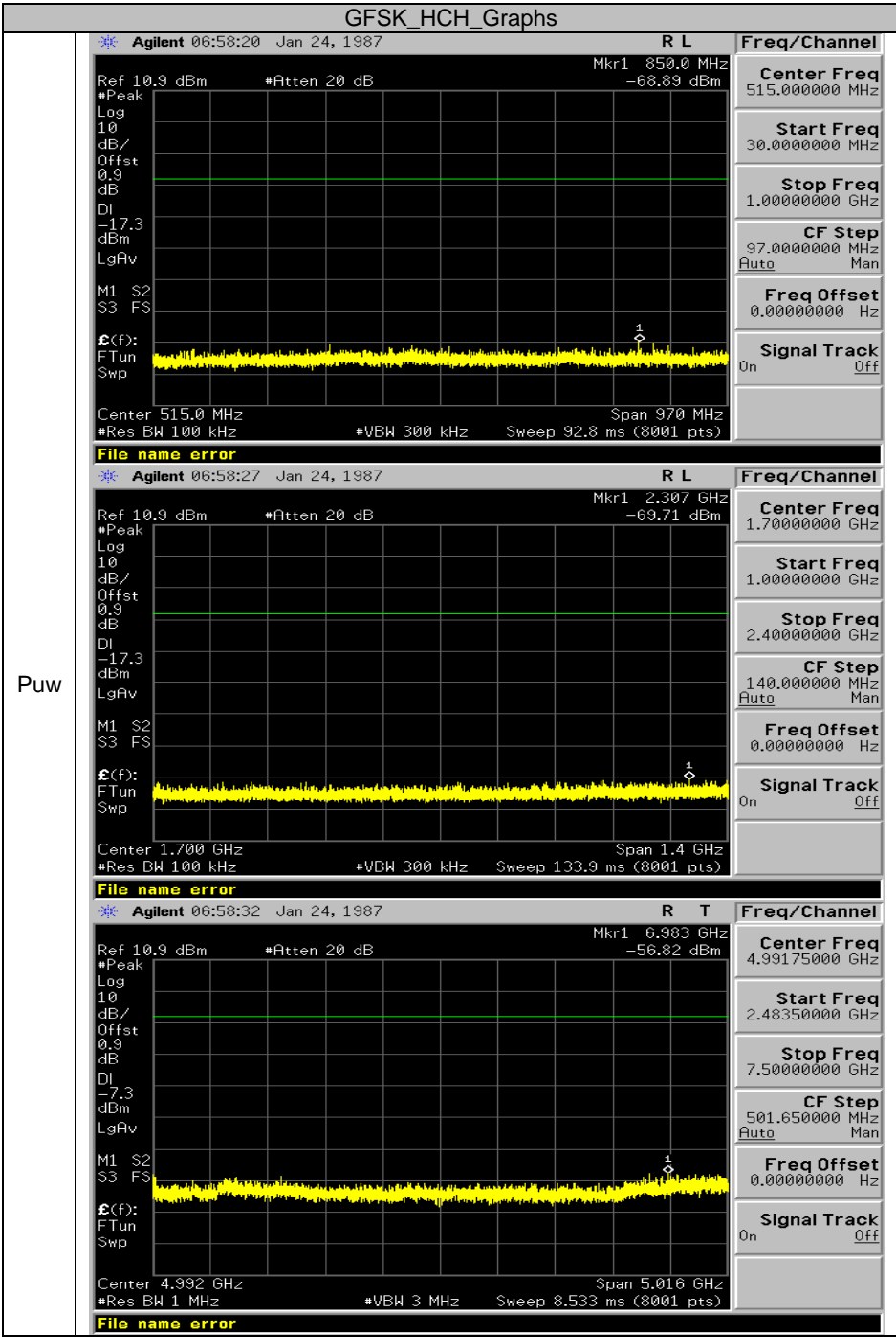

Puw

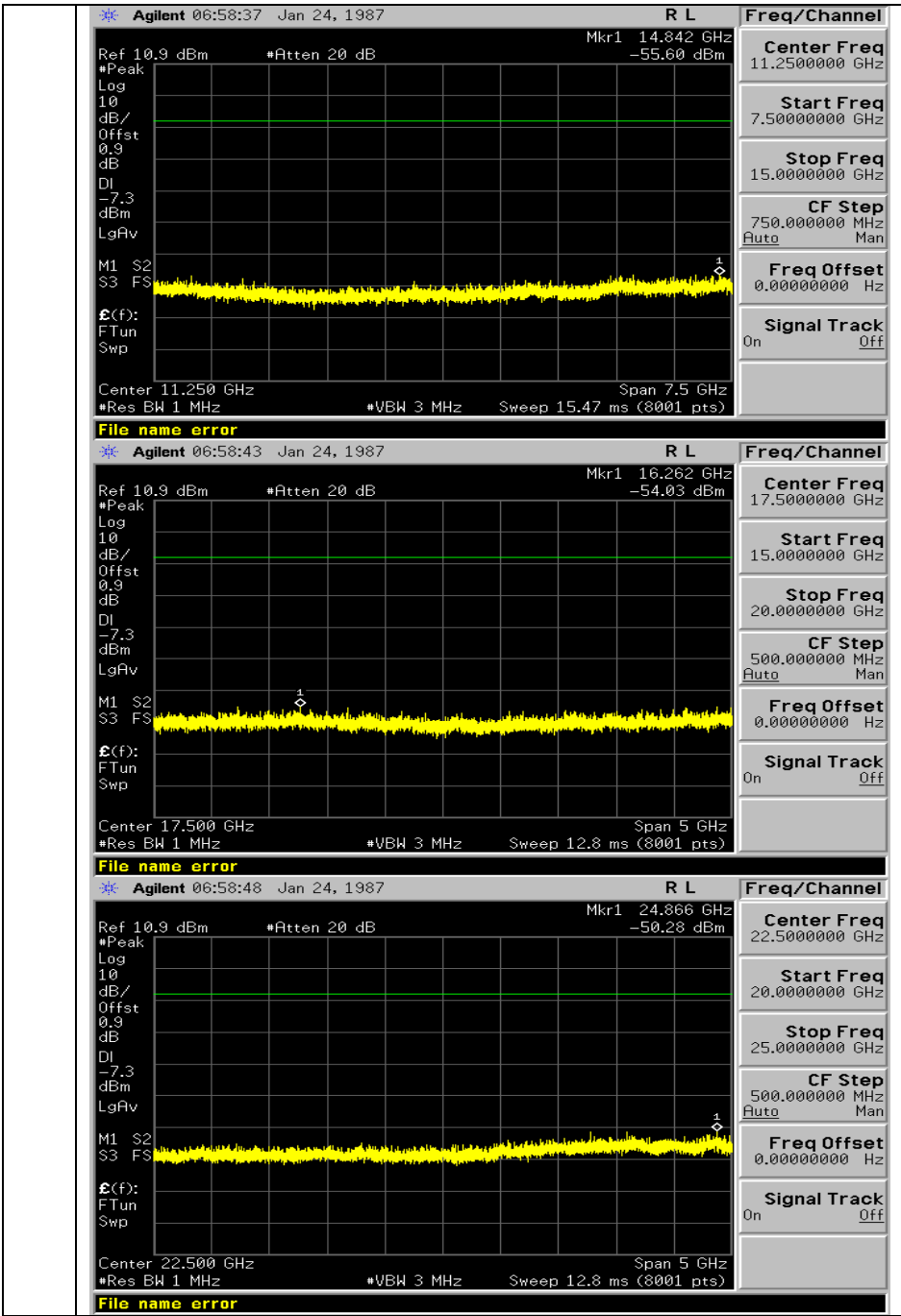

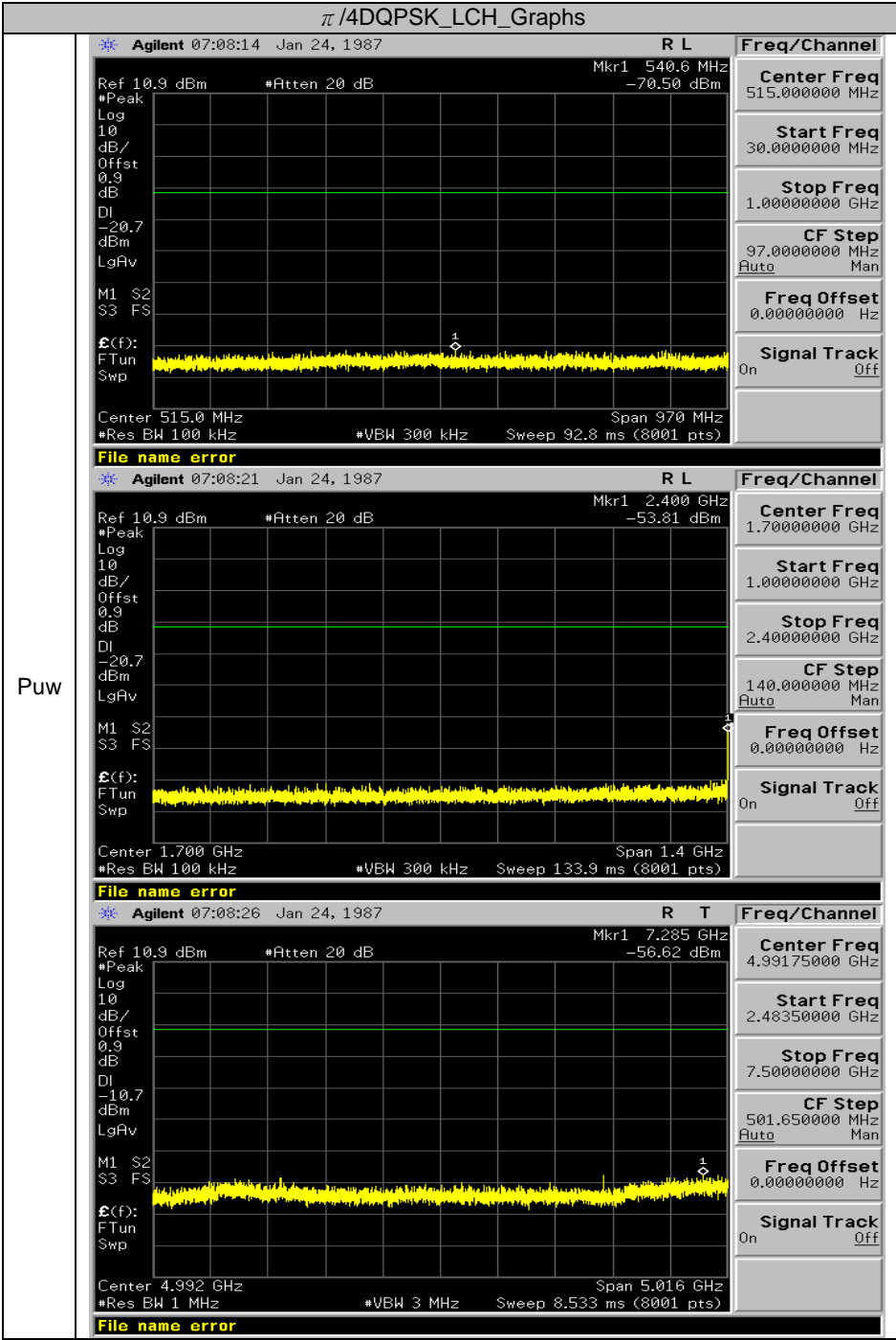

Puw

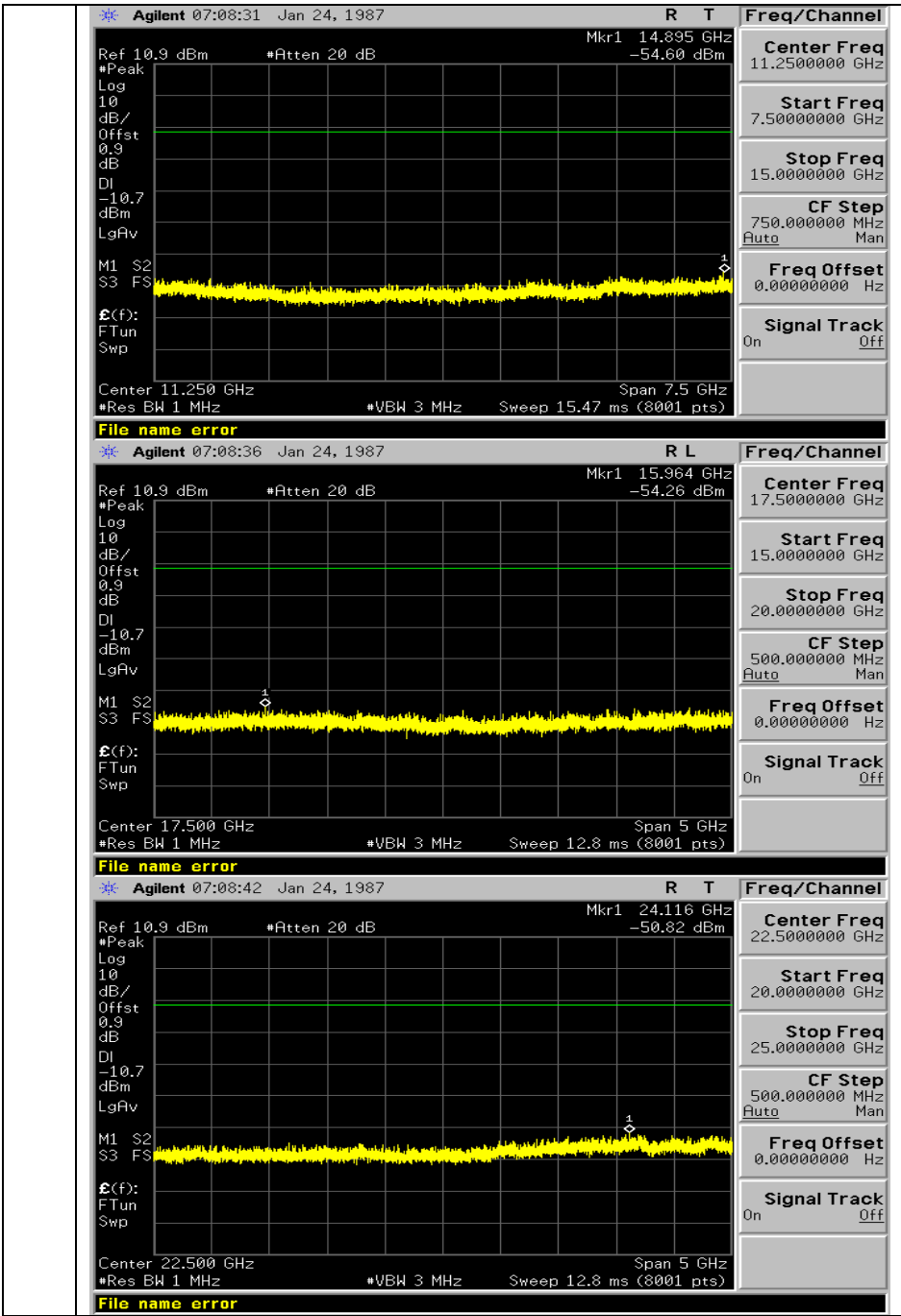

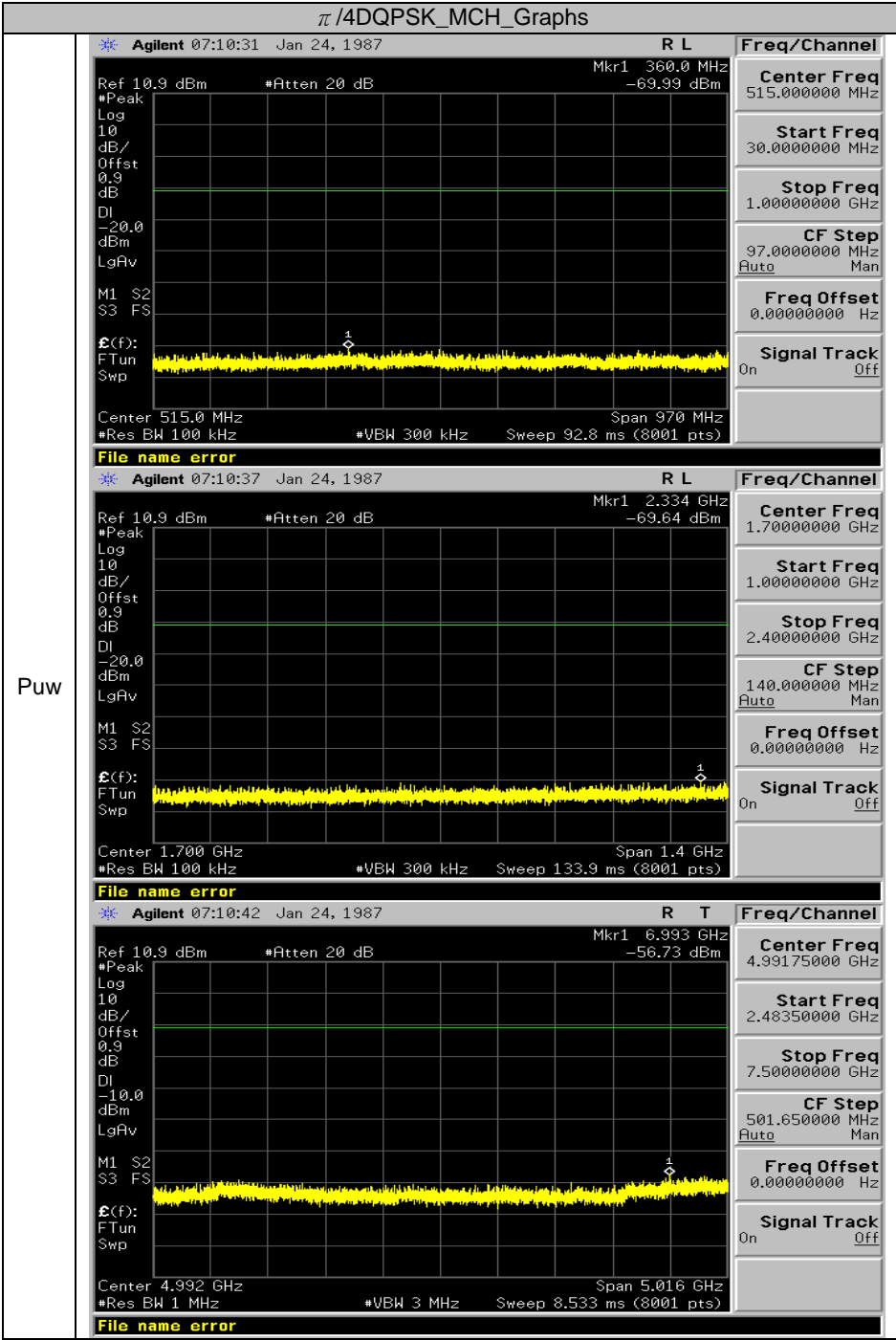

Puw

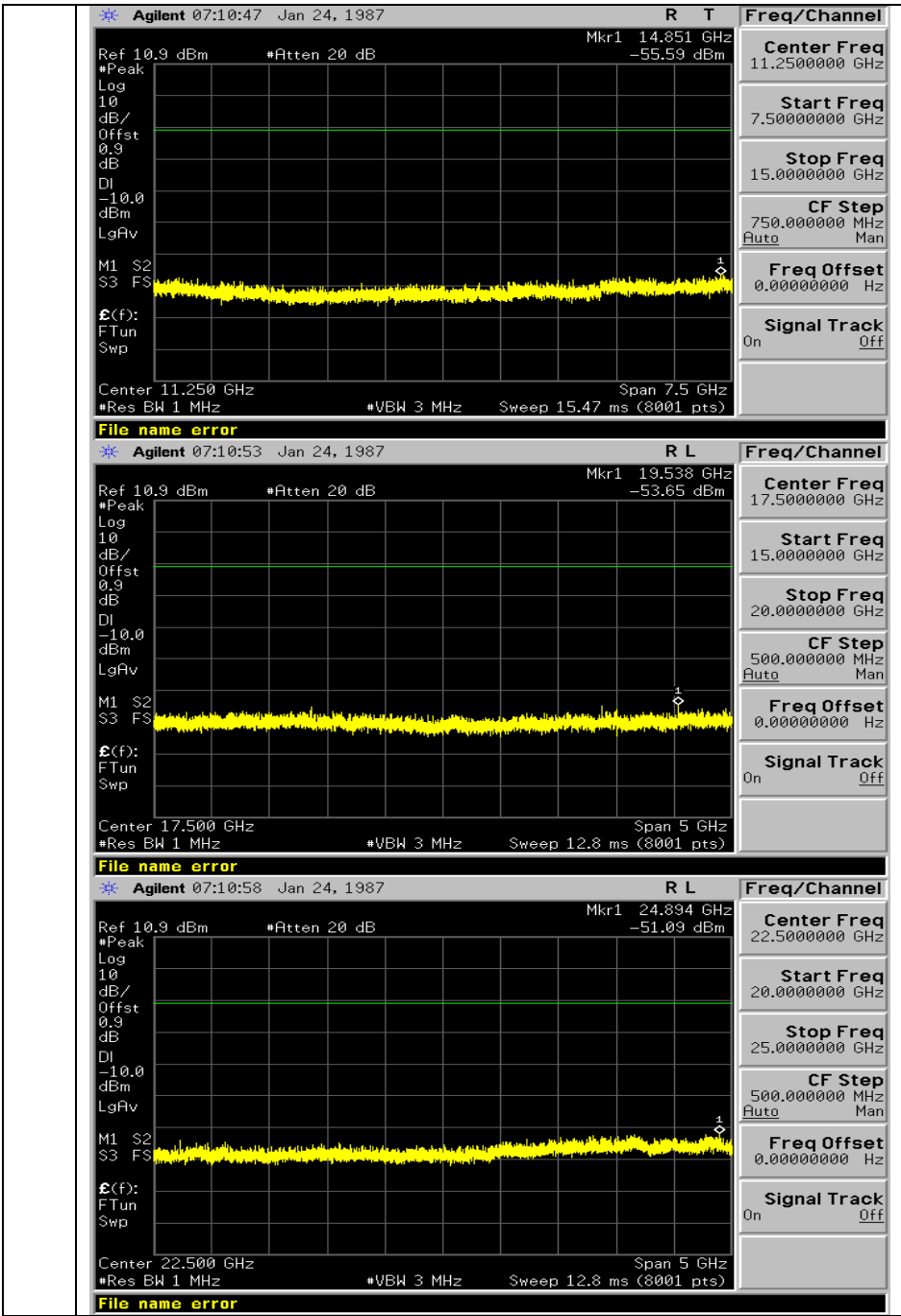



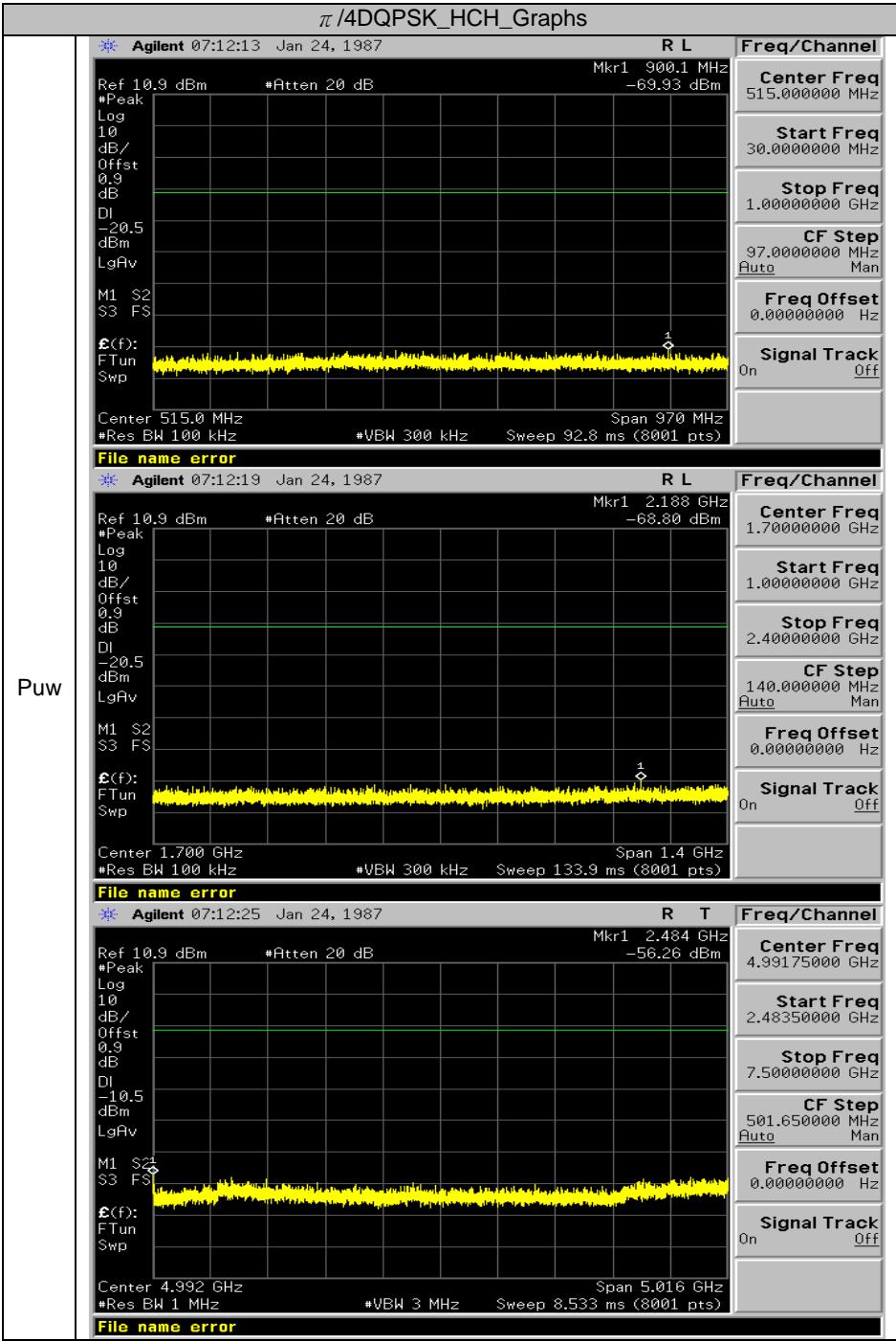

Puw

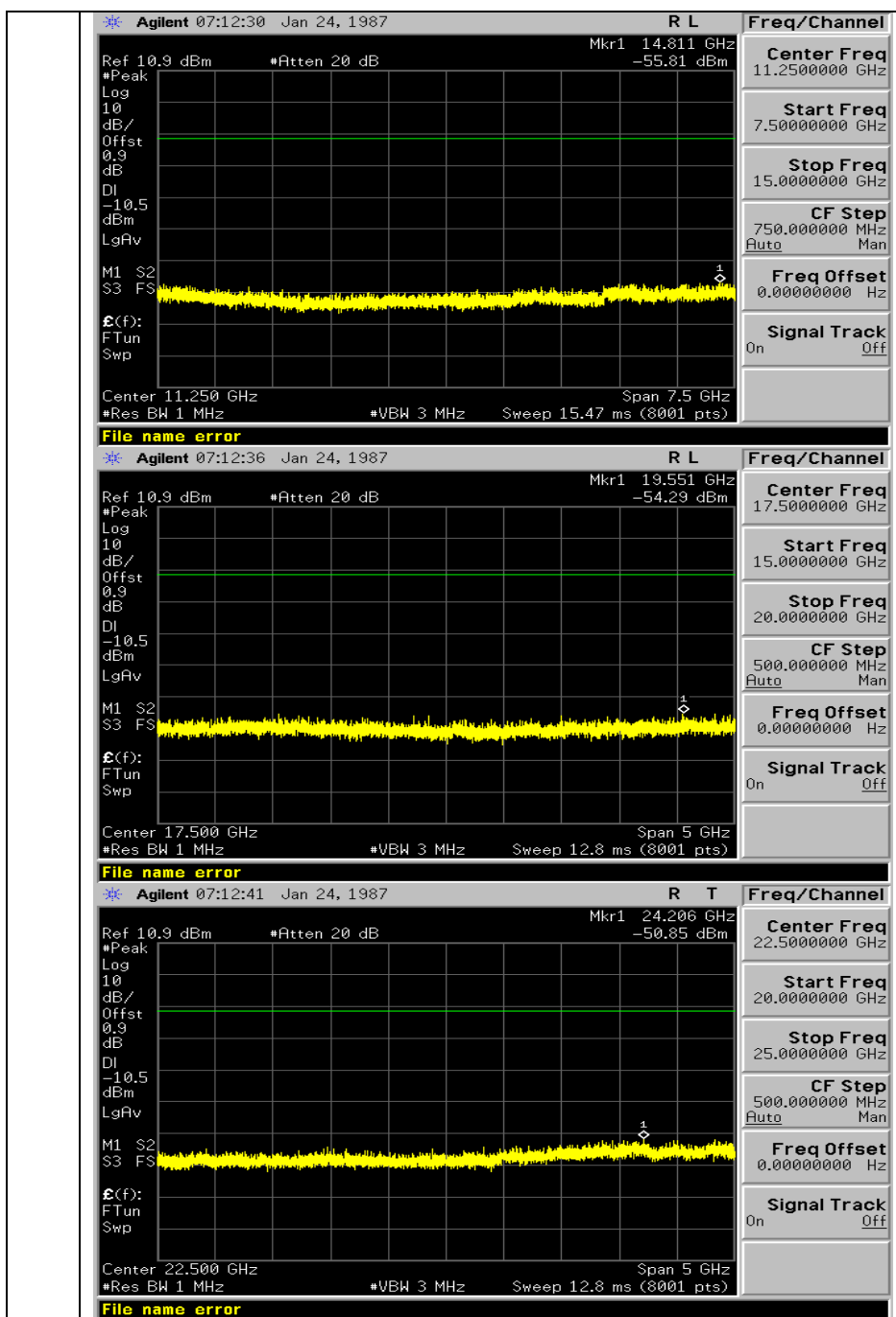

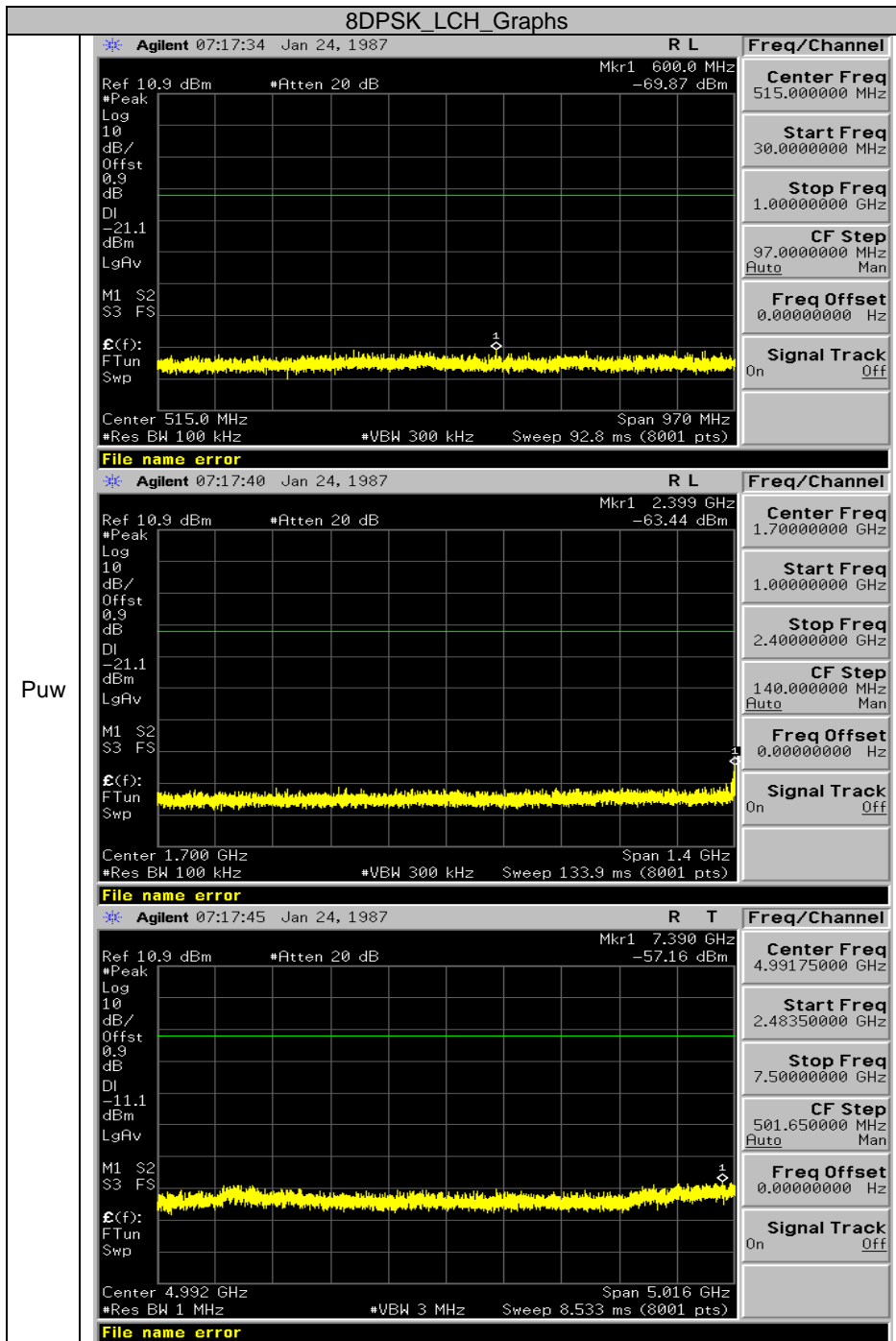

Puw

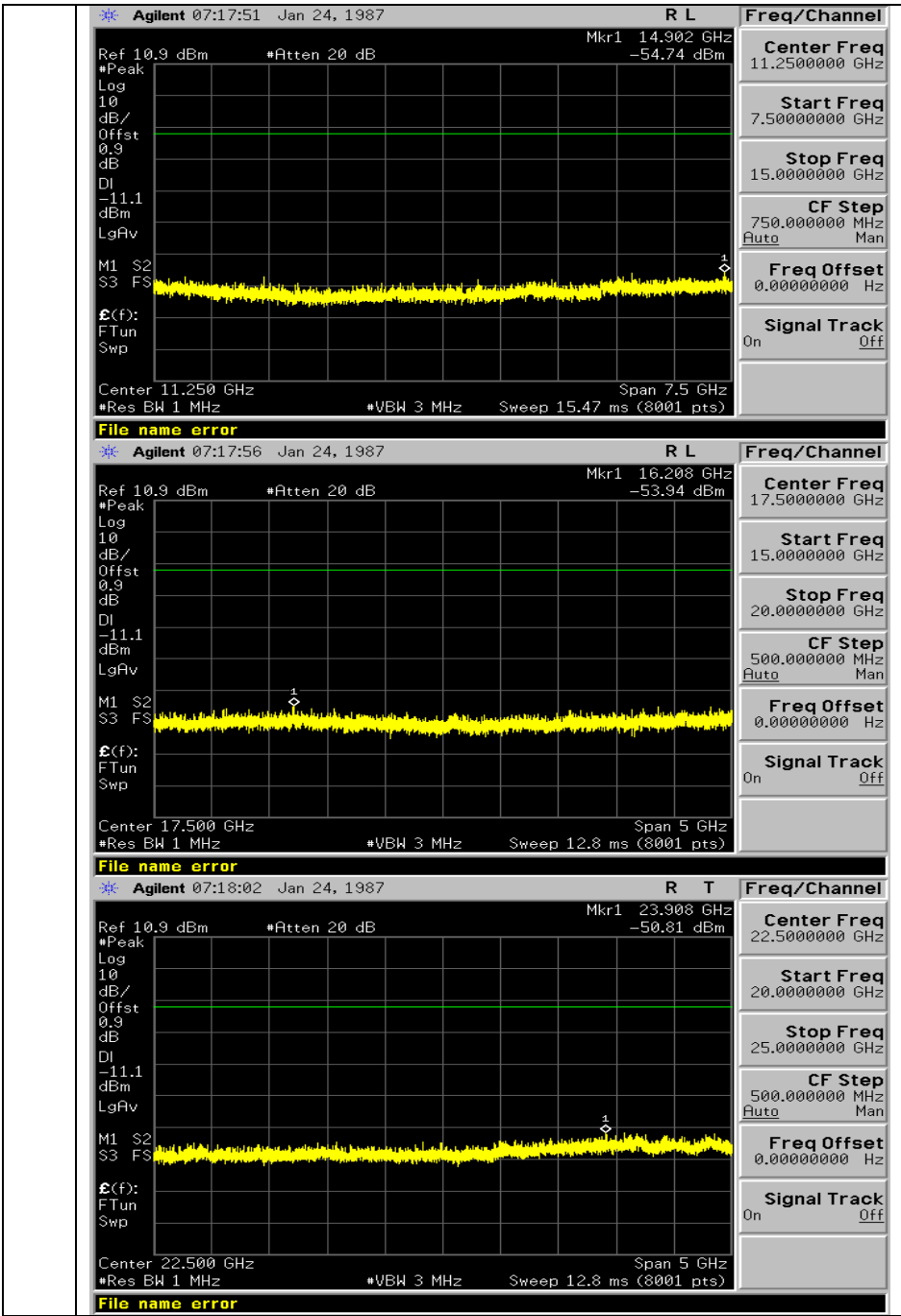

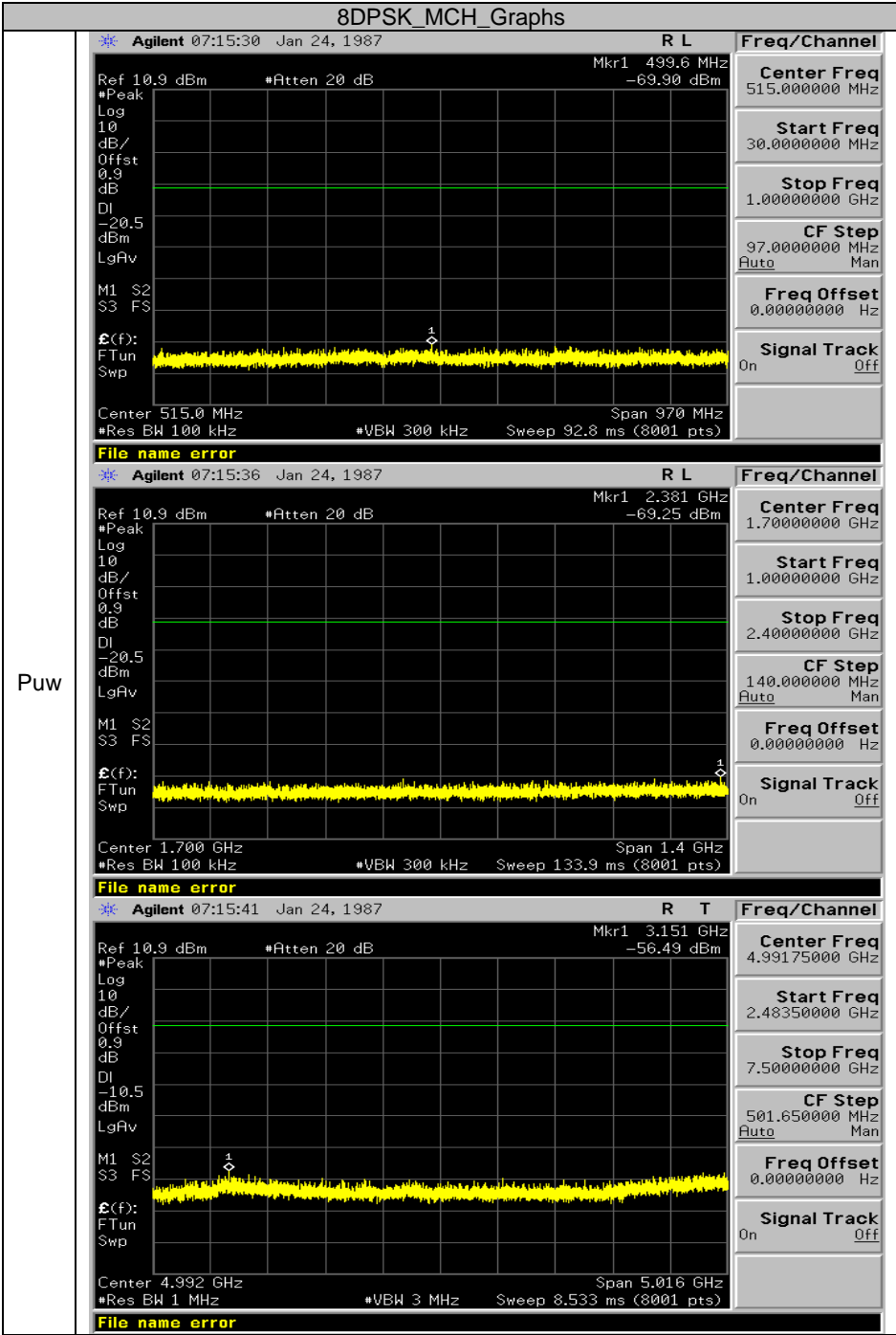

Puw

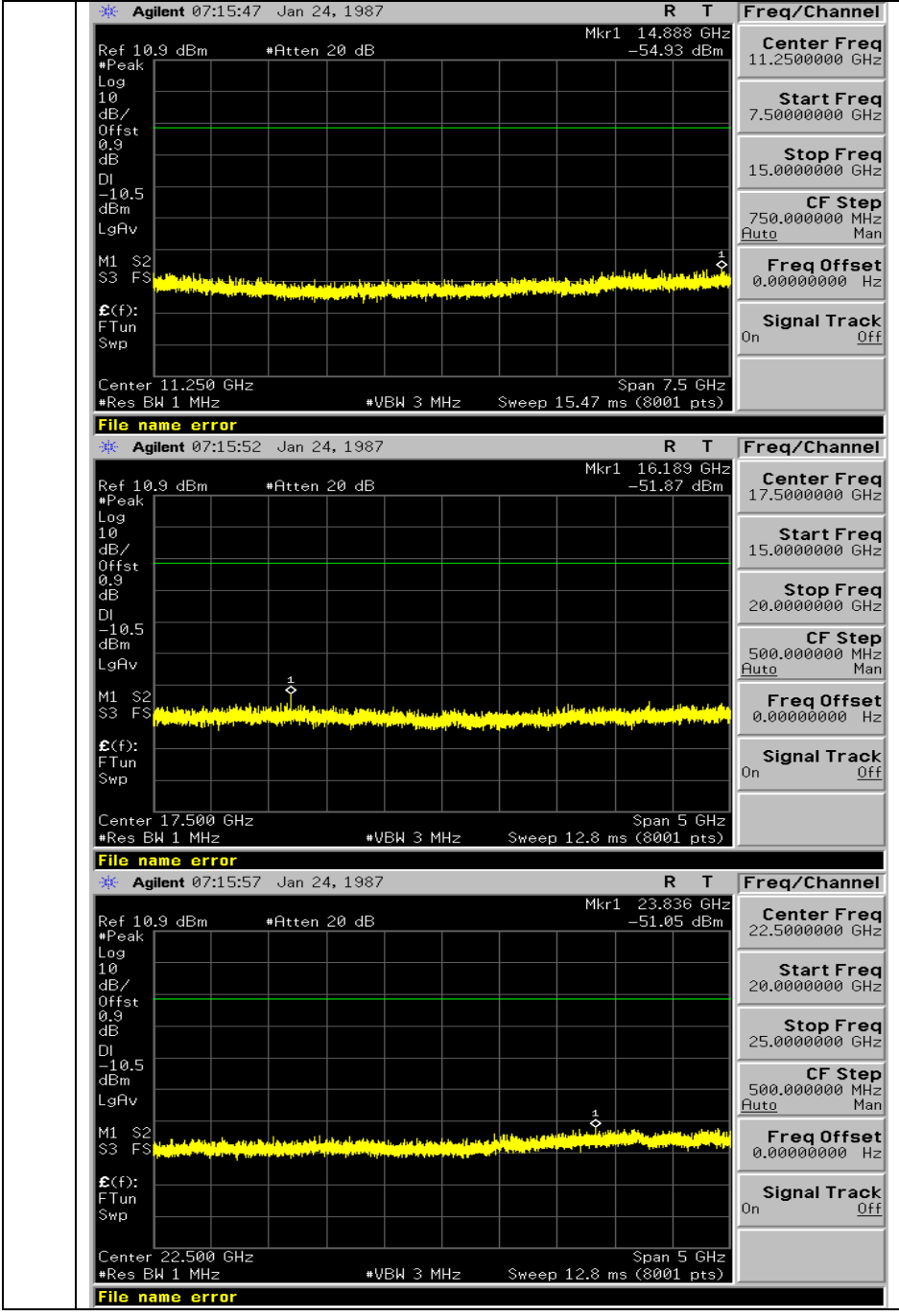

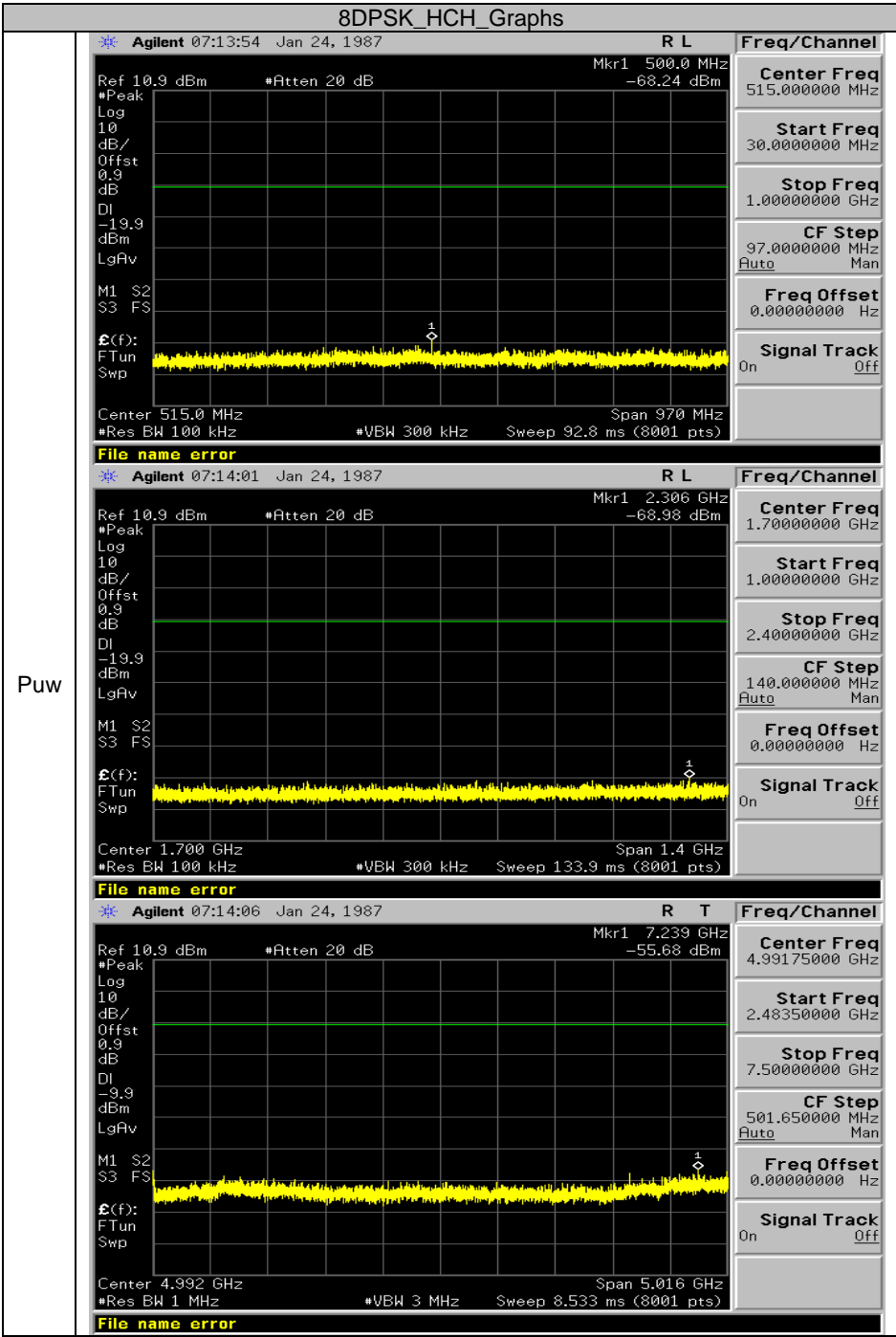

Puw

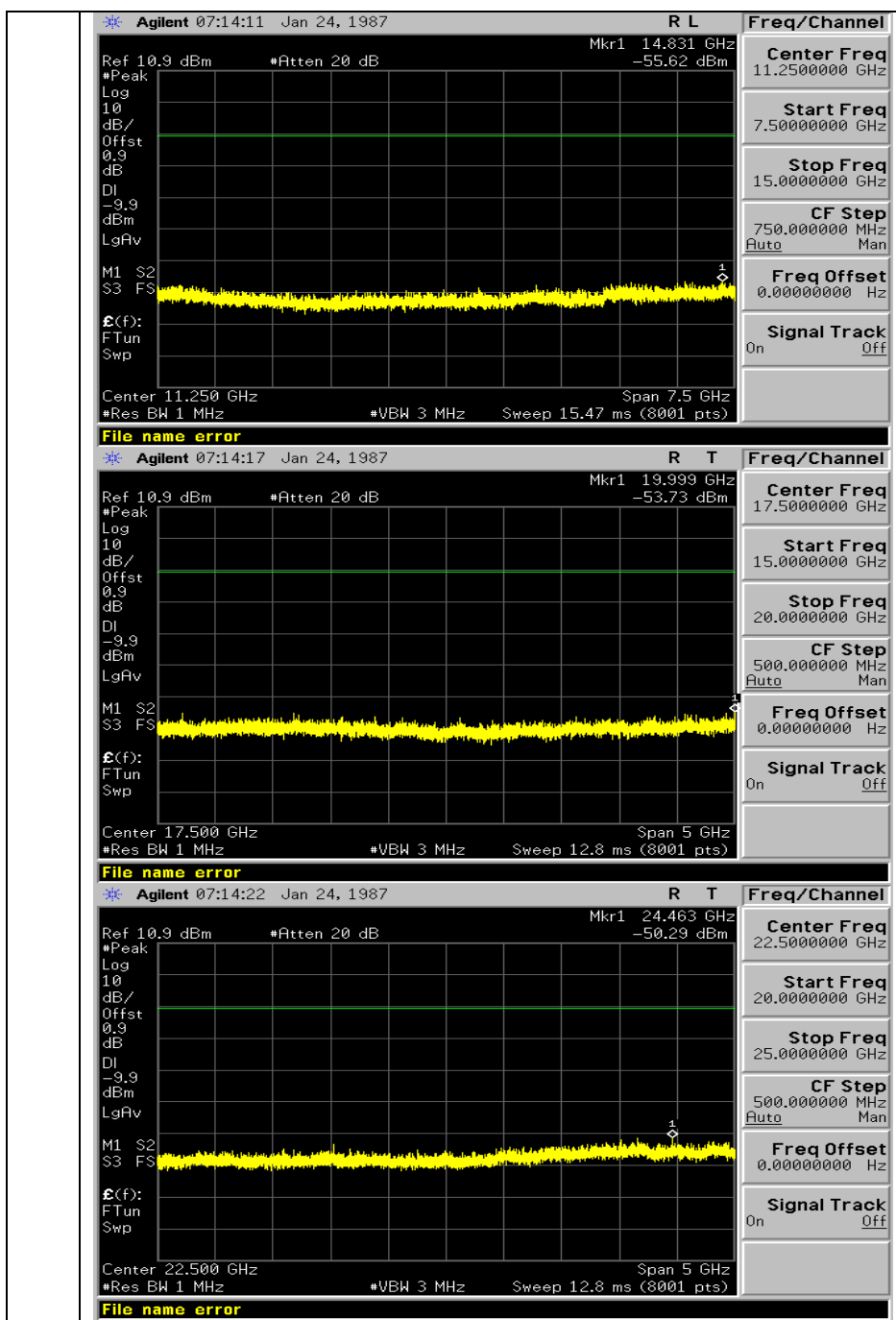



## 10. RADIATED EMISSION

### 10.1. MEASUREMENT PROCEDURE

1. Configure the EUT according to ANSI C63.10. The EUT was placed on the top of the turntable 0.8 meter above ground. The phase center of the receiving antenna mounted on the top of a height-variable antenna tower was placed 3 meters far away from the turntable.
2. Power on the EUT and all the supporting units. The turntable was rotated by 360 degrees to determine the position of the highest radiation.
3. The height of the broadband receiving antenna was varied between one meter and four meters above ground to find the maximum emissions field strength of both horizontal and vertical polarization.
4. For each suspected emissions, the antenna tower was scan (from 1 M to 4 M) and then the turntable was rotated (from 0 degree to 360 degrees) to find the maximum reading.
5. Set the test-receiver system to Peak or CISPR quasi-peak Detect Function with specified bandwidth under Maximum Hold Mode.
6. For emissions above 1GHz, use 1MHz VBW and RBW for peak reading. Then 1MHz RBW and 10Hz VBW for average reading in spectrum analyzer. The EUT was placed on the top of the turntable 1.5 meter above ground. The phase center of the receiving antenna mounted on the top of a height-variable antenna tower was placed 3 meters far away from the turntable.
7. When the radiated emissions limits are expressed in terms of the average value of the emissions, and pulsed operation is employed, the measurement field strength shall be determined by averaging over one complete pulse train, including blanking intervals, as long as the pulse train does not exceed 0.1 seconds. As an alternative (provided the transmitter operates for longer than 0.1 seconds) or in cases where the pulse train exceeds 0.1 seconds, the measured field strength shall be determined from the average absolute voltage during a 0.1 second interval during which the field strength is at its maximum values.
8. If the emissions level of the EUT in peak mode was 3 dB lower than the average limit specified, then testing will be stopped and peak values of EUT will be reported, otherwise, the emissions which do not have 3 dB margin will be repeated one by one using the quasi-peak method for below 1GHz.
9. For testing above 1GHz, the emissions level of the EUT in peak mode was lower than average limit (that means the emissions level in peak mode also complies with the limit in average mode), then testing will be stopped and peak values of EUT will be reported, otherwise, the emissions will be measured in average mode again and reported.
10. In case the emission is lower than 30MHz, loop antenna has to be used for measurement and the recorded data should be QP measured by receiver. High - Low scan is not required in this case.

The following table is the setting of spectrum analyzer and receiver.

<b>Spectrum Parameter</b>	<b>Setting</b>
Start ~Stop Frequency	9KHz~150KHz/RB 200Hz for QP
Start ~Stop Frequency	150KHz~30MHz/RB 9KHz for QP
Start ~Stop Frequency	30MHz~1000MHz/RB 120KHz for QP
Start ~Stop Frequency	1GHz~26.5GHz 1MHz/1MHz for Peak, 1MHz/10Hz for Average

<b>Receiver Parameter</b>	<b>Setting</b>
Start ~Stop Frequency	9KHz~150KHz/RB 200Hz for QP
Start ~Stop Frequency	150KHz~30MHz/RB 9KHz for QP
Start ~Stop Frequency	30MHz~1000MHz/RB 120KHz for QP

10.2. TEST SETUP

RADIATED EMISSION TEST SETUP 30MHz-1000MHz

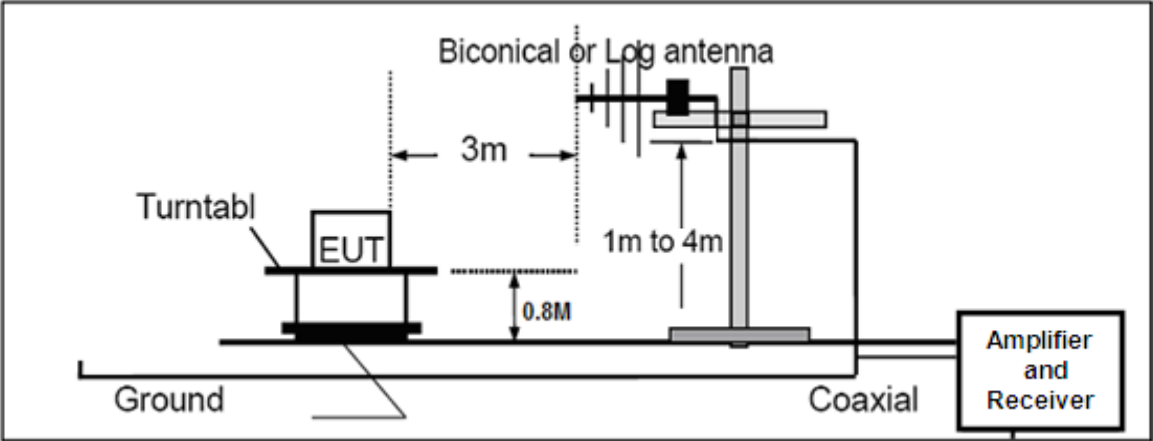

RADIATED EMISSION TEST SETUP ABOVE 1000MHz

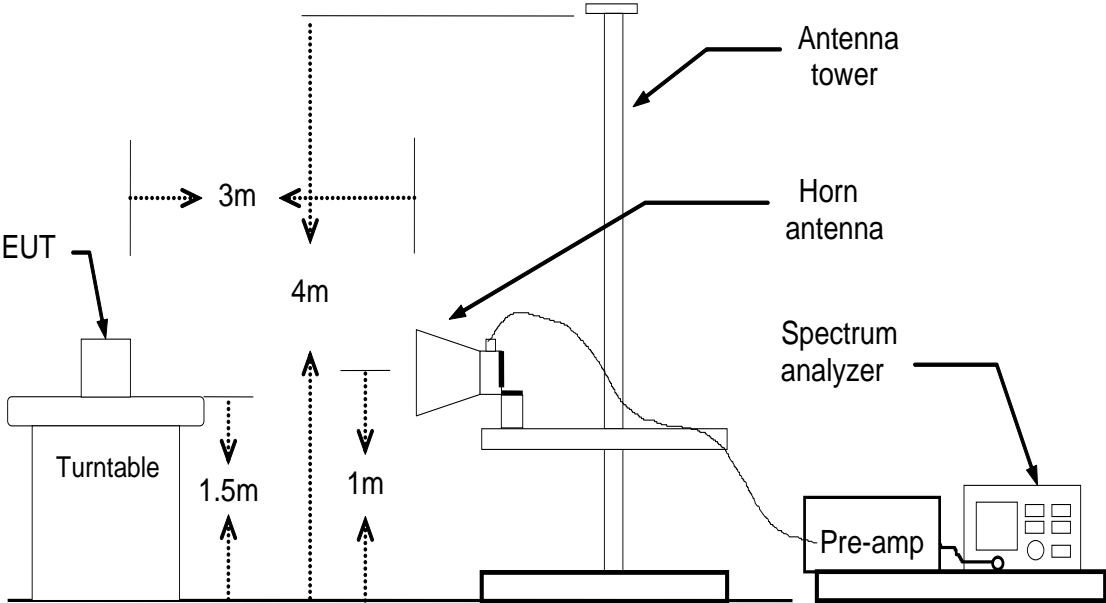

### 10.3. TEST RESULT

#### RADIATED EMISSION BELOW 30MHZ

No emission found between lowest internal used/generated frequencies to 30MHz.

#### RADIATED EMISSION BELOW 1GHZ

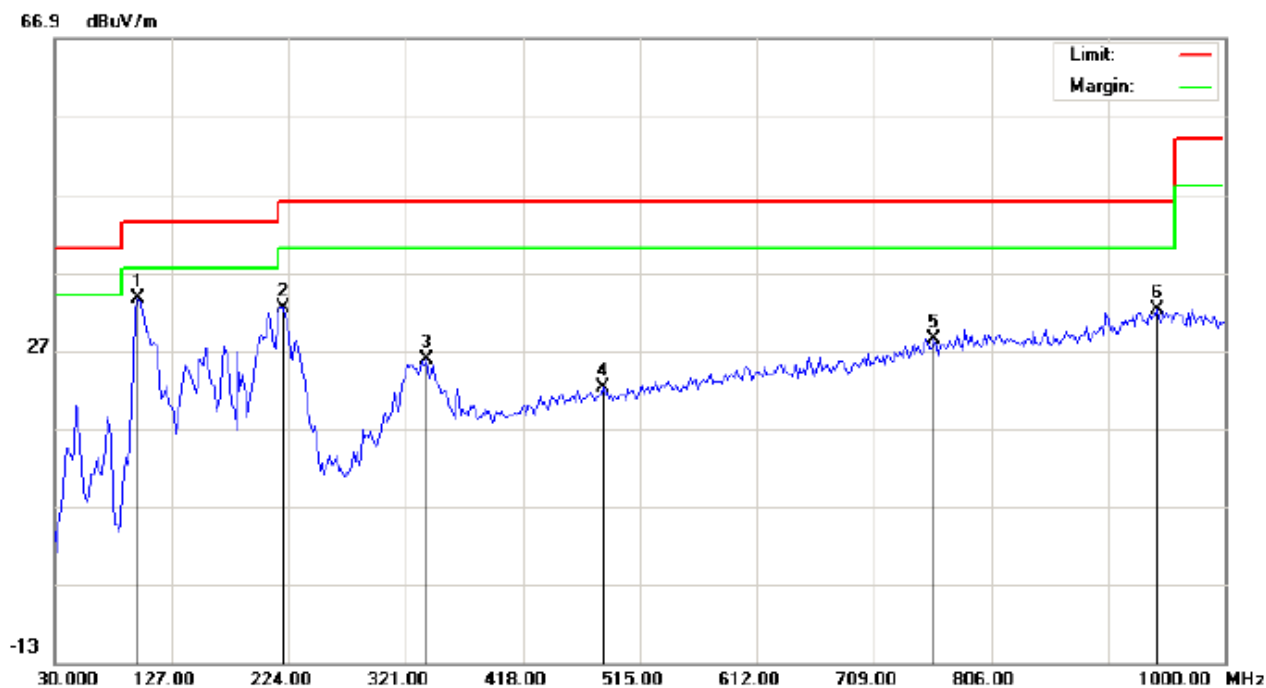

Site: site #1  
Limit: FCC Class B 3M Radiation  
EUT: MOBILE PHONE  
M/N: K4 GOLD  
Mode: Low Channel TX  
Note:

Polarization: *Horizontal*  
Power: AC 120V/60Hz  
Distance: 3m

Temperature: 23.1  
Humidity: 53.6 %

No.	Mk	Freq.	Reading	Factor	Measurement	Limit	Over	Detector	Antenna	Table	Comment
		MHz	dBuV	dB/m	dBuV/m	dBuV/m	dB		Height	Degree	
									cm	degree	
1	*	99.5167	23.69	10.00	33.69	43.50	-9.81	peak			
2		219.1500	22.41	10.05	32.46	46.00	-13.54	peak			
3		338.7833	7.74	17.99	25.73	46.00	-20.27	peak			
4		484.2833	1.26	20.96	22.22	46.00	-23.78	peak			
5		759.1167	1.65	26.76	28.41	46.00	-17.59	peak			
6		943.4167	2.31	29.82	32.13	46.00	-13.87	peak			

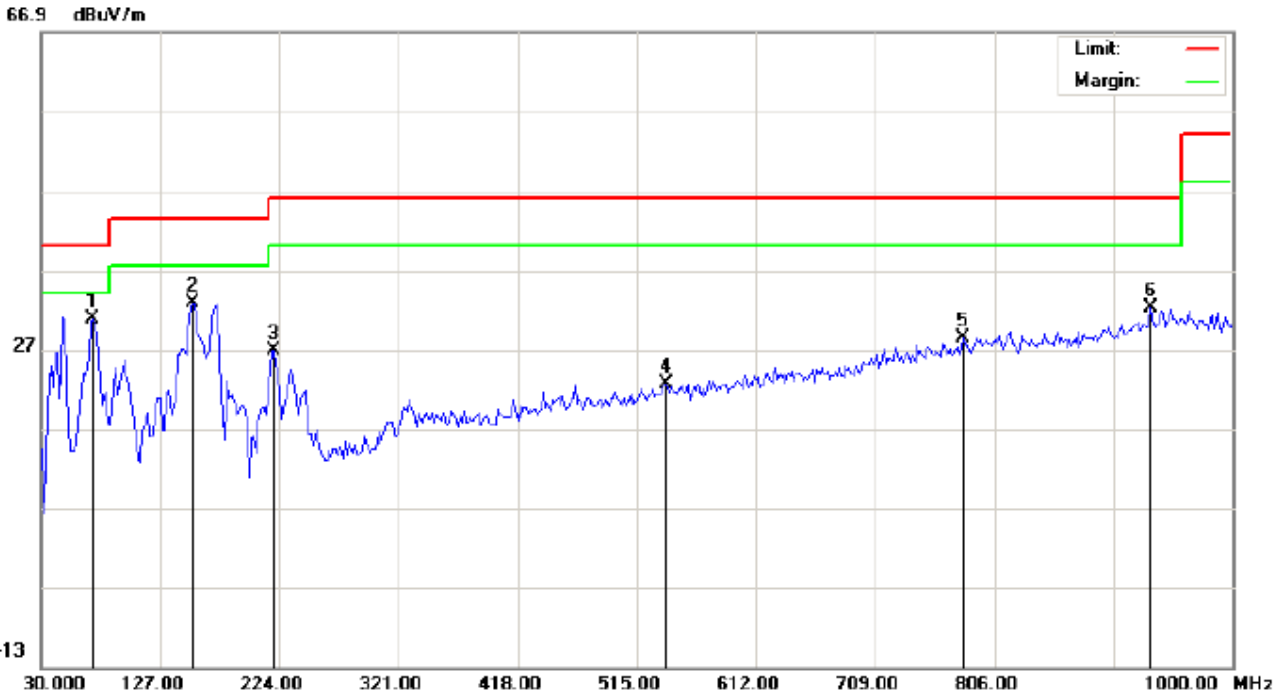

Site: site #1  
 Limit: FCC Class B 3M Radiation  
 EUT: MOBILE PHONE  
 M/N: K4 GOLD  
 Mode: Low Channel TX  
 Note:

Polarization: *Vertical*  
 Power: AC 120V/60Hz  
 Distance: 3m

Temperature: 23.1  
 Humidity: 53.6 %

No.	Mk	Freq.	Reading	Factor	Measurement	Limit	Over	Detector	Antenna Height	Table Degree	Comment
		MHz	dBuV	dB/m	dBuV/m	dBuV/m	dB		cm	degree	
1	*	72.0333	27.11	3.76	30.87	40.00	-9.13	peak			
2		152.8667	17.56	15.28	32.84	43.50	-10.66	peak			
3		219.1500	15.95	10.88	26.83	46.00	-19.17	peak			
4		539.2500	0.43	22.19	22.62	46.00	-23.38	peak			
5		780.1333	1.34	27.05	28.39	46.00	-17.61	peak			
6		933.7167	2.69	29.55	32.24	46.00	-13.76	peak			

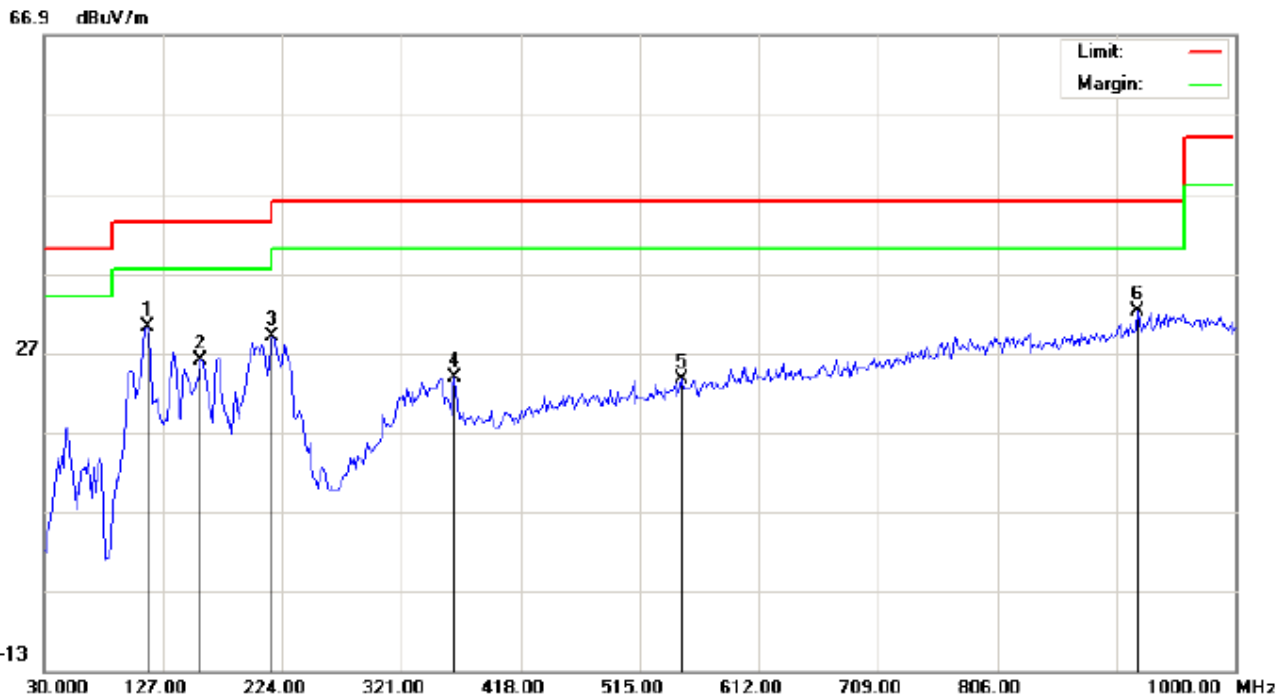

Site: site #1

Polarization: *Horizontal*

Temperature: 23.1

Limit: FCC Class B 3M Radiation

Power: AC 120V/60Hz

Humidity: 53.6 %

EUT: MOBILE PHONE

Distance: 3m

M/N: K4 GOLD

Mode: Middle Channel TX

Note:

No.	Mk	Freq.	Reading	Factor	Measurement	Limit	Over	Detector	Antenna Height	Table Degree	Comment
		MHz	dBuV	dB/m	dBuV/m	dBuV/m	dB		cm	degree	
1	*	114.0667	23.05	7.23	30.28	43.50	-13.22	peak			
2		157.7167	15.07	10.89	25.96	43.50	-17.54	peak			
3		215.9167	18.57	10.38	28.95	43.50	-14.55	peak			
4		364.6500	4.88	18.84	23.72	46.00	-22.28	peak			
5		548.9500	1.22	22.45	23.67	46.00	-22.33	peak			
6		920.7833	3.10	29.19	32.29	46.00	-13.71	peak			

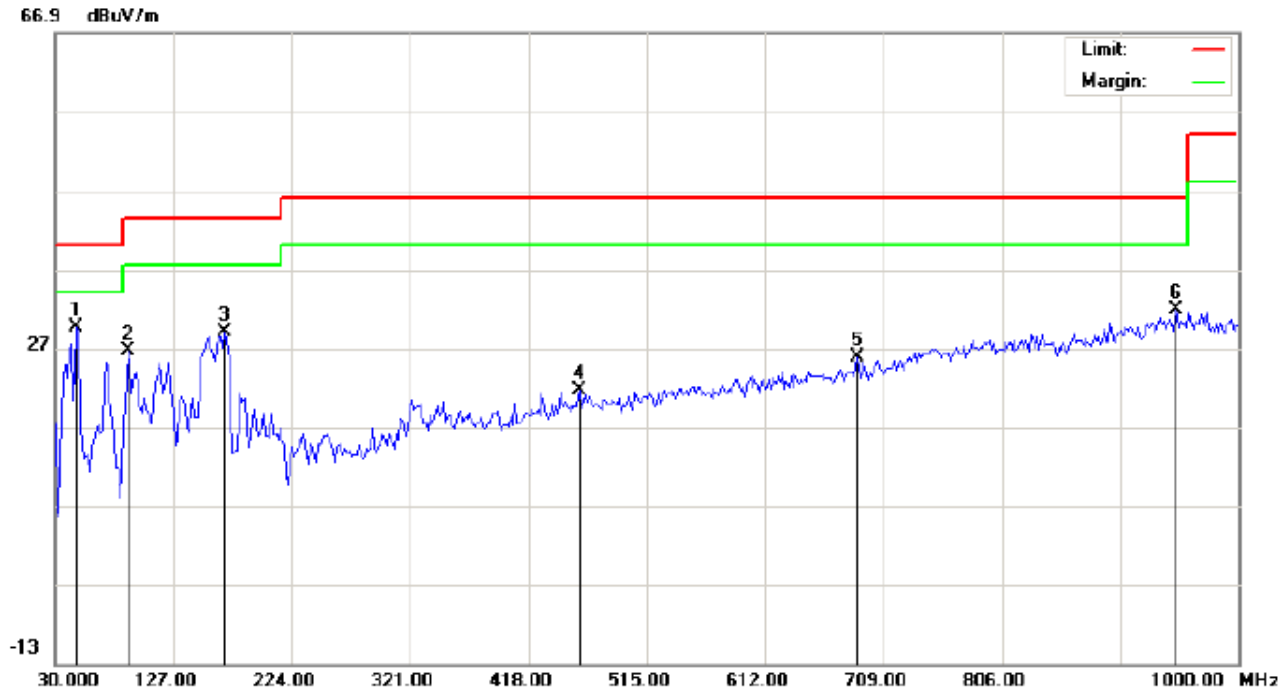

Site: site #1  
 Limit: FCC Class B 3M Radiation  
 EUT: MOBILE PHONE  
 M/N: K4 GOLD  
 Mode: Middle Channel TX  
 Note:

Polarization: *Vertical*  
 Power: AC 120V/60Hz  
 Distance: 3m

Temperature: 23.1  
 Humidity: 53.6 %

No.	Mk	Freq.	Reading	Factor	Measurement	Limit	Over	Detector	Antenna	Table	Comment
		MHz	dBuV	dB/m	dBuV/m	dBuV/m	dB		Height	Degree	
									cm	degree	
1	*	47.7833	21.26	8.39	29.65	40.00	-10.35	peak			
2		89.8167	21.26	5.31	26.57	43.50	-16.93	peak			
3		169.0333	14.31	14.76	29.07	43.50	-14.43	peak			
4		460.0333	0.93	20.70	21.63	46.00	-24.37	peak			
5		687.9833	0.92	24.87	25.79	46.00	-20.21	peak			
6		948.2667	1.78	29.95	31.73	46.00	-14.27	peak			

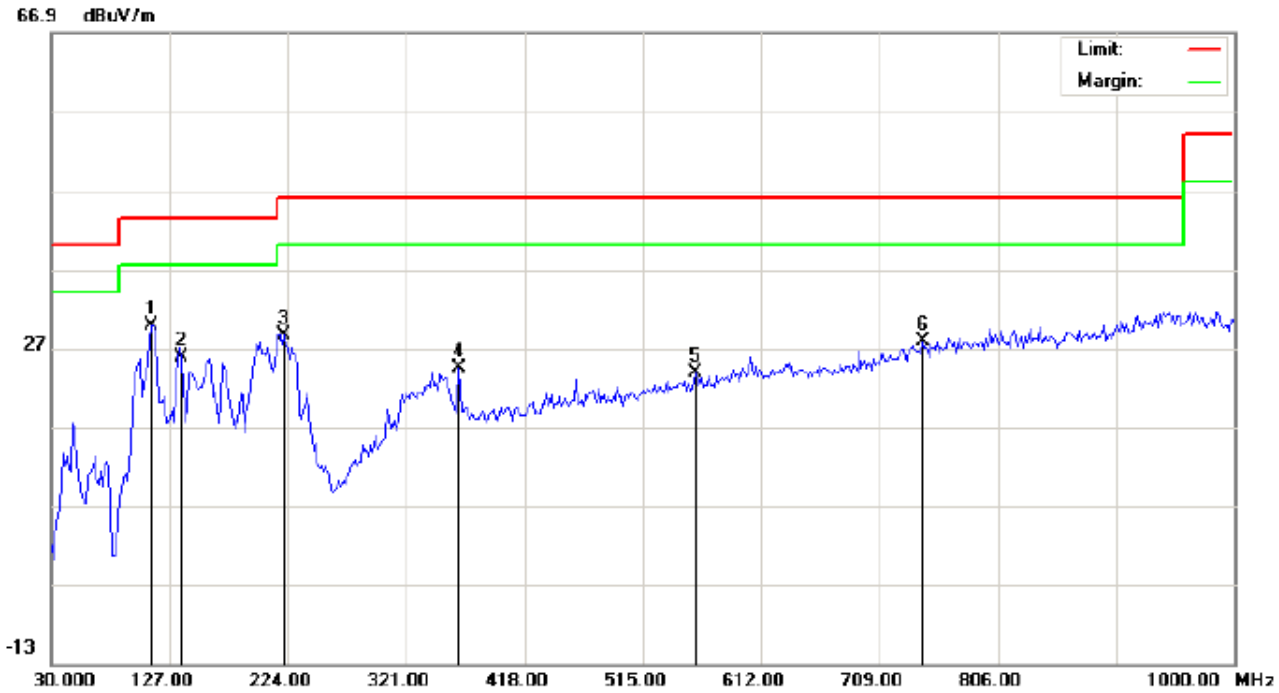

Site: site #1 Polarization: *Horizontal* Temperature: 23.1  
 Limit: FCC Class B 3M Radiation Power: AC 120V/60Hz Humidity: 53.6 %  
 EUT: MOBILE PHONE Distance: 3m  
 M/N: K4 GOLD  
 Mode: High Channel TX  
 Note:

No.	Mk	Freq.	Reading	Factor	Measurement	Limit	Over	Detector	Antenna Height	Table Degree	Comment
		MHz	dBuV	dB/m	dBuV/m	dBuV/m	dB		cm	degree	
1	*	112.4500	22.22	7.60	29.82	43.50	-13.68	peak			
2		136.7000	12.19	13.66	25.85	43.50	-17.65	peak			
3		220.7667	18.76	9.88	28.64	46.00	-17.36	peak			
4		364.6500	5.66	18.84	24.50	46.00	-21.50	peak			
5		558.6500	1.02	22.70	23.72	46.00	-22.28	peak			
6		744.5667	1.35	26.47	27.82	46.00	-18.18	peak			



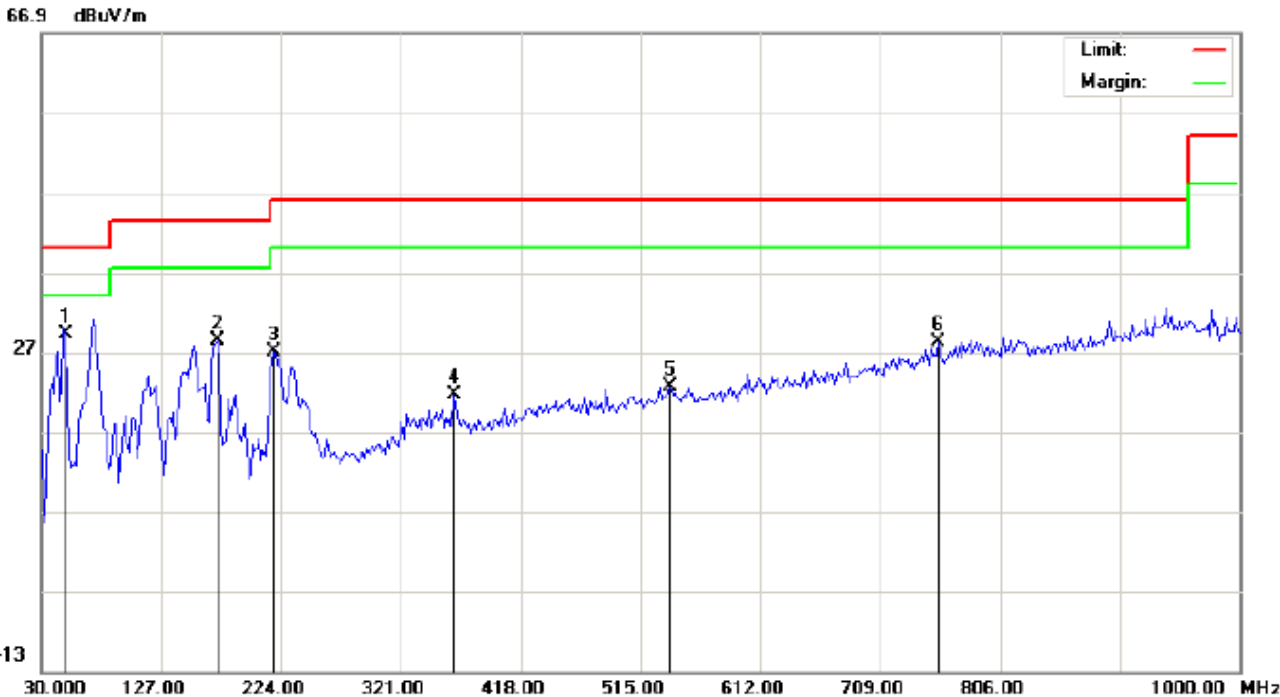

Site: site #1	Polarization: <i>Vertical</i>	Temperature: 23.1
Limit: FCC Class B 3M Radiation	Power: AC 120V/60Hz	Humidity: 53.6 %
EUT: MOBILE PHONE	Distance: 3m	
M/N: K4 GOLD		
Mode: High Channel TX		
Note:		

No.	Mk	Freq.	Reading	Factor	Measurement	Limit	Over	Detector	Antenna	Table	Comment
		MHz	dBuV	dB/m	dBuV/m	dBuV/m	dB		Height	Degree	
									cm	degree	
1	*	49.4000	20.88	8.28	29.16	40.00	-10.84	peak			
2		172.2667	13.77	14.56	28.33	43.50	-15.17	peak			
3		217.5333	16.23	10.72	26.95	46.00	-19.05	peak			
4		364.6500	2.74	18.84	21.58	46.00	-24.42	peak			
5		539.2500	0.48	22.19	22.67	46.00	-23.33	peak			
6		755.8833	1.44	26.71	28.15	46.00	-17.85	peak			

**RESULT: PASS**

**Note:** 1. Factor=Antenna Factor + Cable loss, Margin=Measurement-Limit.

2. The "Factor" value can be calculated automatically by software of measurement system.

RADIATED EMISSION TEST- (ABOVE 1GHZ)

Frequency	Meter Reading	Factor	Emission Level	Limits	Margin	Detector	Comment
(MHz)	(dB $\mu$ V)	(dB)	(dB $\mu$ V/m)	(dB $\mu$ V/m)	(dB)	Type	
Low Channel (2402 MHz)							
4804.264	66.34	-3.62	62.72	74	-11.28	Pk	Vertical
4804.272	46.21	-3.62	42.59	54	-11.41	AV	Vertical
7206.138	64.19	-0.9	63.29	74	-10.71	pk	Vertical
7206.156	43.43	-0.9	42.53	54	-11.47	AV	Vertical
4803.959	65.12	-3.64	61.48	74	-12.52	Pk	Horizontal
4803.964	45.56	-3.64	41.92	54	-12.08	AV	Horizontal
Mid Channel (2441 MHz)							
4882.128	65.57	-3.65	61.92	74	-12.08	Pk	Vertical
4882.094	47.23	-3.65	43.58	54	-10.42	AV	Vertical
7323.228	63.29	-0.82	62.47	74	-11.53	Pk	Vertical
7323.220	46.41	-0.82	45.59	54	-8.41	AV	Vertical
4882.096	63.67	-3.68	59.99	74	-14.01	Pk	Horizontal
4882.171	47.25	-3.68	43.57	54	-10.43	AV	Horizontal
High Channel (2480 MHz)							
4960.260	63.27	-3.59	59.68	74	-14.32	pk	Vertical
4960.325	45.53	-3.59	41.94	54	-12.06	AV	Vertical
4960.190	64.16	-3.59	60.57	74	-13.43	pk	Horizontal
4960.157	46.49	-3.59	42.9	54	-11.1	AV	Horizontal

Note:

1) 30MHz~25GHz:(Scan with GFSK,  $\pi/4$ -DQPSK,8DPSK, the worst casw is GFSK Mode)

2) Factor = Antenna Factor + Cable Loss – Pre-amplifier.

Emission Level = Meter Reading + Factor

Margin = Emission Leve - Limit

**RESULT: PASS**

## 11. BAND EDGE EMISSION

### 11.1. MEASUREMENT PROCEDURE

1. The transmitter output is connected to a spectrum analyzer. The resolution bandwidth is set to 100kHz. The video bandwidth is set to 300kHz.
2. Transmitter set to the normal hopping mode at 2.4 and 2.4835 GHz.

### 11.2. TEST SET-UP

Radiated same as 10.2

Conducted set up

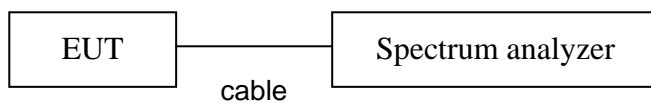

### 11.3. Radiated TEST RESULT

Frequency	Meter Reading	Factor	Emission Level	Limits	Margin	Detector	Comment
(MHz)	(dB $\mu$ V)	(dB)	(dB $\mu$ V/m)	(dB $\mu$ V/m)	(dB)	Type	
GFSK							
2399.9	68.28	-12.99	55.29	74	-18.71	peak	Vertical
2399.9	54.13	-12.99	41.14	54	-12.86	AVG	Vertical
2399.9	71.45	-12.99	58.46	74	-15.54	peak	Horizontal
2399.9	54.33	-12.99	41.34	54	-12.66	AVG	Horizontal
2483.6	71.12	-12.78	58.34	74	-15.66	peak	Vertical
2483.6	54.19	-12.78	41.41	54	-12.59	AVG	Vertical
2483.6	71.53	-12.78	58.75	74	-15.25	peak	Horizontal
2483.6	54.27	-12.78	41.49	54	-12.51	AVG	Horizontal
$\pi/4$ -DQPSK							
2399.9	71.43	-12.99	58.44	74	-15.56	peak	Vertical
2399.9	54.16	-12.99	41.17	54	-12.83	AVG	Vertical
2399.9	70.28	-12.99	57.29	74	-16.71	peak	Horizontal
2399.9	55.41	-12.99	42.42	54	-11.58	AVG	Horizontal
2483.6	71.39	-12.78	58.61	74	-15.39	peak	Vertical
2483.6	58.18	-12.78	45.4	54	-8.6	AVG	Vertical
2483.6	71.52	-12.78	58.74	74	-15.26	peak	Horizontal
2483.6	54.71	-12.78	41.93	54	-12.07	AVG	Horizontal
8DPSK							
2399.9	71.53	-12.99	58.54	74	-15.46	peak	Vertical
2399.9	55.42	-12.99	42.43	54	-11.57	AVG	Vertical
2399.9	70.69	-12.99	57.7	74	-16.3	peak	Horizontal
2399.9	56.72	-12.99	43.73	54	-10.27	AVG	Horizontal
2483.6	71.22	-12.78	58.44	74	-15.56	peak	Vertical
2483.6	55.49	-12.78	42.71	54	-11.29	AVG	Vertical
2483.6	71.18	-12.78	58.4	74	-15.6	peak	Horizontal
2483.6	54.26	-12.78	41.48	54	-12.52	AVG	Horizontal

### RESULT: PASS

**Note:** The other modes radiation emission have enough 20dB margin.

Factor=Antenna Factor + Cable loss - Amplifier gain, Over=Measure-Limit.

The "Factor" value can be calculated automatically by software of measurement system.

**11.4 Conducted TEST RESULT**

Mode	Channel	Carrier Frequency [MHz]	Frequency Hopping	Max Spurious Level [dBm]	Verdict
GFSK	LCH	2402	Off	-58.803	PASS
			On	-58.113	PASS
GFSK	HCH	2480	Off	-59.699	PASS
			On	-58.34	PASS
$\pi/4$ DQPSK	LCH	2402	Off	-56.098	PASS
$\pi/4$ DQPSK	HCH	2480	Off	-59.885	PASS
8DPSK	LCH	2402	Off	-56.902	PASS
8DPSK	HCH	2480	Off	-59.555	PASS

Note: All modes were tested, only the worst case record in the report.

Test Graph

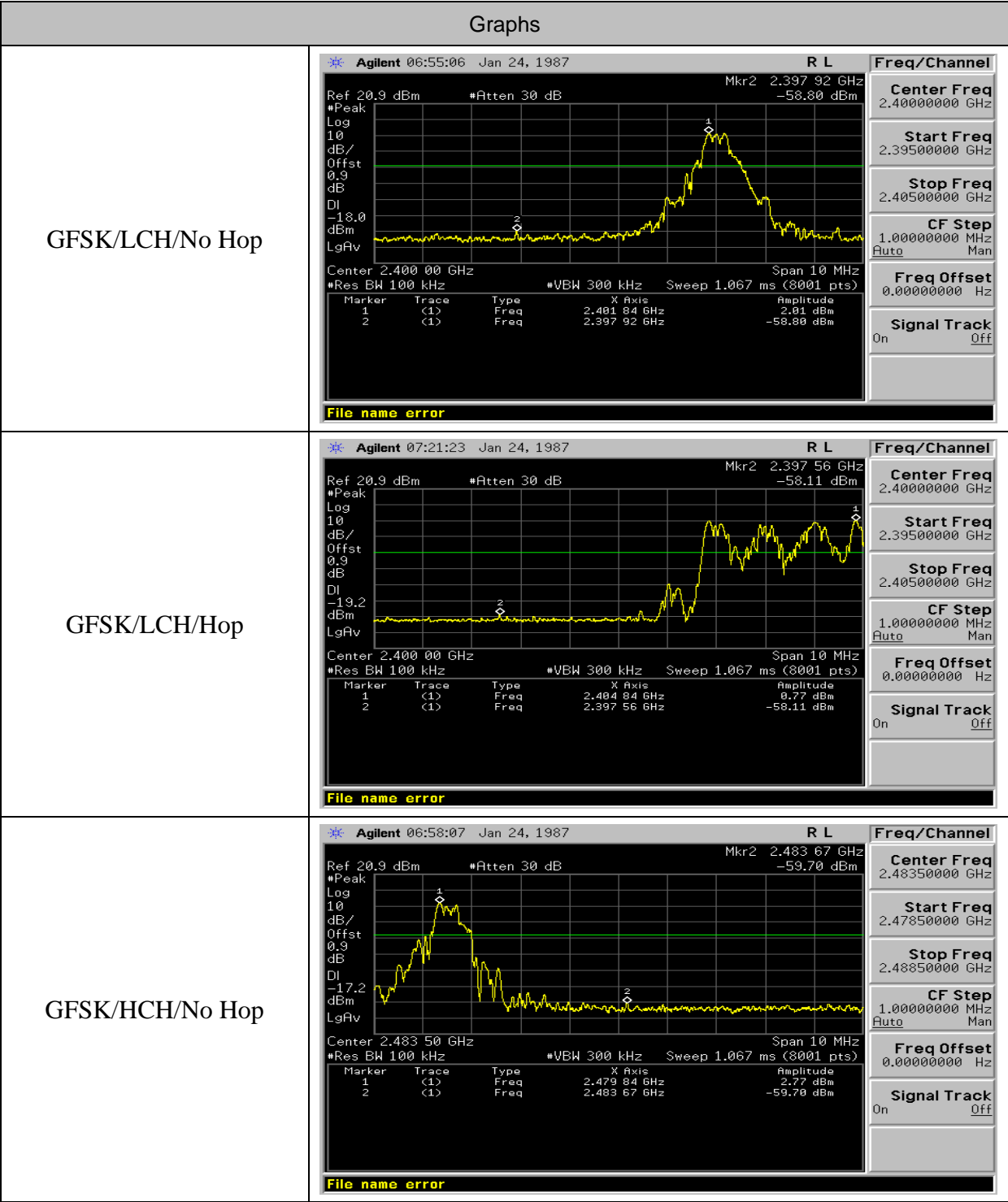

<p>GFSK/HCH/Hop</p>	<p>Agilent 07:23:09 Jan 24, 1987 R L</p> <p>Ref 20.9 dBm #Atten 30 dB Mkr2 2.484 07 GHz -58.34 dBm</p> <p>Center 2.483 50 GHz Span 10 MHz</p> <table border="1"> <thead> <tr> <th>Marker</th> <th>Trace</th> <th>Type</th> <th>X Axis</th> <th>Amplitude</th> </tr> </thead> <tbody> <tr> <td>1</td> <td>(1)</td> <td>Freq</td> <td>2.479 84 6Hz</td> <td>-0.18 dBm</td> </tr> <tr> <td>2</td> <td>(1)</td> <td>Freq</td> <td>2.484 07 6Hz</td> <td>-58.34 dBm</td> </tr> </tbody> </table> <p>File name error</p>	Marker	Trace	Type	X Axis	Amplitude	1	(1)	Freq	2.479 84 6Hz	-0.18 dBm	2	(1)	Freq	2.484 07 6Hz	-58.34 dBm
Marker	Trace	Type	X Axis	Amplitude												
1	(1)	Freq	2.479 84 6Hz	-0.18 dBm												
2	(1)	Freq	2.484 07 6Hz	-58.34 dBm												
<p><math>\pi/4</math>DQPSK/LCH/No Hop</p>	<p>Agilent 07:09:31 Jan 24, 1987 R L</p> <p>Ref 20.9 dBm #Atten 30 dB Mkr2 2.399 65 GHz -56.10 dBm</p> <p>Center 2.400 00 GHz Span 10 MHz</p> <table border="1"> <thead> <tr> <th>Marker</th> <th>Trace</th> <th>Type</th> <th>X Axis</th> <th>Amplitude</th> </tr> </thead> <tbody> <tr> <td>1</td> <td>(1)</td> <td>Freq</td> <td>2.401 85 6Hz</td> <td>-9.08 dBm</td> </tr> <tr> <td>2</td> <td>(1)</td> <td>Freq</td> <td>2.399 65 6Hz</td> <td>-56.10 dBm</td> </tr> </tbody> </table> <p>File name error</p>	Marker	Trace	Type	X Axis	Amplitude	1	(1)	Freq	2.401 85 6Hz	-9.08 dBm	2	(1)	Freq	2.399 65 6Hz	-56.10 dBm
Marker	Trace	Type	X Axis	Amplitude												
1	(1)	Freq	2.401 85 6Hz	-9.08 dBm												
2	(1)	Freq	2.399 65 6Hz	-56.10 dBm												
<p><math>\pi/4</math>DQPSK/HCH/No Hop</p>	<p>Agilent 07:12:00 Jan 24, 1987 R L</p> <p>Ref 20.9 dBm #Atten 30 dB Mkr2 2.487 51 GHz -59.88 dBm</p> <p>Center 2.483 50 GHz Span 10 MHz</p> <table border="1"> <thead> <tr> <th>Marker</th> <th>Trace</th> <th>Type</th> <th>X Axis</th> <th>Amplitude</th> </tr> </thead> <tbody> <tr> <td>1</td> <td>(1)</td> <td>Freq</td> <td>2.479 85 6Hz</td> <td>-0.18 dBm</td> </tr> <tr> <td>2</td> <td>(1)</td> <td>Freq</td> <td>2.487 51 6Hz</td> <td>-59.88 dBm</td> </tr> </tbody> </table> <p>File name error</p>	Marker	Trace	Type	X Axis	Amplitude	1	(1)	Freq	2.479 85 6Hz	-0.18 dBm	2	(1)	Freq	2.487 51 6Hz	-59.88 dBm
Marker	Trace	Type	X Axis	Amplitude												
1	(1)	Freq	2.479 85 6Hz	-0.18 dBm												
2	(1)	Freq	2.487 51 6Hz	-59.88 dBm												

8DPSK/LCH/No Hop

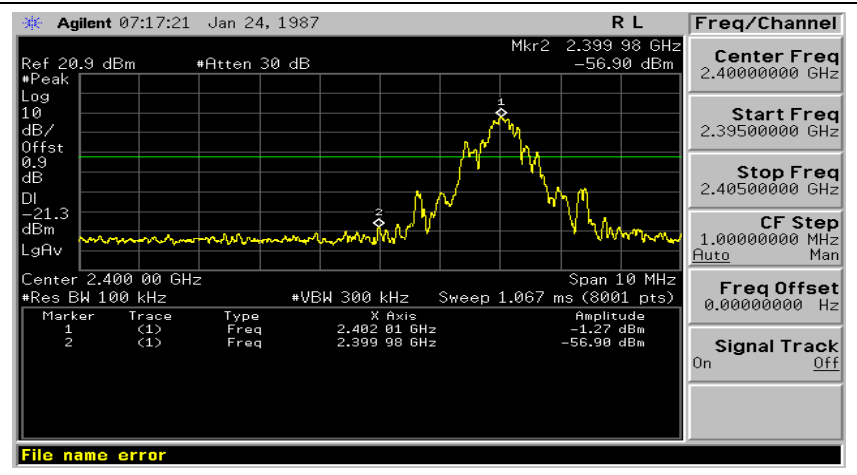

8DPSK/HCH/No Hop

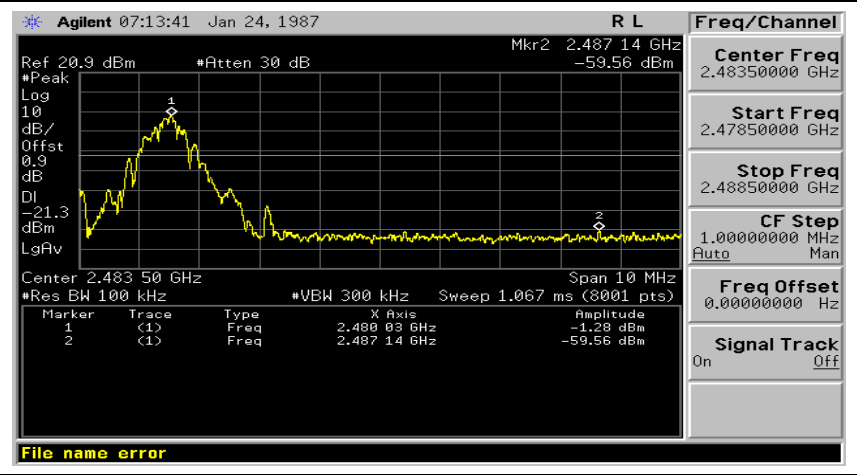



**12. NUMBER OF HOPPING FREQUENCY**

**12.1. MEASUREMENT PROCEDURE**

1. Place the EUT on the table and set it in transmitting mode.
2. Remove the antenna from the EUT and then connect a low RF cable from the antenna port to the spectrum analyzer.
3. Set the spectrum analyzer Start = 2.4GHz Stop = 2.4835GHz
4. Set the Spectrum Analyzer as RBW>=1%span, VBW>=RBW.

**12.2. TEST SETUP (BLOCK DIAGRAM OF CONFIGURATION)**

Same as described in section 8.2

**12.3. MEASUREMENT EQUIPMENT USED**

The same as described in section 6

**12.4. LIMITS AND MEASUREMENT RESULT**

Mode	Channel.	Number of Hopping Channel	Verdict
GFSK	Hop	79	PASS

Note: All modes were tested, only the worst case record in the report.

**Test Graph**

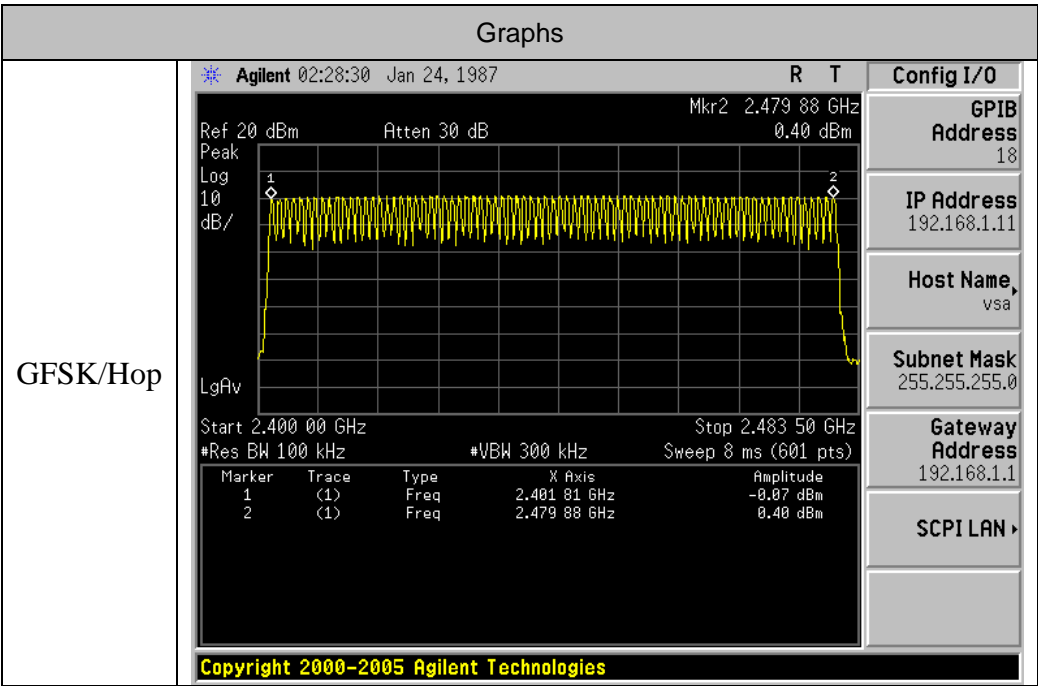

### 13. TIME OF OCCUPANCY (DWELL TIME)

#### 13.1. MEASUREMENT PROCEDURE

1. Place the EUT on the table and set it in transmitting mode
2. Remove the antenna from the EUT and then connect a low RF cable from the antenna port to the spectrum analyzer.
3. Set Span = zero span, centered on a hopping channel
4. Set the spectrum analyzer as RBW=1MHz, VBW>=RBW, Span = 0 Hz

#### 13.2. TEST SETUP (BLOCK DIAGRAM OF CONFIGURATION)

Same as described in section 8.2

#### 13.3. MEASUREMENT EQUIPMENT USED

The same as described in section 6

#### 13.4. LIMITS AND MEASUREMENT RESULT

The Dwell Time=Burst Width\*Total Hops. The detailed calculations are showed as follows:

- The duration for dwell time calculation:  $0.4[s] * \text{hopping number} = 0.4[s] * 79[\text{ch}] = 31.6[s * \text{ch}]$ ;
- The burst width [ms/hop/ch], which is directly measured, refers to the duration on one channel hop.
- The hops per second for all channels: The selected EUT Conf uses a slot type of 5-Tx&1-Rx and a hopping rate of 1600 [ch\*hop/s] for all channels. So the final hopping rate for all channels is  $1600/6 = 266.67 [\text{ch} * \text{hop}/s]$
- The hops per second on one channel:  $266.67 [\text{ch} * \text{hops}/s] / 79 [\text{ch}] = 3.38 [\text{hop}/s]$ ;
- The total hops for all channels within the dwell time calculation duration:  $3.38 [\text{hop}/s] * 31.6[s * \text{ch}] = 106.67 [\text{hop} * \text{ch}]$ ;
- The dwell time for all channels hopping:  $106.67 [\text{hop} * \text{ch}] * \text{Burst Width} [\text{ms}/\text{hop}/\text{ch}]$ .

Mode	Channel.	Burst Width [ms/hop/ch]	Total Hops[hop*ch]	Dwell Time[ms]	Verdict	Limit (ms)
GFSK	LCH	2.871	106.67	306.25	PASS	400
GFSK	MCH	2.931	106.67	312.65	PASS	400
GFSK	HCH	2.870	106.67	306.14	PASS	400

Test Graph

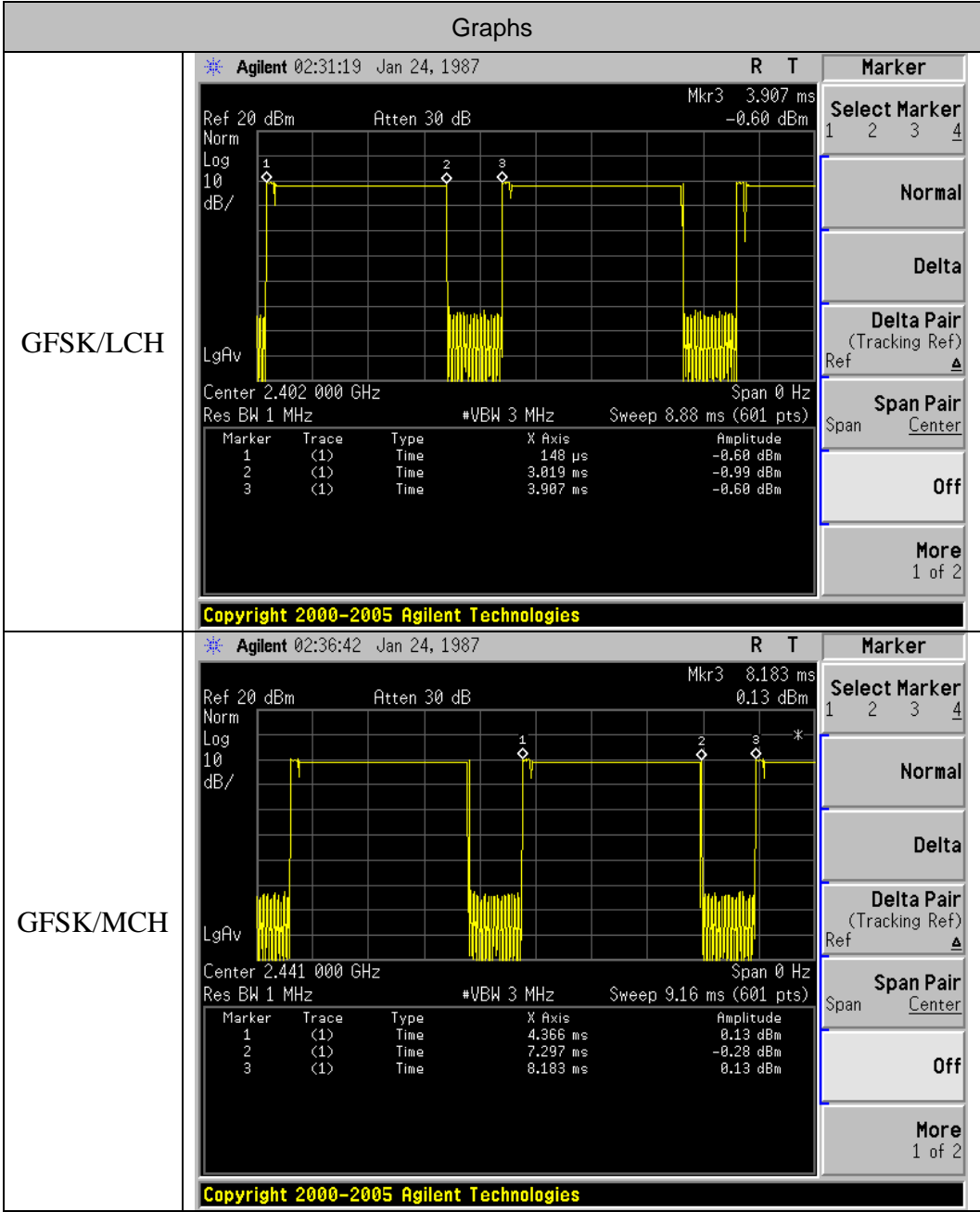

GFSK/HCH

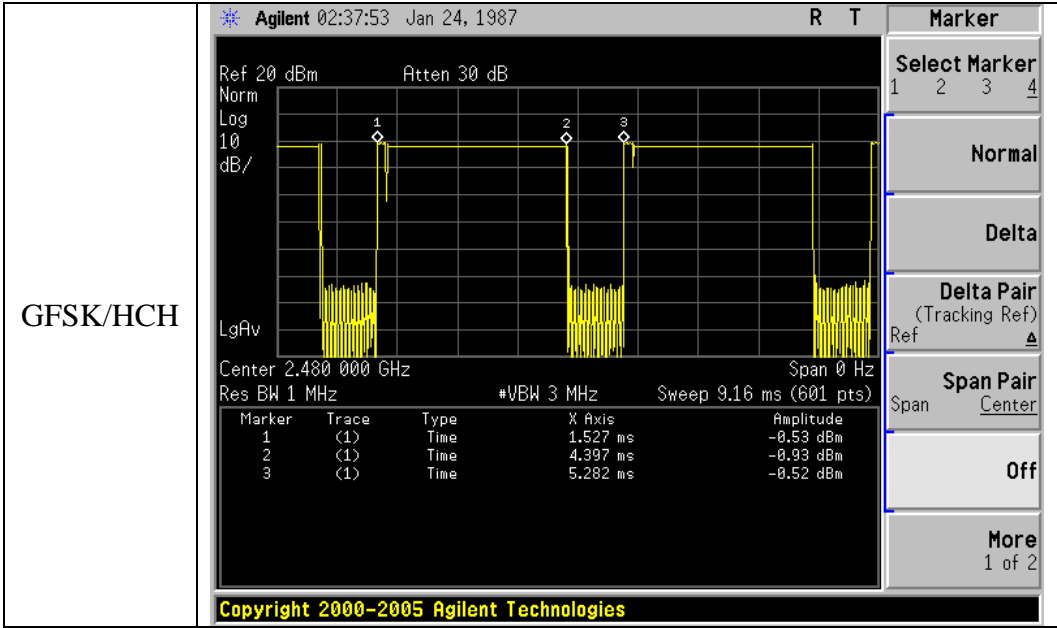

**14. FREQUENCY SEPARATION**

**14.1. MEASUREMENT PROCEDURE**

1. Place the EUT on the table and set it in transmitting mode
2. Remove the antenna from the EUT and then connect a low RF cable from the antenna port to the spectrum analyzer
3. Set Span = wide enough to capture the peaks of two adjacent channels Resolution (or IF) Bandwidth (RBW)  $\geq$  1% of the span Video (or Average) Bandwidth (VBW)  $\geq$  RBW; Sweep = auto; Detector function = peak; Trace = max hold

**14.2. TEST SETUP (BLOCK DIAGRAM OF CONFIGURATION)**

Same as described in section 6.2

**14.3. MEASUREMENT EQUIPMENT USED**

The same as described in section 6.3

**14.4. LIMITS AND MEASUREMENT RESULT**

Mode	Channel.	Carrier Frequency Separation [MHz]	Verdict
8DPSK	Hop	1.011	PASS

Note: All modes were tested, only the worst case record in the report.

**Test Graph**

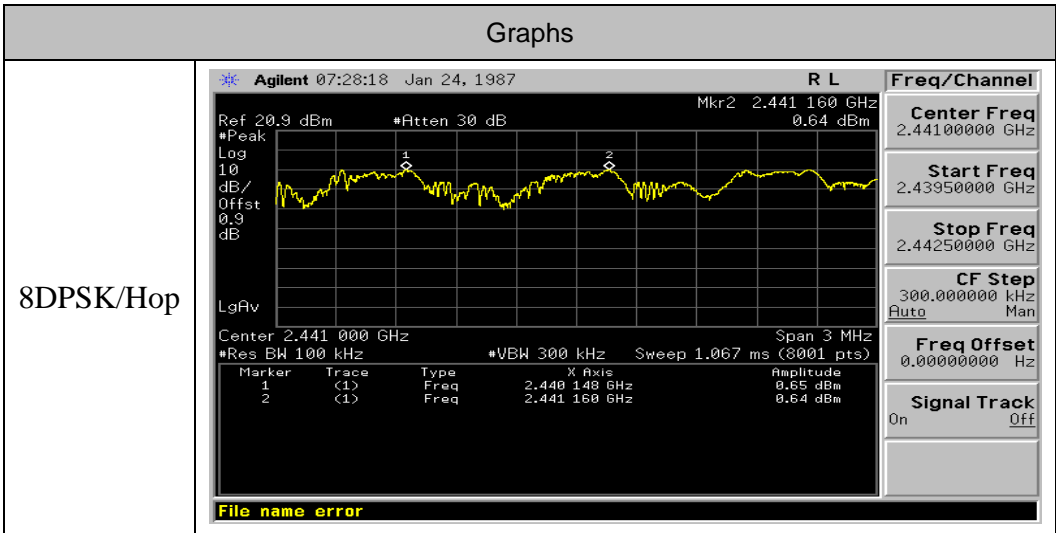

**15. FCC LINE CONDUCTED EMISSION TEST**

**15.1. LIMITS OF LINE CONDUCTED EMISSION TEST**

Frequency	Maximum RF Line Voltage	
	Q.P.( dBuV)	Average( dBuV)
150kHz~500kHz	66-56	56-46
500kHz~5MHz	56	46
5MHz~30MHz	60	50

Note:

1. The lower limit shall apply at the transition frequency.
2. The limit decreases linearly with the logarithm of the frequency in the range 0.15 MHz to 0.50 MHz.

**15.2. BLOCK DIAGRAM OF LINE CONDUCTED EMISSION TEST**

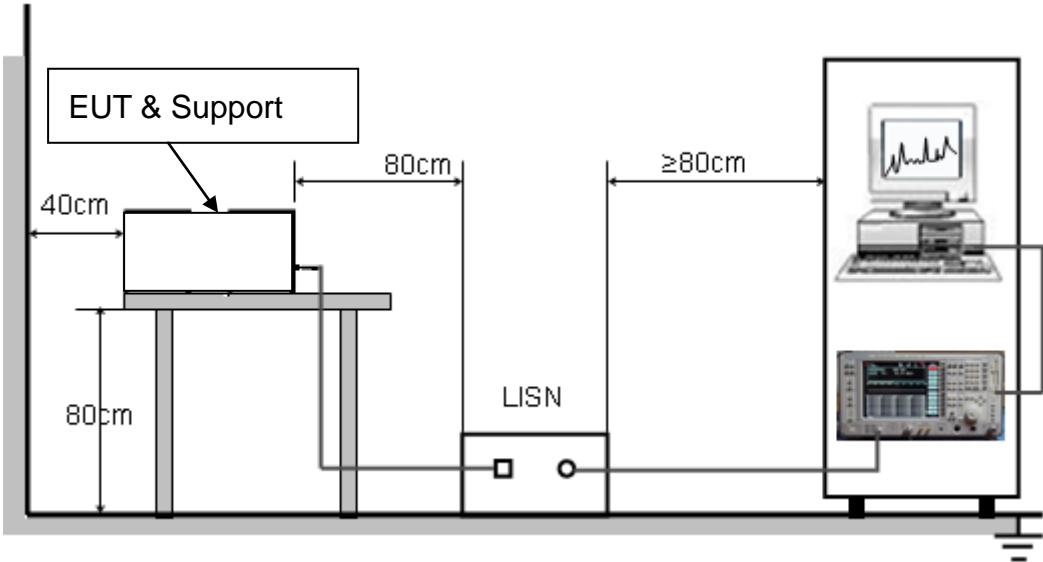

### **15.3. PRELIMINARY PROCEDURE OF LINE CONDUCTED EMISSION TEST**

1. The equipment was set up as per the test configuration to simulate typical actual usage per the user's manual. When the EUT is a tabletop system, a wooden table with a height of 0.8 meters is used and is placed on the ground plane as per ANSI C63.10 (see Test Facility for the dimensions of the ground plane used). When the EUT is a floor-standing equipment, it is placed on the ground plane which has a 3-12 mm non-conductive covering to insulate the EUT from the ground plane.
2. Support equipment, if needed, was placed as per ANSI C63.10.
3. All I/O cables were positioned to simulate typical actual usage as per ANSI C63.10.
4. All support equipments received AC120V/60Hz power from a LISN, if any.
5. The EUT received DC charging voltage by adapter which received 120V/60Hz power by a LISN..
6. The test program was started. Emissions were measured on each current carrying line of the EUT using a spectrum Analyzer / Receiver connected to the LISN powering the EUT. The LISN has two monitoring points: Line 1 (Hot Side) and Line 2 (Neutral Side). Two scans were taken: one with Line 1 connected to Analyzer / Receiver and Line 2 connected to a 50 ohm load; the second scan had Line 1 connected to a 50 ohm load and Line 2 connected to the Analyzer / Receiver.
7. Analyzer / Receiver scanned from 150 kHz to 30MHz for emissions in each of the test modes.
8. During the above scans, the emissions were maximized by cable manipulation.
9. The test mode(s) were scanned during the preliminary test.

Then, the EUT configuration and cable configuration of the above highest emission level were recorded for reference of final testing.

### **15.4. FINAL PROCEDURE OF LINE CONDUCTED EMISSION TEST**

1. EUT and support equipment was set up on the test bench as per step 2 of the preliminary test.
2. A scan was taken on both power lines, Line 1 and Line 2, recording at least the six highest emissions. Emission frequency and amplitude were recorded into a computer in which correction factors were used to calculate the emission level and compare reading to the applicable limit. If EUT emission level was less -2dB to the A.V. limit in Peak mode, then the emission signal was re-checked using Q.P and Average detector.
3. The test data of the worst case condition(s) was reported on the Summary Data page.

15.5. TEST RESULT OF LINE CONDUCTED EMISSION TEST

Line Conducted Emission Test Line 1-L

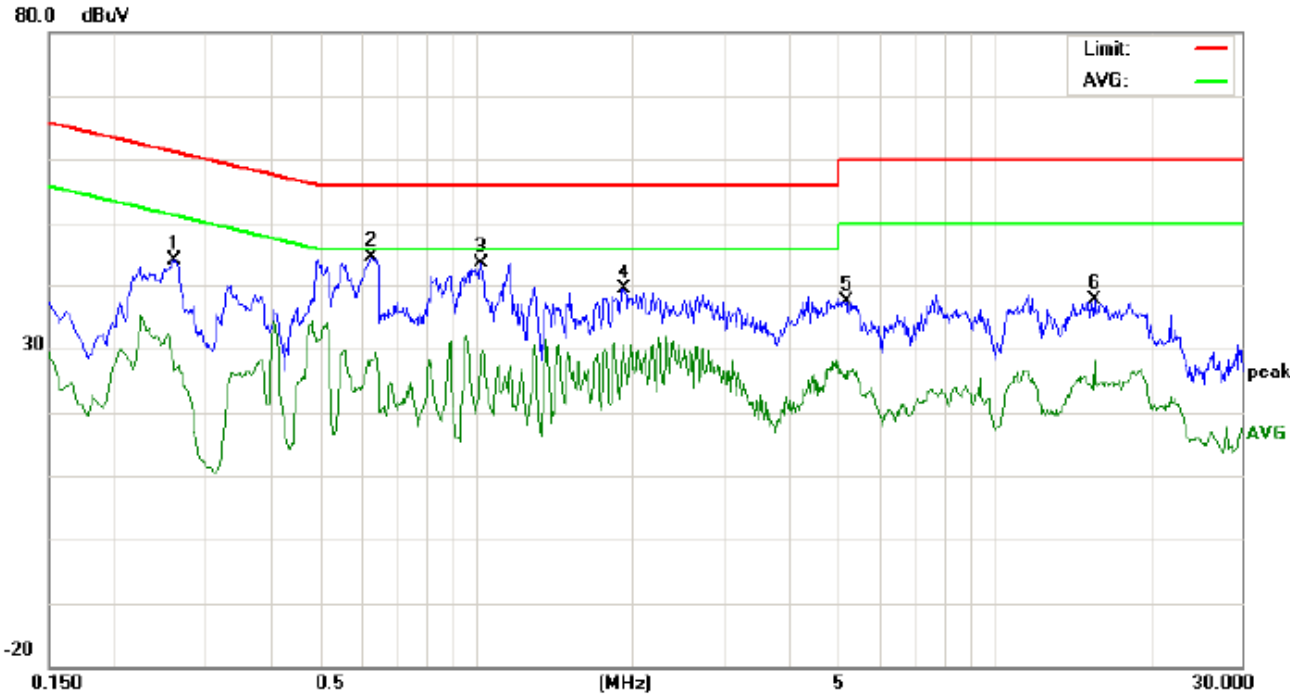

Site: Conduction Phase: **L1** Temperature: 26  
 Limit: FCC Class B Conduction(QP) Power: AC 120V/60Hz Humidity: 60 %  
 EUT: MOBILE PHONE  
 M/N: K4 GOLD  
 Mode: Normal operation(BT3.0)  
 Note:

No.	Freq. (MHz)	Reading_Level (dBuV)			Correct Factor (dB)	Measurement (dBuV)			Limit (dBuV)		Margin (dB)		P/F	Comment
		Peak	QP	AVG		Peak	QP	AVG	QP	AVG	QP	AVG		
1	0.2600	33.90		17.55	10.27	44.17		27.82	61.43	51.43	-17.26	-23.61	P	
2	0.6300	34.36		18.13	10.32	44.68		28.45	56.00	46.00	-11.32	-17.55	P	
3	1.0260	33.38		18.27	10.37	43.75		28.64	56.00	46.00	-12.25	-17.36	P	
4	1.9418	27.23		19.15	10.24	37.47		29.39	56.00	46.00	-18.53	-16.61	P	
5	5.1779	27.26		16.30	10.24	37.50		26.54	60.00	50.00	-22.50	-23.46	P	
6	15.6097	27.59		18.12	10.11	37.70		28.23	60.00	50.00	-22.30	-21.77	P	



Line Conducted Emission Test Line 2-N

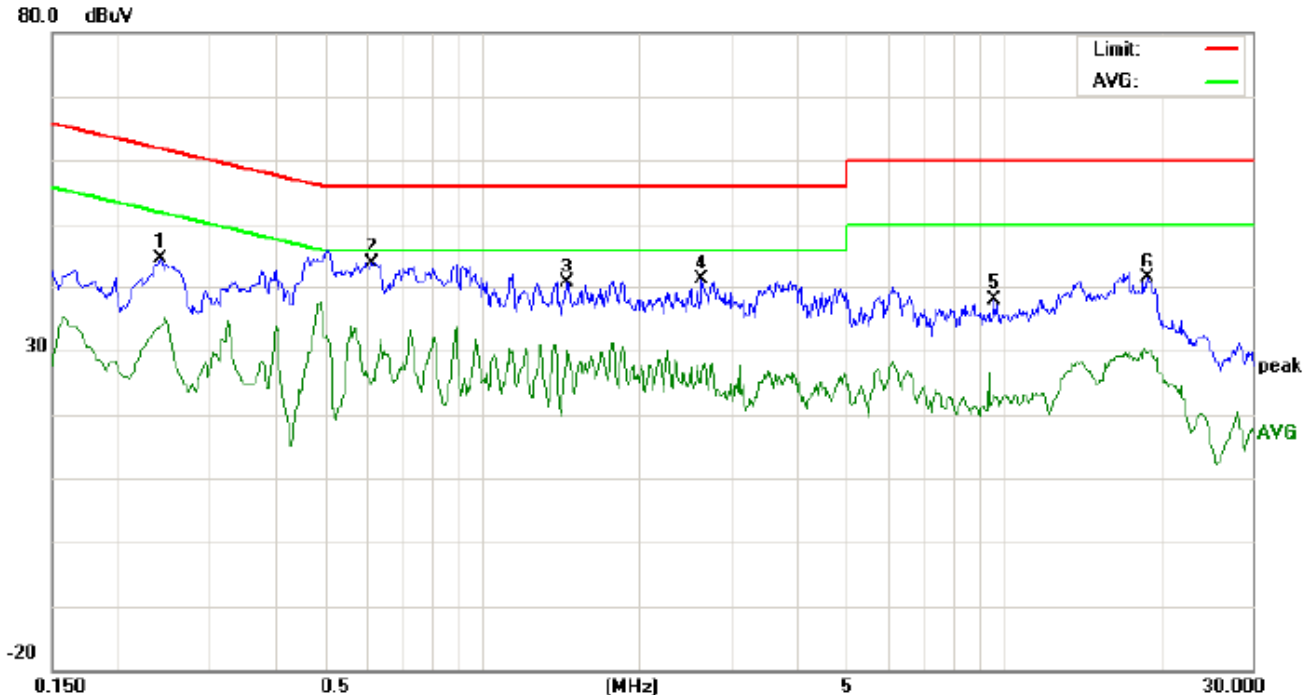

Site: Conduction Phase: **N** Temperature: 26  
 Limit: FCC Class B Conduction(QP) Power: AC 120V/60Hz Humidity: 60 %  
 EUT: MOBILE PHONE  
 M/N: K4 GOLD  
 Mode: Normal operation(BT3.0)  
 Note:

No.	Freq. (MHz)	Reading_Level (dBuV)			Correct Factor (dB)	Measurement (dBuV)			Limit (dBuV)		Margin (dB)		P/F	Comment
		Peak	QP	AVG		Peak	QP	AVG	QP	AVG	QP	AVG		
1	0.2419	34.35		23.54	10.26	44.61		33.80	62.03	52.03	-17.42	-18.23	P	
2	0.6139	33.58		14.57	10.32	43.90		24.89	56.00	46.00	-12.10	-21.11	P	
3	1.4618	30.25		19.73	10.38	40.63		30.11	56.00	46.00	-15.37	-15.89	P	
4	2.6419	30.68		16.16	10.46	41.14		26.62	56.00	46.00	-14.86	-19.38	P	
5	9.5817	27.54		12.75	10.33	37.87		23.08	60.00	50.00	-22.13	-26.92	P	
6	18.8899	31.19		19.54	10.12	41.31		29.66	60.00	50.00	-18.69	-20.34	P	

**APPENDIX A: PHOTOGRAPHS OF TEST SETUP**  
FCC LINE CONDUCTED EMISSION TEST SETUP



FCC RADIATED EMISSION TEST SETUP

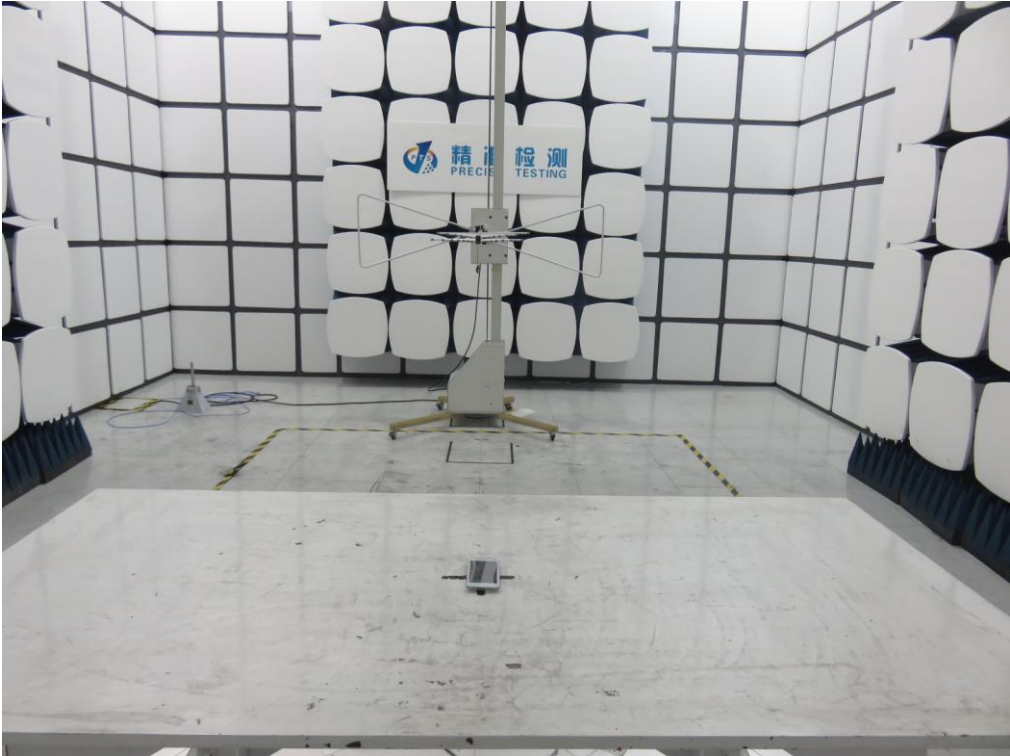

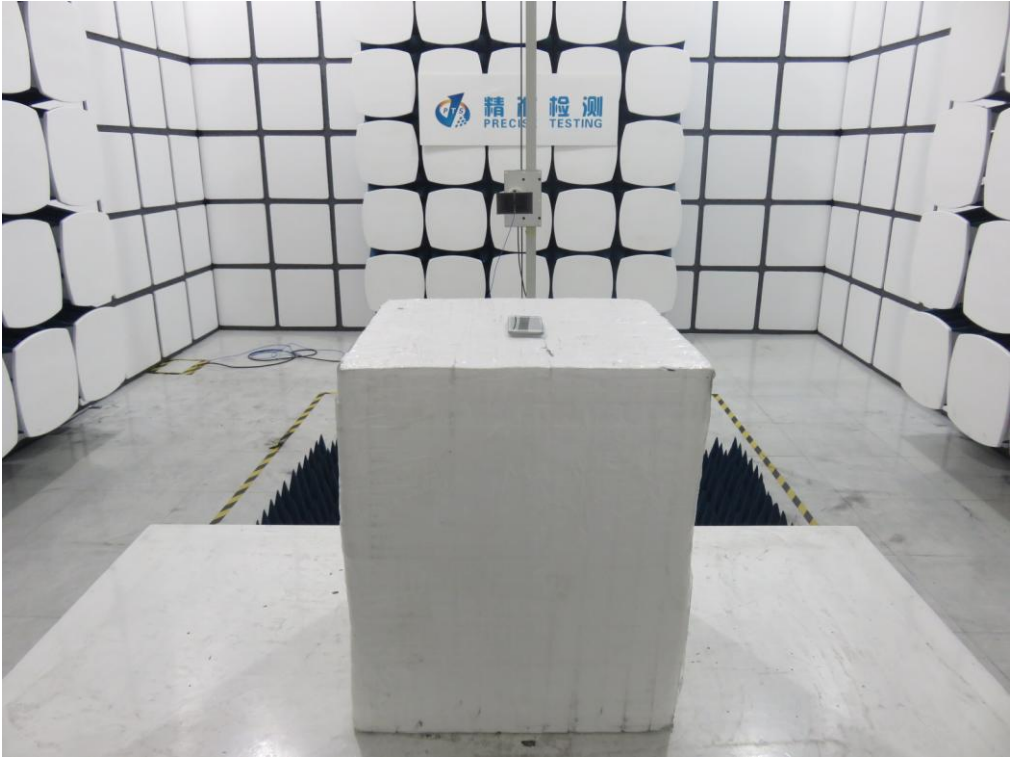

**APPENDIX B: PHOTOGRAPHS OF EUT**  
TOTAL VIEW OF EUT



THE LABEL OF ADAPTER





THE LABEL OF BATTERY



TOP VIEW OF EUT



BOTTOM VIEW OF EUT



FRONT VIEW OF EUT





BACK VIEW OF EUT



LEFT VIEW OF EUT



RIGHT VIEW OF EUT

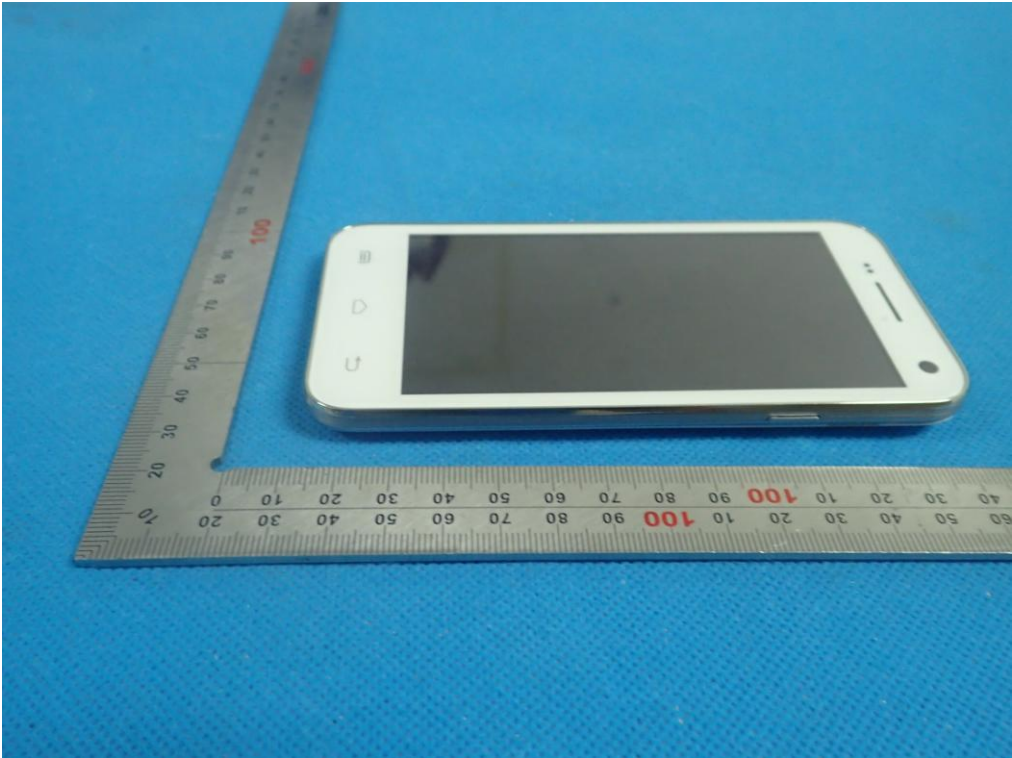

OPEN VIEW OF EUT-1





OPEN VIEW OF EUT-2

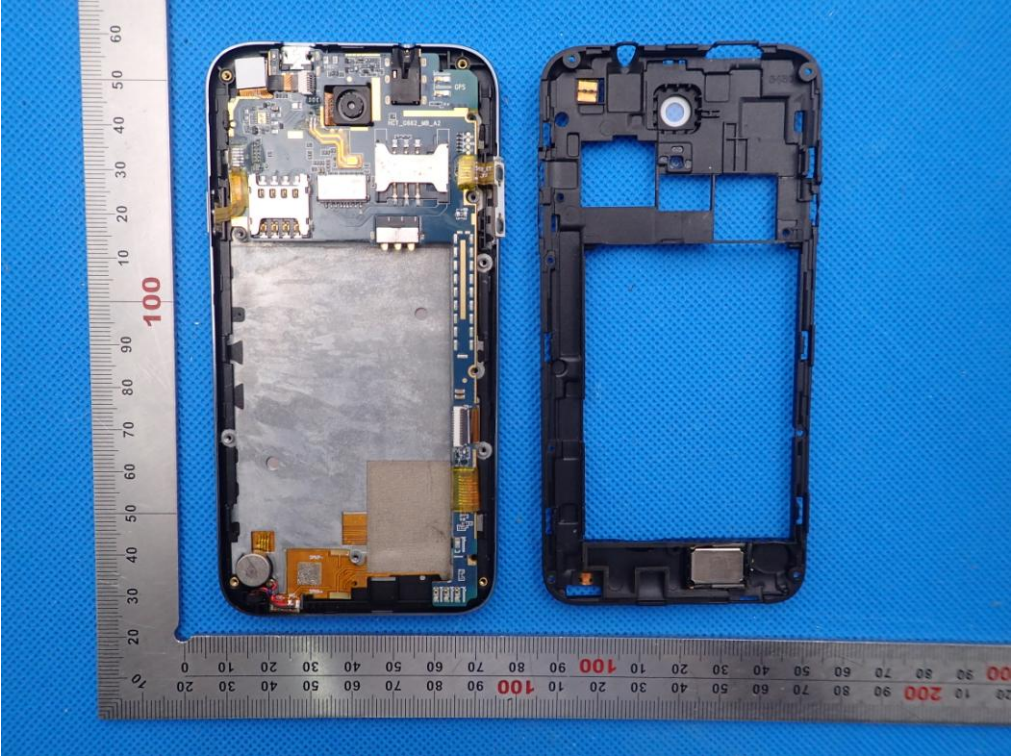

OPEN VIEW OF EUT-3

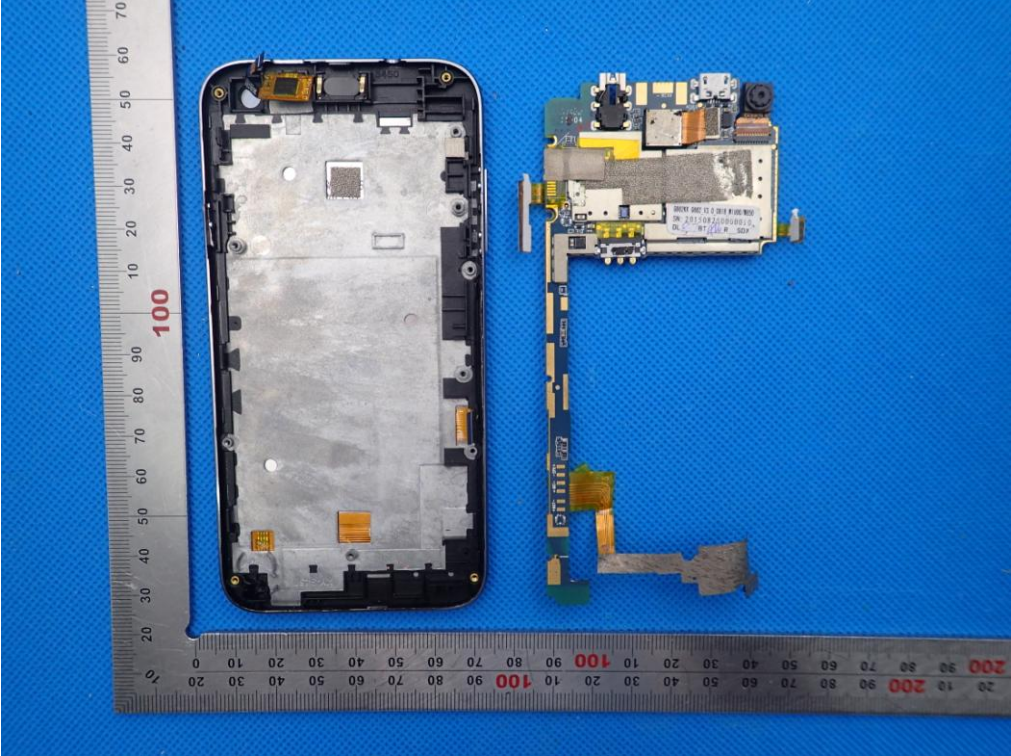



INTERNAL VIEW OF EUT-1

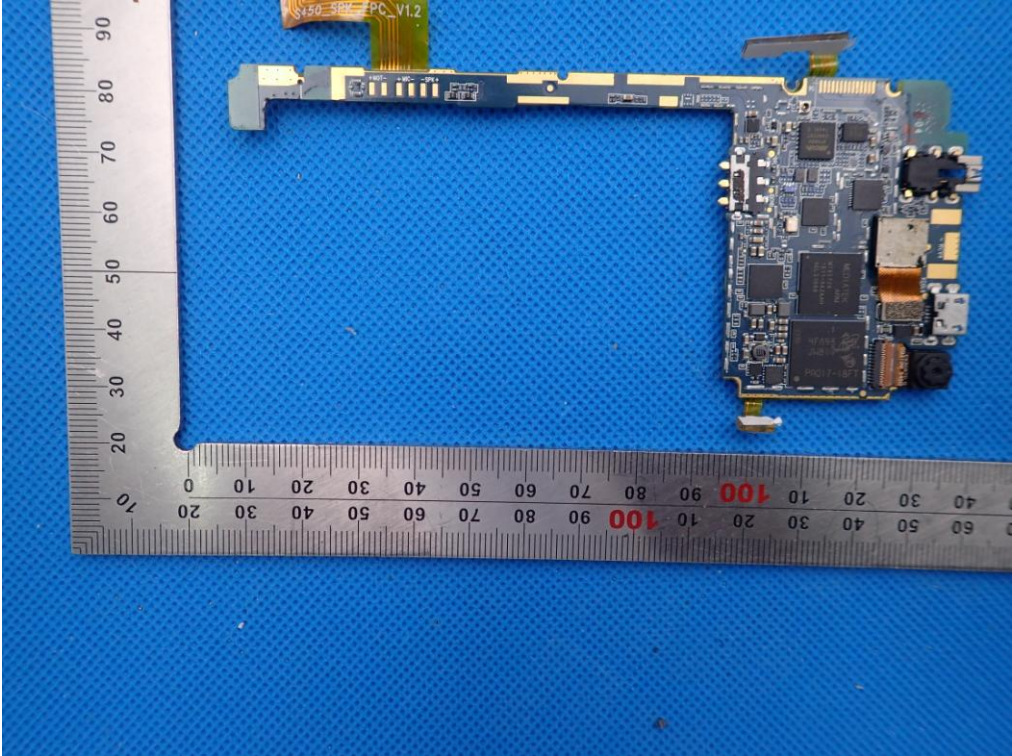

INTERNAL VIEW OF EUT-2

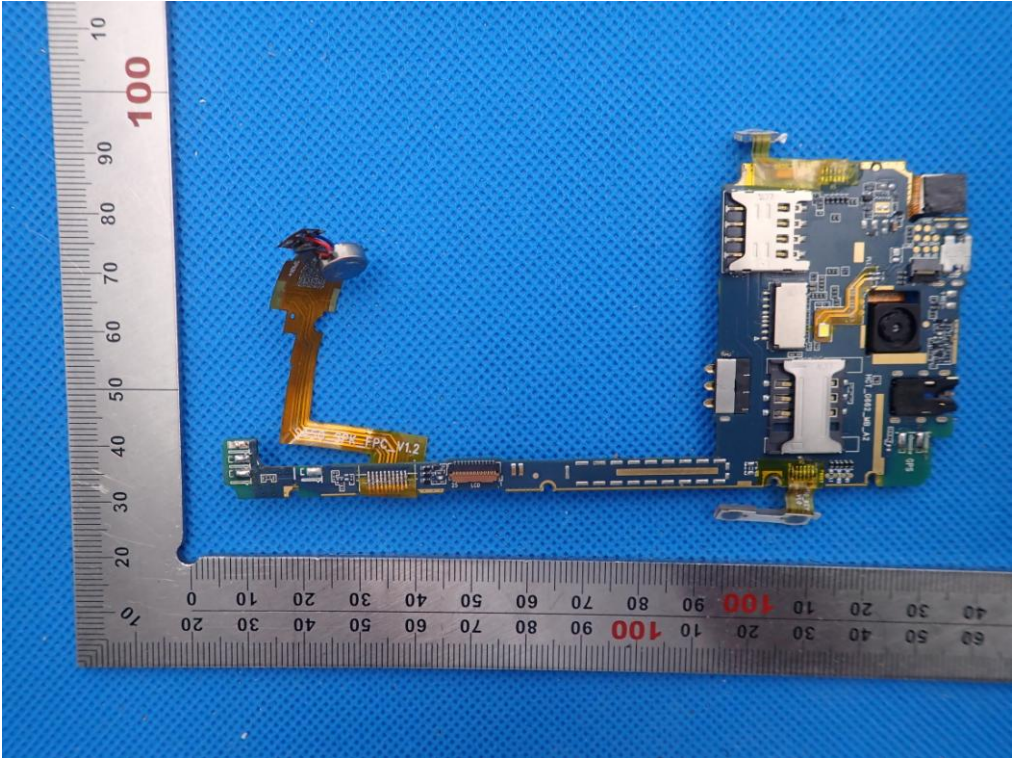

----END OF REPORT----