

---

# SAR Test Report

---

Report No.: AGC00653170502FH01

**FCC ID** : 2AFD9C5  
**APPLICATION PURPOSE** : Original Equipment  
**PRODUCT DESIGNATION** : GSM MOBILE PHONE  
**BRAND NAME** : ZOOM  
**MODEL NAME** : C5  
**CLIENT** : MOVEON TECHNOLOGY LIMITED  
**DATE OF ISSUE** : June 8,2017  
**STANDARD(S)** : IEEE Std. 1528:2013  
: FCC 47CFR § 2.1093  
: IEEE/ANSI C95.1:2005  
**REPORT VERSION** : V1.0

Attestation of Global Compliance(Shenzhen) Co., Ltd.



**CAUTION:**

This report shall not be reproduced except in full without the written permission of the test laboratory and shall not be quoted out of context.



### Report Revise Record

Report Version	Revise Time	Issued Date	Valid Version	Notes
V1.0	/	June 8,2017	Valid	Original Report

## Test Report Certification

Applicant Name	MOVEON TECHNOLOGY LIMITED
Applicant Address	World Trade Plaza-A block#3201-3202 Fuhong Road, Futian, Shenzhen, China
Manufacturer Name	MOVEON TECHNOLOGY LIMITED
Manufacturer Address	World Trade Plaza-A block#3201-3202 Fuhong Road, Futian, Shenzhen, China
Product Designation	GSM MOBILE PHONE
Brand Name	ZOOM
Model Name	C5
Different Description	N/A
EUT Voltage	DC3.7V by battery
Applicable Standard	IEEE Std. 1528:2013 FCC 47CFR § 2.1093 IEEE/ANSI C95.1:2005
Test Date	May 24,2017 to May 25,2017
Performed Location	Attestation of Global Compliance(Shenzhen) Co., Ltd.
	2 F, Building 2, No.1-No.4, Chaxi Sanwei Technical Industrial Park, Gushu, Xixiang Street, Bao'an District, Shenzhen, China
Report Template	AGCRT-US-2.5G/SAR (2016-01-01)

*Eric Zhou*

Tested By \_\_\_\_\_  
Eric Zhou(Zhou Yongkang)      May 25,2017

*Angela Li*

Checked By \_\_\_\_\_  
Angela Li(Li Jiao)      June 8,2017

*Forrest Lei*

Authorized By \_\_\_\_\_  
Forrest Lei(Lei Yonggang)      June 8,2017

---

Authorized Officer

**TABLE OF CONTENTS**

**1. SUMMARY OF MAXIMUM SAR VALUE ..... 5**

**2. GENERAL INFORMATION..... 6**

    2.1. EUT DESCRIPTION..... 6

**3. SAR MEASUREMENT SYSTEM..... 8**

    3.1. THE SATIMO SYSTEM USED FOR PERFORMING COMPLIANCE TESTS CONSISTS OF FOLLOWING ITEMS ..... 8

    3.2. COMOSAR E-FIELD PROBE ..... 9

    3.3. ROBOT..... 10

    3.4. VIDEO POSITIONING SYSTEM ..... 10

    3.5. DEVICE HOLDER ..... 11

    3.6. SAM TWIN PHANTOM..... 12

**4. SAR MEASUREMENT PROCEDURE..... 13**

    4.1. SPECIFIC ABSORPTION RATE (SAR)..... 13

    4.2. SAR MEASUREMENT PROCEDURE ..... 14

    4.3. RF EXPOSURE CONDITIONS ..... 16

**5. TISSUE SIMULATING LIQUID..... 17**

    5.1. THE COMPOSITION OF THE TISSUE SIMULATING LIQUID..... 17

    5.2. TISSUE DIELECTRIC PARAMETERS FOR HEAD AND BODY PHANTOMS ..... 17

    5.3. TISSUE CALIBRATION RESULT ..... 18

**6. SAR SYSTEM CHECK PROCEDURE ..... 19**

    6.1. SAR SYSTEM CHECK PROCEDURES ..... 19

    6.2. SAR SYSTEM CHECK..... 20

**7. EUT TEST POSITION..... 21**

    7.1. DEFINE TWO IMAGINARY LINES ON THE HANDSET..... 21

    7.2. CHEEK POSITION ..... 22

    7.3. TILT POSITION..... 22

    7.4. BODY WORN POSITION ..... 23

**8. SAR EXPOSURE LIMITS ..... 24**

**9. TEST EQUIPMENT LIST ..... 25**

**10. MEASUREMENT UNCERTAINTY ..... 26**

**11. CONDUCTED POWER MEASUREMENT..... 27**

**12. TEST RESULTS ..... 30**

    12.1. SAR TEST RESULTS SUMMARY..... 30

**APPENDIX A. SAR SYSTEM CHECK DATA ..... 36**

**APPENDIX B. SAR MEASUREMENT DATA..... 44**

**APPENDIX C. TEST SETUP PHOTOGRAPHS..... 72**

**APPENDIX D. CALIBRATION DATA ..... 77**

## 1. SUMMARY OF MAXIMUM SAR VALUE

The maximum results of Specific Absorption Rate (SAR) found during testing for EUT are as follows:

Frequency Band	Highest Reported 1g-SAR(W/Kg)		SAR Test Limit (W/Kg)
	Head	Body-worn	
GSM 850	0.377	1.136	1.6
PCS 1900	0.774	1.008	
Simultaneous Reported SAR	1.241		
SAR Test Result	PASS		

This device is compliance with Specific Absorption Rate (SAR) for general population/uncontrolled exposure limits (1.6W/Kg) specified in IEEE Std. 1528:2013; FCC 47CFR § 2.1093; IEEE/ANSI C95.1:2005 and the following specific FCC Test Procedures:

- KDB 447498 D01 General RF Exposure Guidance v06
- KDB 648474 D04 Handset SAR v01r03
- KDB 865664 D01 SAR Measurement 100MHz to 6GHz v01r04
- KDB 941225 D01 3G SAR Procedures v03r01

## 2. GENERAL INFORMATION

### 2.1. EUT Description

General Information	
Product Designation	GSM MOBILE PHONE
Test Model	C5
Hardware Version	HY300
Software Version	HY300-D131--
Device Category	Portable
RF Exposure Environment	Uncontrolled
Antenna Type	Internal
GSM and GPRS	
Support Band	<input checked="" type="checkbox"/> GSM 850 <input checked="" type="checkbox"/> PCS 1900 <input checked="" type="checkbox"/> GSM 900 <input checked="" type="checkbox"/> DCS 1800
GPRS Type	Class B
GPRS Class	Class 12(1Tx+4Rx, 2Tx+3Rx, 3Tx+2Rx, 4Tx+1Rx)
TX Frequency Range	GSM 850 : 820-850MHz;; PCS 1900: 1850-1910MHz;
RX Frequency Range	GSM 850 : 869~894MHz; PCS 1900: 1930~1990MHz
Release Version	R99
Type of modulation	GMSK for GSM/GPRS
Antenna Gain	1.0dBi
Max. Average Power	GSM850: 32.01dBm ;PCS1900: 28.56dBm
Bluetooth	
Bluetooth Version	<input type="checkbox"/> V2.0 <input checked="" type="checkbox"/> V2.1 <input type="checkbox"/> V2.1+EDR <input type="checkbox"/> V3.0 <input type="checkbox"/> V3.0+HS <input type="checkbox"/> V4.0 <input type="checkbox"/> V4.1
Operation Frequency	2402~2480MHz
Type of modulation	<input checked="" type="checkbox"/> GFSK <input type="checkbox"/> π/4-DQPSK <input type="checkbox"/> 8-DPSK
Avg. Burst Power	3.951dBm
Antenna Gain	0.5dBi

**EUT Description( Continue)**

<b>Accessories</b>	
Battery	Brand name: ZOOM Model No. : BP-4L Voltage and Capacitance: 3.7 V & 800mAh
Adapter	Brand name: ZOOM Model No. : C5 Input: AC 100-240V, 50/60Hz, 0.15A    Output: DC 5V, 500mA
Earphone	Brand name: N/A Model No. : N/A

Note:1.CMU200 can measure the average power and Peak power at the same time  
2.The sample used for testing is end product.

Product	Type
	<input checked="" type="checkbox"/> Production unit <input type="checkbox"/> Identical Prototype

### 3. SAR MEASUREMENT SYSTEM

#### 3.1. The SATIMO system used for performing compliance tests consists of following items

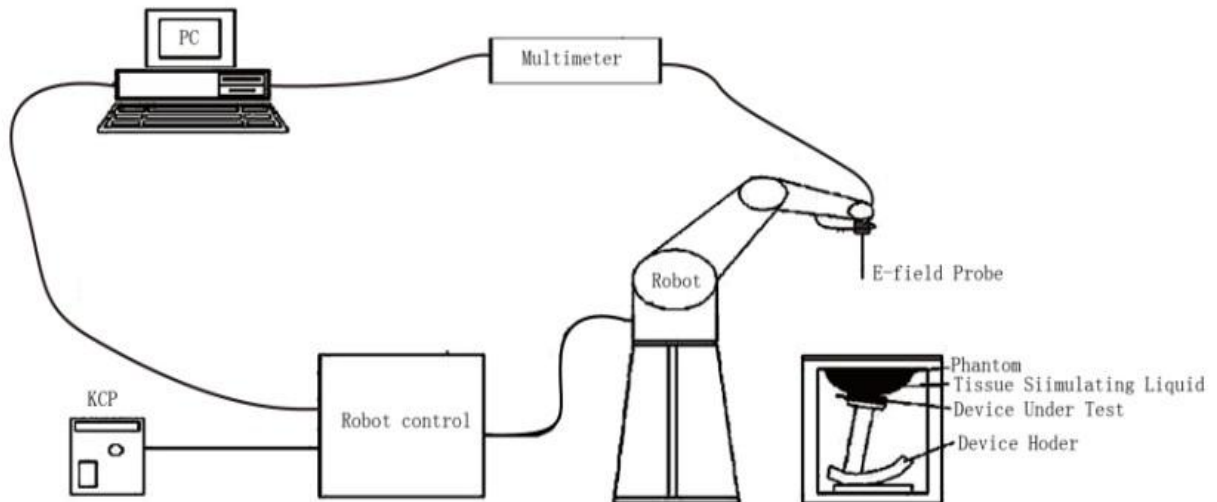

The COMOSAR system for performing compliance tests consists of the following items:

- The PC. It controls most of the bench devices and stores measurement data. A computer running WinXP and the Opensar software.
- The E-Field probe. The probe is a 3-axis system made of 3 distinct dipoles. Each dipole returns a voltage in function of the ambient electric field.
- The Keithley multimeter measures each probe dipole voltages.
- The SAM phantom simulates a human head. The measurement of the electric field is made inside the phantom.
- The liquids simulate the dielectric properties of the human head tissues.
- The network emulator controls the mobile phone under test.
- The validation dipoles are used to measure a reference SAR. They are used to periodically check the bench to make sure that there is no drift of the system characteristics over time.
- The phantom, the device holder and other accessories according to the targeted measurement.



### 3.2. COMOSAR E-Field Probe

The SAR measurement is conducted with the dosimetric probe manufactured by SATIMO. The probe is specially designed and calibrated for use in liquid with high permittivity. The dosimetric probe has special calibration in liquid at different frequency. SATIMO conducts the probe calibration in compliance with international and national standards (e.g. IEEE 1528 and relevant KDB files.) The calibration data are in Appendix D.

#### Isotropic E-Field Probe Specification

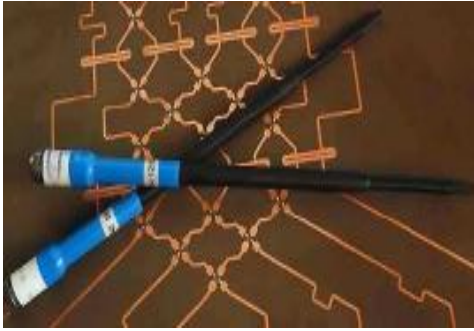
<b>Model</b>	SSE5	
<b>Manufacture</b>	MVG	
<b>Identification No.</b>	SN 14/16 EP307	
<b>Frequency</b>	0.7GHz-3GHz Linearity:±0.05dB(700MHz-3GHz)	
<b>Dynamic Range</b>	0.01W/Kg-100W/Kg Linearity:±0.05dB	
<b>Dimensions</b>	Overall length:330mm Length of individual dipoles:4.5mm Maximum external diameter:8mm Probe Tip external diameter:5mm Distance between dipoles/ probe extremity:2.7mm	
<b>Application</b>	High precision dosimetric measurements in any exposure scenario (e.g., very strong gradient fields). Only probe which enables compliance testing for frequencies up to 3 GHz with precision of better 30%.	

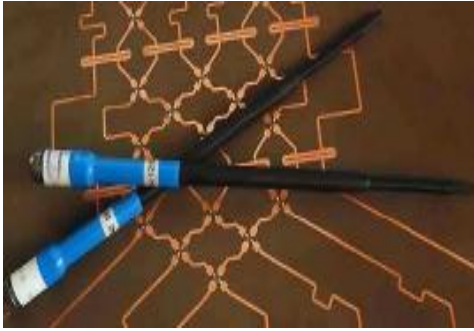
<b>Model</b>	SSE5	
<b>Manufacture</b>	MVG	
<b>Identification No.</b>	SN 14/16 EP308	
<b>Frequency</b>	0.3GHz-3.7GHz Linearity:±0.08dB(300MHz-3.7GHz)	
<b>Dynamic Range</b>	0.01W/Kg-100W/Kg Linearity:±0.08dB	
<b>Dimensions</b>	Overall length:330mm Length of individual dipoles:4.5mm Maximum external diameter:8mm Probe Tip external diameter:5mm Distance between dipoles/ probe extremity:2.7mm	
<b>Application</b>	High precision dosimetric measurements in any exposure scenario (e.g., very strong gradient fields). Only probe which enables compliance testing for frequencies up to 3 GHz with precision of better 30%.	

### 3.3. Robot

The COMOSAR system uses the KUKA robot from SATIMO SA (France). For the 6-axis controller COMOSAR system, the KUKA robot controller version from SATIMO is used.

The XL robot series have many features that are important for our application:

- High precision (repeatability 0.02 mm)
- High reliability (industrial design)
- Jerk-free straight movements
- Low ELF interference (the closed metallic construction shields against motor control fields)
- 6-axis controller



### 3.4. Video Positioning System

The video positioning system is used in OpenSAR to check the probe. Which is composed of a camera, LED, mirror and mechanical parts. The camera is piloted by the main computer with firewire link.

During the process, the actual position of the probe tip with respect to the robot arm is measured, as well as the probe length and the horizontal probe offset. The software then corrects all movements, such that the robot coordinates are valid for the probe tip.

The repeatability of this process is better than 0.1 mm. If a position has been taught with an aligned probe, the same position will be reached with another aligned probe within 0.1 mm, even if the other probe has different dimensions. During probe rotations, the probe tip will keep its actual position.

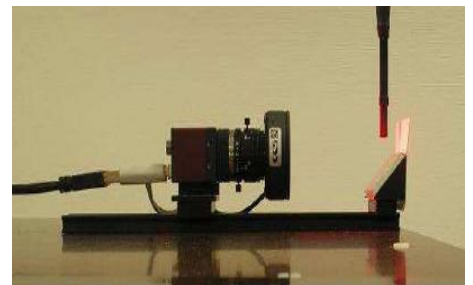

### 3.5. Device Holder

The COMOSAR device holder is designed to cope with different positions given in the standard. It has two scales for the device rotation (with respect to the body axis) and the device inclination (with respect to the line between the ear reference points). The rotation center for both scales is the ear reference point (EPR).

Thus the device needs no repositioning when changing the angles.

The COMOSAR device holder has been made out of low-loss POM material having the following dielectric parameters: relative permittivity

$\epsilon_r = 3$  and loss tangent  $\delta = 0.02$ . The amount of dielectric material has been reduced in the closest vicinity of the device, since measurements have suggested that the influence of the clamp on the test results could thus be lowered.

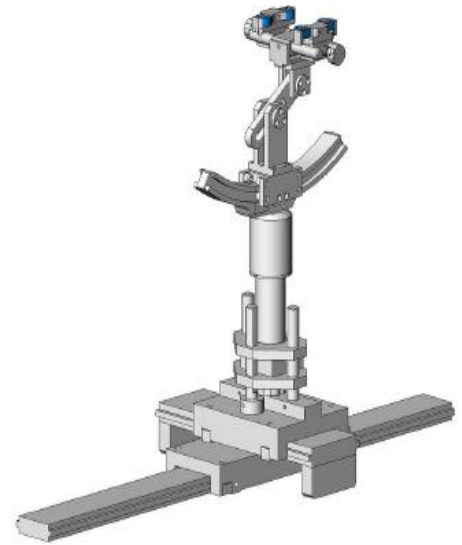

### 3.6. SAM Twin Phantom

The SAM twin phantom is a fiberglass shell phantom with 2mm shell thickness (except the ear region where shell thickness increases to 6mm). It has three measurement areas:

- Left head
- Right head
- Flat phantom



The bottom plate contains three pair of bolts for locking the device holder. The device holder positions are adjusted to the standard measurement positions in the three sections. A white cover is provided to tap the phantom during off-periods to prevent water evaporation and changes in the liquid parameters. On the phantom top, three reference markers are provided to identify the phantom position with respect to the robot.

## 4. SAR MEASUREMENT PROCEDURE

### 4.1. Specific Absorption Rate (SAR)

SAR is related to the rate at which energy is absorbed per unit mass in object exposed to a radio field. The SAR distribution in a biological body is complicated and is usually carried out by experimental techniques or numerical modeling. The standard recommends limits for two tiers of groups, occupational/controlled and occupational/uncontrolled, based on a person's awareness and ability to exercise control over his or her exposure. In general, occupational/controlled exposure limits are higher than the limits for general population/uncontrolled.

The SAR definition is the time derivative (rate) of the incremental energy (dW) absorbed by (dissipated in) an incremental mass (dm) contained in a volume element(dv) of given mass density ( $\rho$ ). The equation description is as below:

$$SAR = \frac{d}{dt} \left( \frac{dW}{dm} \right) = \frac{d}{dt} \left( \frac{dW}{\rho dV} \right)$$

SAR is expressed in units of Watts per kilogram (W/Kg)

SAR can be obtained using either of the following equations:

$$SAR = \frac{\sigma E^2}{\rho}$$

$$SAR = c_h \left. \frac{dT}{dt} \right|_{t=0}$$

Where

SAR	is the specific absorption rate in watts per kilogram;
E	is the r.m.s. value of the electric field strength in the tissue in volts per meter;
$\sigma$	is the conductivity of the tissue in siemens per metre;
$\rho$	is the density of the tissue in kilograms per cubic metre;
$c_h$	is the heat capacity of the tissue in joules per kilogram and Kelvin;

$\left. \frac{dT}{dt} \right|_{t=0}$  is the initial time derivative of temperature in the tissue in kelvins per second

## 4.2. SAR Measurement Procedure

### Step 1: Power Reference Measurement

The Power Reference Measurement and Power Drift Measurement are for monitoring the power drift of the device under test in the batch process. The minimum distance of probe sensors to surface is 2.7mm This distance cannot be smaller than the distance os sensor calibration points to probe tip as defined in the probe properties,

### Step 2: Area Scan

The Area Scan is used as a fast scan in two dimensions to find the area of high field values, before doing a fine measurement around the hot spot. The sophisticated interpolation routines implemented in SATIMO software can find the maximum locations even in relatively coarse grids. When an Area Scan has measured all reachable points, it computes the field maximal found in the scanned area, within a range of the global maximum. The range (in db) is specified in the standards for compliance testing. For example, a 2db range is required in IEEE Standard 1528, whereby 3db is a requirement when compliance is assessed in accordance with the ARIB standard (Japan) If one Zoom Scan follows the Area Scan, then only the absolute maximum will be taken as reference. For cases where multiple maximum are detected, the number of Zoom Scan has to be increased accordingly.

Area Scan Parameters extracted from KDB 865664 D01 SAR Measurement 100MHz to 6GHz

	≤ 3 GHz	> 3 GHz
Maximum distance from closest measurement point (geometric center of probe sensors) to phantom surface	5 ± 1 mm	$\frac{1}{2} \cdot \delta \cdot \ln(2) \pm 0.5$ mm
Maximum probe angle from probe axis to phantom surface normal at the measurement location	30° ± 1°	20° ± 1°
Maximum area scan spatial resolution: $\Delta x_{Area}$ , $\Delta y_{Area}$	≤ 2 GHz: ≤ 15 mm 2 – 3 GHz: ≤ 12 mm	3 – 4 GHz: ≤ 12 mm 4 – 6 GHz: ≤ 10 mm
	When the x or y dimension of the test device, in the measurement plane orientation, is smaller than the above, the measurement resolution must be ≤ the corresponding x or y dimension of the test device with at least one measurement point on the test device.	

### Step 3: Zoom Scan

Zoom Scan are used to assess the peak spatial SAR value within a cubic average volume containing 1g abd 10g of simulated tissue. The Zoom Scan measures points(refer to table below) within a cube whose base faces are centered on the maxima found in a preceding area scan job within the same procedure. When the measurement is done, the Zoom Scan evaluates the averaged SAR for 1g and 10g and displays these values next to the job's label.

Zoom Scan Parameters extracted from KDB865664 d01 SAR Measurement 100MHz to 6GHz

Maximum zoom scan spatial resolution: $\Delta x_{Zoom}$ , $\Delta y_{Zoom}$		$\leq 2$ GHz: $\leq 8$ mm 2 – 3 GHz: $\leq 5$ mm*	3 – 4 GHz: $\leq 5$ mm* 4 – 6 GHz: $\leq 4$ mm*
Maximum zoom scan spatial resolution, normal to phantom surface	uniform grid: $\Delta z_{Zoom}(n)$	$\leq 5$ mm	3 – 4 GHz: $\leq 4$ mm 4 – 5 GHz: $\leq 3$ mm 5 – 6 GHz: $\leq 2$ mm
	graded grid	$\Delta z_{Zoom}(1)$ : between 1 <sup>st</sup> two points closest to phantom surface	$\leq 4$ mm
		$\Delta z_{Zoom}(n>1)$ : between subsequent points	$\leq 1.5 \cdot \Delta z_{Zoom}(n-1)$
Minimum zoom scan volume	x, y, z	$\geq 30$ mm	3 – 4 GHz: $\geq 28$ mm 4 – 5 GHz: $\geq 25$ mm 5 – 6 GHz: $\geq 22$ mm
<p>Note: <math>\delta</math> is the penetration depth of a plane-wave at normal incidence to the tissue medium; see draft standard IEEE P1528-2011 for details.</p> <p>* When zoom scan is required and the <i>reported</i> SAR from the <i>area scan based I-g SAR estimation</i> procedures of KDB 447498 is <math>\leq 1.4</math> W/kg, <math>\leq 8</math> mm, <math>\leq 7</math> mm and <math>\leq 5</math> mm zoom scan resolution may be applied, respectively, for 2 GHz to 3 GHz, 3 GHz to 4 GHz and 4 GHz to 6 GHz.</p>			

Step 4: Power Drift Measurement

The Power Drift Measurement measures the field at the same location as the most recent power reference measurement within the same procedure, and with the same settings. The Power Drift Measurement gives the field difference in dB from the reading conducted within the same settings. This allows a user to monitor the power drift of the device under test within a batch process. The measurement procedure is the same as Step 1.

### 4.3. RF Exposure Conditions

Test Configuration and setting:

The EUT is a model of GSM Portable Mobile Station (MS). It supports GSM/GPRS, BT.

For WWAN SAR testing, the device was controlled by using a base station emulator. Communication between the device and the emulator were established by air link. The distance between the EUT and the antenna is larger than 50cm, and the output power radiated from the emulator antenna is at least 30db smaller than the output power of EUT.

**Antenna Location: ( front view )**

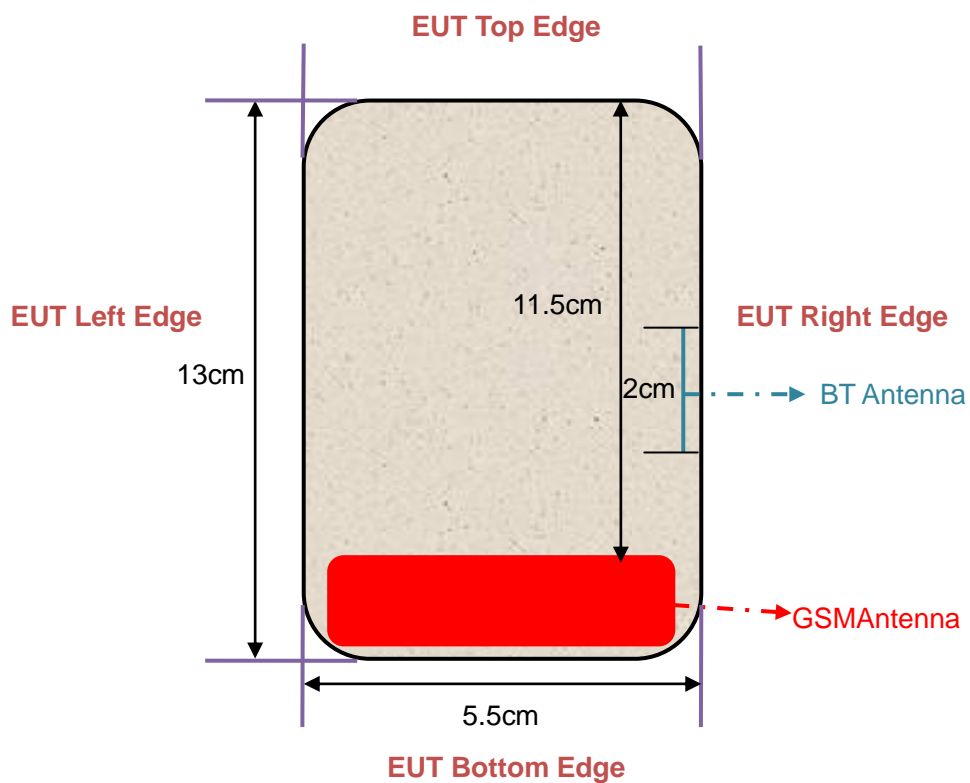



## 5. TISSUE SIMULATING LIQUID

For SAR measurement of the field distribution inside the phantom, the phantom must be filled with homogeneous tissue simulating liquid to a depth of at least 15cm. For head SAR testing the liquid height from the ear reference point (ERP) of the phantom to the liquid top surface is larger than 15cm For body SAR testing, the liquid height from the center of the flat phantom to the liquid top surface is larger than 15cm. The nominal dielectric values of the tissue simulating liquids in the phantom and the tolerance of 5% are listed in 4.2

### 5.1. The composition of the tissue simulating liquid

Ingredient (% Weight) Frequency (MHz)	Water	Nacl	Polysorbate 20	DGBE	1,2 Propanediol	Triton X-100
835 Head	50.36	1.25	48.39	0.0	0.0	0.0
835 Body	54.00	1	0.0	15	0.0	30
1900 Head	54.9	0.18	0.0	44.92	0.0	0.0
1900 Body	70	1	0.0	9	0.0	20

### 5.2. Tissue Dielectric Parameters for Head and Body Phantoms

The head tissue dielectric parameters recommended by the IEEE 1528 have been incorporated in the following table. These head parameters are derived from planar layer models simulating the highest expected SAR for the dielectric properties and tissue thickness variations in a human head. Other head and body tissue parameters that have not been specified in IEEE 1528 are derived from the tissue dielectric parameters computed from the 4-Cole-Cole equations described in Reference [12] and extrapolated according to the head parameters specified in IEEE 1528.

Target Frequency (MHz)	head		body	
	$\epsilon_r$	$\sigma$ (S/m)	$\epsilon_r$	$\sigma$ (S/m)
300	45.3	0.87	58.2	0.92
450	43.5	0.87	56.7	0.94
<b>835</b>	<b>41.5</b>	<b>0.90</b>	<b>55.2</b>	<b>0.97</b>
900	41.5	0.97	55.0	1.05
915	41.5	1.01	55.0	1.06
1450	40.5	1.20	54.0	1.30
1610	40.3	1.29	53.8	1.40
<b>1800 – 2000</b>	<b>40.0</b>	<b>1.40</b>	<b>53.3</b>	<b>1.52</b>
2450	39.2	1.80	52.7	1.95
3000	38.5	2.40	52.0	2.73

( $\epsilon_r$  = relative permittivity,  $\sigma$  = conductivity and  $\rho = 1000$  kg/m<sup>3</sup>)

### 5.3. Tissue Calibration Result

The dielectric parameters of the liquids were verified prior to the SAR evaluation using SATIMO Dielectric Probe Kit and R&S Network Analyzer ZVL6.

Tissue Stimulant Measurement for 835MHz					
	Fr. (MHz)	Dielectric Parameters ( $\pm 5\%$ )		Tissue Temp [°C]	Test time
		$\epsilon_r$ 41.5 (39.425-43.575)	$\delta$ [s/m] 0.90(0.855-0.945)		
Head	824.2	42.96	0.88	21.5	May 25,2017
	835	41.86	0.90		
	836.6	41.48	0.91		
	848.8	40.52	0.93		
	Fr. (MHz)	Dielectric Parameters ( $\pm 5\%$ )		Tissue Temp [°C]	Test time
		$\epsilon_r$ 55.20(52.44-57.96)	$\delta$ [s/m]0.97(0.9215-1.0185)		
Body	824.2	56.86	0.93	21.3	May 25,2017
	835	55.54	0.94		
	836.6	54.89	0.94		
	848.8	53.69	0.96		

Tissue Stimulant Measurement for 1900MHz					
	Fr. (MHz)	Dielectric Parameters ( $\pm 5\%$ )		Tissue Temp [°C]	Test time
		$\epsilon_r$ 40.00(38.00-42.00)	$\delta$ [s/m]1.40(1.33-1.47)		
Head	1850.2	41.38	1.35	21.2	May 24,2017
	1880	40.25	1.38		
	1900	39.45	1.40		
	1909.8	38.73	1.43		
	Fr. (MHz)	Dielectric Parameters ( $\pm 5\%$ )		Tissue Temp [°C]	Test time
		$\epsilon_r$ 53.30(50.635-55.965)	$\delta$ [s/m]1.52(1.444-1.596)		
Body	1850.2	54.36	1.46	21.0	May 24,2017
	1880	53.13	1.50		
	1900	52.81	1.52		
	1909.8	51.64	1.54		

## 6. SAR SYSTEM CHECK PROCEDURE

### 6.1. SAR System Check Procedures

SAR system check is required to confirm measurement accuracy, according to the tissue dielectric media, probe calibration points and other system operating parameters required for measuring the SAR of a test device. The system verification must be performed for each frequency band and within the valid range of each probe calibration point required for testing the device. The same SAR probe(s) and tissue-equivalent media combinations used with each specific SAR system for system verification must be used for device testing. When multiple probe calibration points are required to cover substantially large transmission bands, independent system verifications are required for each probe calibration point. A system verification must be performed before each series of SAR measurements using the same probe calibration point and tissue-equivalent medium. Additional system verification should be considered according to the conditions of the tissue-equivalent medium and measured tissue dielectric parameters, typically every three to four days when the liquid parameters are remeasured or sooner when marginal liquid parameters are used at the beginning of a series of measurements.

Each SATIMO system is equipped with one or more system check kits. These units, together with the predefined measurement procedures within the SATIMO software, enable the user to conduct the system check and system validation. System kit includes a dipole, and dipole device holder.

The system check verifies that the system operates within its specifications. It's performed daily or before every SAR measurement. The system check uses normal SAR measurement in the flat section of the phantom with a matched dipole at a specified distance. The system check setup is shown as below.

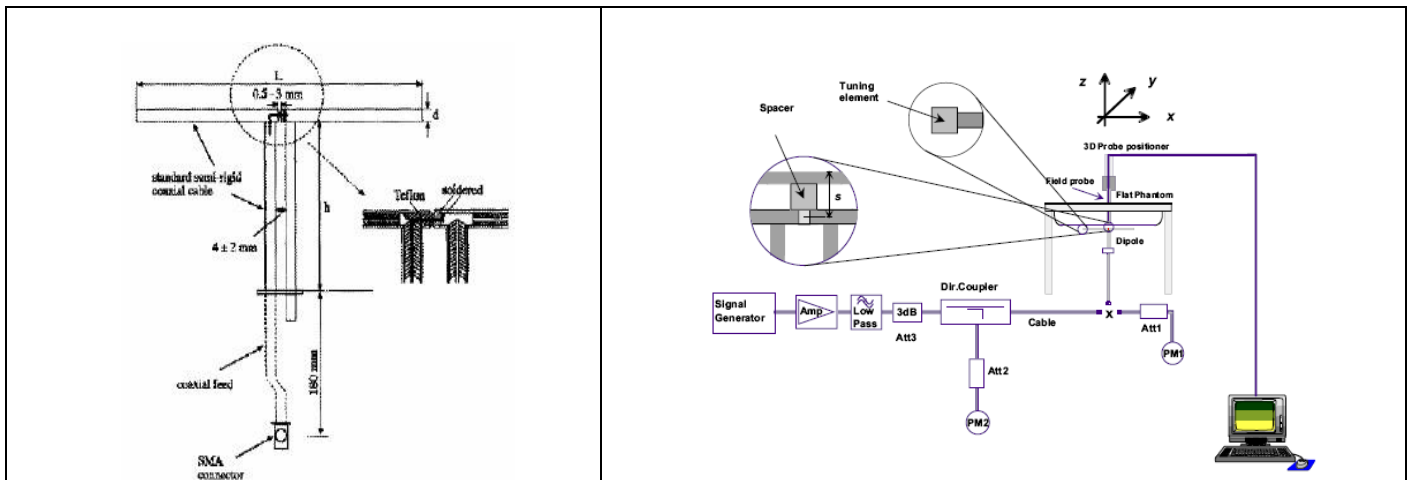

## 6.2. SAR System Check

### 6.2.1. Dipoles

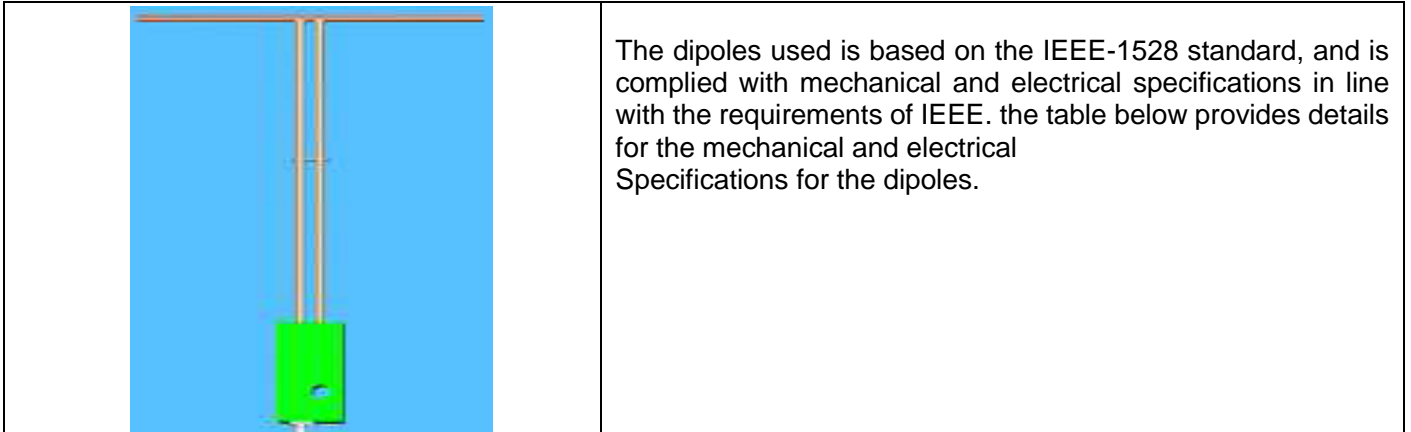

Frequency	L (mm)	h (mm)	d (mm)
835MHz	161.0	89.8	3.6
1900MHz	68	39.5	3.6

### 6.2.2. System Check Result

System Performance Check at 835MHz&1900MHz for Head								
Validation Kit: SN29/15 DIP 0G835-383&SN 29/15 DIP 1G900-389								
Frequency [MHz]	Target Value(W/Kg)		Reference Result ( $\pm 10\%$ )		Tested Value(W/Kg)		Tissue Temp. [°C]	Test time
	1g	10g	1g	10g	1g	10g		
835	10.04	6.43	9.036-11.044	5.787 -7.073	10.39	6.67	21.5	May 25,2017
1900	41.44	21.33	37.296-45.584	19.197-23.463	38.21	20.08	21.2	May 24,2017
System Performance Check at 835 MHz &1900MHz for Body								
Frequency [MHz]	Target Value(W/Kg)		Reference Result ( $\pm 10\%$ )		Tested Value(W/Kg)		Tissue Temp. [°C]	Test time
	1g	10g	1g	10g	1g	10g		
835	9.85	6.45	8.865-10.835	5.805-7.095	10.55	6.51	21.3	May 25,2017
1900	39.38	20.86	35.442-43.318	18.774-22.946	37.26	19.59	21.0	May 24,2017

## 7. EUT TEST POSITION

This EUT was tested in **Right Cheek, Right Tilted, Left Cheek, Left Tilted, Body back, Body front**

### 7.1. Define Two Imaginary Lines on the Handset

- (1) The vertical centerline passes through two points on the front side of the handset: the midpoint of the width  $w_t$  of the handset at the level of the acoustic output, and the midpoint of the width  $w_b$  of the handset.
- (2) The horizontal line is perpendicular to the vertical centerline and passes through the center of the acoustic output. The horizontal line is also tangential to the face of the handset at point A.
- (3) The two lines intersect at point A. Note that for many handsets, point A coincides with the center of the acoustic output; however, the acoustic output may be located elsewhere on the horizontal line. Also note that the vertical centerline is not necessarily to the front face of the handset, especially for clamshell handsets, handsets with flip covers, and other irregularly shaped handsets.

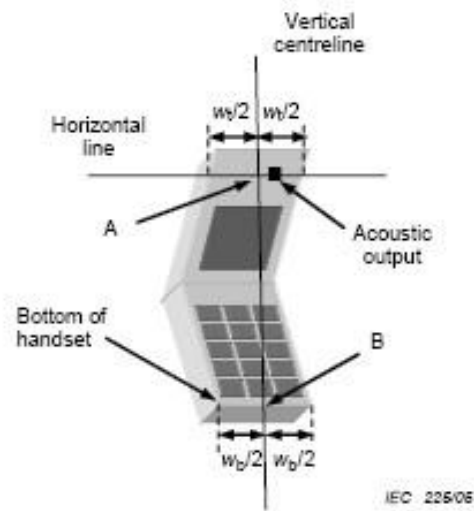
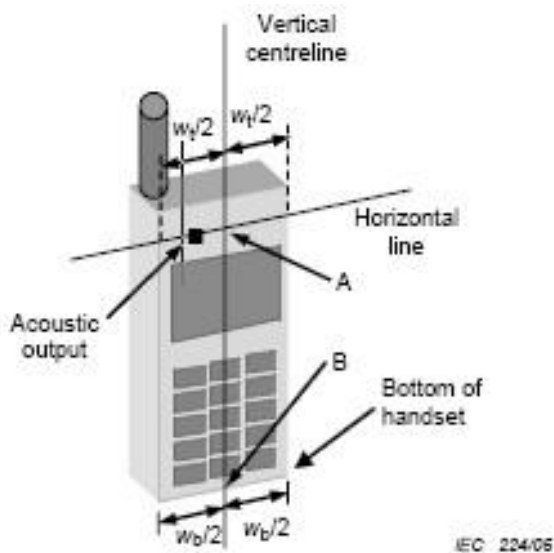

## 7.2. Cheek Position

- (1) To position the device with the vertical center line of the body of the device and the horizontal line crossing the center piece in a plane parallel to the sagittal plane of the phantom. While maintaining the device in this plane, align the vertical center line with the reference plane containing the ear and mouth reference point (M: Mouth, RE: Right Ear, and LE: Left Ear) and align the center of the ear piece with the line RE-LE.
- (2) To move the device towards the phantom with the ear piece aligned with the the line LE-RE until the phone touched the ear. While maintaining the device in the reference plane and maintaining the phone contact with ear, move the bottom of the phone until any point on the front side is in contact with the cheek of the phantom or until contact with the ear is lost



## 7.3. Tilt Position

- (1) To position the device in the "cheek" position described above.
- (2) While maintaining the device in the reference plane described above and pivoting against the ear, moves it outward away from the mouth by an angle of 15 degrees or until with the ear is lost.



#### 7.4. Body Worn Position

- (1) To position the EUT parallel to the phantom surface.
- (2) To adjust the EUT parallel to the flat phantom.
- (3) To adjust the distance between the EUT surface and the flat phantom to **5mm**.

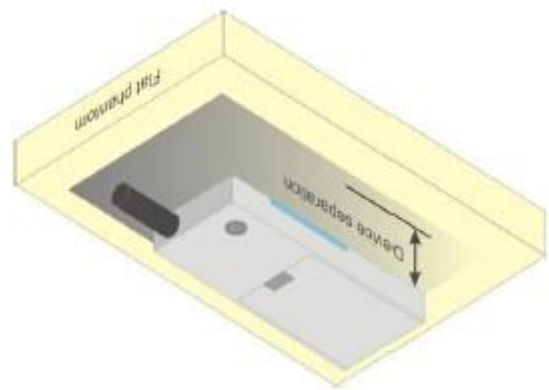
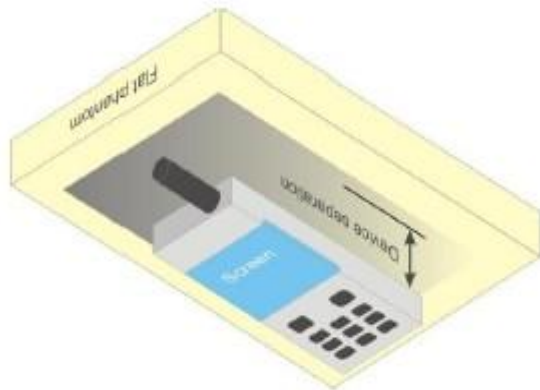

## 8. SAR EXPOSURE LIMITS

SAR assessments have been made in line with the requirements of IEEE-1528, and comply with ANSI/IEEE C95.1-2005 “Uncontrolled Environments” limits. These limits apply to a location which is deemed as “Uncontrolled Environment” which can be described as a situation where the general public may be exposed to an RF source with no prior knowledge or control over their exposure.

### Limits for General Population/Uncontrolled Exposure (W/kg)

Type Exposure	Uncontrolled Environment Limit (W/kg)
Spatial Peak SAR (1g cube tissue for brain or body)	1.60
Spatial Average SAR (Whole body)	0.08
Spatial Peak SAR (Limbs)	4.0



## 9. TEST EQUIPMENT LIST

Equipment description	Manufacturer/ Model	Identification No.	Current calibration date	Next calibration date
SAR Probe	MVG	SN 14/16 EP307	07/05/2016	07/04/2017
SAR Probe	MVG	SN 14/16 EP308	12/05/2016	12/04/2017
TISSUE Probe	SATIMO	SN 23/16 OCPG 75	07/05/2016	07/04/2017
Phantom	SATIMO	SN_4511_SAM90	Validated. No cal required.	Validated. No cal required.
Liquid	SATIMO	-	Validated. No cal required.	Validated. No cal required.
Comm Tester	Agilent-8960	GB46310822	03/02/2017	03/01/2018
Multimeter	Keithley 2000	1188656	03/02/2017	03/01/2018
Dipole	SATIMO SID835	SN29/15 DIP 0G835-383	07/05/2016	07/04/2019
Dipole	SATIMO SID1900	SN 29/15 DIP 1G900-389	07/05/2016	07/04/2019
Signal Generator	Agilent-E4438C	US41461365	03/02/2017	03/01/2018
Vector Analyzer	Agilent / E4440A	US40420298	07/02/2016	07/01/2017
Network Analyzer	Rhode & Schwarz ZVL6	SN100132	03/02/2017	03/01/2018
Attenuator	Warison /WATT-6SR1211	N/A	N/A	N/A
Attenuator	Mini-circuits / VAT-10+	N/A	N/A	N/A
Amplifier	EM30180	SN060552	03/02/2017	03/01/2018
Directional Couple	Werlatone/ C5571-10	SN99463	07/02/2016	07/01/2017
Directional Couple	Werlatone/ C6026-10	SN99482	07/02/2016	07/01/2017
Power Sensor	NRP-Z21	1137.6000.02	10/10/2016	10/09/2017
Power Sensor	NRP-Z23	US38261498	03/02/2017	03/01/2018
Power Viewer	R&S	V2.3.1.0	N/A	N/A

Note: Per KDB 865664 Dipole SAR Validation, AGC Lab has adopted 3 years calibration intervals. On annual basis, every measurement dipole has been evaluated and is in compliance with the following criteria:

1. There is no physical damage on the dipole;
2. System validation with specific dipole is within 10% of calibrated value;
3. Return-loss is within 20% of calibrated measurement;
4. Impedance is within 5Ω of calibrated measurement.

## **10. MEASUREMENT UNCERTAINTY**

Per KDB 865664 D01 SAR Measurement 100 MHz to 6 GHz, when the highest measured 1-g SAR within a frequency band is < 1.5 W/Kg, the extensive SAR measurement uncertainty analysis described in IEEE 1528-2013 is not required in SAR reports submitted for equipment approval.

## 11. CONDUCTED POWER MEASUREMENT GSM BAND

Mode	Frequency(MHz)	Avg. Burst Power(dBm)	Duty cycle Factor(dBm)	Frame Power(dBm)
Maximum Power <1>				
GSM 850	824.2	31.82	-9	22.82
	836.6	<b>32.01</b>	-9	23.01
	848.8	31.99	-9	22.99
GPRS 850 (1 Slot)	824.2	30.88	-9	21.88
	836.6	30.91	-9	21.91
	848.8	30.92	-9	21.92
GPRS 850 (2 Slot)	824.2	28.60	-6	22.60
	836.6	28.24	-6	22.24
	848.8	28.57	-6	22.57
GPRS 850 (3 Slot)	824.2	27.23	-4.26	<b>22.97</b>
	836.6	26.78	-4.26	22.52
	848.8	26.89	-4.26	22.63
GPRS 850 (4 Slot)	824.2	25.18	-3	22.18
	836.6	25.12	-3	22.12
	848.8	25.39	-3	22.39
Maximum Power <2>				
GSM 850	824.2	31.80	-9	22.80
	836.6	31.93	-9	22.93
	848.8	31.96	-9	22.96
GPRS 850 (1 Slot)	824.2	30.86	-9	21.86
	836.6	30.90	-9	21.90
	848.8	30.91	-9	21.91
GPRS 850 (2 Slot)	824.2	28.58	-6	22.58
	836.6	28.22	-6	22.22
	848.8	28.55	-6	22.55
GPRS 850 (3 Slot)	824.2	27.21	-4.26	22.95
	836.6	26.76	-4.26	22.50
	848.8	26.87	-4.26	22.61
GPRS 850 (4 Slot)	824.2	25.16	-3	22.16
	836.6	25.11	-3	22.11
	848.8	25.36	-3	22.36

**GSM BAND CONTINUE**

Mode	Frequency(MHz)	Avg. Burst Power(dBm)	Duty cycle Factor(dBm)	Frame Power(dBm)
Maximum Power <1>				
PCS1900	1850.2	28.53	-9	19.53
	1880	28.37	-9	19.37
	1909.8	<b>28.56</b>	-9	19.56
GPRS1900 (1 Slot)	1850.2	28.16	-9	19.16
	1880	28.42	-9	19.42
	1909.8	28.26	-9	19.26
GPRS1900 (2 Slot)	1850.2	25.39	-6	19.39
	1880	25.20	-6	19.20
	1909.8	25.14	-6	19.14
GPRS1900 (3 Slot)	1850.2	23.02	-4.26	18.76
	1880	22.84	-4.26	18.58
	1909.8	23.05	-4.26	18.79
GPRS1900 (4 Slot)	1850.2	22.47	-3	19.47
	1880	22.29	-3	19.29
	1909.8	22.59	-3	<b>19.59</b>
Maximum Power <2>				
PCS1900	1850.2	28.42	-9	19.42
	1880	28.49	-9	19.49
	1909.8	28.46	-9	19.46
GPRS1900 (1 Slot)	1850.2	28.13	-9	19.13
	1880	28.40	-9	19.40
	1909.8	28.23	-9	19.23
GPRS1900 (2 Slot)	1850.2	25.37	-6	19.37
	1880	25.18	-6	19.18
	1909.8	25.12	-6	19.12
GPRS1900 (3 Slot)	1850.2	23.01	-4.26	18.75
	1880	22.82	-4.26	18.56
	1909.8	23.03	-4.26	18.77
GPRS1900 (4 Slot)	1850.2	22.45	-3	19.45
	1880	22.27	-3	19.27
	1909.8	22.56	-3	19.56

Note 1:

The Frame Power (Source-based time-averaged Power) is scaled the maximum burst average power based on time slots. The calculated methods are show as following:

Frame Power = Max burst power (1 Up Slot) – 9 dB

Frame Power = Max burst power (2 Up Slot) – 6 dB

Frame Power = Max burst power (3 Up Slot) – 4.26 dB

Frame Power = Max burst power (4 Up Slot) – 3 dB

Note 2:

SAR is not required for GPRS (1 Slot) Mode because its output power is less than of Voice Mode

**Bluetooth\_V2.1**

<b>Modulation</b>	<b>Channel</b>	<b>Frequency(MHz)</b>	<b>Peak Power (dBm)</b>
GFSK	0	2402	2.982
	19	2440	<b>3.951</b>
	39	2480	3.945

## 12. TEST RESULTS

### 12.1. SAR Test Results Summary

#### 12.1.1. Test position and configuration

Head SAR was performed with the device configured in the positions according to IEEE 1528-2013, Body-worn SAR was performed with the device 5mm from the phantom.

#### 12.1.2. Operation Mode

1. Per KDB 447498 D01 v06 ,for each exposure position, if the highest 1-g SAR is  $\leq 0.8$  W/kg, testing for low and high channel is optional.
2. Per KDB 865664 D01 v01r04,for each frequency band, if the measured SAR is  $\geq 0.8$ W/Kg, testing for repeated SAR measurement is required , that the highest measured SAR is only to be tested. When the SAR results are near the limit, the following procedures are required for each device to verify these types of SAR measurement related variation concerns by repeating the highest measured SAR configuration in each frequency band.
  - (1) When the original highest measured SAR is  $\geq 0.8$ W/Kg, repeat that measurement once.
  - (2) Perform a second repeated measurement only if the ratio of largest to smallest SAR for the original and first repeated measurements is  $>1.20$  or when the original or repeated measurement is  $\geq 1.45$  W/Kg.
  - (3) Perform a third repeated measurement only if the original, first and second repeated measurement is  $\geq 1.5$  W/Kg and ratio of largest to smallest SAR for the original, first and second measurement is  $\geq 1.20$ .
3. Body-worn exposure conditions are intended to voice call operations, therefore GSM voice call mode is selected to be test.
4. Per KDB 648474 D04 v01r03,when the reported SAR for a body-worn accessory measured without a headset connected to the handset is  $\leq 1.2$ W/Kg, SAR testing with a headset connected is not required.
5. Maximum Scaling SAR in order to calculate the Maximum SAR values to test under the standard Peak Power, Calculation method is as follows:  
Maximum Scaling SAR =tested SAR (Max.)  $\times$  [maximum turn-up power (mw)/ maximum measurement output power(mw) ]
6. Proximity sensor, just for avoiding the wrong operation in the phone screen when call, and has no influence on output power or SAR result.

### 12.1.3. Test Result

SAR MEASUREMENT									
Depth of Liquid (cm):>15					Relative Humidity (%): 55.7				
Product: GSM MOBILE PHONE									
Test Mode: GSM850 with GMSK modulation									
Position	Mode	Ch.	Fr. (MHz)	Power Drift (<math>\pm 5\%</math>)	SAR (1g) (W/kg)	Max. Tune-up Power (dBm)	Meas. output Power (dBm)	Scaled SAR (W/Kg)	Limit (W/kg)
<b>SIM 1 Card</b>									
Left Cheek	voice	190	836.6	-0.08	0.296	32.01	32.01	0.296	1.6
Left Tilt	voice	190	836.6	0.12	0.157	32.01	32.01	0.157	1.6
Right Cheek	voice	190	836.6	-0.15	<b>0.377</b>	32.01	32.01	<b>0.377</b>	1.6
Right Tilt	voice	190	836.6	0.25	0.186	32.01	32.01	0.186	1.6
Body back	voice	128	824.2	-0.02	0.969	32.01	31.82	1.012	1.6
Body back	voice	190	836.6	0.16	1.079	32.01	32.01	1.079	1.6
Body back	voice	251	848.8	-0.03	<b>1.131</b>	32.01	31.99	<b>1.136</b>	1.6
Body front	voice	190	836.6	0.07	0.241	32.01	32.01	0.241	1.6
<b>SIM 2 Card</b>									
Left Cheek	GPRS-3 slot	190	836.6	-0.11	0.251	27.23	26.78	0.278	1.6
Left Tilt	GPRS-3 slot	190	836.6	0.10	0.145	27.23	26.78	0.161	1.6
Right Cheek	GPRS-3 slot	190	836.6	-0.09	<b>0.320</b>	27.23	26.78	<b>0.355</b>	1.6
Right Tilt	GPRS-3 slot	190	836.6	0.16	0.174	27.23	26.78	0.193	1.6
Body back	GPRS-3 slot	128	824.2	-0.02	0.705	27.23	27.23	0.705	1.6
Body back	GPRS-3 slot	190	836.6	0.01	0.812	27.23	26.78	0.901	1.6
Body back	GPRS-3 slot	251	848.8	-0.00	<b>0.897</b>	27.23	26.89	<b>0.970</b>	1.6
Body front	GPRS-3 slot	190	836.6	-0.04	0.239	27.23	26.78	0.265	1.6
<b>SIM 2 Card</b>									
Right Cheek	voice	190	836.6	0.17	0.360	32.01	31.93	0.367	1.6
Body back	voice	251	848.8	-0.13	1.112	32.01	31.96	1.125	1.6

Note:

- When the 1-g Reported SAR is  $\leq 0.8$  W/kg, testing for low and high channel is optional. Refer to KDB 447498.
- The test separation for body back and body front is 5mm of all above table.

SAR MEASUREMENT									
Depth of Liquid (cm):>15					Relative Humidity (%): 56.2				
Product: GSM MOBILE PHONE									
Test Mode: PCS1900 with GMSK modulation									
Position	Mode	Ch.	Fr. (MHz)	Power Drift (<±5%)	SAR (1g) (W/kg)	Max. Tune-up Power (dBm)	Meas. output Power (dBm)	Scaled SAR (W/Kg)	Limit (W/kg)
<b>SIM 1 Card</b>									
Left Cheek	voice	661	1880.0	-0.12	0.619	28.60	28.37	0.653	1.6
Left Tilt	voice	661	1880.0	0.05	0.396	28.60	28.37	0.418	1.6
Right Cheek	voice	661	1880.0	-0.06	<b>0.734</b>	28.60	28.37	<b>0.774</b>	1.6
Right Tilt	voice	661	1880.0	0.16	0.458	28.60	28.37	0.483	1.6
Body back	voice	512	1850.2	0.09	0.939	28.60	28.53	0.954	1.6
Body back	voice	661	1880.0	-0.22	<b>0.956</b>	28.60	28.37	<b>1.008</b>	1.6
Body back	voice	810	1909.8	0.17	0.941	28.60	28.56	0.950	1.6
Body front	voice	512	1850.2	-0.04	0.768	28.60	28.53	0.780	1.6
Body front	voice	661	1880.0	0.08	0.757	28.60	28.37	0.798	1.6
Body front	voice	810	1909.8	-0.23	0.784	28.60	28.56	0.791	1.6
<b>SIM 2 Card</b>									
Left Cheek	GPRS-4 slot	661	1880.0	-0.35	0.597	22.60	22.29	0.641	1.6
Left Tilt	GPRS-4 slot	661	1880.0	0.62	0.441	22.60	22.29	0.474	1.6
Right Cheek	GPRS-4 slot	661	1880.0	-0.19	<b>0.620</b>	22.60	22.29	<b>0.666</b>	1.6
Right Tilt	GPRS-4 slot	661	1880.0	0.36	0.426	22.60	22.29	0.458	1.6
Body back	GPRS-4 slot	512	1850.2	-0.52	<b>0.803</b>	22.60	22.47	0.827	1.6
Body back	GPRS-4 slot	661	1880.0	0.02	0.791	22.60	22.29	<b>0.850</b>	1.6
Body back	GPRS-4 slot	810	1909.8	-0.07	0.772	22.60	22.59	0.774	1.6
Body front	GPRS-4 slot	661	1880.0	0.11	0.659	22.60	22.29	0.708	1.6
Right Cheek	voice	661	1880.0	0.13	0.626	28.60	28.49	0.642	1.6
Body back	voice	661	1880.0	0.10	0.942	28.60	28.49	0.966	1.6

Note:

- When the 1-g Reported SAR is  $\leq 0.8$  W/kg, testing for low and high channel is optional. Refer to KDB 447498.
- The test separation for body back and body front is 5mm of all above table.

Repeated SAR										
Product: GSM MOBILE PHONE										
Test Mode: GSM850&PCS1900 with GMSK modulation										
Position	Mode	Ch.	Fr. (MHz)	Power Drift (<±5%)	Once SAR (1g) (W/kg)	Power Drift (<±5%)	Twice SAR (1g) (W/kg)	Power Drift (<±5%)	Third SAR (1g) (W/kg)	Limit (W/kg)
Body back	voice	251	848.8	0.06	1.080	-	-	-	-	1.6
Body back	voice	661	1880.0	0.25	0.919	-	-	-	-	1.6



NO	Simultaneous state	Portable Handset		
		Head	Body-worn	Hotspot
1	GSM(voice)+Bluetooth(data)	Yes	Yes	-
2	GSM (Data) + Bluetooth(data)	Yes	Yes	-

**NOTE:**

- Simultaneous with every transmitter must be the same test position.
- KDB 447498 D01, BT SAR is excluded as below table.
- KDB 447498 D01, for handsets the test separation distance is determined by the smallest distance between the outer surface of the device and the user; which is 0mm for head SAR and 5mm for body-worn SAR.
- According to KDB 447498 D01 4.3.1, Standalone SAR test exclusion is as follow:  
For 100 MHz to 6 GHz and test separation distances  $\leq 50$  mm, the 1-g and 10-g SAR test exclusion thresholds are determined by the following:  

$$[(\text{max. power of channel, including tune-up tolerance, mW}) / (\text{min. test separation distance, mm})] \cdot [\sqrt{f(\text{GHz})}] \leq 3.0$$
for 1-g SAR, and  $\leq 7.5$  for 10-g extremity SAR<sup>30</sup>, where
  - f(GHz) is the RF channel transmit frequency in GHz
  - Power and distance are rounded to the nearest mW and mm before calculation<sup>31</sup>
  - The result is rounded to one decimal place for comparison
  - The values 3.0 and 7.5 are referred to as numeric thresholds in step b) below
The test exclusions are applicable only when the minimum test separation distance is  $\leq 50$  mm, and for transmission frequencies between 100 MHz and 6 GHz. When the minimum test separation distance is  $< 5$  mm, a distance of 5 mm according to 4.1 f) is applied to determine SAR test exclusion.
- If the test separation distance is  $< 5$ mm, 5mm is used for excluded SAR calculation.
- According to KDB 447498 D01 4.3.2, simultaneous transmission SAR test exclusion is as follow:
  - Simultaneous transmission SAR test exclusion is determined for each operating configuration and exposure condition according to the reported standalone SAR of each applicable simultaneous transmitting antenna.
  - Any transmitters and antennas should be considered when calculating simultaneous mode.
  - For mobile phone and PC, it's the sum of all transmitters and antennas at the same mode with same position in each applicable exposure condition
  - When the standalone SAR test exclusion of section 4.3.2 is applied to an antenna that transmits simultaneously with other antennas, the standalone SAR must be estimated according to the following to det  

$$[(\text{max. power of channel, including tune-up tolerance, mW}) / (\text{min. test separation distance, mm})] \cdot [\sqrt{f(\text{GHz})/x}] \text{ W/kg}$$
for test separation distances  $\leq 50$  mm;  
where  $x = 7.5$  for 1-g SAR, and  $x = 18.75$  for 10-g SAR.
- When the sum of SAR is larger than the limit, SAR test exclusion is determined by the SAR to peak location separation ratio. The simultaneous transmitting antennas in each operating mode and exposure condition combination must be considered one pair at a time to determine the SAR to peak location separation ratio to qualify for test exclusion. The ratio is determined by  $(\text{SAR}_1 + \text{SAR}_2) \cdot 1.5 / R_i$ , rounded to two decimal digits, and must be  $\leq 0.04$  for all antenna pairs in the configuration to qualify for 1-g SAR test exclusion.

Estimated SAR		Max Power including Tune-up Tolerance		Separation Distance (mm)	Estimated SAR (W/kg)
		dBm	mW		
BT	Head	4	2.512	0	0.105
	Body	4	2.512	5	0.105

**Sum of the SAR for GSM 850 & BT:**

RF Exposure Conditions	Test Position	Simultaneous Transmission Scenario		$\Sigma$ 1-g SAR (W/Kg)	SPLSR (Yes/No)
		GSM 850	Bluetooth		
Head (voice)	Left Touch	0.296	0.105	0.401	No
	Left Tilt	0.157	0.105	0.262	No
	Right Touch	0.377	0.105	0.482	No
	Right Tilt	0.186	0.105	0.291	No
Body-worn (voice)	Rear	1.136	0.105	<b>1.241</b>	No
	Front	0.241	0.105	0.346	No
Head (Data)	Left Touch	0.278	0.105	0.383	No
	Left Tilt	0.161	0.105	0.266	No
	Right Touch	0.355	0.105	0.460	No
	Right Tilt	0.193	0.105	0.298	No
Body-worn (Data)	Rear	0.970	0.105	1.075	No
	Front	0.265	0.105	0.370	No

**Note:**

- According to KDB 447498 D01 General RF Exposure Guidance, when the simultaneous transmission SAR is less than 1.6 W/Kg, SPLSR assessment is not required.
- SPLSR mean is "The SAR to Peak Location Separation Ratio "

**Sum of the SAR for PCS 1900 & BT:**

RF Exposure Conditions	Test Position	Simultaneous Transmission Scenario		$\Sigma$ 1-g SAR (W/Kg)	SPLSR (Yes/No)
		PCS 1900	Bluetooth		
Head (voice)	Left Touch	0.653	0.105	0.758	No
	Left Tilt	0.418	0.105	0.523	No
	Right Touch	0.774	0.105	0.879	No
	Right Tilt	0.483	0.105	0.588	No
Body-worn (voice)	Rear	1.008	0.105	1.113	No
	Front	0.798	0.105	0.903	No
Head (Data)	Left Touch	0.641	0.105	0.746	No
	Left Tilt	0.474	0.105	0.579	No
	Right Touch	0.666	0.105	0.771	No
	Right Tilt	0.458	0.105	0.563	No
Body-worn (Data)	Rear	0.850	0.105	0.955	No
	Front	0.708	0.105	0.813	No

**Note:**

- According to KDB 447498 D01 General RF Exposure Guidance, when the simultaneous transmission SAR is less than 1.6 W/Kg, SPLSR assessment is not required.
- SPLSR mean is "The SAR to Peak Location Separation Ratio "

## APPENDIX A. SAR SYSTEM CHECK DATA

Test Laboratory: AGC Lab

Date: May 25, 2017

System Check Head 835 MHz

DUT: Dipole 835 MHz Type: SID 835

Communication System CW; Communication System Band: D835 (835.0 MHz); Duty Cycle: 1:1; Conv.F=5.72

Frequency: 835 MHz; Medium parameters used:  $f = 835$  MHz;  $\sigma=0.90$  mho/m;  $\epsilon_r = 41.86$ ;  $\rho = 1000$  kg/m<sup>3</sup> ;

Phantom section: Flat Section; Input Power=18dBm

Ambient temperature (°C):21.8, Liquid temperature (°C): 21.0

SATIMO Configuration

- Probe: SSE5; Calibrated: 12/05/2016; Serial No.: SN 14/16 EP308
- Sensor-Surface: 4mm (Mechanical Surface Detection)
- Phantom: SAM twin phantom
- Measurement SW: OpenSAR V4\_02\_32

Configuration/System Check 835MHz Head/Area Scan: Measurement grid: dx=8mm, dy=8mm

Configuration/System Check 835MHz Head/Zoom Scan: Measurement grid: dx=8mm,dy=8mm, dz=5mm

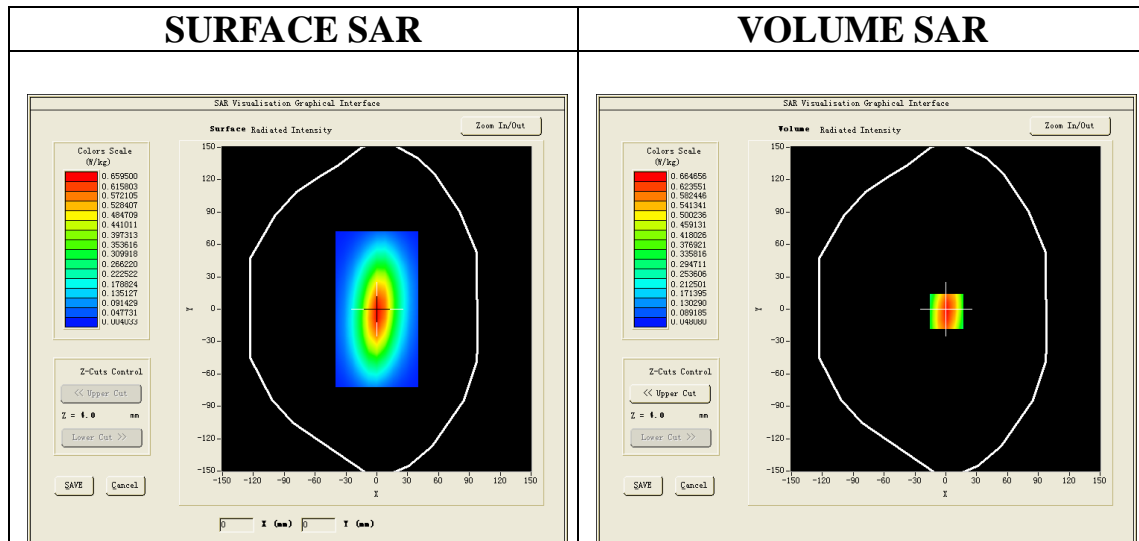

**Maximum location: X=1.00, Y=-2.00**

**SAR Peak: 0.96 W/kg**

<b>SAR 10g (W/Kg)</b>	0.421163
<b>SAR 1g (W/Kg)</b>	0.655854

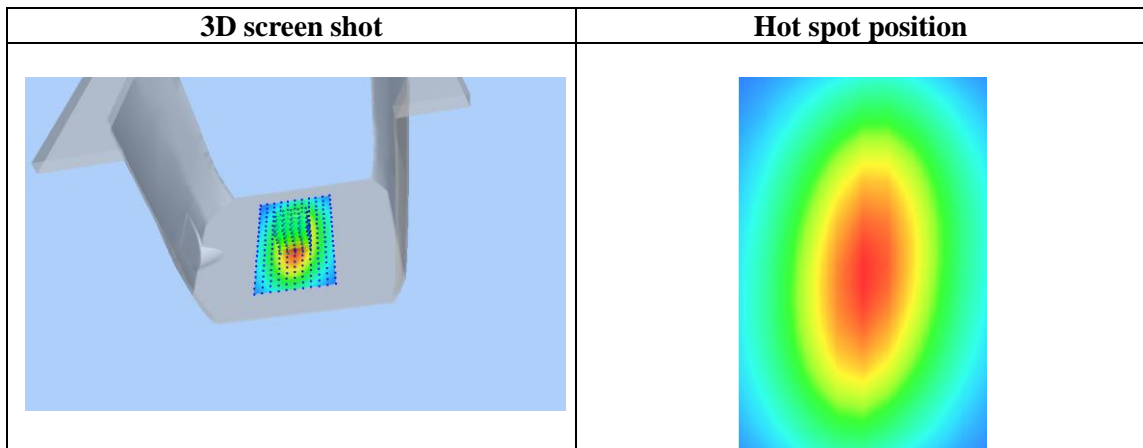
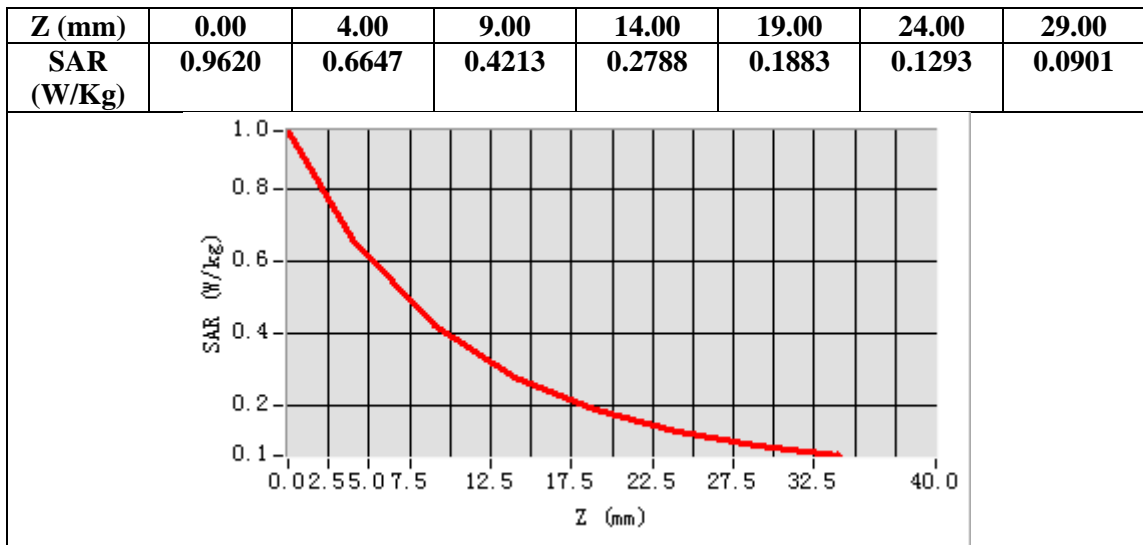

**Test Laboratory: AGC Lab**  
**System Check Body 835 MHz**

**Date: May 25,2017**

**DUT: Dipole 835 MHz Type: SID 835**

Communication System CW; Communication System Band: D835 (835.0 MHz); Duty Cycle: 1:1; Conv.F=5.94  
Frequency: 835 MHz; Medium parameters used:  $f = 835$  MHz;  $\sigma=0.94$  mho/m;  $\epsilon_r =55.54$ ;  $\rho= 1000$  kg/m<sup>3</sup> ;  
Phantom section: Flat Section; Input Power=18dBm  
Ambient temperature (°C):21.8, Liquid temperature (°C): 20.9

**SATIMO Configuration**

- Probe: SSE5; Calibrated: 12/05/2016; Serial No.: SN 14/16 EP308
- Sensor-Surface: 4mm (Mechanical Surface Detection)
- Phantom: SAM twin phantom
- Measurement SW: OpenSAR V4\_02\_32

**Configuration/System Check 835MHz Body/Area Scan: Measurement grid: dx=8mm, dy=8mm**

**Configuration/System Check 835MHz Body/Zoom Scan: Measurement grid: dx=8mm,dy=8mm, dz=5mm**

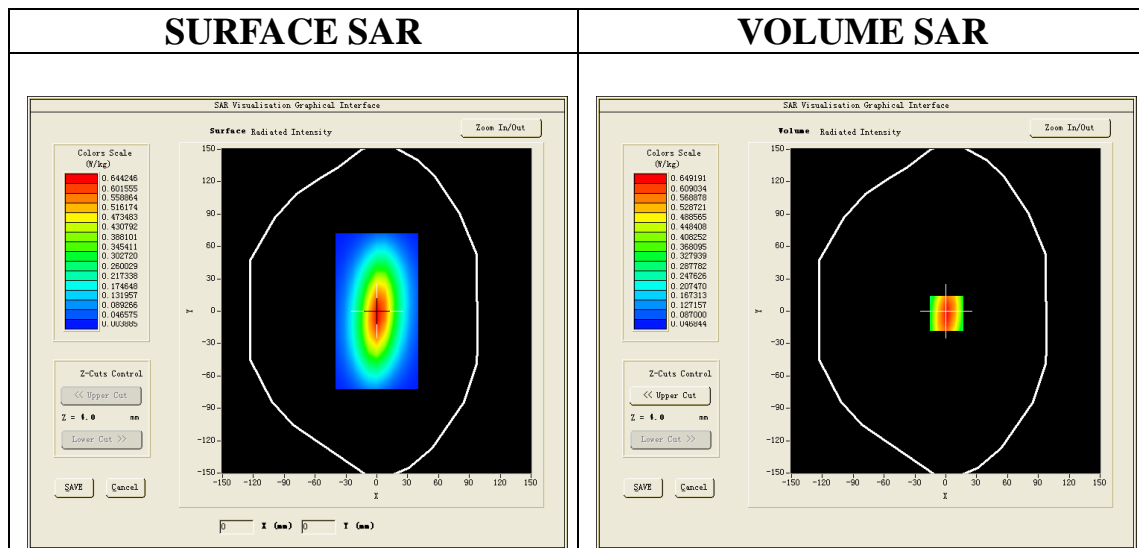

**Maximum location: X=1.00, Y=-2.00**  
**SAR Peak: 0.93 W/kg**

<b>SAR 10g (W/Kg)</b>	0.410627
<b>SAR 1g (W/Kg)</b>	0.665538

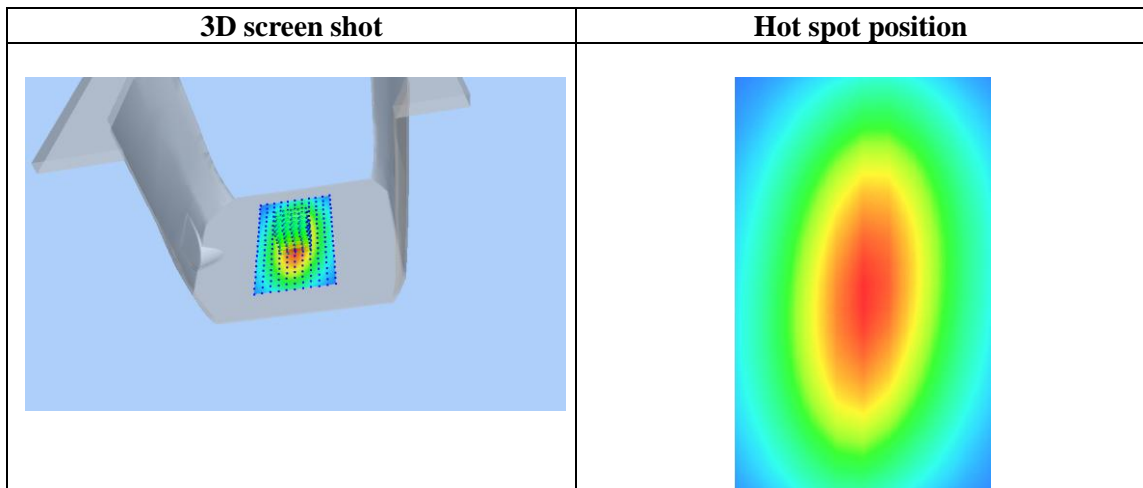
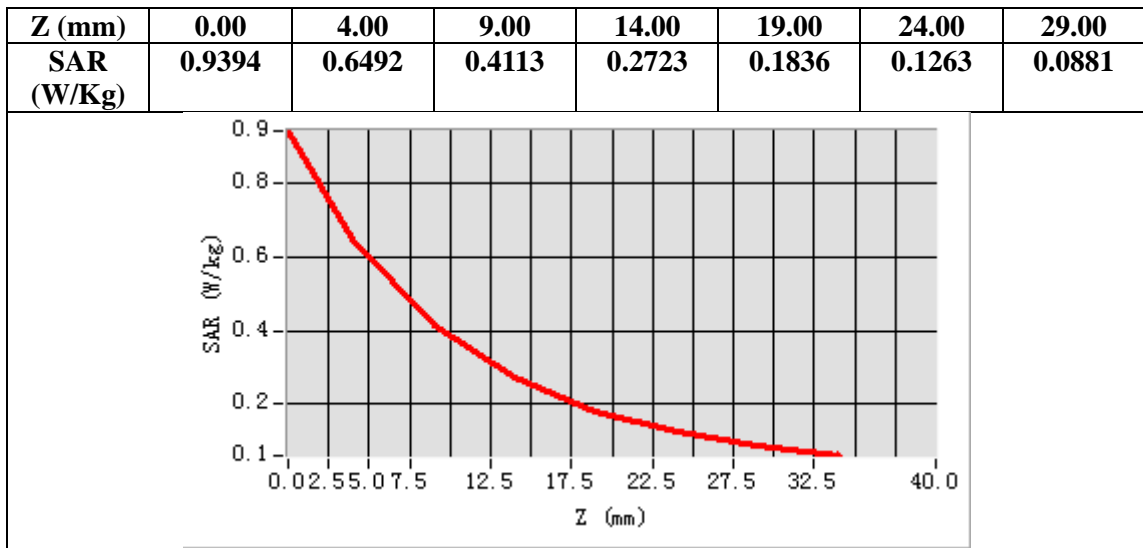

**Test Laboratory: AGC Lab**  
**System Check Head 1900MHz**

**Date: May 24,2017**

**DUT: Dipole 1900 MHz; Type: SID 1900**

Communication System: CW; Communication System Band: D1900 (1900.0 MHz); Duty Cycle:1:1; Conv.F=5.14  
Frequency: 1900 MHz; Medium parameters used:  $f = 1900$  MHz;  $\sigma=1.40$  mho/m;  $\epsilon_r =39.45$ ;  $\rho= 1000$  kg/m<sup>3</sup> ;  
Phantom section: Flat Section; Input Power=18dBm  
Ambient temperature (°C):22.0, Liquid temperature (°C): 21.2

SATIMO Configuration:

- Probe: SSE5; Calibrated: 07/05/2016; Serial No.: SN 14/16 EP307
- Sensor-Surface: 4mm (Mechanical Surface Detection)
- Phantom: SAM twin phantom
- Measurement SW: OpenSAR V4\_02\_35

**Configuration/System Check 1900MHz Head/Area Scan:** Measurement grid: dx=8mm, dy=8mm

**Configuration/System Check 1900MHz Head/Zoom Scan:** Measurement grid: dx=8mm,dy=8mm, dz=5mm

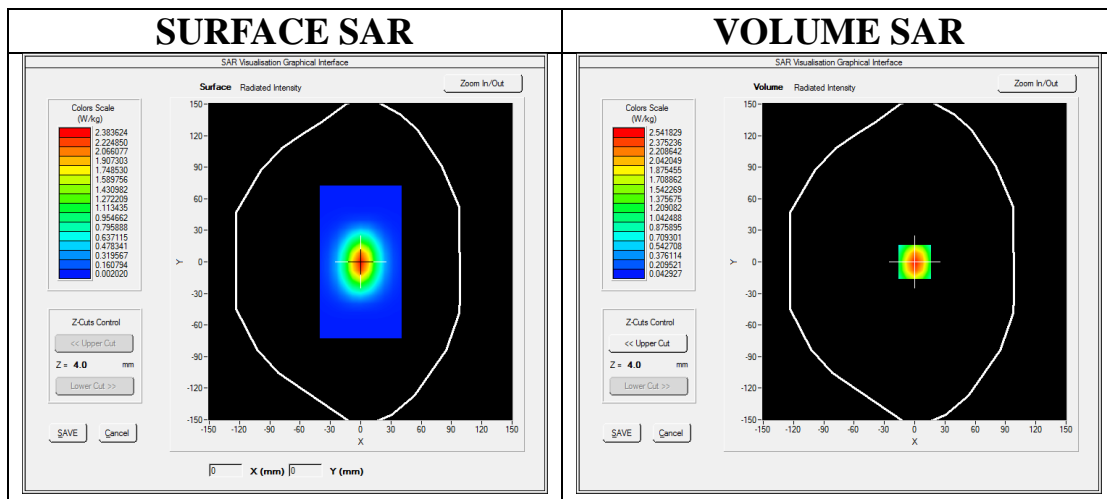

**Maximum location: X=0.00, Y=0.00**

**SAR Peak: 4.03 W/kg**

<b>SAR 10g (W/Kg)</b>	1.266699
<b>SAR 1g (W/Kg)</b>	2.411194



<b>Z (mm)</b>	<b>0.00</b>	<b>4.00</b>	<b>9.00</b>	<b>14.00</b>	<b>19.00</b>	<b>24.00</b>	<b>29.00</b>
<b>SAR (W/Kg)</b>	<b>4.0565</b>	<b>2.5418</b>	<b>1.3803</b>	<b>0.7759</b>	<b>0.4426</b>	<b>0.2565</b>	<b>0.1486</b>

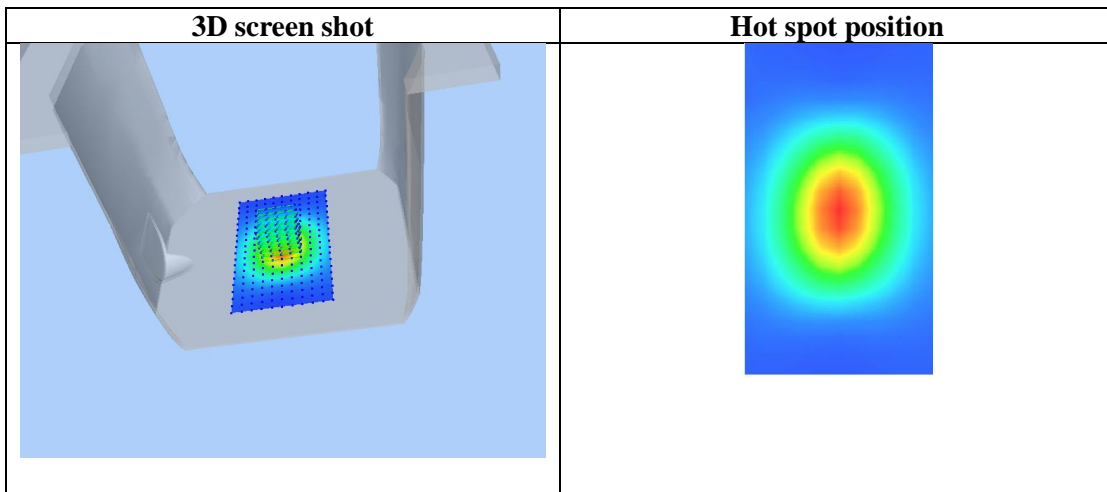
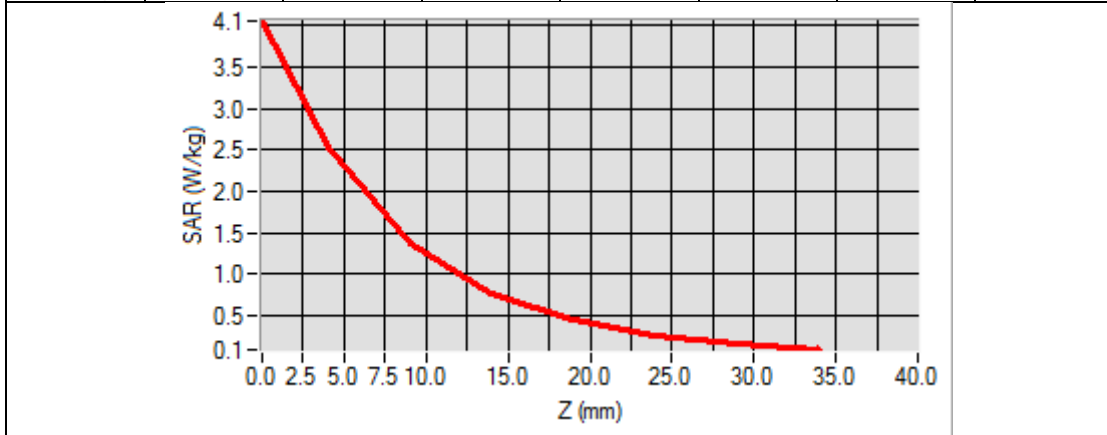

**Test Laboratory: AGC Lab**  
**System Check Body 1900MHz**  
**DUT: Dipole 1900 MHz; Type: SID 1900**

**Date: May 24,2017**

Communication System: CW; Communication System Band: D1900 (1900.0 MHz); Duty Cycle:1:1; Conv.F=5.34  
Frequency: 1900 MHz; Medium parameters used:  $f = 1900$  MHz;  $\sigma=1.52$  mho/m;  $\epsilon_r =52.81$ ;  $\rho= 1000$  kg/m<sup>3</sup> ;  
Phantom section: Flat Section; Input Power=10dBm  
Ambient temperature (°C):22.0, Liquid temperature (°C): 21.0

SATIMO Configuration:

- Probe: SSE5; Calibrated: 07/05/2016; Serial No.: SN 14/16 EP307
- Sensor-Surface: 4mm (Mechanical Surface Detection)
- Phantom: SAM twin phantom
- Measurement SW: OpenSAR V4\_02\_35

**Configuration/System Check 1900MHz Body/Area Scan: Measurement grid: dx=8mm, dy=8mm**

**Configuration/System Check 1900MHz Body/Zoom Scan: Measurement grid: dx=8mm,dy=8mm, dz=5mm**

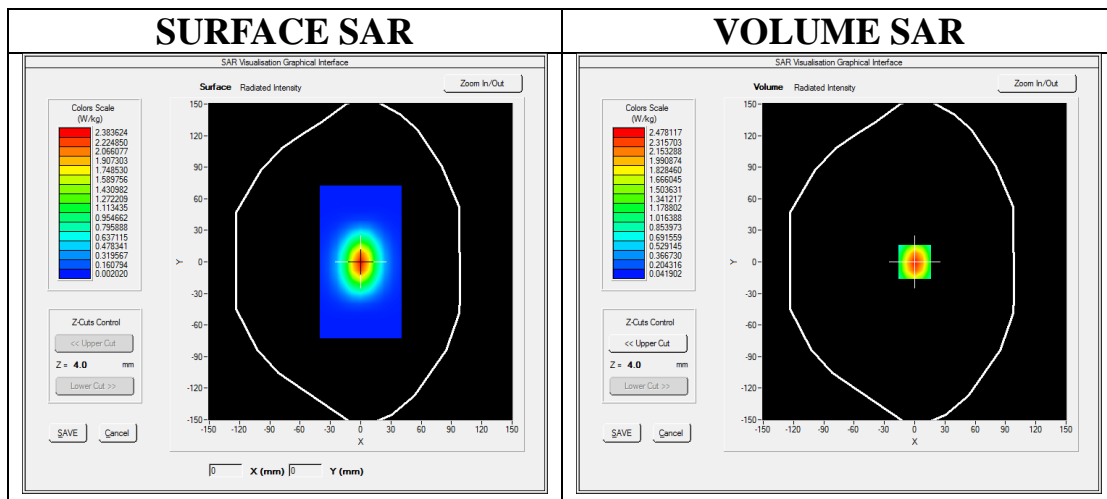

**Maximum location: X=0.00, Y=0.00**

**SAR Peak: 3.93 W/kg**

<b>SAR 10g (W/Kg)</b>	1.236033
<b>SAR 1g (W/Kg)</b>	2.351041

Z (mm)	0.00	4.00	9.00	14.00	19.00	24.00	29.00
SAR (W/Kg)	3.9500	2.4781	1.3482	0.7583	0.4327	0.2500	0.1441

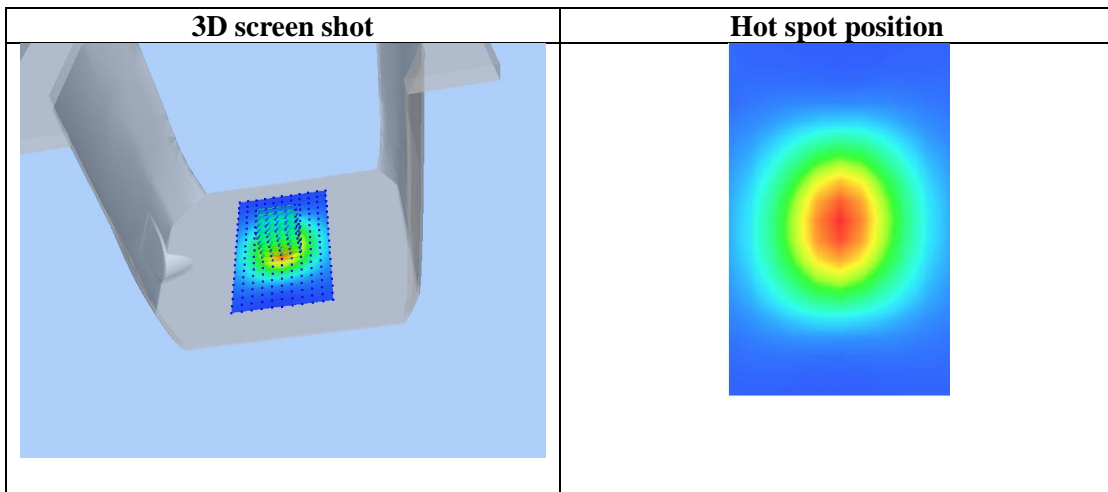
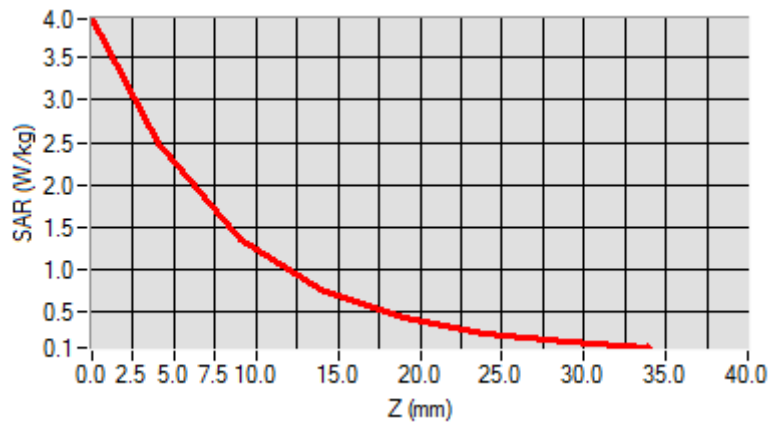

## APPENDIX B. SAR MEASUREMENT DATA

Test Laboratory: AGC Lab  
GSM 850 Mid-Touch-Right <SIM 1>  
DUT: GSM MOBILE PHONE; Type: C5

Date: May 25,2017

Communication System: Generic GSM; Communication System Band: GSM 850; Duty Cycle: 1:8.3; Conv.F=5.72;  
Frequency: 836.6 MHz; Medium parameters used:  $f = 835$  MHz;  $\sigma = 0.91$  mho/m;  $\epsilon_r = 41.48$ ;  $\rho = 1000$  kg/m<sup>3</sup> ;  
Phantom section: Right Section  
Ambient temperature (°C): 21.8, Liquid temperature (°C): 21.0

SATIMO Configuration:

- Probe: SSE5; Calibrated: 12/05/2016; Serial No.: SN 14/16 EP308
- Sensor-Surface: 4mm (Mechanical Surface Detection)
- Phantom: SAM twin phantom
- Measurement SW: OpenSAR V4\_02\_32

Configuration/GSM 850 Mid-Touch-Right/Area Scan: Measurement grid: dx=8mm, dy=8mm  
Configuration/GSM 850 Mid-Touch-Right/Zoom Scan: Measurement grid: dx=8mm,dy=8mm, dz=5mm;

<b>Area Scan</b>	sam_direct_droit2_surf8mm.txt
<b>ZoomScan</b>	5x5x7,dx=8mm dy=8mm dz=5mm,Complete
<b>Phantom</b>	Right head
<b>Device Position</b>	Cheek
<b>Band</b>	GSM 850
<b>Channels</b>	Middle
<b>Signal</b>	TDMA (Crest factor: 8.0)

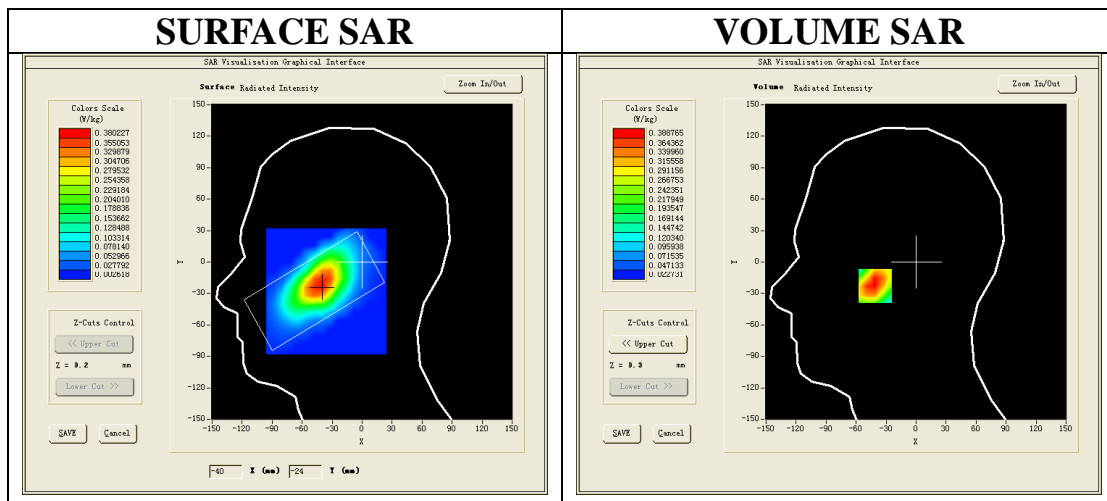

**Maximum location: X=-41.00, Y=-23.00**

**SAR Peak: 0.50 W/kg**

<b>SAR 10g (W/Kg)</b>	0.253855
<b>SAR 1g (W/Kg)</b>	0.376779

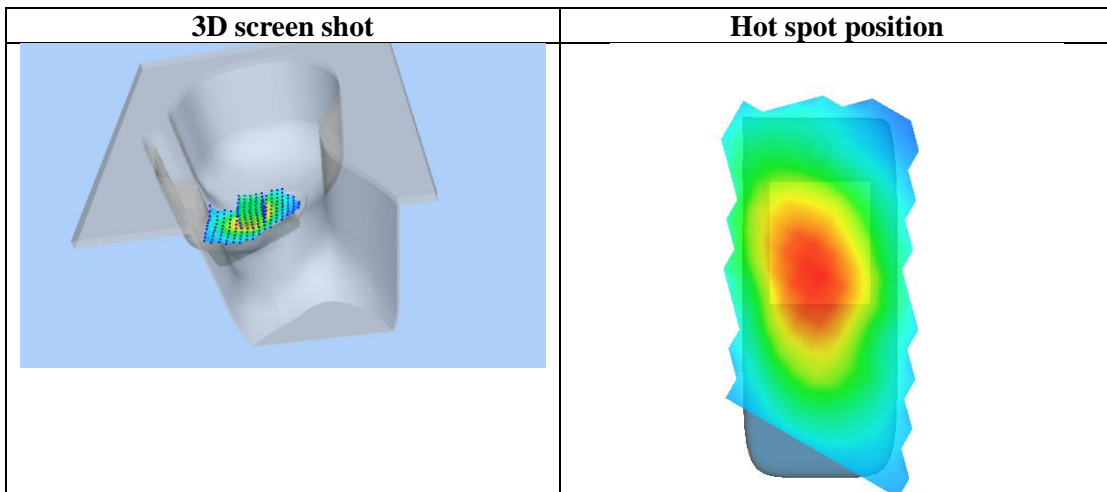
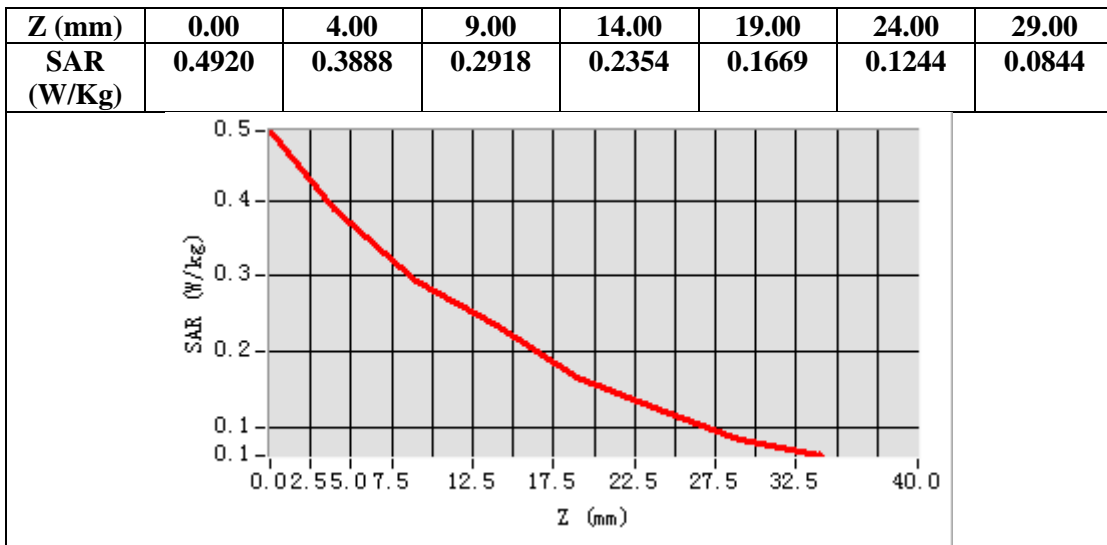

Test Laboratory: AGC Lab  
GSM 850 High- Body- Back (MS)<SIM 1>  
DUT: GSM MOBILE PHONE; Type: C5

Date: May 25,2017

Communication System: Generic GSM; Communication System Band: GSM 850; Duty Cycle: 1:8.3; Conv.F=5.94;  
Frequency: 848.8 MHz; Medium parameters used:  $f = 835$  MHz;  $\sigma = 0.96$  mho/m;  $\epsilon_r = 53.69$ ;  $\rho = 1000$  kg/m<sup>3</sup> ;  
Phantom section: Flat Section  
Ambient temperature (°C): 21.8, Liquid temperature (°C): 20.9

SATIMO Configuration:

- Probe: SSE5; Calibrated: 12/05/2016; Serial No.: SN 14/16 EP308
- Sensor-Surface: 4mm (Mechanical Surface Detection)
- Phantom: SAM twin phantom
- Measurement SW: OpenSAR V4\_02\_32

Configuration/GSM 850 High-Body-Back/Area Scan: Measurement grid: dx=10mm, dy=10mm

Configuration/GSM 850 High-Body-Back/Zoom Scan: Measurement grid: dx=8mm,dy=8mm, dz=5mm;

Area Scan	surf_sam_plan.txt
ZoomScan	5x5x7,dx=8mm dy=8mm dz=5mm,Complete
Phantom	Validation plane
Device Position	Body Back
Band	GSM 850
Channels	High
Signal	TDMA (Crest factor: 8.0)

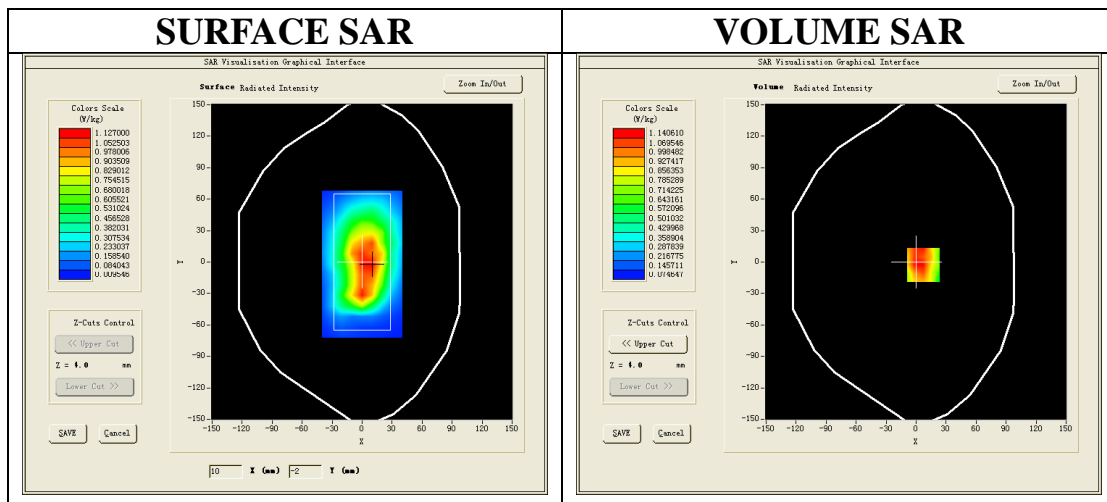

Maximum location: X=7.00, Y=-3.00

SAR Peak: 1.64 W/kg

SAR 10g (W/Kg)	0.744082
SAR 1g (W/Kg)	1.131054

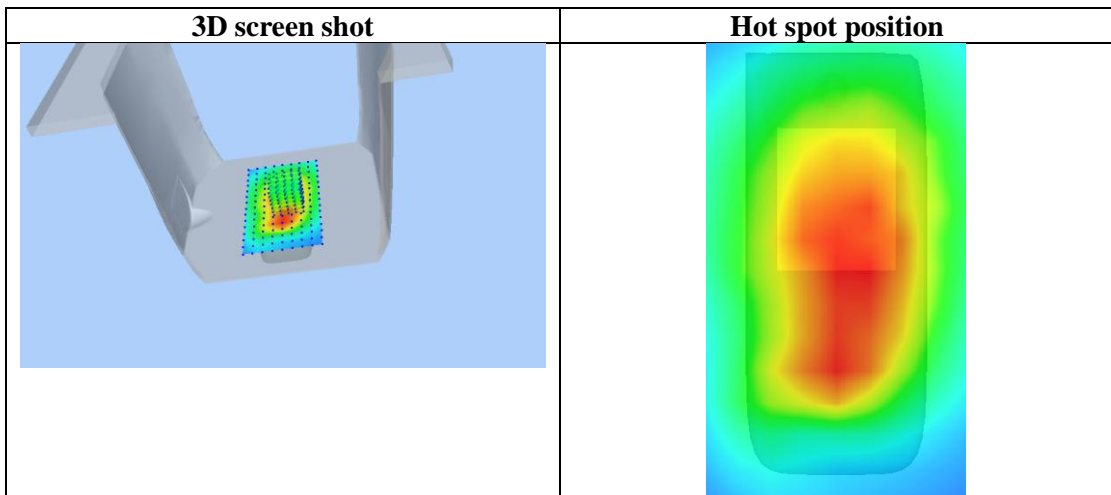
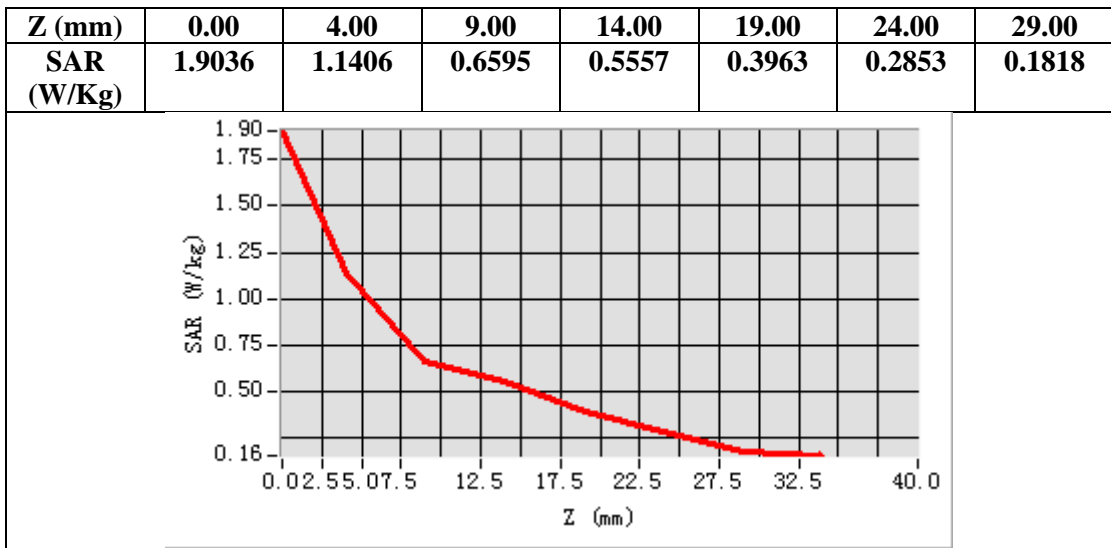

Test Laboratory: AGC Lab  
GPRS 850 Mid- Touch-Right (3up)  
DUT: GSM MOBILE PHONE; Type: C5

Date: May 25,2017

Communication System: GPRS-3Slot; Communication System Band: GSM 850; Duty Cycle: 1:2.7; Conv.F=5.72  
Frequency: 836.6 MHz; Medium parameters used:  $f = 835$  MHz;  $\sigma=0.91$  mho/m;  $\epsilon_r=41.48$ ;  $\rho= 1000$  kg/m<sup>3</sup>;  
Phantom section: Right Section  
Ambient temperature (°C): 21.8, Liquid temperature (°C): 21.0

SATIMO Configuration:

- Probe: SSE5; Calibrated: 12/05/2016; Serial No.: SN 14/16 EP308
- Sensor-Surface: 4mm (Mechanical Surface Detection)
- Phantom: SAM twin phantom
- Measurement SW: OpenSAR V4\_02\_32

Configuration/GPRS 850 Mid-Touch-Right/Area Scan: Measurement grid: dx=8mm, dy=8mm  
Configuration/GPRS 850 Mid-Touch-Right/Zoom Scan: Measurement grid: dx=8mm,dy=8mm, dz=5mm;

Area Scan	sam_direct_droit2_surf8mm.txt
Zoom Scan	5x5x7,dx=8mm dy=8mm dz=5mm,Complete
Phantom	Right head
Device Position	Cheek
Band	GSM 850
Channels	Middle
Signal	TDMA (Crest factor: 2.7)

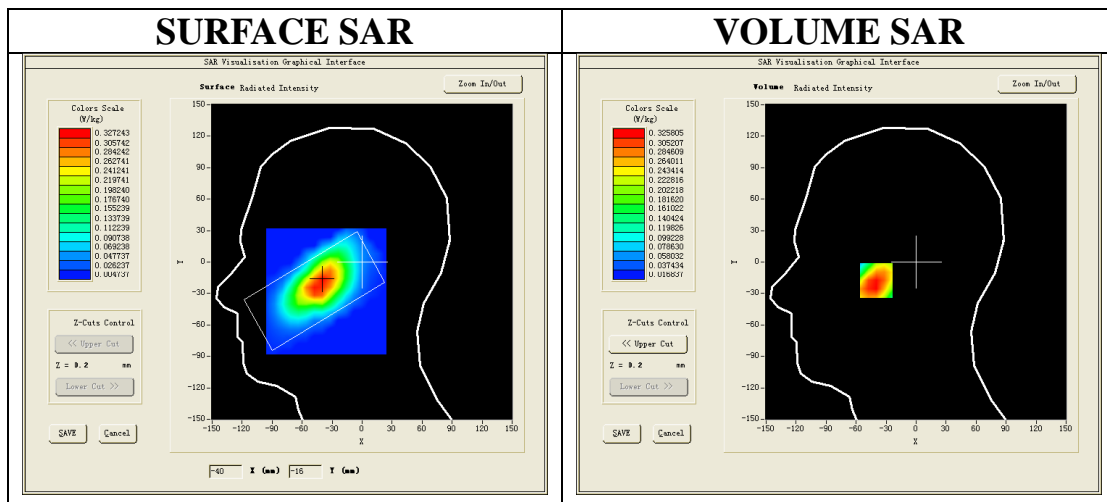

Maximum location: X=-40.00, Y=-17.00

SAR Peak: 0.42 W/kg

SAR 10g (W/Kg)	0.218487
SAR 1g (W/Kg)	0.319613



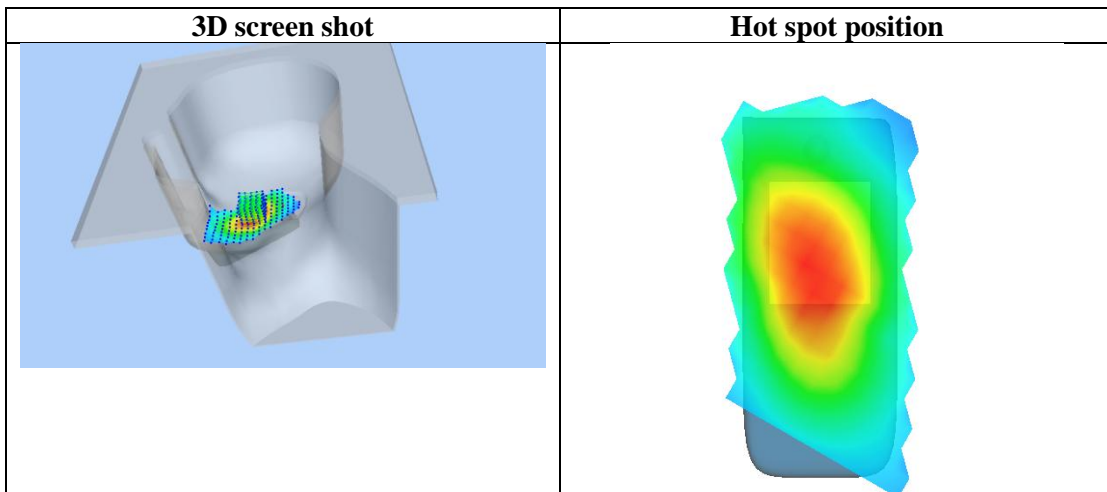
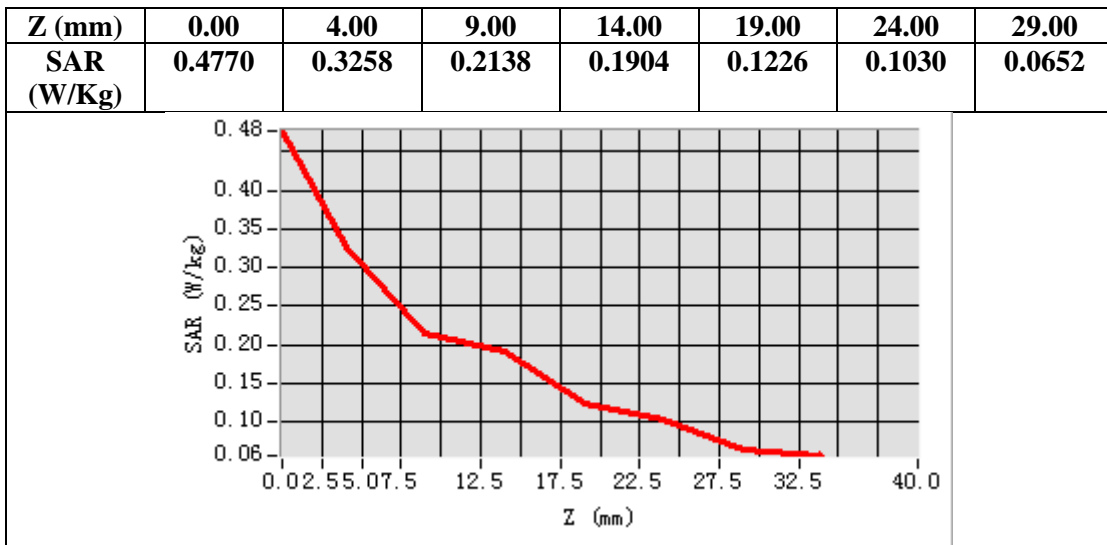

**Test Laboratory: AGC Lab**  
**GPRS 850 High- Body- Back (3up)**  
**DUT: GSM MOBILE PHONE; Type: C5**

**Date: May 25,2017**

Communication System: GPRS-3Slot; Communication System Band: GSM 850; Duty Cycle: 1:2.7; Conv.F=5.94;  
Frequency: 848.8 MHz; Medium parameters used:  $f = 835$  MHz;  $\sigma = 0.96$  mho/m;  $\epsilon_r = 53.69$ ;  $\rho = 1000$  kg/m<sup>3</sup> ;  
Phantom section: Flat Section  
Ambient temperature (°C): 21.8, Liquid temperature (°C): 20.9

SATIMO Configuration:

- Probe: SSE5; Calibrated: 12/05/2016; Serial No.: SN 14/16 EP308
- Sensor-Surface: 4mm (Mechanical Surface Detection)
- Phantom: SAM twin phantom
- Measurement SW: OpenSAR V4\_02\_32

**Configuration/GPRS 850 High-Body-Back/Area Scan:** Measurement grid: dx=10mm, dy=10mm

**Configuration/GPRS 850 High-Body-Back/Zoom Scan:** Measurement grid: dx=8mm,dy=8mm, dz=5mm;

<b>Area Scan</b>	surf_sam_plan.txt
<b>Zoom Scan</b>	5x5x7,dx=8mm dy=8mm dz=5mm,Complete
<b>Phantom</b>	Validation plane
<b>Device Position</b>	Body Back
<b>Band</b>	GSM 850
<b>Channels</b>	High
<b>Signal</b>	TDMA (Crest factor: 2.7)

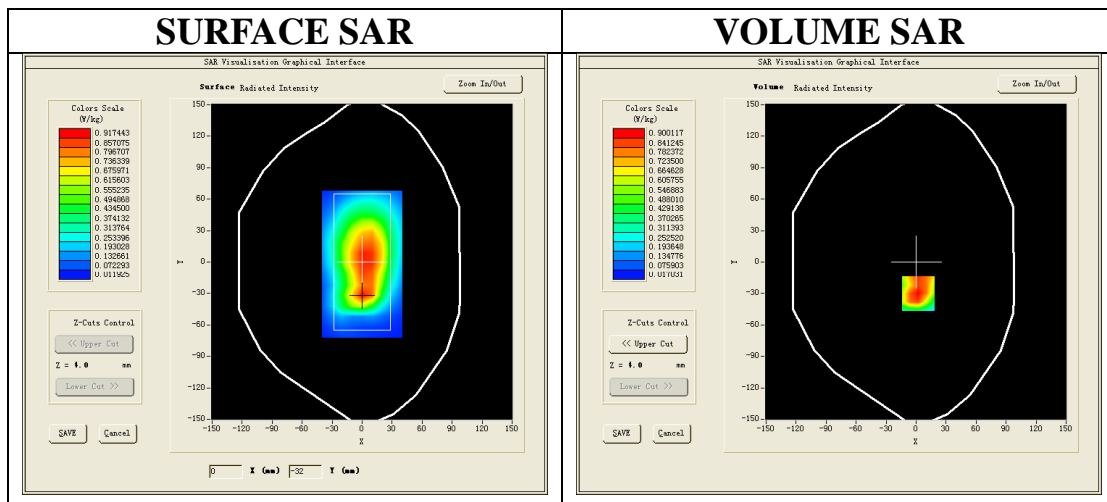

**Maximum location: X=2.00, Y=-30.00**

**SAR Peak: 1.46 W/kg**

<b>SAR 10g (W/Kg)</b>	0.532780
<b>SAR 1g (W/Kg)</b>	0.897498

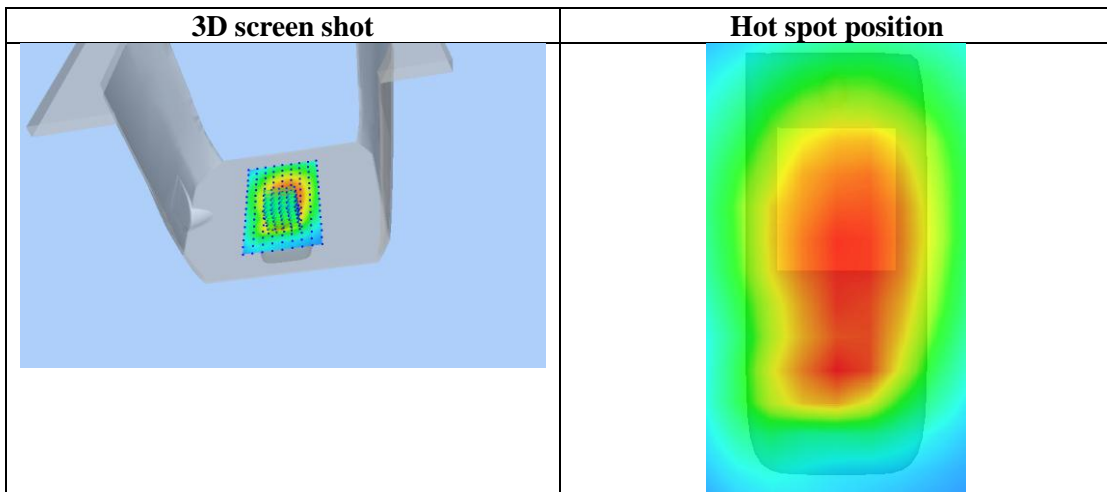
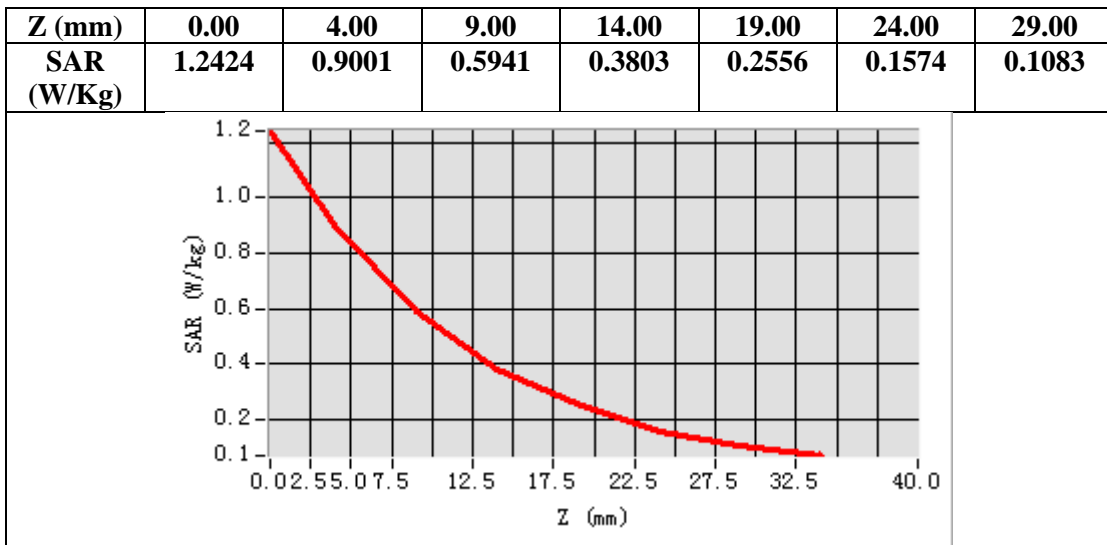

Test Laboratory: AGC Lab  
GSM 850 Mid-Touch-Right <SIM 2>  
DUT: GSM MOBILE PHONE; Type: C5

Date: May 25,2017

Communication System: Generic GSM; Communication System Band: GSM 850; Duty Cycle: 1:8.3; Conv.F=5.72;  
Frequency: 836.6 MHz; Medium parameters used:  $f = 835$  MHz;  $\sigma = 0.91$  mho/m;  $\epsilon_r = 41.48$ ;  $\rho = 1000$  kg/m<sup>3</sup> ;  
Phantom section: Right Section  
Ambient temperature (°C): 21.8, Liquid temperature (°C): 21.0

SATIMO Configuration:

- Probe: SSE5; Calibrated: 12/05/2016; Serial No.: SN 14/16 EP308
- Sensor-Surface: 4mm (Mechanical Surface Detection)
- Phantom: SAM twin phantom
- Measurement SW: OpenSAR V4\_02\_32

Configuration/GSM 850 Mid-Touch-Right/Area Scan: Measurement grid: dx=8mm, dy=8mm

Configuration/GSM 850 Mid-Touch-Right/Zoom Scan: Measurement grid: dx=8mm,dy=8mm, dz=5mm

Area Scan	sam_direct_droit2_surf8mm.txt
ZoomScan	5x5x7,dx=8mm dy=8mm dz=5mm,Complete
Phantom	Right head
Device Position	Cheek
Band	GSM 850
Channels	Middle
Signal	TDMA (Crest factor: 8.0)

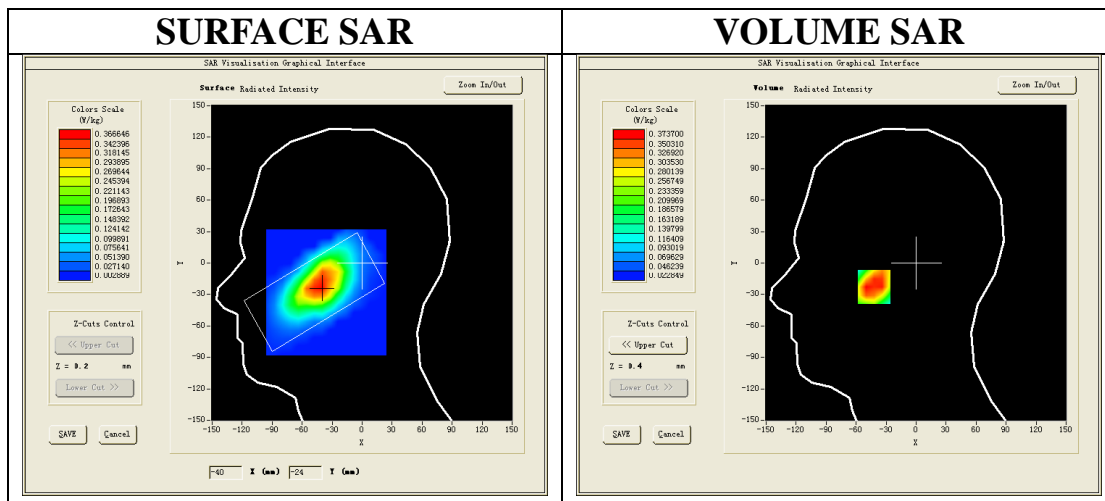

Maximum location: X=-42.00, Y=-23.00

SAR Peak: 0.52 W/kg

SAR 10g (W/Kg)	0.244910
SAR 1g (W/Kg)	0.360480

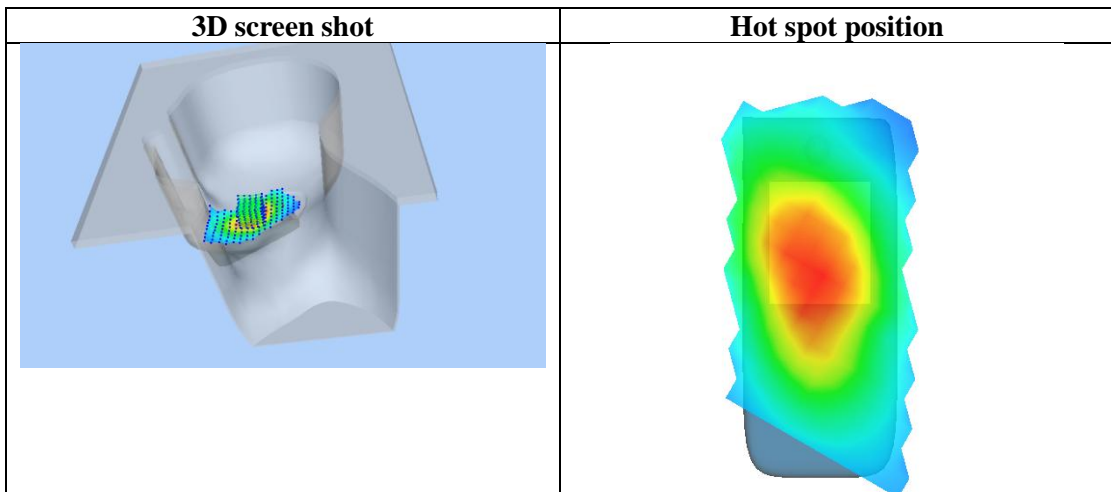
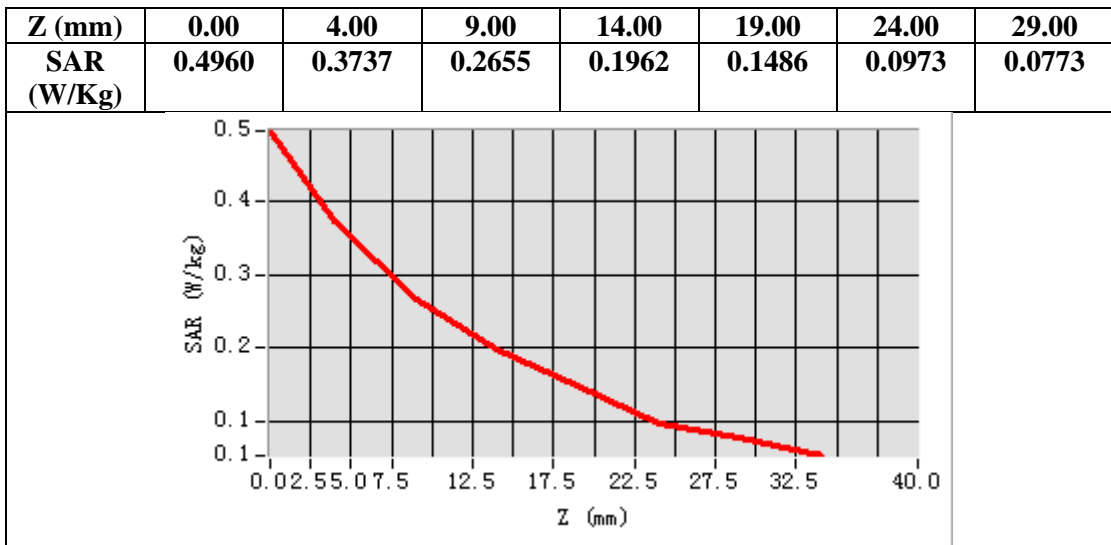

Test Laboratory: AGC Lab  
GSM 850 High- Body- Back (MS)<SIM 2>  
DUT: GSM MOBILE PHONE; Type: C5

Date: May 25,2017

Communication System: Generic GSM; Communication System Band: GSM 850; Duty Cycle: 1:8.3; Conv.F=5.94;  
Frequency: 848.8 MHz; Medium parameters used:  $f = 835$  MHz;  $\sigma = 0.96$  mho/m;  $\epsilon_r = 53.69$ ;  $\rho = 1000$  kg/m<sup>3</sup> ;  
Phantom section: Flat Section  
Ambient temperature (°C): 21.8, Liquid temperature (°C): 20.9

SATIMO Configuration:

- Probe: SSE5; Calibrated: 12/05/2016; Serial No.: SN 14/16 EP308
- Sensor-Surface: 4mm (Mechanical Surface Detection)
- Phantom: SAM twin phantom
- Measurement SW: OpenSAR V4\_02\_32

Configuration/GSM 850 High-Body-Back/Area Scan: Measurement grid: dx=10mm, dy=10mm

Configuration/GSM 850 High-Body-Back/Zoom Scan: Measurement grid: dx=8mm,dy=8mm, dz=5mm;

Area Scan	surf_sam_plan.txt
ZoomScan	5x5x7,dx=8mm dy=8mm dz=5mm,Complete
Phantom	Validation plane
Device Position	Body Back
Band	GSM 850
Channels	High
Signal	TDMA (Crest factor: 8.0)

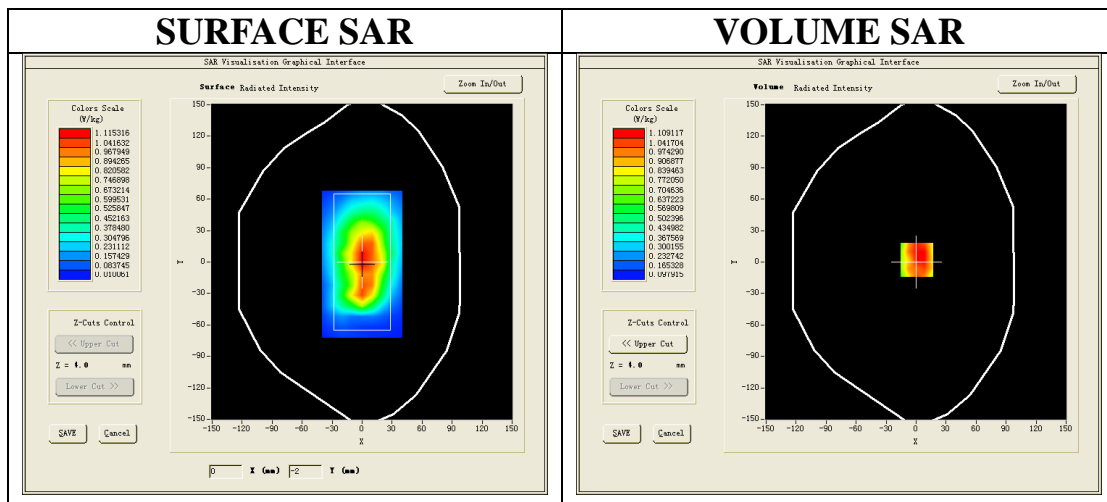

Maximum location: X=1.00, Y=2.00

SAR Peak: 1.69 W/kg

SAR 10g (W/Kg)	0.736097
SAR 1g (W/Kg)	1.111792

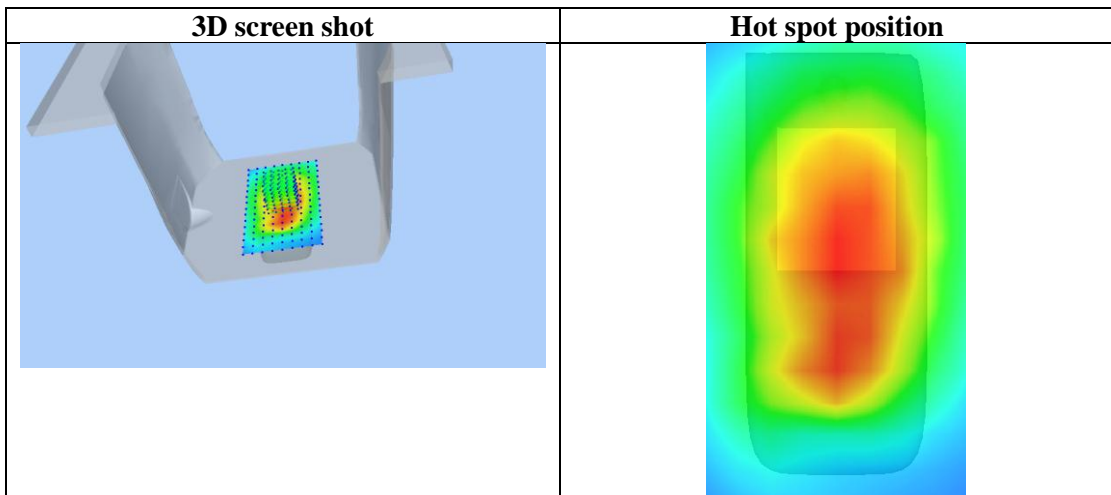
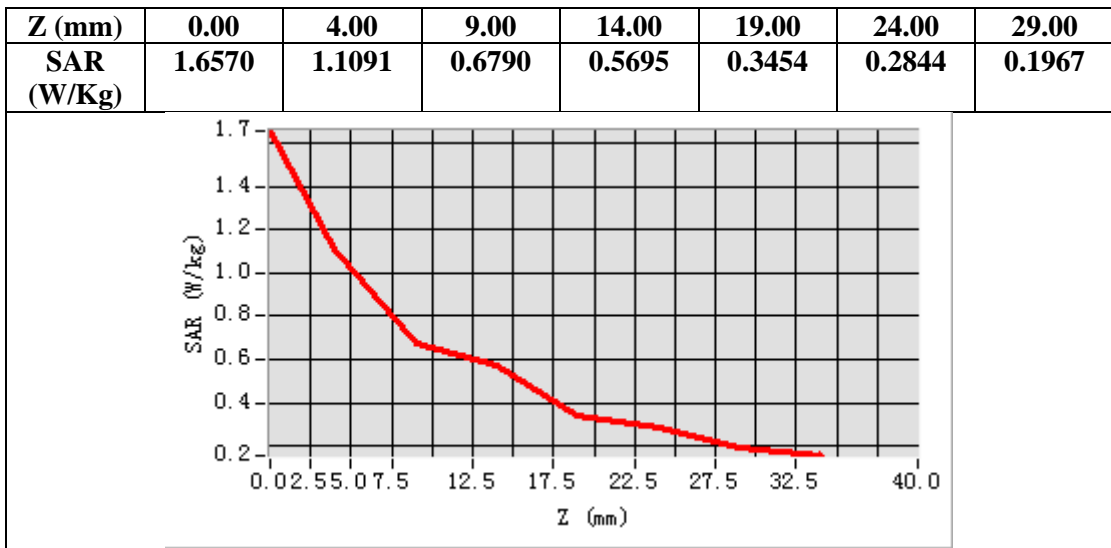

Test Laboratory: AGC Lab  
PCS 1900 Mid-Touch-Right <SIM 1>  
DUT: GSM MOBILE PHONE; Type: C5

Date: May 24,2017

Communication System: Generic GSM; Communication System Band: PCS 1900; Duty Cycle: 1:8.3; Conv.F=5.14;  
Frequency: 1880 MHz; Medium parameters used:  $f = 1900$  MHz;  $\sigma = 1.38$  mho/m;  $\epsilon_r = 40.25$ ;  $\rho = 1000$  kg/m<sup>3</sup> ;  
Phantom section: Right Section  
Ambient temperature (°C): 22.0, Liquid temperature (°C): 21.2

SATIMO Configuration:

- Probe: SSE5; Calibrated: 07/05/2016; Serial No.: SN 14/16 EP307
- Sensor-Surface: 4mm (Mechanical Surface Detection)
- Phantom: SAM twin phantom
- Measurement SW: OpenSAR V4\_02\_35

Configuration/PCS1900 Mid-Touch-Right/Area Scan: Measurement grid: dx=8mm, dy=8mm

Configuration/PCS1900 Mid-Touch-Right/Zoom Scan: Measurement grid: dx=8mm,dy=8mm, dz=5mm;

Area Scan	sam_direct_droit2_surf8mm.txt
ZoomScan	5x5x7,dx=8mm dy=8mm dz=5mm,Complete
Phantom	Right head
Device Position	Cheek
Band	PCS 1900
Channels	Middle
Signal	TDMA (Crest factor: 8.0)

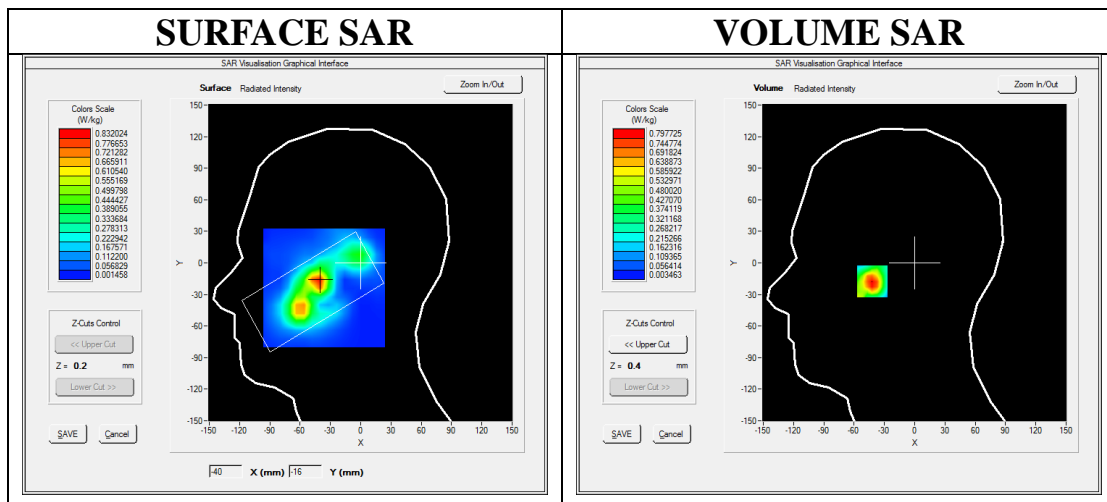

Maximum location: X=-42.00, Y=-17.00

SAR Peak: 1.16 W/kg

SAR 10g (W/Kg)	0.393006
SAR 1g (W/Kg)	0.734261



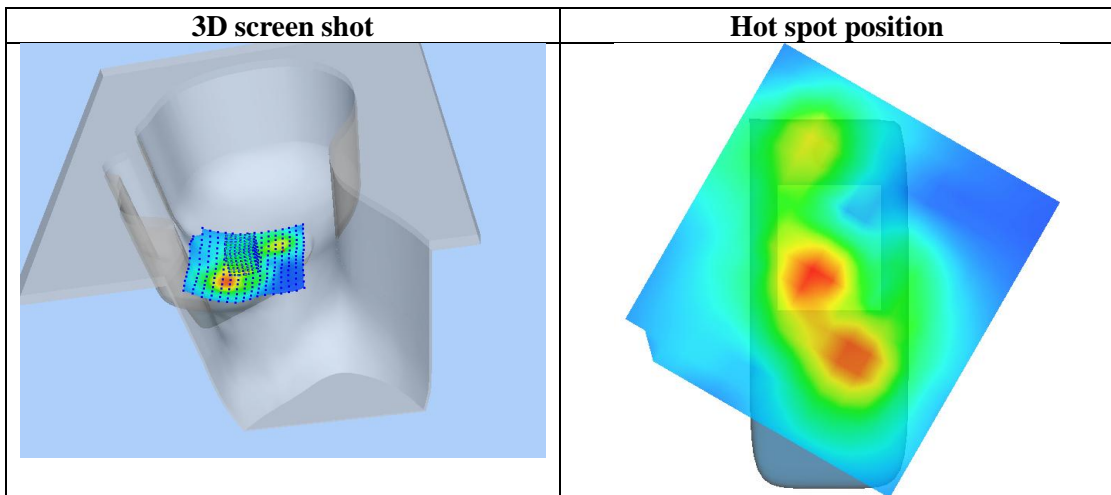
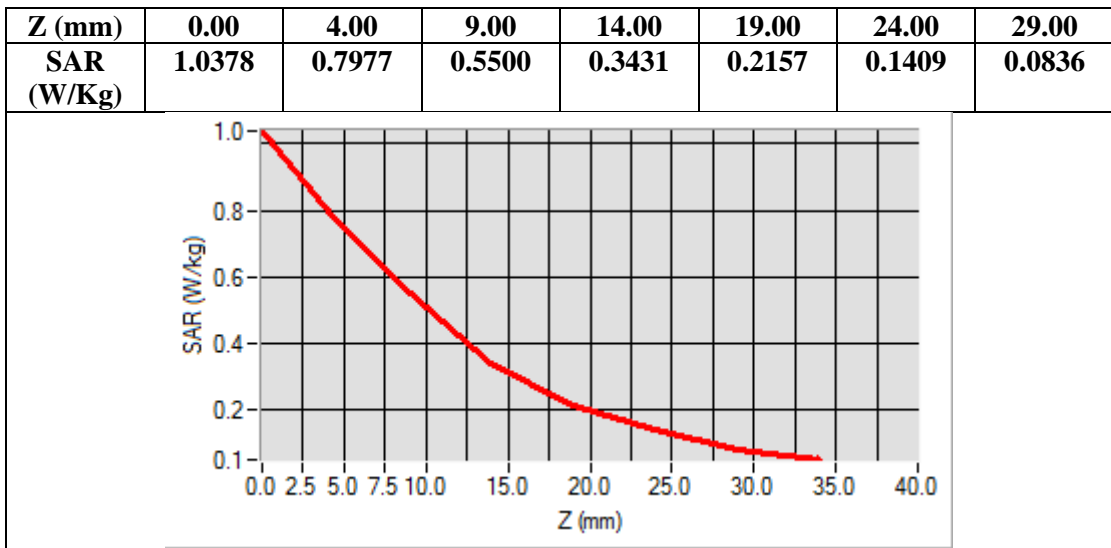

Test Laboratory: AGC Lab  
PCS 1900 Mid-Body-Back (MS)<SIM 1>  
DUT: GSM MOBILE PHONE; Type: C5

Date: May 24,2017

Communication System: Generic GSM; Communication System Band: PCS 1900; Duty Cycle: 1:8.3; Conv.F=5.34;  
Frequency: 1880 MHz; Medium parameters used:  $f = 1900$  MHz;  $\sigma = 1.50$  mho/m;  $\epsilon_r = 53.13$ ;  $\rho = 1000$  kg/m<sup>3</sup> ;  
Phantom section: Flat Section  
Ambient temperature (°C): 22.0, Liquid temperature (°C): 21.0

SATIMO Configuration:

- Probe: SSE5; Calibrated: 07/05/2016; Serial No.: SN 14/16 EP307
- Sensor-Surface: 4mm (Mechanical Surface Detection)
- Phantom: SAM twin phantom
- Measurement SW: OpenSAR V4\_02\_35

Configuration/PCS1900 Mid-Body-Back/Area Scan: Measurement grid: dx=10mm, dy=10mm  
Configuration/PCS1900 Mid-Body-Back/Zoom Scan: Measurement grid: dx=8mm,dy=8mm, dz=5mm;

Area Scan	surf_sam_plan.txt
ZoomScan	5x5x7,dx=8mm dy=8mm dz=5mm,Complete
Phantom	Validation plane
Device Position	Body Back
Band	PCS 1900
Channels	Middle
Signal	TDMA (Crest factor: 8.0)

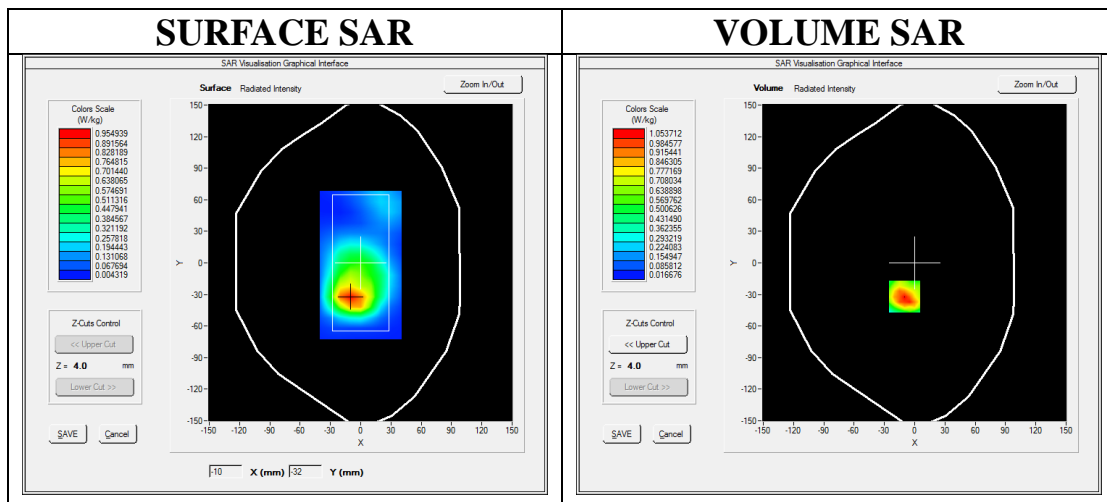

Maximum location: X=-10.00, Y=-32.00  
SAR Peak: 1.69 W/kg

SAR 10g (W/Kg)	0.509150
SAR 1g (W/Kg)	0.956053

Z (mm)	0.00	4.00	9.00	14.00	19.00	24.00	29.00
SAR (W/Kg)	1.6446	1.0537	0.5877	0.3273	0.1902	0.1040	0.0649

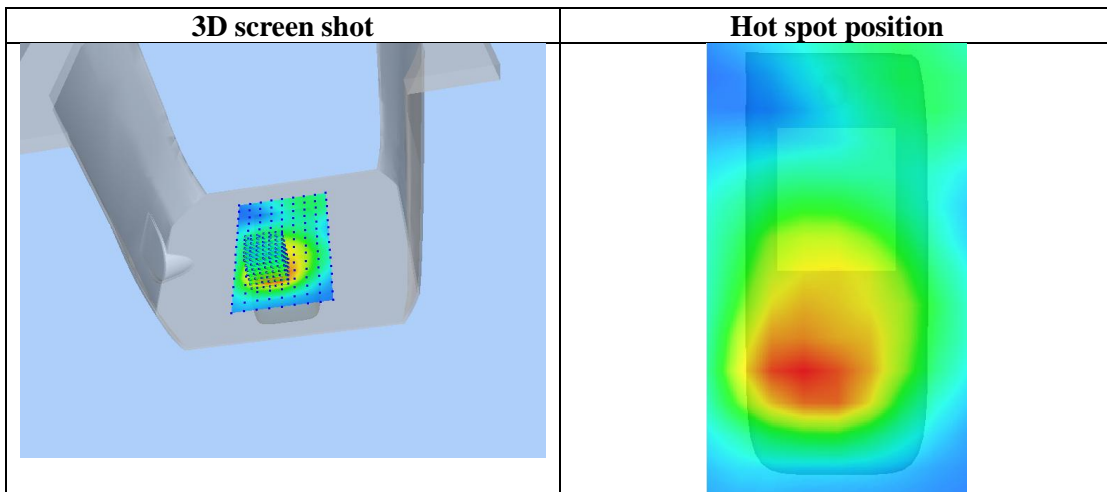
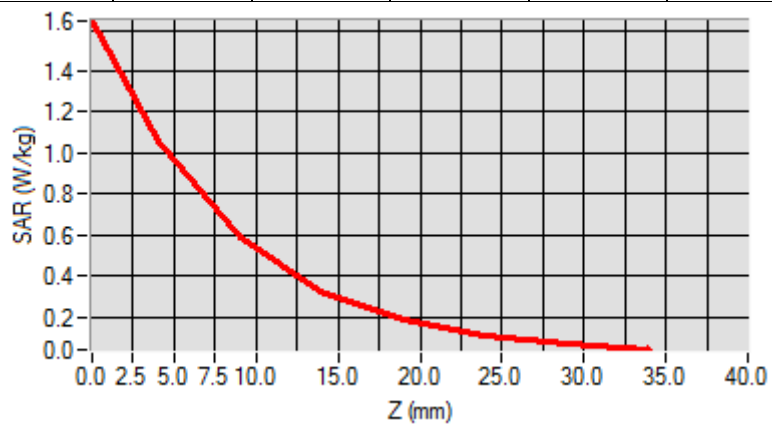

Test Laboratory: AGC Lab  
GPRS1900 Mid-Touch-Right (4up)  
DUT: GSM MOBILE PHONE; Type: C5

Date: May 24,2017

Communication System: GPRS-4Slot; Communication System Band: PCS 1900; Duty Cycle: 1:2.1; Conv.F=5.14;  
Frequency: 1880 MHz; Medium parameters used:  $f = 1900$  MHz;  $\sigma = 1.38$  mho/m;  $\epsilon_r = 40.25$ ;  $\rho = 1000$  kg/m<sup>3</sup> ;  
Phantom section: Right Section  
Ambient temperature (°C): 22.0, Liquid temperature (°C): 21.2

SATIMO Configuration:

- Probe: SSE5; Calibrated: 07/05/2016; Serial No.: SN 14/16 EP307
- Sensor-Surface: 4mm (Mechanical Surface Detection)
- Phantom: SAM twin phantom
- Measurement SW: OpenSAR V4\_02\_35

Configuration/GPRS1900 Mid-Touch-Right/Area Scan: Measurement grid: dx=8mm, dy=8mm

Configuration/GPRS1900 Mid-Touch-Right/Zoom Scan: Measurement grid: dx=8mm,dy=8mm, dz=5mm;

Area Scan	sam_direct_droit2_surf8mm.txt
Zoom Scan	5x5x7,dx=8mm dy=8mm dz=5mm,Complete
Phantom	Right head
Device Position	Cheek
Band	PCS 1900
Channels	Middle
Signal	TDMA (Crest factor: 2.0)

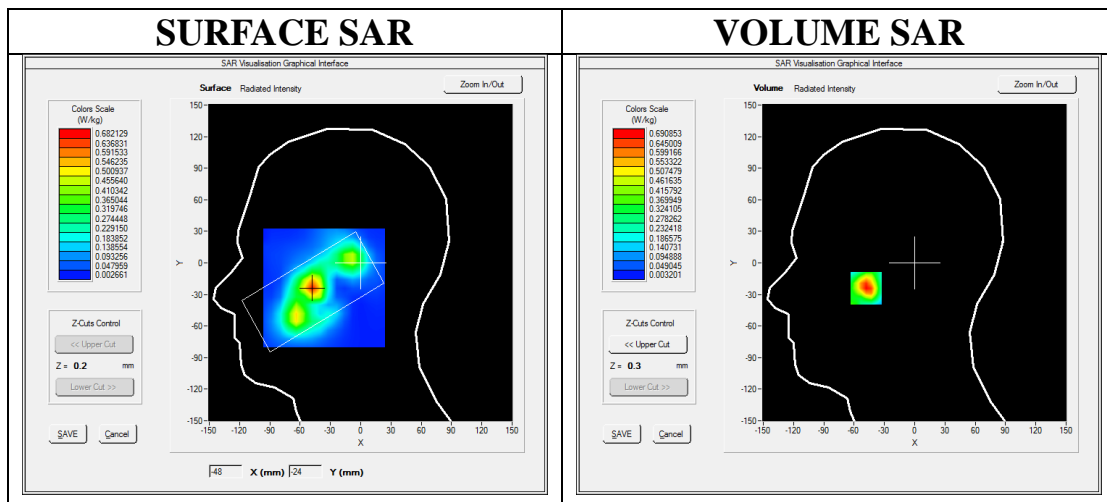

Maximum location: X=-48.00, Y=-24.00

SAR Peak: 0.95 W/kg

SAR 10g (W/Kg)	0.336001
SAR 1g (W/Kg)	0.619740

Z (mm)	0.00	4.00	9.00	14.00	19.00	24.00	29.00
SAR (W/Kg)	0.9346	0.6909	0.4621	0.2935	0.1931	0.1159	0.0778

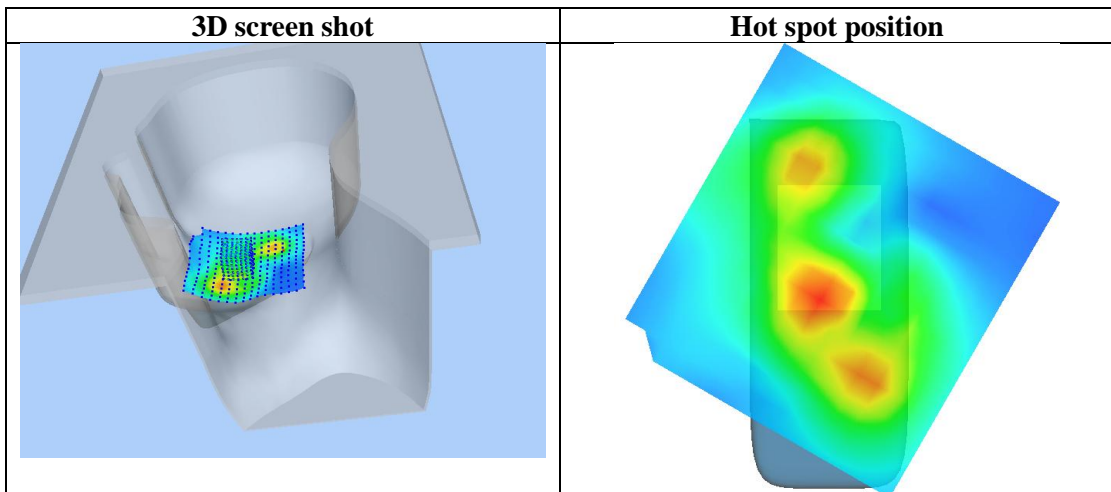
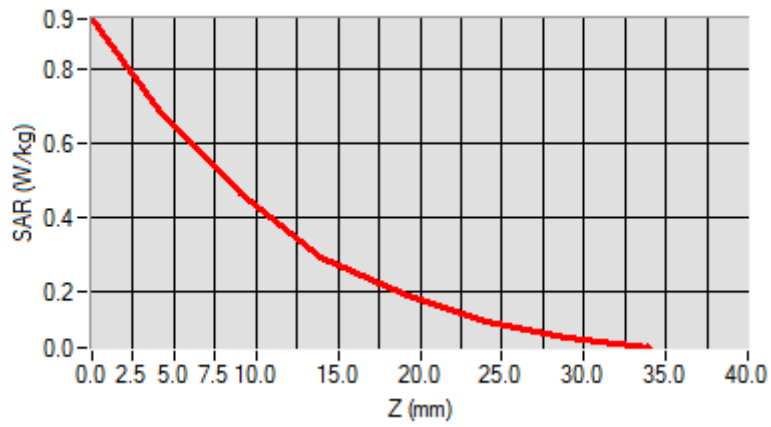

Test Laboratory: AGC Lab  
GPRS 1900 Low-Body-Back (4up)  
DUT: GSM MOBILE PHONE; Type: C5

Date: May 24,2017

Communication System: GPRS-4Slot; Communication System Band: PCS 1900; Duty Cycle: 1:2.1; Conv.F=5.34;  
Frequency: 1850.2 MHz; Medium parameters used:  $f = 1900$  MHz;  $\sigma = 1.46$  mho/m;  $\epsilon_r = 54.36$ ;  $\rho = 1000$  kg/m<sup>3</sup> ;  
Phantom section: Flat Section  
Ambient temperature (°C): 22.0, Liquid temperature (°C): 21.0

SATIMO Configuration:

- Probe: SSE5; Calibrated: 07/05/2016; Serial No.: SN 14/16 EP307
- Sensor-Surface: 4mm (Mechanical Surface Detection)
- Phantom: SAM twin phantom
- Measurement SW: OpenSAR V4\_02\_35

Configuration/GPRS1900 Low-Body-Back/Area Scan: Measurement grid: dx=10mm, dy=10mm  
Configuration/GPRS1900 Low-Body-Back/Zoom Scan: Measurement grid: dx=8mm,dy=8mm, dz=5mm;

Area Scan	surf_sam_plan.txt
Zoom Scan	5x5x7,dx=8mm dy=8mm dz=5mm,Complete
Phantom	Validation plane
Device Position	Body Back
Band	PCS 1900
Channels	Low
Signal	TDMA (Crest factor: 2.0)

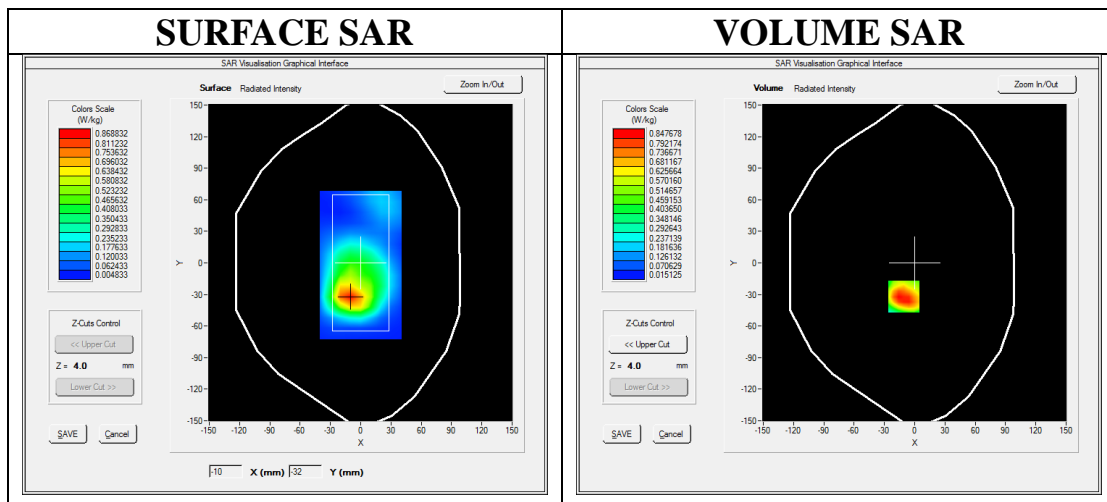

Maximum location: X=-11.00, Y=-32.00  
SAR Peak: 1.37 W/kg

SAR 10g (W/Kg)	0.431761
SAR 1g (W/Kg)	0.803017

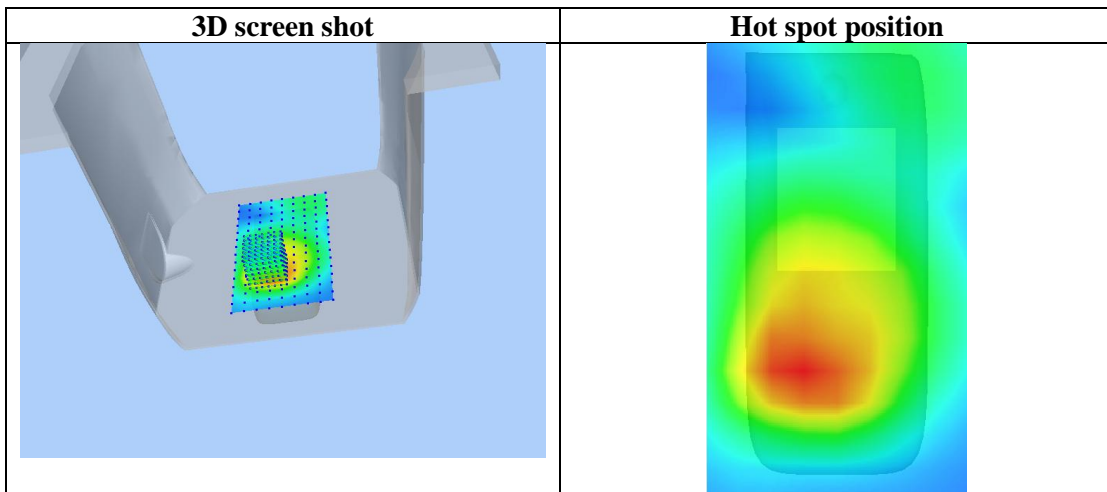
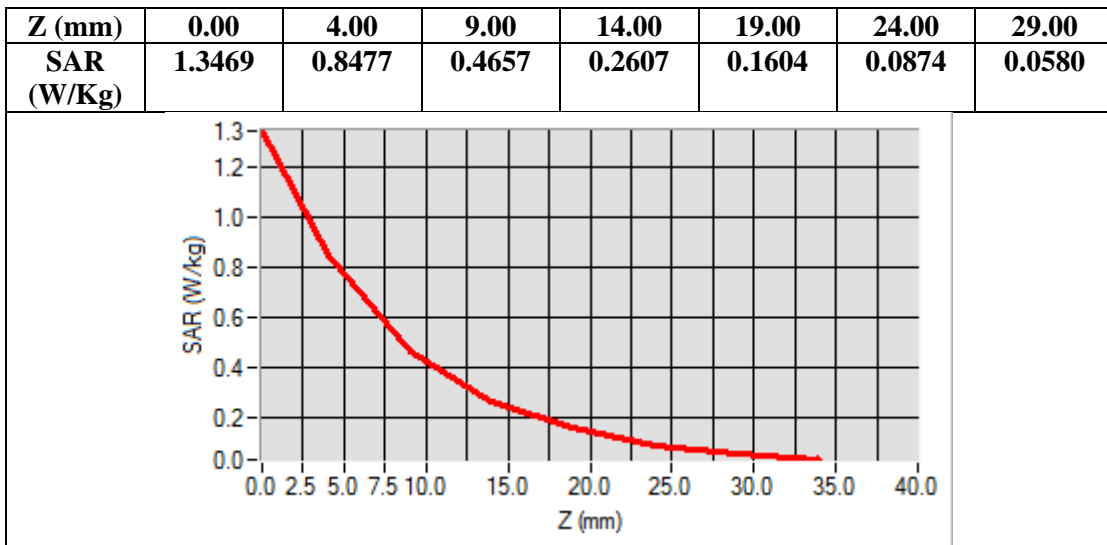

Test Laboratory: AGC Lab  
PCS 1900 Mid-Touch-Right <SIM 2>  
DUT: GSM MOBILE PHONE; Type: C5

Date: May 24,2017

Communication System: Generic GSM; Communication System Band: PCS 1900; Duty Cycle: 1:8.3; Conv.F=5.14;  
Frequency: 1880 MHz; Medium parameters used:  $f = 1900$  MHz;  $\sigma = 1.38$  mho/m;  $\epsilon_r = 40.25$ ;  $\rho = 1000$  kg/m<sup>3</sup> ;  
Phantom section: Right Section  
Ambient temperature (°C): 22.0, Liquid temperature (°C): 21.2

SATIMO Configuration:

- Probe: SSE5; Calibrated: 07/05/2016; Serial No.: SN 14/16 EP307
- Sensor-Surface: 4mm (Mechanical Surface Detection)
- Phantom: SAM twin phantom
- Measurement SW: OpenSAR V4\_02\_35

Configuration/PCS1900 Mid-Touch-Right/Area Scan: Measurement grid: dx=8mm, dy=8mm

Configuration/PCS1900 Mid-Touch-Right/Zoom Scan: Measurement grid: dx=8mm,dy=8mm, dz=5mm;

Area Scan	sam_direct_droit2_surf8mm.txt
ZoomScan	5x5x7,dx=8mm dy=8mm dz=5mm,Complete
Phantom	Right head
Device Position	Cheek
Band	PCS 1900
Channels	Middle
Signal	TDMA (Crest factor: 8.0)

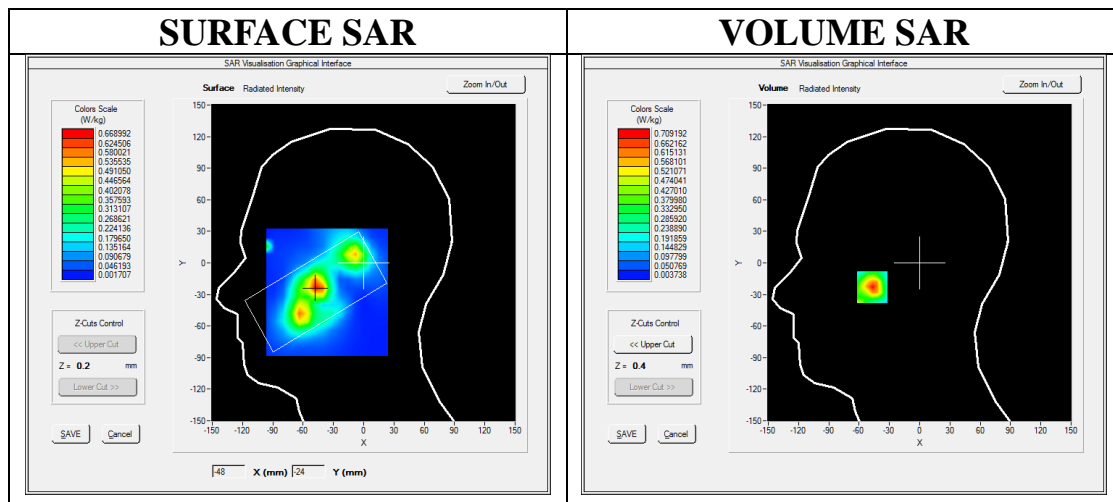

Maximum location: X=-47.00, Y=-23.00

SAR Peak: 1.09 W/kg

SAR 10g (W/Kg)	0.332366
SAR 1g (W/Kg)	0.626042



<b>Z (mm)</b>	<b>0.00</b>	<b>4.00</b>	<b>9.00</b>	<b>14.00</b>	<b>19.00</b>	<b>24.00</b>	<b>29.00</b>
<b>SAR (W/Kg)</b>	<b>1.1075</b>	<b>0.7092</b>	<b>0.4216</b>	<b>0.2732</b>	<b>0.1952</b>	<b>0.1198</b>	<b>0.0778</b>

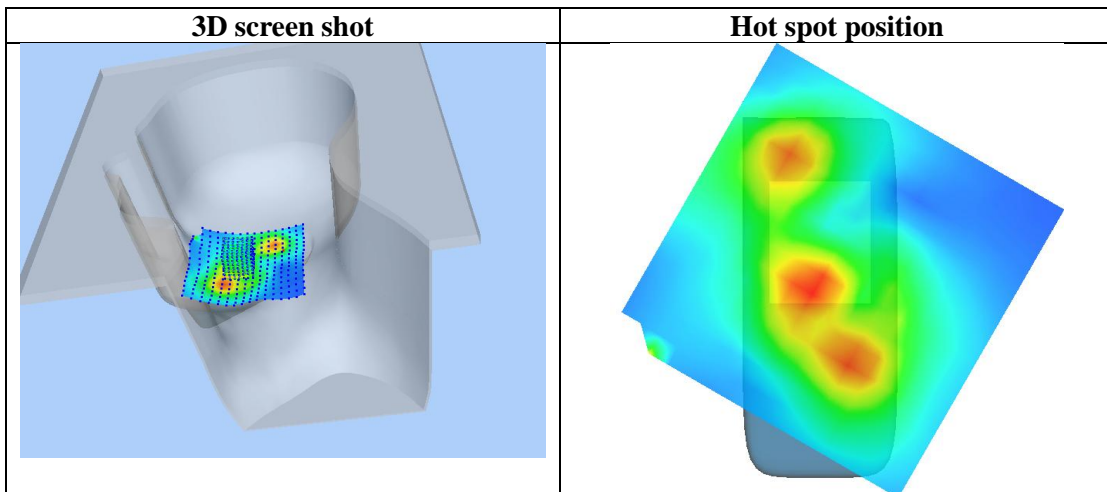
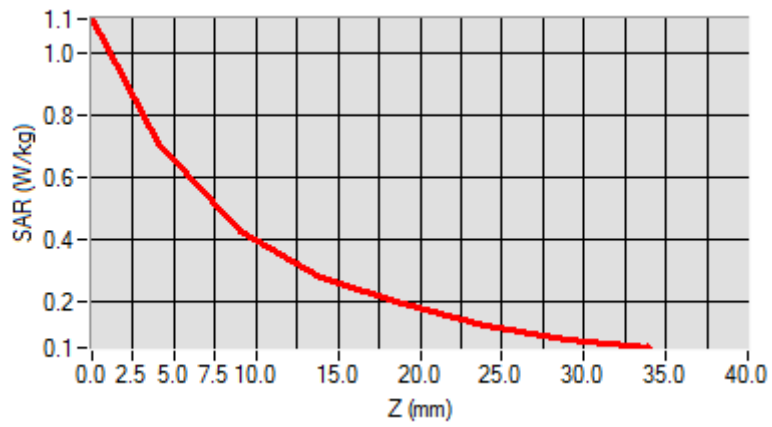

Test Laboratory: AGC Lab  
PCS 1900 Mid-Body-Back (MS)<SIM 2>  
DUT: GSM MOBILE PHONE; Type: C5

Date: May 24,2017

Communication System: Generic GSM; Communication System Band: PCS 1900; Duty Cycle: 1:8.3; Conv.F=5.34;  
Frequency: 1880 MHz; Medium parameters used:  $f = 1900$  MHz;  $\sigma = 1.50$  mho/m;  $\epsilon_r = 53.13$ ;  $\rho = 1000$  kg/m<sup>3</sup> ;  
Phantom section: Flat Section  
Ambient temperature (°C): 22.0, Liquid temperature (°C): 21.0

SATIMO Configuration:

- Probe: SSE5; Calibrated: 07/05/2016; Serial No.: SN 14/16 EP307
- Sensor-Surface: 4mm (Mechanical Surface Detection)
- Phantom: SAM twin phantom
- Measurement SW: OpenSAR V4\_02\_35

Configuration/PCS1900 Mid-Body-Back/Area Scan: Measurement grid: dx=10mm, dy=10mm  
Configuration/PCS1900 Mid-Body-Back/Zoom Scan: Measurement grid: dx=8mm,dy=8mm, dz=5mm;

Area Scan	surf_sam_plan.txt
ZoomScan	5x5x7,dx=8mm dy=8mm dz=5mm,Complete
Phantom	Validation plane
Device Position	Body Back
Band	PCS 1900
Channels	Middle
Signal	TDMA (Crest factor: 8.0)

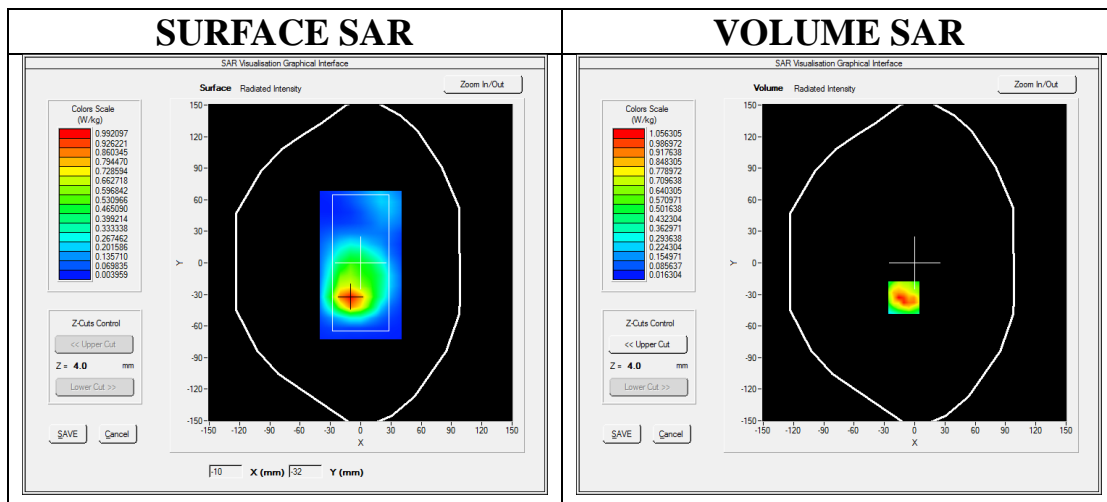

Maximum location: X=-11.00, Y=-33.00  
SAR Peak: 1.80 W/kg

SAR 10g (W/Kg)	0.499492
SAR 1g (W/Kg)	0.942425

Z (mm)	0.00	4.00	9.00	14.00	19.00	24.00	29.00
SAR (W/Kg)	1.7034	1.0563	0.5652	0.3071	0.1857	0.1003	0.0686

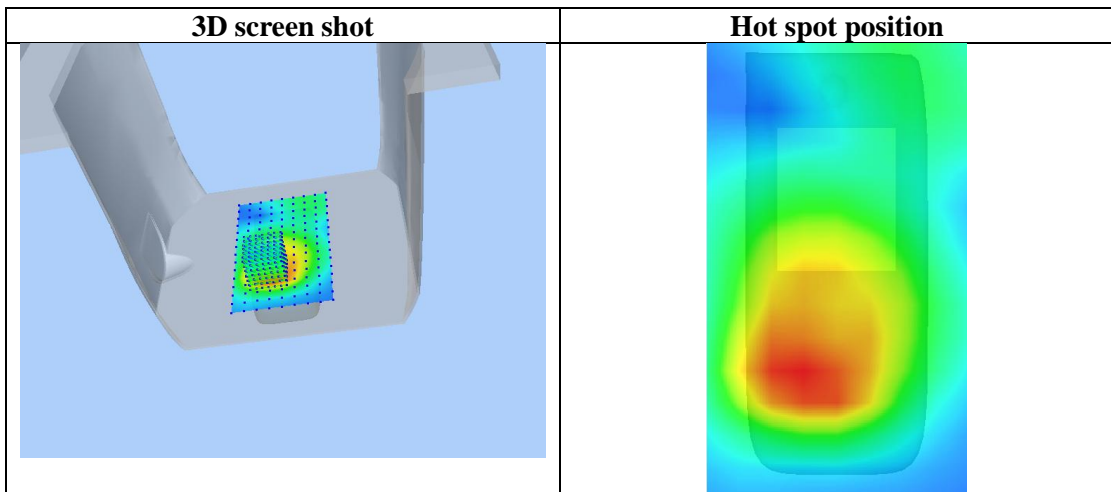
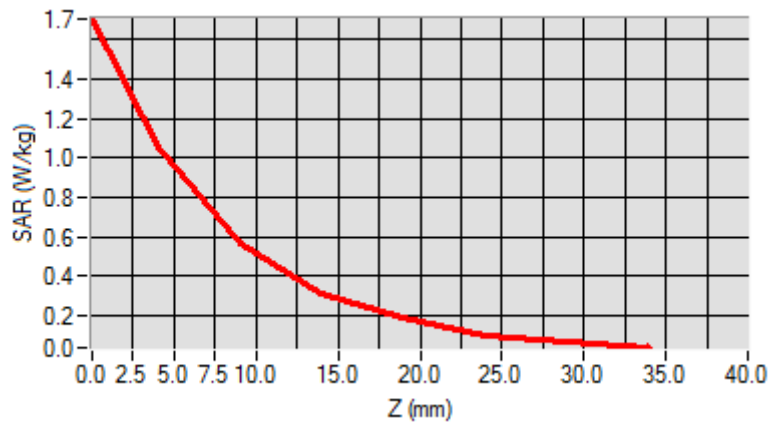

**Repeated SAR**

Test Laboratory: AGC Lab  
GSM 850 High- Body- Back (MS)<SIM 1>  
DUT: GSM MOBILE PHONE; Type: C5

Date: May 25,2017

Communication System: Generic GSM; Communication System Band: GSM 850; Duty Cycle: 1:8.3; Conv.F=5.94;  
Frequency: 848.8 MHz; Medium parameters used:  $f = 835$  MHz;  $\sigma = 0.96$  mho/m;  $\epsilon_r = 53.69$ ;  $\rho = 1000$  kg/m<sup>3</sup> ;  
Phantom section: Flat Section  
Ambient temperature (°C): 21.8, Liquid temperature (°C): 20.9

SATIMO Configuration:

- Probe: SSE5; Calibrated: 12/05/2016; Serial No.: SN 14/16 EP308
- Sensor-Surface: 4mm (Mechanical Surface Detection)
- Phantom: SAM twin phantom
- Measurement SW: OpenSAR V4\_02\_32

Configuration/GSM 850 High-Body-Back/Area Scan: Measurement grid: dx=10mm, dy=10mm  
Configuration/GSM 850 High-Body-Back/Zoom Scan: Measurement grid: dx=8mm,dy=8mm, dz=5mm;

Area Scan	surf_sam_plan.txt
ZoomScan	5x5x7,dx=8mm dy=8mm dz=5mm,Complete
Phantom	Validation plane
Device Position	Body Back
Band	GSM 850
Channels	High
Signal	TDMA (Crest factor: 8.0)

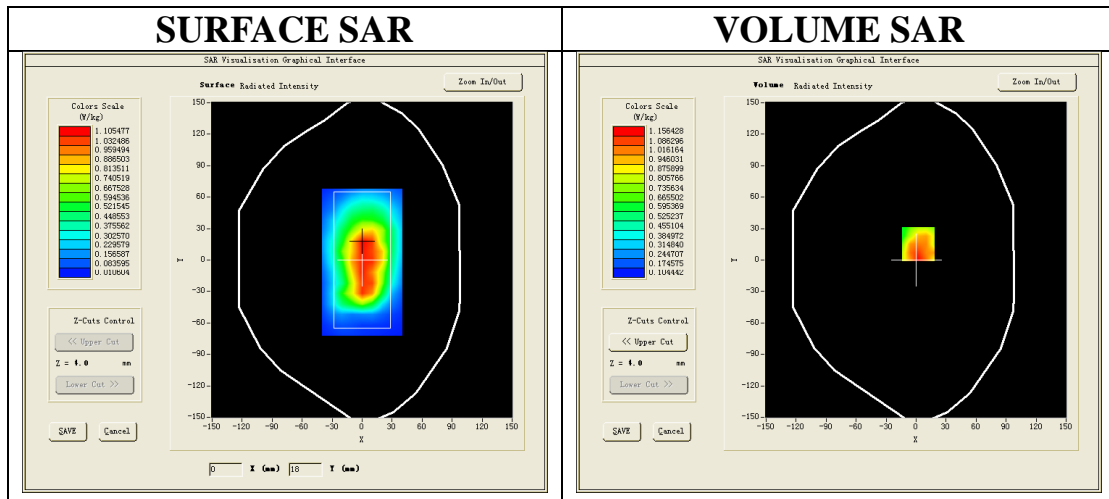

Maximum location: X=2.00, Y=15.00

SAR Peak: 1.54 W/kg

SAR 10g (W/Kg)	0.745785
SAR 1g (W/Kg)	1.079501

Z (mm)	0.00	4.00	9.00	14.00	19.00	24.00	29.00
SAR (W/Kg)	2.1496	1.1564	0.5666	0.5785	0.3597	0.3276	0.1828

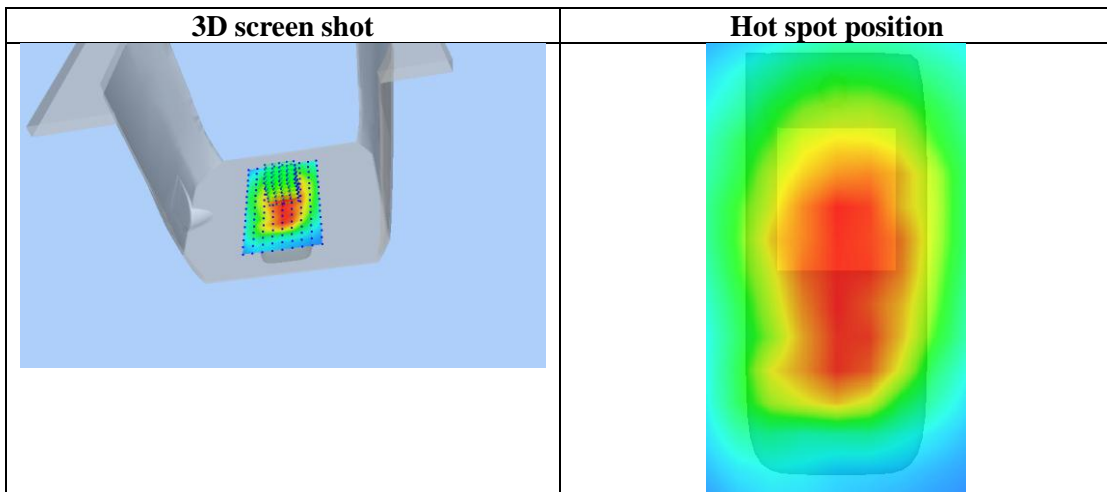
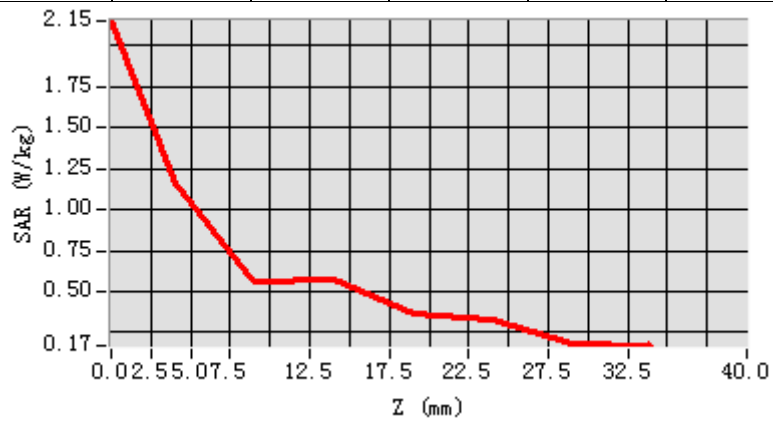

Test Laboratory: AGC Lab  
PCS 1900 Mid-Body-Back (MS)<SIM 1>  
DUT: GSM MOBILE PHONE; Type: C5

Date: May 24,2017

Communication System: Generic GSM; Communication System Band: PCS 1900; Duty Cycle: 1:8.3; Conv.F=5.34;  
Frequency: 1880 MHz; Medium parameters used:  $f = 1900$  MHz;  $\sigma = 1.50$  mho/m;  $\epsilon_r = 53.13$ ;  $\rho = 1000$  kg/m<sup>3</sup> ;  
Phantom section: Flat Section  
Ambient temperature (°C): 22.0, Liquid temperature (°C): 21.0

SATIMO Configuration:

- Probe: SSE5; Calibrated: 07/05/2016; Serial No.: SN 14/16 EP307
- Sensor-Surface: 4mm (Mechanical Surface Detection)
- Phantom: SAM twin phantom
- Measurement SW: OpenSAR V4\_02\_35

Configuration/PCS1900 Mid-Body-Back/Area Scan: Measurement grid: dx=10mm, dy=10mm  
Configuration/PCS1900 Mid-Body-Back/Zoom Scan: Measurement grid: dx=8mm,dy=8mm, dz=5mm;

Area Scan	surf_sam_plan.txt
ZoomScan	5x5x7,dx=8mm dy=8mm dz=5mm,Complete
Phantom	Validation plane
Device Position	Body Back
Band	PCS 1900
Channels	Middle
Signal	TDMA (Crest factor: 8.0)

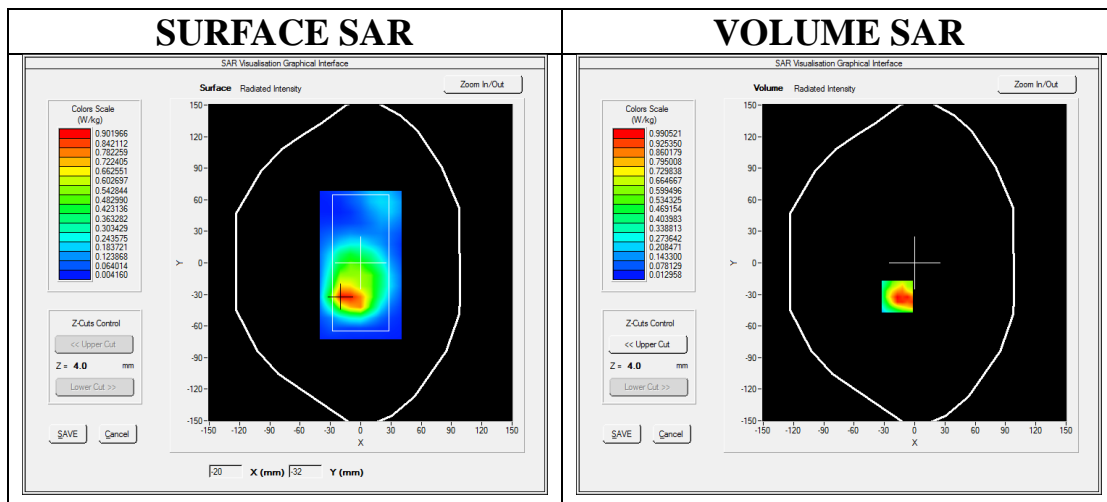

Maximum location: X=-17.00, Y=-32.00  
SAR Peak: 1.64 W/kg

SAR 10g (W/Kg)	0.479477
SAR 1g (W/Kg)	0.918949

<b>Z (mm)</b>	<b>0.00</b>	<b>4.00</b>	<b>9.00</b>	<b>14.00</b>	<b>19.00</b>	<b>24.00</b>	<b>29.00</b>
<b>SAR (W/Kg)</b>	<b>1.6187</b>	<b>0.9905</b>	<b>0.5263</b>	<b>0.2746</b>	<b>0.1673</b>	<b>0.1009</b>	<b>0.0580</b>

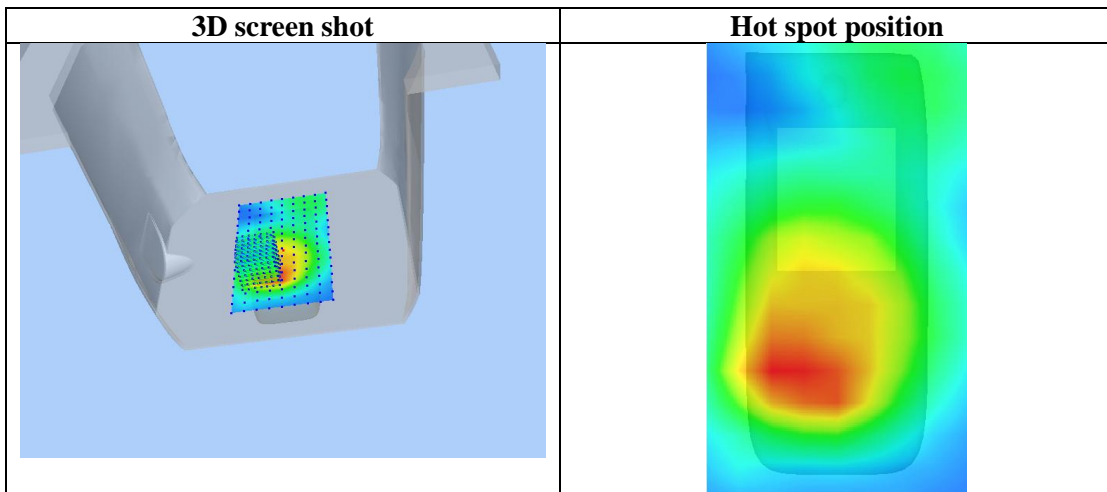
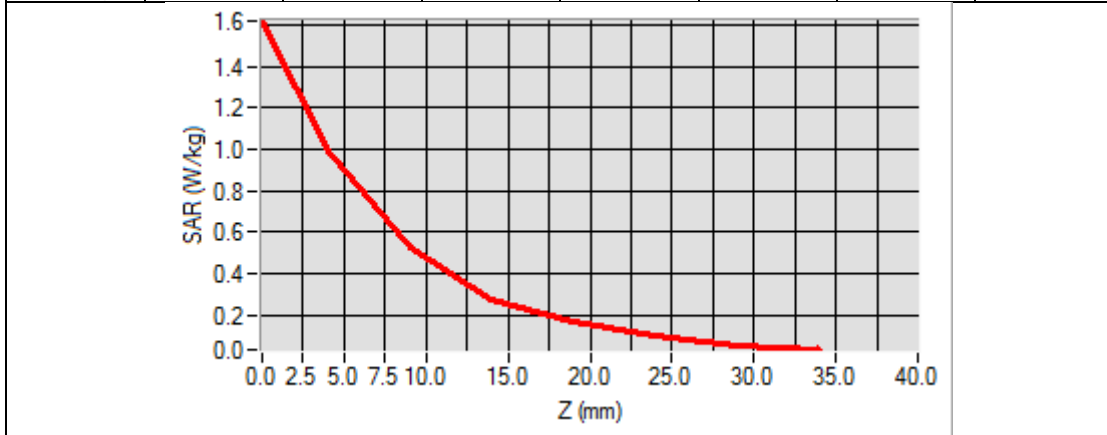

## APPENDIX C. TEST SETUP PHOTOGRAPHS

LEFT- CHEEK TOUCH

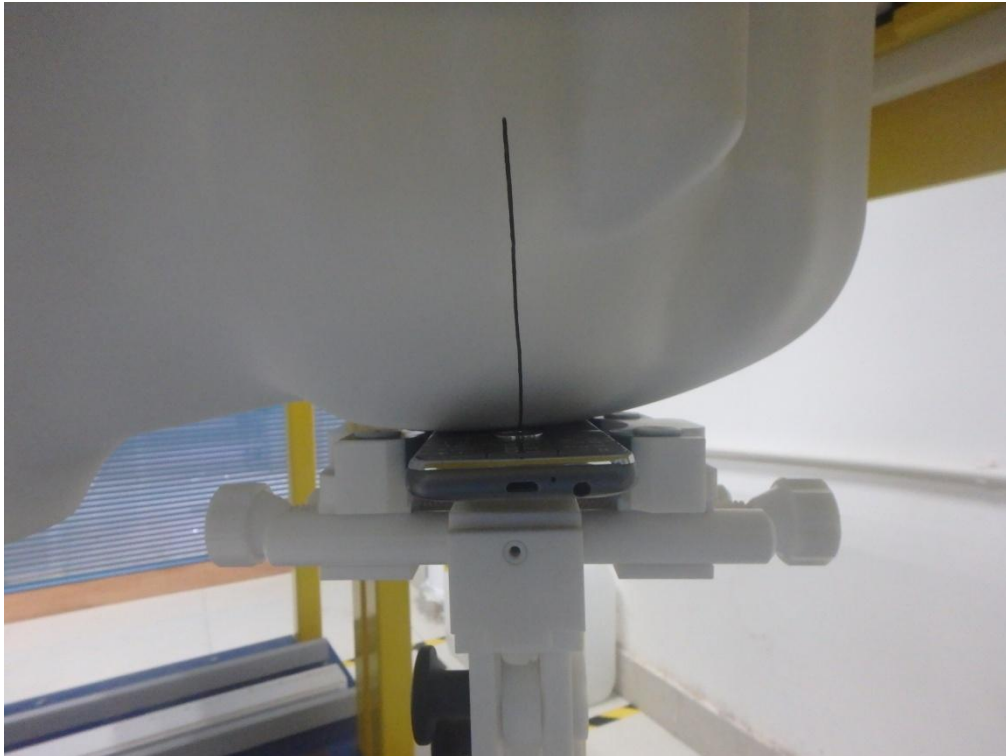

LEFT-TILT 15°

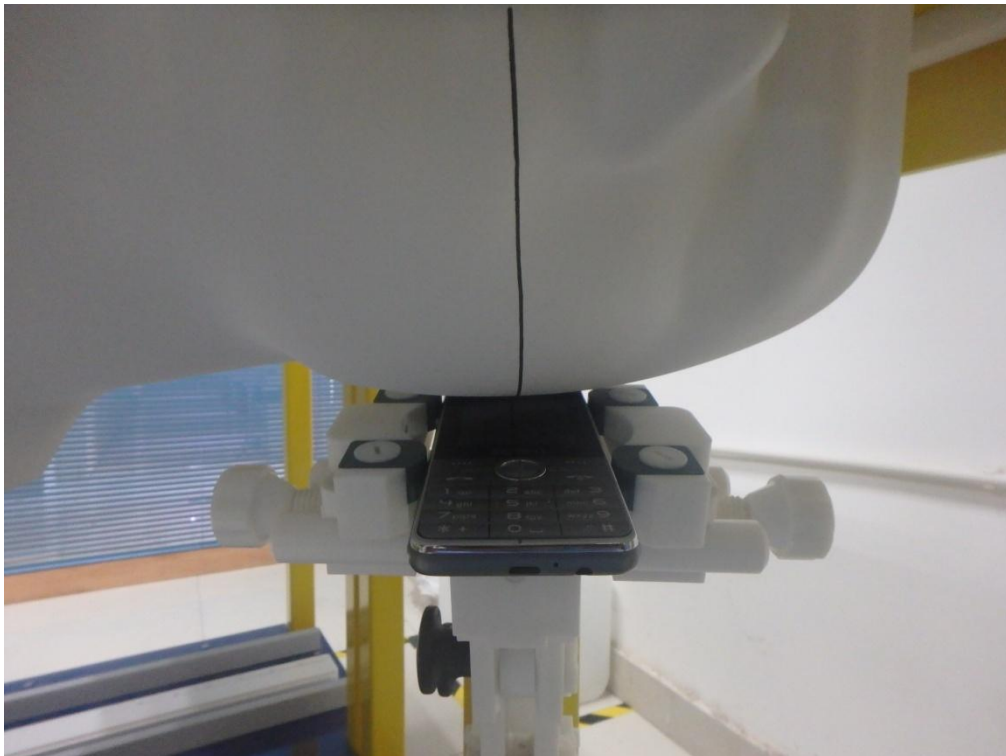



RIGHT- CHEEK TOUCH

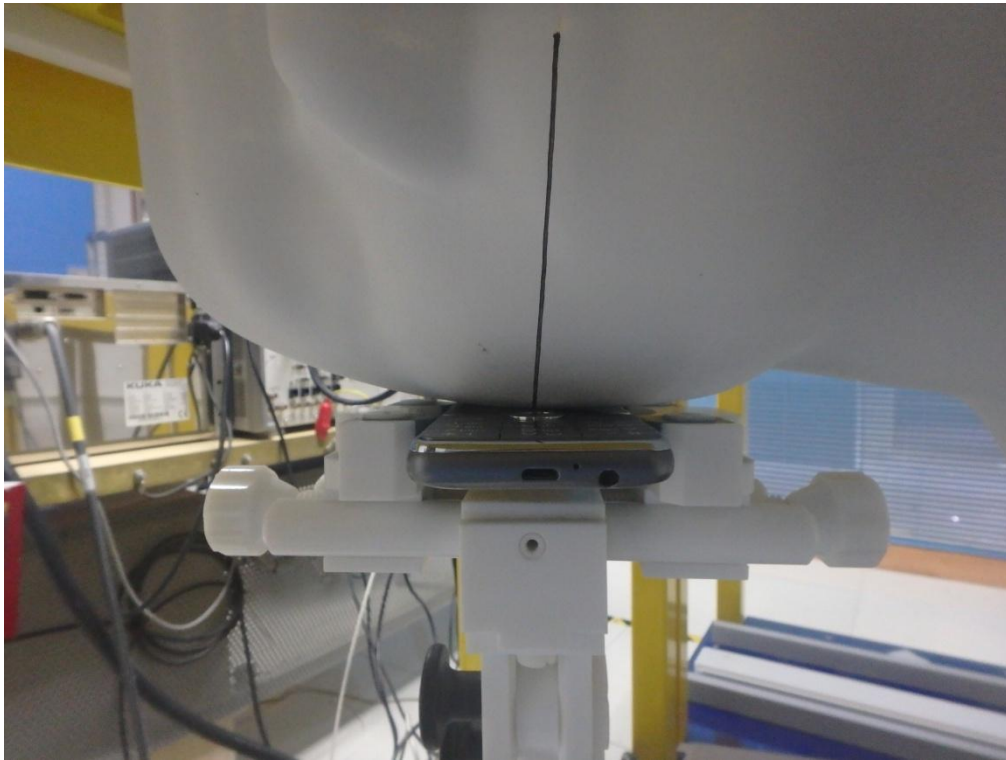

RIGHT-TILT 15°

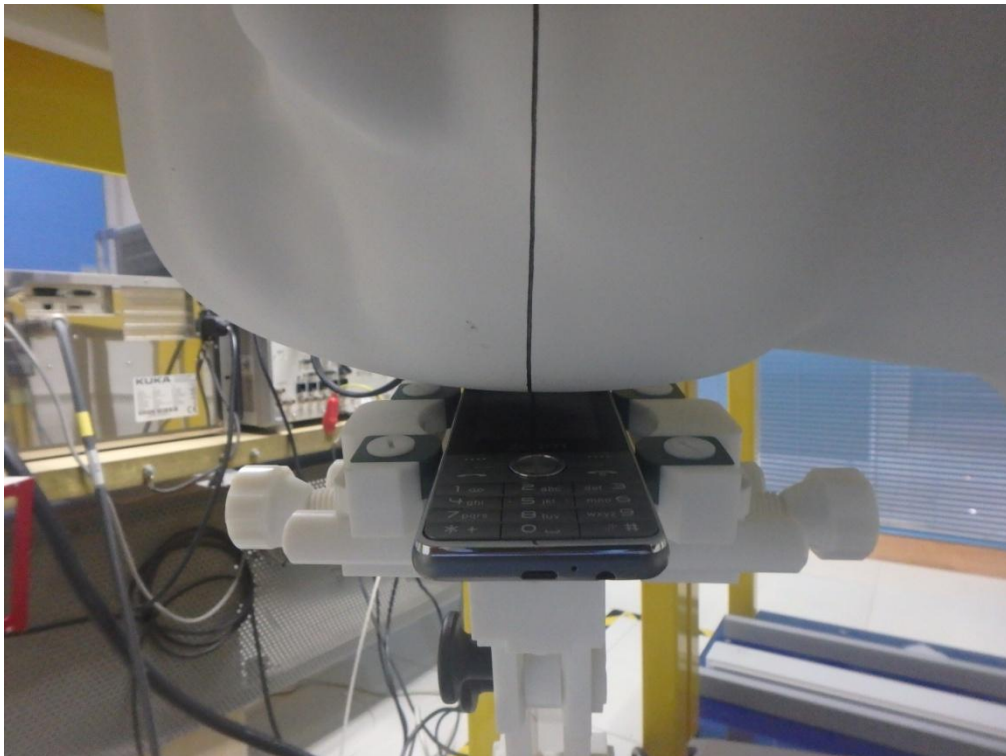

Body Back 5mm

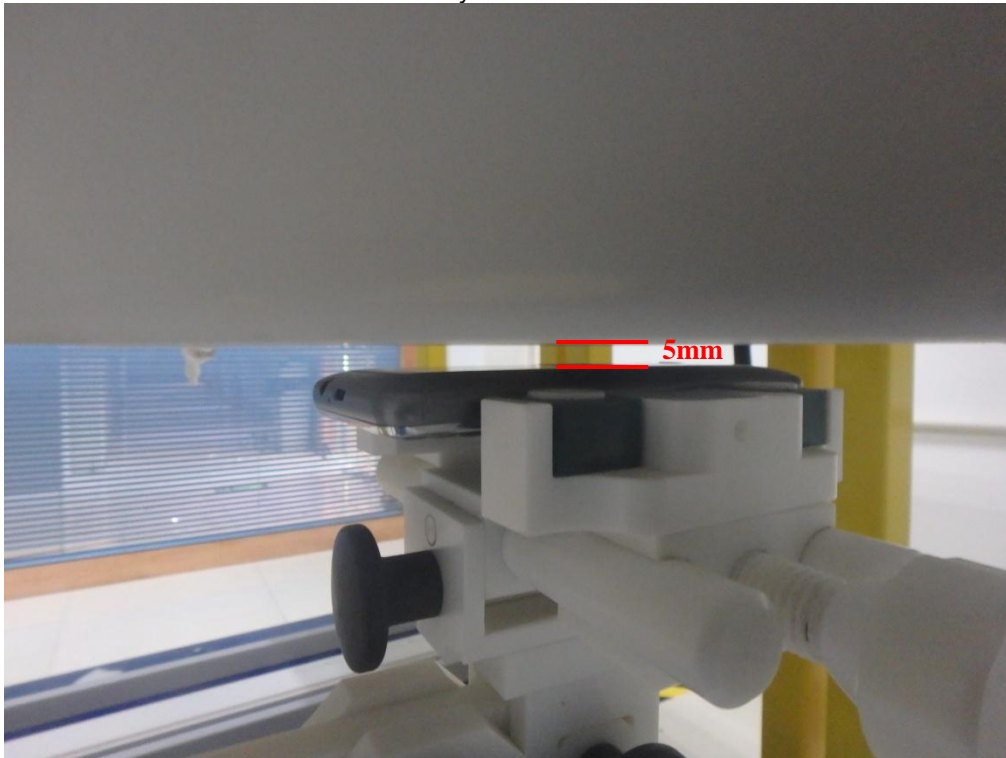

Body Front 5mm

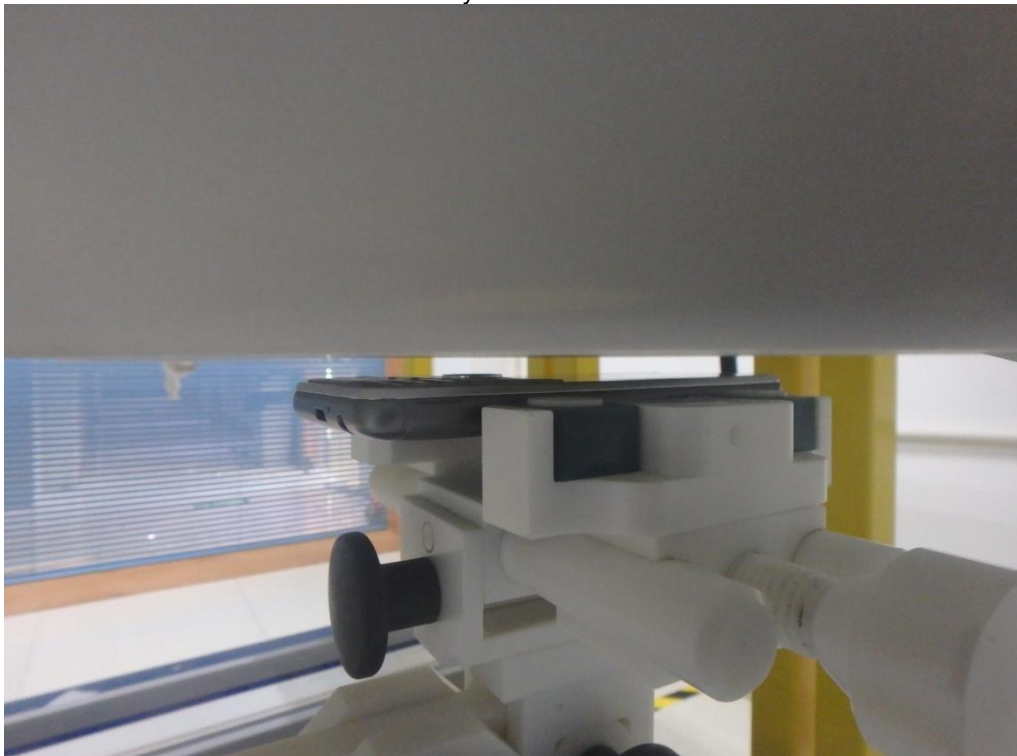

Body Back with Headset 5mm

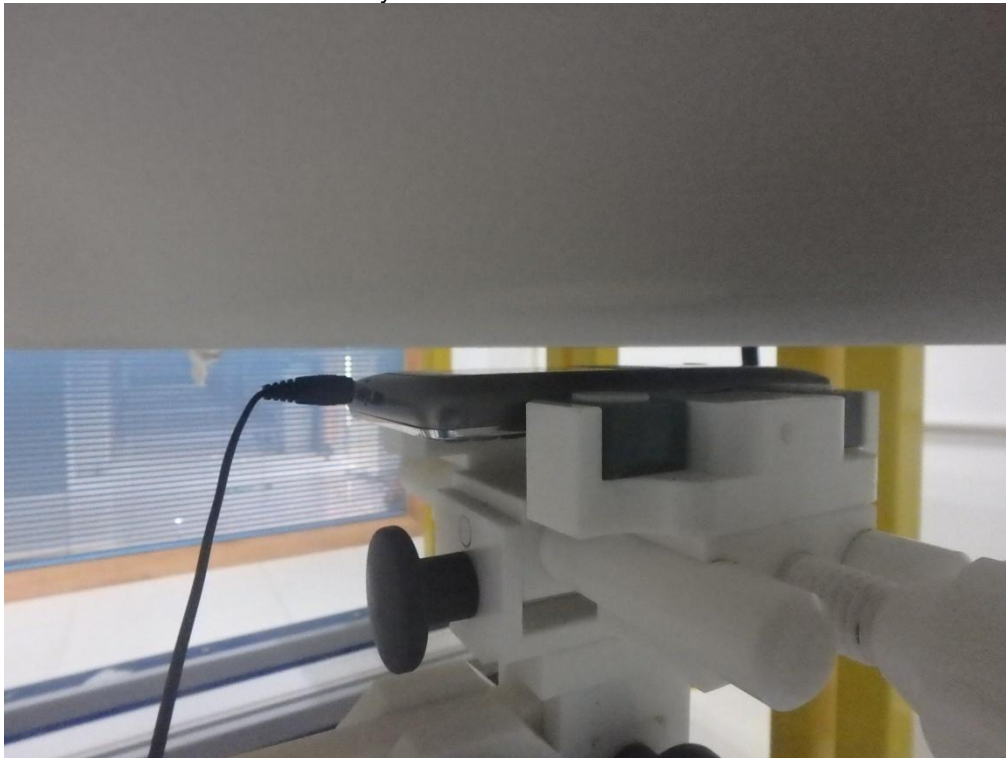

Position of the device under test in relation to the phantom

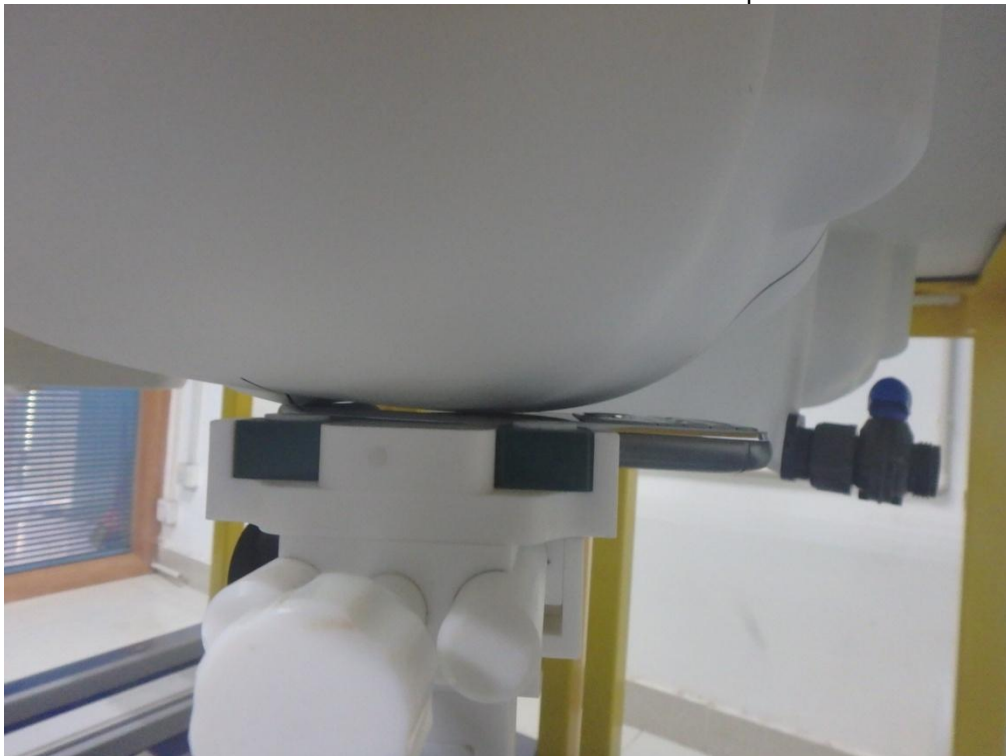

### DEPTH OF THE LIQUID IN THE PHANTOM—ZOOM IN

Note : The position used in the measurement were according to IEEE 1528-2013

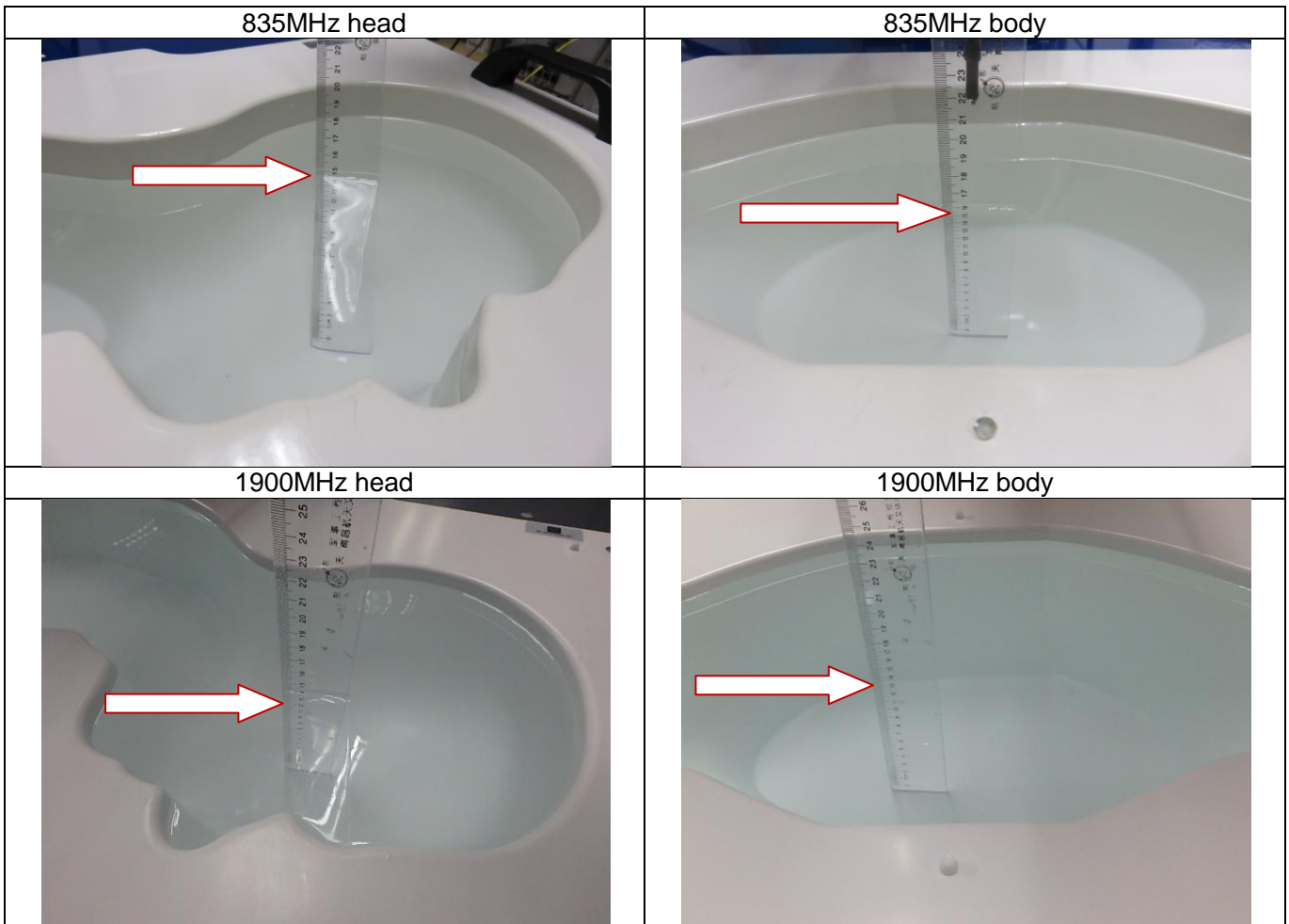

## **APPENDIX D. CALIBRATION DATA**

Refer to Attached files.