FCC Test Report

Report No.: AGC00653170502FE01

FCC ID : 2AFD9C5
APPLICATION PURPOSE : Original Equipment
PRODUCT DESIGNATION : GSM MOBILE PHONE
BRAND NAME : ZOOM
MODEL NAME : C5
CLIENT : MOVEON TECHNOLOGY LIMITED
DATE OF ISSUE : June 08, 2017
STANDARD(S) : FCC Part 15 Rules
REPORT VERSION : V1.0

Attestation of Global Compliance (Shenzhen) Co., Ltd



CAUTION:

This report shall not be reproduced except in full without the written permission of the test laboratory and shall not be quoted out of context.



Report Revise Record

Report Version	Revise Time	Issued Date	Valid Version	Notes
V1.0	/	June 08, 2017	Valid	Original Report

TABLE OF CONTENTS



- 1. VERIFICATION OF CONFORMITY 4**
- 2. SYSTEM DESCRIPTION 5**
- 3. MEASUREMENT UNCERTAINTY 5**
- 4. PRODUCT INFORMATION 6**
- 5. SUPPORT EQUIPMENT 7**
- 6. TEST FACILITY 8**
- 7. FCCLINE CONDUCTED EMISSION TEST 10**
 - 7.1. LIMITS OF LINE CONDUCTED EMISSION TEST 10
 - 7.2. BLOCK DIAGRAM OF TEST SETUP 10
 - 7.3. PROCEDURE OF LINE CONDUCTED EMISSION TEST 11
 - 7.4. TEST RESULT OF LINE CONDUCTED EMISSION TEST 12
- 8. FCC RADIATED EMISSION TEST 14**
 - 8.1. Except for Class A digital devices, the field strength of radiated emissions from unintentional radiators at a distance of 3 meters shall not exceed the following values: 14
 - 8.2. BLOCK DIAGRAM OF TEST SETUP 14
 - 8.3. PROCEDURE OF RADIATED EMISSION TEST 16
 - 8.4. TEST RESULT OF RADIATED EMISSION TEST 17
- APPENDIX A: PHOTOGRAPHS OF TEST SETUP 21**

1. VERIFICATION OF CONFORMITY

Applicant	MOVEON TECHNOLOGY LIMITED
Address	World Trade Plaza-A block#3201-3202 Fuhong Road, Futian, Shenzhen, China
Manufacturer	MOVEON TECHNOLOGY LIMITED
Address	World Trade Plaza-A block#3201-3202 Fuhong Road, Futian, Shenzhen, China
Product Designation	GSM MOBILE PHONE
Brand Name	ZOOM
Test Model	C5
Date of test	May. 26, 2017~June 06, 2017
Deviation	None
Condition of Test Sample	Normal
Report Template	AGCRT-US-IT/AC

The above equipment was tested by Dongguan Precise Testing Service Co., Ltd. for compliance with the requirements set forth in the FCC Rules and Regulations Part 15, the measurement procedure according to ANSI C63.4:2014. This said equipment in the configuration described in this report shows the maximum emission levels emanating from equipment are within the compliance requirements.

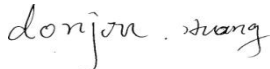
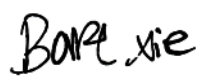
The test results of this report relate only to the tested sample identified in this report.

Tested By	
	_____ Donjon Huang(Huang Dongyang) June 06, 2017
Reviewed By	
	_____ Bart Xie(Xie Xiaobin) June 08, 2017
Approved By	
	_____ Solger Zhang(Zhang Hongyi) Authorized Officer June 08, 2017

2. SYSTEM DESCRIPTION

EUT test procedure:

1. Connect EUT and peripheral devices (PC) through USB port.
2. Power on the EUT, use the software to transfer data between EUT and PC.
3. Make sure the EUT operates normally during the test.

Test Mode

TEST MODE DESCRIPTION		
NO.	TEST MODE DESCRIPTION	WORST
1	USB (connection for data transferring)	V
Note: 1.V means EMI worst mode 2 .Other modes have been verified through VOC mode. 3. USB cable is provided by AGC-Lab.		

3. MEASUREMENT UNCERTAINTY

The uncertainty is calculated using the methods suggested in the “Guide to the Expression of Uncertainty in Measurement” (GUM) published by ISO.

Conducted measurement: +/- 2.75dB

Radiated measurement: +/- 3.2Db

Summary Of Test Results

FCC Rules	Description Of Test	Result
§15.107	Conduction Emission	Compliant
§15.109	Radiated Emission	Compliant
§15.33	Frequency range of radiated measurement	Compliant

4. PRODUCT INFORMATION

Housing Type	plastics
Adapter Input	AC100-240V, 50-60Hz, 0.15A
Adapter Output	DC5V, 500mA
Adapter Test Model Name	C5

I/O Port Information (Applicable Not Applicable)

I/O Port of EUT			
I/O Port Type	Q'TY	Cable	Tested with
USB Port	1	0.8m, Unshielded	1

5. SUPPORT EQUIPMENT

Device Type	Manufacturer	Model Name	Serial No.	Data Cable	Power Cable
Notebook	Lenovo	B460	WB03928113	1	1.5m unshielded
AC Adapter	N/A	42T4416	PA-1650-54I	1	1.5m unshielded

Note: All the above equipment/cables were placed in worse case positions to maximize emission signals during emission test.

6. TEST FACILITY

Site	Dongguan Precise Testing Service Co., Ltd.
Location	Building D, Baoding Technology Park, Guangming Road2,Dongcheng District, Dongguan, Guangdong, China,
FCC Registration No.	371540
Description	The test site is constructed and calibrated to meet the FCC requirements in documents ANSI C63.4:2014.

ALL TEST EQUIPMENT LIST

FOR RADIATED EMISSION TEST (BELOW 1GHZ)

Radiated Emission Test Site					
Name of Equipment	Manufacturer	Model Number	Serial Number	Last Calibration	Due Calibration
EMI Test Receiver	Rohde & Schwarz	ESCI	101417	July 3, 2016	July 2, 2017
Trilog Broadband Antenna (25M-1GHz)	SCHWARZBECK	VULB9160	9160-3355	July 3, 2016	July 2, 2017
Signal Amplifier	SCHWARZBECK	BBV 9475	9745-0013	July 3, 2016	July 2, 2017
RF Cable	SCHWARZBECK	AK9515E	96221	July 3, 2016	July 2, 2017
3m Anechoic Chamber	CHENGYU	966	PTS-001	June 5, 2017	June 4, 2018
MULTI-DEVICE Positioning Controller	Max-Full	MF-7802	MF780208339	N/A	N/A
Active loop antenna (9K-30MHz)	Schwarzbeck	FMZB1519	1519-038	June 5, 2017	June 4, 2018
Spectrum analyzer	Agilent	E4407B	MY46185649	June 5, 2017	June 4, 2018

FOR RADIATED EMISSION TEST (1GHZ ABOVE)

Radiated Emission Test Site					
Name of Equipment	Manufacturer	Model Number	Serial Number	Last Calibration	Due Calibration
EMI Test Receiver	Rohde & Schwarz	ESCI	101417	July 3, 2016	July 2, 2017
Horn Antenna (1G-18GHz)	SCHWARZBECK	BBHA9120D	9120D-1246	July 10, 2016	July 9, 2017
Spectrum Analyzer	Agilent	E4411B	MY4511453	July 3, 2016	July 2, 2017
Signal Amplifier	SCHWARZBECK	BBV 9718	9718-269	July 6, 2016	July 5, 2017
RF Cable	SCHWARZBECK	AK9515H	96220	July 7, 2016	July 6, 2017
3m Anechoic Chamber	CHENGYU	966	PTS-001	June 5, 2017	June 4, 2018

MULTI-DEVICE Positioning Controller	Max-Full	MF-7802	MF780208339	N/A	N/A
Horn Ant (18G-40GHz)	Schwarzbeck	BBHA 9170	9170-181	June 5, 2017	June 4, 2018

Conducted Emission Test Site					
Name of Equipment	Manufacturer	Model Number	Serial Number	Last Calibration	Due Calibration
EMI Test Receiver	Rohde & Schwarz	ESCI	101417	July 3, 2016	July 2, 2017
Artificial Mains Network	Narda	L2-16B	000WX31025	July 7, 2016	July 6, 2017
Artificial Mains Network (AUX)	Narda	L2-16B	000WX31026	July 7, 2016	July 6, 2017
RF Cable	SCHWARZBECK	AK9515E	96222	July 3, 2016	July 2, 2017
Shielded Room	CHENGYU	843	PTS-002	June 5, 2017	June 4, 2018

7. FCCLINE CONDUCTED EMISSION TEST

7.1. LIMITS OF LINE CONDUCTED EMISSION TEST

Frequency	Maximum RF Line Voltage	
	Q.P.(dBuV)	Average(dBuV)
150kHz-500kHz	66-56	56-46
500kHz-5MHz	56	46
5MHz-30MHz	60	50

Note:

1. The lower limit shall apply at the transition frequency.
2. The limit decreases linearly with the logarithm of the frequency in the range 0.15 MHz to 0.50MHz.

7.2. BLOCK DIAGRAM OF TEST SETUP

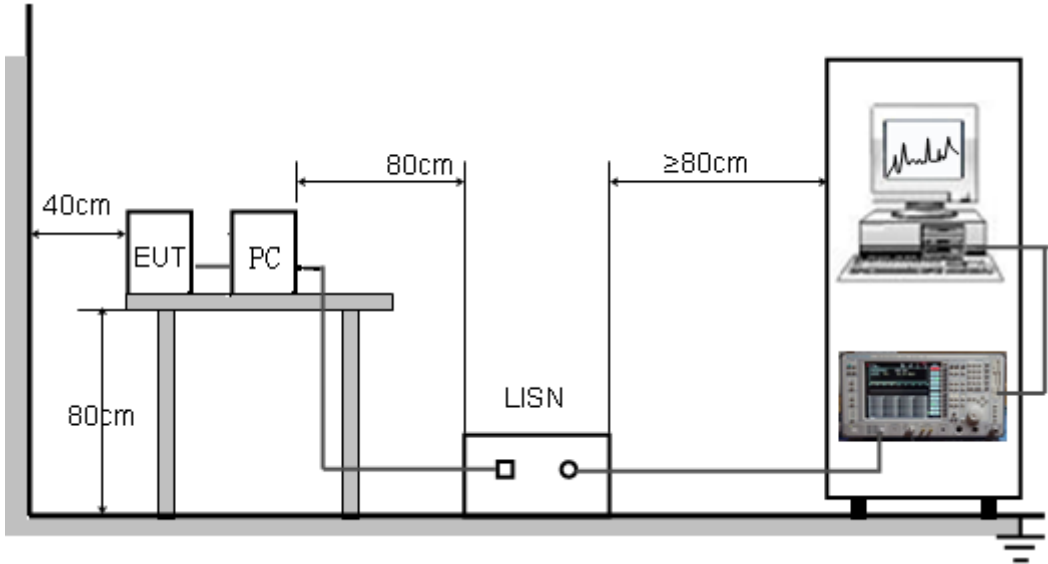

7.3. PROCEDURE OF LINE CONDUCTED EMISSION TEST

- (1) The equipment was set up as per the test configuration to simulate typical actual usage per the user's manual. When the EUT is a tabletop system, a wooden table with a height of 0.8 meters is used and is placed on the ground plane as per ANSI C63.4 (see Test Facility for the dimensions of the ground plane used). When the EUT is a floor-standing equipment, it is placed on the ground plane which has a 3-12 mm non-conductive covering to insulate the EUT from the ground plane.
- (2) Support equipment, if needed, was placed as per ANSI C63.4.
- (3) All I/O cables were positioned to simulate typical actual usage as per ANSI C63.4.
- (4) The EUT received DC5V power from PC with receive AC120V/60Hz power from a LISN.
- (5) The EUT test program was started. Emissions were measured on each current carrying line of the EUT using a spectrum Analyzer / Receiver connected to the LISN powering the EUT. The LISN has two monitoring points: Line 1 (Hot Side) and Line 2 (Neutral Side). Two scans were taken: one with Line 1 connected to Analyzer / Receiver and Line 2 connected to a 50 ohm load; the second scan had Line 1 connected to a 50 ohm load and Line 2 connected to the Analyzer / Receiver.
- (6) Analyzer / Receiver scanned from 150 kHz to 30MHz for emissions in each of the test modes.
- (7) During the above scans, the emissions were maximized by cable manipulation.
- (8) A scan was taken on both power lines, Line 1 and Line 2, recording at least the six highest emissions.
- (9) Emission frequency and amplitude were recorded into a computer in which correction factors were used to calculate the emission level and compare reading to the applicable limit. If EUT emission level was less -2dB to the A.V. limit in Peak mode, then the emission signal was re-checked using Q.P and Average detector.

The test data of the worst case condition (mode 1) was reported on the Summary Data page.

7.4. TEST RESULT OF LINE CONDUCTED EMISSION TEST
 LINE CONDUCTED EMISSION TEST-L

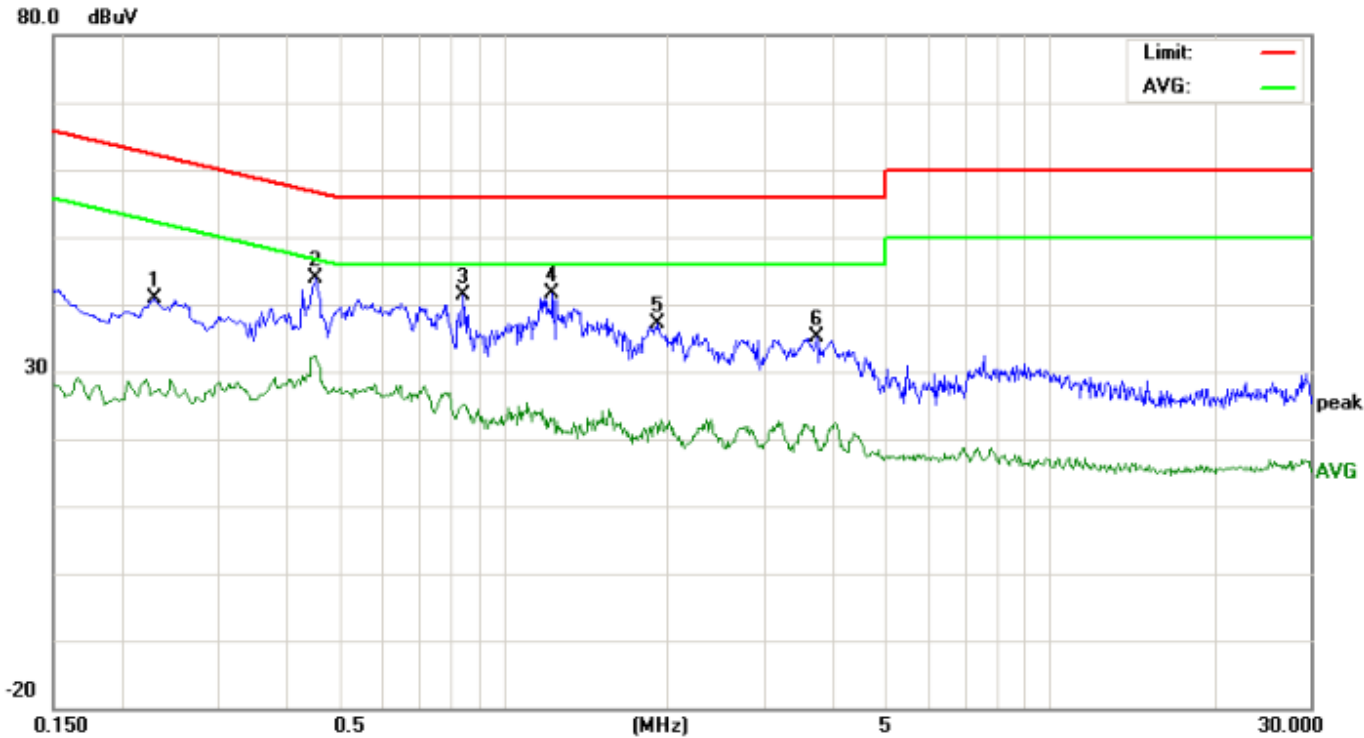

No.	Freq. (MHz)	Reading_Level (dBuV)			Correct Factor (dB)	Measurement (dBuV)			Limit (dBuV)		Margin (dB)		P/F	Comment
		Peak	QP	AVG		Peak	QP	AVG	QP	AVG	QP	AVG		
1	0.2300	30.59		16.90	10.25	40.84		27.15	62.45	52.45	-21.61	-25.30	P	
2	0.4540	33.45		21.77	10.37	43.82		32.14	56.80	46.80	-12.98	-14.66	P	
3	0.8460	30.99		14.75	10.34	41.33		25.09	56.00	46.00	-14.67	-20.91	P	
4	1.2300	31.32		12.42	10.37	41.69		22.79	56.00	46.00	-14.31	-23.21	P	
5	1.9220	26.76		10.52	10.24	37.00		20.76	56.00	46.00	-19.00	-25.24	P	
6	3.7540	24.59		9.36	10.47	35.06		19.83	56.00	46.00	-20.94	-26.17	P	

LINE CONDUCTED EMISSION TEST-N

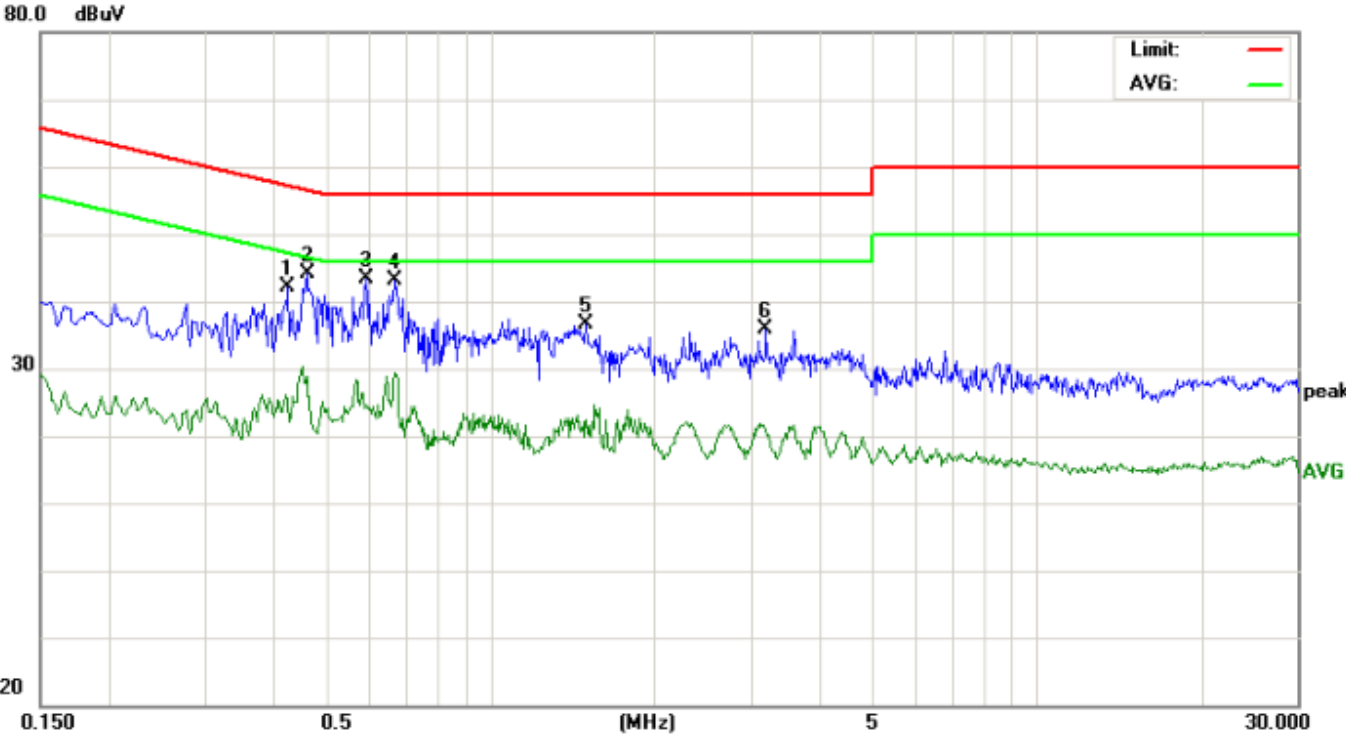

No.	Freq. (MHz)	Reading_Level (dBuV)			Correct Factor (dB)	Measurement (dBuV)			Limit (dBuV)		Margin (dB)		P/F	Comment
		Peak	QP	AVG		Peak	QP	AVG	QP	AVG	QP	AVG		
1	0.4260	31.77		14.47	10.35	42.12		24.82	57.33	47.33	-15.21	-22.51	P	
2	0.4620	33.65		18.46	10.37	44.02		28.83	56.66	46.66	-12.64	-17.83	P	
3	0.5940	33.01		14.22	10.32	43.33		24.54	56.00	46.00	-12.67	-21.46	P	
4	0.6700	32.89		19.12	10.34	43.23		29.46	56.00	46.00	-12.77	-16.54	P	
5	1.4980	26.33		12.08	10.38	36.71		22.46	56.00	46.00	-19.29	-23.54	P	
6	3.1940	25.43		10.68	10.53	35.96		21.21	56.00	46.00	-20.04	-24.79	P	

RESULT: PASS

8. FCC RADIATED EMISSION TEST

8.1. Except for Class A digital devices, the field strength of radiated emissions from unintentional radiators at a distance of 3 meters shall not exceed the following values:

Frequency (MHz)	Distance (m)	Maximum Field Strength Limit (dBuV/m/ Q.P.)
30~88	3	40.0
88~216	3	43.5
216~960	3	46.0
Above 960	3	54.0

Note: The lower limit shall apply at the transition frequency.

8.1.1 The following table is the setting of spectrum analyzer and receiver:

Spectrum Parameter	Setting
Start ~Stop Frequency	9KHz~150KHz/RB 200Hz for QP
Start ~Stop Frequency	150KHz~30MHz/RB 9KHz for QP
Start ~Stop Frequency	30MHz~1000MHz/RB 120KHz for QP
Start ~Stop Frequency	1GHz~26.5GHz 1MHz/1MHz for Peak, 1MHz/10Hz for Average

Receiver Parameter	Setting
Start ~Stop Frequency	9KHz~150KHz/RB 200Hz for QP
Start ~Stop Frequency	150KHz~30MHz/RB 9KHz for QP
Start ~Stop Frequency	30MHz~1000MHz/RB 120KHz for QP

8.2. BLOCK DIAGRAM OF TEST SETUP

System Diagram of Connections between EUT and Simulators

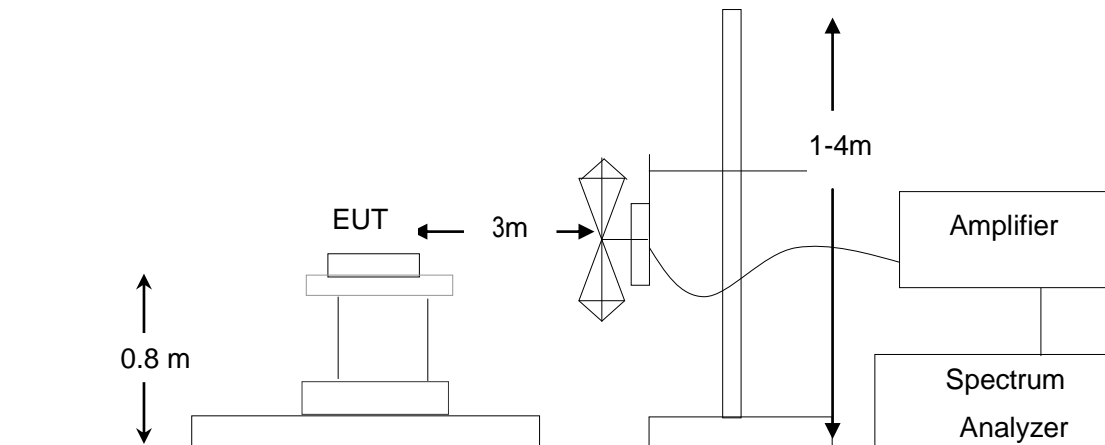

RADIATED EMISSION TEST SETUP ABOVE 1000MHz

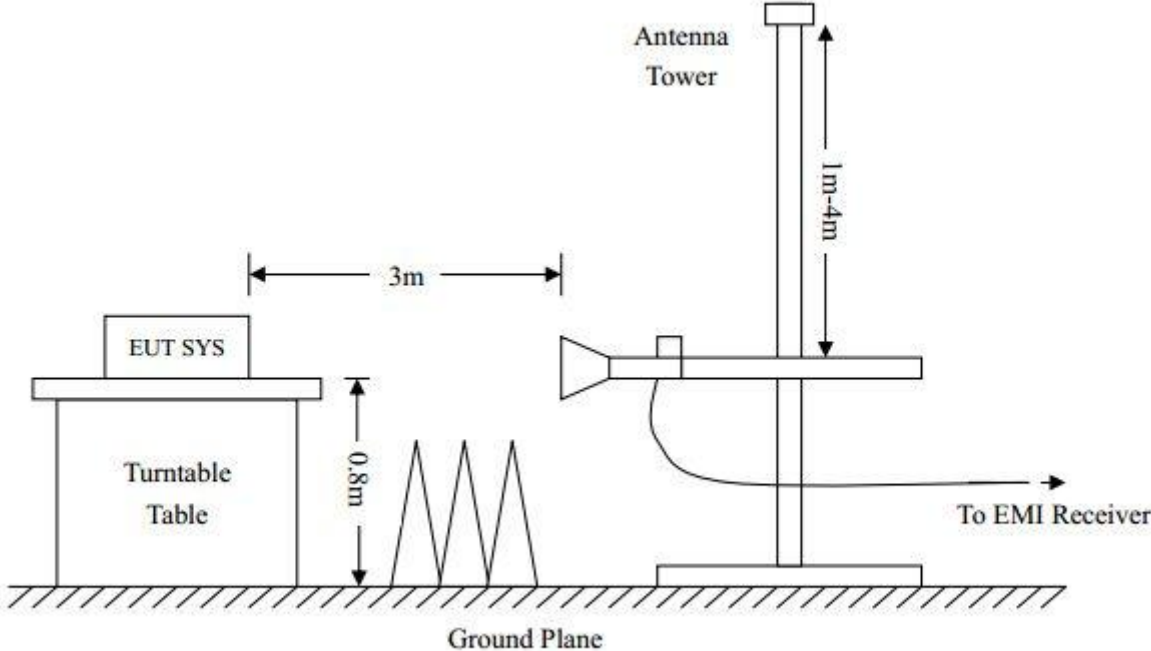

8.3. PROCEDURE OF RADIATED EMISSION TEST

1. Configure the EUT according to ANSI C63.4. The EUT was placed on the top of the turntable 0.8 meter above ground. The phase center of the receiving antenna mounted on the top of a height-variable antenna tower was placed 3 meters far away from the turntable.
2. Power on the EUT and all the supporting units. The turntable was rotated by 360 degrees to determine the position of the highest radiation.
3. The height of the broadband receiving antenna was varied between one meter and four meters above ground to find the maximum emissions field strength of both horizontal and vertical polarization.
4. For each suspected emissions, the antenna tower was scan (from 1 M to 4 M) and then the turntable was rotated (from 0 degree to 360 degrees) to find the maximum reading.
5. Set the test-receiver system to Peak or CISPR quasi-peak Detect Function with specified bandwidth under Maximum Hold Mode.
6. For emissions above 1GHz, use 1MHz RBW and 3MHz VBW for peak reading. Then 1MHz RBW and 3MHz VBW for average reading in spectrum analyzer. The EUT was placed on the top of the turntable 0.8 meter above ground. The phase center of the receiving antenna mounted on the top of a height-variable antenna tower was placed 3 meters far away from the turntable.
7. When the radiated emissions limits are expressed in terms of the average value of the emissions, and pulsed operation is employed, the measurement field strength shall be determined by averaging over one complete pulse train, including blanking intervals, as long as the pulse train does not exceed 0.1 seconds. As an alternative (provided the transmitter operates for longer than 0.1 seconds) or in cases where the pulse train exceeds 0.1 seconds, the measured field strength shall be determined from the average absolute voltage during a 0.1 second interval during which the field strength is at its maximum values.
8. If the emissions level of the EUT in peak mode was 3 dB lower than the average limit specified, then testing will be stopped and peak values of EUT will be reported, otherwise, the emissions which do not have 3 dB margin will be repeated one by one using the quasi-peak method for below 1GHz.
9. If the emission level of the EUT in peak mode was 10 dB lower than the limit specified, then testing could be stopped and the peak values of the EUT would be reported. Otherwise the emissions that did not have 10 dB margin would be re-tested one by one using peak, quasi-peak or average method as specified and then reported in a data sheet.
10. In case the emission is lower than 30MHz, loop antenna has to be used for measurement and the recorded data should be QP measured by receiver. High - Low scan is not required in this case.
11. The test data of the worst case condition (mode 1) was reported on the Summary Data page.

8.4. TEST RESULT OF RADIATED EMISSION TEST

Radiated Emission Test at 3m Distance-Horizontal

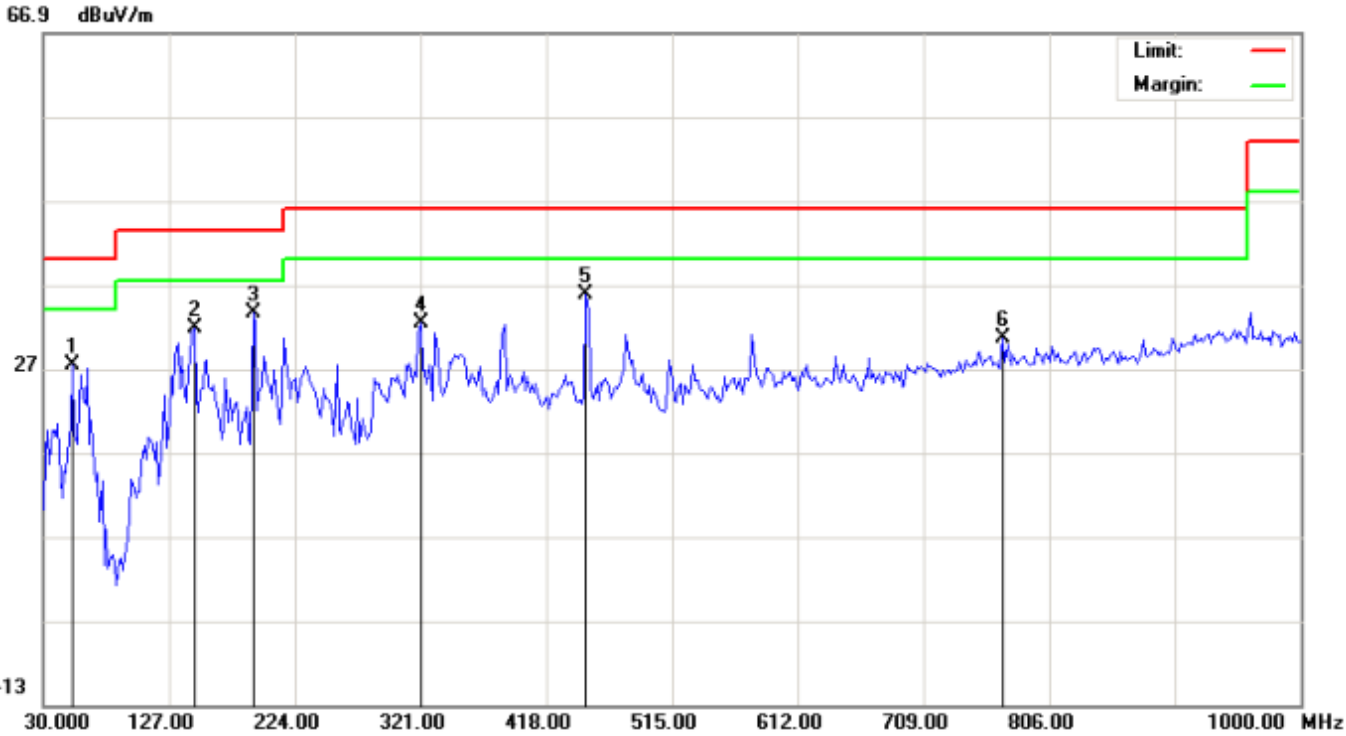

No.	Mk	Freq.	Reading	Factor	Measurement	Limit	Over	Detector	Antenna Height	Table Degree	Comment
		MHz	dBuV	dB/m	dBuV/m	dBuV/m	dB		cm	degree	
1		52.6333	19.00	8.41	27.41	40.00	-12.59	peak			
2		146.4000	18.11	13.64	31.75	43.50	-11.75	peak			
3	*	191.6667	22.08	11.61	33.69	43.50	-9.81	peak			
4		321.0000	15.51	16.81	32.32	46.00	-13.68	peak			
5		448.7167	15.18	20.55	35.73	46.00	-10.27	peak			
6		770.4333	3.72	26.91	30.63	46.00	-15.37	peak			

RESULT: PASS

Radiated Emission Test at 3m Distance-Vertical

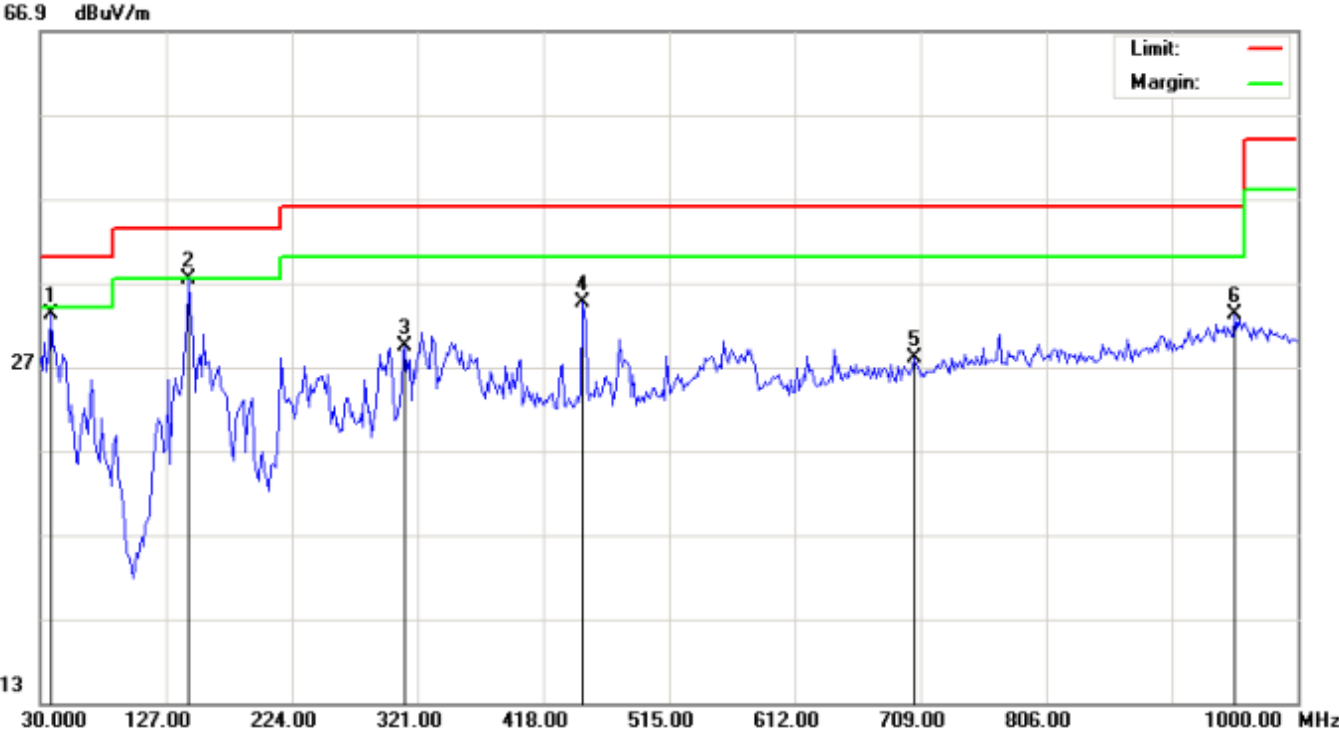

No.	Mk	Freq.	Reading	Factor	Measurement	Limit	Over	Detector	Antenna Height	Table Degree	Comment
		MHz	dBuV	dB/m	dBuV/m	dBuV/m	dB		cm	degree	
1	.	38.0833	26.81	6.39	33.20	40.00	-6.80	peak			
2	*	144.7833	22.13	15.23	37.36	43.50	-6.14	peak			
3		311.3000	13.15	16.16	29.31	46.00	-16.69	peak			
4		448.7167	14.04	20.55	34.59	46.00	-11.41	peak			
5		704.1500	2.65	25.31	27.96	46.00	-18.04	peak			
6		951.5000	3.15	29.99	33.14	46.00	-12.86	peak			

RESULT: PASS

Note: 1.Measurement = Reading + Factor, Over = Measurement – Limit.

2. The “Factor” value can be calculated automatically by software of measurement system.

Radiated Emission Above 1GHz (1-10th Harmonics) –Horizontal

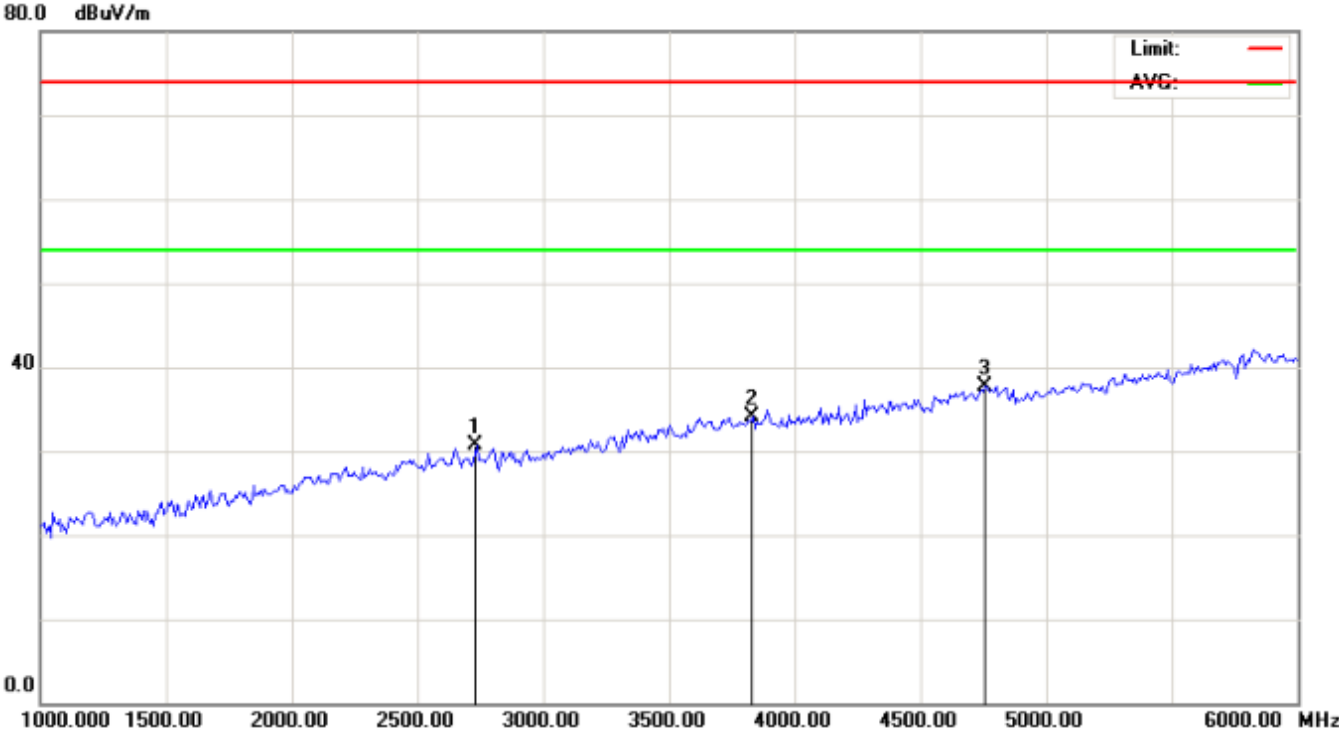

No.	Mk	Freq.	Reading	Factor	Measurement	Limit	Over	Detector	Antenna Height	Table Degree	Comment
		MHz	dBuV	dB/m	dBuV/m	dBuV/m	dB		cm	degree	
1		2733.333	14.78	15.95	30.73	74.00	-43.27	peak			
2		3833.333	17.16	16.89	34.05	74.00	-39.95	peak			
3	*	4758.333	22.30	15.35	37.65	74.00	-36.35	peak			

Radiated Emission Above 1GHZ (1-10th Harmonics) –Vertical

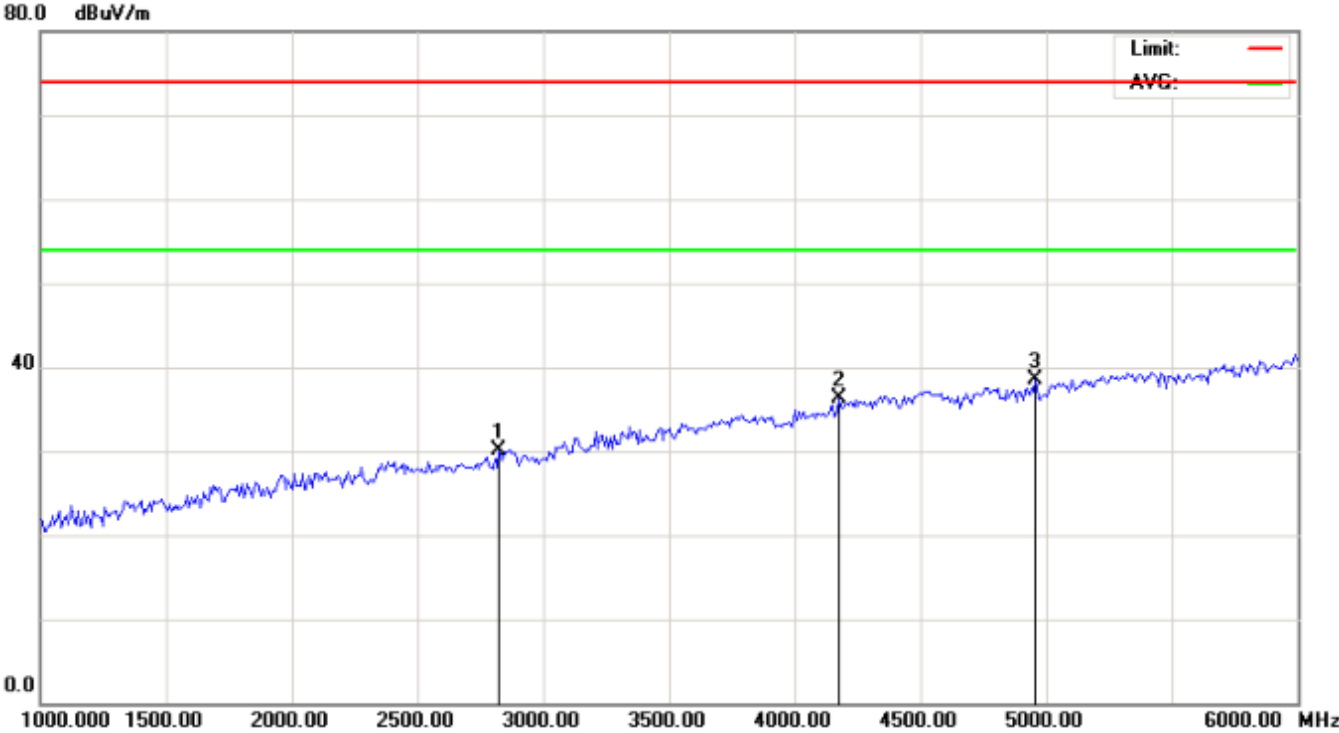

No.	Mk	Freq.	Reading	Factor	Measurement	Limit	Over	Detector	Antenna Height	Table Degree	Comment
		MHz	dBuV	dB/m	dBuV/m	dBuV/m	dB		cm	degree	
1		2825.000	14.02	16.07	30.09	74.00	-43.91	peak			
2		4175.000	19.80	16.48	36.28	74.00	-37.72	peak			
3	*	4958.333	22.99	15.52	38.51	74.00	-35.49	peak			

- Note:** 1. The Eut operates at 2400~2483.5MHz, according to FCC part 15.33, if the intentional radiator operates below 10 GHz: to the tenth harmonic of the highest fundamental frequency or to 40 GHz, whichever is lower. It's approximately to 25G.
2. 6~25GHz at least have 20dB margin. No recording in the test report.
3. Factor=Antenna Factor + Cable loss - Amplifier gain, Margin=Measurement-Limit.
4. The "Factor" value can be calculated automatically by software of measurement system.

APPENDIX A: PHOTOGRAPHS OF TEST SETUP
FCC LINE CONDUCTED EMISSION TEST SETUP



FCC RADIATED EMISSION TEST SETUP

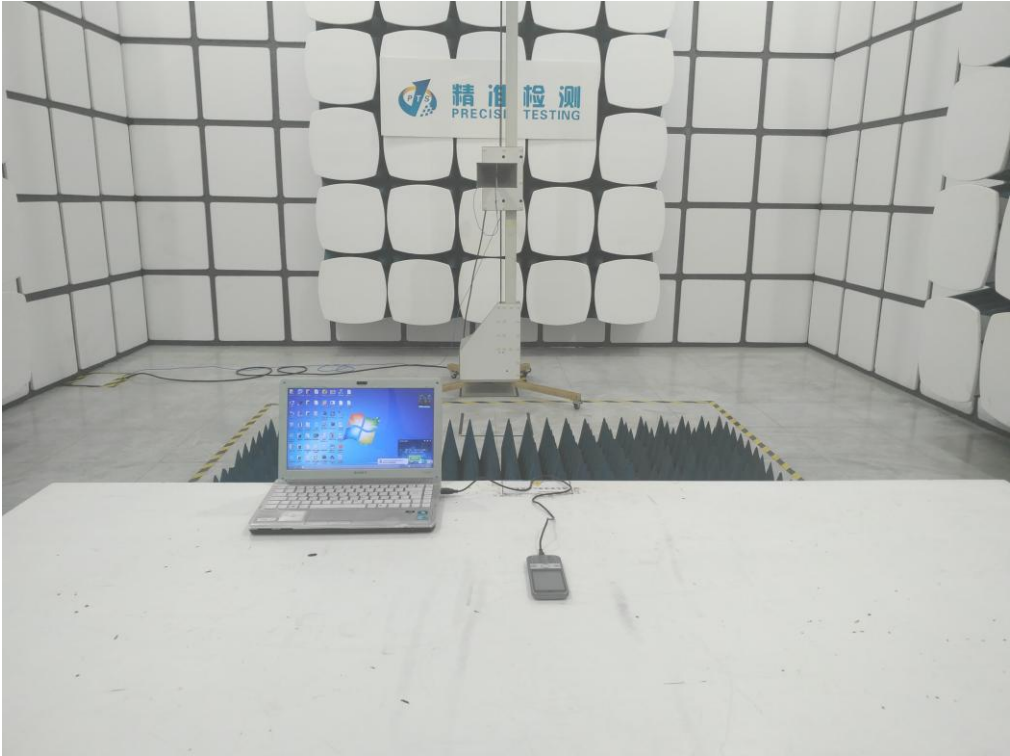

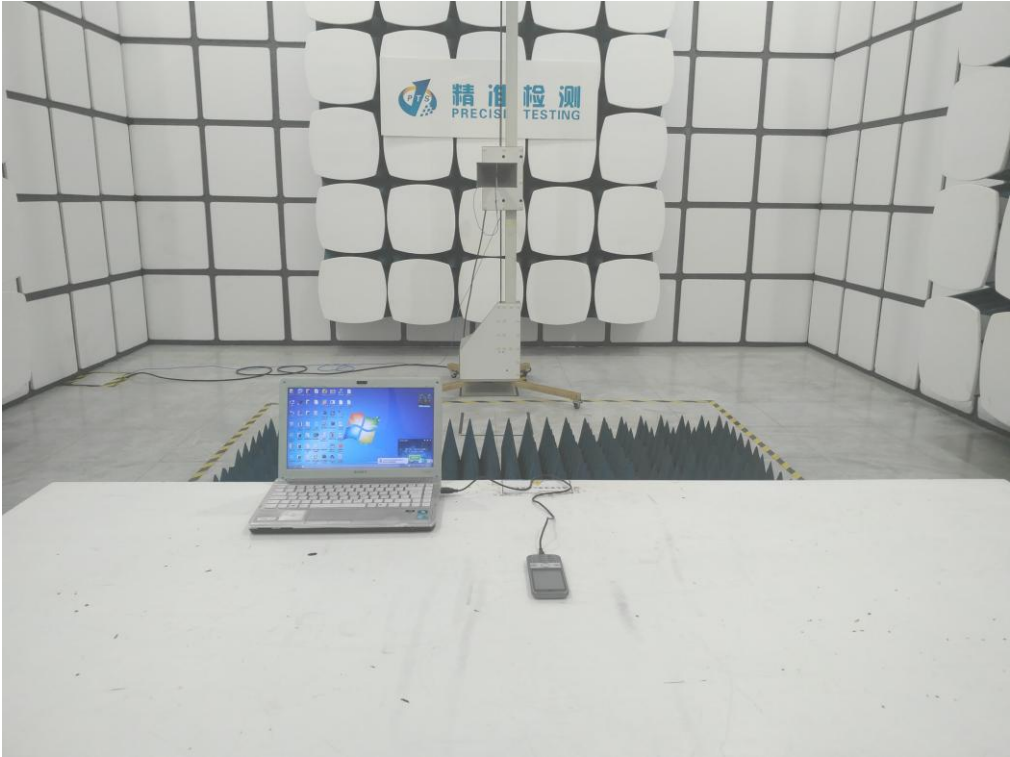

----END OF REPORT----