



TEST REPORT

Report Reference No...... : **TRE17030279** R/C.....: 11274
FCC ID..... : **2AFD9-NETTITANIUM**
Applicant's name..... : **MOVEON TECHNOLOGY LIMITED**
 Address..... : World Trade Plaza-A block#3201-3202 Fuhong Road,Futian, Shenzhen,China
 Manufacturer..... : MOVEON TECHNOLOGY LIMITED
 Address..... : World Trade Plaza-A block#3201-3202 Fuhong Road,Futian, Shenzhen,China
Test item description : **smart mobile phone**
 Trade Mark : KRONO
 Model/Type reference..... : NET TITANIUM
 Listed Model(s) : -
Standard : **FCC 47 CFR Part2.1093**
ANSI/IEEE C95.1: 1999
IEEE 1528: 2013
 Date of receipt of test sample..... : Mar. 29, 2017
 Date of testing..... : Mar. 29, 2017- Apr. 14, 2017
 Date of issue..... : Apr. 14, 2017
Result..... : **PASS**

| | | |
|--------------------------------------------------------|----------------------------------|---------------------------------------------------------------------------------------|
| Compiled by (position+printed name+signature)... | File administrators: Becky Liang |  |
| Supervised by (position+printed name+signature)... | Test Engineer: Siyuan Rao |  |
| Approved by (position+printed name+signature)... | Manager: Hans Hu |  |

Testing Laboratory Name : **Shenzhen Huatongwei International Inspection Co., Ltd.**
 Address..... : 1/F, Bldg 3, Hongfa Hi-tech Industrial Park, Genyu Road, Tianliao, Gongming, Shenzhen, China

Shenzhen Huatongwei International Inspection Co., Ltd. All rights reserved.

This publication may be reproduced in whole or in part for non-commercial purposes as long as the Shenzhen Huatongwei International Inspection Co., Ltd. is acknowledged as copyright owner and source of the material. Shenzhen Huatongwei International Inspection Co., Ltd. takes no responsibility for and will not assume liability for damages resulting from the reader's interpretation of the reproduced material due to its placement and context.

*The test report merely corresponds to the test sample.
 It is not permitted to copy extracts of these test result without the written permission of the test laboratory.*

Contents

| | | |
|------------|-------------------------------------------------------------------|-----------|
| <u>1.</u> | <u>Test Standards and Report version</u> | <u>3</u> |
| 1.1. | Test Standards | 3 |
| 1.2. | Report version | 3 |
| <u>2.</u> | <u>Summary</u> | <u>4</u> |
| 2.1. | Client Information | 4 |
| 2.2. | Product Description | 4 |
| <u>3.</u> | <u>Test Environment</u> | <u>6</u> |
| 3.1. | Address of the test laboratory | 6 |
| 3.2. | Test Facility | 6 |
| <u>4.</u> | <u>Equipments Used during the Test</u> | <u>7</u> |
| <u>5.</u> | <u>Measurement Uncertainty</u> | <u>8</u> |
| <u>6.</u> | <u>SAR Measurements System Configuration</u> | <u>10</u> |
| 6.1. | SAR Measurement Set-up | 10 |
| 6.2. | DASY5 E-field Probe System | 11 |
| 6.3. | Phantoms | 12 |
| 6.4. | Device Holder | 12 |
| <u>7.</u> | <u>SAR Test Procedure</u> | <u>13</u> |
| 7.1. | Scanning Procedure | 13 |
| 7.2. | Data Storage and Evaluation | 14 |
| <u>8.</u> | <u>Position of the wireless device in relation to the phantom</u> | <u>16</u> |
| 8.1. | Head Position | 16 |
| 8.2. | Body Position | 17 |
| 8.3. | Hotspot Mode Exposure conditions | 17 |
| <u>9.</u> | <u>System Check</u> | <u>18</u> |
| 9.1. | Tissue Dielectric Parameters | 18 |
| 9.2. | SAR System Check | 20 |
| <u>10.</u> | <u>SAR Exposure Limits</u> | <u>28</u> |
| <u>11.</u> | <u>Conducted Power Measurement Results</u> | <u>29</u> |
| <u>12.</u> | <u>Maximum Tune-up Limit</u> | <u>34</u> |
| <u>13.</u> | <u>Antenna Location</u> | <u>35</u> |
| <u>14.</u> | <u>SAR Measurement Results</u> | <u>36</u> |
| <u>15.</u> | <u>Simultaneous Transmission analysis</u> | <u>55</u> |
| <u>16.</u> | <u>Test Setup Photos</u> | <u>59</u> |
| <u>17.</u> | <u>External and Internal Photos of the EUT</u> | <u>61</u> |

1 . Test Standards and Report version

1.1. Test Standards

The tests were performed according to following standards:

[FCC 47 Part 2.1093](#) Radiofrequency Radiation Exposure Evaluation:Portable Devices

[IEEE Std C95.1, 1999](#): IEEE Standard for Safety Levels with Respect to Human Exposure to Radio Frequency Electromagnetic Fields, 3 KHz to 300 GHz.

[IEEE Std 1528™-2013](#): IEEE Recommended Practice for Determining the Peak Spatial-Average Specific Absorption Rate (SAR) in the Human Head from Wireless Communications Devices: Measurement Techniques.

[KDB 865664 D01 SAR Measurement 100 MHz to 6 GHz v01r04](#): SAR Measurement Requirements for 100 MHz to 6 GHz

[KDB 865664 D02 RF Exposure Reporting v01r02](#): RF Exposure Compliance Reporting and Documentation Considerations

[KDB 447498 D01 General RF Exposure Guidance v06](#): Mobile and Portable Device RF Exposure Procedures and Equipment Authorization Policies

[KDB248227 D01 802 11 Wi-Fi SAR v02r02](#): SAR Measurement Proceduresfor802.11 a/b/g Transmitters

[KDB 648474 D04 Handset SAR v01r03](#): SAR Evaluation Considerations for Wireless Handsets

[KDB941225 D01 3G SAR Procedures v03r01](#): SAR Measurement Procedures for 3G Devices

[KDB 941225 D06 Hotspot Mode v02r01](#): SAR Evaluation Procedures for Portable Devices with Wireless Router Capabilities

1.2. Report version

| Version No. | Date of issue | Description |
|-------------|---------------|-------------|
| 00 | Apr. 14, 2017 | Original |
| | | |
| | | |
| | | |
| | | |

2. Summary

2.1. Client Information

| | |
|---------------|------------------------------------------------------------------------|
| Applicant: | MOVEON TECHNOLOGY LIMITED |
| Address: | World Trade Plaza-A block#3201-3202 Fuhong Road,Futian,Shenzhen, China |
| Manufacturer: | MOVEON TECHNOLOGY LIMITED |
| Address: | World Trade Plaza-A block#3201-3202 Fuhong Road,Futian,Shenzhen, China |

2.2. Product Description

| | |
|----------------------------|---------------------------------------------------------------|
| Name of EUT: | smart mobile phone |
| Trade Mark: | KRONO |
| Model No.: | NET TITANIUM |
| Listed Model(s): | - |
| Power supply: | DC 3.8V From internal battery |
| Device Category: | Portable |
| Product stage: | Production unit |
| RF Exposure Environment: | General Population / Uncontrolled |
| IMEI : | IMEI1: 35968007500015 IMEI2: 35968007000017 |
| Hardware version: | V1.2 |
| Software version: | H5501_V10_V04 |
| Maximum SAR Value | |
| Separation Distance: | Head: 0mm Body: 10mm |
| Max Report SAR Value (1g): | Head: 0.36 W/Kg Body: 0.83 W/Kg |
| GSM | |
| Support Network: | GSM, GPRS, EGPRS |
| Support Band: | GSM850, PCS1900 |
| Modulation: | GSM/GPRS/EGPRS: GMSK |
| Transmit Frequency: | GSM850: 824.20MHz-848.80MHz PCS1900: 1850.20MHz-1909.80MHz |
| Receive Frequency: | GSM850: 869.20MHz-893.80MHz PCS1900: 1930.20MHz-1989.80MHz |
| GPRS Class: | 12 |
| EGPRS Class: | 12 |
| Antenna type: | Intergal Antenna |
| WCDMA | |
| Operation Band: | FDD Band II and FDD Band V |
| Power Class: | Power Class 3 |
| Modulation Type: | QPSK/16QAM/64QAM/HSUPA/HSDPA |

| | |
|------------------------------------------------------------------------------------------------------------------------------------|-------------------------------------------------------------------------------------------|
| Antenna type: | Intergal Antenna |
| WIFI | |
| Supported type: | 802.11b/802.11g/802.11n(H20) |
| Modulation: | 802.11b: DSSS (DBPSK / DQPSK / CCK) 802.11g/n(H20): OFDM (BPSK / QPSK / 16QAM / 64QAM) |
| Operation frequency: | 802.11b/g/n(H20): 2412MHz~2462MHz |
| Channel number: | 802.11b/g/n(H20): 11 |
| Channel separation: | 5MHz |
| Antenna type: | Internal Antenna |
| Bluetooth-EDR | |
| Version: | Supported BT4.0+EDR |
| Modulation: | GFSK, $\pi/4$ DQPSK, 8DPSK |
| Operation frequency: | 2402MHz~2480MHz |
| Channel number: | 79 |
| Channel separation: | 1MHz |
| Antenna type: | Integral Antenna |
| Bluetooth-BLE | |
| Version: | Supported BT4.0+BLE |
| Modulation: | GFSK |
| Operation frequency: | 2402MHz~2480MHz |
| Channel number: | 40 |
| Channel separation: | 2MHz |
| Antenna type: | Integral Antenna |
| <i>Remark:</i> <i>The EUT battery must be fully charged and checked periodically during the test to ascertain uniform power</i> | |

3. Test Environment

3.1. Address of the test laboratory

Laboratory: Shenzhen Huatongwei International Inspection Co., Ltd.

Address: 1/F, Bldg 3, Hongfa Hi-tech Industrial Park, Genyu Road, Tianliao, Gongming, Shenzhen, China

Phone: 86-755-26748019 Fax: 86-755-26748089

3.2. Test Facility

The test facility is recognized, certified, or accredited by the following organizations:

CNAS-Lab Code: L1225

Shenzhen Huatongwei International Inspection Co., Ltd. has been assessed and proved to be in compliance with CNAS-CL01 Accreditation Criteria for Testing and Calibration Laboratories (identical to ISO/IEC17025: 2005 General Requirements) for the Competence of Testing and Calibration Laboratories.

A2LA-Lab Cert. No.: 3902.01

Shenzhen Huatongwei International Inspection Co., Ltd. EMC Laboratory has been accredited by A2LA for technical competence in the field of electrical testing, and proved to be in compliance with ISO/IEC 17025: 2005 General Requirements for the Competence of Testing and Calibration Laboratories and any additional program requirements in the identified field of testing.

FCC-Registration No.: 317478

Shenzhen Huatongwei International Inspection Co., Ltd. EMC Laboratory has been registered and fully described in a report filed with the FCC (Federal Communications Commission). The acceptance letter from the FCC is maintained in our files. Registration 317478.

IC-Registration No.: 5377B

Two 3m Alternate Test Site of Shenzhen Huatongwei International Inspection Co., Ltd. has been registered by Certification and Engineering Bureau of Industry Canada for the performance of radiated measurements with Registration No. 5377B.

ACA

Shenzhen Huatongwei International Inspection Co., Ltd. EMC Laboratory can also perform testing for the Australian C-Tick mark as a result of our A2LA accreditation.

4. Equipments Used during the Test

| Test Equipment | Manufacturer | Type/Model | Serial Number | Calibration | |
|--------------------------------------|-----------------|------------|---------------|------------------|----------------------|
| | | | | Last Calibration | Calibration Interval |
| Data Acquisition Electronics DAEx | SPEAG | DAE4 | 1315 | 2016/07/26 | 1 |
| E-field Probe | SPEAG | ES3DV3 | 3292 | 2016/09/02 | 1 |
| System Validation Dipole D835V2 | SPEAG | D835V2 | 4d134 | 2014/07/24 | 3 |
| System Validation Dipole D1750V2 | SPEAG | D1750V2 | 1062 | 2015/07/25 | 3 |
| System Validation Dipole D1900V2 | SPEAG | D1900V2 | 5d101 | 2015/07/23 | 3 |
| System Validation Dipole D2450V2 | SPEAG | D2450V2 | 884 | 2015/09/01 | 3 |
| Dielectric Probe Kit | Agilent | 85070E | US44020288 | / | / |
| Power meter | Agilent | E4417A | GB41292254 | 2016/10/25 | 1 |
| Power sensor | Agilent | 8481H | MY41095360 | 2016/10/25 | 1 |
| Power sensor | Agilent | E9327A | US40441621 | 2016/10/25 | 1 |
| Network analyzer | Agilent | 8753E | US37390562 | 2016/10/24 | 1 |
| Universal Radio Communication Tester | ROHDE & SCHWARZ | CMU200 | 112012 | 2016/10/22 | 1 |
| Signal Generator | ROHDE & SCHWARZ | SMBV100A | 258525 | 2016/10/22 | 1 |
| Power Divider | ARRA | A3200-2 | N/A | N/A | N/A |
| Dual Directional Coupler | Agilent | 778D | 50783 | Note | |
| Attenuator 1 | PE | PE7005-10 | N/A | Note | |
| Attenuator 2 | PE | PE7005-10 | N/A | Note | |
| Attenuator 3 | PE | PE7005-3 | N/A | Note | |
| Power Amplifier | AR | 5S1G4M2 | 0328798 | Note | |

Note:

1. The Probe, Dipole and DAE calibration reference to the Appendix A.

5. Measurement Uncertainty

| Measurement Uncertainty | | | | | | | | | | |
|----------------------------------------------------|-------------------------------------------------|--------------------------------------------|-------------------|-----------------------|------------|---------|----------|----------------|-----------------|-------------------|
| No. | Error Description | Type | Uncertainty Value | Probably Distribution | Div. | (Ci) 1g | (Ci) 10g | Std. Unc. (1g) | Std. Unc. (10g) | Degree of freedom |
| Measurement System | | | | | | | | | | |
| 1 | Probe calibration | B | 6.0% | N | 1 | 1 | 1 | 6.0% | 6.0% | ∞ |
| 2 | Axial isotropy | B | 4.70% | R | $\sqrt{3}$ | 0.7 | 0.7 | 1.90% | 1.90% | ∞ |
| 3 | Hemispherical isotropy | B | 9.60% | R | $\sqrt{3}$ | 0.7 | 0.7 | 3.90% | 3.90% | ∞ |
| 4 | Boundary Effects | B | 1.00% | R | $\sqrt{3}$ | 1 | 1 | 0.60% | 0.60% | ∞ |
| 5 | Probe Linearity | B | 4.70% | R | $\sqrt{3}$ | 1 | 1 | 2.70% | 2.70% | ∞ |
| 6 | Detection limit | B | 1.00% | R | $\sqrt{3}$ | 1 | 1 | 0.60% | 0.60% | ∞ |
| 7 | RF ambient conditions-noise | B | 0.00% | R | $\sqrt{3}$ | 1 | 1 | 0.00% | 0.00% | ∞ |
| 8 | RF ambient conditions-reflection | B | 0.00% | R | $\sqrt{3}$ | 1 | 1 | 0.00% | 0.00% | ∞ |
| 9 | Response time | B | 0.80% | R | $\sqrt{3}$ | 1 | 1 | 0.50% | 0.50% | ∞ |
| 10 | Integration time | B | 5.00% | R | $\sqrt{3}$ | 1 | 1 | 2.90% | 2.90% | ∞ |
| 11 | RF ambient | B | 3.00% | R | $\sqrt{3}$ | 1 | 1 | 1.70% | 1.70% | ∞ |
| 12 | Probe positioned mech. restrictions | B | 0.40% | R | $\sqrt{3}$ | 1 | 1 | 0.20% | 0.20% | ∞ |
| 13 | Probe positioning with respect to phantom shell | B | 2.90% | R | $\sqrt{3}$ | 1 | 1 | 1.70% | 1.70% | ∞ |
| 14 | Max.SAR evaluation | B | 3.90% | R | $\sqrt{3}$ | 1 | 1 | 2.30% | 2.30% | ∞ |
| Test Sample Related | | | | | | | | | | |
| 15 | Test sample positioning | A | 1.86% | N | 1 | 1 | 1 | 1.86% | 1.86% | ∞ |
| 16 | Device holder uncertainty | A | 1.70% | N | 1 | 1 | 1 | 1.70% | 1.70% | ∞ |
| 17 | Drift of output power | B | 5.00% | R | $\sqrt{3}$ | 1 | 1 | 2.90% | 2.90% | ∞ |
| Phantom and Set-up | | | | | | | | | | |
| 18 | Phantom uncertainty | B | 4.00% | R | $\sqrt{3}$ | 1 | 1 | 2.30% | 2.30% | ∞ |
| 19 | Liquid conductivity (target) | B | 5.00% | R | $\sqrt{3}$ | 0.64 | 0.43 | 1.80% | 1.20% | ∞ |
| 20 | Liquid conductivity (meas.) | A | 0.50% | N | 1 | 0.64 | 0.43 | 0.32% | 0.26% | ∞ |
| 21 | Liquid permittivity (target) | B | 5.00% | R | $\sqrt{3}$ | 0.64 | 0.43 | 1.80% | 1.20% | ∞ |
| 22 | Liquid permittivity (meas.) | A | 0.16% | N | 1 | 0.64 | 0.43 | 0.10% | 0.07% | ∞ |
| Combined standard uncertainty | | $u_c = \sqrt{\sum_{i=1}^{22} c_i^2 u_i^2}$ | | / | / | / | / | 9.79% | 9.67% | ∞ |
| Expanded uncertainty (confidence interval of 95 %) | | $u_e = 2u_c$ | | R | K=2 | / | / | 19.57% | 19.34% | ∞ |

| System Check Uncertainty | | | | | | | | | | |
|----------------------------------------------------|--------------------------------------------------------|--------------------------------------------|-------------------|-----------------------|------------|---------|----------|----------------|-----------------|-------------------|
| No. | Error Description | Type | Uncertainty Value | Probably Distribution | Div. | (Ci) 1g | (Ci) 10g | Std. Unc. (1g) | Std. Unc. (10g) | Degree of freedom |
| Measurement System | | | | | | | | | | |
| 1 | Probe calibration | B | 6.0% | N | 1 | 1 | 1 | 6.0% | 6.0% | ∞ |
| 2 | Axial isotropy | B | 4.70% | R | $\sqrt{3}$ | 0.7 | 0.7 | 1.90% | 1.90% | ∞ |
| 3 | Hemispherical isotropy | B | 9.60% | R | $\sqrt{3}$ | 0.7 | 0.7 | 3.90% | 3.90% | ∞ |
| 4 | Boundary Effects | B | 1.00% | R | $\sqrt{3}$ | 1 | 1 | 0.60% | 0.60% | ∞ |
| 5 | Probe Linearity | B | 4.70% | R | $\sqrt{3}$ | 1 | 1 | 2.70% | 2.70% | ∞ |
| 6 | Detection limit | B | 1.00% | R | $\sqrt{3}$ | 1 | 1 | 0.60% | 0.60% | ∞ |
| 7 | RF ambient conditions-noise | B | 0.00% | R | $\sqrt{3}$ | 1 | 1 | 0.00% | 0.00% | ∞ |
| 8 | RF ambient conditions-reflection | B | 0.00% | R | $\sqrt{3}$ | 1 | 1 | 0.00% | 0.00% | ∞ |
| 9 | Response time | B | 0.80% | R | $\sqrt{3}$ | 1 | 1 | 0.50% | 0.50% | ∞ |
| 10 | Integration time | B | 5.00% | R | $\sqrt{3}$ | 1 | 1 | 2.90% | 2.90% | ∞ |
| 11 | RF ambient | B | 3.00% | R | $\sqrt{3}$ | 1 | 1 | 1.70% | 1.70% | ∞ |
| 12 | Probe positioned mech. restrictions | B | 0.40% | R | $\sqrt{3}$ | 1 | 1 | 0.20% | 0.20% | ∞ |
| 13 | Probe positioning with respect to phantom shell | B | 2.90% | R | $\sqrt{3}$ | 1 | 1 | 1.70% | 1.70% | ∞ |
| 14 | Max.SAR evaluation | B | 3.90% | R | $\sqrt{3}$ | 1 | 1 | 2.30% | 2.30% | ∞ |
| System validation source-dipole | | | | | | | | | | |
| 15 | Deviation of experimental dipole from numerical dipole | A | 1.58% | N | 1 | 1 | 1 | 1.58% | 1.58% | ∞ |
| 16 | Dipole axis to liquid distance | A | 1.35% | N | 1 | 1 | 1 | 1.35% | 1.35% | ∞ |
| 17 | Input power and SAR drift | B | 4.00% | R | $\sqrt{3}$ | 1 | 1 | 2.30% | 2.30% | ∞ |
| Phantom and Set-up | | | | | | | | | | |
| 18 | Phantom uncertainty | B | 4.00% | R | $\sqrt{3}$ | 1 | 1 | 2.30% | 2.30% | ∞ |
| 20 | Liquid conductivity (meas.) | A | 0.50% | N | 1 | 0.64 | 0.43 | 0.32% | 0.26% | ∞ |
| 22 | Liquid cpermittivity (meas.) | A | 0.16% | N | 1 | 0.64 | 0.43 | 0.10% | 0.07% | ∞ |
| Combined standard uncertainty | | $u_c = \sqrt{\sum_{i=1}^{22} c_i^2 u_i^2}$ | | / | / | / | / | 8.80% | 8.79% | ∞ |
| Expanded uncertainty (confidence interval of 95 %) | | $u_e = 2u_c$ | | R | K=2 | / | / | 17.59% | 17.58% | ∞ |

6. SAR Measurements System Configuration

6.1. SAR Measurement Set-up

The DASY5 system for performing compliance tests consists of the following items:

A standard high precision 6-axis robot (Stäubli RX family) with controller and software. An arm extension for accommodating the data acquisition electronics (DAE).

A dosimetric probe, i.e. an isotropic E-field probe optimized and calibrated for usage in tissue simulating liquid. The probe is equipped with an optical surface detector system.

A data acquisition electronic (DAE) which performs the signal amplification, signal multiplexing, AD-conversion, offset measurements, mechanical surface detection, collision detection, etc. The unit is battery powered with standard or rechargeable batteries. The signal is optically transmitted to the EOC.

A unit to operate the optical surface detector which is connected to the EOC.

The Electro-Optical Coupler (EOC) performs the conversion from the optical into a digital electric signal of the DAE. The EOC is connected to the DASY5 measurement server.

The DASY5 measurement server, which performs all real-time data evaluation for field measurements and surface detection, controls robot movements and handles safety operation. A computer operating Windows 2003.

DASY5 software and SEMCAD data evaluation software.

Remote control with teach panel and additional circuitry for robot safety such as warning lamps, etc.

The generic twin phantom enabling the testing of left-hand and right-hand usage.

The device holder for handheld Mobile Phones.

Tissue simulating liquid mixed according to the given recipes.

System validation dipoles allowing to validate the proper functioning of the system.

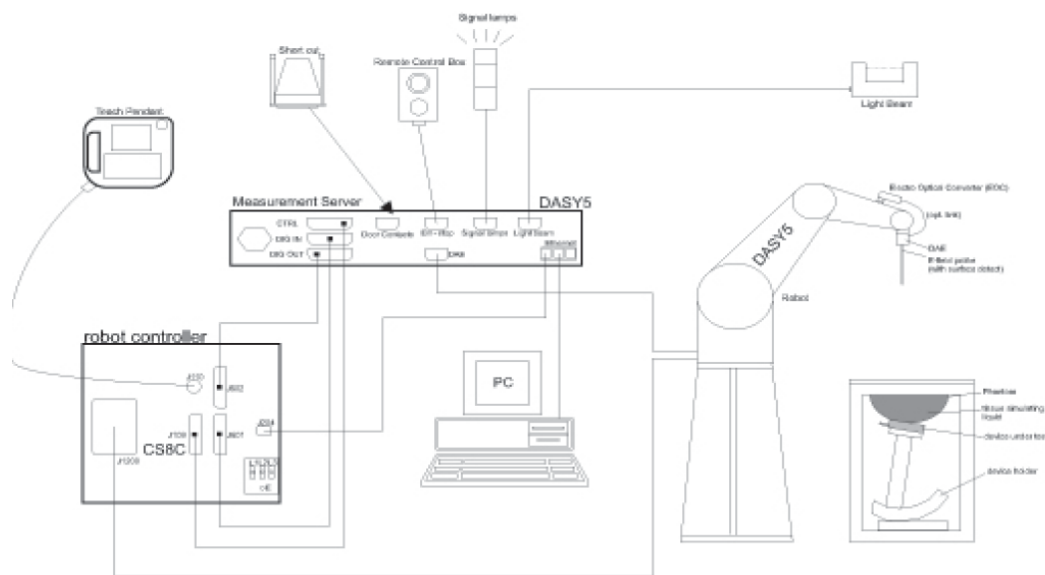

6.2. DASY5 E-field Probe System

The SAR measurements were conducted with the dosimetric probe ES3DV3 (manufactured by SPEAG), designed in the classical triangular configuration and optimized for dosimetric evaluation.

● Probe Specification

Construction Symmetrical design with triangular core
 Interleaved sensors
 Built-in shielding against static charges
 PEEK enclosure material (resistant to organic solvents, e.g., DGBE)

Calibration ISO/IEC 17025 calibration service available.

| | |
|---------------|--------------------------------------------------------------------------------------------------------------------------------|
| Frequency | 10 MHz to 4 GHz; Linearity: ± 0.2 dB (30 MHz to 4 GHz) |
| Directivity | ± 0.2 dB in HSL (rotation around probe axis) ± 0.3 dB in tissue material (rotation normal to probe axis) |
| Dynamic Range | 5 μ W/g to > 100 mW/g; Linearity: ± 0.2 dB |
| Dimensions | Overall length: 337 mm (Tip: 20 mm) Tip diameter: 3.9 mm (Body: 12 mm) Distance from probe tip to dipole centers: 2.0 mm |
| Application | General dosimetry up to 4 GHz Dosimetry in strong gradient fields Compliance tests of Mobile Phones |
| Compatibility | DASY3, DASY4, DASY52 SAR and higher, EASY4/MRI |



● Isotropic E-Field Probe

The isotropic E-Field probe has been fully calibrated and assessed for isotropicity, and boundary effect within a controlled environment. Depending on the frequency for which the probe is calibrated the method utilized for calibration will change.

The E-Field probe utilizes a triangular sensor arrangement as detailed in the diagram below:

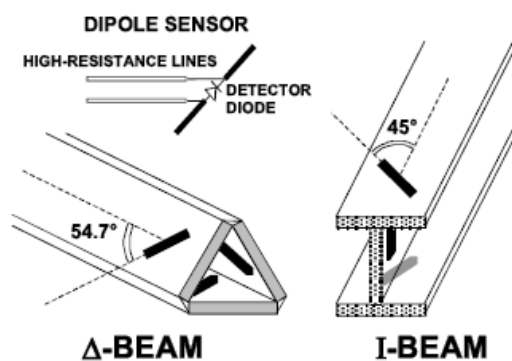

6.3. Phantoms

The phantom used for all tests i.e. for both system checks and device testing, was the twin-headed "SAM Phantom", manufactured by SPEAG. The SAM twin phantom is a fiberglass shell phantom with 2mm shell thickness (except the ear region, where shell thickness increases to 6mm).

System checking was performed using the flat section, whilst Head SAR tests used the left and right head profile sections. Body SAR testing also used the flat section between the head profiles.



SAM Twin Phantom

6.4. Device Holder

The device was placed in the device holder (illustrated below) that is supplied by SPEAG as an integral part of the DASY system.

The DASY device holder is designed to cope with the different positions given in the standard. It has two scales for device rotation (with respect to the body axis) and device inclination (with respect to the line between the ear reference points). The rotation centers for both scales is the ear reference point (ERP). Thus the device needs no repositioning when changing the angles.



Device holder supplied by SPEAG

7. SAR Test Procedure

7.1. Scanning Procedure

The DASY5 installation includes predefined files with recommended procedures for measurements and validation. They are read-only document files and destined as fully defined but unmeasured masks. All test positions (head or body-worn) are tested with the same configuration of test steps differing only in the grid definition for the different test positions.

The “reference” and “drift” measurements are located at the beginning and end of the batch process. They measure the field drift at one single point in the liquid over the complete procedure. The indicated drift is mainly the variation of the DUT’s output power and should vary max. $\pm 5\%$.

The “surface check” measurement tests the optical surface detection system of the DASY5 system by repeatedly detecting the surface with the optical and mechanical surface detector and comparing the results. The output gives the detecting heights of both systems, the difference between the two systems and the standard deviation of the detection repeatability. Air bubbles or refraction in the liquid due to separation of the sugar-water mixture gives poor repeatability (above $\pm 0.1\text{mm}$). To prevent wrong results tests are only executed when the liquid is free of air bubbles. The difference between the optical surface detection and the actual surface depends on the probe and is specified with each probe (It does not depend on the surface reflectivity or the probe angle to the surface within $\pm 30^\circ$.)

Area Scan

The Area Scan is used as a fast scan in two dimensions to find the area of high field values before running a detailed measurement around the hot spot. Before starting the area scan a grid spacing of 15 mm x 15 mm is set. During the scan the distance of the probe to the phantom remains unchanged. After finishing area scan, the field maxima within a range of 2 dB will be ascertained.

Zoom Scan

Zoom Scans are used to estimate the peak spatial SAR values within a cubic averaging volume containing 1 g and 10 g of simulated tissue. The default Zoom Scan is done by 7x7x5 points within a cube whose base is centered around the maxima found in the preceding area scan.

Spatial Peak Detection

The procedure for spatial peak SAR evaluation has been implemented and can determine values of masses of 1g and 10g, as well as for user-specific masses. The DASY5 system allows evaluations that combine measured data and robot positions, such as: • maximum search • extrapolation • boundary correction • peak search for averaged SAR. During a maximum search, global and local maxima searches are automatically performed in 2-D after each Area Scan measurement with at least 6 measurement points. It is based on the evaluation of the local SAR gradient calculated by the Quadratic Shepard’s method. The algorithm will find the global maximum and all local maxima within -2 dB of the global maxima for all SAR distributions.

Extrapolation routines are used to obtain SAR values between the lowest measurement points and the inner phantom surface. The extrapolation distance is determined by the surface detection distance and the probe sensor offset. Several measurements at different distances are necessary for the extrapolation. Extrapolation routines require at least 10 measurement points in 3-D space. They are used in the Zoom Scan to obtain SAR values between the lowest measurement points and the inner phantom surface. The routine uses the modified Quadratic Shepard’s method for extrapolation. For a grid using 7x7x5 measurement points with 5mm resolution amounting to 343 measurement points, the uncertainty of the extrapolation routines is less than 1% for 1g and 10g cubes.

A Z-axis scan measures the total SAR value at the x-and y-position of the maximum SAR value found during the cube 7x7x5 scan. The probe is moved away in z-direction from the bottom of the SAM phantom in 5mm steps.

7.2. Data Storage and Evaluation

Data Storage

The DASY5 software stores the acquired data from the data acquisition electronics as raw data (in microvolt readings from the probe sensors),s together with all necessary software parameters for the data evaluation (probe calibration data, liquid parameters and device frequency and modulation data) in measurement files with the extension “.DA4”. The software evaluates the desired unit and format for output each time the data is visualized or exported. This allows verification of the complete software setup even after the measurement and allows correction of incorrect parameter settings. For example, if a measurement has been performed with a wrong crest factor parameter in the device setup, the parameter can be corrected afterwards and the data can be re-evaluated.

The measured data can be visualized or exported in different units or formats, depending on the selected probe type ([V/m], [A/m], [°C], [mW/g], [mW/cm²], [dBrel], etc.). Some of these units are not available in certain situations or show meaningless results, e.g., a SAR output in a lossless media will always be zero. Raw data can also be exported to perform the evaluation with other software packages.

Data Evaluation

The SEMCAD software automatically executes the following procedures to calculate the field units from the microvolt readings at the probe connector. The parameters used in the evaluation are stored in the configuration modules of the software:

| | | |
|--------------------|--------------------------|----------------------|
| Probe parameters: | Sensitivity: | Normi, ai0, ai1, ai2 |
| | Conversion factor: | ConvFi |
| | Diode compression point: | Dcpi |
| Device parameters: | Frequency: | f |
| | Crest factor: | cf |
| Media parameters: | Conductivity: | σ |
| | Density: | ρ |

These parameters must be set correctly in the software. They can be found in the component documents or they can be imported into the software from the configuration files issued for the DASY5 components. In the direct measuring mode of the multimeter option, the parameters of the actual system setup are used. In the scan visualization and export modes, the parameters stored in the corresponding document files are used.

The first step of the evaluation is a linearization of the filtered input signal to account for the compression characteristics of the detector diode. The compensation depends on the input signal, the diode type and the DC-transmission factor from the diode to the evaluation electronics. If the exciting field is pulsed, the crest factor of the signal must be known to correctly compensate for peak power. The formula for each channel can be given as:

$$V_i = U_i + U_i^2 \cdot \frac{cf}{dcp_i}$$

| | |
|--------------------|-------------------------------------------------|
| Vi: | compensated signal of channel (i = x, y, z) |
| Ui: | input signal of channel (i = x, y, z) |
| cf: | crest factor of exciting field (DASY parameter) |
| dcp _i : | diode compression point (DASY parameter) |

From the compensated input signals the primary field data for each channel can be evaluated:

$$E - \text{fieldprobes} : \quad E_i = \sqrt{\frac{V_i}{Norm_i \cdot ConvF}}$$

$$H - \text{fieldprobes} : \quad H_i = \sqrt{V_i} \cdot \frac{a_{i0} + a_{i1}f + a_{i2}f^2}{f}$$

| | |
|---------------------|-----------------------------------------------------------------------------------------------|
| Vi: | compensated signal of channel (i = x, y, z) |
| Norm _i : | sensor sensitivity of channel (i = x, y, z), [mV/(V/m) ²] for E-field Probes |
| ConvF: | sensitivity enhancement in solution |
| a _{ij} : | sensor sensitivity factors for H-field probes |
| f: | carrier frequency [GHz] |
| E _i : | electric field strength of channel i in V/m |
| H _i : | magnetic field strength of channel i in A/m |

The RSS value of the field components gives the total field strength (Hermitian magnitude):

$$E_{tot} = \sqrt{E_x^2 + E_y^2 + E_z^2}$$

The primary field data are used to calculate the derived field units.

$$SAR = E_{tot}^2 \cdot \frac{\sigma}{\rho \cdot 1'000}$$

SAR: local specific absorption rate in mW/g
Etot: total field strength in V/m
 σ : conductivity in [mho/m] or [Siemens/m]
 ρ : equivalent tissue density in g/cm³

Note that the density is normally set to 1 (or 1.06), to account for actual brain density rather than the density of the simulation liquid.

8. Position of the wireless device in relation to the phantom

8.1. Head Position

The wireless device define two imaginary lines on the handset, the vertical centreline and the horizontal line, for the handset in vertical orientation as shown in Figures 5a and 5b.

The vertical centreline passes through two points on the front side of the handset: the midpoint of the width W_t of the handset at the level of the acoustic output (point A in Figures 5a and 5b), and the midpoint of the width W_b of the bottom of the handset (point B).

The horizontal line is perpendicular to the vertical centreline and passes through the centre of the acoustic output (see Figures 5a and 5b). The two lines intersect at point A.

Note that for many handsets, point A coincides with the centre of the acoustic output. However, the acoustic output may be located elsewhere on the horizontal line. Also note that the vertical centreline is not necessarily parallel to the front face of the handset (see Figure 5b), especially for clam-shell handsets, handsets with flip cover pieces, and other irregularly shaped handsets.

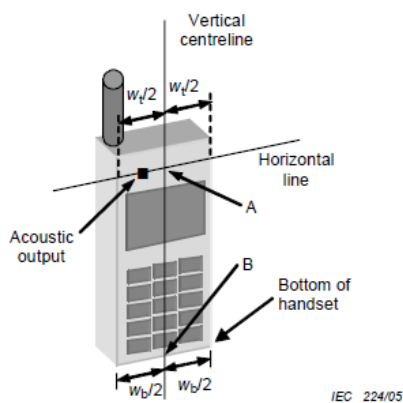

Figures 5a

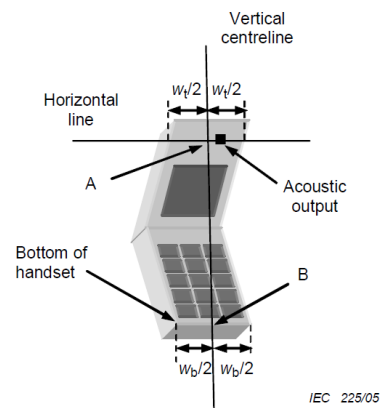

Figures 5b

- W_t Width of the handset at the level of the acoustic
- W_b Width of the bottom of the handset
- A Midpoint of the width w_t of the handset at the level of the acoustic output
- B Midpoint of the width w_b of the bottom of the handset

Cheek position

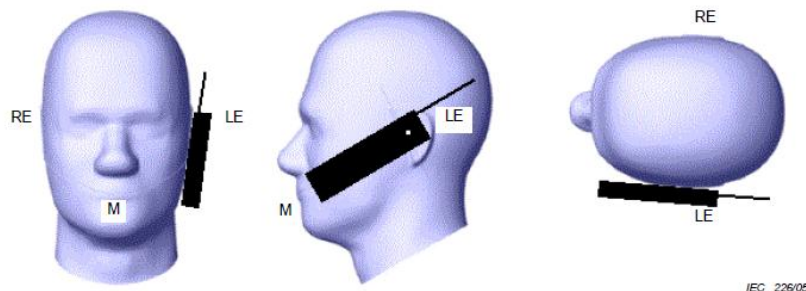

Picture 2 Cheek position of the wireless device on the left side of SAM

Tilt position

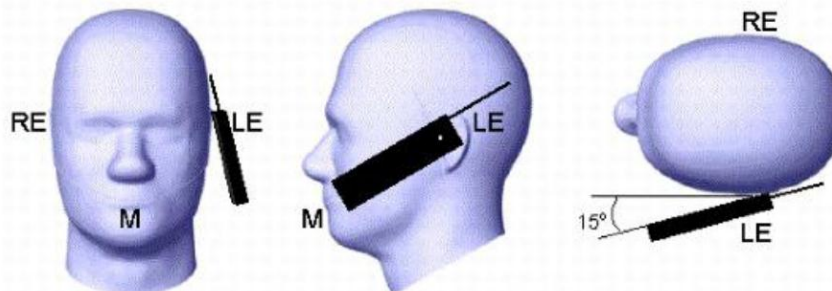

Picture 3 Tilt position of the wireless device on the left side of SAM

8.2. Body Position

Devices that support transmission while used with body-worn accessories must be tested for body-worn accessory SAR compliance, typically according to the smallest test separation distance required for the group of body-worn accessories with similar operating and exposure characteristics. Devices that are designed to operate on the body of users using lanyards and straps or without requiring additional body-worn accessories must be tested for SAR compliance using a conservative minimum test separation distance $\leq 5 \text{ mm}$ to support compliance

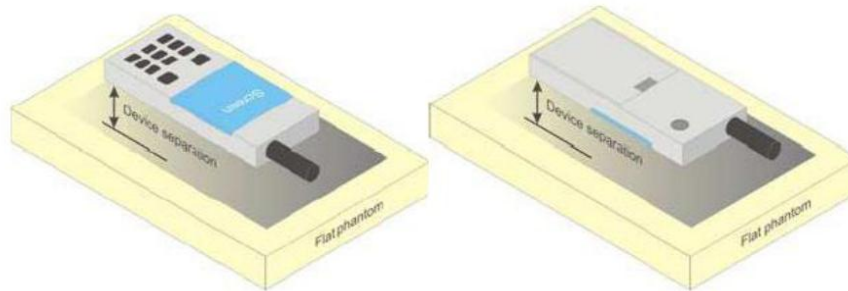

Picture 4 Test positions for body-worn devices

8.3. Hotspot Mode Exposure conditions

The hotspot mode and body-worn accessory SAR test configurations may overlap for handsets. When the same wireless mode transmission configurations for voice and data are required for SAR measurements, the more conservative configuration with a smaller separation distance should be tested for the overlapping SAR configurations. This typically applies to the back and front surfaces of a handset when SAR is required for both hotspot mode and body-worn accessory exposure conditions. Depending on the form factor and dimensions of a device, the test separation distance used for hotspot mode SAR measurement is either **10 mm** or that used in the body-worn accessory configuration, whichever is less for devices with dimension $> 9 \text{ cm} \times 5 \text{ cm}$. For smaller devices with dimensions $\leq 9 \text{ cm} \times 5 \text{ cm}$ because of a greater potential for next to body use a test separation of $\leq 5 \text{ mm}$ must be used.

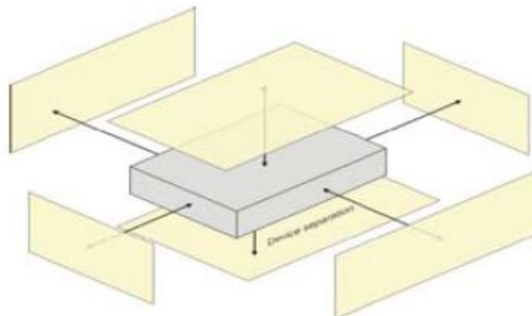

Picture 5 Test positions for Hotspot Mode

9. System Check

9.1. Tissue Dielectric Parameters

The liquid is consisted of water,salt,Glycol,Sugar,Preventol and Cellulose.The liquid has previously been proven to be suited for worst-case.The table 3 and table 4 show the detail solition.It's satisfying the latest tissue dielectric parameters requirements proposed by the KDB865664.

| Frequency (MHz) | Water (%) | Sugar (%) | Cellulose (%) | Salt (%) | Preventol (%) | DGBE (%) | Conductivity (σ) | Permittivity (ϵ_r) |
|-----------------|-----------|-----------|---------------|----------|---------------|----------|---------------------------|-------------------------------|
| For Head | | | | | | | | |
| 835 | 40.3 | 57.9 | 0.2 | 1.4 | 0.2 | 0 | 0.9 | 41.5 |
| 1800,1900,2000 | 55.2 | 0 | 0 | 0.3 | 0 | 44.5 | 1.4 | 40 |
| 2450 | 55 | 0 | 0 | 0 | 0 | 45 | 1.8 | 39.2 |
| For Body | | | | | | | | |
| 835 | 50.8 | 48.2 | 0 | 0.9 | 0.1 | 0 | 0.97 | 55.2 |
| 1800.1900.2000 | 70.2 | 0 | 0 | 0.4 | 0 | 29.4 | 1.52 | 53.3 |
| 2450 | 68.6 | 0 | 0 | 0 | 0 | 31.4 | 1.95 | 52.7 |

| Tissue dielectric parameters for head and body phantoms | | | | |
|---------------------------------------------------------|--------------|----------------|--------------|----------------|
| Target Frequency (MHz) | Head | | Body | |
| | ϵ_r | σ (s/m) | ϵ_r | σ (s/m) |
| 835 | 41.5 | 0.90 | 55.2 | 0.97 |
| 1800-2000 | 40.0 | 1.40 | 53.3 | 1.52 |
| 2450 | 39.2 | 1.80 | 52.7 | 1.95 |

Check Result:

| Dielectric performance of Head tissue simulating liquid | | | | |
|----------------------------------------------------------------|----------------------------------|-------------------------|----------------------|------|
| Frequency (MHz) | Description | DielectricParameters | | Temp |
| | | ϵ_r | σ (s/m) | °C |
| 835 | Recommended result ±5% window | 41.50 39.43 to 43.58 | 0.90 0.86 to 0.95 | / |
| | Measurement value 2017-04-03 | 41.52 | 0.90 | 21 |
| 1900 | Recommended result ±5% window | 40.0 38.00 to 42.00 | 1.40 1.33 to 1.47 | / |
| | Measurement value 2017-04-04 | 40.12 | 1.41 | 21 |
| 2450 | Recommended result ±5% window | 39.2 37.24 to 41.16 | 1.80 1.71 to 1.89 | / |
| | Measurement value 2017-04-05 | 39.10 | 1.79 | 21 |

| Dielectric performance of Body tissue simulating liquid | | | | |
|----------------------------------------------------------------|----------------------------------|------------------------|----------------------|------|
| Frequency (MHz) | Description | DielectricParameters | | Temp |
| | | ϵ_r | σ (s/m) | °C |
| 835 | Recommended result ±5% window | 55.2 52.44 to 57.96 | 0.97 0.92 to 1.02 | / |
| | Measurement value 2017-04-03 | 55.15 | 0.96 | 21 |
| 1900 | Recommended result ±5% window | 53.3 50.64 to 55.97 | 1.52 1.44 to 1.60 | / |
| | Measurement value 2017-04-04 | 53.12 | 1.52 | 21 |
| 2450 | Recommended result ±5% window | 52.7 50.07 to 55.34 | 1.95 1.85 to 2.05 | / |
| | Measurement value 2017-04-05 | 52.55 | 1.94 | 21 |

9.2. SAR System Check

The purpose of the system check is to verify that the system operates within its specifications at the device test frequency. The system check is simple check of repeatability to make sure that the system works correctly at the time of the compliance test;

System check results have to be equal or near the values determined during dipole calibration with the relevant liquids and test system ($\pm 10\%$).

System check is performed regularly on all frequency bands where tests are performed with the DASY5 system.

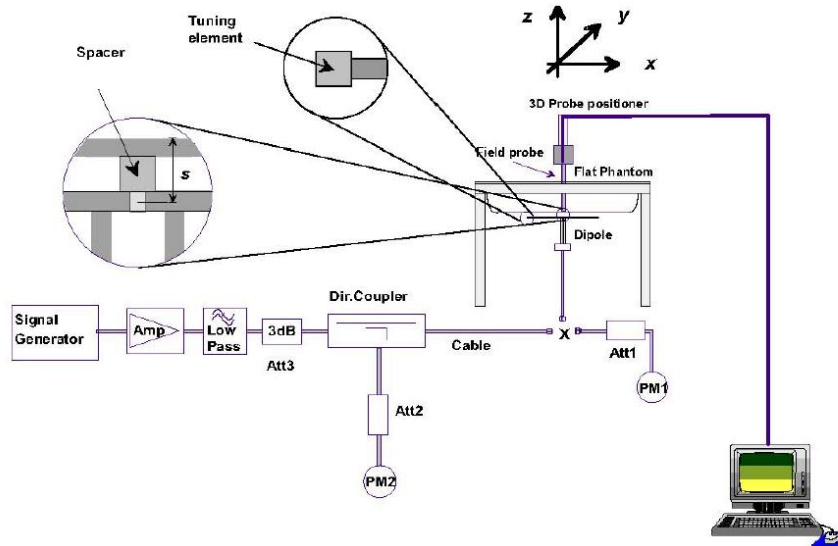

The output power on dipole port must be calibrated to 24 dBm (250mW) before dipole is connected.

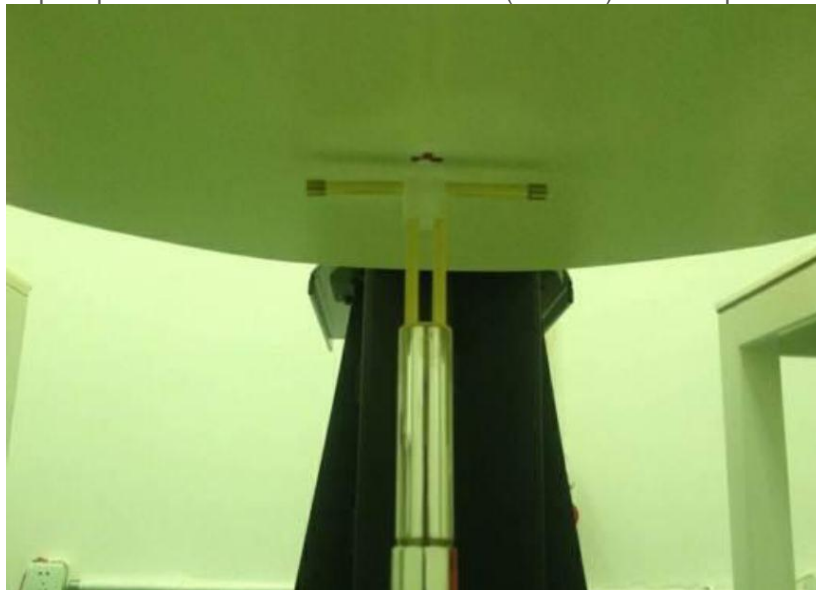

Photo of Dipole Setup

Check Result:

| Head | | | | |
|-----------------|----------------------------------|-----------------------|---------------------|------|
| Frequency (MHz) | Description | SAR(W/kg) | | Temp |
| | | 1g | 10g | °C |
| 835 | Recommended result ±5% window | 2.41 2.29 - 2.53 | 1.57 1.49 - 1.65 | / |
| | Measurement value 2017-04-03 | 2.43 | 1.58 | 21 |
| 1900 | Recommended result ±5% window | 10.10 9.60 - 10.61 | 5.34 5.07 - 5.61 | / |
| | Measurement value 2017-04-04 | 10.02 | 5.11 | 21 |
| 2450 | Recommended result ±5% window | 13.1 11.79 - 14.41 | 6.17 5.56 - 6.78 | / |
| | Measurement value 2017-04-05 | 13.35 | 6.25 | 21 |

| Body | | | | |
|-----------------|----------------------------------|-----------------------|---------------------|------|
| Frequency (MHz) | Description | SAR(W/kg) | | Temp |
| | | 1g | 10g | °C |
| 835 | Recommended result ±5% window | 2.47 2.35 - 2.59 | 1.64 1.55 - 1.71 | / |
| | Measurement value 2017-04-03 | 2.52 | 1.65 | 21 |
| 1900 | Recommended result ±5% window | 10.20 9.69 - 10.71 | 5.47 5.20 - 5.74 | / |
| | Measurement value 2017-04-04 | 10.2 | 5.33 | 21 |
| 2450 | Recommended result ±5% window | 13.1 11.79 - 14.41 | 6.11 5.50 - 6.72 | / |
| | Measurement value 2017-04-05 | 13.2 | 6.13 | 21 |

Note:

1. the graph results see follow.
2. Recommended Values used derive from the calibration certificate and 250 mW is used as feeding power to the calibrated dipole.

System Performance Check at 835 MHz Head

DUT: Dipole 835 MHz; Type: D835V2; Serial: 4d134

Date:2017-04-03

Communication System: CW; Frequency: 835 MHz;Duty Cycle: 1:1

Medium parameters used (interpolated): $f = 835$ MHz; $\sigma = 0.90$ S/m; $\epsilon_r = 41.52$; $\rho = 1000$ kg/m³

Phantom section: Flat Section

DASY5 Configuration:

•Probe: ES3DV3 - SN3292; ConvF(6.53, 6.53, 6.53); Calibrated: 02/09/2016;

•Sensor-Surface: 4mm (Mechanical Surface Detection)

•Electronics: DAE4 Sn1315; Calibrated: 26/07/2016

•Phantom: SAM 1; Type: SAM;

•Measurement SW: DASY52, Version 52.8 (2); SEMCAD X Version 14.6.6 (6824)

Area Scan (61x91x1):Measurement grid: dx=15.00 mm, dy=15.00 mm

Maximum value of SAR (interpolated) = 2.58 mW/g

Zoom Scan (5x5x7)/Cube 0: Measurement grid: dx=7mm, dy=7mm, dz=5mm

Reference Value = 52.82 V/m; Power Drift = 0.03 dB

Peak SAR (extrapolated) = 3.66 W/kg

SAR(1 g) = 2.43 mW/g; SAR(10 g) = 1.58 mW/g

Maximum value of SAR (measured) = 2.59 mW/g

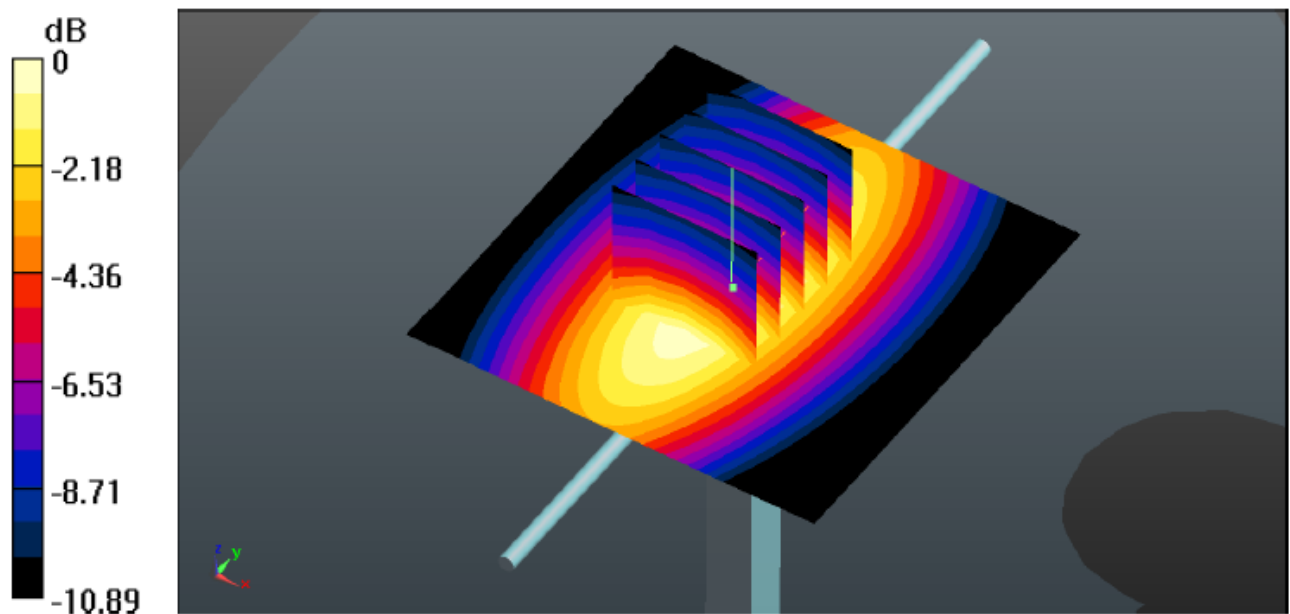

System Performance Check 835MHz Head 250mW

System Performance Check at 835 MHz Body

DUT: Dipole 835 MHz; Type: D835V2; Serial: 4d134

Date:2017-04-03

Communication System: CW; Frequency: 835 MHz;Duty Cycle: 1:1

Medium parameters used (interpolated): $f = 835$ MHz; $\sigma = 0.96$ S/m; $\epsilon_r = 55.15$; $\rho = 1000$ kg/m³

Phantom section: Flat Section

DASY5 Configuration:

- Probe: ES3DV3 - SN3292; ConvF(6.27, 6.27, 6.27); Calibrated: 02/09/2016;
- Sensor-Surface: 4mm (Mechanical Surface Detection)
- Electronics: DAE4 Sn1315; Calibrated: 26/07/2016
- Phantom: SAM 1; Type: SAM;
- Measurement SW: DASY52, Version 52.8 (2); SEMCAD X Version 14.6.6 (6824)

Area Scan (61x91x1):Measurement grid: dx=15.00 mm, dy=15.00 mm

Maximum value of SAR (interpolated) = 2.45 mW/g

Zoom Scan (5x5x7)/Cube 0: Measurement grid: dx=7mm, dy=7mm, dz=5mm

Reference Value = 51.00 V/m; Power Drift = -0.07 dB

Peak SAR (extrapolated) = 3.70 W/kg

SAR(1 g) = 2.52 mW/g; SAR(10 g) = 1.65 mW/g

Maximum value of SAR (measured) = 2.94 W/kg

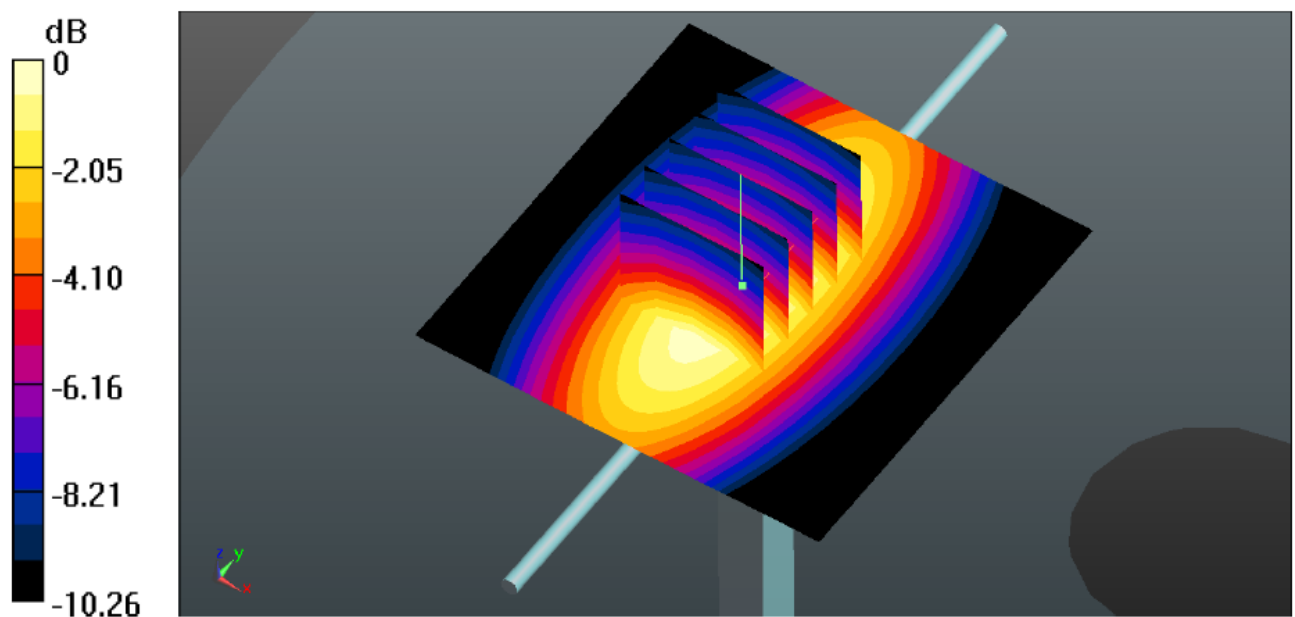

System Performance Check 835MHz Body 250mW

System Performance Check at 1900 MHz Head

DUT: Dipole 1900 MHz; Type: D1900V2; Serial: 5d150
Date:2017-04-04

Communication System: CW; Frequency: 1900 MHz;Duty Cycle: 1:1

Medium parameters used (interpolated): $f = 1900$ MHz; $\sigma = 1.41$ S/m; $\epsilon_r = 40.12$; $\rho = 1000$ kg/m³

Phantom section: Flat Section

DASY5 Configuration:

Probe: ES3DV3 - SN3292; ConvF(5.26,5.26,5.26); Calibrated: 02/09/2016;

Sensor-Surface: 3mm (Mechanical Surface Detection)

Electronics: DAE4 Sn1315; Calibrated: 26/07/2016

Phantom: SAM 1; Type: SAM;

Measurement SW: DASY52, Version 52.8 (1); SEMCAD X Version 14.6.5 (6469)

Area Scan (61x91x1):Measurement grid: dx=15.00 mm, dy=15.00 mm

Maximum value of SAR (interpolated) = 10.65 W/kg

Zoom Scan (5x5x7)/Cube 0: Measurement grid: dx=7mm, dy=7mm, dz=5mm

Reference Value = 73.83 V/m; Power Drift = -0.15 Db

Peak SAR (extrapolated) = 12.352 W/kg

SAR(1 g) = 10.02 mW/g; SAR(10 g) = 5.11 mW/g

Maximum value of SAR (measured) = 12.43 W/kg

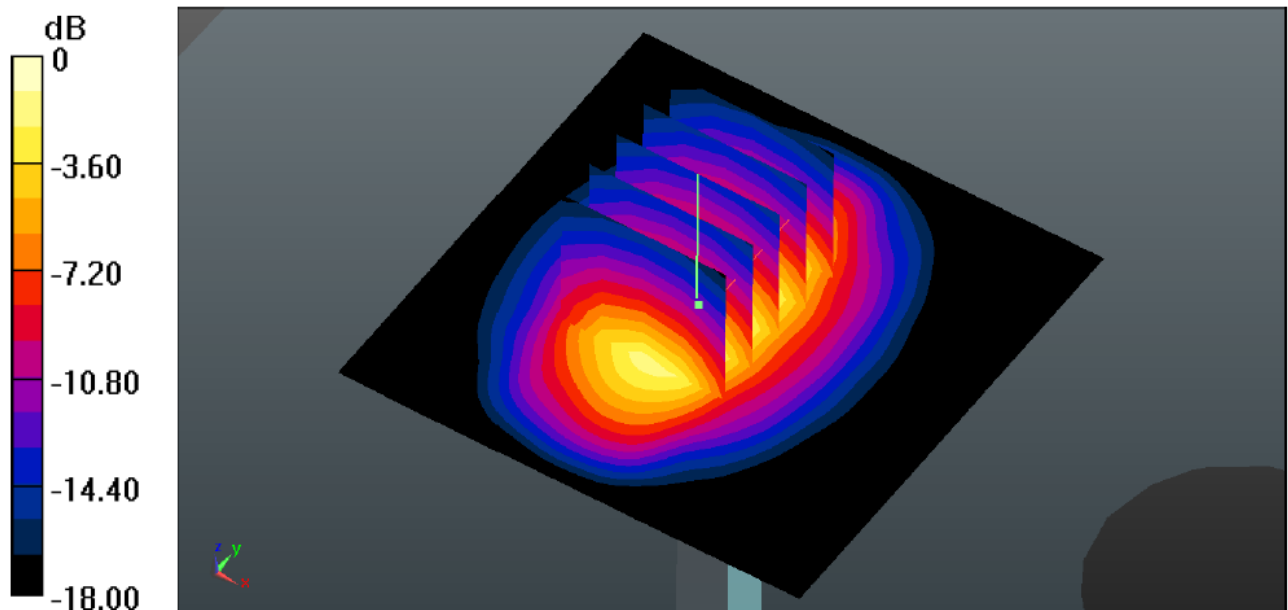

System Performance Check 1900MHz Head 250mW

System Performance Check at 1900 MHz Body

DUT: Dipole 1900 MHz; Type: D1900V2; Serial: 5d150
Date:2017-04-04

Communication System: CW; Frequency: 1900 MHz;Duty Cycle: 1:1

Medium parameters used (interpolated): $f = 1900$ MHz; $\sigma = 1.52$ S/m; $\epsilon_r = 53.12$; $\rho = 1000$ kg/m³

Phantom section: Flat Section

DASY5 Configuration:

Probe: ES3DV3 - SN3292; ConvF(5.05,5.05,5.05); Calibrated: 02/09/2016;

Sensor-Surface: 3mm (Mechanical Surface Detection)

Electronics: DAE4 Sn1315; Calibrated: 26/07/2016

Phantom: SAM 1; Type: SAM;

Measurement SW: DASY52, Version 52.8 (1); SEMCAD X Version 14.6.5 (6469)

Area Scan (61x91x1):Measurement grid: dx=15.00 mm, dy=15.00 mm
Maximum value of SAR (interpolated) = 11.46 mW/g

Zoom Scan (5x5x7)/Cube 0: Measurement grid: dx=7mm, dy=7mm, dz=5mm

Reference Value = 70.21 V/m; Power Drift = -0.11 dB

Peak SAR (extrapolated) = 19.4 W/kg

SAR(1 g) = 10.2 mW/g; SAR(10 g) = 5.33 mW/g

Maximum value of SAR (measured) = 16.4 mW/g

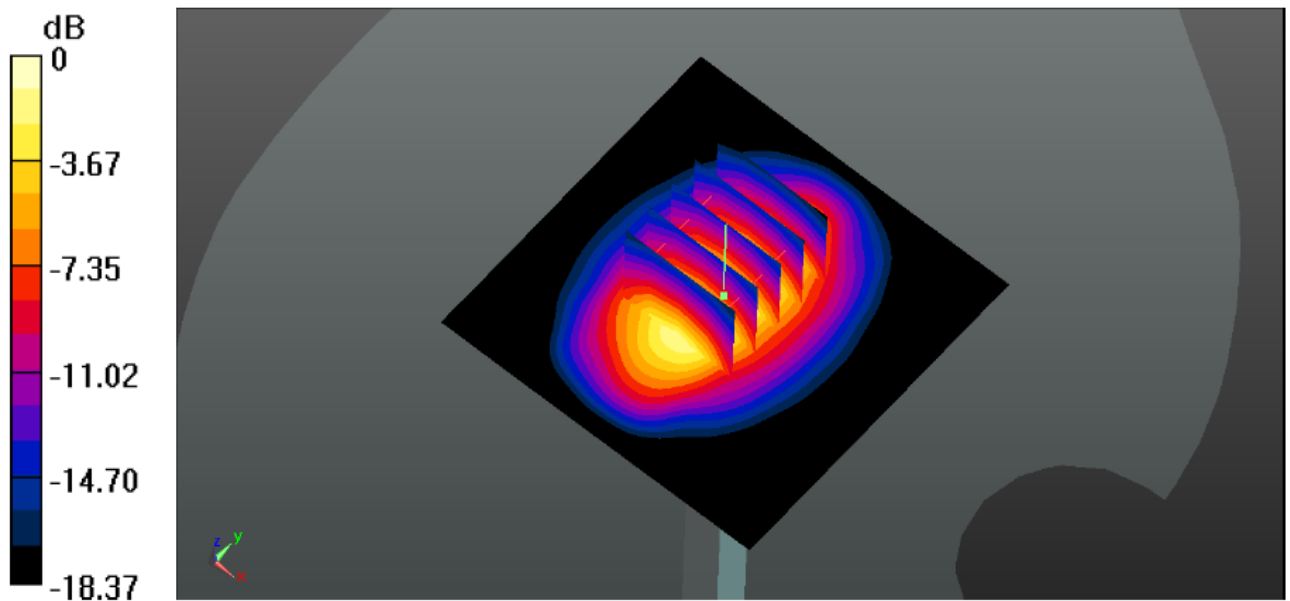

System Performance Check 1900MHz Body250mW

System Performance Check at 2450 MHz Head

DUT: Dipole 2450 MHz; Type: D2450V2; Serial: 884
Date:2017-04-05

Communication System: CW; Frequency: 2450 MHz;Duty Cycle: 1:1

Medium parameters used (interpolated): $f = 2450$ MHz; $\sigma = 1.79$ S/m; $\epsilon_r = 39.10$; $\rho = 1000$ kg/m³

Phantom section: Flat Section

DASY5 Configuration:

Probe: ES3DV3 - SN3292; ConvF(4.97,4.97,4.97); Calibrated: 02/09/2016;

Sensor-Surface: 3mm (Mechanical Surface Detection)

Electronics: DAE4 Sn1315; Calibrated: 26/07/2016

Phantom: SAM 1; Type: SAM;

Measurement SW: DASY52, Version 52.8 (1); SEMCAD X Version 14.6.5 (6469)

Area Scan (61x91x1):Measurement grid: dx=10.00 mm, dy=10.00 mm

Maximum value of SAR (interpolated) = 14.9 mW/g

Zoom Scan (7x7x7)/Cube 0: Measurement grid: dx=5mm, dy=5mm, dz=5mm

Reference Value = 90.57 V/m; Power Drift = 0.06 dB

Peak SAR (extrapolated) = 27.6 W/kg

SAR(1 g) = 13.35 mW/g; SAR(10 g) = 6.25 mW/g

Maximum value of SAR (measured) = 14.5 mW/g

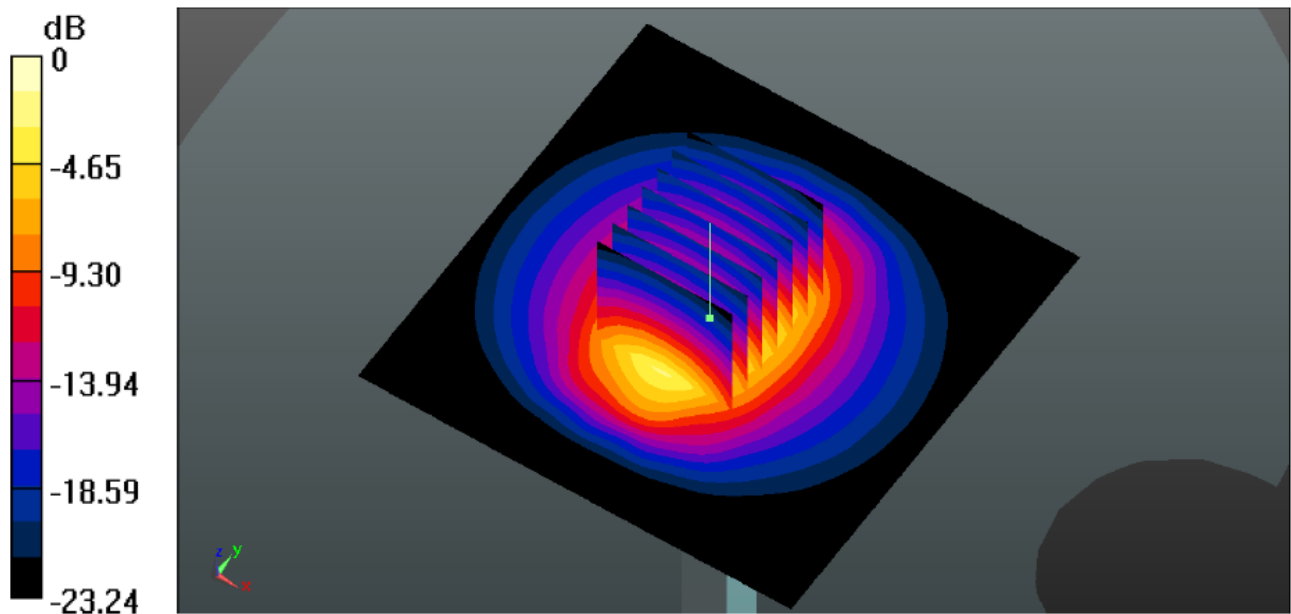

System Performance Check 2450MHz Head250mW

System Performance Check at 2450 MHz Body

DUT: Dipole 2450 MHz; Type: D2450V2; Serial: 884
Date:2017-04-05

Communication System: CW; Frequency: 2450 MHz;Duty Cycle: 1:1

Medium parameters used (interpolated): $f = 2450$ MHz; $\sigma = 1.94$ S/m; $\epsilon_r = 52.55$; $\rho = 1000$ kg/m³

Phantom section: Flat Section

DASY5 Configuration:

Probe: ES3DV3 - SN3292; ConvF(4.70,4.70,4.70); Calibrated: 02/09/2016;

Sensor-Surface: 3mm (Mechanical Surface Detection)

Electronics: DAE4 Sn1315; Calibrated: 26/07/2016

Phantom: SAM 1; Type: SAM;

Measurement SW: DASY52, Version 52.8 (1); SEMCAD X Version 14.6.5 (6469)

Area Scan (61x91x1):Measurement grid: dx=10.00 mm, dy=10.00 mm

Maximum value of SAR (interpolated) = 15.4 mW/g

Zoom Scan (7x7x7)/Cube 0: Measurement grid: dx=5mm, dy=5mm, dz=5mm

Reference Value = 83.63 V/m; Power Drift = -0.15 dB

Peak SAR (extrapolated) = 26.4 W/kg

SAR(1 g) = 13.2 mW/g; SAR(10 g) = 6.13 mW/g

Maximum value of SAR (measured) = 18.5 mW/g

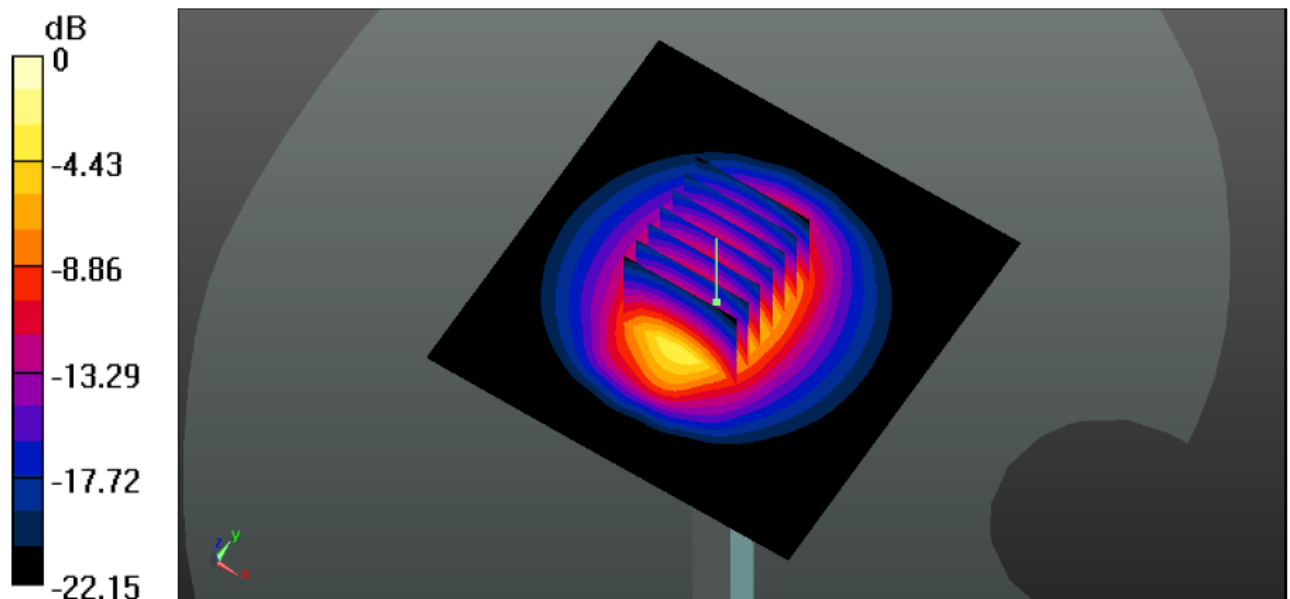

System Performance Check 2450MHz Body250mW

10. SAR Exposure Limits

SAR assessments have been made in line with the requirements of ANSI/IEEE C95.1-1992

| Type Exposure | Limit (mW/g) | |
|---------------------------------------------------------|-----------------------------------------------------------|---------------------------------------------------|
| | General Population / Uncontrolled Exposure Environment | Occupational / Controlled Exposure Environment |
| Spatial Average SAR (whole body) | 0.08 | 0.4 |
| Spatial Peak SAR (1g cube tissue for head and trunk) | 1.60 | 8.0 |
| Spatial Peak SAR (10g for limb) | 4.0 | 20.0 |

Population/Uncontrolled Environments: are defined as locations where there is the exposure of individual who have no knowledge or control of their exposure.

Occupational/Controlled Environments: are defined as locations where there is exposure that may be incurred by people who are aware of the potential for exposure (i.e. as a result of employment or occupation).

11. Conducted Power Measurement Results

GSM Conducted Power

1. Per KDB 447498 D01, the maximum output power channel is used for SAR testing and further SAR test reduction
2. Per KDB 941225 D01, considering the possibility of e.g. 3rd party VoIP operation for Head and Body-worn SAR test reduction for GSM and GPRS modes is determined by the source-base time-averaged output power including tune-up tolerance. The mode with highest specified time-averaged output power should be tested for SAR compliance in the applicable exposure conditions. For modes with the same specified maximum output power and tolerance, the higher number time-slot configuration should be tested. Therefore, the EUT was set in GPRS (4Tx slots) for GSM850 and GPRS (4Tx slots) for PCS1900.
3. Per KDB941225 D01, for hotspot SAR test reduction for GPRS modes is determined by the source-based time-averaged output power including tune-up tolerance, For modes with the same specified maximum output power and tolerance, the higher number time-slot configuration should be tested. Therefore, the EUT was set in GPRS (4Tx slots) for GSM850 and GPRS (4Tx slots) for PCS1900.

| Mode: GSM850 | | Conducted Power (dBm) | | | Division Factors | Averager Power (dBm) | | |
|---------------|----------|-----------------------|-----------|-----------|------------------|----------------------|-----------|-----------|
| | | CH128 | CH190 | CH251 | | CH128 | CH190 | CH251 |
| | | 824.2MHz | 836.6MHz | 848.8MHz | | 824.2MHz | 836.6MHz | 848.8MHz |
| GSM | | 31.84 | 31.82 | 31.75 | -9.03 | 22.81 | 22.79 | 22.72 |
| GPRS (GMSK) | 1TXslot | 31.81 | 31.79 | 31.73 | -9.03 | 22.78 | 22.76 | 22.70 |
| | 2TXslots | 29.32 | 29.38 | 29.31 | -6.02 | 23.30 | 23.36 | 23.29 |
| | 3TXslots | 27.66 | 27.67 | 27.59 | -4.26 | 23.40 | 23.41 | 23.33 |
| | 4TXslots | 26.46 | 26.45 | 26.38 | -3.01 | 23.45 | 23.44 | 23.37 |
| EGPRS (GMSK) | 1TXslot | 31.79 | 31.76 | 31.72 | -9.03 | 22.76 | 22.73 | 22.69 |
| | 2TXslots | 29.30 | 29.35 | 29.30 | -6.02 | 23.28 | 23.33 | 23.28 |
| | 3TXslots | 27.64 | 27.65 | 27.58 | -4.26 | 23.38 | 23.39 | 23.32 |
| | 4TXslots | 26.44 | 26.43 | 26.37 | -3.01 | 23.43 | 23.42 | 23.36 |
| Mode: PCS1900 | | Conducted Power (dBm) | | | Division Factors | Averager Power (dBm) | | |
| | | CH512 | CH661 | CH810 | | CH512 | CH661 | CH810 |
| | | 1850.2MHz | 1880.0MHz | 1909.8MHz | | 1850.2MHz | 1880.0MHz | 1909.8MHz |
| GSM | | 29.35 | 29.34 | 28.92 | -9.03 | 20.32 | 20.31 | 19.89 |
| GPRS (GMSK) | 1TXslot | 29.32 | 29.31 | 28.91 | -9.03 | 20.29 | 20.28 | 19.88 |
| | 2TXslots | 27.03 | 27.09 | 26.70 | -6.02 | 21.01 | 21.07 | 20.68 |
| | 3TXslots | 25.50 | 25.52 | 25.13 | -4.26 | 21.24 | 21.26 | 20.87 |
| | 4TXslots | 24.39 | 24.39 | 24.03 | -3.01 | 21.38 | 21.38 | 21.02 |
| EGPRS (GMSK) | 1TXslot | 29.30 | 29.29 | 28.90 | -9.03 | 20.27 | 20.26 | 19.87 |
| | 2TXslots | 27.01 | 27.07 | 26.69 | -6.02 | 20.99 | 21.05 | 20.67 |
| | 3TXslots | 25.48 | 25.50 | 25.12 | -4.26 | 21.22 | 21.24 | 20.86 |
| | 4TXslots | 24.37 | 24.37 | 24.02 | -3.01 | 21.36 | 21.36 | 21.01 |

Note:

1) Division Factors

To average the power, the division factor is as follows:

1TX-slot = 1 transmit time slot out of 8 time slots=> conducted power divided by (8/1) => -9.03dB

2TX-slots = 2 transmit time slots out of 8 time slots=> conducted power divided by (8/2) => -6.02dB

3TX-slots = 3 transmit time slots out of 8 time slots=> conducted power divided by (8/3) => -4.26dB

4TX-slots = 4 transmit time slots out of 8 time slots=> conducted power divided by (8/4) => -3.01dB

WCDMA Conducted Power

1. The following tests were conducted according to the test requirements outlines in 3GPP TS34.121 specification.
2. The procedures in KDB 941225 D01 are applied for 3GPP Rel. 6 HSPA to configure the device in the required sub-test mode to determine SAR test exclusion

A summary of these settings are illustrated below:

HSDPA Setup Configuration:

- a) The EUT was connected to base station RS CMU200 referred to the setup configuration
- b) The RF path losses were compensated into the measurements
- c) A call was established between EUT and base station with following setting:
 - i. Set Gain Factors (β_c and β_d) and parameters were set according to each specific sub-test in the following table, C10.1.4, Quoted from the TS 34.121
 - ii. Set RMC 12.2Kbps + HSDPA mode
 - iii. Set Cell Power=-86dBm
 - iv. Set HS-DSCH Configuration Type to FRC (H-set 1, QPSK)
 - v. Select HSDPA uplink parameters
 - vi. Set Delta ACK, Delta NACK and Delta CQI=8
 - vii. Set Ack-Nack repetition Factor to 3
 - viii. Set CQI Feedback Cycle (K) to 4ms
 - ix. Set CQI repetition factor to 2
 - x. Power ctrl mode= all up bits
- d) The transmitter maximum output power was recorded.

Table C.10.1.4: β values for transmitter characteristics tests with HS-DPCCH

| Sub-test | β_c | β_d | β_d (SF) | β_c/β_d | β_{HS} (Note 1, Note 2) | CM (dB) (Note 3) | MPR (dB) (Note 3) |
|----------|-------------------|-------------------|-------------------|-------------------|-------------------------------------|---------------------|----------------------|
| 1 | 2/15 | 15/15 | 64 | 2/15 | 4/15 | 0.0 | 0.0 |
| 2 | 12/15 (Note 4) | 15/15 (Note 4) | 64 | 12/15 (Note 4) | 24/15 | 1.0 | 0.0 |
| 3 | 15/15 | 8/15 | 64 | 15/8 | 30/15 | 1.5 | 0.5 |
| 4 | 15/15 | 4/15 | 64 | 15/4 | 30/15 | 1.5 | 0.5 |

Note 1: Δ_{ACK} , Δ_{NACK} and $\Delta_{CQI} = 30/15$ with $\beta_{HS} = 30/15 * \beta_c$.

Note 2: For the HS-DPCCH power mask requirement test in clause 5.2C, 5.7A, and the Error Vector Magnitude (EVM) with HS-DPCCH test in clause 5.13.1A, and HSDPA EVM with phase discontinuity in clause 5.13.1AA, Δ_{ACK} and $\Delta_{NACK} = 30/15$ with $\beta_{HS} = 30/15 * \beta_c$, and $\Delta_{CQI} = 24/15$ with $\beta_{HS} = 24/15 * \beta_c$.

Note 3: CM = 1 for $\beta_c/\beta_d = 12/15$, $\beta_{HS}/\beta_c = 24/15$. For all other combinations of DPDCH, DPCCH and HS-DPCCH the MPR is based on the relative CM difference. This is applicable for only UEs that support HSDPA in release 6 and later releases.

Note 4: For subtest 2 the β_c/β_d ratio of 12/15 for the TFC during the measurement period (TF1, TF0) is achieved by setting the signalled gain factors for the reference TFC (TF1, TF1) to $\beta_c = 11/15$ and $\beta_d = 15/15$.

Setup Configuration

HSUPA Setup Configuration:

- a) The EUT was connected to base station RS CMU200 referred to the setup configuration
- b) The RF path losses were compensated into the measurements
- c) A call was established between EUT and base station with following setting:
 - i. Call configs = 5.2b, 5.9b, 5.10b, and 5.13.2B with QPSK
 - ii. Set Gain Factors (β_c and β_d) and parameters (AG index) were set according to each specific sub-test in the following table, C11.1.3, Quoted from the TS 34.121
 - iii. Set Cell Power=-86dBm
 - iv. Set channel type= 12.2Kbps + HSPA mode
 - v. Set UE Target power
 - vi. Set Ctrl mode=Alternating bits
 - vii. Set and observe the E-TFCI
 - viii. Confirm that E-TFCI is equal the target E-TFCI of 75 for Sub-test 1, and other subtest's E-TFCI
- d) The transmitter maximum output power was recorded.

Table C.11.1.3: β values for transmitter characteristics tests with HS-DPCCH and E-DCH

| Sub-test | β_c | β_d | β_d (SF) | β_c/β_d | β_{HS} (Note 1) | β_{ec} | β_{ed} (Note 5) (Note 6) | β_{ed} (SF) | β_{ed} (Codes) | CM (dB) (Note 2) | MPR (dB) (Note 2) | AG Index (Note 6) | E-TFCI |
|----------|----------------|----------------|----------------|-------------------|-----------------------|--------------|------------------------------------------------|-------------------|----------------------|------------------|-------------------|-------------------|--------|
| 1 | 11/15 (Note 3) | 15/15 (Note 3) | 64 | 11/15 (Note 3) | 22/15 | 209/25 | 1309/225 | 4 | 1 | 1.0 | 0.0 | 20 | 75 |
| 2 | 6/15 | 15/15 | 64 | 6/15 | 12/15 | 12/15 | 94/75 | 4 | 1 | 3.0 | 2.0 | 12 | 67 |
| 3 | 15/15 | 9/15 | 64 | 15/9 | 30/15 | 30/15 | β_{ed1} : 47/15 β_{ed2} : 47/15 | 4 4 | 2 | 2.0 | 1.0 | 15 | 92 |
| 4 | 2/15 | 15/15 | 64 | 2/15 | 4/15 | 2/15 | 56/75 | 4 | 1 | 3.0 | 2.0 | 17 | 71 |
| 5 | 15/15 (Note 4) | 15/15 (Note 4) | 64 | 15/15 (Note 4) | 30/15 | 24/15 | 134/15 | 4 | 1 | 1.0 | 0.0 | 21 | 81 |

Note 1: $\Delta_{ACK}, \Delta_{NACK}$ and $\Delta_{CQI} = 30/15$ with $\beta_{HS} = 30/15 * \beta_c$.

Note 2: CM = 1 for $\beta_c/\beta_d=12/15$, $\beta_{HS}/\beta_c=24/15$. For all other combinations of DPDCH, DPCCH, HS-DPCCH, E-DPDCH and E-DPCCH the MPR is based on the relative CM difference.

Note 3: For subtest 1 the β_c/β_d ratio of 11/15 for the TFC during the measurement period (TF1, TF0) is achieved by setting the signalled gain factors for the reference TFC (TF1, TF1) to $\beta_c = 10/15$ and $\beta_d = 15/15$.

Note 4: For subtest 5 the β_c/β_d ratio of 15/15 for the TFC during the measurement period (TF1, TF0) is achieved by setting the signalled gain factors for the reference TFC (TF1, TF1) to $\beta_c = 14/15$ and $\beta_d = 15/15$.

Note 5: In case of testing by UE using E-DPDCH Physical Layer category 1, Sub-test 3 is omitted according to TS25.306 Table 5.1g.

Note 6: β_{ed} can not be set directly, it is set by Absolute Grant Value.

Setup Configuration**General Note:**

1. Per KDB 941225 D01, SAR for Head / Hotspot / Body-worn Exposure is measured using a 12.2Kbps RMC with TPC bit configured to all 1s
2. Per KDB 941225 D01 RMC12.2Kbps setting is used to evaluate SAR. If the maximum output power and Tune-up tolerance specified for production units in HSDPA/HSUPA is $\leq 1/4$ dB higher than RMC 12.2Kbps or when the highest reported SAR of the RMC12.2Kbps is scaled by the ratio of specified maximum output power and tune-up tolerance of HSDPA / HSUPA to RMC 12.2Kbps and the adjusted SAR is ≤ 1.2 mW/g, SAR measurement is not required for HSDPA / HSUPA.

| Mode | | WCDMA Band V | | | WCDMA Band II | | |
|-----------|-----------|-----------------------|--------|--------|-----------------------|--------|--------|
| | | Conducted Power (dBm) | | | Conducted Power (dBm) | | |
| | | CH4132 | CH4183 | CH4233 | CH9262 | CH9400 | CH9538 |
| | | 826.4 | 836.6 | 846.6 | 1852.4 | 1880.0 | 1907.6 |
| AMR 12.2K | | 22.47 | 22.42 | 22.15 | 22.08 | 22.01 | 22.08 |
| RMC 12.2K | | 22.49 | 22.46 | 22.16 | 22.10 | 22.04 | 22.09 |
| HSDPA | Subtest-1 | 20.66 | 20.61 | 20.37 | 20.30 | 20.24 | 20.30 |
| | Subtest-2 | 20.49 | 20.44 | 20.20 | 20.13 | 20.07 | 20.13 |
| | Subtest-3 | 20.49 | 20.47 | 20.19 | 20.14 | 20.08 | 20.13 |
| | Subtest-4 | 20.22 | 20.18 | 19.94 | 19.87 | 19.81 | 19.87 |
| HSUPA | Subtest-1 | 20.11 | 20.07 | 19.82 | 19.76 | 19.70 | 19.76 |
| | Subtest-2 | 19.95 | 19.91 | 19.67 | 19.61 | 19.54 | 19.61 |
| | Subtest-3 | 19.86 | 19.82 | 19.58 | 19.52 | 19.46 | 19.52 |
| | Subtest-4 | 19.81 | 19.76 | 19.52 | 19.46 | 19.40 | 19.46 |
| | Subtest-5 | 19.75 | 19.71 | 19.47 | 19.41 | 19.35 | 19.41 |

WLAN Conducted Power

For 2.4GHz WLAN SAR testing, highest average RF output power channel for the lowest data rate for 802.11b were for SAR evaluation. 802.11g/n were not investigated since the average putput powers over all channels and data rates were not more than 0.25dB higher than the tested channel in the lowest data rate of 802.11b mode.

| WIFI | | | | | |
|--------------|---------|-----------------|----------------------------|-------------------------------|-----------|
| Mode | Channel | Frequency (MHz) | Conducted Peak Power (dBm) | Conducted Average Power (dBm) | Data rate |
| 802.11b | 01 | 2412 | 16.46 | 14.04 | 1 Mbps |
| | 06 | 2437 | 16.35 | 13.95 | 1 Mbps |
| | 11 | 2462 | 16.71 | 14.24 | 1 Mbps |
| 802.11g | 01 | 2412 | 15.07 | 11.81 | 6 Mbps |
| | 06 | 2437 | 14.80 | 11.56 | 6 Mbps |
| | 11 | 2462 | 15.09 | 11.80 | 6 Mbps |
| 802.11n(H20) | 01 | 2412 | 15.06 | 11.48 | 6.5 Mbps |
| | 06 | 2437 | 14.63 | 11.14 | 6.5 Mbps |
| | 11 | 2462 | 15.18 | 11.56 | 6.5 Mbps |

Note: The output power was test all data rate and recorded worst case at recorded data rate.

Bluetooth Conducted Power

| Bluetooth | | | |
|-----------|---------|-----------------|-----------------------|
| Mode | Channel | Frequency (MHz) | Conducted power (dBm) |
| GFSK | 00 | 2402 | 1.15 |
| | 39 | 2441 | 1.18 |
| | 78 | 2480 | 0.32 |
| π/4QPSK | 00 | 2402 | 1.07 |
| | 39 | 2441 | 1.06 |
| | 78 | 2480 | 0.23 |
| 8DPSK | 00 | 2402 | 1.18 |
| | 39 | 2441 | 1.18 |
| | 78 | 2480 | 0.41 |
| BLE(GFSK) | 0 | 2402 | -6.22 |
| | 19 | 2440 | -6.24 |
| | 39 | 2480 | -7.42 |

Per KDB 447498 D01, the 1-g and 10-g SAR test exclusion thresholds for 100MHz to 6GHz at test separation distances $\leq 50\text{mm}$ are determined by:

$$\left[\frac{\text{(max. Power of channel, including tune-up tolerance, mW)}}{\text{(min. test separation distance, mm)}} \right] * [\sqrt{f(\text{GHz})}] \leq 3.0 \text{ for 1-g SAR}$$

| Band/Mode | F(GHz) | Position | SAR test exclusion threshold (mW) | RF output power | | SAR test exclusion |
|-----------|--------|----------|-----------------------------------|-----------------|-------|--------------------|
| | | | | dBm | mW | |
| Bluetooth | 2.45 | Head | 9.6 | 2 | 1.59 | Yes |
| | | Body | 19.20 | 2 | 1.59 | Yes |
| WiFi | 2.45 | Head | 9.6 | 14.50 | 28.18 | No |
| | | Body | 19.20 | 14.50 | 28.18 | No |

Per KDB 447498 D01, when the minimum test separation distance is $< 5\text{mm}$, a distance of 5mm is applied to determine SAR test exclusion.

The test exclusion threshold is ≤ 3 , SAR testing is not required.

12. Maximum Tune-up Limit

| Mode | Burst Average Power (dBm) | |
|------------------------|---------------------------|---------|
| | GSM850 | PCS1900 |
| GSM (GMSK, 1Tx Slot) | 32.00 | 30.00 |
| GPRS (GMSK, 1Tx Slot) | 32.00 | 30.00 |
| GPRS (GMSK, 2Tx Slot) | 30.00 | 28.00 |
| GPRS (GMSK, 3Tx Slot) | 28.00 | 26.00 |
| GPRS (GMSK, 4Tx Slot) | 27.00 | 25.00 |
| EGPRS (GMSK, 1Tx Slot) | 32.00 | 30.00 |
| EGPRS (GMSK, 2Tx Slot) | 30.00 | 28.00 |
| EGPRS (GMSK, 3Tx Slot) | 28.00 | 26.00 |
| EGPRS (GMSK, 4Tx Slot) | 27.00 | 25.00 |

| Mode | Burst Average Power (dBm) | |
|-----------------|---------------------------|---------------|
| | WCDMA Band V | WCDMA Band II |
| AMR 12.2Kbps | 23.00 | 23.00 |
| RMC 12.2Kbps | 23.00 | 23.00 |
| HSDPA Subtest-1 | 21.00 | 21.00 |
| HSDPA Subtest-2 | 21.00 | 21.00 |
| HSDPA Subtest-3 | 21.00 | 21.00 |
| HSDPA Subtest-4 | 21.00 | 20.50 |
| HSUPA Subtest-1 | 20.50 | 20.00 |
| HSUPA Subtest-2 | 20.50 | 20.00 |
| HSUPA Subtest-3 | 20.50 | 20.00 |
| HSUPA Subtest-4 | 20.50 | 20.00 |
| HSUPA Subtest-5 | 20.50 | 20.00 |

| WLAN | | |
|---------------|------------------|---------------------------|
| Mode | Peak Power (dBm) | Burst Average Power (dBm) |
| 802.11b | 17.00 | 14.50 |
| 802.11g | 15.50 | 12.00 |
| 802.11n(HT20) | 15.50 | 12.00 |

| BT | |
|--------------|----------------------------|
| Mode | Conducted Peak Power (dBm) |
| GFSK | 2.00 |
| π /4QPSK | 2.00 |
| 8DPSK | 2.00 |
| BLE(GFSK) | -6.00 |

13. Antenna Location

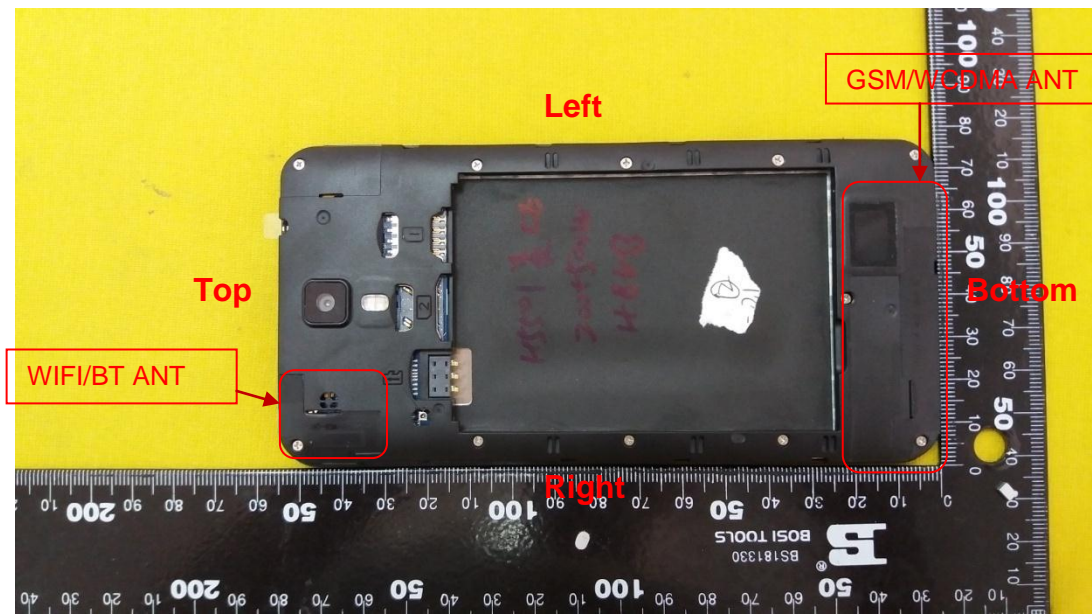

| Positions for SAR tests; Hotspot mode | | | | | | |
|---------------------------------------|------|-------|----------|-------------|------------|-----------|
| Antenna | Back | Front | Top side | Bottom side | Right side | Left side |
| WWAN | Yes | Yes | No | Yes | Yes | Yes |
| WIFI / BT | Yes | Yes | Yes | No | Yes | No |

General note:

Referring to KDB941225 D06, when the overall device length and width are >9cm*5cm, the test distance is 10mm. SAR must be measured for all sides and surfaces with a transmitting antenna located within 25mm from that surface or edge.

14. SAR Measurement Results

Evaluation of multi-SIM for Head Test

| Frequency | | Mode/Band | Side | Test Position | SAR(1g)(W/kg) | Power Drift(dB) | Card Slot |
|-----------|--------|---------------|------|---------------|---------------|-----------------|-------------|
| CH | MHz | | | | | | |
| 9400 | 1880.0 | WCDMA Band II | Left | Cheek | 0.291 | 0.18 | SIM1 |
| 9400 | 1880.0 | WCDMA Band II | Left | Cheek | 0.287 | 0.11 | SIM2 |

Note: According to the values in the above table, the SIM1 is the primary card slot. We'll perform the head measurement with this slot and retest on highest value point with other.

Evaluation of multi-SIM for Body Test

| Frequency | | Mode/Band | Test Position | Spacing (mm) | SAR(1g)(W/kg) | Power Drift(dB) | Card Slot |
|-----------|--------|---------------|---------------|--------------|---------------|-----------------|-------------|
| CH | MHz | | | | | | |
| 9400 | 1880.0 | WCDMA Band II | Back | 10 | 0.667 | 0.01 | SIM1 |
| 9400 | 1880.0 | WCDMA Band II | Back | 10 | 0.648 | 0.06 | SIM2 |

Note: According to the values in the above table, the SIM1 is the primary card slot. We'll perform the Body measurement with this slot and retest on highest value point with other.

Head SAR

| GSM850 | | | | | | | | | | |
|-----------------|---------------|-----------|-------|-----------------------|---------------------|------------------------|-----------------|-------------------------|-----------------------|-----------|
| Mode | Test Position | Frequency | | Conducted Power (dBm) | Tune up limit (dBm) | Tune up scaling factor | Power Drift(dB) | Measured SAR(1g) (mW/g) | Report SAR(1g) (mW/g) | Test Plot |
| | | CH | MHz | | | | | | | |
| GPRS (4Tx slot) | Left-Cheek | 128 | 824.2 | 26.46 | 27.00 | 1.13 | - | - | - | - |
| | | 190 | 836.6 | 26.45 | 27.00 | 1.13 | 0.13 | 0.211 | 0.24 | H1 |
| | | 251 | 848.8 | 26.38 | 27.00 | 1.15 | - | - | - | - |
| | Left-Tilt | 128 | 824.2 | 26.46 | 27.00 | 1.13 | - | - | - | - |
| | | 190 | 836.6 | 26.45 | 27.00 | 1.13 | -0.14 | 0.161 | 0.18 | - |
| | | 251 | 848.8 | 26.38 | 27.00 | 1.15 | - | - | - | - |
| | Right-Cheek | 128 | 824.2 | 26.46 | 27.00 | 1.13 | - | - | - | - |
| | | 190 | 836.6 | 26.45 | 27.00 | 1.13 | -0.06 | 0.199 | 0.23 | - |
| | | 251 | 848.8 | 26.38 | 27.00 | 1.15 | - | - | - | - |
| | Right-Tilt | 128 | 824.2 | 26.46 | 27.00 | 1.13 | - | - | - | - |
| | | 190 | 836.6 | 26.45 | 27.00 | 1.13 | 0.08 | 0.159 | 0.18 | - |
| | | 251 | 848.8 | 26.38 | 27.00 | 1.15 | - | - | - | - |

| PCS1900 | | | | | | | | | | |
|-----------------|---------------|-----------|--------|-----------------------|---------------------|------------------------|-----------------|-------------------------|-----------------------|-----------|
| Mode | Test Position | Frequency | | Conducted Power (dBm) | Tune up limit (dBm) | Tune up scaling factor | Power Drift(dB) | Measured SAR(1g) (mW/g) | Report SAR(1g) (mW/g) | Test Plot |
| | | CH | MHz | | | | | | | |
| GPRS (4Tx slot) | Left-Cheek | 512 | 1850.2 | 24.39 | 25.00 | 1.15 | - | - | - | - |
| | | 661 | 1880.0 | 24.39 | 25.00 | 1.15 | 0.11 | 0.248 | 0.29 | H2 |
| | | 810 | 1909.8 | 24.03 | 25.00 | 1.25 | - | - | - | - |
| | Left-Tilt | 512 | 1850.2 | 24.39 | 25.00 | 1.15 | - | - | - | - |
| | | 661 | 1880.0 | 24.39 | 25.00 | 1.15 | 0.08 | 0.184 | 0.21 | - |
| | | 810 | 1909.8 | 24.03 | 25.00 | 1.25 | - | - | - | - |
| | Right-Cheek | 512 | 1850.2 | 24.39 | 25.00 | 1.15 | - | - | - | - |
| | | 661 | 1880.0 | 24.39 | 25.00 | 1.15 | -0.06 | 0.227 | 0.26 | - |
| | | 810 | 1909.8 | 24.03 | 25.00 | 1.25 | - | - | - | - |
| | Right-Tilt | 512 | 1850.2 | 24.39 | 25.00 | 1.15 | - | - | - | - |
| | | 661 | 1880.0 | 24.39 | 25.00 | 1.15 | -0.07 | 0.174 | 0.20 | - |
| | | 810 | 1909.8 | 24.03 | 25.00 | 1.25 | - | - | - | - |

Note:

Per KDB865664 D01v01r04, Repeated measurement is not required when the original highest measured SAR is < 0.80 mW/g

| WCDMA Band V | | | | | | | | | | |
|---------------|---------------|-----------|-------|-----------------------|---------------------|------------------------|-----------------|-------------------------|-----------------------|-----------|
| Mode | Test Position | Frequency | | Conducted Power (dBm) | Tune up limit (dBm) | Tune up scaling factor | Power Drift(dB) | Measured SAR(1g) (mW/g) | Report SAR(1g) (mW/g) | Test Plot |
| | | CH | MHz | | | | | | | |
| RMC 12.2K bps | Left-Cheek | 4132 | 826.4 | 22.49 | 23.00 | 1.12 | - | - | - | - |
| | | 4183 | 836.6 | 22.46 | 23.00 | 1.13 | 0.03 | 0.162 | 0.18 | H3 |
| | | 4233 | 846.6 | 22.16 | 23.00 | 1.21 | - | - | - | - |
| | Left-Tilt | 4132 | 826.4 | 22.49 | 23.00 | 1.12 | - | - | - | - |
| | | 4183 | 836.6 | 22.46 | 23.00 | 1.13 | 0.03 | 0.133 | 0.15 | - |
| | | 4233 | 846.6 | 22.16 | 23.00 | 1.21 | - | - | - | - |
| | Right-Cheek | 4132 | 826.4 | 22.49 | 23.00 | 1.12 | - | - | - | - |
| | | 4183 | 836.6 | 22.46 | 23.00 | 1.13 | 0.04 | 0.153 | 0.17 | - |
| | | 4233 | 846.6 | 22.16 | 23.00 | 1.21 | - | - | - | - |
| | Right-Tilt | 4132 | 826.4 | 22.49 | 23.00 | 1.12 | - | - | - | - |
| | | 4183 | 836.6 | 22.46 | 23.00 | 1.13 | -0.01 | 0.124 | 0.14 | - |
| | | 4233 | 846.6 | 22.16 | 23.00 | 1.21 | - | - | - | - |

| WCDMA Band II | | | | | | | | | | |
|---------------|---------------|-----------|--------|-----------------------|---------------------|------------------------|-----------------|-------------------------|-----------------------|-----------|
| Mode | Test Position | Frequency | | Conducted Power (dBm) | Tune up limit (dBm) | Tune up scaling factor | Power Drift(dB) | Measured SAR(1g) (mW/g) | Report SAR(1g) (mW/g) | Test Plot |
| | | CH | MHz | | | | | | | |
| RMC 12.2K bps | Left-Cheek | 9262 | 1852.4 | 22.10 | 23.00 | 1.23 | - | - | - | - |
| | | 9400 | 1880.0 | 22.04 | 23.00 | 1.25 | 0.18 | 0.291 | 0.36 | H4 |
| | | 9538 | 1907.6 | 22.09 | 23.00 | 1.23 | - | - | - | - |
| | Left-Tilt | 9262 | 1852.4 | 22.10 | 23.00 | 1.23 | - | - | - | - |
| | | 9400 | 1880.0 | 22.04 | 23.00 | 1.25 | 0.10 | 0.234 | 0.29 | - |
| | | 9538 | 1907.6 | 22.09 | 23.00 | 1.23 | - | - | - | - |
| | Right-Cheek | 9262 | 1852.4 | 22.10 | 23.00 | 1.23 | - | - | - | - |
| | | 9400 | 1880.0 | 22.04 | 23.00 | 1.25 | -0.31 | 0.277 | 0.35 | - |
| | | 9538 | 1907.6 | 22.09 | 23.00 | 1.23 | - | - | - | - |
| | Right-Tilt | 9262 | 1852.4 | 22.10 | 23.00 | 1.23 | - | - | - | - |
| | | 9400 | 1880.0 | 22.04 | 23.00 | 1.25 | -0.09 | 0.212 | 0.26 | - |
| | | 9538 | 1907.6 | 22.09 | 23.00 | 1.23 | - | - | - | - |

Note:

Per KDB865664 D01v01r04, Repeated measurement is not required when the original highest measured SAR is < 0.80 mW/g

| WLAN | | | | | | | | | | |
|------------------|---------------|-----------|------|-----------------------|---------------------|------------------------|-----------------|-------------------------|-----------------------|-----------|
| Mode | Test Position | Frequency | | Conducted Power (dBm) | Tune up limit (dBm) | Tune up scaling factor | Power Drift(dB) | Measured SAR(1g) (mW/g) | Report SAR(1g) (mW/g) | Test Plot |
| | | CH | MHz | | | | | | | |
| 802.11b 1Mbps | Left-Cheek | 01 | 2412 | 14.04 | 14.50 | 1.11 | - | - | - | - |
| | | 06 | 2437 | 13.95 | 14.50 | 1.13 | - | - | - | - |
| | | 11 | 2462 | 14.24 | 14.50 | 1.06 | 0.17 | 0.127 | 0.13 | H5 |
| | Left-Tilt | 01 | 2412 | 14.04 | 14.50 | 1.11 | - | - | - | - |
| | | 06 | 2437 | 13.95 | 14.50 | 1.13 | - | - | - | - |
| | | 11 | 2462 | 14.24 | 14.50 | 1.06 | -0.13 | 0.108 | 0.11 | - |
| | Right-Cheek | 01 | 2412 | 14.04 | 14.50 | 1.11 | - | - | - | - |
| | | 06 | 2437 | 13.95 | 14.50 | 1.13 | - | - | - | - |
| | | 11 | 2462 | 14.24 | 14.50 | 1.06 | -0.09 | 0.116 | 0.12 | - |
| | Right-Tilt | 01 | 2412 | 14.04 | 14.50 | 1.11 | - | - | - | - |
| | | 06 | 2437 | 13.95 | 14.50 | 1.13 | - | - | - | - |
| | | 11 | 2462 | 14.24 | 14.50 | 1.06 | 0.12 | 0.101 | 0.11 | - |

Note:

1. According to the above table, the initial test position for head is "LeftCheek", and its reported SAR is ≤ 0.4W/kg. Thus further SAR measurement is not required for the other (remaining) test positions. Because the reported SAR of the highest measured maximum output power channel for the exposureconfiguration is ≤ 0.8W/kg, no further SAR testing is required for 802.11b DSSS in that exposureconfiguration.
2. Maximum SAR value for 802.11b: 0.198mW/g,
Report SAR value for 802.11g:
 $0.198 * \text{Power} (802.11g) / \text{Power} (802.11b) = 0.198 * 31.623\text{mw} / 15.85\text{mw} = 0.125\text{mw/g} < 1.2\text{mw/g}$

SAR is not required for 802.11g conditions

| WLAN- Scaled Reported SAR | | | | | | | |
|---------------------------|---------------|-----------|------|--------------------|---------------------|-------------------------|--------------------------------|
| Mode | Test Position | Frequency | | Actual duty factor | maximum duty factor | Reported SAR (1g)(W/kg) | Scaled reported SAR (1g)(W/kg) |
| | | CH | MHz | | | | |
| 802.11b 1Mbps | Left-Cheek | 11 | 2462 | 92.73% | 100% | 0.13 | 0.14 |
| | Left-Tilt | 11 | 2462 | 92.73% | 100% | 0.11 | 0.12 |
| | Right-Cheek | 11 | 2462 | 92.73% | 100% | 0.12 | 0.13 |
| | Right-Tilt | 11 | 2462 | 92.73% | 100% | 0.11 | 0.12 |

Note:

1. According to the KDB248227 D01, The reported SAR must be scaled to 100% transmission duty factor to determine compliance at the maximum tune-up tolerance limit. A maximum transmission duty factor of 92.73% is achievable for WLAN in this project.

Body SAR

| GSM850 | | | | | | | | | | |
|-----------------|---------------|-----------|-------|-----------------------|---------------------|------------------------|-----------------|-------------------------|-----------------------|-----------|
| Mode | Test Position | Frequency | | Conducted Power (dBm) | Tune up limit (dBm) | Tune up scaling factor | Power Drift(dB) | Measured SAR(1g) (mW/g) | Report SAR(1g) (mW/g) | Test Plot |
| | | CH | MHz | | | | | | | |
| GPRS (4Tx slot) | Front | 128 | 824.2 | 26.46 | 27.00 | 1.13 | - | - | - | - |
| | | 190 | 836.6 | 26.45 | 27.00 | 1.13 | 0.02 | 0.405 | 0.46 | - |
| | | 251 | 848.8 | 26.38 | 27.00 | 1.15 | - | - | - | - |
| | Back | 128 | 824.2 | 26.46 | 27.00 | 1.13 | - | - | - | - |
| | | 190 | 836.6 | 26.45 | 27.00 | 1.13 | 0.00 | 0.613 | 0.70 | B1 |
| | | 251 | 848.8 | 26.38 | 27.00 | 1.15 | - | - | - | - |

| PCS1900 | | | | | | | | | | |
|-----------------|---------------|-----------|--------|-----------------------|---------------------|------------------------|-----------------|-------------------------|-----------------------|-----------|
| Mode | Test Position | Frequency | | Conducted Power (dBm) | Tune up limit (dBm) | Tune up scaling factor | Power Drift(dB) | Measured SAR(1g) (mW/g) | Report SAR(1g) (mW/g) | Test Plot |
| | | CH | MHz | | | | | | | |
| GPRS (4Tx slot) | Front | 512 | 1850.2 | 24.39 | 25.00 | 1.15 | - | - | - | - |
| | | 661 | 1880.0 | 24.39 | 25.00 | 1.15 | 0.07 | 0.430 | 0.49 | - |
| | | 810 | 1909.8 | 24.03 | 25.00 | 1.25 | - | - | - | - |
| | Back | 512 | 1850.2 | 24.39 | 25.00 | 1.15 | - | - | - | - |
| | | 661 | 1880.0 | 24.39 | 25.00 | 1.15 | -0.1 | 0.659 | 0.76 | B2 |
| | | 810 | 1909.8 | 24.03 | 25.00 | 1.25 | - | - | - | - |

| WCDMA Band V | | | | | | | | | | |
|--------------|---------------|-----------|-------|-----------------------|---------------------|------------------------|-----------------|-------------------------|-----------------------|-----------|
| Mode | Test Position | Frequency | | Conducted Power (dBm) | Tune up limit (dBm) | Tune up scaling factor | Power Drift(dB) | Measured SAR(1g) (mW/g) | Report SAR(1g) (mW/g) | Test Plot |
| | | CH | MHz | | | | | | | |
| RMC 12.2Kbps | Front | 4132 | 826.4 | 22.49 | 23.00 | 1.12 | - | - | - | - |
| | | 4183 | 836.6 | 22.46 | 23.00 | 1.13 | 0.01 | 0.411 | 0.47 | - |
| | | 4233 | 846.6 | 22.16 | 23.00 | 1.21 | - | - | - | - |
| | Back | 4132 | 826.4 | 22.49 | 23.00 | 1.12 | - | - | - | - |
| | | 4183 | 836.6 | 22.46 | 23.00 | 1.13 | -0.03 | 0.578 | 0.65 | B3 |
| | | 4233 | 846.6 | 22.16 | 23.00 | 1.21 | - | - | - | - |

| WCDMA Band II | | | | | | | | | | |
|---------------|---------------|-----------|--------|-----------------------|---------------------|------------------------|-----------------|-------------------------|-----------------------|-----------|
| Mode | Test Position | Frequency | | Conducted Power (dBm) | Tune up limit (dBm) | Tune up scaling factor | Power Drift(dB) | Measured SAR(1g) (mW/g) | Report SAR(1g) (mW/g) | Test Plot |
| | | CH | MHz | | | | | | | |
| RMC 12.2Kbps | Front | 9262 | 1852.4 | 22.10 | 23.00 | 1.23 | - | - | - | - |
| | | 9400 | 1880.0 | 22.04 | 23.00 | 1.25 | 0.00 | 0.458 | 0.57 | - |
| | | 9538 | 1907.6 | 22.09 | 23.00 | 1.23 | - | - | - | - |
| | Back | 9262 | 1852.4 | 22.10 | 23.00 | 1.23 | 0.06 | 0.656 | 0.81 | - |
| | | 9400 | 1880.0 | 22.04 | 23.00 | 1.25 | 0.01 | 0.667 | 0.83 | B4 |
| | | 9538 | 1907.6 | 22.09 | 23.00 | 1.23 | 0.12 | 0.645 | 0.80 | - |

Note:

- Per KDB865664 D01, Repeated measurement is not required when the original highest measured SAR is < 0.80 mW/g

| WLAN | | | | | | | | | | |
|------------------|---------------|-----------|------|-----------------------|---------------------|------------------------|-----------------|-------------------------|-----------------------|-----------|
| Mode | Test Position | Frequency | | Conducted Power (dBm) | Tune up limit (dBm) | Tune up scaling factor | Power Drift(dB) | Measured SAR(1g) (mW/g) | Report SAR(1g) (mW/g) | Test Plot |
| | | CH | MHz | | | | | | | |
| 802.11b 1Mbps | Front | 1 | 2412 | 14.04 | 14.50 | 1.11 | - | - | - | - |
| | | 6 | 2437 | 13.95 | 14.50 | 1.13 | - | - | - | - |
| | | 11 | 2462 | 14.24 | 14.50 | 1.06 | 0.15 | 0.059 | 0.06 | - |
| | Back | 1 | 2412 | 14.04 | 14.50 | 1.11 | - | - | - | - |
| | | 6 | 2437 | 13.95 | 14.50 | 1.13 | - | - | - | - |
| | | 11 | 2462 | 14.24 | 14.50 | 1.06 | -0.10 | 0.096 | 0.10 | B5 |

Note:

- According to the above table, the initial test position for body is "Back", and its reported SAR is $\leq 0.4W/kg$. Thus further SAR measurement is not required for the other (remaining) test positions. Because the reported SAR of the highest measured maximum output power channel for the exposure configuration is $\leq 0.8W/kg$, no further SAR testing is required for 802.11b DSSS in that exposure configuration.

| WLAN- Scaled Reported SAR | | | | | | | |
|---------------------------|---------------|-----------|------|--------------------|---------------------|-------------------------|--------------------------------|
| Mode | Test Position | Frequency | | Actual duty factor | maximum duty factor | Reported SAR (1g)(W/kg) | Scaled reported SAR (1g)(W/kg) |
| | | CH | MHz | | | | |
| 802.11b 1Mbps | Front | 11 | 2462 | 92.73% | 100% | 0.06 | 0.06 |
| | Back | 11 | 2462 | 92.73% | 100% | 0.10 | 0.11 |

Note:

- According to the KDB248227 D01, The reported SAR must be scaled to 100% transmission duty factor to determine compliance at the maximum tune-up tolerance limit. A maximum transmission duty factor of 92.73% is achievable for WLAN in this project.

Hotspot SAR

| Positions for SAR tests; Hotspot mode | | | | | | |
|---------------------------------------|------|-------|----------|-------------|------------|-----------|
| Antenna | Back | Front | Top side | Bottom side | Right side | Left side |
| WWAN | Yes | Yes | No | Yes | Yes | Yes |
| WIFI / BT | Yes | Yes | Yes | No | Yes | No |

General note:

Referring to KDB941225 D06, when the overall device length and width are >9cm*5cm, the test distance is 10mm. SAR must be measured for all sides and surfaces with a transmitting antenna located within 25mm from that surface or edge.

| GSM850 | | | | | | | | | | |
|-----------------|---------------|-----------|-------|-----------------------|---------------------|------------------------|-----------------|-------------------------|-----------------------|-----------|
| Mode | Test Position | Frequency | | Conducted Power (dBm) | Tune up limit (dBm) | Tune up scaling factor | Power Drift(dB) | Measured SAR(1g) (mW/g) | Report SAR(1g) (mW/g) | Test Plot |
| | | CH | MHz | | | | | | | |
| GPRS (4Tx slot) | Front | 128 | 824.2 | 26.46 | 27.00 | 1.13 | - | - | - | - |
| | | 190 | 836.6 | 26.45 | 27.00 | 1.13 | 0.02 | 0.405 | 0.46 | - |
| | | 251 | 848.8 | 26.38 | 27.00 | 1.15 | - | - | - | - |
| | Back | 128 | 824.2 | 26.46 | 27.00 | 1.13 | - | - | - | - |
| | | 190 | 836.6 | 26.45 | 27.00 | 1.13 | 0.00 | 0.613 | 0.70 | B1 |
| | | 251 | 848.8 | 26.38 | 27.00 | 1.15 | - | - | - | - |
| | Left | 190 | 836.6 | 26.45 | 27.00 | 1.13 | 0.06 | 0.270 | 0.31 | - |
| | Right | 190 | 836.6 | 26.45 | 27.00 | 1.13 | 0.12 | 0.195 | 0.22 | - |
| | Top | 190 | 836.6 | 26.45 | 27.00 | 1.13 | - | - | - | - |
| Bottom | 190 | 836.6 | 26.45 | 27.00 | 1.13 | 0.01 | 0.349 | 0.40 | - | |

| PCS1900 | | | | | | | | | | |
|-----------------|---------------|-----------|--------|-----------------------|---------------------|------------------------|-----------------|-------------------------|-----------------------|-----------|
| Mode | Test Position | Frequency | | Conducted Power (dBm) | Tune up limit (dBm) | Tune up scaling factor | Power Drift(dB) | Measured SAR(1g) (mW/g) | Report SAR(1g) (mW/g) | Test Plot |
| | | CH | MHz | | | | | | | |
| GPRS (4Tx slot) | Front | 512 | 1850.2 | 24.39 | 25.00 | 1.15 | - | - | - | - |
| | | 661 | 1880.0 | 24.39 | 25.00 | 1.15 | 0.07 | 0.430 | 0.49 | - |
| | | 810 | 1909.8 | 24.03 | 25.00 | 1.25 | - | - | - | - |
| | Back | 512 | 1850.2 | 24.39 | 25.00 | 1.15 | - | - | - | - |
| | | 661 | 1880.0 | 24.39 | 25.00 | 1.15 | -0.1 | 0.659 | 0.76 | B2 |
| | | 810 | 1909.8 | 24.03 | 25.00 | 1.25 | - | - | - | - |
| | Left | 661 | 1880.0 | 24.39 | 25.00 | 1.15 | 0.05 | 0.287 | 0.33 | - |
| | Right | 661 | 1880.0 | 24.39 | 25.00 | 1.15 | 0.03 | 0.219 | 0.25 | - |
| | Top | 661 | 1880.0 | 24.39 | 25.00 | 1.15 | - | - | - | - |
| Bottom | 661 | 1880.0 | 24.39 | 25.00 | 1.15 | -0.10 | 0.376 | 0.43 | - | |

| WCDMA Band V | | | | | | | | | | |
|-----------------|---------------|-----------|-------|-----------------------|---------------------|------------------------|-----------------|-------------------------|-----------------------|-----------|
| Mode | Test Position | Frequency | | Conducted Power (dBm) | Tune up limit (dBm) | Tune up scaling factor | Power Drift(dB) | Measured SAR(1g) (mW/g) | Report SAR(1g) (mW/g) | Test Plot |
| | | CH | MHz | | | | | | | |
| RMC 12.2Kbps | Front | 4132 | 826.4 | 22.49 | 23.00 | 1.12 | - | - | - | - |
| | | 4183 | 836.6 | 22.46 | 23.00 | 1.13 | 0.01 | 0.411 | 0.47 | - |
| | | 4233 | 846.6 | 22.16 | 23.00 | 1.21 | - | - | - | - |
| | Back | 4132 | 826.4 | 22.49 | 23.00 | 1.12 | - | - | - | - |
| | | 4183 | 836.6 | 22.46 | 23.00 | 1.13 | -0.03 | 0.578 | 0.65 | B3 |
| | | 4233 | 846.6 | 22.16 | 23.00 | 1.21 | - | - | - | - |
| | Left | 4183 | 836.6 | 22.46 | 23.00 | 1.13 | -0.05 | 0.274 | 0.31 | - |
| | Right | 4183 | 836.6 | 22.46 | 23.00 | 1.13 | 0.03 | 0.255 | 0.29 | - |
| | Top | 4183 | 836.6 | 22.46 | 23.00 | 1.13 | - | - | - | - |
| Bottom | 4183 | 836.6 | 22.46 | 23.00 | 1.13 | 0.01 | 0.329 | 0.37 | - | |

| WCDMA Band II | | | | | | | | | | |
|-----------------|---------------|-----------|--------|-----------------------|---------------------|------------------------|-----------------|-------------------------|-----------------------|-----------|
| Mode | Test Position | Frequency | | Conducted Power (dBm) | Tune up limit (dBm) | Tune up scaling factor | Power Drift(dB) | Measured SAR(1g) (mW/g) | Report SAR(1g) (mW/g) | Test Plot |
| | | CH | MHz | | | | | | | |
| RMC 12.2Kbps | Front | 9262 | 1852.4 | 22.10 | 23.00 | 1.23 | - | - | - | - |
| | | 9400 | 1880.0 | 22.04 | 23.00 | 1.25 | 0.00 | 0.458 | 0.57 | - |
| | | 9538 | 1907.6 | 22.09 | 23.00 | 1.23 | - | - | - | - |
| | Back | 9262 | 1852.4 | 22.10 | 23.00 | 1.23 | 0.06 | 0.656 | 0.81 | - |
| | | 9400 | 1880.0 | 22.04 | 23.00 | 1.25 | 0.01 | 0.667 | 0.83 | B4 |
| | | 9538 | 1907.6 | 22.09 | 23.00 | 1.23 | 0.12 | 0.645 | 0.80 | - |
| | Left | 9400 | 1880.0 | 22.04 | 23.00 | 1.25 | -0.01 | 0.316 | 0.39 | - |
| | Right | 9400 | 1880.0 | 22.04 | 23.00 | 1.25 | 0.01 | 0.359 | 0.45 | - |
| | Top | 9400 | 1880.0 | 22.04 | 23.00 | 1.25 | - | - | - | - |
| Bottom | 9400 | 1880.0 | 22.04 | 23.00 | 1.25 | 0.02 | 0.345 | 0.43 | - | |

| WLAN | | | | | | | | | | |
|------------------|---------------|-----------|-------|-----------------------|---------------------|------------------------|-----------------|-------------------------|-----------------------|-----------|
| Mode | Test Position | Frequency | | Conducted Power (dBm) | Tune up limit (dBm) | Tune up scaling factor | Power Drift(dB) | Measured SAR(1g) (mW/g) | Report SAR(1g) (mW/g) | Test Plot |
| | | CH | MHz | | | | | | | |
| 802.11b 1Mbps | Front | 1 | 2412 | 14.04 | 14.50 | 1.11 | - | - | - | - |
| | | 6 | 2437 | 13.95 | 14.50 | 1.13 | - | - | - | - |
| | | 11 | 2462 | 14.24 | 14.50 | 1.06 | 0.15 | 0.059 | 0.06 | - |
| | Back | 1 | 2412 | 14.04 | 14.50 | 1.11 | - | - | - | - |
| | | 6 | 2437 | 13.95 | 14.50 | 1.13 | - | - | - | - |
| | | 11 | 2462 | 14.24 | 14.50 | 1.06 | -0.10 | 0.096 | 0.10 | B5 |
| | Left | 11 | 2462 | 14.24 | 14.50 | 1.06 | - | - | - | - |
| | Right | 11 | 2462 | 14.24 | 14.50 | 1.06 | -0.07 | 0.046 | 0.05 | - |
| | Top | 11 | 2462 | 14.24 | 14.50 | 1.06 | -0.13 | 0.050 | 0.05 | - |
| Bottom | 11 | 2462 | 14.24 | 14.50 | 1.06 | - | - | - | - | |

Note:

- According to the above table, the initial test position for body is “Back”, and its reported SAR is ≤ 0.4W/kg. Thus further SAR measurement is not required for the other (remaining) test positions. Because the reported SAR of the highest measured maximum output power channel for the exposure configuration is ≤ 0.8W/kg, no further SAR testing is required for 802.11b DSSS in that exposure configuration.

| WLAN- Scaled Reported SAR | | | | | | | |
|---------------------------|---------------|-----------|------|--------------------|---------------------|-------------------------|--------------------------------|
| Mode | Test Position | Frequency | | Actual duty factor | maximum duty factor | Reported SAR (1g)(W/kg) | Scaled reported SAR (1g)(W/kg) |
| | | CH | MHz | | | | |
| 802.11b 1Mbps | Front | 11 | 2462 | 92.73% | 100% | 0.06 | 0.06 |
| | Back | 11 | 2462 | 92.73% | 100% | 0.10 | 0.11 |
| | Right | 11 | 2462 | 92.73% | 100% | 0.05 | 0.05 |
| | Top | 11 | 2462 | 92.73% | 100% | 0.05 | 0.05 |

Note:

- According to the KDB248227 D01, The reported SAR must be scaled to 100% transmission duty factor to determine compliance at the maximum tune-up tolerance limit. A maximum transmission duty factor of 92.73% is achievable for WLAN in this project.

SAR Test Data Plots

| | | | | | |
|------------|-----------------|----------------|-----------------|------------|----|
| Test mode: | GSM850-GPRS 4TS | Test Position: | Left Head Cheek | Test Plot: | H1 |
|------------|-----------------|----------------|-----------------|------------|----|

Date:2017-04-03

Communication System: Customer System; Frequency:836.6 MHz;Duty Cycle:1:2

Medium parameters used (interpolated): $f=836.6$ MHz; $\sigma=0.91$ S/m; $\epsilon_r=41.48$; $\rho=1000$ kg/m³

Phantom section: Left Head Section:

DASY 5 Configuration:

- Probe: ES3DV3 - SN3292; ConvF(6.53, 6.53, 6.53); Calibrated: 02/09/2016;
- Sensor-Surface: 4mm (Mechanical Surface Detection)
- Electronics: DAE4 Sn1315; Calibrated: 26/07/2016
- Phantom: SAM 1; Type: SAM;
- Measurement SW: DASY52, Version 52.8 (2); SEMCAD X Version 14.6.6 (6824)

Area Scan (61x101x1): Interpolated grid: $dx=1.500$ mm, $dy=1.500$ mm

Maximum value of SAR (interpolated) = 0.222 W/kg

Zoom Scan (7x7x7)/Cube 0: Measurement grid: $dx=5$ mm, $dy=5$ mm, $dz=5$ mm

Reference Value = 6.172 V/m; Power Drift = 0.01 dB

Peak SAR (extrapolated) = 0.247 mW/g

SAR(1 g) = 0.211 mW/g; SAR(10 g) = 0.178 mW/g

Maximum value of SAR (measured) = 0.215 W/kg

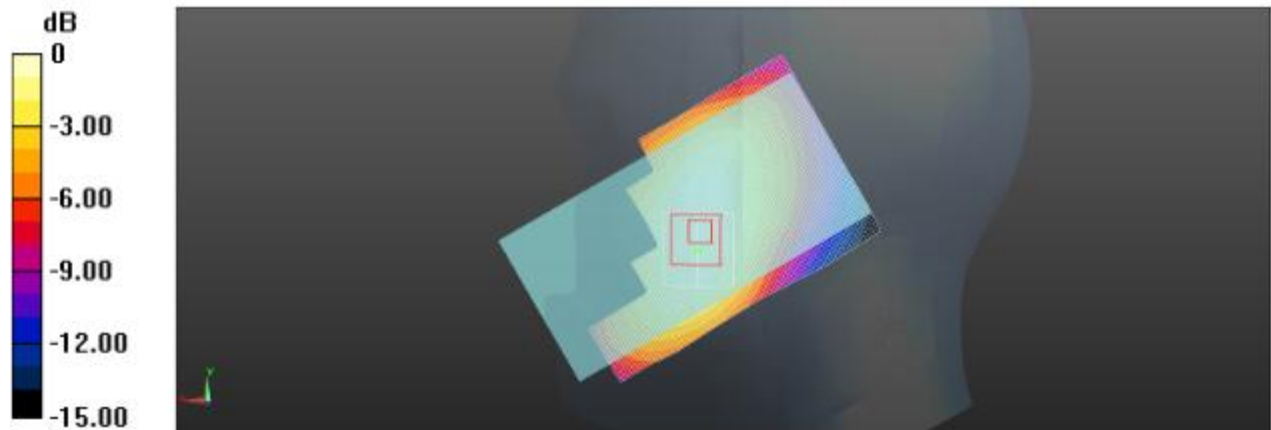

Left Head Cheek (GSM850 GPRS 4TS Middle Channel)

| | | | | | |
|------------|------------------|----------------|-----------------|------------|----|
| Test mode: | PCS1900 GPRS 4TS | Test Position: | Left Head Cheek | Test Plot: | H2 |
|------------|------------------|----------------|-----------------|------------|----|

Date:2017-04-04

Communication System: Customer System; Frequency: 1880.0 MHz;Duty Cycle: 1:2

Medium parameters used (interpolated): $f = 1880.0$ MHz; $\sigma = 1.41$ mho/m; $\epsilon = 40.01$; $\rho = 1000$ kg/m³

Phantom section: Left Head Section

DASY5 Configuration:

- Probe: ES3DV3 - SN3292; ConvF(5.26,5.26,5.26); Calibrated: 02/09/2016;
- Sensor-Surface: 4mm (Mechanical Surface Detection)
- Electronics: DAE4 Sn1315; Calibrated: 26/07/2016
- Phantom: SAM 1; Type: SAM;
- Measurement SW: DASY52, Version 52.8 (2); SEMCAD X Version 14.6.6 (6824)

Area Scan (61x121x1): Interpolated grid: $dx=1.500$ mm, $dy=1.500$ mm

Maximum value of SAR (interpolated) = 0.305 mW/g

Zoom Scan (7x7x7)/Cube 0: Measurement grid: $dx=5$ mm, $dy=5$ mm, $dz=5$ mm

Reference Value = 5.125 V/m; Power Drift = 0.12 dB

Peak SAR (extrapolated) = 0.415 mW/g

SAR(1 g) = 0.248 mW/g; SAR(10 g) = 0.180 mW/g

Maximum value of SAR (measured) = 0.304 mW/g

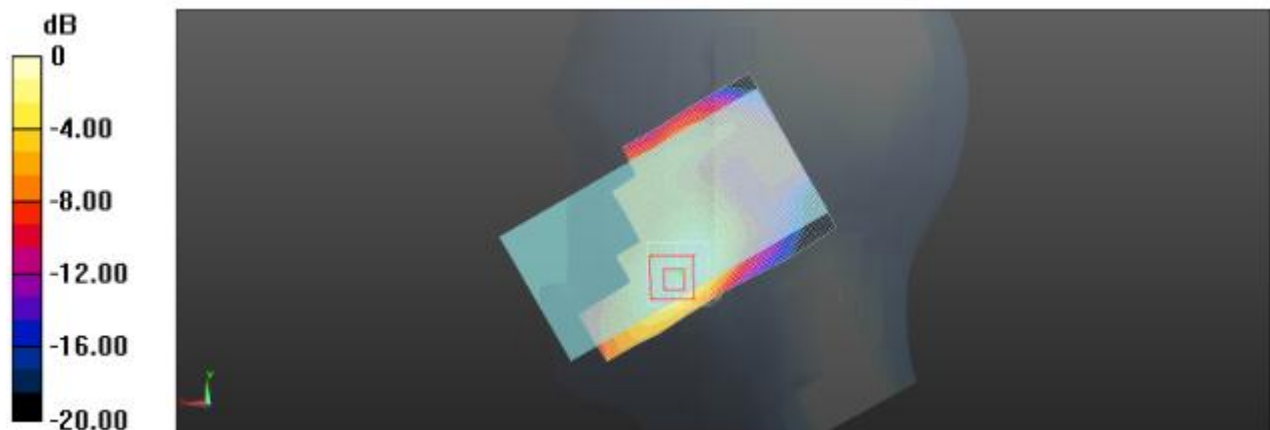

Left Head (PCS1900 Middle Channel)

| | | | | | |
|------------|--------------|----------------|-----------------|------------|----|
| Test mode: | WCDMA Band V | Test Position: | Left Head Cheek | Test Plot: | H3 |
|------------|--------------|----------------|-----------------|------------|----|

Date:2017-04-03

Communication System: Customer System; Frequency: 836.6 MHz;Duty Cycle:1:1

Medium parameters used (interpolated): $f=836.6$ MHz; $\sigma=0.91$ S/m; $\epsilon_r=41.48$; $\rho=1000$ kg/m³

Phantom section: Left Head Section:

DASY5 Configuration:

- Probe: ES3DV3 - SN3292; ConvF(6.53, 6.53, 6.53); Calibrated: 02/09/2016;
- Sensor-Surface: 4mm (Mechanical Surface Detection)
- Electronics: DAE4 Sn1315; Calibrated: 26/07/2016
- Phantom: SAM 1; Type: SAM;
- Measurement SW: DASY52, Version 52.8 (2); SEMCAD X Version 14.6.6 (6824)

Area Scan (61x121x1): Interpolated grid: $dx=1.500$ mm, $dy=1.500$ mm

Maximum value of SAR (interpolated) =0.186 W/kg

Zoom Scan (7x7x7)/Cube 0: Measurement grid: $dx=5$ mm, $dy=5$ mm, $dz=5$ mm

Reference Value = 4.034 V/m; Power Drift = 0.19 dB

Peak SAR (extrapolated) = 0.277 mW/g

SAR(1 g) = 0.162 mW/g; SAR(10 g) = 0.101 mW/g

Maximum value of SAR (measured) = 0.187 W/kg

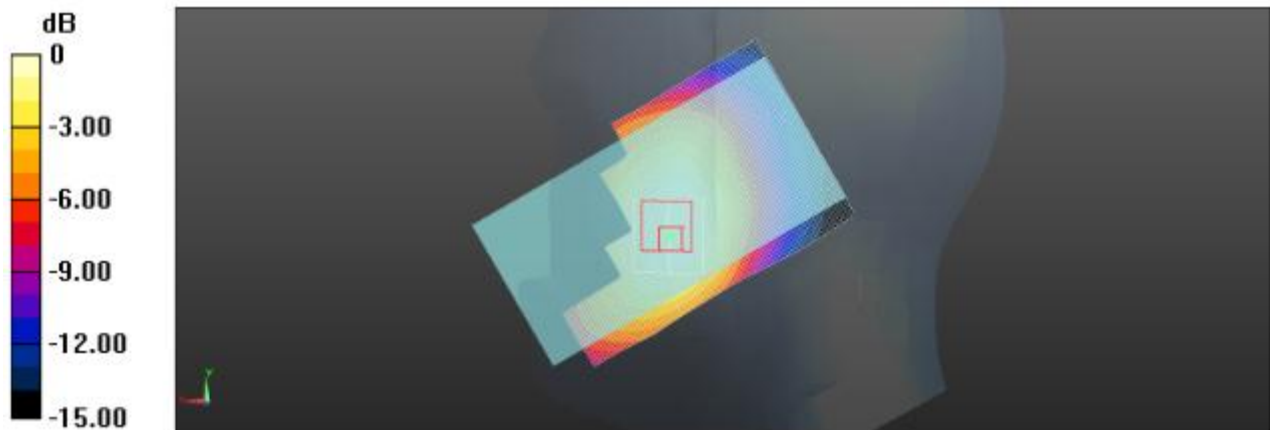

Left Head Cheek (WCDMA Band V Middle Channel)

| | | | | | |
|------------|---------------|----------------|-----------------|------------|----|
| Test mode: | WCDMA Band II | Test Position: | Left Head Cheek | Test Plot: | H4 |
|------------|---------------|----------------|-----------------|------------|----|

Date:2017-04-04

Communication System: Customer System; Frequency: 1880.0 MHz;Duty Cycle:1:1

Medium parameters used (interpolated): $f = 1880.0$ MHz; $\sigma = 1.41$ mho/m; $\epsilon = 40.01$; $\rho = 1000$ kg/m³

Phantom section: Left Head Section:

DASY5 Configuration:

- Probe: ES3DV3 - SN3292; ConvF(5.26,5.26,5.26); Calibrated: 02/09/2016;
- Sensor-Surface: 4mm (Mechanical Surface Detection)
- Electronics: DAE4 Sn1315; Calibrated: 26/07/2016
- Phantom: SAM 1; Type: SAM;
- Measurement SW: DASY52, Version 52.8 (2); SEMCAD X Version 14.6.6 (6824)

Area Scan (61x121x1): Interpolated grid: $dx=1.500$ mm, $dy=1.500$ mm

Maximum value of SAR (interpolated) =0.333 W/kg

Zoom Scan (7x7x7)/Cube 0: Measurement grid: $dx=5$ mm, $dy=5$ mm, $dz=5$ mm

Reference Value = 6.256 V/m; Power Drift = 0.05 dB

Peak SAR (extrapolated) = 0.451 mW/g

SAR(1 g) = 0.291 mW/g; SAR(10 g) = 0.179 mW/g

Maximum value of SAR (measured) = 0.327 W/kg

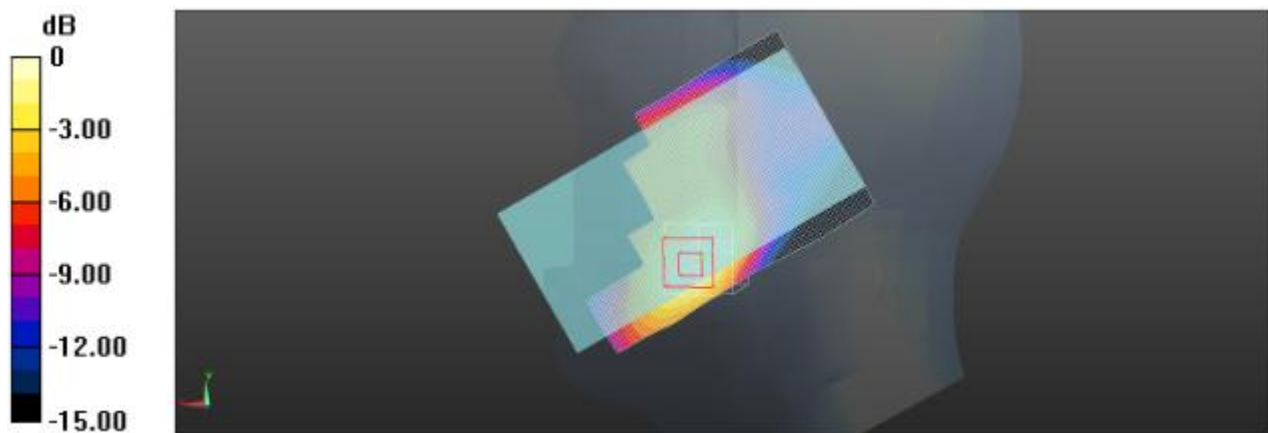

Left Head Cheek (WCDMA Band II Middle Channel)

| | | | | | |
|------------|--------------|----------------|-----------------|------------|----|
| Test mode: | WLAN 802.11b | Test Position: | Left Head Cheek | Test Plot: | H5 |
|------------|--------------|----------------|-----------------|------------|----|

Date:2017-04-05

Communication System: Customer System; Frequency: 2462.0 MHz;Duty Cycle:1:1

Medium parameters used (interpolated): $f=2462.0$ MHz; $\sigma=1.79$ S/m; $\epsilon_r=39.02$; $\rho=1000$ kg/m³

Phantom section: Left Head Section:

DASY5 Configuration:

- Probe: ES3DV3 - SN3292; ConvF(4.97,4.97,4.97); Calibrated: 02/09/2016;
- Sensor-Surface: 4mm (Mechanical Surface Detection)
- Electronics: DAE4 Sn1315; Calibrated: 26/07/2016
- Phantom: SAM 1; Type: SAM;
- Measurement SW: DASY52, Version 52.8 (2); SEMCAD X Version 14.6.6 (6824)

Area Scan (61x121x1): Interpolated grid: $dx=1.500$ mm, $dy=1.500$ mm

Maximum value of SAR (interpolated) = 0.176 W/kg

Zoom Scan (7x7x7)/Cube 0: Measurement grid: $dx=5$ mm, $dy=5$ mm, $dz=5$ mm

Reference Value =4.256 V/m; Power Drift =-0.06 dB

Peak SAR (extrapolated) = 0.251 mW/g

SAR(1 g) = 0.127 mW/g; SAR(10 g) = 0.073 mW/g

Maximum value of SAR (measured) = 0.169 W/kg

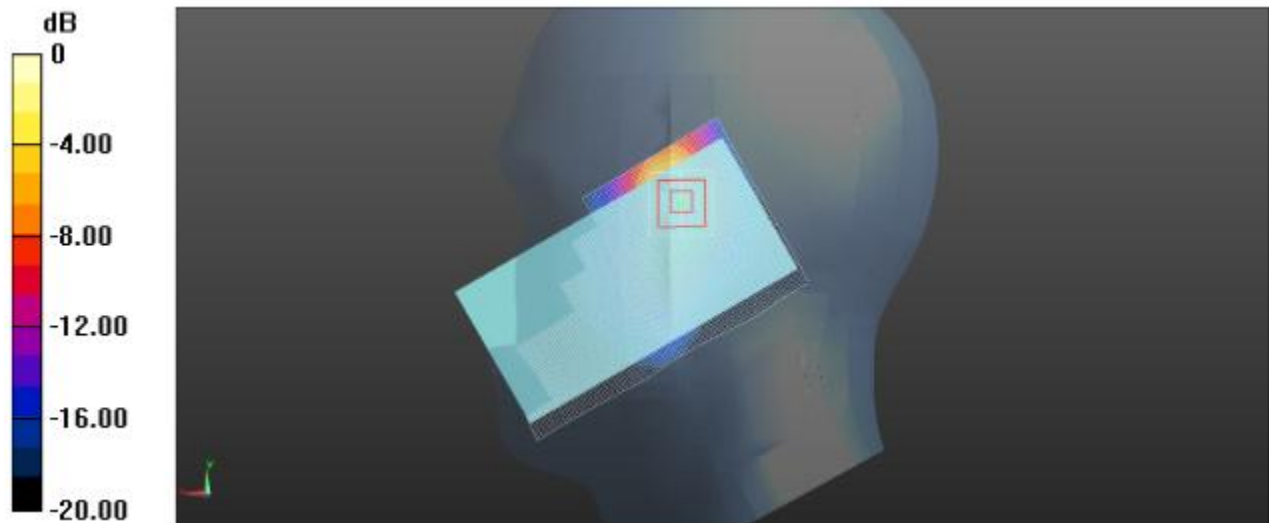

Left Head Cheek

| | | | | | |
|------------|-----------------|----------------|-----------|------------|----|
| Test mode: | GSM850 GPRS 4TS | Test Position: | Rear Side | Test Plot: | B1 |
|------------|-----------------|----------------|-----------|------------|----|

Date:2017-04-03

Communication System: Customer System; Frequency:836.6 MHz;Duty Cycle:1:2

Medium parameters used (interpolated): $f=836.6$ MHz; $\sigma=0.97$ S/m; $\epsilon_r=55.10$; $\rho=1000$ kg/m³

Phantom section: Flat Section:

DASY 5 Configuration:

- Probe: ES3DV3 - SN3292; ConvF(6.27, 6.27, 6.27); Calibrated: 02/09/2016;
- Sensor-Surface: 4mm (Mechanical Surface Detection)
- Electronics: DAE4 Sn1315; Calibrated: 26/07/2016
- Phantom: SAM 1; Type: SAM;
- Measurement SW: DASY52, Version 52.8 (2); SEMCAD X Version 14.6.6 (6824)

Area Scan (61x121x1): Interpolated grid: $dx=1.500$ mm, $dy=1.500$ mm

Maximum value of SAR (interpolated) = 0.696 W/kg

Zoom Scan (7x7x7)/Cube 0: Measurement grid: $dx=5$ mm, $dy=5$ mm, $dz=5$ mm

Reference Value = 26.268 V/m; Power Drift = 0.12 dB

Peak SAR (extrapolated) = 1.127 mW/g

SAR(1 g) = 0.613 mW/g; SAR(10 g) = 0.363 mW/g

Maximum value of SAR (measured) = 0.709 W/kg

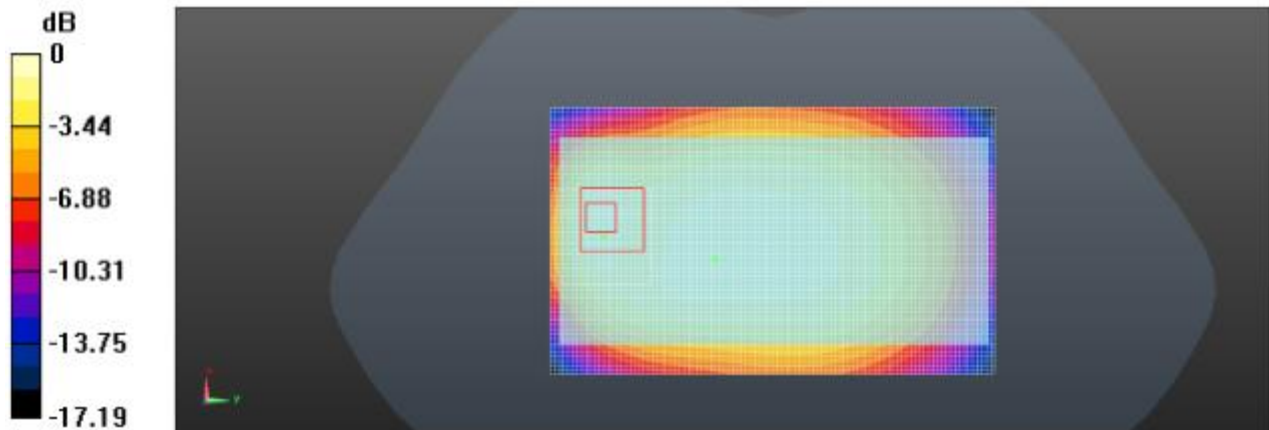

Rear Side (GSM850 GPRS 4TS Middle Channel)

| | | | | | |
|------------|------------------|----------------|-----------|------------|----|
| Test mode: | PCS1900 GPRS 4TS | Test Position: | Rear Side | Test Plot: | B2 |
|------------|------------------|----------------|-----------|------------|----|

Date:2017-04-04

Communication System: Customer System; Frequency: 1880.0 MHz;Duty Cycle: 1:2

Medium parameters used (interpolated): $f = 1880.0$ MHz; $\sigma = 1.51$ mho/m; $\epsilon = 53.21$; $\rho = 1000$ kg/m³

Phantom section: Flat Section

DASY5 Configuration:

- Probe: ES3DV3 - SN3292; ConvF(5.05,5.05,5.05); Calibrated: 02/09/2016;
- Sensor-Surface: 4mm (Mechanical Surface Detection)
- Electronics: DAE4 Sn1315; Calibrated: 26/07/2016
- Phantom: SAM 1; Type: SAM;
- Measurement SW: DASY52, Version 52.8 (2); SEMCAD X Version 14.6.6 (6824)

Area Scan (61x121x1): Interpolated grid: dx=1.500 mm, dy=1.500 mm

Maximum value of SAR (interpolated) =0.722 W/kg

Zoom Scan (7x7x7)/Cube 0: Measurement grid: dx=5mm, dy=5mm, dz=5mm

Reference Value = 7.557 V/m; Power Drift = 0.03 dB

Peak SAR (extrapolated) = 1.387 mW/g

SAR(1 g) = 0.659 mW/g; SAR(10 g) = 0.335 mW/g

Maximum value of SAR (measured) = 0.727 W/kg

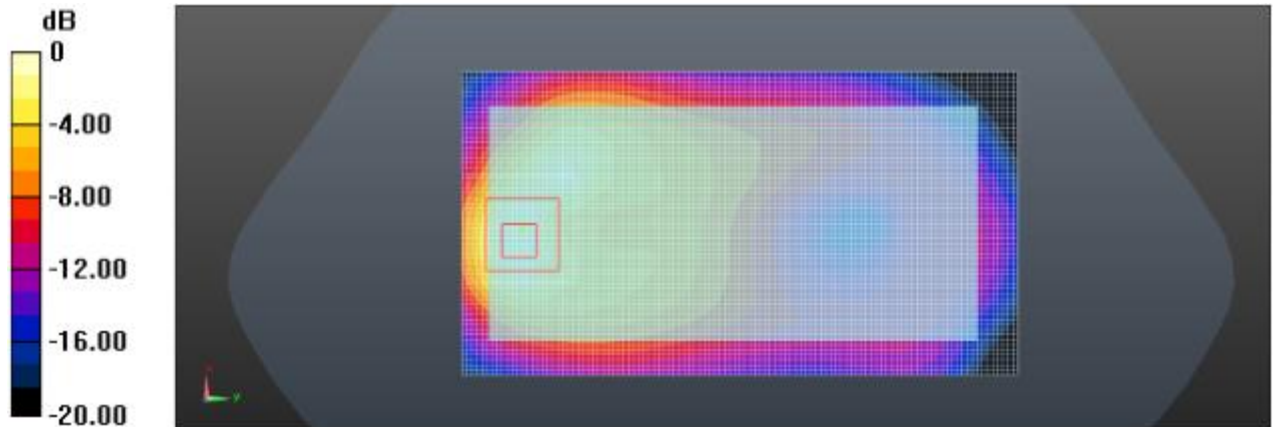

Rear Side (PCS1900 GPRS 4TS Middle Channel)

| | | | | | |
|------------|--------------|----------------|-----------|------------|----|
| Test mode: | WCDMA Band V | Test Position: | Rear Side | Test Plot: | B3 |
|------------|--------------|----------------|-----------|------------|----|

Date:2017-04-03

Communication System: Customer System; Frequency: 836.6 MHz;Duty Cycle:1:1

Medium parameters used (interpolated): $f=836.6$ MHz; $\sigma=0.97$ S/m; $\epsilon_r=55.10$; $\rho=1000$ kg/m³

Phantom section: Flat Section

DASY5 Configuration:

- Probe: ES3DV3 - SN3292; ConvF(6.27, 6.27, 6.27); Calibrated: 02/09/2016;
- Sensor-Surface: 4mm (Mechanical Surface Detection)
- Electronics: DAE4 Sn1315; Calibrated: 26/07/2016
- Phantom: SAM 1; Type: SAM;
- Measurement SW: DASY52, Version 52.8 (2); SEMCAD X Version 14.6.6 (6824)

Area Scan (61x121x1): Interpolated grid: $dx=1.500$ mm, $dy=1.500$ mm

Maximum value of SAR (interpolated) =0.673 W/kg

Zoom Scan (7x7x7)/Cube 0: Measurement grid: $dx=5$ mm, $dy=5$ mm, $dz=5$ mm

Reference Value = 7.953 V/m; Power Drift = -0.01 dB

Peak SAR (extrapolated) = 1.896 mW/g

SAR(1 g) = 0.578 mW/g; SAR(10 g) = 0.241 mW/g

Maximum value of SAR (measured) = 0.672 W/kg

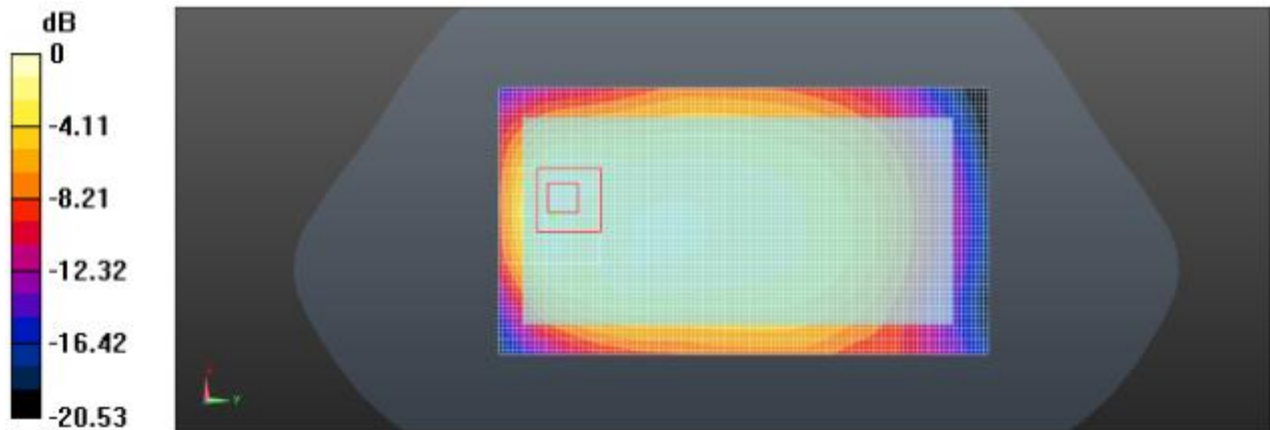

Rear Side (WCDMA Band V Middle Channel)

| | | | | | |
|------------|---------------|----------------|-----------|------------|----|
| Test mode: | WCDMA Band II | Test Position: | Rear Side | Test Plot: | B4 |
|------------|---------------|----------------|-----------|------------|----|

Date:2017-04-04

Communication System: Customer System; Frequency: 1880.0 MHz;Duty Cycle:1:1

Medium parameters used (interpolated): $f=1880.0$ MHz; $\sigma=1.51$ S/m; $\epsilon_r=53.21$; $\rho=1000$ kg/m³

Phantom section: Flat Section

DASY5 Configuration:

- Probe: ES3DV3 - SN3292; ConvF(5.05,5.05,5.05); Calibrated: 02/09/2016;
- Sensor-Surface: 4mm (Mechanical Surface Detection)
- Electronics: DAE4 Sn1315; Calibrated: 26/07/2016
- Phantom: SAM 1; Type: SAM;
- Measurement SW: DASY52, Version 52.8 (2); SEMCAD X Version 14.6.6 (6824)

Area Scan (61x121x1): Interpolated grid: $dx=1.500$ mm, $dy=1.500$ mm

Maximum value of SAR (interpolated) = 0.720 W/kg

Zoom Scan (7x7x7)/Cube 0: Measurement grid: $dx=5$ mm, $dy=5$ mm, $dz=5$ mm

Reference Value = 7.597 V/m; Power Drift = 0.12 dB

Peak SAR (extrapolated) = 1.416 mW/g

SAR(1 g) = 0.667 mW/g; SAR(10 g) = 0.381 mW/g

Maximum value of SAR (measured) = 0.716 W/kg

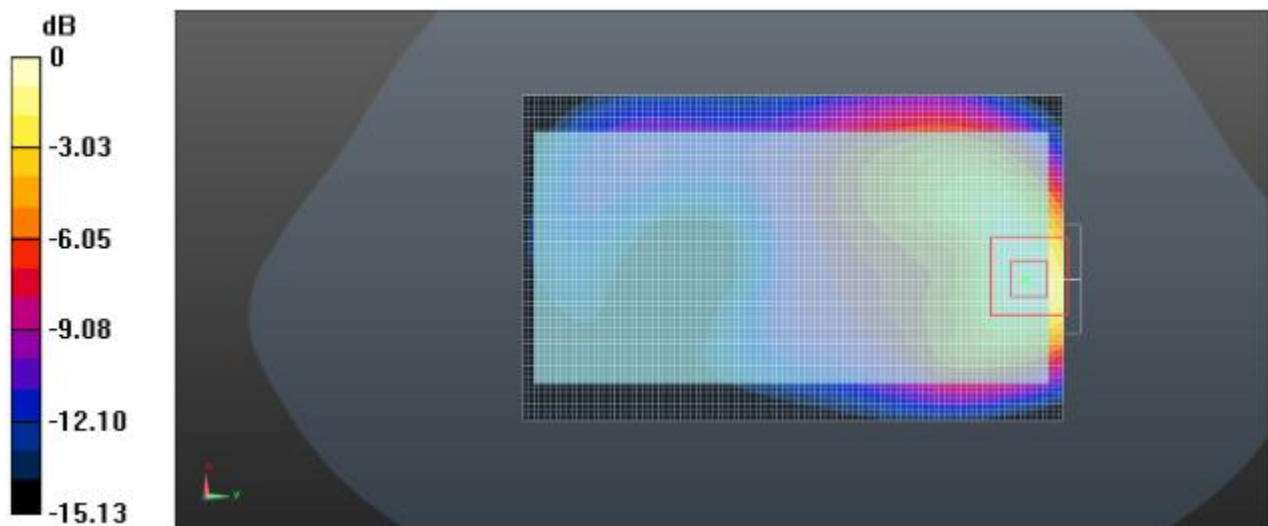

Rear Side (WCDMA Band II Middle Channel)

| | | | | | |
|------------|--------------|----------------|-----------|------------|----|
| Test mode: | WLAN 802.11b | Test Position: | Rear Side | Test Plot: | B5 |
|------------|--------------|----------------|-----------|------------|----|

Date:2017-04-05

Communication System: Customer System; Frequency: 2462.0 MHz;Duty Cycle:1:1

Medium parameters used (interpolated): f= 2462.0 MHz; $\sigma=1.94\text{S/m}$; $\epsilon_r=52.53$; $\rho=1000\text{ kg/m}^3$

Phantom section : Flat Section

DASY5 Configuration:

- Probe: ES3DV3 - SN3292; ConvF(4.70,4.70,4.70); Calibrated: 02/09/2016;
- Sensor-Surface: 4mm (Mechanical Surface Detection)
- Electronics: DAE4 Sn1315; Calibrated: 26/07/2016
- Phantom: SAM 1; Type: SAM;
- Measurement SW: DASY52, Version 52.8 (2); SEMCAD X Version 14.6.6 (6824)

Area Scan (61x121x1): Interpolated grid: dx=1.500 mm, dy=1.500 mm

Maximum value of SAR (interpolated) = 0.122 W/kg

Zoom Scan (7x7x7)/Cube 0: Measurement grid: dx=5mm, dy=5mm, dz=5mm

Reference Value = 5.165 V/m; Power Drift = 0.12 dB

Peak SAR (extrapolated) = 0.227 mW/g

SAR(1 g) = 0.096 mW/g; SAR(10 g) = 0.054 mW/g

Maximum value of SAR (measured) = 0.129 W/kg

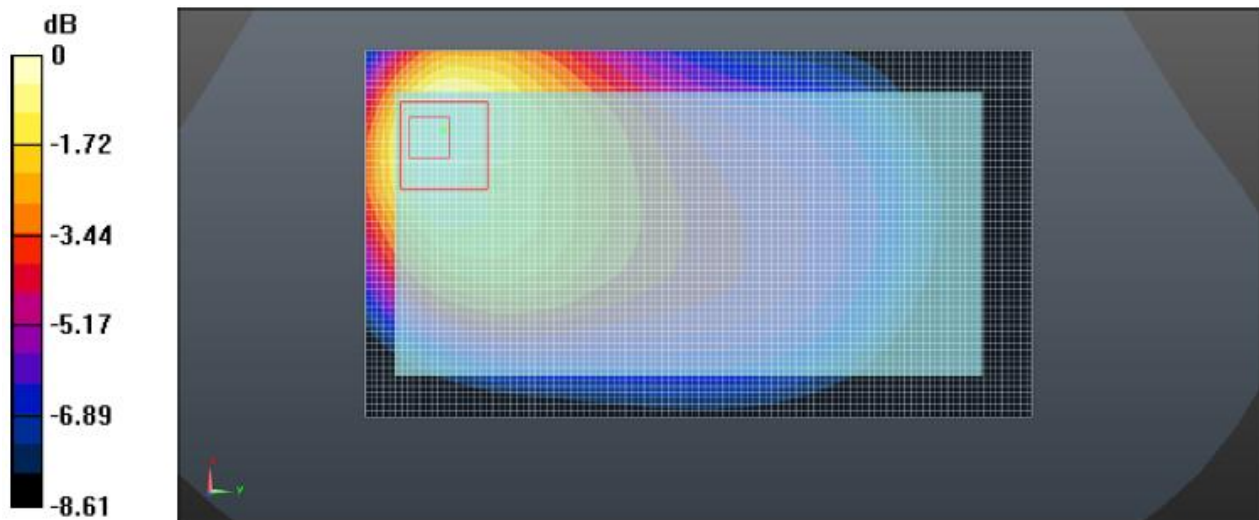

Rear side (WLAN 802.11b)

15. Simultaneous Transmission analysis

| No. | Simultaneous Transmission Configurations | Head | Body-worn | Hotspot | Note |
|-----|------------------------------------------|------|-----------|---------|------|
| 1 | GSM(voice) + Bluetooth (data) | Yes | Yes | | |
| 2 | GSM(voice) + WIFI (data) | Yes | Yes | | |
| 3 | WCDMA(voice) + Bluetooth (data) | Yes | Yes | | |
| 4 | WCDMA(voice) + WIFI (data) | Yes | Yes | | |
| 5 | GPRS (data) + Bluetooth (data) | Yes | Yes | NA | |
| 6 | GPRS (data) + WIFI (data) | Yes | Yes | Yes | |
| 7 | WCDMA (data) + Bluetooth (data) | Yes | Yes | NA | |
| 8 | WCDMA (data) + WIFI (data) | Yes | Yes | Yes | |

General note:

1. WLAN and Bluetooth share the same antenna, and cannot transmit simultaneously.
2. EUT will choose either GSM or WCDMA according to the network signal condition; therefore, they will not operate simultaneously at any moment.
3. For simultaneous transmission analysis, Bluetooth SAR is estimated per KDB 447498 D01 based on the formula below
 - a) $[(\text{max. Power of channel, including tune-up tolerance, mW}) / (\text{min. test separation distance, mm})]^2 \cdot [(\text{f(GHz)/x})^2] \text{mW/g}$ for test separation distances $\leq 50\text{mm}$; when $x=7.5$ for 1-g SAR, and $x=18.75$ for 10-g SAR.
 - b) When the minimum separation distance is $<5\text{mm}$, the distance is used 5mm to determine SAR test exclusion
 - c) 0.4 mW/g for 1-g SAR and 1.0mW/g for 10-g SAR, when the test separation distances is $>50\text{mm}$.

| Bluetooth Max power | Exposure position | Head | Hotspot | Body worn |
|------------------------|----------------------|-----------|-----------|-----------|
| | Test separation | 0mm | 10mm | 10mm |
| 2.00dBm | Estimated SAR (mW/g) | 0.07 mW/g | 0.03 mW/g | 0.03 mW/g |

Head Exposure condition

| WWAN PCE +WIFI DTS | | | | | |
|--------------------|---------|-------------------|----------------|----------|-------------------|
| WWAN Band | | Exposure Position | Max SAR (mW/g) | | Summed SAR (mW/g) |
| | | | WWAN PCS | WIFI DTS | |
| GSM | GSM850 | Left Cheek | 0.24 | 0.14 | 0.38 |
| | | Left Tilted | 0.18 | 0.12 | 0.31 |
| | | Right Cheek | 0.23 | 0.13 | 0.36 |
| | | Right Tilted | 0.18 | 0.12 | 0.30 |
| | PCS1900 | Left Cheek | 0.29 | 0.14 | 0.43 |
| | | Left Tilted | 0.21 | 0.12 | 0.33 |
| | | Right Cheek | 0.26 | 0.13 | 0.39 |
| | | Right Tilted | 0.20 | 0.12 | 0.32 |
| WCDMA | Band V | Left Cheek | 0.18 | 0.14 | 0.33 |
| | | Left Tilted | 0.15 | 0.12 | 0.27 |
| | | Right Cheek | 0.17 | 0.13 | 0.30 |
| | | Right Tilted | 0.14 | 0.12 | 0.26 |
| | Band II | Left Cheek | 0.36 | 0.14 | 0.51 |
| | | Left Tilted | 0.29 | 0.12 | 0.41 |
| | | Right Cheek | 0.35 | 0.13 | 0.48 |
| | | Right Tilted | 0.26 | 0.12 | 0.38 |

| WWAN PCE + Bluetooth DSS | | | | | |
|--------------------------|---------|-------------------|----------------|---------------|-------------------|
| WWAN Band | | Exposure Position | Max SAR (mW/g) | | Summed SAR (mW/g) |
| | | | WWAN PCS | Bluetooth DSS | |
| GSM | GSM850 | Left Cheek | 0.24 | 0.07 | 0.31 |
| | | Left Tilted | 0.18 | 0.07 | 0.25 |
| | | Right Cheek | 0.23 | 0.07 | 0.29 |
| | | Right Tilted | 0.18 | 0.07 | 0.25 |
| | PCS1900 | Left Cheek | 0.29 | 0.07 | 0.35 |
| | | Left Tilted | 0.21 | 0.07 | 0.28 |
| | | Right Cheek | 0.26 | 0.07 | 0.33 |
| | | Right Tilted | 0.20 | 0.07 | 0.27 |
| WCDMA | Band V | Left Cheek | 0.18 | 0.07 | 0.25 |
| | | Left Tilted | 0.15 | 0.07 | 0.22 |
| | | Right Cheek | 0.17 | 0.07 | 0.24 |
| | | Right Tilted | 0.14 | 0.07 | 0.21 |
| | Band II | Left Cheek | 0.36 | 0.07 | 0.43 |
| | | Left Tilted | 0.29 | 0.07 | 0.36 |
| | | Right Cheek | 0.35 | 0.07 | 0.41 |
| | | Right Tilted | 0.26 | 0.07 | 0.33 |

Maximum reported SAR value for Body-worn





| WWAN PCE + WIFI DTS | | | | | |
|---------------------|---------|-------------------|----------------|----------|-------------------|
| WWAN Band | | Exposure Position | Max SAR (mW/g) | | Summed SAR (mW/g) |
| | | | WWAN PCS | WIFI DTS | |
| GSM | GSM850 | Front | 0.46 | 0.06 | 0.52 |
| | | Back | 0.70 | 0.11 | 0.81 |
| | PCS1900 | Front | 0.49 | 0.06 | 0.55 |
| | | Back | 0.76 | 0.11 | 0.87 |
| WCDMA | Band V | Front | 0.47 | 0.06 | 0.53 |
| | | Back | 0.65 | 0.11 | 0.76 |
| | Band II | Front | 0.57 | 0.06 | 0.63 |
| | | Back | 0.83 | 0.11 | 0.94 |

| WWAN PCE + Bluetooth DSS | | | | | |
|--------------------------|---------|-------------------|----------------|---------------|-------------------|
| WWAN Band | | Exposure Position | Max SAR (mW/g) | | Summed SAR (mW/g) |
| | | | WWAN PCS | Bluetooth DTS | |
| GSM | GSM850 | Front | 0.46 | 0.03 | 0.49 |
| | | Back | 0.70 | 0.03 | 0.73 |
| | PCS1900 | Front | 0.49 | 0.03 | 0.53 |
| | | Back | 0.76 | 0.03 | 0.79 |
| WCDMA | Band V | Front | 0.47 | 0.03 | 0.50 |
| | | Back | 0.65 | 0.03 | 0.69 |
| | Band II | Front | 0.57 | 0.03 | 0.60 |
| | | Back | 0.83 | 0.03 | 0.86 |

Maximum reported SAR value for Hotspot mode

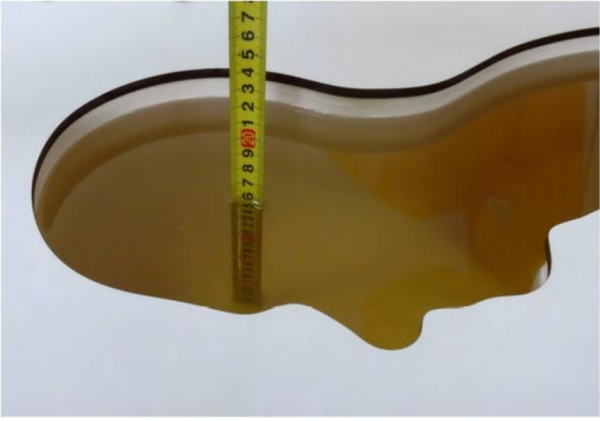
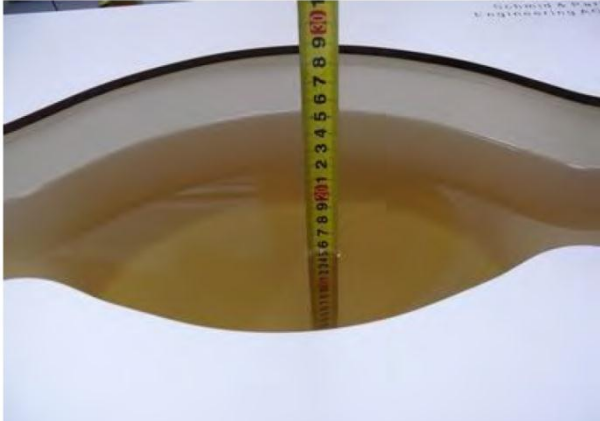
| WWAN PCE + WLAN DTS | | | | | |
|---------------------|---------|-------------------|----------------|----------|-------------------|
| WWAN Band | | Exposure Position | Max SAR (W/kg) | | Summed SAR (W/kg) |
| | | | WWAN PCS | WLAN DTS | |
| GSM | GSM850 | Front | 0.46 | 0.06 | 0.52 |
| | | Back | 0.70 | 0.11 | 0.81 |
| | | Left side | 0.31 | - | 0.31 |
| | | Right side | 0.22 | 0.05 | 0.27 |
| | | Top side | - | 0.05 | 0.05 |
| | | Bottom side | 0.40 | - | 0.40 |
| | PCS1900 | Front | 0.49 | 0.06 | 0.55 |
| | | Back | 0.76 | 0.11 | 0.87 |
| | | Left side | 0.33 | - | 0.33 |
| | | Right side | 0.25 | 0.05 | 0.30 |
| | | Top side | - | 0.05 | 0.05 |
| | | Bottom side | 0.43 | - | 0.43 |
| WCDMA | Band V | Front | 0.47 | 0.06 | 0.53 |
| | | Back | 0.65 | 0.11 | 0.76 |
| | | Left side | 0.31 | - | 0.31 |
| | | Right side | 0.29 | 0.05 | 0.34 |
| | | Top side | - | 0.05 | 0.05 |
| | | Bottom side | 0.37 | - | 0.37 |
| | Band II | Front | 0.57 | 0.06 | 0.63 |
| | | Back | 0.83 | 0.11 | 0.94 |
| | | Left side | 0.39 | - | 0.39 |
| | | Right side | 0.45 | 0.05 | 0.50 |
| | | Top side | - | 0.05 | 0.05 |
| | | Bottom side | 0.43 | - | 0.43 |

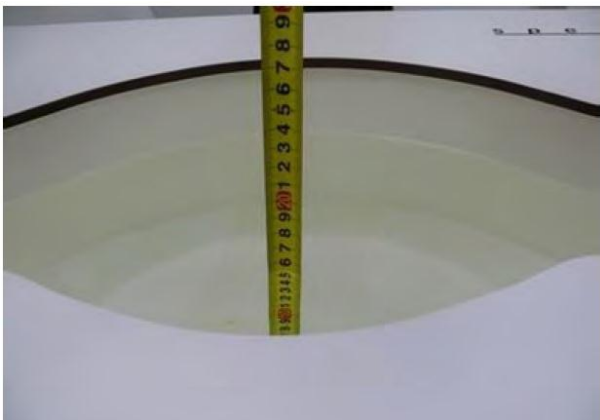
16. Test Setup Photos

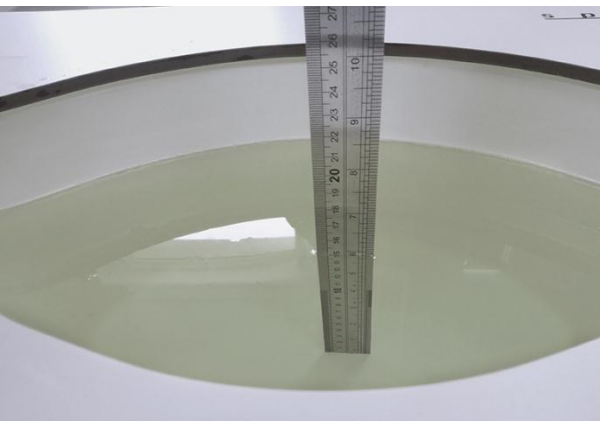
| | |
|-------------------------------------------------------------------------------------|--------------------------------------------------------------------------------------|
|  |  |
| Liquid depth in the head phantom (835MHz) | Liquid depth in the body phantom (835MHz) |
|  |  |
| Liquid depth in the head phantom (1900MHz) | Liquid depth in the body phantom (1900MHz) |
|  |  |
| Liquid depth in the head phantom (2450MHz) | Liquid depth in the body phantom (2450MHz) |

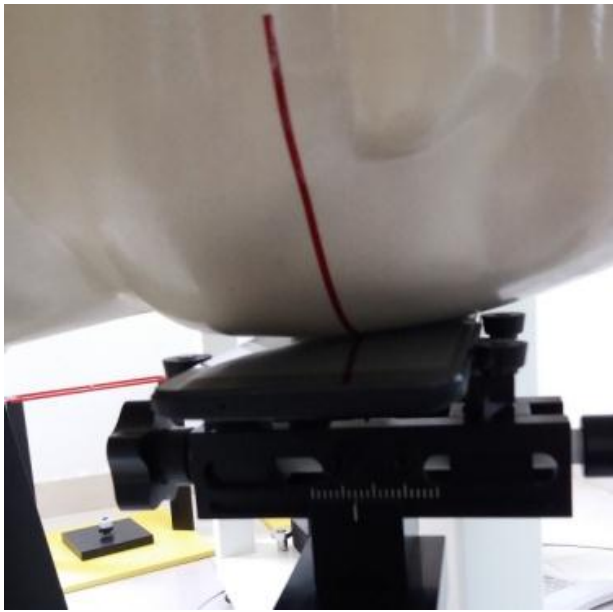

Left Head Touch

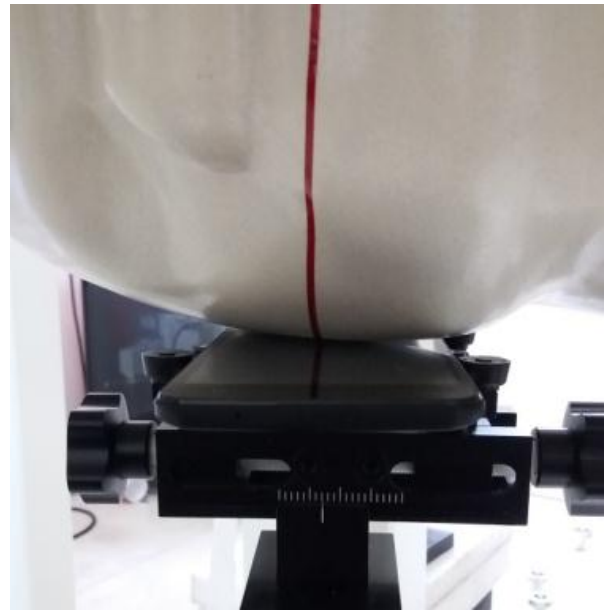

Right Head Touch

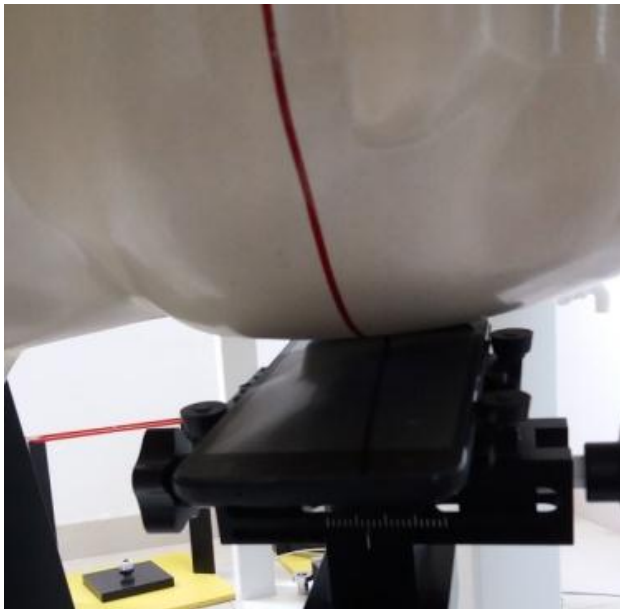

Left Head Tilt (15°)

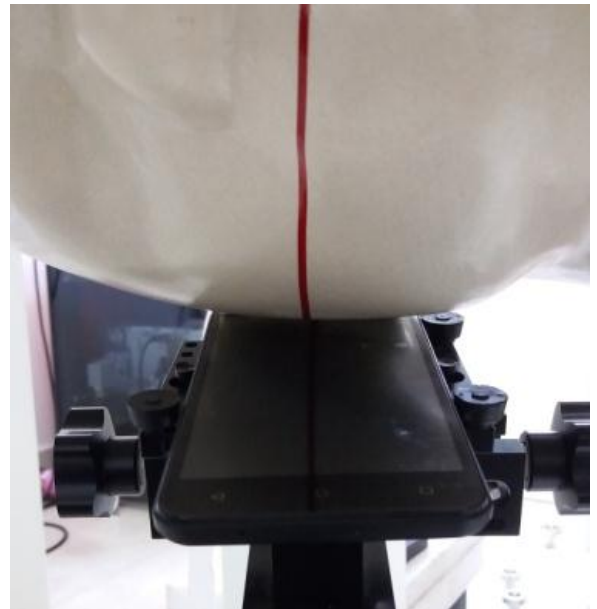

Right Head Tilt (15°)



Body-worn Front Side (10mm)



Body-worn Rear Side (10mm)



Hotspot mode - Front Side (10mm)



Hotspot mode - Rear Side (10mm)



Hotspot mode - Left Side (10mm)



Hotspot mode - Right Side (10mm)



Hotspot mode - Top Side (10mm)



Hotspot mode - Bottom Side (10mm)

17. External and Internal Photos of the EUT

Please reference to the report No.: TRE1703027801.

-----End of Report-----