



TEST REPORT

Report Reference No...... : **TRE1707013804** R/C.....: 97923

FCC ID..... : **2AFD9-DUAL**

Applicant's name..... : **MOVEON TECHNOLOGY LIMITED**

Address..... : World Trade Plaza-A block#3201-3202 Fuhong Road, Futian, Shenzhen,China

Manufacturer..... : MOVEON TECHNOLOGY LIMITED

Address..... : World Trade Plaza-A block#3201-3202 Fuhong Road, Futian, Shenzhen,China

Test item description : **smart mobile phone**

Trade Mark : KRONO

Model/Type reference..... : DUAL

Listed Model(s) : -

Standard : **FCC CFR Title 47 Part 15 Subpart C Section 15.247**

Date of receipt of test sample..... : Jul. 19, 2017

Date of testing..... : Jul. 20, 2017 - Jul.31, 2017

Date of issue..... : Aug.03, 2017

Result..... : **PASS**

Compiled by
(position+printedname+signature).... : File administrators Candy Liu

Supervised by
(position+printed name+signature).... : Project Engineer Lion Cai

Approved by
(position+printed name+signature).... : RF Manager Hans Hu

Testing Laboratory Name : **Shenzhen Huatongwei International Inspection Co., Ltd.**

Address..... : 1/F, Bldg 3, Hongfa Hi-tech Industrial Park, Genyu Road, Tianliao, Gongming, Shenzhen, China

Shenzhen Huatongwei International Inspection Co., Ltd. All rights reserved.

This publication may be reproduced in whole or in part for non-commercial purposes as long as the Shenzhen Huatongwei International Inspection Co., Ltd. is acknowledged as copyright owner and source of the material. Shenzhen Huatongwei International Inspection Co., Ltd. takes no responsibility for and will not assume liability for damages resulting from the reader's interpretation of the reproduced material due to its placement and context.

Contents

1.	<u>TEST STANDARDS AND REPORT VERSION</u>	3
1.1.	Applicable Standards	3
1.2.	Report version	3
2.	<u>TEST DESCRIPTION</u>	4
3.	<u>SUMMARY</u>	5
3.1.	Client Information	5
3.2.	Product Description	5
3.3.	Operation state	6
3.4.	EUT configuration	6
3.5.	Modifications	6
4.	<u>TEST ENVIRONMENT</u>	7
4.1.	Address of the test laboratory	7
4.2.	Test Facility	7
4.3.	Equipments Used during the Test	8
4.4.	Environmental conditions	9
4.5.	Statement of the measurement uncertainty	9
5.	<u>TEST CONDITIONS AND RESULTS</u>	10
5.1.	Antenna requirement	10
5.2.	Conducted Emission (AC Main)	11
5.3.	Conducted Peak Output Power	14
5.4.	Power Spectral Density	15
5.5.	6dB bandwidth	17
5.6.	Restricted band	19
5.7.	Band edge and Spurious Emission (conducted)	21
5.8.	Spurious Emission (radiated)	23
6.	<u>TEST SETUP PHOTOS OF THE EUT</u>	27
7.	<u>EXTERNAL AND INTERNAL PHOTOS OF THE EUT</u>	28

1. Test standards and Report version

1.1. Applicable Standards

The tests were performed according to following standards:

[FCC Rules Part 15.247](#): Frequency Hopping, Direct Spread Spectrum and Hybrid Systems that are in operation within the bands of 902-928 MHz, 2400-2483.5 MHz, and 5725-5850 MHz

[ANSI C63.10:2013](#): American National Standard for Testing Unlicensed Wireless Devices

[KDB 558074 D01 DTS Meas Guidance v03r05](#): Guidance for Performing Compliance Measurements on Digital Transmission Systems (DTS) Operating under § 15.247

1.2. Report version

Version No.	Date of issue	Description
00	Aug.03, 2017	Original

2. Test Description

Test Item	FCC Rule	Result
Antenna requirement	15.203/15.247 (c)	Pass
Line Conducted Emission (AC Main)	15.207	Pass
Conducted Peak Output Power	15.247 (b)(3)	Pass
Power Spectral Density	15.247 (e)	Pass
6dB Bandwidth	15.247 (a)(2)	Pass
Restricted band	15.247(d)/15.205	Pass
Spurious Emission	15.247(d)/15.209	Pass

Note: The measurement uncertainty is not included in the test result.

3. SUMMARY

3.1. Client Information

Applicant:	MOVEON TECHNOLOGY LIMITED
Address:	World Trade Plaza-A block#3201-3202 Fuhong Road, Futian, Shenzhen,China
Manufacturer:	MOVEON TECHNOLOGY LIMITED
Address:	World Trade Plaza-A block#3201-3202 Fuhong Road, Futian, Shenzhen,China

3.2. Product Description

Name of EUT:	smart mobile phone
Trade Mark:	KRONO
Model No.:	DUAL
Listed Model(s):	-
IMEI 1:	359348060000114
IMEI 2:	359348060000106
Power supply:	DC 3.80V From internal battery
Adapter information:	Input: 100-240Va.c., 50/60Hz, 0.15A Output: 5Vd.c., 1000mA
Hardware version:	V1.2
Software version:	KRONO_H5507_Y8361_B2B5_8+1_6.0_V07
Bluetooth	
Version:	Supported BT4.0+BLE
Modulation:	GFSK
Operation frequency:	2402MHz~2480MHz
Channel number:	40
Channel separation:	2MHz
Antenna type:	Integral Antenna
Antenna gain:	0.58dBi

3.3. Operation state

➤ Test frequency list

According to section 15.31(m), regards to the operating frequency range over 10 MHz, must select three channel which were tested. the Lowest frequency, the middle frequency, and the highest frequency of channel were selected to perform the test, please see the above gray bottom.

Channel	Frequency (MHz)
00	2402
02	2404
⋮	⋮
19	2440
⋮	⋮
38	2478
39	2480

➤ Test mode

For RF test items
The engineering test program was provided and enabled to make EUT continuous transmit (duty cycle>98%).
For AC power line conducted emissions:
The EUT was set to connect with the Bluetooth instrument under large package sizes transmission.
For RF test axis
EUT in each of three orthogonal axis emissions had been tested ,but only the worst case (X axis) data Recorded in the report.

3.4. EUT configuration

The following peripheral devices and interface cables were connected during the measurement:

- - supplied by the manufacturer
- - supplied by the lab

	Length (m):	/
	Shield:	/
	Detachable:	/
	Manufacturer:	/
	Model No.:	/

3.5. Modifications

No modifications were implemented to meet testing criteria.

4. TEST ENVIRONMENT

4.1. Address of the test laboratory

Laboratory: Shenzhen Huatongwei International Inspection Co., Ltd.

Address: 1/F, Bldg 3, Hongfa Hi-tech Industrial Park, Genyu Road, Tianliao, Gongming, Shenzhen, China

Phone: 86-755-26748019 Fax: 86-755-26748089

4.2. Test Facility

The test facility is recognized, certified, or accredited by the following organizations:

CNAS-Lab Code: L1225

Shenzhen Huatongwei International Inspection Co., Ltd. has been assessed and proved to be in compliance with CNAS-CL01 Accreditation Criteria for Testing and Calibration Laboratories (identical to ISO/IEC17025: 2005 General Requirements) for the Competence of Testing and Calibration Laboratories.

A2LA-Lab Cert. No.: 3902.01

Shenzhen Huatongwei International Inspection Co., Ltd. EMC Laboratory has been accredited by A2LA for technical competence in the field of electrical testing, and proved to be in compliance with ISO/IEC 17025: 2005 General Requirements for the Competence of Testing and Calibration Laboratories and any additional program requirements in the identified field of testing.

FCC-Registration No.: 762235

Shenzhen Huatongwei International Inspection Co., Ltd. EMC Laboratory has been registered and fully described in a report filed with the FCC (Federal Communications Commission). The acceptance letter from the FCC is maintained in our files. Registration 762235

IC-Registration No.: 5377B-1

Two 3m Alternate Test Site of Shenzhen Huatongwei International Inspection Co., Ltd. has been registered by Certification and Engineering Bureau of Industry Canada for the performance of radiated measurements with Registration No. 5377B-1.

ACA

Shenzhen Huatongwei International Inspection Co., Ltd. EMC Laboratory can also perform testing for the Australian C-Tick mark as a result of our A2LA accreditation.

4.3. Equipments Used during the Test

Conducted Emission (AC Main)					
Item	Test Equipment	Manufacturer	Model No.	Serial No.	Last Cal.
1	Artificial Mains	Rohde&Schwarz	ESH2-Z5	100028	2016/11/13
2	EMI Test Receiver	Rohde&Schwarz	ESCI3	100038	2016/11/13
3	Pulse Limiter	Rohde&Schwarz	ESHSZ2	100044	2016/11/13
4	EMI Test Software	Rohde&Schwarz	ES-K1 V1.71	N/A	N/A

Radiated Emission					
Item	Test Equipment	Manufacturer	Model No.	Serial No.	Last Cal.
1	Ultra-Broadband Antenna	ShwarzBeck	VULB9163	538	2016/11/13
2	EMI TEST RECEIVER	Rohde&Schwarz	ESI 26	100009	2016/11/13
3	EMI TEST Software	Audix	E3	N/A	N/A
4	TURNTABLE	ETS	2088	2149	N/A
5	ANTENNA MAST	ETS	2075	2346	N/A
6	EMI TEST Software	Rohde&Schwarz	ESK1	N/A	N/A
7	HORNANTENNA	ShwarzBeck	9120D	1011	2016/11/13
8	Amplifer	Sonoma	310N	E009-13	2016/11/13
9	JS amplifer	Rohde&Schwarz	JS4-00101800-28-5A	F201504	2016/11/13
10	High pass filter	Compliance Direction systems	BSU-6	34202	2016/11/13
11	HORNANTENNA	ShwarzBeck	9120D	1012	2016/11/13
12	Amplifer	Compliance Direction systems	PAP1-4060	120	2016/11/13
13	Loop Antenna	Rohde&Schwarz	HFH2-Z2	100020	2016/11/13
14	TURNTABLE	MATURO	TT2.0	----	N/A
15	ANTENNA MAST	MATURO	TAM-4.0-P	----	N/A
16	Horn Antenna	SCHWARZBECK	BBHA9170	25841	2016/11/13
17	ULTRA-BROADBAND ANTENNA	Rohde&Schwarz	HL562	100015	2016/11/13

Maximum Peak Output Power / Power Spectral Density / 6dB Bandwidth / Band Edge Compliance of RF Emission / Spurious RF Conducted Emission					
Item	Test Equipment	Manufacturer	Model No.	Serial No.	Last Cal.
1	Spectrum Analyzer	Rohde&Schwarz	FSP	1164.4391.40	2016/11/13
2	Power Meter	Anritsu	ML2480B	100798	2016/11/13
3	Power Sensor	Anritsu	MA2411B	100258	2016/11/13

The Cal. Interval was one year.

4.4. Environmental conditions

During the measurement the environmental conditions were within the listed ranges:

Temperature:	15~35°C
Relative Humidity:	30~60 %
Air Pressure:	950~1050 mba

4.5. Statement of the measurement uncertainty

The data and results referenced in this document are true and accurate. The reader is cautioned that there may be errors within the calibration limits of the equipment and facilities. The measurement uncertainty was calculated for all measurements listed in this test report acc. to TR-100028-01 "Electromagnetic compatibility and Radio spectrum Matters (ERM); Uncertainties in the measurement of mobile radio equipment characteristics; Part 1" and TR-100028-02 "Electromagnetic compatibility and Radio spectrum Matters (ERM); Uncertainties in the measurement of mobile radio equipment characteristics; Part 2" and is documented in the Shenzhen Huatongwei International Inspection Co., Ltd quality system acc. to DIN EN ISO/IEC 17025. Furthermore, component and process variability of devices similar to that tested may result in additional deviation. The manufacturer has the sole responsibility of continued compliance of the device.

Hereafter the best measurement capability for Shenzhen Huatongwei laboratory is reported:

Test Items	Measurement Uncertainty	Notes
Transmitter Power Conducted	0.57 dB	(1)
Transmitter Power Radiated	2.20 dB	(1)
Conducted Spurious Emission 9 kHz ~ 40 GHz	1.60 dB	(1)
Radiated Spurious Emission 9 kHz ~ 40 GHz	2.20 dB	(1)
Conducted Emission 9 kHz ~ 30 MHz	3.39 dB	(1)
Radiated Emission 30 ~ 1000 MHz	4.24 dB	(1)
Radiated Emission 1 ~ 18 GHz	5.16 dB	(1)
Radiated Emission 18 ~ 40 GHz	5.54 dB	(1)
Occupied Bandwidth	-----	(1)

(1) This uncertainty represents an expanded uncertainty expressed at approximately the 95% confidence level using a coverage factor of $k=1.96$.

5. TEST CONDITIONS AND RESULTS

5.1. Antenna requirement

Requirement

FCC CFR Title 47 Part 15 Subpart C Section 15.203:

An intentional radiator shall be designed to ensure that no antenna other than that furnished by the responsible party shall be used with the device. The use of a permanently attached antenna or of an antenna that uses a unique coupling to the intentional radiator, the manufacturer may design the unit so that a broken antenna can be replaced by the user, but the use of a standard antenna jack or electrical connector is prohibited.

FCC CFR Title 47 Part 15 Subpart C Section 15.247(c) (1)(i):

(i) Systems operating in the 2400-2483.5 MHz band that is used exclusively for fixed. Point-to-point operations may employ transmitting antennas with directional gain greater than 6 dBi provided the maximum conducted output power of the intentional radiator is reduced by 1 dB for every 3 dB that the directional gain of the antenna exceeds 6 dBi.

TEST RESULTS

Passed **Not Applicable**

The antenna is integral antenna, the best case gain of the antenna is 0.58dBi, please refer to the below antenna photo.

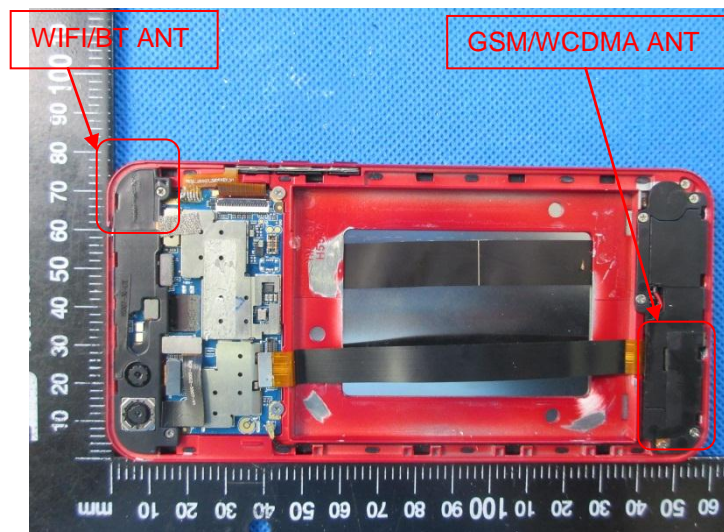

5.2. Conducted Emission (AC Main)

LIMIT

FCC CFR Title 47 Part 15 Subpart C Section 15.207

Frequency range (MHz)	Limit (dBuV)	
	Quasi-peak	Average
0.15-0.5	66 to 56*	56 to 46*
0.5-5	56	46
5-30	60	50

* Decreases with the logarithm of the frequency.

TEST CONFIGURATION

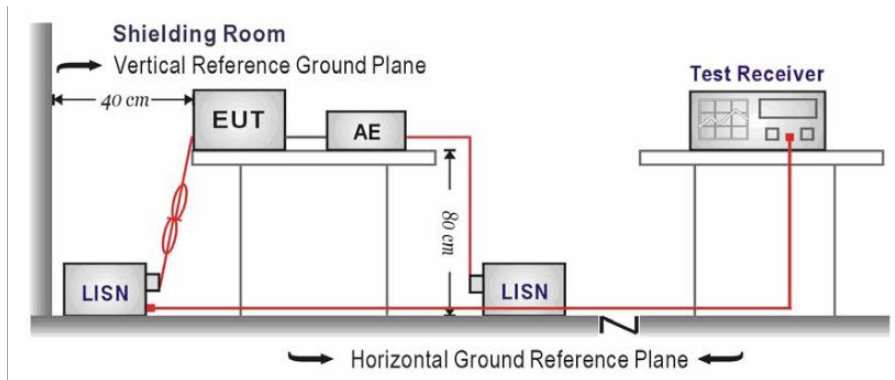

TEST PROCEDURE

1. The EUT was setup according to ANSI C63.10:2013 for compliance to FCC 47CFR 15.247 requirements.
2. The EUT was placed on a platform of nominal size, 1 m by 1.5 m, raised 80 cm above the conducting ground plane. The vertical conducting plane was located 40 cm to the rear of the EUT. All other surfaces of EUT were at least 80 cm from any other grounded conducting surface.
3. The EUT and simulators are connected to the main power through a line impedance stabilization network (LISN). The LISN provides a 50 ohm /50uH coupling impedance for the measuring equipment.
4. The peripheral devices are also connected to the main power through a LISN. (Please refer to the block diagram of the test setup and photographs)
5. Each current-carrying conductor of the EUT power cord, except the ground (safety) conductor, was individually connected through a LISN to the input power source.
6. The excess length of the power cord between the EUT and the LISN receptacle were folded back and forth at the center of the lead to form a bundle not exceeding 40 cm in length.
7. Conducted emissions were investigated over the frequency range from 0.15 MHz to 30 MHz using a receiver bandwidth of 9 kHz.
8. During the above scans, the emissions were maximized by cable manipulation.

TEST MODE:

Please refer to the clause 3.3

TEST RESULTS

Passed Not Applicable

Note:

- 1) Transd = Cable lose + Pulse Limiter Factor + Artificial Mains Factor
- 2) Margin = Limit - Level

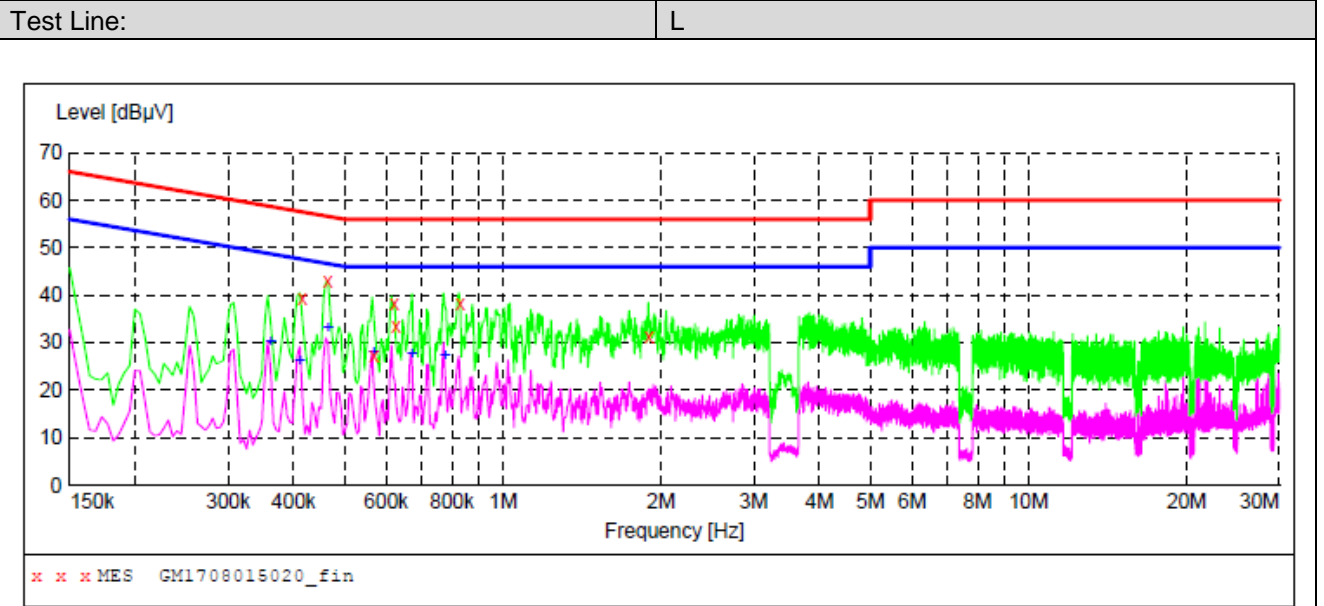

MEASUREMENT RESULT: "GM1708015020_fin"

8/1/2017 2:59PM

Frequency MHz	Level dBµV	Transd dB	Limit dBµV	Margin dB	Detector	Line	PE
0.415500	39.40	10.2	58	18.1	QP	L1	GND
0.465000	42.90	10.2	57	13.7	QP	L1	GND
0.568500	27.40	10.2	56	28.6	QP	L1	GND
0.622500	38.30	10.2	56	17.7	QP	L1	GND
0.627000	33.40	10.2	56	22.6	QP	L1	GND
0.829500	38.20	10.2	56	17.8	QP	L1	GND
1.896000	31.40	10.2	56	24.6	QP	L1	GND

MEASUREMENT RESULT: "GM1708015020_fin2"

8/1/2017 2:59PM

Frequency MHz	Level dBµV	Transd dB	Limit dBµV	Margin dB	Detector	Line	PE
0.361500	30.10	10.2	49	18.6	AV	L1	GND
0.411000	26.30	10.2	48	21.3	AV	L1	GND
0.465000	33.00	10.2	47	13.6	AV	L1	GND
0.568500	28.10	10.2	46	17.9	AV	L1	GND
0.672000	27.80	10.2	46	18.2	AV	L1	GND
0.775500	27.20	10.2	46	18.8	AV	L1	GND

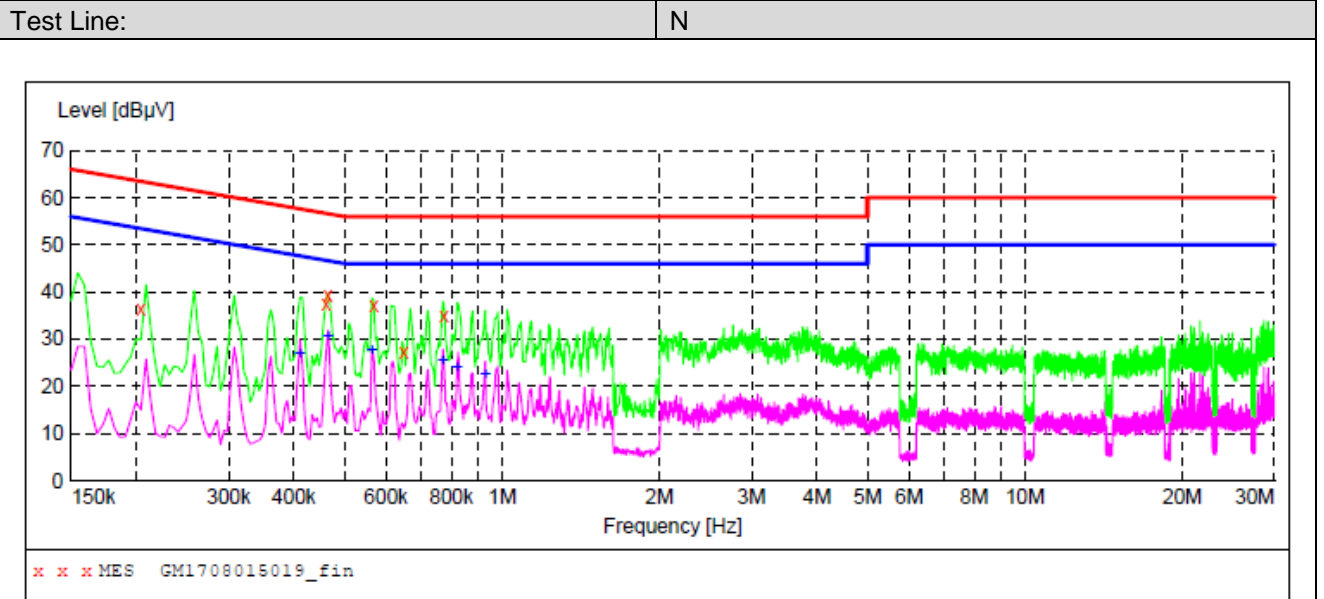

MEASUREMENT RESULT: "GM1708015019_fin"

8/1/2017 2:54PM

Frequency MHz	Level dBµV	Transd dB	Limit dBµV	Margin dB	Detector	Line	PE
0.204000	36.50	10.3	63	26.9	QP	N	GND
0.460500	37.50	10.2	57	19.2	QP	N	GND
0.465000	39.30	10.2	57	17.3	QP	N	GND
0.568500	37.30	10.2	56	18.7	QP	N	GND
0.649500	27.20	10.2	56	28.8	QP	N	GND
0.775500	35.10	10.2	56	20.9	QP	N	GND

MEASUREMENT RESULT: "GM1708015019_fin2"

8/1/2017 2:54PM

Frequency MHz	Level dBµV	Transd dB	Limit dBµV	Margin dB	Detector	Line	PE
0.411000	26.90	10.2	48	20.7	AV	N	GND
0.465000	30.40	10.2	47	16.2	AV	N	GND
0.564000	27.60	10.2	46	18.4	AV	N	GND
0.771000	25.50	10.2	46	20.5	AV	N	GND
0.820500	24.10	10.2	46	21.9	AV	N	GND
0.928500	22.60	10.2	46	23.4	AV	N	GND

5.3. Conducted Peak Output Power

LIMIT

FCC CFR Title 47 Part 15 Subpart C Section 15.247 (b)(3): **30 dBm**

TEST CONFIGURATION

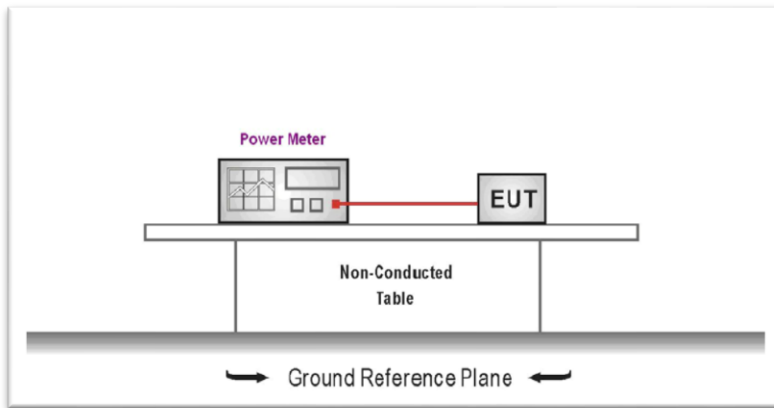

TEST PROCEDURE

1. The EUT was tested according to KDB 558074 D01 V03R03 for compliance to FCC 47CFR 15.247 requirements.
2. The maximum peak conducted output power may be measured using a broadband peak RF power meter.
3. The power meter shall have a video bandwidth that is greater than or equal to the DTS bandwidth and shall utilize a fast-responding diode detector.
4. Record the measurement data.

TEST MODE:

Please refer to the clause 3.3

TEST RESULTS

Passed **Not Applicable**

Type	Channel	Output power (dBm)	Limit (dBm)	Result
BT-BLE	00	-5.04	30.00	Pass
	19	-5.13		
	39	-5.55		

5.4. Power Spectral Density

LIMIT

FCC CFR Title 47 Part 15 Subpart C Section 15.247 (e): **8dBm/3KHz**

For digitally modulated systems, the power spectral density conducted from the intentional radiator to the antenna shall not be greater than 8 dBm in any 3 kHz band during any time interval of continuous transmission.

TEST CONFIGURATION

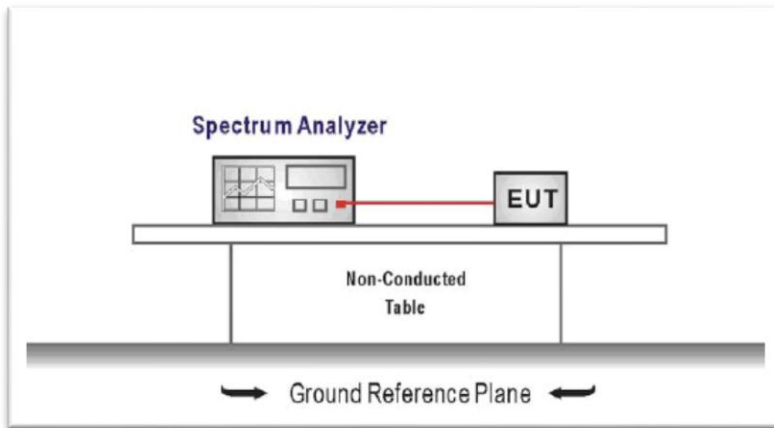

TEST PROCEDURE

1. Connect the antenna port(s) to the spectrum analyzer input,
2. Configure the spectrum analyzer as shown below:
 Center frequency=DTS channel center frequency
 Span =1.5 times the DTS bandwidth
 RBW = 3 kHz ≤ RBW ≤ 100 kHz, VBW ≥ 3 × RBW
 Sweep time = auto couple
 Detector = peak
 Trace mode = max hold
3. Place the radio in continuous transmit mode, allow the trace to stabilize, view the transmitter waveform on the spectrum analyzer.
4. Use the peak marker function to determine the maximum amplitude level within the RBW.
5. If measured value exceeds limit, reduce RBW (no less than 3 kHz) and repeat.

TEST MODE:

Please refer to the clause 3.3

TEST RESULTS

Passed Not Applicable

Type	Channel	Power Spectral Density(dBm/3kHz)	Limit (dBm/3kHz)	Result
BT-BLE	00	-20.61	8.00	Pass
	19	-20.83		
	39	-21.18		

Test plot as follows:

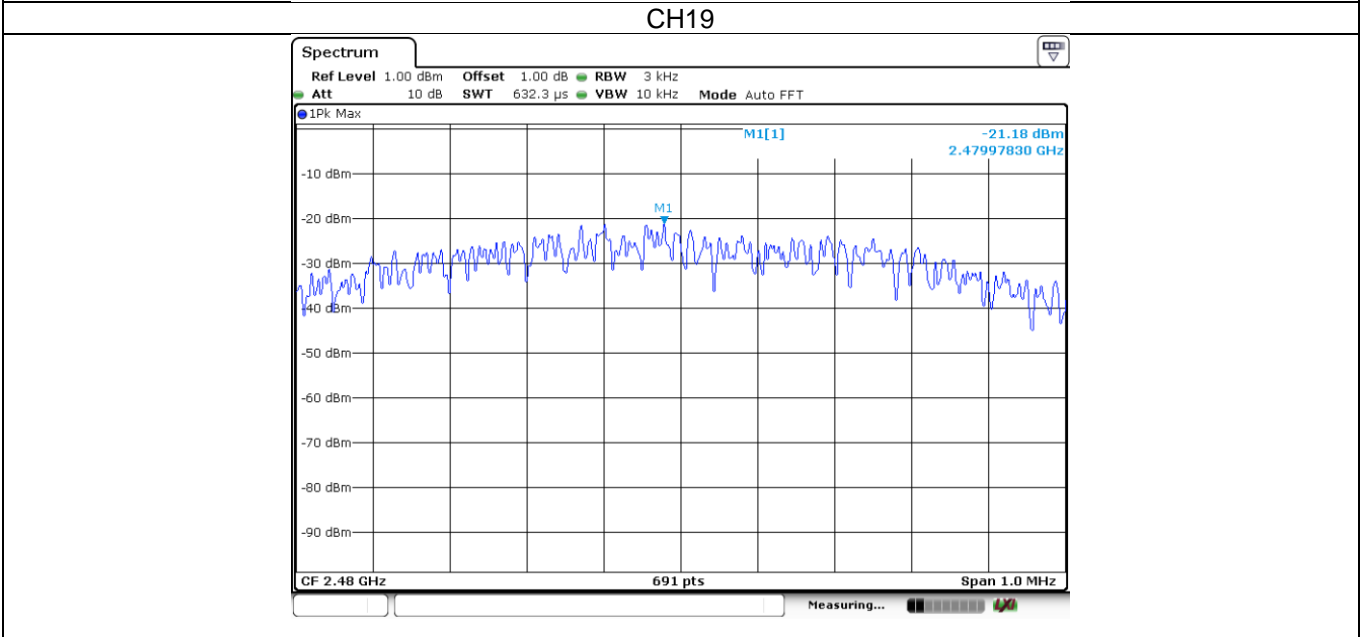
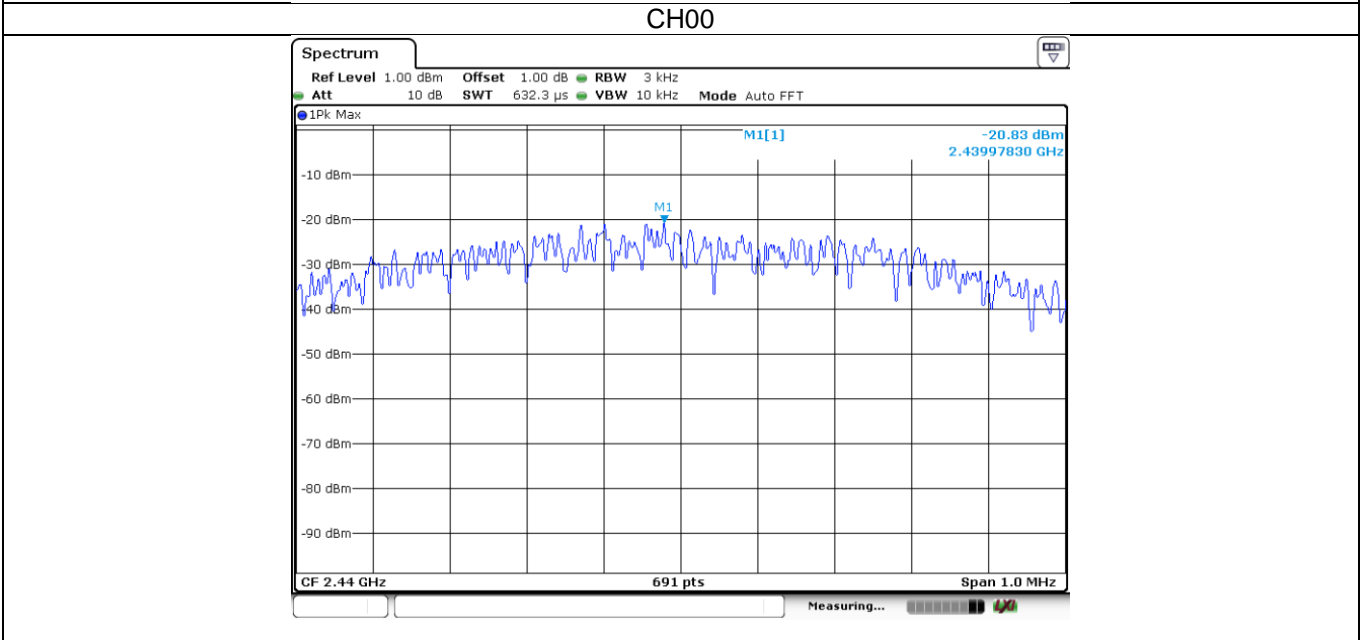
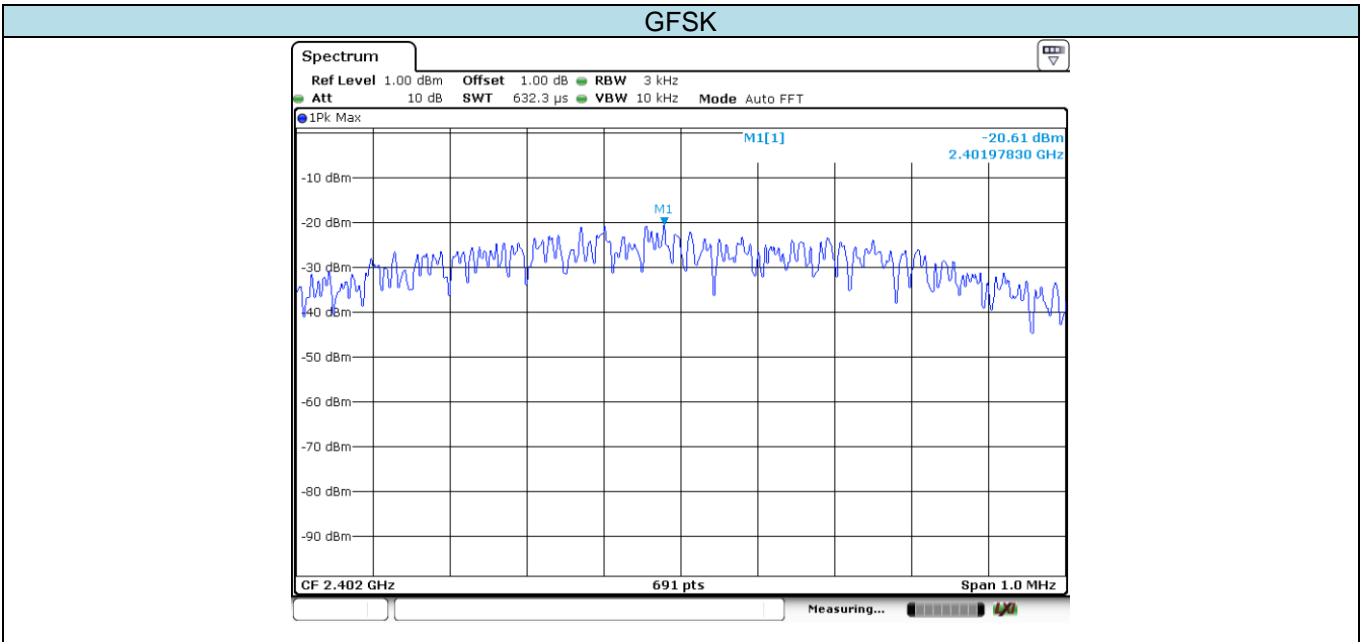

CH39

5.5. 6dB bandwidth

LIMIT

FCC CFR Title 47 Part 15 Subpart C Section 15.247 (a)(2):

For digital modulation systems, the minimum 6 dB bandwidth shall be at least 500 kHz.

TEST CONFIGURATION

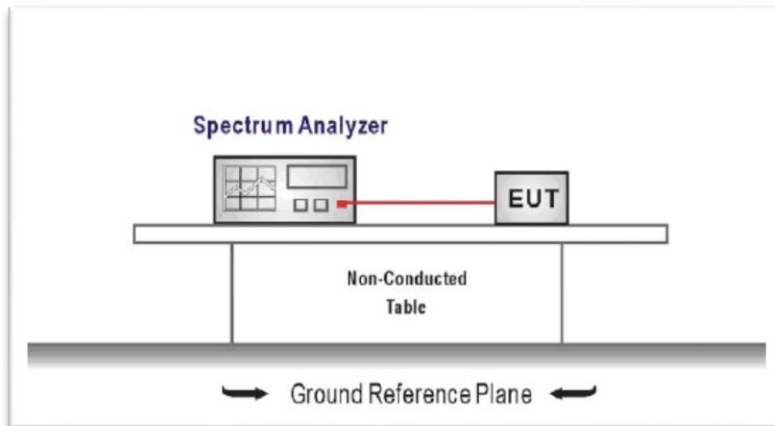

TEST PROCEDURE

1. Connect the antenna port(s) to the spectrum analyzer input.
2. Configure the spectrum analyzer as shown below (enter all losses between the transmitter output and the spectrum analyzer).
 Center Frequency = DTS channel center frequency
 Span = 2 x DTS bandwidth
 RBW = 100 kHz, VBW ≥ 3 x RBW
 Sweep time = auto couple
 Detector = Peak
 Trace mode = max hold
3. Place the radio in continuous transmit mode, allow the trace to stabilize, view the transmitter waveform on the spectrum analyzer.
4. Measure the maximum width of the emission that is constrained by the frequencies associated with the two outermost amplitude points (upper and lower frequencies) that are attenuated by 6 dB relative to the maximum level measured in the fundamental emission, and record the pertinent measurements.

TEST MODE:

Please refer to the clause 3.3

TEST RESULTS

Passed Not Applicable

Type	Channel	6dB Bandwidth(kHz)	Limit (kHz)	Result
BT-BLE	00	706.20	≥500	Pass
	19	714.90		
	39	703.30		

Test plot as follows:

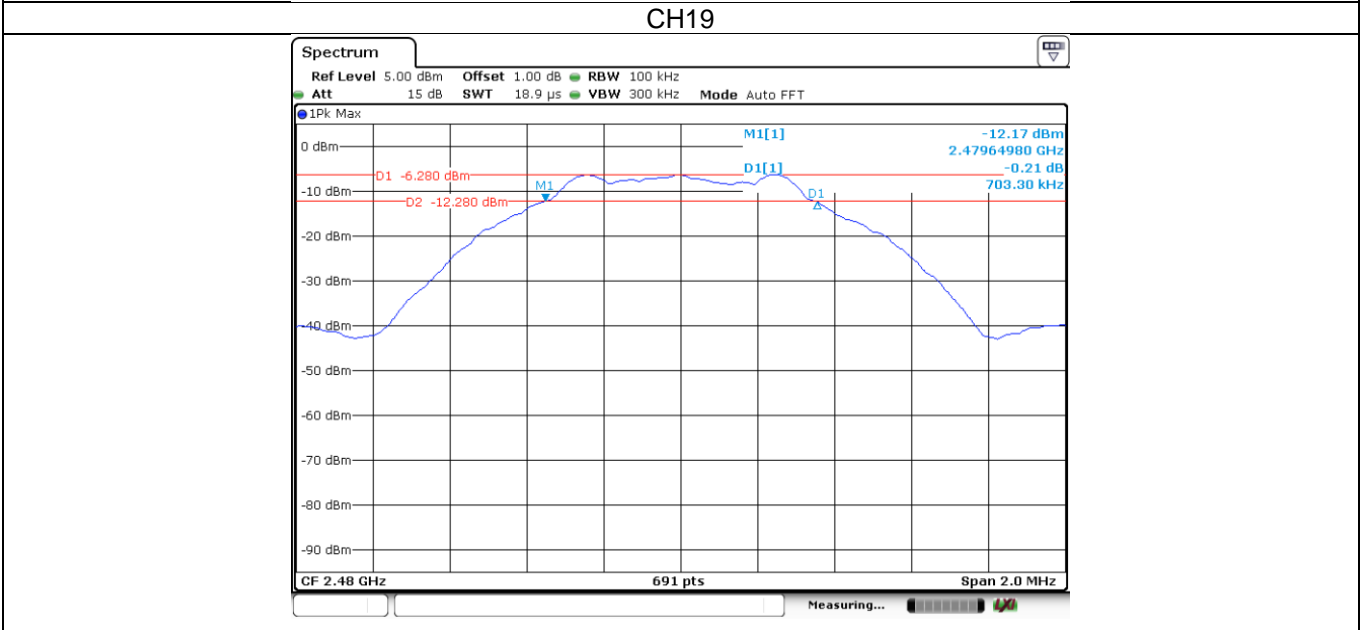
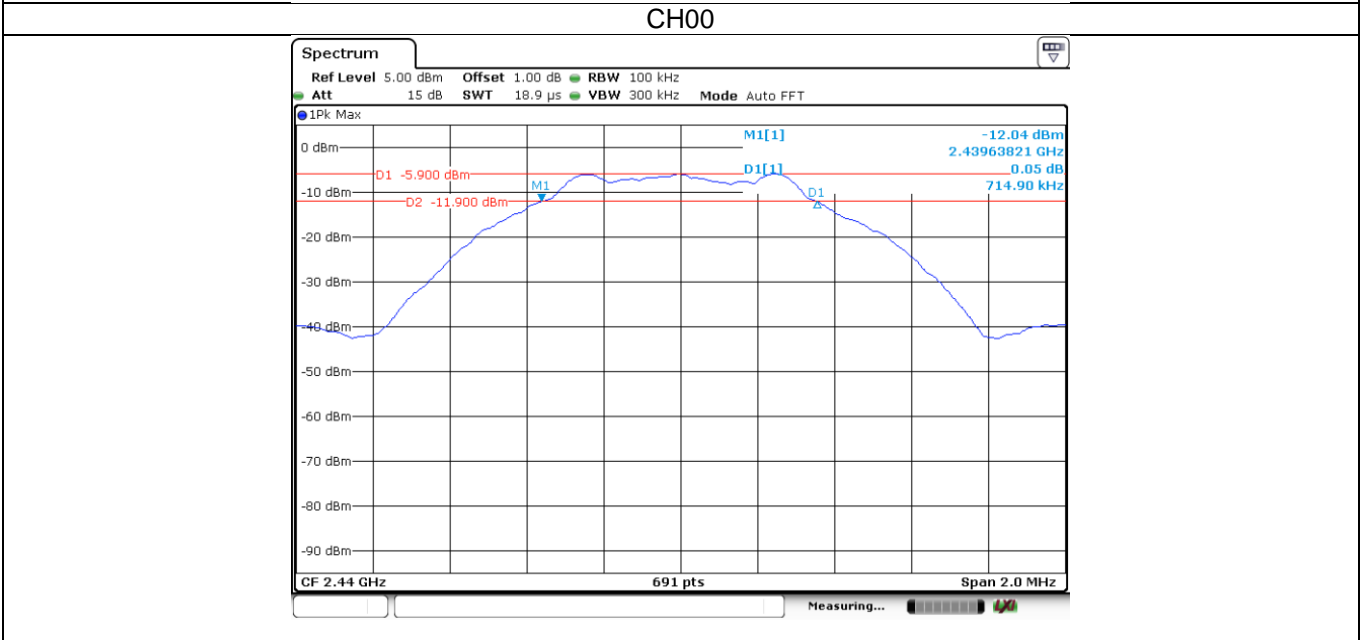
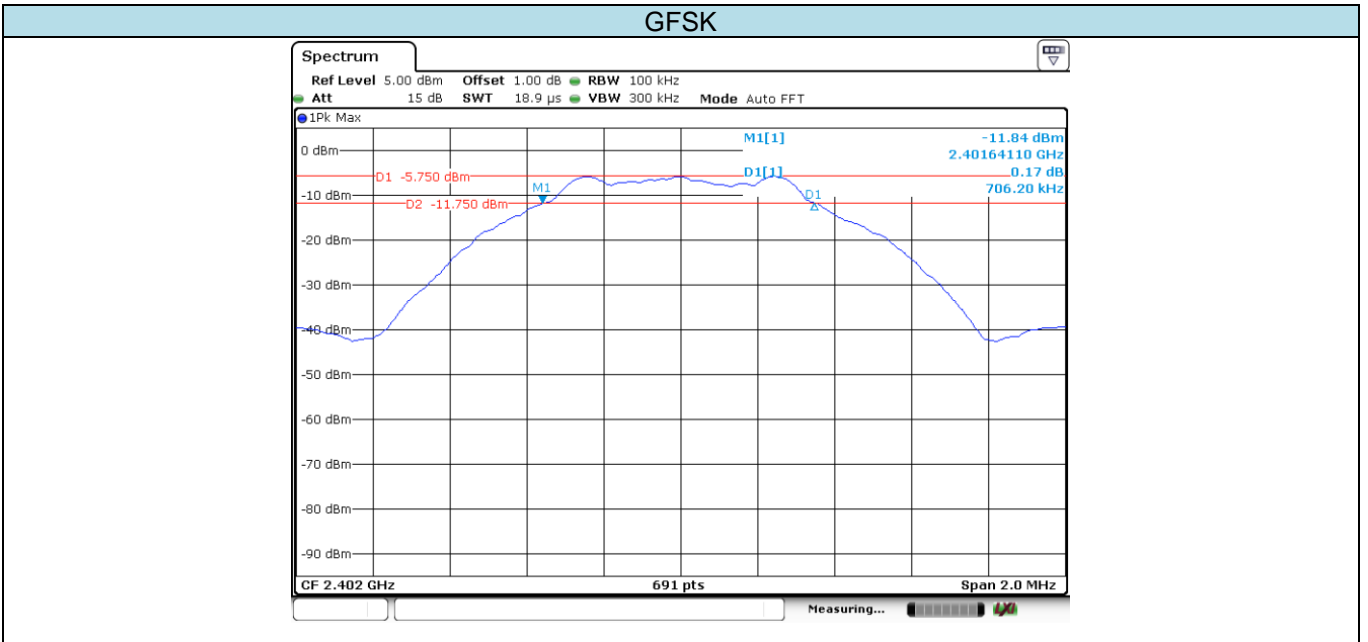

CH39

5.6. Restricted band

LIMIT

FCC CFR Title 47 Part 15 Subpart C Section 15.247 (d):

In any 100 kHz bandwidth outside the frequency band in which the spread spectrum or digitally modulated intentional radiator is operating, radiated emissions which fall in the restricted bands, as defined in §15.205(a), must also comply with the radiated emission limits specified in §15.209(a) (see §15.205(c)).

TEST CONFIGURATION

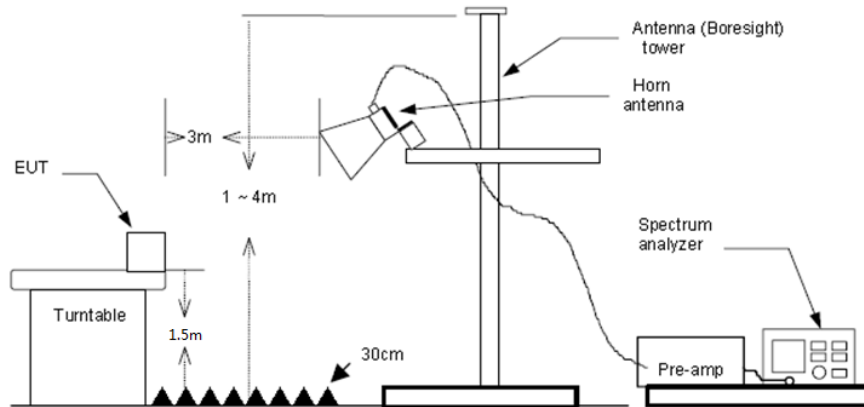

TEST PROCEDURE

1. The EUT was setup and tested according to ANSI C63.10:2013 for compliance to FCC 47CFR 15.247 requirements.
2. The EUT is placed on a turn table which is 1.5 meter above ground. The turn table is rotated 360 degrees to determine the position of the maximum emission level.
3. The EUT was positioned such that the distance from antenna to the EUT was 3 meters.
4. The antenna is scanned from 1 meter to 4 meters to find out the maximum emission level. This is repeated for both horizontal and vertical polarization of the antenna. In order to find the maximum emission, all of the interface cables were manipulated according to ANSI C63.10:2013 on radiated measurement.
5. The receiver set as follow:
 RBW=1 MHz, VBW=3 MHz for Peak value
 RBW=1 MHz, VBW=3 MHz RMS detector for Average value.

TEST MODE:

Please refer to the clause 3.3

TEST RESULTS

Passed **Not Applicable**

Note:

- 1) Final level= Read level + Antenna Factor+ Cable Loss- Preamp Factor
- 2) The peak level is lower than average limit(54 dBuV/m), this data is the too weak instrument of signal is unable to test.

BT-BLE					CH00				
Frequency (MHz)	Read Level (dBuV)	Antenna Factor (dB/m)	Cable Loss (dB)	Preamp Factor (dB)	Level (dBuV/m)	Limit Line (dBuV/m)	Margin Limit (dB)	Polarization	Test value
2310.00	35.23	28.05	6.62	37.65	32.25	74.00	-41.75	Vertical	Peak
2390.03	35.19	27.65	6.75	37.87	31.72	74.00	-42.28	Vertical	
2310.00	34.51	28.05	6.62	37.65	31.53	74.00	-42.47	Horizontal	
2390.03	35.24	27.65	6.75	37.87	31.77	74.00	-42.23	Horizontal	

BT-BLE					CH39				
Frequency (MHz)	Read Level (dBuV)	Antenna Factor (dB/m)	Cable Loss (dB)	Preamp Factor (dB)	Level (dBuV/m)	Limit Line (dBuV/m)	Margin Limit (dB)	Polarization	Test value
2483.50	45.16	27.26	6.83	37.87	41.38	74.00	-32.62	Vertical	Peak
2500.00	35.37	27.20	6.84	37.87	31.54	74.00	-42.46	Vertical	
2483.50	40.31	27.26	6.83	37.87	36.53	74.00	-37.47	Horizontal	
2500.00	35.35	27.20	6.84	37.87	31.52	74.00	-42.48	Horizontal	

5.7. Band edge and Spurious Emission (conducted)

LIMIT

FCC CFR Title 47 Part 15 Subpart C Section 15.247 (d):

In any 100 kHz bandwidth outside the frequency band in which the spread spectrum intentional radiator is operating, the radio frequency power that is produced by the intentional radiator shall be at least 20 dB below that in the 100 kHz bandwidth within the band that contains the highest level of the desired power, based on either an RF conducted or a radiated measurement.

TEST CONFIGURATION

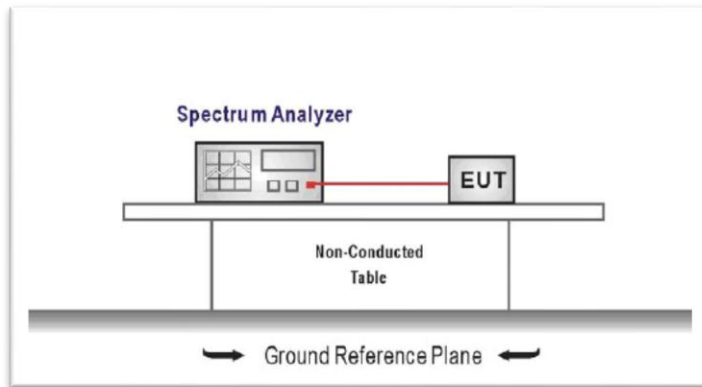

TEST PROCEDURE

1. Connect the antenna port(s) to the spectrum analyzer input.
2. Establish a reference level by using the following procedure
Center frequency=DTS channel center frequency
The span = 1.5 times the DTS bandwidth.
RBW = 100 kHz, VBW $\geq 3 \times$ RBW
Detector = peak, Sweep time = auto couple, Trace mode = max hold
Allow trace to fully stabilize
Use the peak marker function to determine the maximum PSD level

Note that the channel found to contain the maximum PSD level can be used to establish the reference level.

3. Emission level measurement
Set the center frequency and span to encompass frequency range to be measured
RBW = 100 kHz, VBW $\geq 3 \times$ RBW
Detector = peak, Sweep time = auto couple, Trace mode = max hold
Allow trace to fully stabilize
Use the peak marker function to determine the maximum amplitude level.
4. Place the radio in continuous transmit mode, allow the trace to stabilize, view the transmitter waveform on the spectrum analyzer.
5. Ensure that the amplitude of all unwanted emissions outside of the authorized frequency band excluding restricted frequency bands) are attenuated by at least the minimum requirements specified (at least 20 dB relative to the maximum in-band peak PSD level in 100 kHz). Report the three highest emissions relative to the limit.

TEST MODE:

Please refer to the clause 3.3

TEST RESULTS

Passed Not Applicable

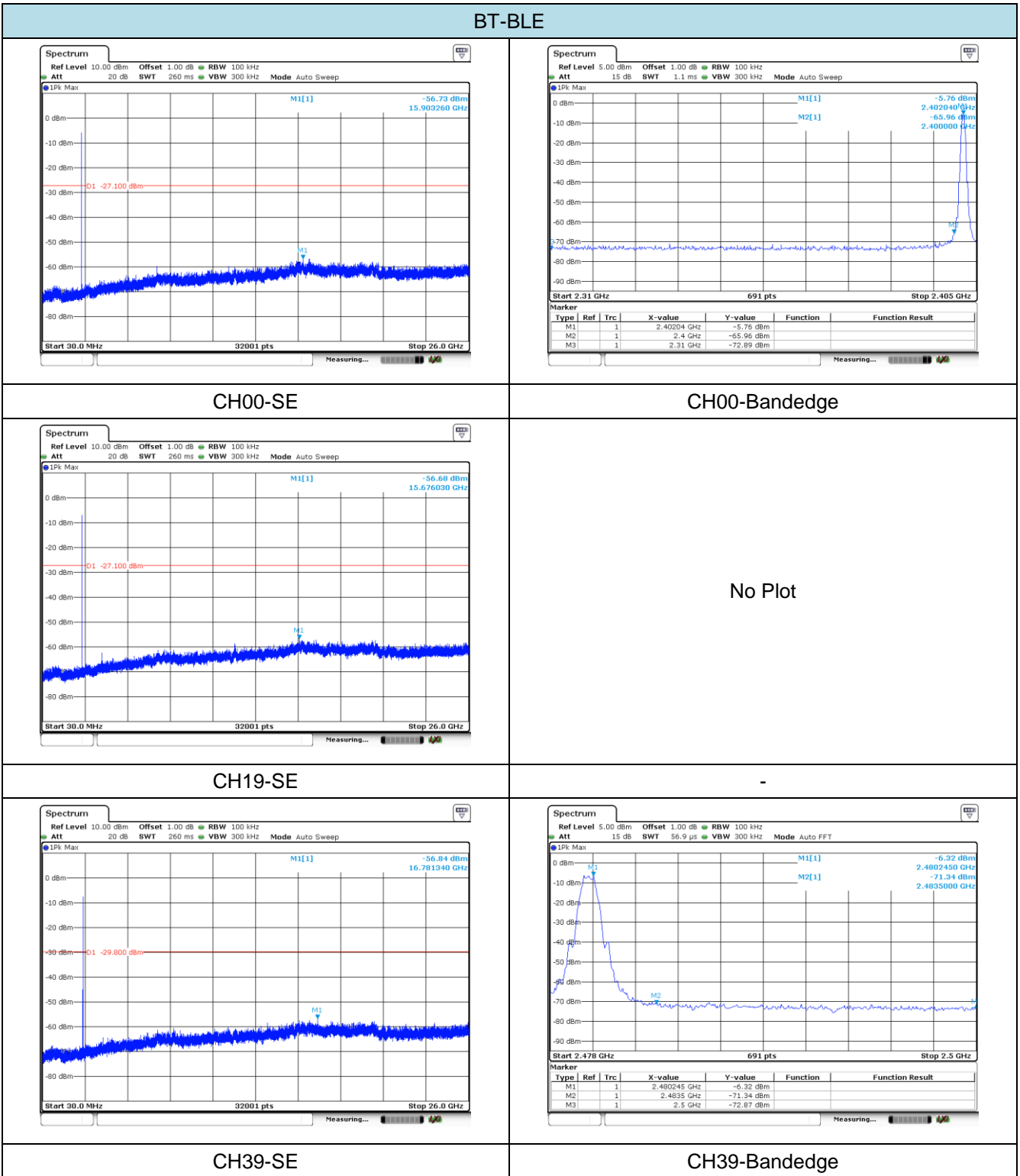

5.8. Spurious Emission (radiated)

LIMIT

FCC CFR Title 47 Part 15 Subpart C Section 15.209

Frequency	Limit (dBuV/m @3m)	Value
30MHz-88MHz	40.00	Quasi-peak
88MHz-216MHz	43.50	Quasi-peak
216MHz-960MHz	46.00	Quasi-peak
960MHz-1GHz	54.00	Quasi-peak
Above 1GHz	54.00	Average
	74.00	Peak

TEST CONFIGURATION

- 9 kHz ~ 30 MHz

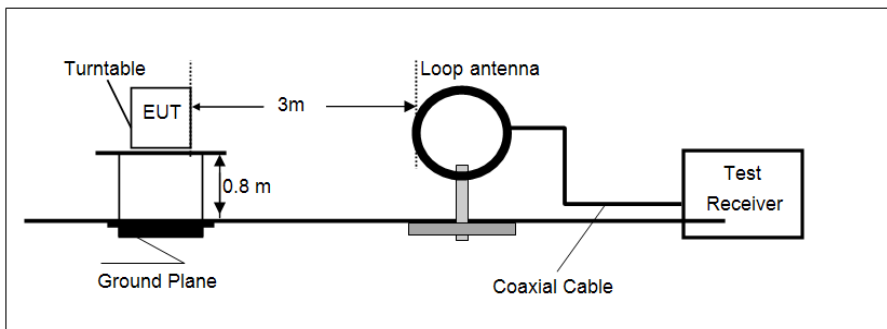

- 30 MHz ~ 1 GHz

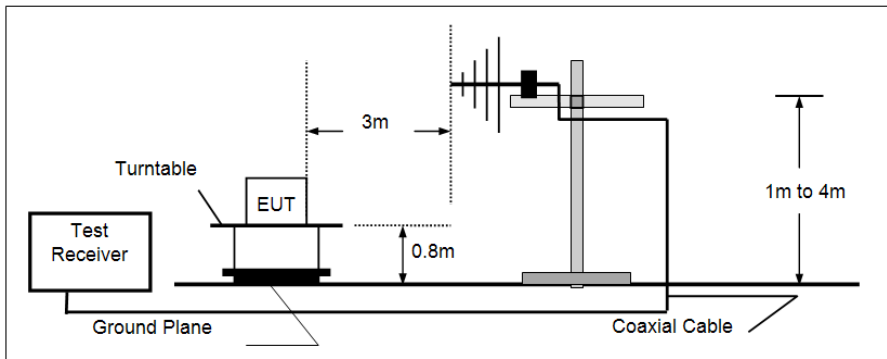

- Above 1 GHz

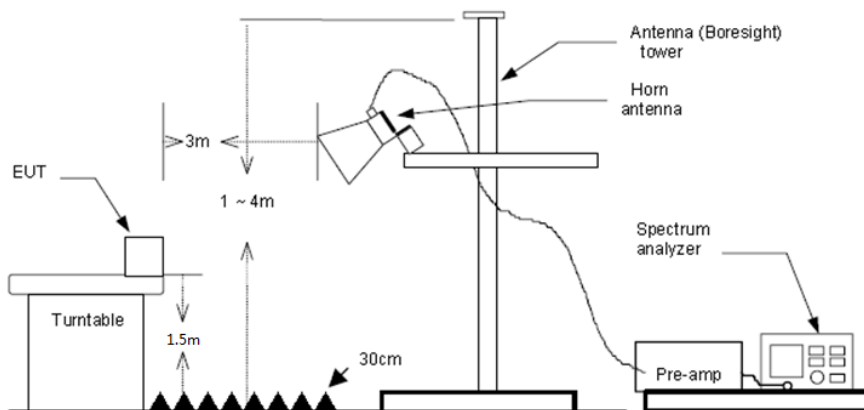

TEST PROCEDURE

1. The EUT was setup and tested according to ANSI C63.10:2013 for compliance to FCC 47CFR 15.247 requirements.
2. The EUT is placed on a turn table which is 0.8 meter above ground for below 1 GHz, and 1.5 m for above 1 GHz. The turn table is rotated 360 degrees to determine the position of the maximum emission level.
3. The EUT was positioned such that the distance from antenna to the EUT was 3 meters.
4. The antenna is scanned from 1 meter to 4 meters to find out the maximum emission level. This is repeated for both horizontal and vertical polarization of the antenna. In order to find the maximum emission, all of the interface cables were manipulated according to ANSI C63.10:2013 on radiated measurement.
5. Use the following spectrum analyzer settings
 - (1) Span shall wide enough to fully capture the emission being measured;
 - (2) Below 1 GHz, RBW=120 kHz, VBW=300 kHz, Sweep=auto, Detector function=peak, Trace=max hold; If the emission level of the EUT measured by the peak detector is 3 dB lower than the applicable limit, the peak emission level will be reported. Otherwise, the emission measurement will be repeated using the quasi-peak detector and reported.
 - (3) Above 1 GHz, RBW=1 MHz, VBW=3 MHz for Peak value
RBW=1 MHz, VBW=3 MHz RMS detector for Average value.

TEST MODE:

Please refer to the clause 3.3

TEST RESULTS

Passed **Not Applicable**

Note:

- 1) Above 1GHz Final Level =Receiver Read level + Antenna Factor + Cable Loss – Preamplifier Factor
 - 2) The emission levels of other frequencies are very lower than the limit and not show in test report.
- **9 kHz ~ 30 MHz**
The EUT was pre-scanned the frequency band (9 kHz ~ 30 MHz), found the radiated level lower than the limit, so don't show on the report.
- **30 MHz ~ 1000 MHz**
Have pre-scan all modulation mode, found the BT-BLE mode CH00 which it was worst case, so only the worst case's data on the test report.

➤ 30 MHz ~ 1 GHz

Polarization: Vertical

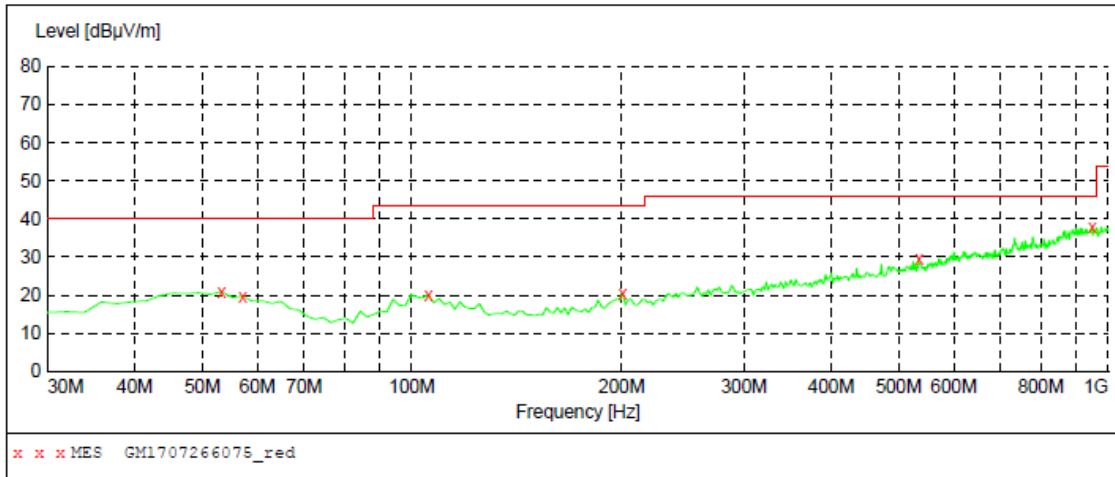

MEASUREMENT RESULT: "GM1707266075_red"

7/26/2017 4:01PM

Frequency MHz	Level dBµV/m	Transd dB	Limit dBµV/m	Margin dB	Det.	Height cm	Azimuth deg	Polarization
53.280000	21.00	-9.0	40.0	19.0	QP	100.0	77.00	VERTICAL
57.160000	19.70	-9.4	40.0	20.3	QP	100.0	118.00	VERTICAL
105.660000	20.20	-10.5	43.5	23.3	QP	100.0	229.00	VERTICAL
200.720000	20.60	-9.9	43.5	22.9	QP	100.0	171.00	VERTICAL
534.400000	29.40	-1.1	46.0	16.6	QP	100.0	106.00	VERTICAL
947.620000	37.90	7.2	46.0	8.1	QP	100.0	0.00	VERTICAL

Polarization: Horizontal

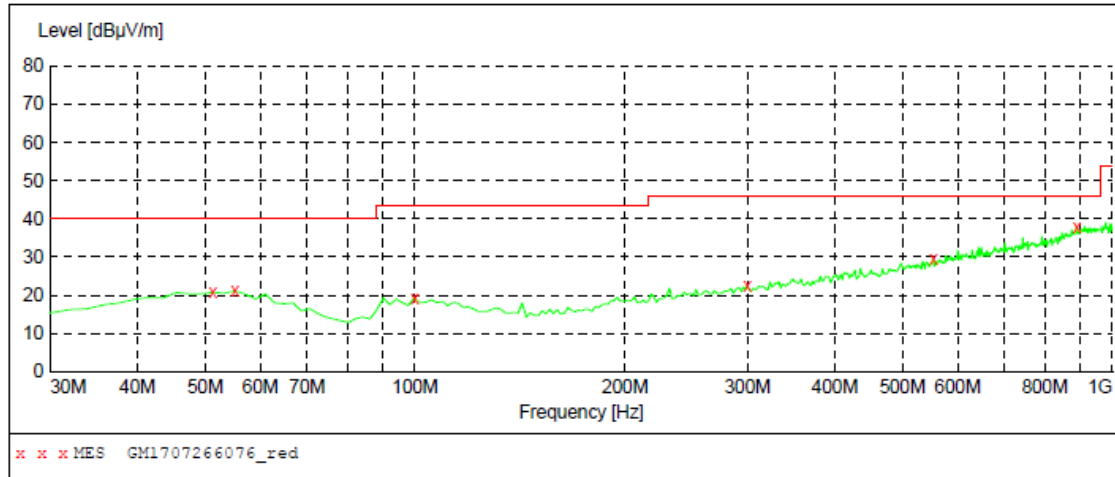

MEASUREMENT RESULT: "GM1707266076_red"

7/26/2017 4:04PM

Frequency MHz	Level dBµV/m	Transd dB	Limit dBµV/m	Margin dB	Det.	Height cm	Azimuth deg	Polarization
51.340000	20.80	-8.8	40.0	19.2	QP	100.0	225.00	HORIZONTAL
55.220000	21.10	-9.2	40.0	18.9	QP	300.0	39.00	HORIZONTAL
99.840000	19.40	-10.6	43.5	24.1	QP	300.0	121.00	HORIZONTAL
299.660000	22.50	-7.3	46.0	23.5	QP	100.0	333.00	HORIZONTAL
553.800000	29.40	-0.7	46.0	16.6	QP	100.0	333.00	HORIZONTAL
889.420000	38.00	6.5	46.0	8.0	QP	100.0	225.00	HORIZONTAL

➤ Above 1 GHz

BT-BLE					CH00				
Frequency (MHz)	Read Level (dBuV)	Antenna Factor (dB/m)	Cable Loss (dB)	Preamp Factor (dB)	Level (dBuV/m)	Limit Line (dBuV/m)	Margin Limit (dB)	Polarization	Test value
1442.76	37.47	25.86	5.12	36.52	31.93	74.00	-42.07	Vertical	Peak
3291.39	37.88	28.25	7.83	38.36	35.60	74.00	-38.40	Vertical	
4809.50	37.93	31.58	9.55	36.93	42.13	74.00	-31.87	Vertical	
6494.56	31.36	33.96	11.16	35.33	41.15	74.00	-32.85	Vertical	
1385.18	36.51	25.94	4.97	36.47	30.95	74.00	-43.05	Horizontal	Peak
3010.83	36.99	28.62	7.49	38.23	34.87	74.00	-39.13	Horizontal	
3923.37	36.27	29.70	8.67	38.16	36.48	74.00	-37.52	Horizontal	
5880.78	32.40	32.26	10.62	35.37	39.91	74.00	-34.09	Horizontal	

BT-BLE					CH19				
Frequency (MHz)	Read Level (dBuV)	Antenna Factor (dB/m)	Cable Loss (dB)	Preamp Factor (dB)	Level (dBuV/m)	Limit Line (dBuV/m)	Margin Limit (dB)	Polarization	Test value
1777.65	36.59	25.36	5.92	37.09	30.78	74.00	-43.22	Vertical	Peak
3672.11	36.97	29.30	8.35	38.26	36.36	74.00	-37.64	Vertical	
4883.52	37.51	31.43	9.59	36.73	41.80	74.00	-32.20	Vertical	
7508.69	31.95	36.11	12.42	34.91	45.57	74.00	-28.43	Vertical	
2223.98	35.22	27.65	6.48	37.41	31.94	74.00	-42.06	Horizontal	
3570.71	37.47	29.21	8.22	38.31	36.59	74.00	-37.41	Horizontal	
7045.74	32.40	35.44	11.85	34.86	44.83	74.00	-29.17	Horizontal	

BT-BLE					CH39				
Frequency (MHz)	Read Level (dBuV)	Antenna Factor (dB/m)	Cable Loss (dB)	Preamp Factor (dB)	Level (dBuV/m)	Limit Line (dBuV/m)	Margin Limit (dB)	Polarization	Test value
1968.18	36.05	25.99	6.22	37.27	30.99	74.00	-43.01	Vertical	Peak
3010.83	38.63	28.62	7.49	38.23	36.51	74.00	-37.49	Vertical	
5718.40	32.74	31.69	10.46	35.54	39.35	74.00	-34.65	Vertical	
7357.33	32.44	36.30	12.03	34.88	45.89	74.00	-28.11	Vertical	
1764.12	49.39	25.33	5.89	37.06	43.55	74.00	-30.45	Horizontal	
3241.50	36.89	28.55	7.77	38.27	34.94	74.00	-39.06	Horizontal	
5177.97	33.47	31.59	9.81	36.22	38.65	74.00	-35.35	Horizontal	
7432.62	32.13	36.23	12.18	34.85	45.69	74.00	-28.31	Horizontal	

Remark:

- Final Level = Receiver Read level + Antenna Factor + Cable Loss – Pre-amplifier Factor
- The peak level is lower than average limit (54 dBuV/m), this data is the too weak instrument of signal is unable to test.
- The emission levels of other frequencies are very lower than the limit and not show in test report.

6. Test Setup Photos of the EUT

Radiated Emission

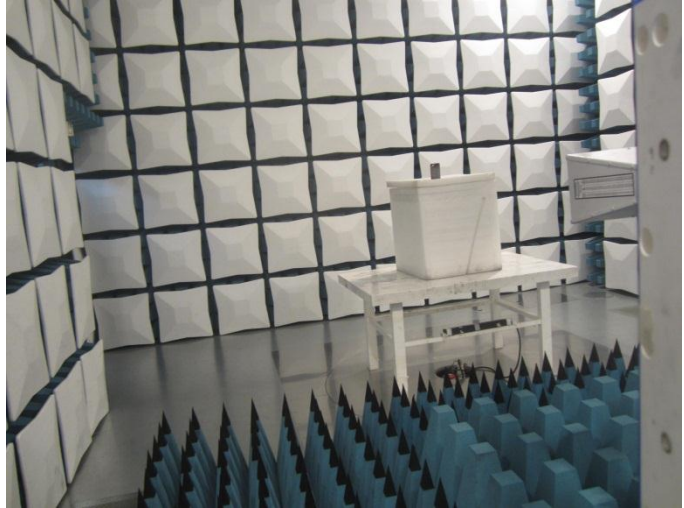
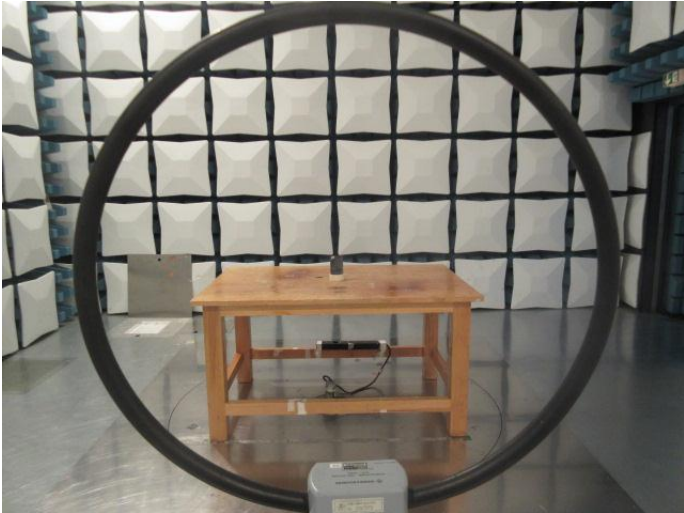

Conducted Emission (AC Mains)



7. External and Internal Photos of the EUT

Reference to Test Report No.: TRE1707013801.

.....**End of Report**.....