



TEST REPORT

FCC ID: 2AFCBLY-97

On Behalf of

Shenzhen Longzhiyuan Technology Co., Ltd.

SMART PET FEEDER

Model No.: LY-97

Prepared for : Shenzhen Longzhiyuan Technology Co., Ltd.
Address : 5F Building B, Zhuangbian 2nd Industrial Park, Hezhou Industrial
District, Xixiang Town, Bao' an District, Shenzhen, China

Prepared By : Shenzhen Alpha Product Testing Co., Ltd.
Address : Building i, No.2, Lixin Road, Fuyong Street, Bao'an District, 518103,
Shenzhen, Guangdong, China

Report Number : T1871569 05
Date of Receipt : June 24,2017
Date of Test : June 24,2017- July 11,2017
Date of Report : July 11,2017
Version Number : REV0

TABLE OF CONTENT

Description	Page
1 General Information -----	6
1.1 Description of Device (EUT) -----	6
1.2 Accessories of device (EUT) -----	7
1.3 Test Lab information -----	7
2 EMC Equipment List -----	8
3 Test Procedure -----	9
4 Summary of Measurement -----	10
4.1 Summary of test result -----	10
4.2 Test connection -----	10
4.3 Assistant equipment used for test -----	11
4.4 Test mode -----	11
4.5 Channel list -----	11
4.6 Test Conditions -----	12
4.7 Measurement Uncertainty (95% confidence levels, k=2) -----	12
5 Spurious Emission -----	13
5.1 Radiation Emission -----	13
5.1.1 Radiation Emission Limits(15.209) -----	13
5.1.2 Test Setup -----	13
5.1.3 Test Procedure -----	15
5.1.4 Test Equipment Setting For emission test Result -----	16
5.1.5 Test Condition -----	16
5.1.6 Test Result -----	16
6 POWER LINE CONDUCTED EMISSION -----	31
6.1 Conducted Emission Limits(15.207) -----	31
6.2 Test Setup -----	31
6.3 Test Procedure -----	32
6.4 Test Results -----	32
7 Conducted Maximum Output Power -----	35
7.1 Test limit -----	35
7.2 Test Procedure -----	35
7.3 Test Setup -----	35
7.4 Test Results -----	35
8 PEAK POWER SPECTRAL DENSITY -----	37
8.1 Test limit -----	37
8.2 Method of measurement -----	37
8.3 Test Setup -----	37
8.4 Test Results -----	38
9 Bandwidth -----	45
9.1 Test limit -----	45
9.2 Method of measurement -----	45
9.3 Test Setup -----	45
9.4 Test Results -----	45
10 Band Edge Check -----	53
10.1 Test limit -----	53

10.2	Test Procedure -----	53
10.3	Test Setup-----	53
10.4	Test Result-----	53
11	Antenna Requirement -----	74
11.1	Standard Requirement -----	74
11.2	Antenna Connected Construction -----	74
11.3	Result-----	74
12	Test setup photo -----	75
12.1	Photos of Radiated emission -----	75
12.2	Photos of Conducted Emission test -----	76
13	Photographs of EUT -----	77

TEST REPORT DECLARATION

Applicant : Shenzhen Longzhiyuan Technology Co., Ltd.
 Address : 5F Building B, Zhuangbian 2nd Industrial Park, Hezhou Industrial District, Xixiang Town, Bao'an District, Shenzhen, China
 Manufacturer : Shenzhen Longzhiyuan Technology Co., Ltd.
 Address : 5F Building B, Zhuangbian 2nd Industrial Park, Hezhou Industrial District, Xixiang Town, Bao'an District, Shenzhen, China
 EUT Description : SMART PET FEEDER
 (A) Model No. : LY-97
 (B) Trademark : N/A

Measurement Standard Used:

FCC Rules and Regulations Part 15 Subpart C 2016, ANSI C63.4:2014, ANSI C63.10:2013

The device described above is tested by Shenzhen Alpha Product Testing Co., Ltd. to determine the maximum emission levels emanating from the device. The maximum emission levels are compared to the FCC Part 15 Subpart C limits both conducted and radiated emissions. The test results are contained in this test report and Shenzhen Alpha Product Testing Co., Ltd. is assumed of full responsibility for the accuracy and completeness of these tests.

After the test, our opinion is that EUT compliance with the requirement of the above standards.

This report applies to above tested sample only. This report shall not be reproduced in parts without written approval of Shenzhen Alpha Product Testing Co., Ltd.

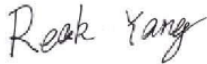
Tested by (name + signature).....: Reak Yang
 Project Engineer 

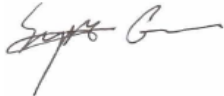
Approved by (name + signature).....: Simple Guan
 Project Manager 

Date of issue.....: July 11,2017

Revision History

Revision	Issue Date	Revisions	Revised By
00	July 11,2017	Initial released Issue	Simple Guan

1 General Information

1.1 Description of Device (EUT)

EUT Name : SMART PET FEEDER

Trade Name : N/A

Model No. : LY-97

Power supply : DC 5V from adapter input AC 120V/60Hz
IEEE 802.11b/g: 2412MHz-2462MHz

Operation frequency : IEEE 802.11n HT20: 2412MHz-2462MHz
IEEE 802.11n HT40: 2422MHz-2452MHz
IEEE 802.11b: DSSS(CCK,DQPSK,DBPSK)

Modulation : IEEE 802.11g: OFDM(64QAM, 16QAM, QPSK, BPSK)
IEEE 802.11n: OFDM (64QAM, 16QAM, QPSK,BPSK)

Antenna Type : PIFA Antenna, Maximum Gain is 1.10dBi for WIFI

Software version : V1.3

Hardware version : V1.0

1.2 Accessories of device (EUT)

Accessories1 : Adapter
Model : MX12L1~0502000V
Input : 100-240V~50-60Hz
Output : 5V, 2A

1.3 Test Lab information

Shenzhen Alpha Product Testing Co., Ltd
Building i, No.2, Lixin Road, Fuyong Street, Bao'an District, 518103,
Shenzhen, Guangdong, China

August 11, 2014 File on Federal Communication Commission
Registration Number: 203110

July 26, 2017 Certificated by IC
Registration Number: 12135A

2 EMC Equipment List

Equipment	Manufacture	Model No.	Serial No.	Last cal.	Cal Interval
3m Semi-Anechoic	ETS-LINDGR EN	N/A	SEL0017	2016.09.29	1Year
Spectrum analyzer	Agilent	E4407B	MY46185649	2016.09.29	1Year
Receiver	R&S	ESCI	1166.5950K03-101 1	2016.09.29	1Year
Receiver	R&S	ESCI	101202	2016.09.29	1Year
Bilog Antenna	Schwarzbeck	VULB 9168	VULB9168-438	2016.09.30	2Year
Horn Antenna	EMCO	3115	640201028-06	2016.09.30	2Year
Active Loop Antenna	Beijing Daze	ZN30900A	SEL0097	2016.09.30	2Year
Cable	Resenberger	N/A	No.1	2016.09.29	1Year
Cable	SCHWARZBE CK	N/A	No.2	2016.09.29	1Year
Cable	SCHWARZBE CK	N/A	No.3	2016.09.29	1Year
Pre-amplifier	Schwarzbeck	BBV9743	9743-019	2016.09.29	1Year
Pre-amplifier	R&S	AFS33-1800265 0-30-8P-44	SEL0080	2016.09.29	1Year
Base station	Agilent	E5515C	GB44300243	2016.09.29	1 Year
Temperature controller	Terchy	MHQ	120	2016.09.29	1Year
Power divider	Anritsu	K240C	020346	2016.09.29	1 Year
Signal Generator	HP	83732B	VS3449051	2016.09.29	1 Year
Power Meter	Anritsu	ML2487A	6K00001491	2016.09.29	1Year
Power sensor	Anritsu	ML2491A	32516	2016.09.29	1Year
L.I.S.N.#1	Schwarzbeck	NSLK8126	8126466	2016.09.29	1Year
L.I.S.N.#2	ROHDE&SCH WARZ	ENV216	101043	2016.09.29	1 Year

3 Test Procedure

POWER LINE CONDUCTED INTERFERENCE: The test procedure used was ANSI Standard ANSI C63.4:2014 using a 50 u H LISN. Both Lines were observed. The bandwidth of the receiver was 10kHz with an appropriate sweep speed. The ambient temperature of the EUT was 25°C with a humidity of 58%.

RADIATION INTERFERENCE: The test procedure used was ANSI Standard ANSI C63.4:2014 using a ANRITSU spectrum analyzer with a pre-selector. The analyzer was calibrated in dB above a micro volt at the output of the antenna. The resolution bandwidth was 100kHz and the video bandwidth was 300 kHz up to 1 GHz and 1 MHz with a video BW of 3MHz above 1 GHz. The ambient temperature of the EUT was 25°C with a humidity of 58%.

FORMULA OF CONVERSION FACTORS: The Field Strength at 3m was established by adding the meter reading of the spectrum analyzer (which is set to read in units of dBuV) to the antenna correction factor supplied by the antenna manufacturer and cable loss. The antenna correction factors and cable loss are stated in terms of dB. The gain of the Pre-selector was accounted for in the Spectrum Analyzer Meter Reading.

Example:

Freq (MHz) METER READING + ACF + CABLE = FS

33.20 dBuV + 10.36 dB + 0.9 dB= 44.46 dBuV/m @ 3m

ANSI STANDARD ANSI C63.4:2014 10.1.7 MEASUREMENT PROCEDURES: The EUT was placed on a table 80 cm high and with dimensions of 1m by 1.5m. The EUT was placed in the center of the table (1.5m side). The table used for radiated measurements is capable of continuous rotation. When an emission was found, the table was rotated to produce the maximum signal strength. At this point, the antenna was raised and lowered from 1m to 4m. The antenna was placed in both the horizontal and vertical planes. The situation was similar for the conducted measurement except that the table did not rotate. The EUT was setup as described in ANSI Standard ANSI C63.4:2014 10.1.7 with the EUT 40 cm from the vertical ground wall.

4 Summary of Measurement

4.1 Summary of test result

Note: The EUT has been tested as an independent unit. And Continual Transmitting in

Test Item	Test Requirement	Standards Paragraph	Result
Spurious Emission	FCC PART 15 : 2014 & IC RSS-247	Section 15.247&15.209 & RSS-247 Section 5.5	Compliance
Conduction Emission	FCC PART 15 : 2015 & IC RSS Gen	Section 15.207&7.2.4	Compliance
Bandwidth Test	FCC PART 15 : 2015 & IC RSS-247	Section 15.247& RSS-247 5.1(2)	Compliance
Peak Power	FCC PART 15 : 2015 & IC RSS-247	Section 15.247 & RSS-247 5.4(2)	Compliance
Power Density	FCC PART 15 : 2015 & IC RSS-247	Section 15.247 & Section 5.2(2)	Compliance
Band Edge	FCC PART 15 : 2015 & IC RSS-247	Section 15.247 & Section 5.5	Compliance
Antenna Requirement	FCC PART 15 : 2015 & IC RSS Gen	Section 15.203&7.1.4	Compliance

maximum power (The adapter be used during Test)

4.2 Test connection



4.3 Assistant equipment used for test

Description	:	N/A
Manufacturer	:	N/A
Model No.	:	N/A

4.4 Test mode

Duty cycle :100%			
Keeping TX			
Mode	data rate (Mbps)(see Note)	Channel	Frequency (MHz)
IEEE 802.11b	1	Low :CH1	2412
	1	Middle: CH6	2437
	1	High: CH11	2462
IEEE 802.11g	6	Low :CH1	2412
	6	Middle: CH6	2437
	6	High: CH11	2462
IEEE 802.11 n/HT20 with 2.4G	6.5	Low :CH1	2412
	6.5	Middle: CH6	2437
	6.5	High: CH11	2462
IEEE 802.11 n/HT40 with 2.4G	13.5	Low :CH3	2422
	13.5	Middle:CH6	2437
	13.5	High:CH9	2452
Note: According exploratory test, EUT will have maximum output power in those data rate. so those data rate were used for all test.			

4.5 Channel list

For IEEE 802.11b/g and IEEE 802.11n/HT20 with 2.4G					
Channel	Frequency (MHz)	Channel	Frequency (MHz)	Channel	Frequency (MHz)
CH1	2412	CH5	2432	CH9	2452
CH2	2417	CH6	2437	CH10	2457
CH3	2422	CH7	2442	CH11	2462
CH4	2427	CH8	2447		

For IEEE 802.11n/HT40 with 2.4G					
Channel	Frequency (MHz)	Channel	Frequency (MHz)	Channel	Frequency (MHz)
CH1	/	CH5	2432	CH9	2452
CH2	/	CH6	2437	/	/
CH3	2422	CH7	2442	/	/
CH4	2427	CH8	2447	/	/

4.6 Test Conditions

Temperature range	21-25°C
Humidity range	40-75%
Pressure range	86-106kPa

4.7 Measurement Uncertainty (95% confidence levels, k=2)

Item	MU	Remark
Uncertainty for Power point Conducted Emissions Test	2.42dB	
Uncertainty for Radiation Emission test in 3m chamber (below 30MHz)	2.13 dB	Polarize: V
	2.57dB	Polarize: H
Uncertainty for Radiation Emission test in 3m chamber (30MHz to 1GHz)	3.54dB	Polarize: V
	4.1dB	Polarize: H
Uncertainty for Radiation Emission test in 3m chamber (1GHz to 25GHz)	2.08dB	Polarize: H
	2.56dB	Polarize: V
Uncertainty for radio frequency	1×10^{-9}	
Uncertainty for conducted RF Power	0.65dB	
Uncertainty for temperature	0.2°C	
Uncertainty for humidity	1%	
Uncertainty for DC and low frequency voltages	0.06%	

5 Spurious Emission

5.1 Radiation Emission

5.1.1 Radiation Emission Limits(15.209)

Frequencies (MHz)	Field Strength (micorvolts/meter)	Measurement Distance (meters)
0.009~0.490	2400/F(KHz)	300
0.490~1.705	24000/F(KHz)	30
1.705~30.0	30	30
30~88	100	3
88~216	150	3
216~960	200	3
Above 960	500	3

Harmonic emissions limits comply with below 54 dBuV/m at 3m. Other emissions radiated outside of the specified frequency bands, except for harmonics, shall be attenuated by at least 50 dB below the level of the fundamental or comply with the radiated emissions limits specified in section 15.209(a) limit in the table below has to be followed.

NOTE:

- a) The tighter limit applies at the band edges.
- b) Emission Level(dB uV/m)=20log Emission Level(Uv/m)

5.1.2 Test Setup

See the next page

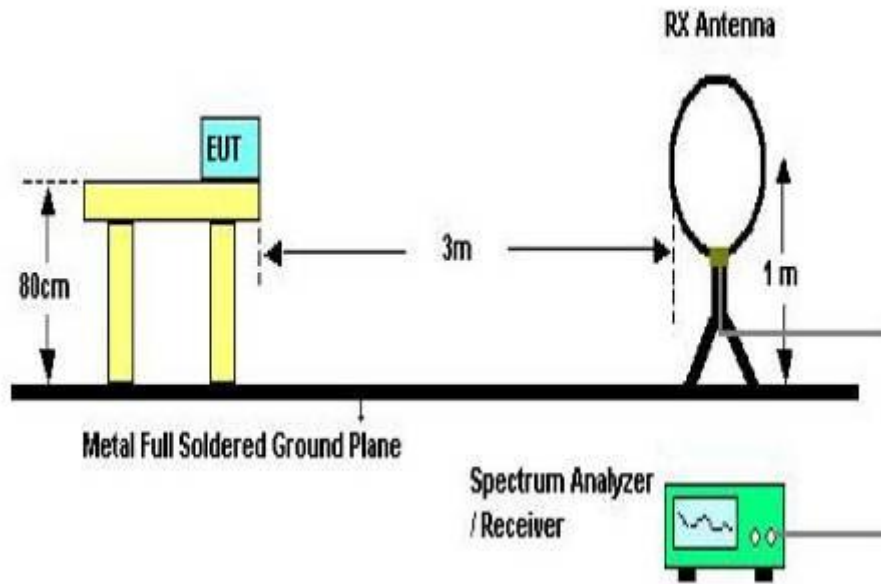

Below 30MHz Test Setup

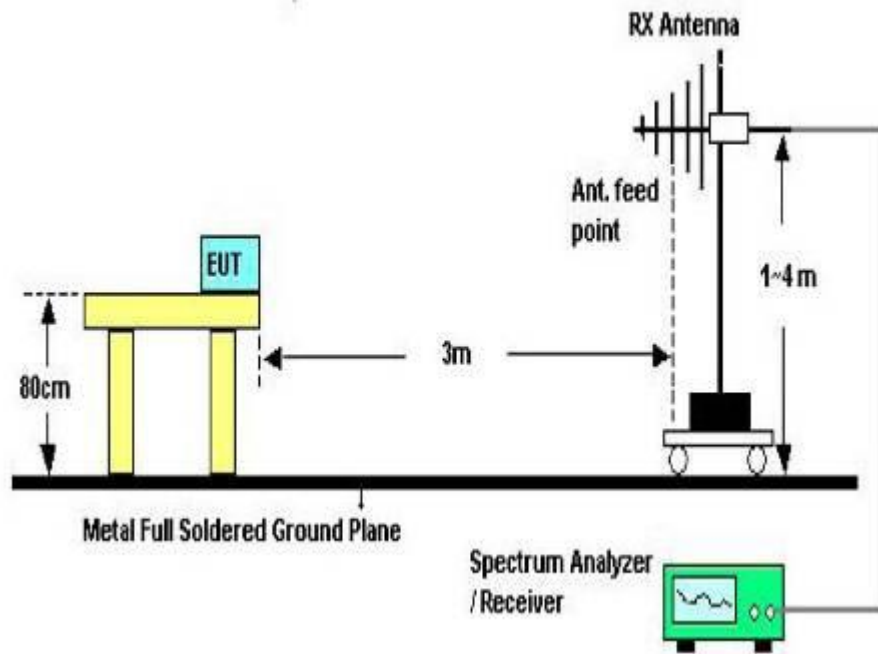

Above 30MHz Test Setup

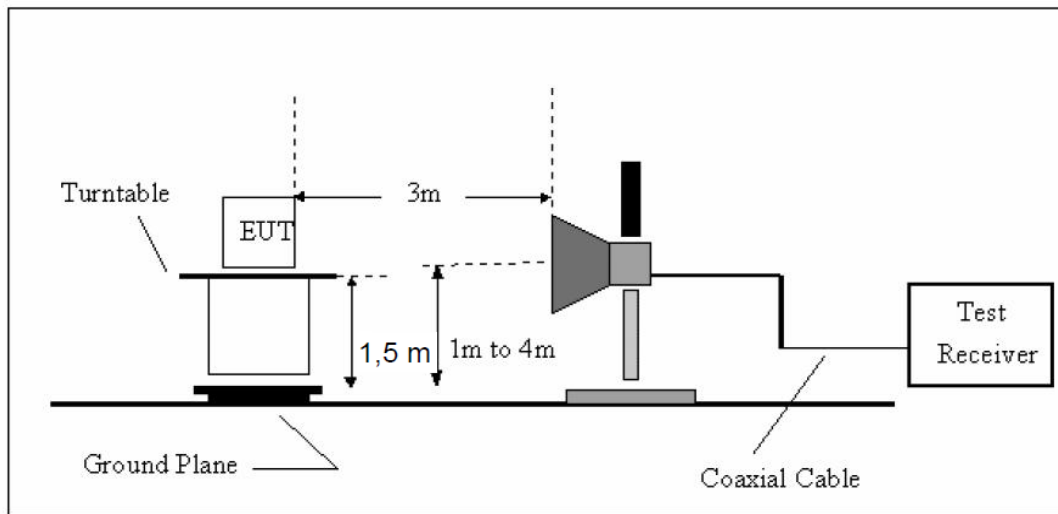

Above 1GHz Test Setup

5.1.3 Test Procedure

- a) The measuring distance of 3m shall be used for measurements at frequency up to 1GHz and above 1GHz, The EUT was placed on a rotating 0.8 m high above ground, The table was rotated 360 degrees to determine the position of the highest radiation
- b) The Test antenna shall vary between 1m and 4m, Both Horizontal and Vertical antenna are set of make measurement.
- c) The initial step in collecting conducted emission data is a spectrum analyzer Peak detector mode pre-scanning the measurement frequency range. Significant Peaks are then marked. and then Qusia Peak Detector mode premeasured
- d) If Peak value comply with QP limit Below 1GHz. The EUT deemed to comply with QP limit. But the Peak value and average value both need to comply with applicable limit above 1GHz.
- e) For the actual test configuration, please see the test setup photo.

5.1.4 Test Equipment Setting For emission test Result

9KHz~150KHz	RBW 200Hz	VBW1KHz
150KHz~30MHz	RBW 9KHz	VBW 30KHz
30MHz~1GHz	RBW 120KHz	VBW 300KHz
Above 1GHz	RBW 1MHz	VBW 3MHz

5.1.5 Test Condition

Continual Transmitting in maximum power.

5.1.6 Test Result

We have scanned the 9KHz from 25GHz to the EUT.
Detailed information please see the following page.

From 9KHz to 30MHz: Conclusion: PASS

Note: The amplitude of spurious emissions which are attenuated by more than 20dB below the permissible value has no need to be reported.

Site LAB
 Limit: FCC Class B Radiation
 EUT: SMART PET FEEDER
 M/N: LY-97
 Mode:WIFI
 Note:
 Engineer Signature:

Polarization: **Vertical**
 Power: AC 120V/60Hz
 Distance: 3m

Temperature: 23.9
 Humidity: 46 %

Radiated Emission Measurement

File :LY-97 Data :#2 Date: 2017/6/30 Time: 16:46:50

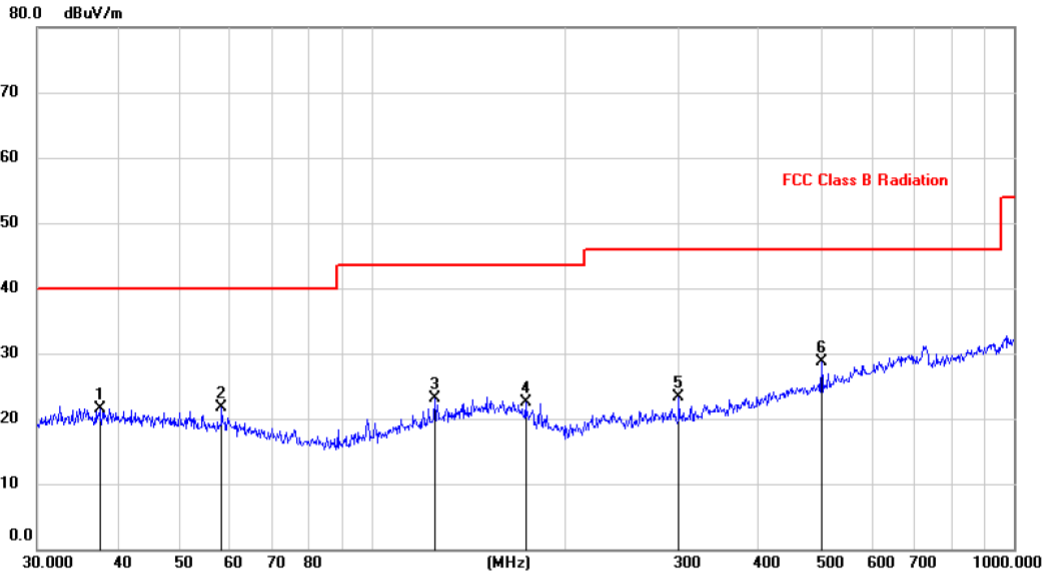

No.	Mk.	Freq.	Reading Level	Correct Factor	Measurement	Limit	Margin	Antenna Height	Table Degree	
		MHz	dBuV	dB	dBuV/m	dBuV/m	dB	cm	degree	Comment
1		37.6798	7.64	13.82	21.46	40.00	-18.54	peak		
2		58.2030	8.64	13.13	21.77	40.00	-18.23	peak		
3		125.0066	10.22	12.92	23.14	43.50	-20.36	peak		
4		173.2051	9.18	13.25	22.43	43.50	-21.07	peak		
5		301.4224	9.83	13.51	23.34	46.00	-22.66	peak		
6	*	501.1790	11.57	17.22	28.79	46.00	-17.21	peak		

Note: 1. *:Maximum data; x:Over limit; !:over margin.
 2.Measurement=Reading Level+Correct Factor; Correct Factor=Antenna Factor+Cable Loss.

Site LAB
 Limit: FCC Class B Radiation
 EUT: SMART PET FEEDER
 M/N: LY-97
 Mode:WIFI
 Note:
 Engineer Signature:

Polarization: **Horizontal**
 Power: AC 120V/60Hz
 Distance: 3m

Temperature: 23.9
 Humidity: 46 %

Radiated Emission Measurement

File :LY-97 Data :#1 Date: 2017/6/30 Time: 16:45:33

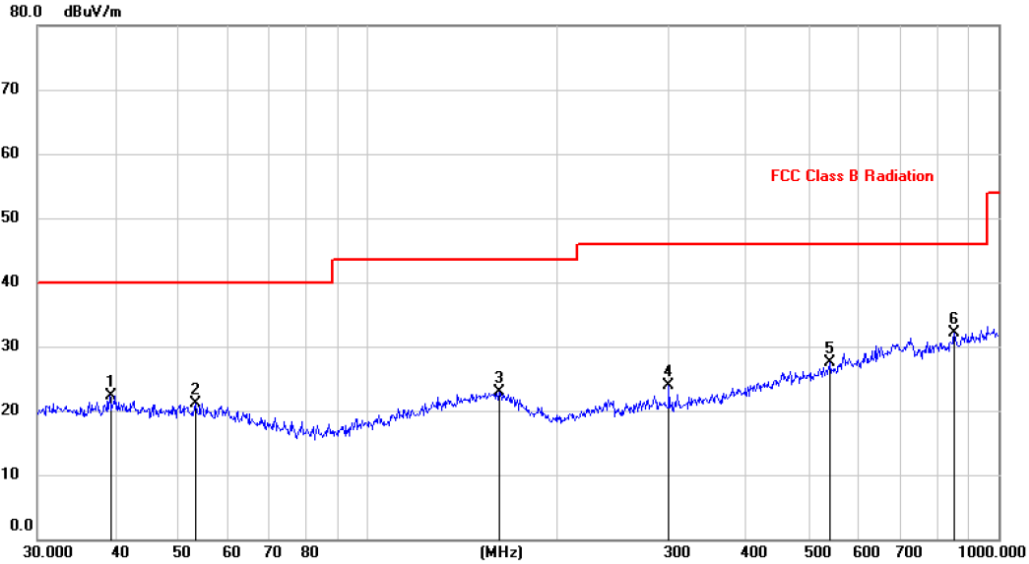

No.	Mk.	Freq.	Reading Level	Correct Factor	Measurement	Limit	Margin	Antenna Height	Table Degree	
		MHz	dBuV	dB	dBuV/m	dBuV/m	dB	cm	degree	Comment
1		39.1616	8.09	14.21	22.30	40.00	-17.70			peak
2		53.5052	7.76	13.43	21.19	40.00	-18.81			peak
3		162.6106	8.56	14.37	22.93	43.50	-20.57			peak
4		301.4224	10.36	13.51	23.87	46.00	-22.13			peak
5		541.3725	9.31	18.21	27.52	46.00	-18.48			peak
6	*	851.0353	9.44	22.65	32.09	46.00	-13.91			peak

Note:1. *:Maximum data; x:Over limit; !:over margin.

2.Measurement=Reading Level+Correct Factor; Correct Factor=Antenna Factor+Cable Loss.

Remark: All modes and channels have been tested and only worst data of 802.11b, 2412MHz is listed in this report.

From 1G-25GHz

IEEE 802.11b

EUT	SMART PET FEEDER	Model Name	LY-97
Temperature	26°C	Relative Humidity	56%
Pressure	960hPa	Test voltage	DC 5V from adapter
Test Mode	TX Low		

Freq. (MHz)	Ant. Pol H/V	Peak Reading (dBuV)	AV Reading (dBuV)	Ant. / CL CF (dB)	Actual Fs		Peak Limit (dBuV/m)	AV Limit (dBuV/m)	Margin (dB)	Remarks
					Peak (dBuV/m)	AV (dBuV/m)				
1124	V	44.84	---	-11.24	33.60	---	74	54	40.40	Peak
4824	V	38.30	---	0.64	38.94	---	74	54	35.06	Peak
N/A										

EUT	SMART PET FEEDER	Model Name	LY-97
Temperature	26°C	Relative Humidity	56%
Pressure	960hPa	Test voltage	DC 5V from adapter
Test Mode	TX Low		

Freq. (MHz)	Ant. Pol H/V	Peak Reading (dBuV)	AV Reading (dBuV)	Ant. / CL CF (dB)	Actual Fs		Peak Limit (dBuV/m)	AV Limit (dBuV/m)	Margin (dB)	Remarks
					Peak (dBuV/m)	AV (dBuV/m)				
1124	H	43.49	---	-11.24	32.25	---	74	54	41.75	Peak
4824	H	36.68	---	0.64	37.32	---	74	54	36.68	Peak
N/A										

Notes: AV Means AV detector test data, Peak Means Peak detector test data.

Emissions attenuated more than 20 dB below the permissible value are not reported.

EUT	SMART PET FEEDER	Model Name	LY-97
Temperature	26°C	Relative Humidity	56%
Pressure	960hPa	Test voltage	DC 5V from adapter
Test Mode	TX Mid		

Freq. (MHz)	Ant. Pol H/V	Peak Reading (dBuV)	AV Reading (dBuV)	Ant. / CL CF (dB)	Actual Fs		Peak Limit (dBuV/m)	AV Limit (dBuV/m)	Margin (dB)	Remark
					Peak (dBuV/m)	AV (dBuV/m)				
1124	V	43.09	---	-11.24	31.85	---	74	54	42.15	Peak
4874	V	37.10	---	0.76	37.86	---	74	54	36.14	Peak

EUT	SMART PET FEEDER	Model Name	LY-97
Temperature	26°C	Relative Humidity	56%
Pressure	960hPa	Test voltage	DC 5V from adapter
Test Mode	TX Mid		

Freq. (MHz)	Ant. Pol H/V	Peak Reading (dBuV)	AV Reading (dBuV)	Ant. / CL CF (dB)	Actual Fs		Peak Limit (dBuV/m)	AV Limit (dBuV/m)	Margin (dB)	Remark
					Peak (dBuV/m)	AV (dBuV/m)				
1103	H	44.61	---	-11.24	33.37	---	74	54	40.63	Peak
4874	H	37.60	---	0.76	38.36	---	74	54	35.64	Peak

Notes: AV Means AV detector test data, Peak Means Peak detector test data.

Emissions attenuated more than 20 dB below the permissible value are not reported.

EUT	SMART PET FEEDER	Model Name	LY-97
Temperature	26°C	Relative Humidity	56%
Pressure	960hPa	Test voltage	DC 5V from adapter
Test Mode	TX High		

Freq. (MHz)	Ant. Pol H/V	Peak Reading (dBuV)	AV Reading (dBuV)	Ant. / CL CF (dB)	Actual Fs		Peak Limit (dBuV/m)	AV Limit (dBuV/m)	Margin (dB)	Remark
					Peak (dBuV/m)	AV (dBuV/m)				
1103	V	43.02	---	-11.24	31.78	---	74	54	42.22	Peak
4924	V	36.18	---	0.87	37.05	---	74	54	36.95	Peak

EUT	SMART PET FEEDER	Model Name	LY-97
Temperature	26°C	Relative Humidity	56%
Pressure	960hPa	Test voltage	DC 5V from adapter
Test Mode	TX High		

Freq. (MHz)	Ant. Pol H/V	Peak Reading (dBuV)	AV Reading (dBuV)	Ant. / CL CF (dB)	Actual Fs		Peak Limit (dBuV/m)	AV Limit (dBuV/m)	Margin (dB)	Remark
					Peak (dBuV/m)	AV (dBuV/m)				
1103	H	43.56	---	-11.24	32.32	---	74	54	41.68	Peak
4924	H	35.83	---	0.87	36.70	---	74	54	37.30	Peak

Notes: AV Means AV detector test data, Peak Means Peak detector test data.

Emissions attenuated more than 20 dB below the permissible value are not reported.

IEEE 802.11 g:

EUT	SMART PET FEEDER	Model Name	LY-97
Temperature	26°C	Relative Humidity	56%
Pressure	960hPa	Test voltage	DC 5V from adapter
Test Mode	TX Low		

Freq. (MHz)	Ant. Pol H/V	Peak Reading (dBuV)	AV Reading (dBuV)	Ant. / CL CF (dB)	Actual Fs		Peak Limit (dBuV/m)	AV Limit (dBuV/m)	Margin (dB)	Remark
					Peak (dBuV/m)	AV (dBuV/m)				
1129	V	43.59	---	-11.24	32.35	---	74	54	41.65	Peak
2573	V	45.11	---	-7.13	37.98	---	74	54	36.02	Peak
3128	V	44.87	---	-5.74	39.13	---	74	54	34.87	Peak
4824	V	40.68	---	0.64	41.32	---	74	54	32.68	Peak
N/A										

EUT	SMART PET FEEDER	Model Name	LY-97
Temperature	26°C	Relative Humidity	56%
Pressure	960hPa	Test voltage	DC 5V from adapter
Test Mode	TX Low		

Freq. (MHz)	Ant. Pol H/V	Peak Reading (dBuV)	AV Reading (dBuV)	Ant. / CL CF (dB)	Actual Fs		Peak Limit (dBuV/m)	AV Limit (dBuV/m)	Margin (dB)	Remark
					Peak (dBuV/m)	AV (dBuV/m)				
1263	H	43.12	---	-10.96	32.16	---	74	54	41.84	Peak
2059	H	43.47	---	-8.58	34.89	---	74	54	39.11	Peak
3391	H	42.64	---	-4.95	37.69	---	74	54	36.31	Peak
4824	H	41.25	---	0.64	41.89	---	74	54	32.11	Peak
N/A										

Notes: AV Means AV detector test data, Peak Means Peak detector test data.

Emissions attenuated more than 20 dB below the permissible value are not reported.

EUT	SMART PET FEEDER	Model Name	LY-97
Temperature	26°C	Relative Humidity	56%
Pressure	960hPa	Test voltage	DC 5V from adapter
Test Mode	TX Mid		

Freq. (MHz)	Ant. Pol H/V	Peak Reading (dBuV)	AV Reading (dBuV)	Ant. / CL CF (dB)	Actual Fs		Peak Limit (dBuV/m)	AV Limit (dBuV/m)	Margin (dB)	Remark
					Peak (dBuV/m)	AV (dBuV/m)				
1376	V	44.13	---	-10.43	33.70	---	74	54	40.30	Peak
2564	V	43.63	---	-7.13	36.50	---	74	54	37.50	Peak
3342	V	43.67	---	-5.18	38.49	---	74	54	35.51	Peak
4874	V	40.71	---	0.76	41.47	---	74	54	32.53	Peak

EUT	SMART PET FEEDER	Model Name	LY-97
Temperature	26°C	Relative Humidity	56%
Pressure	960hPa	Test voltage	DC 5V from adapter
Test Mode	TX Mid		

Freq. (MHz)	Ant. Pol H/V	Peak Reading (dBuV)	AV Reading (dBuV)	Ant. / CL CF (dB)	Actual Fs		Peak Limit (dBuV/m)	AV Limit (dBuV/m)	Margin (dB)	Remark
					Peak (dBuV/m)	AV (dBuV/m)				
1317	H	42.79	---	-10.84	31.95	---	74	54	42.05	Peak
2362	H	43.89	---	-7.46	36.43	---	74	54	37.57	Peak
3551	H	42.41	---	-4.76	37.65	---	74	54	36.35	Peak
4874	H	40.48	---	0.76	41.24	---	74	54	32.76	Peak

Notes: AV Means AV detector test data, Peak Means Peak detector test data.

Emissions attenuated more than 20 dB below the permissible value are not reported.

EUT	SMART PET FEEDER	Model Name	LY-97
Temperature	26°C	Relative Humidity	56%
Pressure	960hPa	Test voltage	DC 5V from adapter
Test Mode	TX High		

Freq. (MHz)	Ant. Pol H/V	Peak Reading (dBuV)	AV Reading (dBuV)	Ant. / CL CF (dB)	Actual Fs		Peak Limit (dBuV/m)	AV Limit (dBuV/m)	Margin (dB)	Remark
					Peak (dBuV/m)	AV (dBuV/m)				
1325	V	44.16	---	-10.84	33.32	---	74	54	40.68	Peak
2902	V	43.81	---	-5.86	37.95	---	74	54	36.05	Peak
3846	V	43.51	---	-3.96	39.55	---	74	54	34.45	Peak
4924	V	39.85	---	0.87	40.72	---	74	54	33.28	Peak

EUT	SMART PET FEEDER	Model Name	LY-97
Temperature	26°C	Relative Humidity	56%
Pressure	960hPa	Test voltage	DC 5V from adapter
Test Mode	TX High		

Freq. (MHz)	Ant. Pol H/V	Peak Reading (dBuV)	AV Reading (dBuV)	Ant. / CL CF (dB)	Actual Fs		Peak Limit (dBuV/m)	AV Limit (dBuV/m)	Margin (dB)	Remark
					Peak (dBuV/m)	AV (dBuV/m)				
1439	H	44.68	---	-10.29	34.39	---	74	54	39.61	Peak
2143	H	44.96	---	-8.24	36.72	---	74	54	37.28	Peak
3712	H	43.65	---	-3.68	39.97	---	74	54	34.03	Peak
4924	H	41.04	---	0.87	41.91	---	74	54	32.09	Peak

Notes: AV Means AV detector test data, Peak Means Peak detector test data.

Emissions attenuated more than 20 dB below the permissible value are not reported.

IEEE 802.11n/HT20 with 2.4G

EUT		SMART PET FEEDER			Model Name		LY-97			
Temperature		26°C			Relative Humidity		56%			
Pressure		960hPa			Test voltage		DC 5V from adapter			
Test Mode		TX Low								
Freq. (MHz)	Ant. Pol H/V	Peak Reading (dBuV)	AV Reading (dBuV)	Ant. / CL CF (dB)	Actual Fs		Peak Limit (dBuV/m)	AV Limit (dBuV/m)	Margin (dB)	Remark
					Peak (dBuV/m)	AV (dBuV/m)				
1347	V	44.54	---	-10.27	34.27	---	74	54	39.73	Peak
2651	V	44.72	---	-6.94	37.78	---	74	54	36.22	Peak
3916	V	44.14	---	-3.68	40.46	---	74	54	33.54	Peak
4824	V	39.96	---	0.64	40.60	---	74	54	33.40	Peak
N/A										

EUT		SMART PET FEEDER			Model Name		LY-97			
Temperature		26°C			Relative Humidity		56%			
Pressure		960hPa			Test voltage		DC 5V from adapter			
Test Mode		TX Low								

Freq. (MHz)	Ant. Pol H/V	Peak Reading (dBuV)	AV Reading (dBuV)	Ant. / CL CF (dB)	Actual Fs		Peak Limit (dBuV/m)	AV Limit (dBuV/m)	Margin (dB)	Remark
					Peak (dBuV/m)	AV (dBuV/m)				
1451	H	43.35	---	-10.27	33.08	---	74	54	40.92	Peak
2864	H	44.66	---	-6.17	38.49	---	74	54	35.51	Peak
3659	H	41.75	---	-4.52	37.23	---	74	54	36.77	Peak
4824	H	40.15	---	0.64	40.79	---	74	54	33.21	Peak
N/A										

Notes: AV Means AV detector test data, Peak Means Peak detector test data.

Emissions attenuated more than 20 dB below the permissible value are not reported.

EUT	SMART PET FEEDER	Model Name	LY-97
Temperature	26°C	Relative Humidity	56%
Pressure	960hPa	Test voltage	DC 5V from adapter
Test Mode	TX Mid		

Freq. (MHz)	Ant. Pol H/V	Peak Reading (dBuV)	AV Reading (dBuV)	Ant. / CL CF (dB)	Actual Fs		Peak Limit (dBuV/m)	AV Limit (dBuV/m)	Margin (dB)	Remark
					Peak (dBuV/m)	AV (dBuV/m)				
1351	V	43.72	---	-10.96	32.76	---	74	54	41.24	Peak
2154	V	43.73	---	-8.58	35.15	---	74	54	38.85	Peak
3407	V	42.42	---	-4.07	38.35	---	74	54	35.65	Peak
4874	V	40.01	---	0.76	40.77	---	74	54	33.23	Peak

EUT	SMART PET FEEDER	Model Name	LY-97
Temperature	26°C	Relative Humidity	56%
Pressure	960hPa	Test voltage	DC 5V from adapter
Test Mode	TX Mid		

Freq. (MHz)	Ant. Pol H/V	Peak Reading (dBuV)	AV Reading (dBuV)	Ant. / CL CF (dB)	Actual Fs		Peak Limit (dBuV/m)	AV Limit (dBuV/m)	Margin (dB)	Remark
					Peak (dBuV/m)	AV (dBuV/m)				
1206	H	43.11	---	-10.14	32.97	---	74	54	41.03	Peak
2454	H	44.40	---	-7.59	36.81	---	74	54	37.19	Peak
3202	H	43.34	---	-5.39	37.95	---	74	54	36.05	Peak
4874	H	40.52	---	0.76	41.28	---	74	54	32.72	Peak

Notes: AV Means AV detector test data, Peak Means Peak detector test data.

Emissions attenuated more than 20 dB below the permissible value are not reported.

EUT	SMART PET FEEDER	Model Name	LY-97
Temperature	26°C	Relative Humidity	56%
Pressure	960hPa	Test voltage	DC 5V from adapter
Test Mode	TX High		

Freq. (MHz)	Ant. Pol H/V	Peak Reading (dBuV)	AV Reading (dBuV)	Ant. / CL CF (dB)	Actual Fs		Peak Limit (dBuV/m)	AV Limit (dBuV/m)	Margin (dB)	Remark
					Peak (dBuV/m)	AV (dBuV/m)				
1374	V	43.94	---	-10.27	33.67	---	74	54	40.33	Peak
2036	V	44.10	---	-6.43	37.67	---	74	54	36.33	Peak
3651	V	44.04	---	-4.76	39.28	---	74	54	34.72	Peak
4924	V	40.92	---	0.87	41.79	---	74	54	32.21	Peak

EUT	SMART PET FEEDER	Model Name	LY-97
Temperature	26°C	Relative Humidity	56%
Pressure	960hPa	Test voltage	DC 5V from adapter
Test Mode	TX High		

Freq. (MHz)	Ant. Pol H/V	Peak Reading (dBuV)	AV Reading (dBuV)	Ant. / CL CF (dB)	Actual Fs		Peak Limit (dBuV/m)	AV Limit (dBuV/m)	Margin (dB)	Remark
					Peak (dBuV/m)	AV (dBuV/m)				
1315	H	41.52	---	-10.14	31.38	---	74	54	42.62	Peak
3483	H	43.26	---	-4.96	38.30	---	74	54	35.70	Peak
4117	H	41.97	---	-2.48	39.49	---	74	54	34.51	Peak
4924	H	39.56	---	0.87	40.43	---	74	54	33.57	Peak

Notes: AV Means AV detector test data, Peak Means Peak detector test data.

Emissions attenuated more than 20 dB below the permissible value are not reported.

IEEE 802.11n/HT40 with 2.4G

EUT		SMART PET FEEDER			Model Name		LY-97			
Temperature		26°C			Relative Humidity		56%			
Pressure		960hPa			Test voltage		DC 5V from adapter			
Test Mode		TX Low								
Freq. (MHz)	Ant. Pol H/V	Peak Reading (dBuV)	AV Reading (dBuV)	Ant. / CL CF (dB)	Actual Fs		Peak Limit (dBuV/m)	AV Limit (dBuV/m)	Margin (dB)	Remark
					Peak (dBuV/m)	AV (dBuV/m)				
1245	V	43.30	---	-10.07	33.23	---	74	54	40.77	Peak
2456	V	44.43	---	-6.94	37.49	---	74	54	36.51	Peak
3402	V	42.42	---	-4.95	37.47	---	74	54	36.53	Peak
4844	V	40.11	---	0.64	40.75	---	74	54	33.25	Peak
N/A										

EUT		SMART PET FEEDER			Model Name		LY-97			
Temperature		26°C			Relative Humidity		56%			
Pressure		960hPa			Test voltage		DC 5V from adapter			
Test Mode		TX Low								

Freq. (MHz)	Ant. Pol H/V	Peak Reading (dBuV)	AV Reading (dBuV)	Ant. / CL CF (dB)	Actual Fs		Peak Limit (dBuV/m)	AV Limit (dBuV/m)	Margin (dB)	Remark
					Peak (dBuV/m)	AV (dBuV/m)				
1442	H	43.33	---	-10.14	33.19	---	74	54	40.81	Peak
2347	H	43.87	---	-7.59	36.28	---	74	54	37.72	Peak
3075	H	43.11	---	-5.74	37.37	---	74	54	36.63	Peak
4844	H	40.54	---	0.64	41.18	---	74	54	32.82	Peak
N/A										

Notes: AV Means AV detector test data, Peak Means Peak detector test data.

Emissions attenuated more than 20 dB below the permissible value are not reported.

EUT	SMART PET FEEDER	Model Name	LY-97
Temperature	26°C	Relative Humidity	56%
Pressure	960hPa	Test voltage	DC 5V from adapter
Test Mode	TX Mid		

Freq. (MHz)	Ant. Pol H/V	Peak Reading (dBuV)	AV Reading (dBuV)	Ant. / CL CF (dB)	Actual Fs		Peak Limit (dBuV/m)	AV Limit (dBuV/m)	Margin (dB)	Remark
					Peak (dBuV/m)	AV (dBuV/m)				
1664	V	43.01	---	-9.84	33.17	---	74	54	40.83	Peak
2483	V	43.30	---	-7.13	36.17	---	74	54	37.83	Peak
3261	V	43.01	---	-5.31	37.70	---	74	54	36.30	Peak
4874	V	40.38	---	0.76	41.14	---	74	54	32.86	Peak

EUT	SMART PET FEEDER	Model Name	LY-97
Temperature	26°C	Relative Humidity	56%
Pressure	960hPa	Test voltage	DC 5V from adapter
Test Mode	TX Mid		

Freq. (MHz)	Ant. Pol H/V	Peak Reading (dBuV)	AV Reading (dBuV)	Ant. / CL CF (dB)	Actual Fs		Peak Limit (dBuV/m)	AV Limit (dBuV/m)	Margin (dB)	Remark
					Peak (dBuV/m)	AV (dBuV/m)				
1558	H	42.90	---	-10.07	32.83	---	74	54	41.17	Peak
2286	H	42.89	---	-8.13	34.76	---	74	54	39.24	Peak
3119	H	41.90	---	-5.52	36.38	---	74	54	37.62	Peak
4874	H	40.07	---	0.76	40.83	---	74	54	33.17	Peak

Notes: AV Means AV detector test data, Peak Means Peak detector test data.

Emissions attenuated more than 20 dB below the permissible value are not reported.

EUT	SMART PET FEEDER	Model Name	LY-97
Temperature	26°C	Relative Humidity	56%
Pressure	960hPa	Test voltage	DC 5V from adapter
Test Mode	TX High		

Freq. (MHz)	Ant. Pol H/V	Peak Reading (dBuV)	AV Reading (dBuV)	Ant. / CL CF (dB)	Actual Fs		Peak Limit (dBuV/m)	AV Limit (dBuV/m)	Margin (dB)	Remark
					Peak (dBuV/m)	AV (dBuV/m)				
1605	V	44.39	---	-9.84	34.55	---	74	54	39.45	Peak
2587	V	44.49	---	-7.13	37.36	---	74	54	36.64	Peak
3763	V	43.64	---	-3.84	39.80	---	74	54	34.20	Peak
4904	V	39.05	---	0.87	39.92	---	74	54	34.08	Peak

EUT	SMART PET FEEDER	Model Name	LY-97
Temperature	26°C	Relative Humidity	56%
Pressure	960hPa	Test voltage	DC 5V from adapter
Test Mode	TX High		

Freq. (MHz)	Ant. Pol H/V	Peak Reading (dBuV)	AV Reading (dBuV)	Ant. / CL CF (dB)	Actual Fs		Peak Limit (dBuV/m)	AV Limit (dBuV/m)	Margin (dB)	Remark
					Peak (dBuV/m)	AV (dBuV/m)				
1743	H	43.83	---	-9.27	34.56	---	74	54	39.44	Peak
2880	H	45.38	---	-6.17	39.21	---	74	54	34.79	Peak
3752	H	43.09	---	-4.24	38.85	---	74	54	35.15	Peak
4904	H	40.13	---	0.87	41.00	---	74	54	33.00	Peak

Notes: AV Means AV detector test data, Peak Means Peak detector test data.

Emissions attenuated more than 20 dB below the permissible value are not reported.

6 POWER LINE CONDUCTED EMISSION

6.1 Conducted Emission Limits(15.207)

Frequency MHz	Limits dB(μ V)	
	Quasi-peak Level	Average Level
0.15 -0.50	66 -56*	56 - 46*
0.50 -5.00	56	46
5.00 -30.00	60	50

Notes: 1. *Decreasing linearly with logarithm of frequency.

2. The lower limit shall apply at the transition frequencies.

3.The limit decreases in line with the logarithm of the frequency in the rang of 0.15 to 0.50 MHz.

6.2 Test Setup

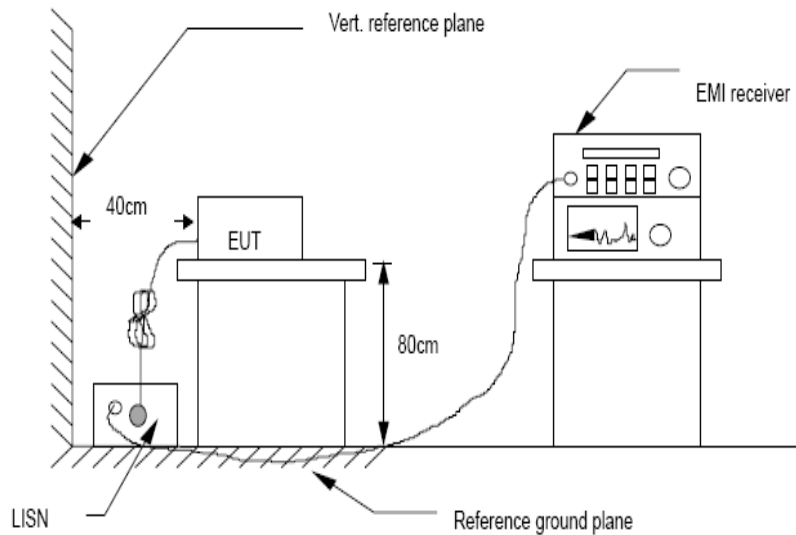

6.3 Test Procedure

The EUT is put on the plane 0.8m high above the ground by insulating support and is connected to the power mains through a line impedance stabilization network (L.I.S.N.). This provides a 50ohm coupling impedance for the EUT system. Please refer the block diagram of the test setup and photographs. Both sides of AC lines are checked to find out the maximum conducted emission. In order to find the maximum emission levels, the relative positions of equipment and all of the interface cables shall be changed according to ANSI C63.4:2014 on Conducted Emission Measurement. The bandwidth of test receiver is set at 9 kHz.

6.4 Test Results

Worse case is reported only

PASS

Detailed information please see the following page.

Site LAB
 Limit: FCC Part 15 CLASS B QP
 EUT: SMART PET FEEDER
 M/N: LY-97
 Mode: WIFI
 Note:
 Engineer Signature:

Phase: **N**
 Power: AC 120V/60Hz

Temperature: 24.2
 Humidity: 53 %

Conducted Emission Measurement

File :LY-97 Data :#4 Date: 2017-6-29 Time: 13:26:12

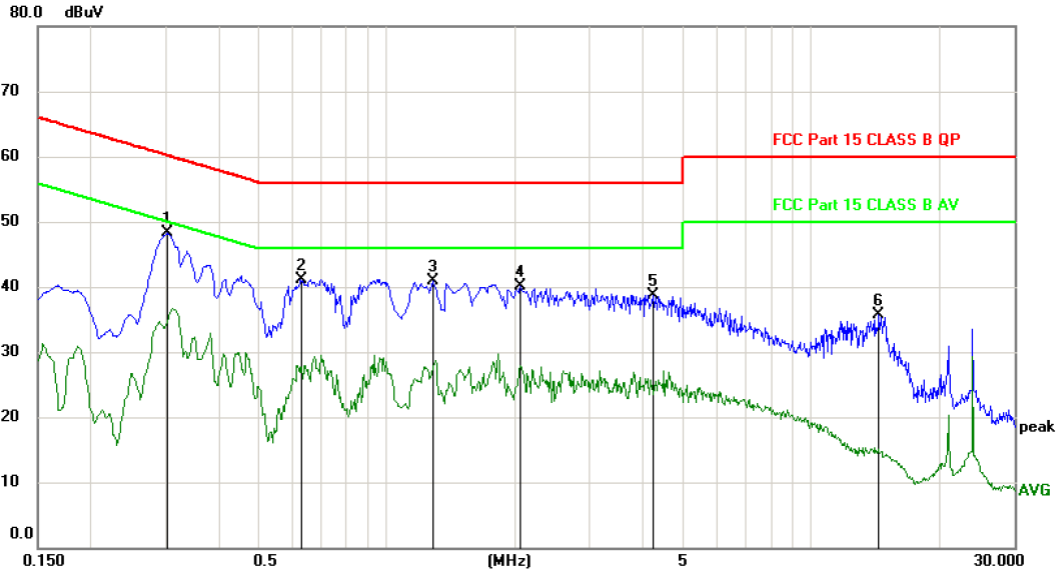

No.	Mk.	Freq. MHz	Reading Level dBuV	Correct Factor dB	Measure- ment dBuV	Limit dBuV	Margin dB	Detector	Comment
1	*	0.3030	38.51	9.76	48.27	60.16	-11.89	peak	
2		0.6270	31.33	9.79	41.12	56.00	-14.88	peak	
3		1.2805	31.11	9.85	40.96	56.00	-15.04	peak	
4		2.0605	30.25	9.92	40.17	56.00	-15.83	peak	
5		4.2404	28.48	10.15	38.63	56.00	-17.37	peak	
6		14.3805	25.30	10.36	35.66	60.00	-24.34	peak	

*:Maximum data x:Over limit !:over margin

Note: Measurement=Reading Level+Correc Factor. Factor=(LISN or ISN or PLC or Current Probe)Factor+Cable

Site LAB
 Limit: FCC Part 15 CLASS B QP
 EUT: SMART PET FEEDER
 M/N: LY-97
 Mode: WIFI
 Note:
 Engineer Signature:

Phase: **L1**
 Power: AC 120V/60Hz

Temperature: 24.2
 Humidity: 53 %

Conducted Emission Measurement

File :LY-97 Data :#3 Date: 2017-6-29 Time: 13:24:12

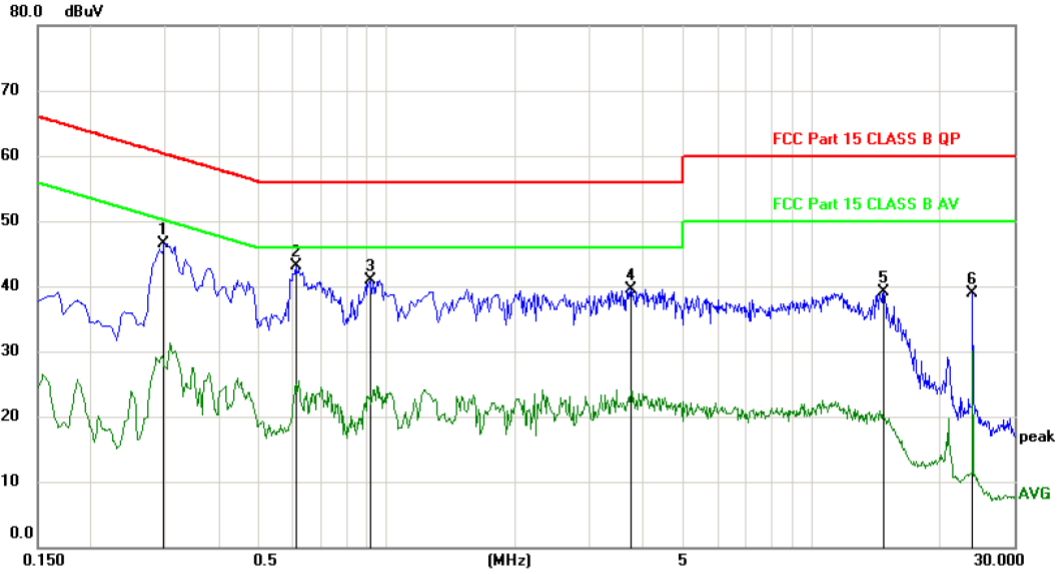

No.	Mk.	Freq. MHz	Reading Level dBuV	Correct Factor dB	Measure- ment dBuV	Limit dBuV	Margin dB	Detector	Comment
1		0.2985	36.69	9.76	46.45	60.28	-13.83	peak	
2	*	0.6090	33.35	9.79	43.14	56.00	-12.86	peak	
3		0.9105	31.07	9.83	40.90	56.00	-15.10	peak	
4		3.7405	29.42	10.10	39.52	56.00	-16.48	peak	
5		14.8005	28.74	10.39	39.13	60.00	-20.87	peak	
6		24.0005	28.10	10.72	38.82	60.00	-21.18	peak	

*:Maximum data x:Over limit !:over margin

Note: Measurement=Reading Level+Correc Factor. Factor=(LISN or ISN or PLC or Current Probe)Factor+Cable

Remark: All modes and channels have been tested and only worst data of 802.11b, 2412MHz is listed in this report.

7 Conducted Maximum Output Power

7.1 Test limit

Please refer section 15.247.

Regulation 15.247(b) The limit of Maximum Peak Output Power Measurement is 1W(30dBm)

7.2 Test Procedure

Details see the KDB558074 Meas Guidance V03

7.2.1 Place the EUT on the table and set it in transmitting mode.

7.2.2 Connected the EUT's antenna port to peak power meter by 20dB attenuator.

7.2.3 Measure out each mode and each bands peak output power of EUT.

Note: The cable loss and attenuator loss were offset into measure device as amplitude offset.

Details see the KDB558074 DTS Meas Guidance V03

7.3 Test Setup

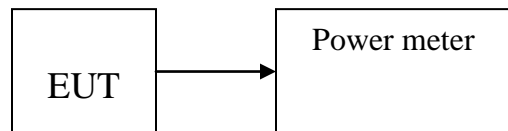

7.4 Test Results

PASS

Detailed information please see the following page.

EUT: SMART PET FEEDER		M/N: LY-97				
Test date: 2017-06-30		Test site: RF site		Tested by: Simple Guan		
Mode	Frequency (MHz)	Ant Port	PK Output power(dBm)		Limit (dBm)	Margin (dB)
IEEE 802.11 b	CH1: 2412	0	7.81	7.81	30	22.19
		1	/			
	CH6: 2437	0	8.15	8.15	30	21.85
		1	/			
	CH11: 2462	0	7.78	7.78	30	22.22
		1	/			
IEEE 802.11 g	CH1: 2412	0	5.66	5.66	30	24.34
		1	/			
	CH6: 2437	0	4.87	4.87	30	25.13
		1	/			
	CH11: 2462	0	4.03	4.03	30	25.97
		1	/			
IEEE 802.11 n/HT20 with 2.4G	CH1: 2412	0	3.72	3.72	30	26.28
		1	/			
	CH6: 2437	0	4.09	4.09	30	25.91
		1	/			
	CH11: 2462	0	4.01	4.01	30	25.99
		1	/			
IEEE 802.11 n/HT40 with 2.4G	CH1: 2422	0	1.63	1.63	30	28.37
		1	/			
	CH4: 2437	0	-0.54	-0.54	30	30.54
		1	/			
	CH7: 2452	0	1.52	1.52	30	28.48
		1	/			
Conclusion: PASS						

8 PEAK POWER SPECTRAL DENSITY

8.1 Test limit

8.1.1 Please refer section 15.247.

8.1.2 For direct sequence systems, the peak power spectral density conducted from the intentional radiator to the antenna shall not be greater than 8dBm in any 3kHz band during any time interval of continuous transmission.

8.1.3 The direct sequence operating of the hybrid system, with the frequency hopping operation turned off, shall comply with the power density requirements of paragraph (d) of this section.

8.2 Method of measurement

Details see the KDB558074 DTS Meas Guidance V03

8.2.1 Place the EUT on the table and set it in transmitting mode.

8.2.2 Remove the antenna from the EUT and then connect a low loss RF cable from the antenna port to the spectrum analyzer.

8.2.3 Set the spectrum analyzer as RBW = 3kHz, VBW = 10kHz, span=5-30%EBW, detail see the test plot.

8.2.4 Record the max reading.

8.2.5 Repeat the above procedure until the measurements for all frequencies are completed.

8.3 Test Setup

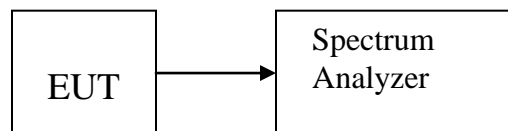

8.4 Test Results

PASS.

Detailed information please see the below.

EUT: SMART PET FEEDER		M/N: LY-97				
Test date: 2017-06-30		Test site: RF site		Tested by: Simple Guan		
Mode	Frequency (MHz)	Ant Port	PK Output power(dBm)		Limit (dBm)	Result
IEEE 802.11 b	CH1: 2412	0	-8.31	-8.31	8	PASS
		1	/			
	CH6: 2437	0	-8.34	-8.34	8	PASS
		1	/			
	CH11: 2462	0	-8.56	-8.56	8	PASS
		1	/			
IEEE 802.11 g	CH1: 2412	0	-14.56	-14.56	8	PASS
		1	/			
	CH6: 2437	0	-10.96	-10.96	8	PASS
		1	/			
	CH11: 2462	0	-12.89	-12.89	8	PASS
		1	/			
IEEE 802.11 n/HT20 with 2.4G	CH1: 2412	0	-13.57	-13.57	8	PASS
		1	/			
	CH6: 2437	0	-12.04	-12.04	8	PASS
		1	/			
	CH11: 2462	0	-13.24	-13.24	8	PASS
		1	/			
IEEE 802.11 n/HT40 with 2.4G	CH1: 2422	0	-13.65	-13.65	8	PASS
		1	/			
	CH4: 2437	0	-16.79	-16.79	8	PASS
		1	/			
	CH7: 2452	0	-15.77	-15.77	8	PASS
		1	/			
Conclusion: PASS						

IEEE 802.11b :
CH Low :

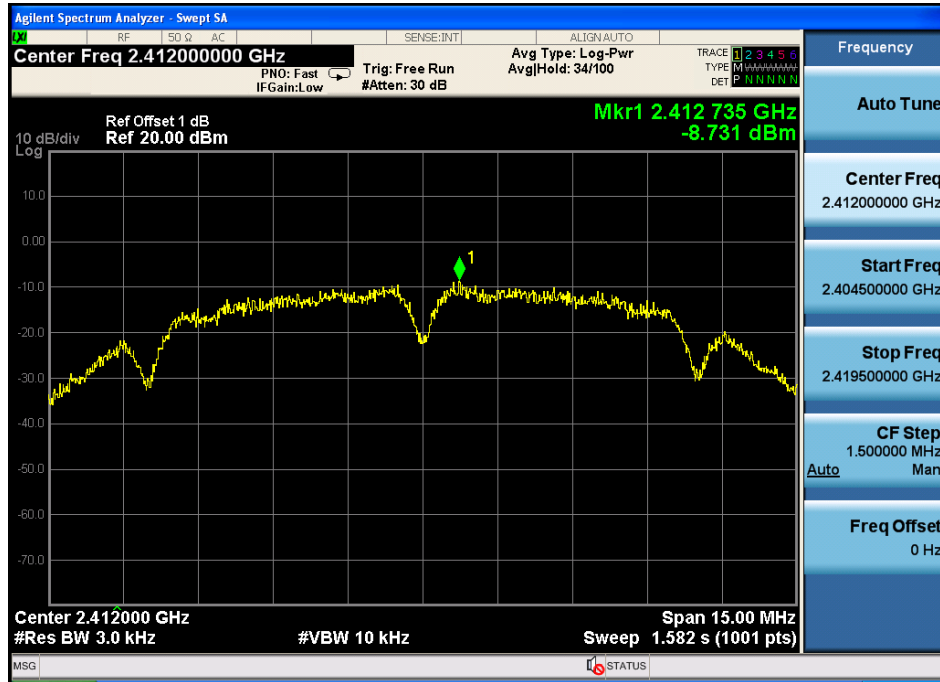

CH Mid:

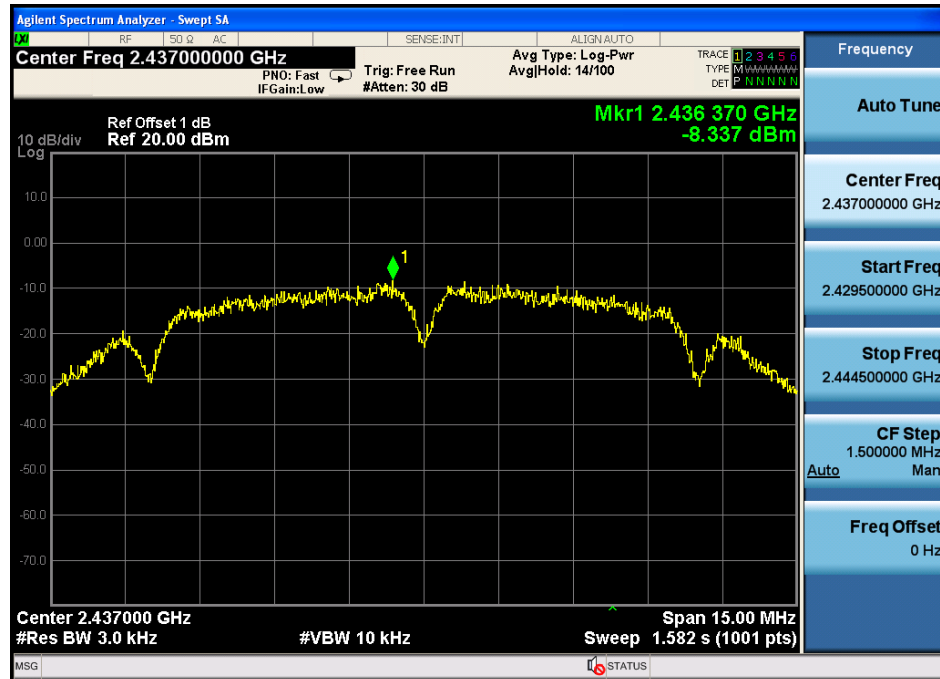

CH Hig:



IEEE 802.11g :
CH Low

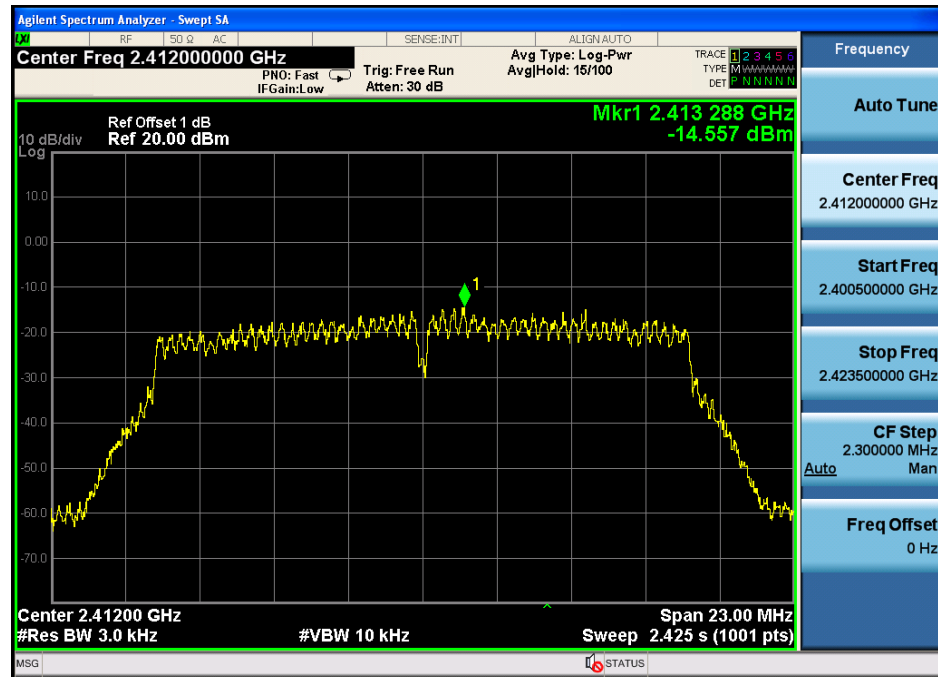

CH Mid:

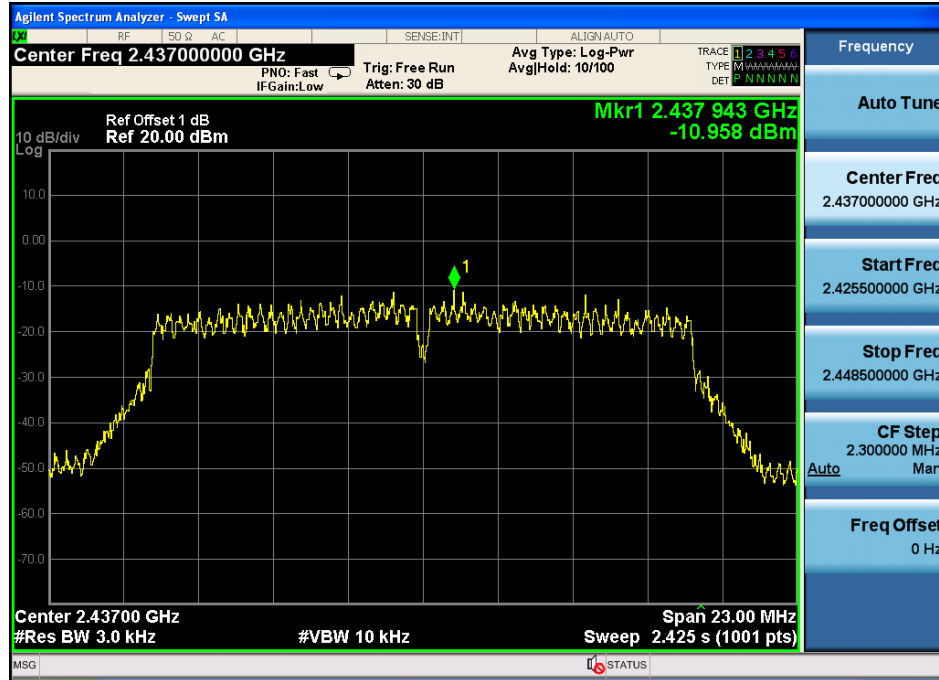

CH Hig:

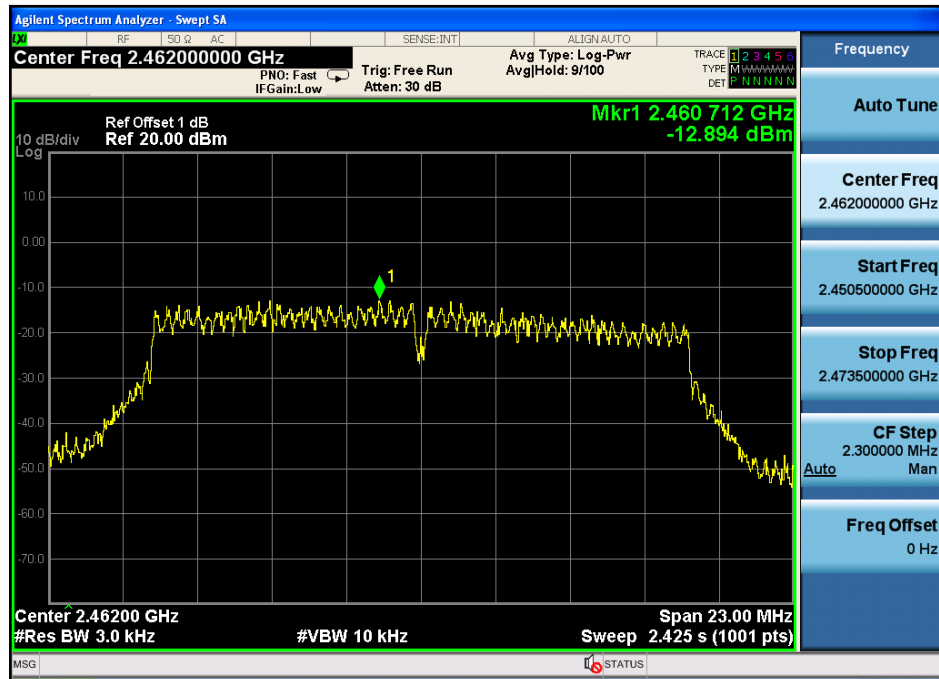

IEEE 802.11n HT20 :
CH Low :

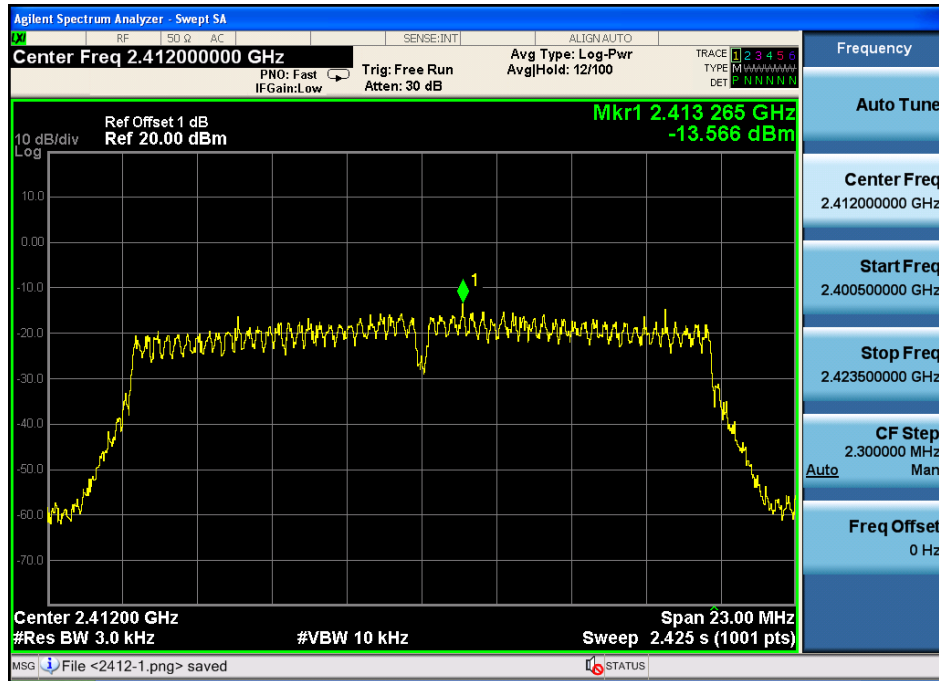

CH Mid:

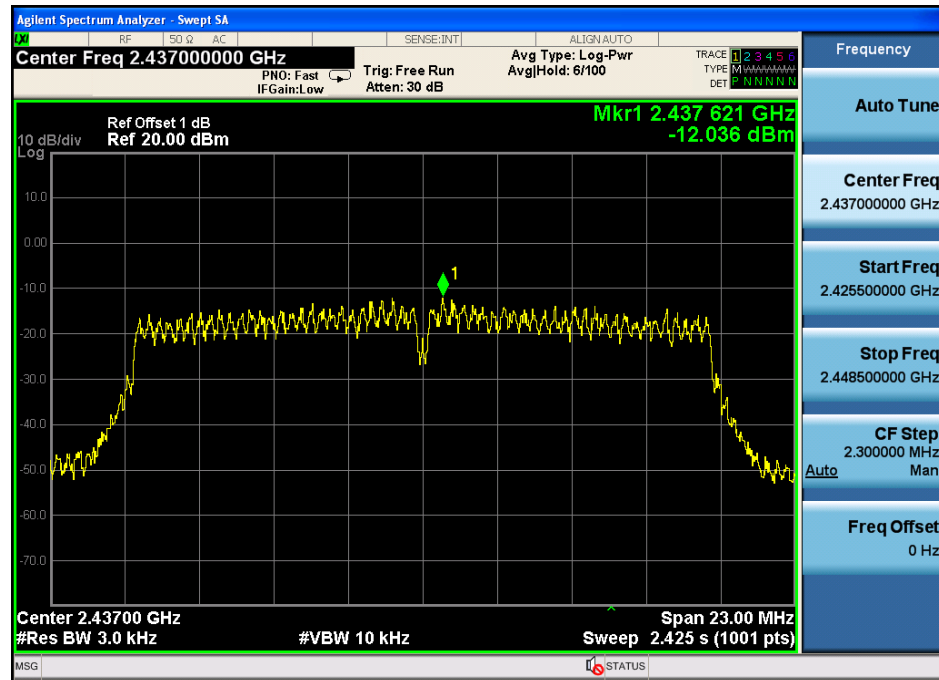

CH Hig:

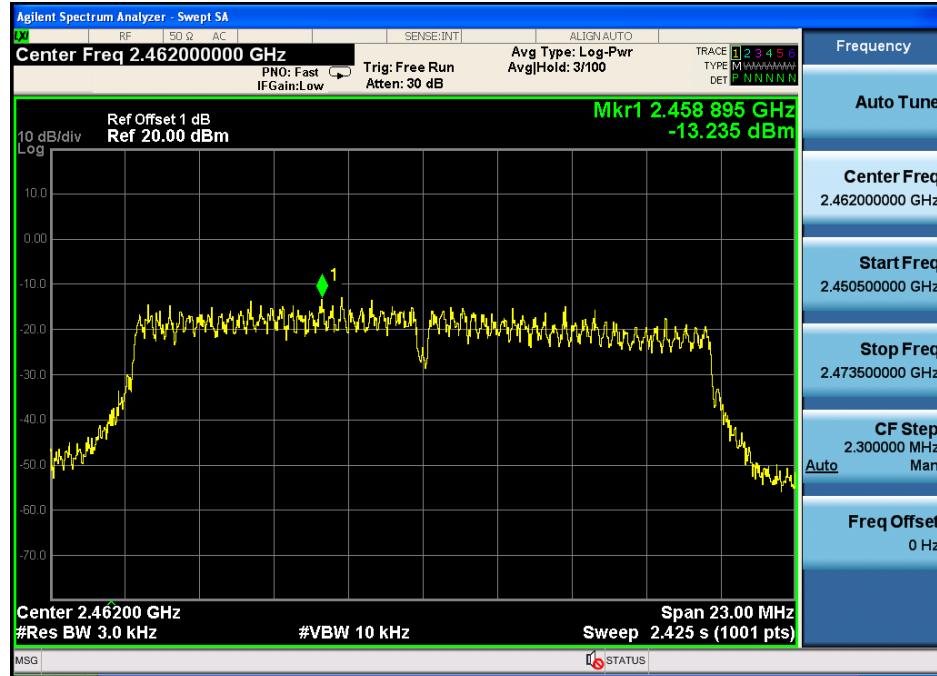

IEEE 802.11n HT40 :

CH Low :

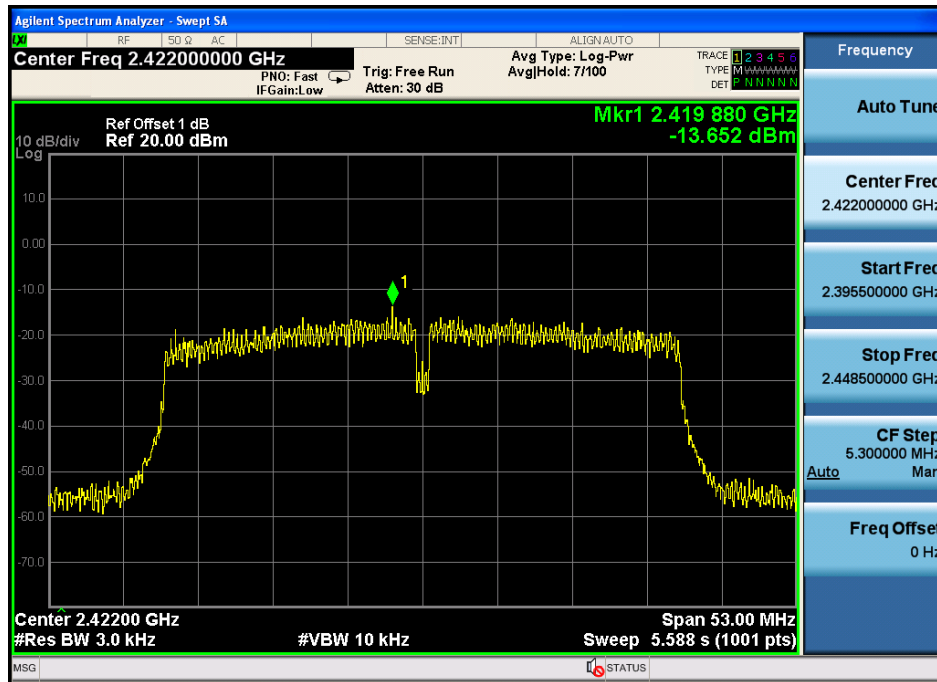

CH Mid:

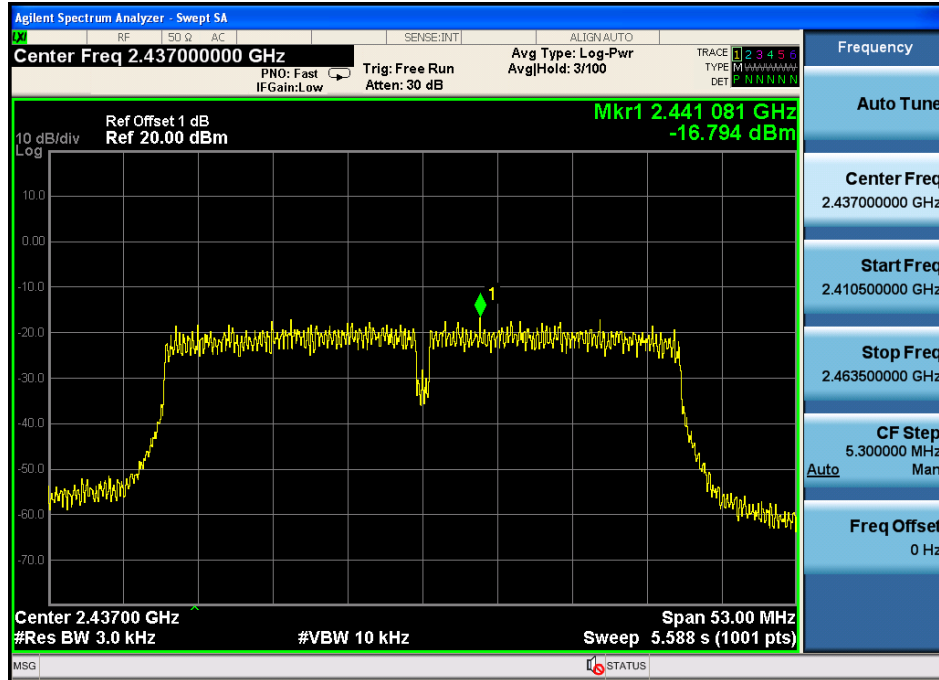

CH Hig:

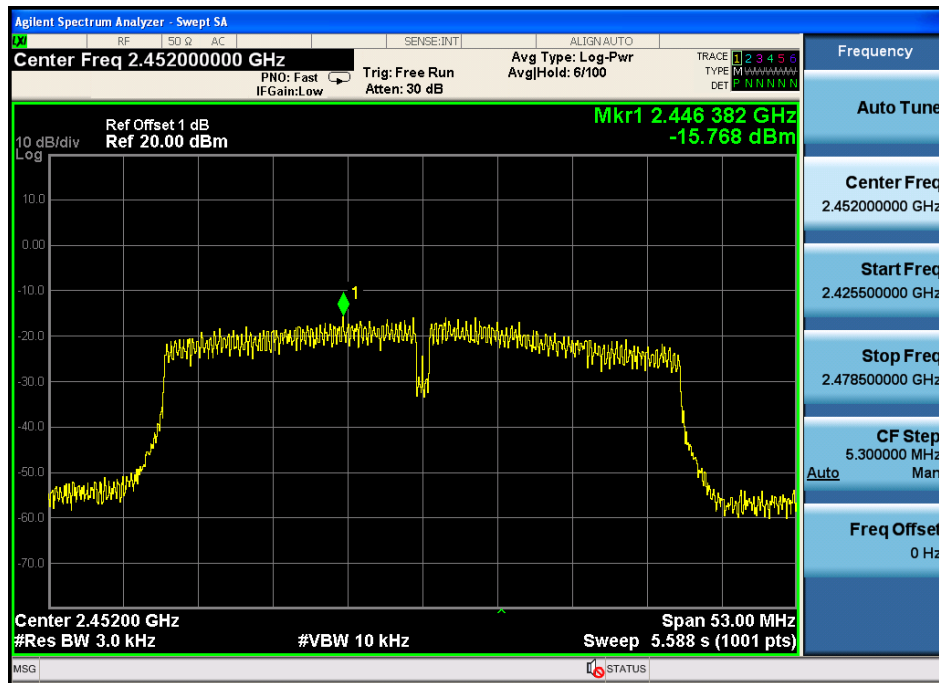

9 Bandwidth

9.1 Test limit

Please refer section 15.247

For direct sequence systems, the minimum 6dB bandwidth shall be at least 500 kHz.

9.2 Method of measurement

Details see the KDB558074 D01 Meas Guidance V04

a) The bandwidth is measured at an amplitude level reduced 20dB from the reference level.

The reference level is the level of the highest amplitude signal observed from the transmitter at the fundamental frequency. Once the reference level is established, the equipment is conditioned with typical modulating signal to produce the worst-case (i.e. the widest) bandwidth.

b) The test receiver set RBW = 100kHz, VBW $\geq 3 \cdot$ RBW = 300kHz,, Peak Detector, Sweep time set auto, detail see the test plot.

9.3 Test Setup

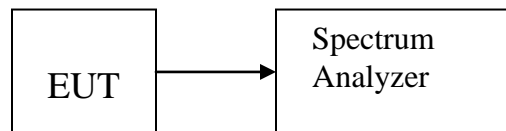

9.4 Test Results

PASS.

Detailed information please see the following page.