

WOSPORTS

G600 PRO WIFI Trail Camera

- Thanks for purchasing this trail camera
Please read before using this equipment
- If you have any questions or problems.
Please contact us by email: support@wosports.com

CONTENTS

PART LIST	4
PRODUCT STRUCTURE	
Front View	5
Operation Interface	6
Bottom View	7
Back View	7
CAMERA OPERATIONS	
How to use?	8
LOADING BATTERIES	9
INSERTING SD CARD	10
HOW TO INSTALL APP	11
APP SETUP FOR IOS PHONES	12-17
APP SETUP FOR ANDROID PHONES	18-21
USING THE CAMERA	
Operating Buttons	22
ITEM SETTINGS	
Settings Menu	23-27
MOUNTING	28
TECHNICAL SPECIFICATION	29-30
FAQ	31-36

PARTS LIST

1.Trail Camerax1

2.User' s Manualx1

3.Nylon Strap with Bucklex1

4.Wall Mountx1

5.Screwsx3

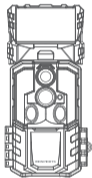

①



②



③

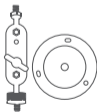

④



⑤

PRODUCT STRUCTURE

FRONT VIEW

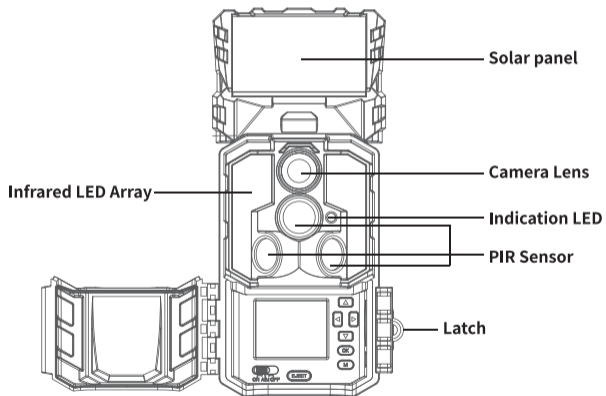

PRODUCT STRUCTURE

OPERATION INTERFACE

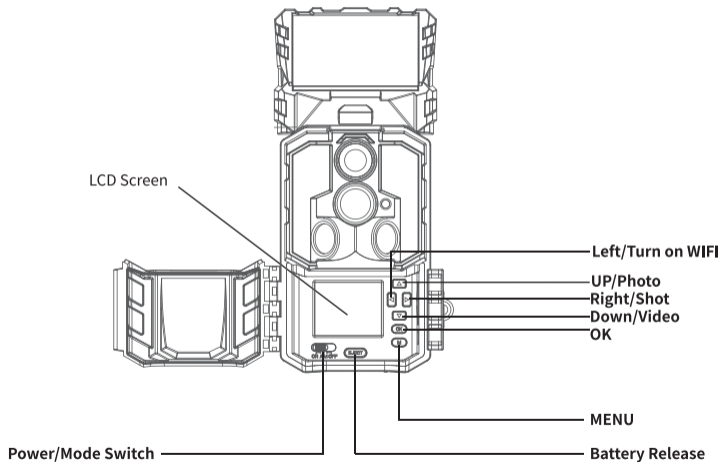

PRODUCT STRUCTURE

BOTTOM VIEW

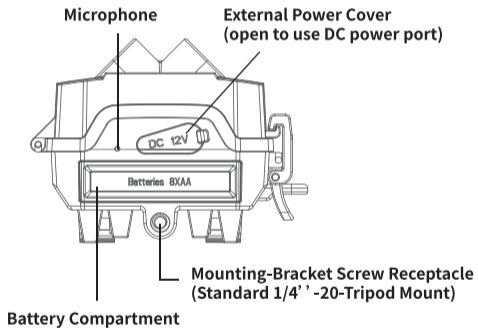

BACK VIEW

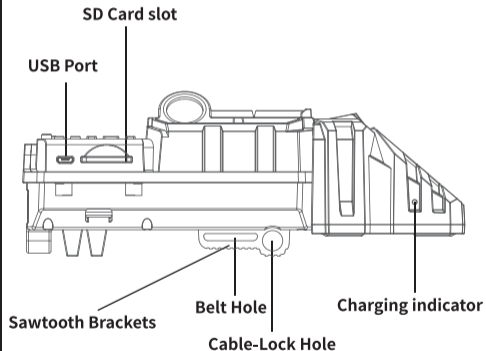

CAMERA OPERATIONS

HOW TO USE?

1. Insert the charger with 5V / 2A output into the USB port to fully charge the internal lithium battery. The indicator light is red when charging and green after charging fully. It can also be powered by 8PCS AA batteries.
2. Install SD card (CLASS 6 or higher class Up to 32GB max, NOT INCLUDED).
3. Put the switch to "AIM", then you can setting (Date/Time, Image resolution, video resolution, and the Interval time etc)
4. Put the switch to the "ON" position, it will enter the PIR detection state. Then the trail camera starts working.

Note:

1. Be sure to switch the camera's power OFF before inserting /exiting the SD card and loading/unloading the batteries.
2. Formatting the SD card before using it for the first time is recommended. (Put the switch to "AIM ". Press "Menu " - "Settings" - "Format" - Press OK to format the SD card .)

LOADING BATTERIES

1. Press the Battery Tray EJECT button to release the battery tray and pull it out for loading. Switch the camera's power OFF when loading/unloading batteries.
2. Be sure to inset each battery so its polarity(+/- direction) matches the polarity indications at the bottom of the battery tray. A full set of 8AA Alkaline or Lithium batteries should be used.
3. Pull the battery tray into the host, you will hear a slight “click” sound, which means the battery compartment is locked.

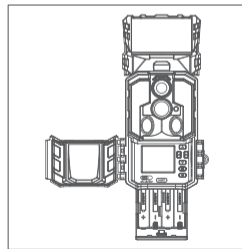
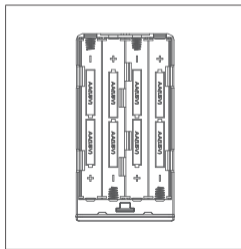
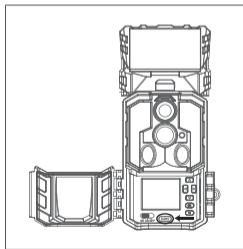

INSERTING SD CARD

Make sure that the SD card is insert correctly .If you hear“click” sounds that means it has be inserted correctly .The camera uses a standard SD memory card to save your photos or videos.SD and SDHC (high capacity)class 4 or higher seed cards up to a maximum 32GB are supported. A class 10 memory card is recommended when the camera works at burst mode.

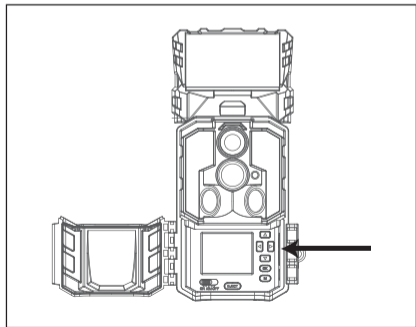
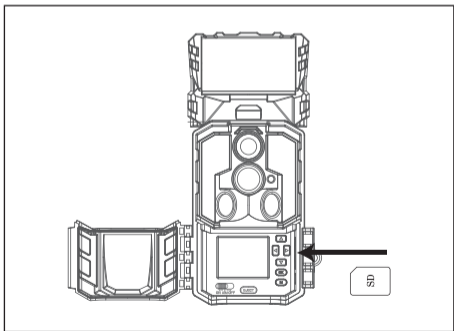

HOW TO INSTALL APP

Please download and install the APP on your smartphones before using. If you are IOS user, search "Wo Trail Cam" on Apple Store. If you are Android user, you can search "Remote Trail CAM" on Google Play to download and install, or directly scan the following QR code:



5. Set permissions:

Select “While Using” for Location, “All Photos” for Photos. Afterwards, click “Settings” at the left top corner for next setup.

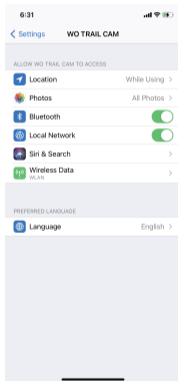

6. Select “WLAN” and enter into WIFI list.

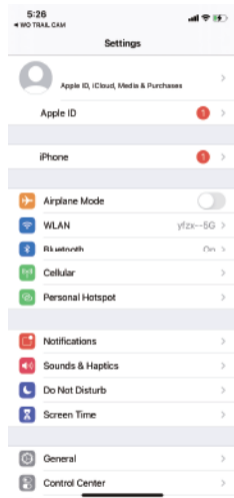

7. Select “G600-WIFI-XXXXXX” in the list.



8. Input password “12345678” to connect.

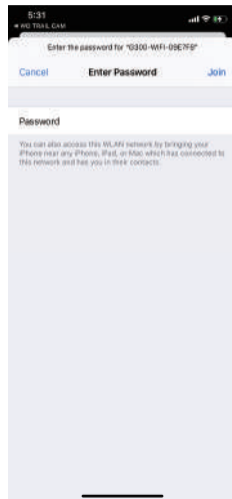

9. When WIFI connected, click “WO TRAIL CAM” at the left-top corner and back to camera APP.

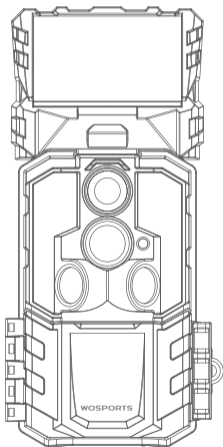



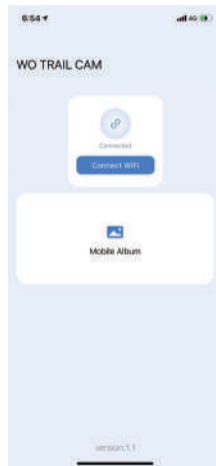

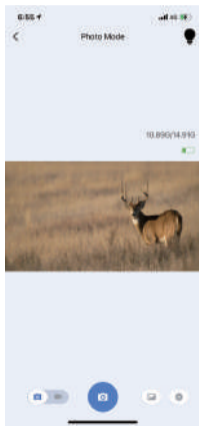

10. Select “Connect Wifi” to view the live video from camera



11. In this page, you can browse the photo/ video files from SD card, configure your camera and manage your settings, as well as shoot photos and videos.



12. Icon description.

	The camera's battery indicator
0.3GB/14.6GB	The camera's capacity indicator
	Turn on or turn off the IR LED
	The camera playback
	Camera Setting
	Turn on video mode
	Turn on photo mode
	Video recording or photo taking

1. In the WIFI list, select the WIFI name displayed on the camera screen "G600-WIFI-XXXXXX".



2. Enter the password "12345678" and click the Connect icon to connect to WIFI.

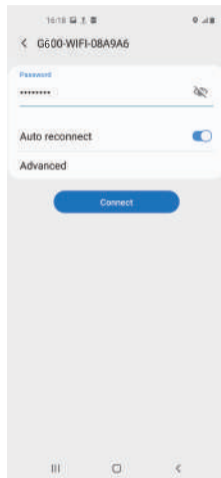







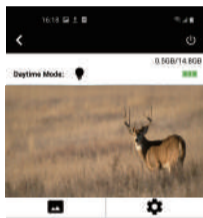

3. After confirming that the WIFI is connected, click the return button to automatically jump to the image interface.



4. In this interface, you can browse the pictures, videos and parameter settings of the SD card, You can also take photos and videos manually.











5. Icon description.

	Turn off Wifi
	The camera's battery indicator
0.3GB/14.6GB	The camera's capacity indicator
	Turn on or turn off the IR LED
	The camera playback
	Camera Setting
	Turn on video mode
	Turn on photo mode
	Video recording or photo taking

USING THE CAMERA

Operating Buttons

1.  :Page up.
2.  :Page down.
3.  :Page left.
4.  :Page right/ Shot key
5.  : Save settings.
 : Review photos and videos in the AIM mode.
Press OK again to exit the preview interface.
6.  :Enter the setup menu in preview mode.
 :Exchange between main screen and setup.
- 7.AIM mode: To program camera.
- 8.OFF mode: To turn off the camera.
- 9.ON mode: When movement occurs in the monitoring region, the camera will take pictures or videos automatically according to the previous programmed setting. After switching the camera to ON position, the motion-indication LED (red) will blink for about 10 seconds. This interval allows time for you to close the Cam' s front cover, lock it, and leave the monitored area.

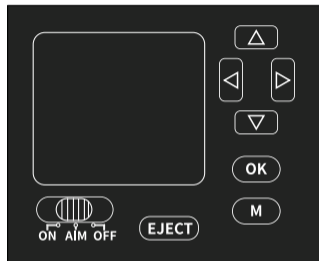

ITEM SETTINGS

Settings Menu

To view the camera settings menu, press(M) in the AIM mode.

Use ▲ or ▼ to select the sub-menu, use ◀ or ▶ to select the different options, then press (OK) to save the setting and the option. Press(M)to return.

Quick Setting

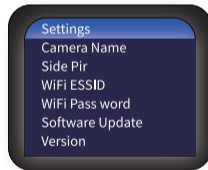

Setting Items	Sub menu	Description
Set Clock/ Date	00:00 00-00-0000	-Hour: Minute -Month-Date-Year

Setting Items	Sub menu	Description
Photo/Video		There are 3 modes to choose from Photo Video, Photo& video
Photo	Image Size Capture Number	-8MP, 16MP , 30MP Image size can be selected. -Number of photos per PIR capture. Can select 1-6 images.
Video	Video Size Video Length	-Quality: VGA :640x480P, HD:1280 x720P, FHD:1920x1080P, QHD:2560x1440P and 4K:3840x2160P video. -Video Length: Select between 5,10,20, 30 seconds, 1MIN, 2MIN We recommends setting the video length for more shorter tomaximize battery life.
Photo &Video	Image Size Capture Number Video Size Video Length	-If you choose this mode, the camera will take a photo first ,then start to record video.

Setting Items	Sub menu	Description
Interval	2second -60second 5minute-60minute	This interval means how long the PIR will be disabled after each triggering in the ON mode. During this time, the PIR will not react motion. The minimum interval is 2 seconds and the maximum is 60 minutes.
Sensor Level	LOW High	-Set the sensitivity of the sensor. -Low sensitivity, High sensitivity can be set .The higher degree indicates that the camera is more easily triggered by motion.It is recommended to use lower sensitivity for environments with lots of interference like wind, tall grass, or intense shadows.
Flash Modes	Power Save Long Range Fast Motion	-Set the distance of infrared induction. There are three options can be selected. - Power Save- Medium LED output Medium Shutter Speed. - Long Rang-High LED output Low Shutter Speed. - Fast Motion- High LED output Fast Shutter Speed.

Setting Items	Sub menu	Description
Set Active Time	Off ON Start 00:00 Stop 00:00	- Off means you shut down the function. - ON— The camera would always worked within the active time you set up.
Set Time lapse	Off ON TL Freq TL period	- Off— Close the time lapse function -Time lapse delay: Can select 5, 10 ,15, 30, 60 minutes. For example, set the interval to 5 minutes, the camera will take a photo each 5 minutes. The camera will take photos automatically during the 2 blocks of time you set up at “A” and “B”. Note: If the time of period A and period B you set are not within “Active Time” you set, the time lapse function will not react during this time quantum.
Format	Yes/No	- If you choose format SD card, the system will delete all images and video stored on the SD card. Make sure that you have a backup of important data. (Highly recommended to format with new SD cards.)

MOUNTING

After the setting the camera' s time/date and other options to your preference , you' re ready to take it outside and begin capturing images of animals in the area you want to monitor.

When mounting the camera to a tree, use the adjustable web belt provided. Please be sure to mount it in place correctly and securely. To get the optimal picture quality, the tree should be about 10-30ft. away from the place to be monitored, with the camera placed at a height of 3.6-4.5ft.

Tips: Try not to mount the camera facing the rising or setting sun. If mounting to a feeder or in a dusty environment , be sure to clean the camera lens and the PIR sensor regularly. Periodically check the mounting of the camera to make sure it hasn' t come loose. Check the batteries frequently to ensure they are still providing power to the camera.

TECHNICAL SPECIFICATION

Resolution	8MP Native Sensor/Up to 30MP Interpolated
Trigger Speed	0.3s
Camera Lens(FOV)	120 degree
IR Illumination	32pcs 850 LEDs
IR Flash Distance	90' Flash
Video Resolution	3840x2160P 2560x1440P 1920x1080P 1280 x720P 640x480P
Detection Distance	Up To 80 ft
Recovery Rate	1s
Time Lapse Mode	Yes
Multi Shot Mode	Up to 6 Per Trigger

WIFI	IEEE802.11b/g/n
Battery	Built in 2600mAH lithium battery, solar charging
LCD Screen	2.0" LCD Screen
Button Interface	Backlit 6 Button
Attachment Interface	1/4"-20 Brass Insert Bottom w/Dead Stop
Case Color	Camo Dipped Front Case
Power Source	8AA 12V
DC IN	12V DC In
Cable Lock Compatible	Yes, Closed Dual Slot Above Dual Strap Slot
Accessories	Nylon Strap with Buckle
Weight (Product without packaging)	Less Than 310 Grams (Without Batteries)
Dimensions (Product without packaging)	147mm x90mm x55mm

FAQ

CAMERA WON' T POWER UP

1. Make sure that you have installed all batteries in the battery compartment, filling all battery spaces with no “gaps”.
2. We recommend using a full set of 8 Energizer® Lithium AA batteries.
3. Make sure that the batteries are installed correctly, observing proper polarity.
4. Please be sure to switch the power “OFF” and remove the batteries if necessary. Trying to reopen the camera after 1 min.

FAQ

CAMERA STOPS TAKING IMAGES OR WON' T TALK IMAGES

1. Please make sure that the SD card is not full. If the card is full (display indicates "FULL", the camera will stop taking images.)
2. Make sure that the power/mode switch is in the ON position and not set to OFF or AIM.
3. Make sure that you are using a good quality SD card in your camera. We recommends SanDisk® SD cards up to 32GB.
4. If the SD card has its write protect switch in the lock position, the camera will not take images.
5. Formatting the SD card before using it for the first time is recommended. It can be completed using the "format" function. Make sure you have backed up (saved to your computer) any files you want to keep on a previously used card, as formatting erases all files.
6. Please make sure that the battery have the enough power to support to work.

FAQ

BATTERY LIFE IS SHORTER THAN EXPECTED

1. Check to make sure you have used new alkaline or lithium batteries. We recommend using a full set of 8 Energize® Lithium AA batteries to obtain maximum battery life.
2. These are several variables that will determine the battery life including type of batteries, temperature outside, recording settings, frequency of camera activity, etc. Colder temperatures, night photos and photo frequency (low camera delay) will result in shorter battery life. Note: capturing video clips and time lapse uses more power and will result in shorter battery life than capture motion detected photos. 2S Interval mode will use more power as more photos and videos will be taken. We recommend setting the Interval time for more longer time to maximize battery life.
3. Make sure that you are using a good quality SD card in your camera. We recommend SanDisk® SD cards up to 32GB. Our experience indicates that poor quality SD cards can sometimes reduce your camera battery life.

FAQ

CAMERA PIR WON' T WORK

1.Check the Interval time you settings. It won' t take images for a long time if you setting the Interval time is too longer .You can figure out that by restore the camera to factory settings.

2.Check if something stuff on the PIR sensor, please be sure the PIR sensor is clean.

3.Higher temperature will make the PIR detection distance become shorter. So that sometimes the animal will not be monitored even it is through by the PIR sensor' s detection of activity in the area it covers.

Please be sure to mount the camera in place correctly and securely. The height is need to keep the same between the animal and camera.

CAMERA TAKES CONTINUOUS IMAGES OF NO SUBJECT

A camera has what is know as a “false trigger” if the PIR sensor thinks that there is motion and heat in front of the camera lens when there is no subject in the images. These “false triggers” are the result of placing the camera in an environment where there is motion associated with tree branches creating motion in front of the camera or an area where

FAQ

there is high heat in the foreground and any motion from wind cloud set off the camera. Setting a camera up over water is also a potential cause for this issue. To remedy this situation.

1.Try moving the camera to an area that does not have any of these issues or remove potential obstacles near the lens if possible.

2.If the camera continuous to take images when there is no subject in them, test the camera by placing it in an inside environment and aiming at a location where there is no motion.

If the camera continuous to show issues, then there is probably an electronic component issue. If this the case, please contact service team.

PHOTO AND VIDEO QUALITY PROBLEMS

1.The image is blurred or out of focus

Check if something stuff on the lens, please be sure the lens is clean.

2.Daytime photos or videos appear too bright/dark

Make sure that the camera is not aimed at the sun or other light sources during the day.

FAQ

3.Night photos or video appear too bright

You will get the best results when the subject is within the ideal flash range, no closer than 3m from the camera. Subjects may appear too light at closer distances.



We will offer prompt and authoritative reply within 24 hours, and try our best to resolve your problem ASAP.

This equipment has been tested and found to comply with the limits for a Class B digital device, pursuant to part 15 of the FCC Rules. These limits are designed to provide reasonable protection against harmful interference in a residential installation. This equipment generates, uses and can radiate radio frequency energy and, if not installed and used in accordance with the instructions, may cause harmful interference to radio communications. However, there is no guarantee that interference will not occur in a particular installation. If this equipment does cause harmful interference to radio or television reception, which can be determined by turning the equipment off and on, the user is encouraged to try to correct the interference by one or more of the following measures:

- Reorient or relocate the receiving antenna.
- Increase the separation between the equipment and receiver.
- Connect the equipment into an outlet on a circuit different from that to which the receiver is connected.
- Consult the dealer or an experienced radio/TV technician for help.

Caution: Any changes or modifications to this device not explicitly approved by manufacturer could void your authority to operate this equipment.

This device complies with part 15 of the FCC Rules. Operation is subject to the following two conditions: (1) This device may not cause harmful interference, and (2) this device must accept any interference received, including interference that may cause undesired operation.

The device has been evaluated to meet general RF exposure requirement.