



## **Baby Monitor**

### **INSTRUCTION MANUAL**

*Thank you for purchasing our baby series products. We kindly recommend you to read the following instructions before using this product.*

## CONTENTS

Warning.....	04
Packing List.....	04
Camera Structure.....	05
Monitor Structure.....	05-07
Status Bar Icons.....	07-08
How To Use.....	08
Camera Setting.....	09-11
Sleep Mode.....	11-12
Temp/Sound Alert.....	12-14
Time Set.....	14-16
Brightness.....	16
Lullabies.....	17
Zoom.....	17-18
Setting.....	18-21
FAQ.....	21-22
Specification.....	23-24
FCC Statement.....	25-26

## WARNING

1. Please keep the product away from the baby more than 3feet (1meter).
2. Please place the product in a dry place to prevent short circuit caused by damp.
3. Please use Ac adapter(s) provided by us only. We do not recommend to use Ac adapters and charging cables from other brands.
4. This product is not medical equipment. Check your baby's activities regularly as this product is not designed for supervision but for assisting your supervising.

## PACKING LIST



①



②

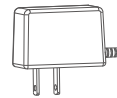

③

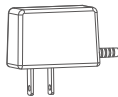

④



⑤



⑥

① Monitor

② Camera

③ Monitor AC power Adapter

④ Camera AC power Adapter

⑤ Mount kit

⑥ User Manual

## CAMERA STRUCTURE

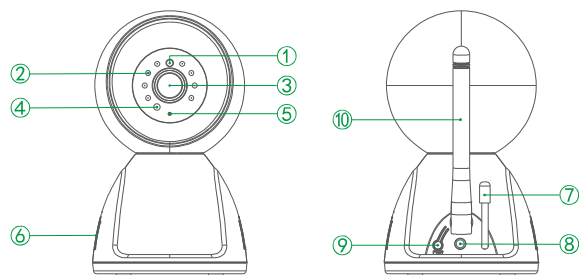

- |                |                      |
|----------------|----------------------|
| ① Light Sensor | ⑥ Speaker            |
| ② IR LED       | ⑦ Temperature sensor |
| ③ Camera       | ⑧ DC connector 3.5mm |
| ④ Power LEDs   | ⑨ Pairing key        |
| ⑤ Mic          | ⑩ Antenna            |

## MONITOR STRUCTURE

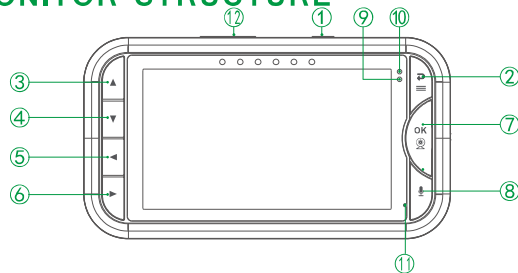

1. **Power /Sleep:** Long press to turn on/off the monitor.  
Short press to turn on /off the screen.
2. **Menu/Black:** Press to enter menu page or press as a Back button.
3. **Up:** Control motor to move up (Live video).  
Press to change your selection upward (Menu setting).
4. **Down:** Control motor to move down (Live video ).  
Press to change your selection downward (Menu setting).
5. **Left:** Control motor to move left (Live video).  
Press to change your selection leftward (Menu setting ).
6. **Right:** Control motor to move right (Live video).  
Press to change your selection rightward (Menu setting).
7. **OK/Camera Switch:** Press to confirm your selection or switch cameras if connected with 2 or more cameras.
8. **Talk:** Press to talk to your baby in the monitoring image.
9. **Charging Indicator:** It gives off red light while the monitor is being charged.
10. **Power Indicator:** The green light will turn on when turn on the power .
11. **Microphone.**
12. **Volume Button:** Press to adjust the monitor's volume in the monitoring image.

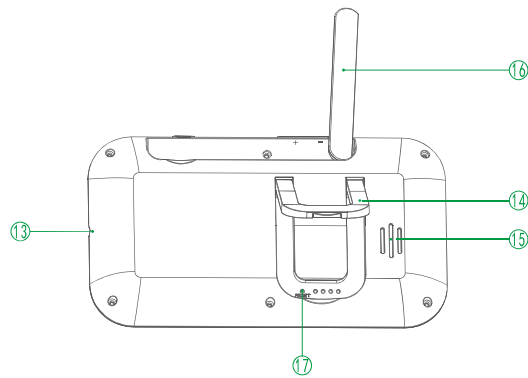

- ⑬ Power input
- ⑭ Support stand
- ⑮ Speaker
- ⑯ Antenna
- ⑰ Reset hole

### STATUS BAR ICON DESCRIPTION



- |                    |                     |
|--------------------|---------------------|
| ① Signal strength  | ⑥ Lullaby           |
| ② Temperature      | ⑦ Camera cycle time |
| ③ Camera connected | ⑧ Sound sensitivity |
| ④ Alarm prompt     | ⑨ Date/time         |
| ⑤ Feeding          | ⑩ Battery capacity  |

## HOW TO USE?

### Getting started

#### Step1:

1. Plug the AC adapter into a power socket.
2. Connect the camera to the DC adapter.

**Note:** Place the camera away from your baby 3ft/1m at least.

#### Step2:

1. Plug the AC adapter into a power socket.
2. Connect the monitor to the DC adapter.

**Note:** The monitor takes about 3 hours to be fully charged, and it lasts about 4hours.

#### Step3:

Long press the power button to turn on the monitor then you can see the monitoring interface.



**Note:** The camera and monitor were paired already before you get them. So you don't need to pair them.



# CAMERA SETTING

## 1. Add camera

This function is to add a new camera to the monitor.

- a. Press  button enter to the menu page. Select  and press OK to enter camera settings.

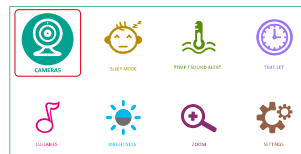

- b. Select **Add Camera** and press OK button.



- c. Pop up pairing interface .  
Countdown 60sec.

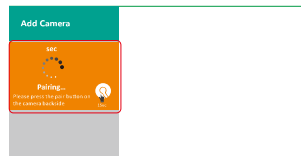



- d. Press the **Pair** button on the back of the camera. Then see the camera added successfully.





**Note:** Four cameras at most can be connected to one monitor.  
The video resolution is 720P when only one camera connected. The video resolution is VGA when connect 2-4 cameras.



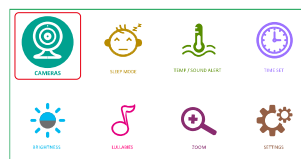

## 2. Delete Cameras

- a. Press  enter menu page.  
Select  and press OK to enter camera settings.

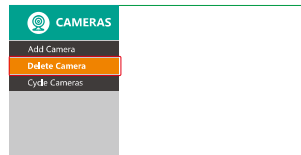

- b. Press  to select the **Delete Camera** and press OK.



- c. Press  or  to select the camera you need to delete.  
Press OK to confirm you choose.

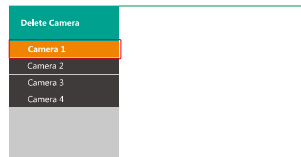

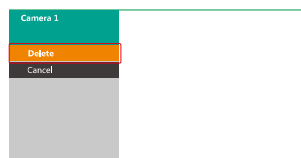

- d. Select the **Delete** option and go to delete your camera. Use  button to select **Cancel** to return to the superior menu.



### 3. Cycle Cameras

This function is setting the time for switch one camera to another camera if connecting multiple cameras.

- a. Press  enter menu page.  
Select  and press OK to enter camera settings.

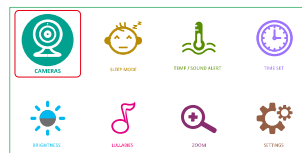

- b. Press  to select the **Cycle Cameras** and press OK.





- c. Choose the time you want.  
Press OK to confirm.





### SLEEP MODE

This function is to prolong your monitor's run time by shutting down the screen.

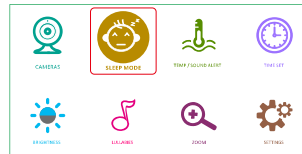
- a. Press  to enter menu page. Select . Press OK to enter the setting.



- b. Select OFF to turn off Sleep Mode. Press  or  button to select the time you want. Press OK to confirm.

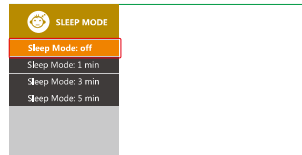



- c. Press  to back to menu interface.

## TEMP/SOUND ALERT

### 1. Temp Activated Alert

This function is to send alarms if the temperature exceeds your settings.

- a. Press  to enter menu page. Choose  and press OK.

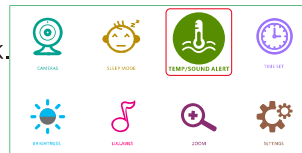

- b. Select the **Temp Activated Alert** and press OK.

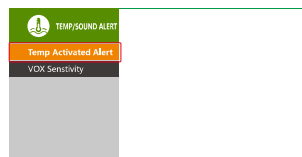

- c. High temperature setting.  
Select the option you want.  
Press OK to confirm.

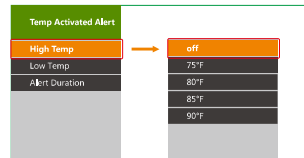

- d. Low temperature setting.  
Select the option you want.  
Press OK to confirm.

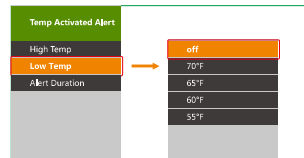

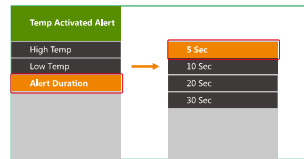

- e. Alert Duration setting. Select the time you want. Press OK to confirm.



## 2. VOX Sensitivity

### Sound Level

There are six options of sound detection, off, 1-5. OFF means you shut down the function. 1 means the sound sensitivity is the highest and so on for Medium and Lowest (5 sensitivity).

- a. Press  to enter menu page.  
Press  button to select the **Vox sensitivity** and press OK.

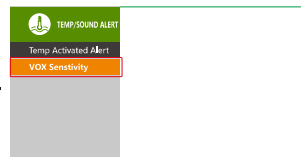

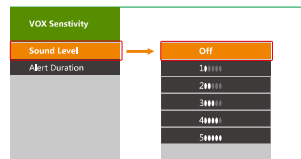

- b. Sound level setting, 1-5 levels of sensitivity you can choose. Press OK to confirm you want select one.

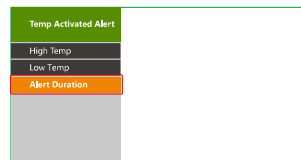

### Alert Duration

- a. Press  to enter menu page. Choose the **Alert Duration** option and press OK.



- b. There are four options of alarm time you can choose. Press  or  to choose the right time and press OK to confirm.

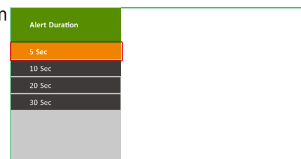



**Note:** The alert duration can adjust to 5s-30s. The alert interval time is 1 minute . 5s means it will alarm you lasts 5s every 1 minutes when the sound is detected, and so on for other options.

## TIME SET

### 1. Set Time

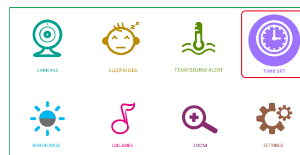

This function is to set Date/Time, turn on /off OSD. The real time you set that will be displayed on the status of the monitor if you turn on OSD.

- a. Press  to enter menu page.  
Choose  enter the settings.



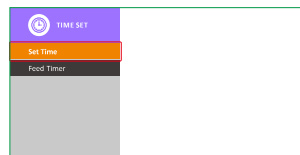



- b. Select **Set Time** and press OK to enter the next interface.

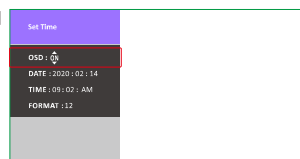

- c. Press  or  to choose the ON or OFF. ON stands for starting the setting.



- d. Use , , ,  button to change the Date/time settings. Press OK to finish setting.

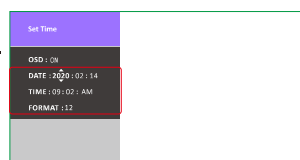

## 2. Feed Timer

This function is to remind you of feeding your baby. Off means you shut down the function, 2.5H hour means remind you every 2.5 hour and so on for other options.

- a. Press  to enter menu page.  
Choose **Feed Timer** enter the setting.

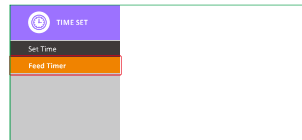

- b. Choose the time you want.  
Select Off to turn off the feeding reminder.

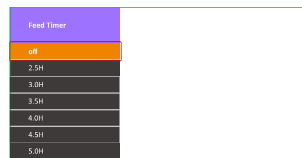



**Note:** Feeding alarm lasts 5 second.

## BRIGHTNESS

This function is to set the brightness of monitor screen.

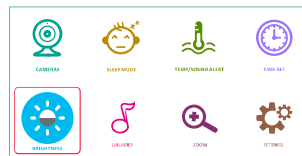
- a. Press  to enter menu page.  
Choose  enter the interface.



- b. Use ,  button to adjust the brightness.

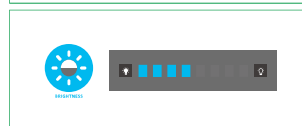



**Note:** The higher the brightness, the higher the power consumption.  
It has an impact on the working time of the monitor.

## LULLABIES

This function is to comfort your baby when needed.

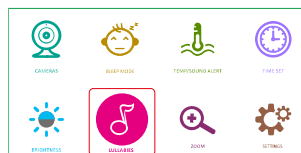
- a. Press  to enter menu page.  
Choose  enter the interface.



- b. Use ,  button to select the lullaby you want. Choose Play All to play the lullabies in a loop.

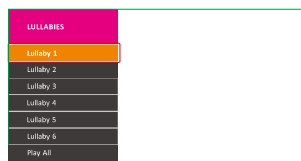

## ZOOM

This function is to Zoom in/out image to facilitate the observation of baby's life details.

- a. Press  to enter menu page.  
Choose  enter the interface.

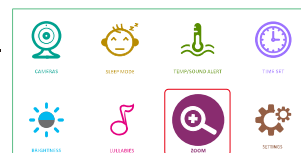



- b. Select 1.5x or 2x you want.  
Press OK to confirm.

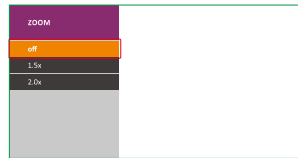

## SETTING

This function is to set Night Vision Mode, Anti-Screen Flicker, Default Settings and provide service support information.

### 1. Night Vision Mode

- a. Press to enter menu page.  
Choose enter the interface.

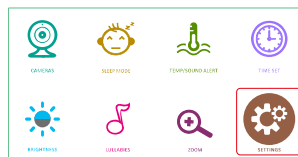

- b. Select the camera you want to  
turn on/off the  
**Night Vision function.**

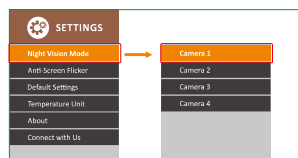

## 2. Anti-Screen Flicker

- a. Select and confirm **Anti-Screen Flicker**. Press OK to enter the interface.

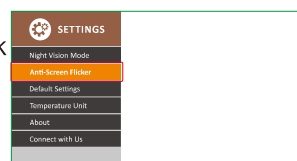

- b. Power supply frequency of 50Hz or 60Hz can be selected.



**Note:** Generally 60Hz is selected in the United States, Japan and other countries. In this way, the picture will not flicker because of the interference of the power frequency. It's usually 50Hz in Europe.

## 3. Default Settings

- a. Select and confirm **Default Settings**. Press OK to enter the interface.

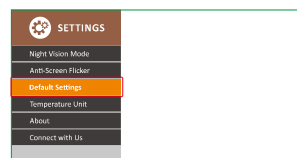

b. Confirm YES to reset. Press  or confirm NO to exit.

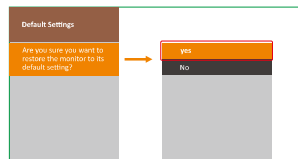

## 4. Temperature Unit

a. Select and confirm **Temperature Unit**. Press OK to enter the interface.

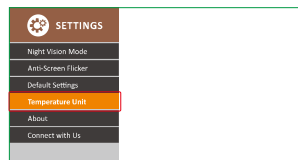

b. Choose °F or °C you want and press OK.

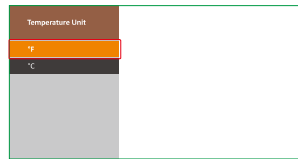

## 5. About

Select **About** to enter the interface.

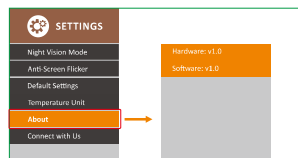

## 6. Connect With Us

Select **Connect With Us** to enter the interface.

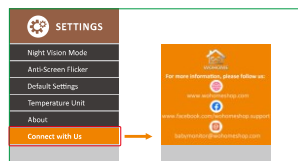

## FAQ

### Q1. The monitor will alarm when the network is disconnected

- a. The monitor will alarm 1 minute when the network is disconnected. It will alarm again after every 5 minutes, and so on lasts for 30minutes will automatically turn off.
- b. You can press Menu button to turn off the alarm directly.

### Q2. The monitor failed to connect to the camera

Please check whether the distance between the camera and the monitor is within the proper range Please try to move to a shorter distance and try to pair again.

### Q3. Why is the live video so blurry?

Please check and make sure there is no obstacle on the lens of the camera.

### Q4. Noise on the monitor

The camera is too close to the monitor. Please put them further apart.

**Q5. Can I hear my baby when I turn off the screen?**

Yes. Please turn on the function of sound monitoring on the monitor. It will wake up the screen and have a beep alarm prompt. If the camera detects that the baby's voice exceeds the set value.

**Q6. Why is there always the temperature alarm sound and icon prompt?**

Please check the temperature of the baby's room in time. If the temperature is abnormal, please timely adjust the temperature of the baby's room to avoid interfering with your baby's normal rest.

**Q7. Why are the pictures black and white?**

The Night Vision Mode will be activated if the camera worked in a dark scene (less than 7-10lux).

**Q8. Why don't you see images at night**

Please check the Night Vision mode setting of the monitor.  
Please confirm the Night Vision Mode is ON.

**Q9. How long will the monitor stand by with screen on?**

The monitor can last 4 hours, and the time of endurance varies depending on the brightness.

Please select the monitor brightness to the appropriate brightness. It can increase the working time of the battery.

## SPECIFICATION

	Item	Spec
No.	Camera	
1	Image Sensor	1/4-inch CMOS
2	Resolution	1280x720P
3	FOV Angle	70°
4	The Vertical Angle(Motor)	70 degree
5	The Horizontal Angle(Motor)	355 degree
6	IR Distance	5M
7	Night Vision	>5LUX(IR OFF)
8	Video Resolution	1280x720P/25fps
9	Video Bitrate	32kbps-8Mbps
10	Audio Encode	PCM
11	Audio Transmission	2 way audio
12	Alarm Mode	Voice Detection
13	Voice Sensitivity	49dbm
14	Wireless Transmission	2.4GHz FHSS
15	Transmission Distance	900ft
16	Connector	DC Interfac
17	Adaptor	DC 5V/1.5A
18	Working Power	600ma
19	Temperature Sensor	External
20	Dimension	81.2x72x123mm
21	Weight	189g(Adaptor not included)
22	Working Temperature	0°C~50°C
23	Working Humidity	20%~80%

No.	Monitor	
1	Screen Dimension	5inch
2	Screen Resolution	1280*720P
3	Video Input	Single channel(720P resolution) Multiple channel(VGA resolution)
4	Audio Input	Mic
5	Power Adaptor	DC 5V/1.5A
6	Built-in polymer lithium battery	2100mah/3.7V
7	Dimension	164x90x18.85mm
8	Weight	176g(Adaptor not included)
9	Working Temperature	-10°C~50°C
10	Working Humidity	20%~80%

## FCC STATEMENT

This equipment has been tested and found to comply with the limits for a Class B digital device, pursuant to part 15 of the FCC Rules. These limits are designed to provide reasonable protection against harmful interference in a residential installation. This equipment generates, uses and can radiate radio frequency energy and, if not installed and used in accordance with the instructions, may cause harmful interference to radio communications. However, there is no guarantee that interference will not occur in a particular installation. If this equipment does cause harmful interference to radio or television reception, which can be determined by turning the equipment off and on, the user is encouraged to try to correct the interference by one or more of the following measures:

- Reorient or relocate the receiving antenna.
- Increase the separation between the equipment and receiver.
- Connect the equipment into an outlet on a circuit different from that to which the receiver is connected.
- Consult the dealer or an experienced radio/TV technician for help.

**Caution:** Any changes or modifications to this device not explicitly approved by manufacturer could void your authority to operate this equipment.



This device complies with part 15 of the FCC Rules. Operation is subject to the following two conditions: (1) This device may not cause harmful interference, and (2) this device must accept any interference received, including interference that may cause undesired operation.

The device has been evaluated to meet general RF exposure requirement.

The distance between user and products should be no less than 20cm.



If you have any questions or problems,

Please contact us by email: [babymonitor@wohomeshop.com](mailto:babymonitor@wohomeshop.com)

We will offer prompt and authoritative reply within 24 hours, and try our best to resolve your problem ASAP.