



FCC TEST REPORT

FCC ID: 2AFCB-LY-129

On Behalf of

Shenzhen Longzhiyuan Technology Co., Ltd.

Baby monitor

Model No.: LY-129

Prepared for : Shenzhen Longzhiyuan Technology Co., Ltd.
Address : 2F & 5F, Bldg #2, Zhuangbian 2nd Industrial Park, Hezhou Community,
Hangcheng, Bao'an, Shenzhen City, China

Prepared By : Shenzhen Alpha Product Testing Co., Ltd.
Address : Building i, No.2, Lixin Road, Fuyong Street, Bao'an District, 518103,
Shenzhen, Guangdong, China

Report Number : A2007208-C01-R01
Date of Receipt : July 22, 2020
Date of Test : July 22-30, 2020
Date of Report : July 30, 2020
Version Number : V0

TABLE OF CONTENTS

Description	Page
1. Summary of Standards And Results	6
1.1. Description of Standards and Results	6
2. General Information.....	7
2.1. Description of Device (EUT).....	7
2.2. Accessories of Device (EUT)	8
2.3. Tested Supporting System Details	8
2.4. Block Diagram of connection between EUT and simulators	8
2.5. Test Mode Description.....	8
2.6. Test Conditions	9
2.7. Test Facility	9
2.8. Measurement Uncertainty.....	9
2.9. Test Equipment List	10
3. Maximum Peak Output power	11
3.1. Limit	11
3.2. Test Procedure	11
3.3. Test Setup.....	11
3.4. Test Result	11
4. Bandwidth.....	12
4.1. Limit	12
4.2. Test Procedure	12
4.3. Test Result	12
5. Carrier Frequency Separation.....	16
5.1. Limit	16
5.2. Test Procedure	16
5.3. Test Result	16
6. Number Of Hopping Channel.....	17
6.1. Limit	17
6.2. Test Procedure	17
6.3. Test Result	17
7. Dwell Time.....	18
7.1. Test limit	18
7.2. Test Procedure	18
7.3. Test Result	18
8. Radiated emissions.....	20
8.1. Limit	20
8.2. Block Diagram of Test setup	21
8.3. Test Procedure	22
8.4. Test Result	22
9. Band Edge Compliance	26

9.1. Block Diagram of Test Setup.....	26
9.2. Limit	26
9.3. Test Procedure	26
9.4. Test Result	26
10. Power Line Conducted Emissions	30
10.1. Block Diagram of Test Setup.....	30
10.2. Limit	30
10.3. Test Procedure	30
10.4. Test Result	30
11. Antenna Requirements	33
11.1. Limit	33
11.2. Result	33
12. Test setup photo	34
12.1. Photos of Radiated emission.....	34
12.2. Photos of Power Line Conducted Emission Test.....	35
13. Photos of EUT	36

TEST REPORT DECLARATION

Applicant : Shenzhen Longzhiyuan Technology Co., Ltd.
 Address : 2F & 5F, Bldg #2, Zhuangbian 2nd Industrial Park, Hezhou Community, Hangcheng, Bao'an, Shenzhen City, China
 Manufacturer : Shenzhen Longzhiyuan Technology Co., Ltd.
 Address : 2F & 5F, Bldg #2, Zhuangbian 2nd Industrial Park, Hezhou Community, Hangcheng, Bao'an, Shenzhen City, China
 EUT Description : Baby monitor
 (A) Model No. : LY-129
 (B) Trademark : N/A

Measurement Standard Used:

FCC Rules and Regulations Part 15 Subpart C Section 15.247

ANSI C63.10: 2013

The device described above is tested by Shenzhen Alpha Product Testing Co., Ltd. to determine the maximum emission levels emanating from the device. The maximum emission levels are compared to the FCC Part 15 Subpart C limits both conducted and radiated emissions. The test results are contained in this test report and Shenzhen Alpha Product Testing Co., Ltd. is assumed of full responsibility for the accuracy and completeness of these tests.

After the test, our opinion is that EUT compliance with the requirement of the above standards.

This report applies to above tested sample only. This report shall not be reproduced in parts without written approval of Shenzhen Alpha Product Testing Co., Ltd.

Tested by (name + signature).....: Lucas Pang
 Project Engineer



.....

Approved by (name + signature).....: Simple Guan
 Project Manager



.....

Date of issue..... : July 30, 2020

Revision History

Revision	Issue Date	Revisions	Revised By
V0	July 30, 2020	Initial released Issue	Lucas Pang

1. SUMMARY OF STANDARDS AND RESULTS

1.1. Description of Standards and Results

The EUT have been tested according to the applicable standards as referenced below:

Test Item	Standards Paragraph	Result
Maximum Peak Output Power	FCC Part 15: 15.247(b)(1) ANSI C63.10: 2013	P
Bandwidth	FCC Part 15: 15.215 ANSI C63.10: 2013	P
Carrier Frequency Separation	FCC Part 15: 15.247(a)(1) ANSI C63.10: 2013	P
Number Of Hopping Channel	FCC Part 15: 15.247(a)(1)(iii) ANSI C63.10: 2013	P
Dwell Time	FCC Part 15: 15.247(a)(1)(iii) ANSI C63.10: 2013	P
Radiated Emission	FCC Part 15: 15.209 FCC Part 15: 15.247(d) ANSI C63.10: 2013	P
Band Edge Compliance	FCC Part 15: 15.247(d) ANSI C63.10: 2013	P
Power Line Conducted Emissions	FCC Part 15: 15.207 ANSI C63.10: 2013	P
Antenna requirement	FCC Part 15: 15.203	P
Note:	1. P is an abbreviation for Pass. 2. F is an abbreviation for Fail. 3. N/A is an abbreviation for Not Applicable.	

2. GENERAL INFORMATION

2.1. Description of Device (EUT)

Description : Baby monitor

Model Number : LY-129

Diff : N/A

Trademark : N/A

Test Voltage : DC 5V from adapter

Operation frequency : 2410-2477MHz

Channel No. : 23 Channels

Modulation type : GFSK

Antenna Type : External antenna, Maximum Gain is 3.5dBi

Software version : V1.0

Hardware version : V1.0

Note : N/A

2.2. Accessories of Device (EUT)

Accessory 1	:	TRAVEL CHARGER
Model	:	TPA-97050150U01
Input	:	100-240V~50/60Hz 0.3A
Output	:	5V=1500mA
Accessory 2	:	/
Model	:	/
Input	:	/
Output	:	/

2.3. Tested Supporting System Details

No.	Description	Manufacturer	Model	Serial Number	Certification or SDOC
1	N/A	N/A	N/A	N/A	N/A

2.4. Block Diagram of connection between EUT and simulators

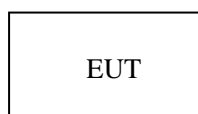

2.5. Test Mode Description

Tested mode, channel, and data rate information		
Mode	Channel	Frequency (MHz)
GFSK	Low :CH1	2410
	Middle: CH11	2441
	High: CH23	2477
	Hopping	2410-2477

Channel list:

CH1	2410MHz	CH7	2429MHz	CH13	2447MHz	CH19	2465MHz
CH2	2414MHz	CH8	2432MHz	CH14	2450MHz	CH20	2468MHz
CH3	2417MHz	CH9	2435MHz	CH15	2453MHz	CH21	2471MHz
CH4	2420MHz	CH10	2438MHz	CH16	2456MHz	CH22	2474MHz
CH5	2423MHz	CH11	2441MHz	CH17	2459MHz	CH23	2477MHz
CH6	2426MHz	CH12	2444MHz	CH18	2462MHz		

2.6. Test Conditions

Items	Required	Actual
Temperature range:	15-45°C	27°C
Humidity range:	25-75%	56%
Pressure range:	86-106kPa	98kPa

2.7. Test Facility

Shenzhen Alpha Product Testing Co., Ltd

Building i, No.2, Lixin Road, Fuyong Street, Bao'an District, 518103,
Shenzhen, Guangdong, China

June 21, 2018 File on Federal Communication Commission

Registration Number: 293961

Designation Number: CN1236

July 15, 2019 Certificated by IC

Registration Number: CN0085

2.8. Measurement Uncertainty

(95% confidence levels, k=2)

Item	Uncertainty
Uncertainty for Power point Conducted Emissions Test	2.74dB
Uncertainty for Radiation Emission test in 3m chamber (below 30MHz)	2.13 dB(Polarize: V)
	2.57dB(Polarize: H)
Uncertainty for Radiation Emission test in 3m chamber (30MHz to 1GHz)	3.77dB(Polarize: V)
	3.80dB(Polarize: H)
Uncertainty for Radiation Emission test in 3m chamber (1GHz to 25GHz)	4.13dB(Polarize: H)
	4.16dB(Polarize: V)
Uncertainty for radio frequency	5.4×10^{-8}
Uncertainty for conducted RF Power	0.37dB
Uncertainty for temperature	0.2°C
Uncertainty for humidity	1%
Uncertainty for DC and low frequency voltages	0.06%

2.9. Test Equipment List

Equipment	Manufacture	Model No.	Serial No.	Last cal.	Cal Interval
9*6*6 anechoic chamber	CHENYU	9*6*6	N/A	2019.09.06	3Year
Spectrum analyzer	ROHDE&SCHWARZ	FSV40-N	102137	2019.09.05	1Year
Spectrum analyzer	Agilent	N9020A	MY499100060	2019.09.05	1Year
Receiver	ROHDE&SCHWARZ	ESR	1316.3003K03-10208 2-Wa	2019.09.06	1Year
Receiver	R&S	ESCI	101165	2019.09.05	1Year
Bilog Antenna	Schwarzbeck	VULB 9168	VULB9168-438	2019.09.07	2Year
Horn Antenna	SCHWARZBECK	BBHA 9120 D	BBHA 9120 D(1201)	2020.04.12	2Year
Active Loop Antenna	SCHWARZBECK	FMZB 1519B	00059	2019.09.07	2Year
Cable	Resenberger	N/A	No.1	2019.09.05	1Year
Cable	Resenberger	N/A	No.2	2019.09.05	1Year
Cable	Resenberger	N/A	No.3	2019.09.05	1Year
Pre-amplifier	HP	HP8347A	2834A00455	2019.09.05	1Year
Pre-amplifier	Agilent	8449B	3008A02664	2019.09.05	1Year
L.I.S.N.#1	Schwarzbeck	NSLK8126	8126466	2019.09.05	1Year
L.I.S.N.#2	ROHDE&SCHWARZ	ENV216	101043	2019.09.05	1Year
20db Attenuator	ICPROBING	IATS1	82347	2019.08.26	1Year
Horn Antenna	SCHWARZBECK	BBHA9170	00946	2019.09.07	2Year
Preamplifier	SKET	LNPA_1840-50	SK2018101801	2019.09.06	1Year
Power Meter	Agilent	E9300A	MY41496625	2019.09.06	1Year
Temp. & Humid. Chamber	Weihuang	WHTH-1000-40-8 80	100631	2019.09.06	1Year
Switching Mode Power Supply	JUNKE	JK12010S	20140927-6	2019.09.05	1Year

3. MAXIMUM PEAK OUTPUT POWER

3.1.Limit

Please refer section15.247.

For frequency hopping systems operating in the 2400-2483.5 MHz band employing at least 75 non-overlapping hopping channels, and all frequency hopping systems in the 5725-5850 MHz band: 1 watt. For all other frequency hopping systems in the 2400-2483.5 MHz band: 0.125 watts, the e.i.r.p shall not exceed 4W

3.2.Test Procedure

The transmitter output is connected to the RF Power Meter. The RF Power Meter is set to the peak power detection.

3.3.Test Setup

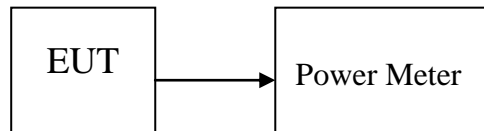

3.4.Test Result

Mode	Freq (MHz)	PK Output Power (dBm)	PK Output Power (mW)	Limit (dBm)	Result
GFSK	2410	12.686	18.561	21.00	Pass
	2441	12.895	19.476	21.00	Pass
	2477	11.224	13.256	21.00	Pass
Conclusion: PASS					

4. BANDWIDTH

4.1.Limit

Intentional radiators operating under the alternative provisions to the general emission limits, as contained in §§ 15.217 through 15.257 and in Subpart E of this part, must be designed to ensure that the 20 dB bandwidth of the emission, or whatever bandwidth may otherwise be specified in the specific rule section under which the equipment operates, is contained within the frequency band designated in the rule section under which the equipment is operated.

4.2.Test Procedure

The transmitter output was directly connected to a spectrum analyzer with a 50Ω cable. The bandwidth of the fundamental frequency was measured by spectrum analyzer with 30kHz RBW and 100kHz VBW. The 20dB bandwidth is defined as the total spectrum the power of which is higher than peak power minus 20dB.

4.3.Test Result

Frequency (MHz)	Antenna	99% OBW (MHz)	-20 dB Bandwidth (MHz)	Limit -20 dB Bandwidth (MHz)	Verdict
2410	Ant 1	4.3896	4.06	/	Pass
2441	Ant 1	4.4266	4.443	/	Pass
2477	Ant 1	4.7095	4.055	/	Pass

OBW NVNT 1-DH1 2410MHz Ant1

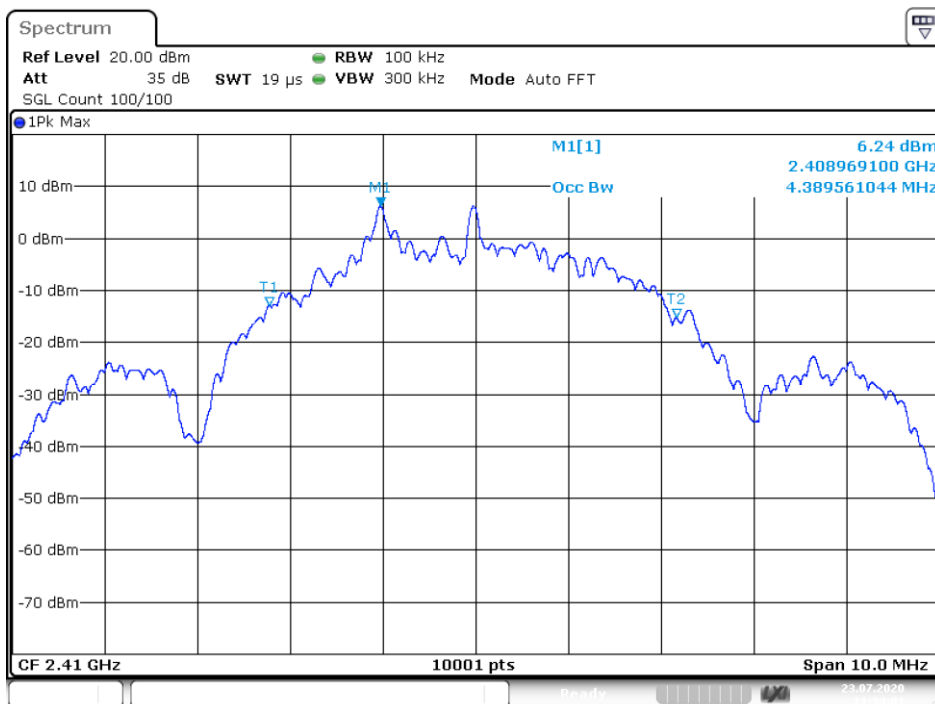

Date: 23.JUL.2020 11:34:02

-20 dB BW NVNT 1-DH1 2410MHz Ant1

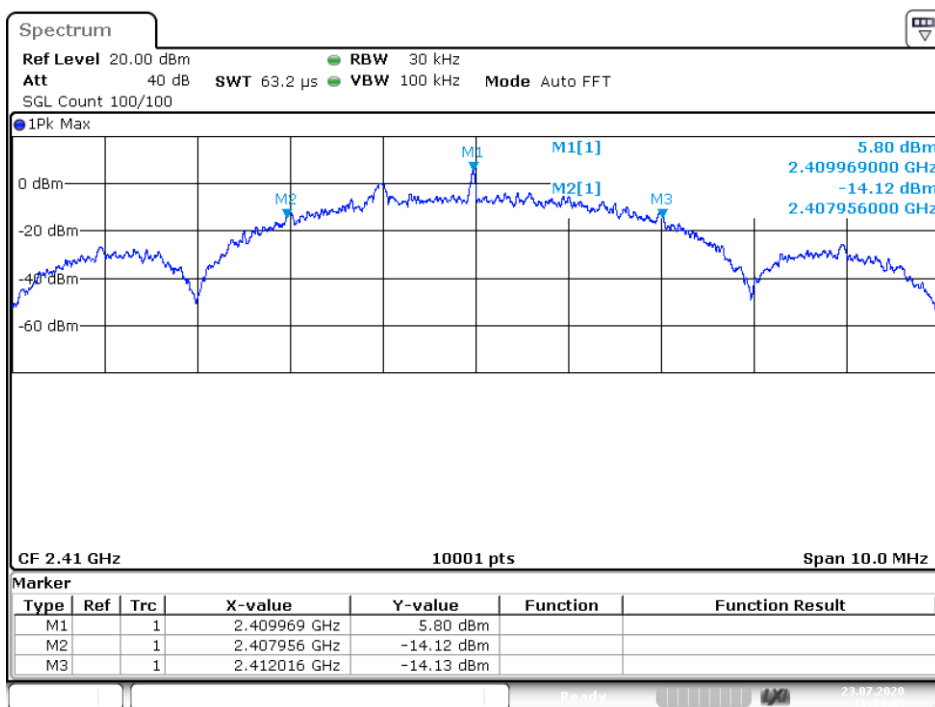

Date: 23.JUL.2020 11:34:05

OBW NVNT 1-DH1 2441MHz Ant1

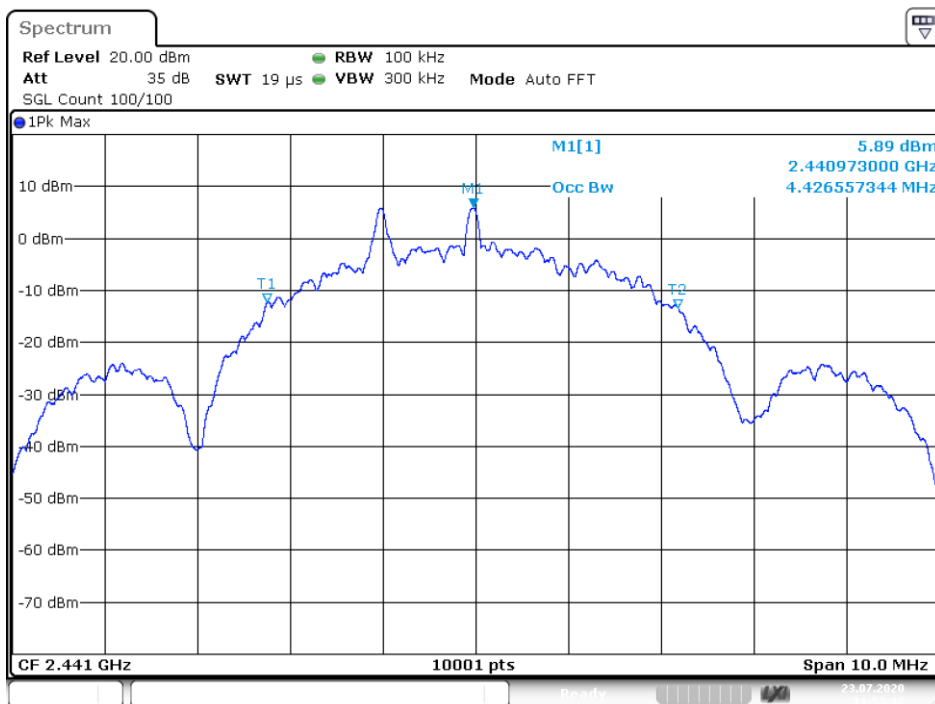

Date: 23.JUL.2020 11:53:17

-20 dB BW NVNT 1-DH1 2441MHz Ant1

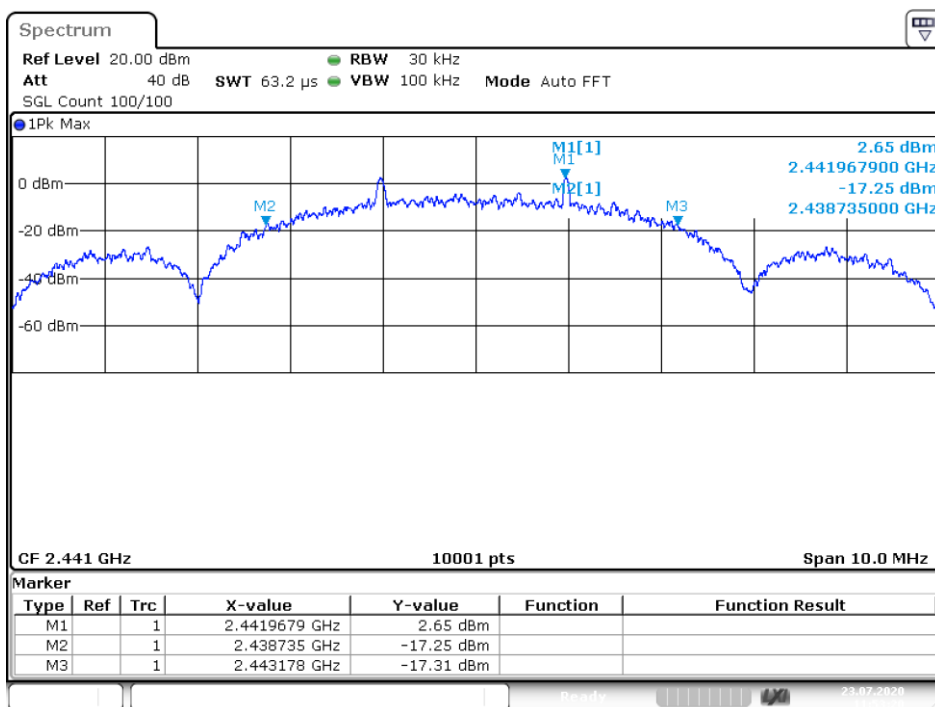

Date: 23.JUL.2020 11:53:20

OBW NVNT 1-DH1 2477MHz Ant1

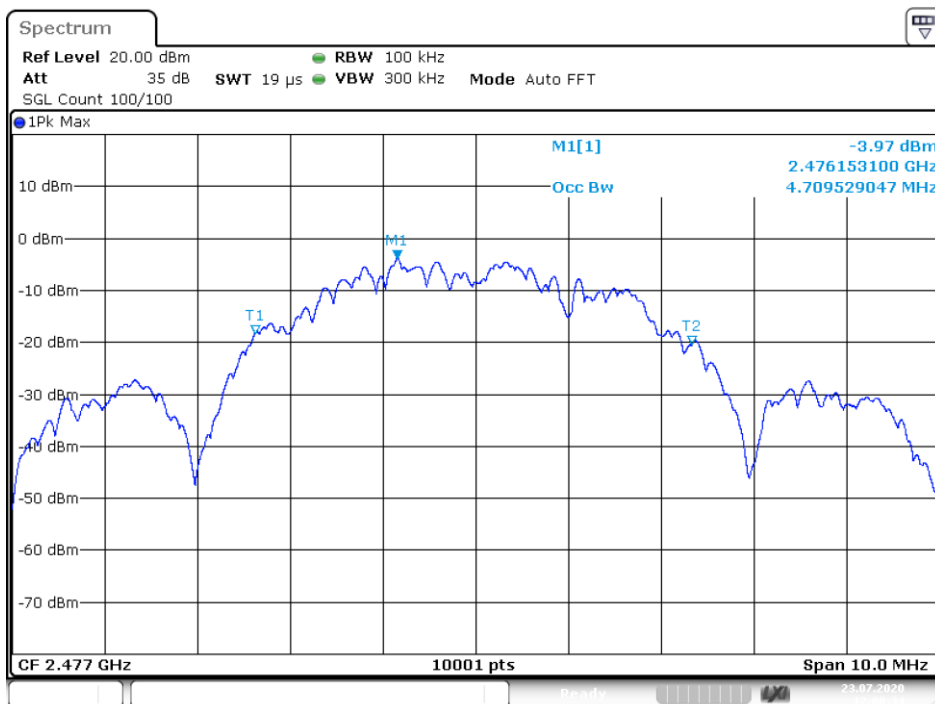

Date: 23.JUL.2020 12:00:34

-20 dB BW NVNT 1-DH1 2477MHz Ant1

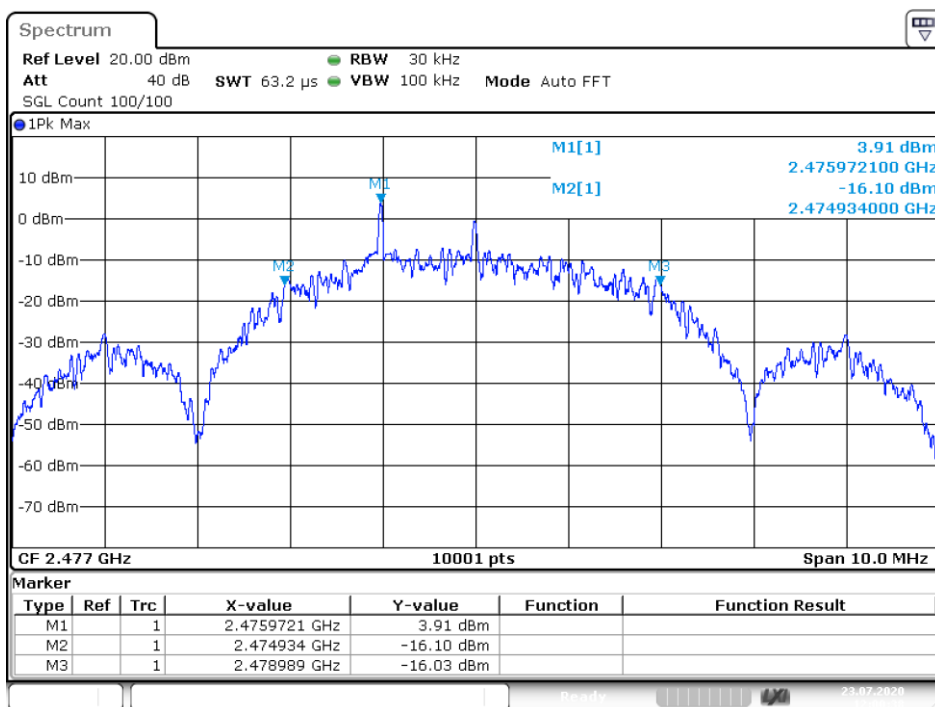

Date: 23.JUL.2020 12:00:38

5. CARRIER FREQUENCY SEPARATION

5.1.Limit

Frequency hopping systems shall have hopping channel carrier frequencies separated by a minimum of 25 kHz or the 20 dB bandwidth of the hopping channel, whichever is greater. Alternatively, frequency hopping systems operating in the 2400-2483.5 MHz band may have hopping channel carrier frequencies that are separated by 25 kHz or two-thirds of the 20 dB bandwidth of the hopping channel, whichever is greater, provided the systems operate with an output power no greater than 125 mW

5.2.Test Procedure

The transmitter output was directly connected to a spectrum analyzer with a 50Ω cable. The carrier frequency was measured by spectrum analyzer with 100kHz RBW and 300kHz VBW.

5.3.Test Result

Condition	Mode	Freq(MHz)	HFS (MHz)	Limit (MHz)	Verdict
NVNT	User	2441	3.040	2.54	Pass

CFS NVNT user 2441MHz

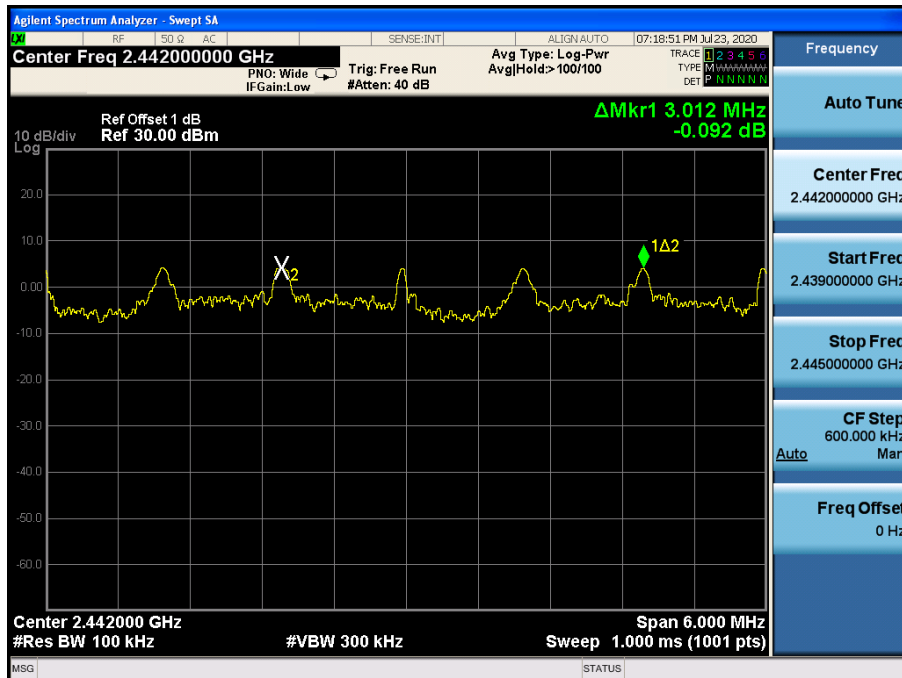

6. NUMBER OF HOPPING CHANNEL

6.1.Limit

Frequency hopping systems in the 2400-2483.5 MHz band shall use at least 15 channels

6.2.Test Procedure

The transmitter output was directly connected to a spectrum analyzer with a 50Ω cable. The number of hopping channel was measured by spectrum analyzer with 100kHz RBW and 300KHz VBW.

6.3.Test Result

Condition	Mode	Hopping Number	Limit	Verdict
NVNT	user	23	15	Pass

Hopping No. NVNT user 2441MHz

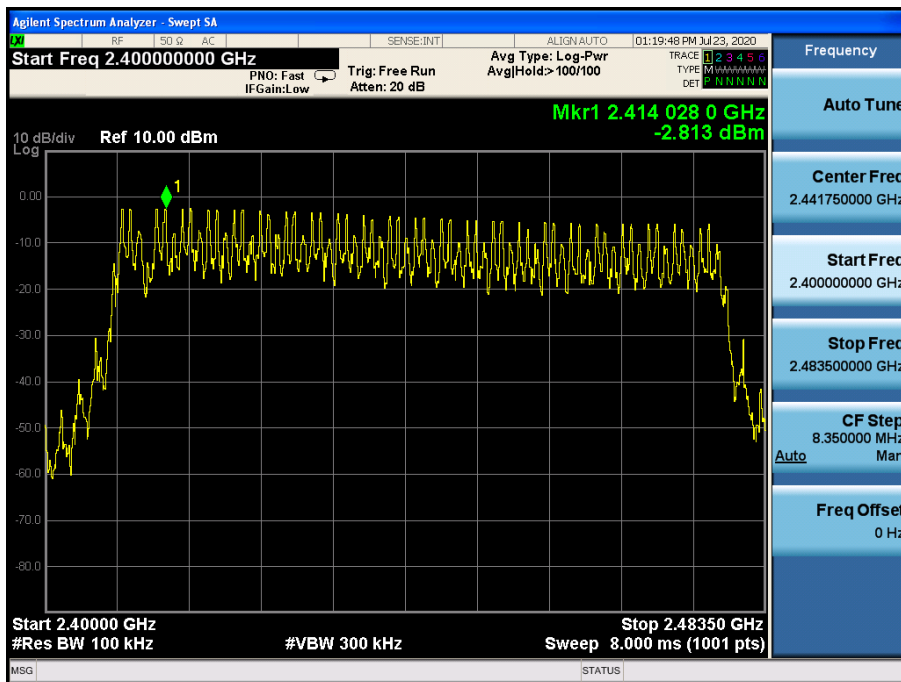

7. DWELL TIME

7.1. Test limit

Please refer section 15.247

According to §15.247(a)(1)(iii), Frequency hopping systems operating in the 2400MHz-2483.5 MHz. The average time of occupancy on any frequency shall not be greater than 0.4 s within period of 0.4 seconds multiplied by the number of hopping channels employed.

7.2. Test Procedure

7.2.1. Place the EUT on the table and set it in transmitting mode.

7.2.2. Remove the antenna from the EUT and then connect a low loss RF cable from the antenna port to the spectrum analyzer.

7.2.3. Set center frequency of spectrum analyzer = operating frequency.

7.2.4. Set the spectrum analyzer as RBW=1MHz, VBW=1MHz, Span = 0Hz, Sweep = auto.

7.2.5. Repeat above procedures until all frequency measured were complete.

7.3. Test Result

PASS.

Detailed information please see the following page.

Mode	Frequency (MHz)	Pulse Duration (ms)	Dwell Time (ms)	Limit (ms)	Conclusion
GFSK	2441	3.24	324	<400	PASS

Note: Dwell time= 100*3.24=324ms

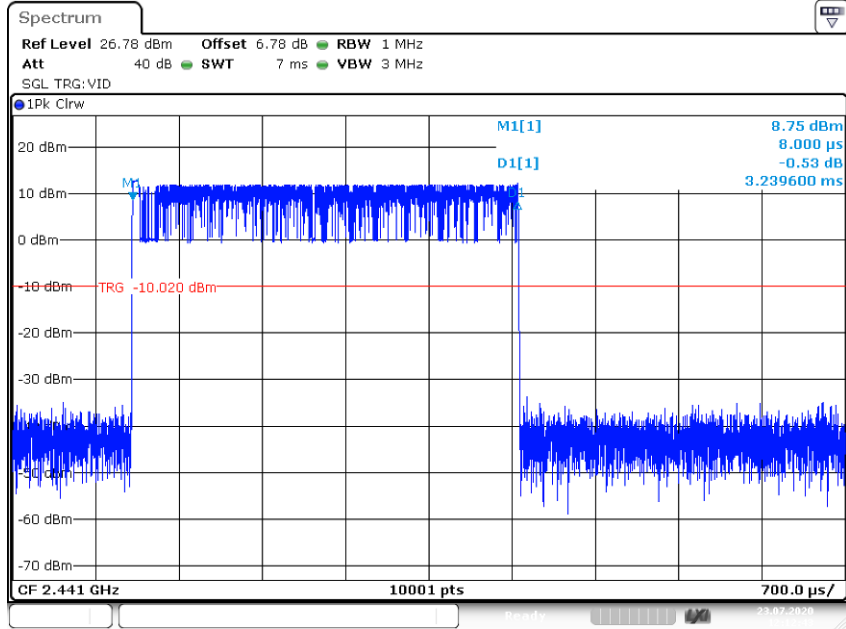

Date: 23.JUL.2020 12:12:44

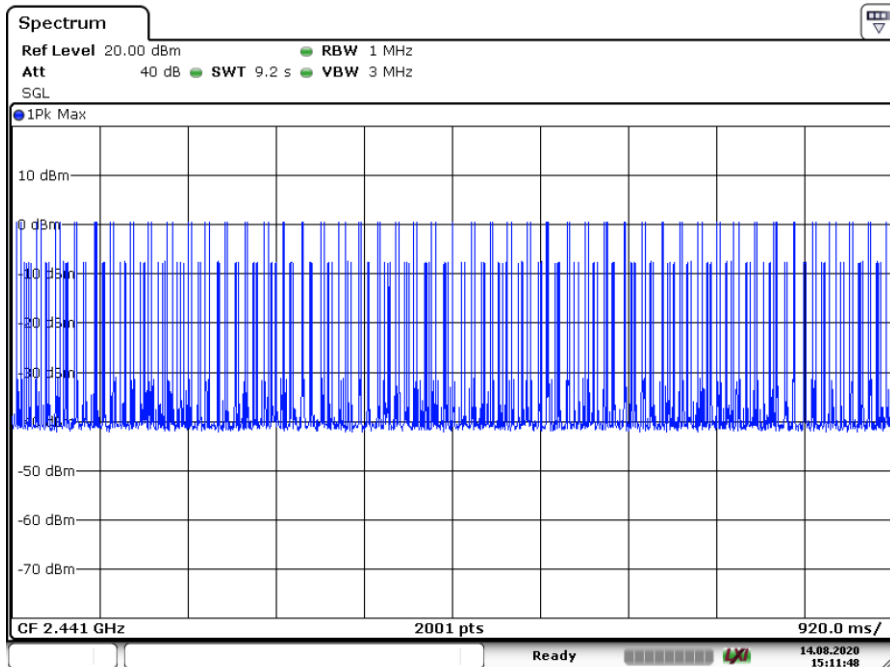

Scan time: 23*0.4=9.2s

Times: 100

8. RADIATED EMISSIONS

8.1.Limit

All the emissions appearing within 15.205 restricted frequency bands shall not exceed the limits shown in 15.209, all the other emissions shall be at least 20dB below the fundamental emissions, or comply with 15.209 limits.

15.205 Restricted frequency band

MHz	MHz	MHz	GHz
0.090 - 0.110	16.42 - 16.423	399.9 - 410	4.5 - 5.15
0.495 - 0.505	16.69475 - 16.69525	608 - 614	5.35 - 5.46
2.1735 - 2.1905	16.80425 - 16.80475	960 - 1240	7.25 - 7.75
4.125 - 4.128	25.5 - 25.67	1300 - 1427	8.025 - 8.5
4.17725 - 4.17775	37.5 - 38.25	1435 - 1626.5	9.0 - 9.2
4.20725 - 4.20775	73 - 74.6	1645.5 - 1646.5	9.3 - 9.5
6.215 - 6.218	74.8 - 75.2	1660 - 1710	10.6 - 12.7
6.26775 - 6.26825	108 - 121.94	1718.8 - 1722.2	13.25 - 13.4
6.31175 - 6.31225	123 - 138	2200 - 2300	14.47 - 14.5
8.291 - 8.294	149.9 - 150.05	2310 - 2390	15.35 - 16.2
8.362 - 8.366	156.52475 - 156.52525	2483.5 - 2500	17.7 - 21.4
8.37625 - 8.38675	156.7 - 156.9	2690 - 2900	22.01 - 23.12
8.41425 - 8.41475	162.0125 - 167.17	3260 - 3267	23.6 - 24.0
12.29 - 12.293	167.72 - 173.2	3332 - 3339	31.2 - 31.8
12.51975 - 12.52025	240 - 285	3345.8 - 3358	36.43 - 36.5
12.57675 - 12.57725	322 - 335.4	3600 - 4400	(²)

15.209 Limit

FREQUENCY MHz	DISTANCE Meters	FIELD STRENGTHS LIMIT	
		$\mu\text{V}/\text{m}$	$\text{dB}(\mu\text{V})/\text{m}$
0.009-0.490	300	2400/F(KHz)	/
0.490-1.705	30	24000/F(KHz)	/
1.705-30	30	30	29.5
30 ~ 88	3	100	40.0
88 ~ 216	3	150	43.5
216 ~ 960	3	200	46.0
960 ~ 1000	3	500	54.0
Above 1000	3	74.0 dB(μV)/m (Peak) 54.0 dB(μV)/m (Average)	

8.2. Block Diagram of Test setup

8.2.1 In 3m Anechoic Chamber Test Setup Diagram for 9KHzHz to 30MHz

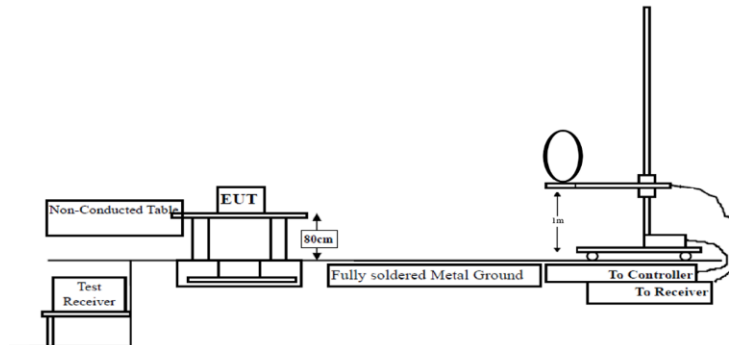

8.2.2 In 3m Anechoic Chamber Test Setup Diagram for 30MHz to 1GHz

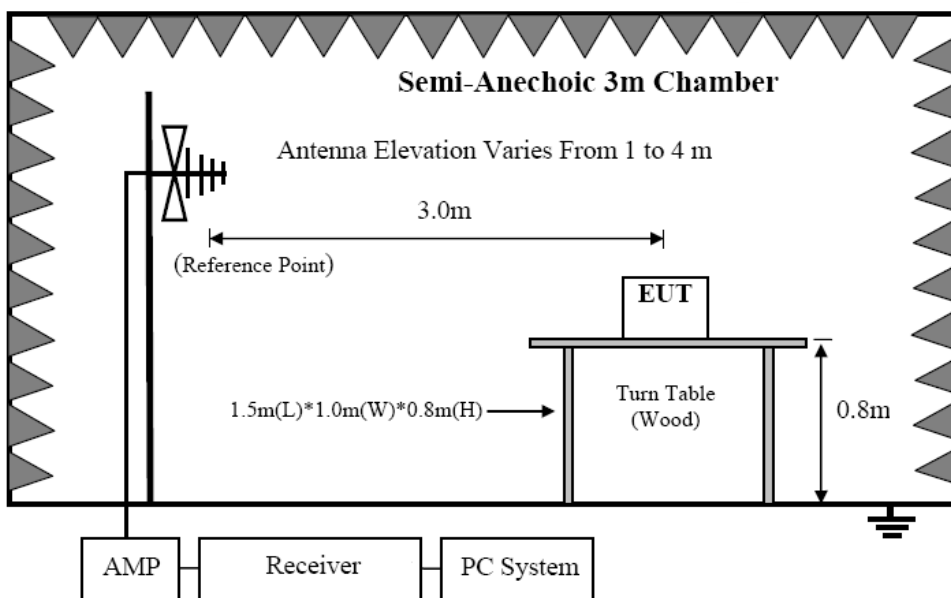

8.2.3 In 3m Anechoic Chamber Test Setup Diagram for frequency above 1GHz

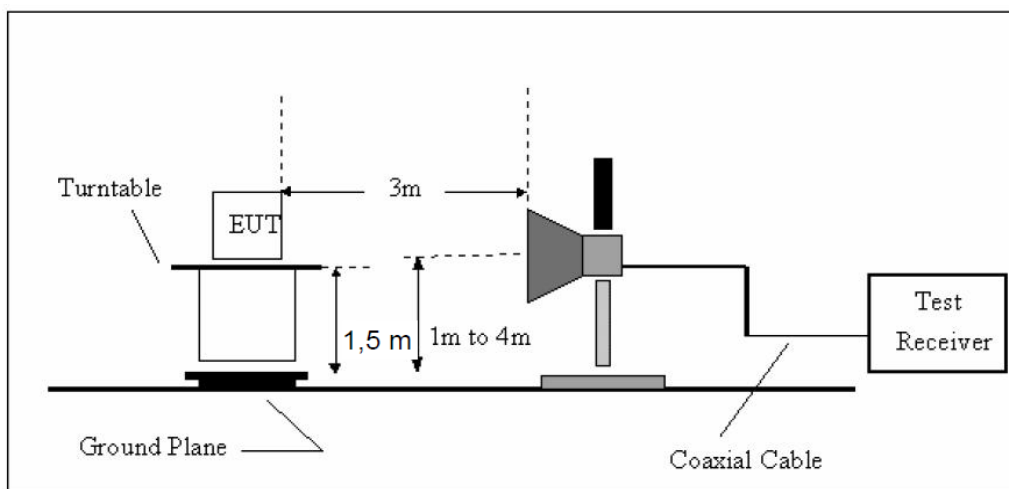

Note: For harmonic emissions test a appropriate high pass filter was inserted in the input port of AMP.

8.3. Test Procedure

- (1) EUT was placed on a non-metallic table, 80 cm above the ground plane inside a semi-anechoic chamber for below 1GHz test, 150 cm above the ground plane inside a semi-anechoic chamber for above 1GHz test
- (2) Setup EUT and simulator as shown in section 1.4 and 6.1
- (3) Test antenna was located 3m from the EUT on an adjustable mast. Below pre-scan procedure was first performed in order to find prominent radiated emissions.
 - (a) Change work frequency or channel of device if practicable.
 - (b) Change modulation type of device if practicable.
 - (c) Rotated EUT though three orthogonal axes to determine the attitude of EUT arrangement produces highest emissions
- (4) Spectrum frequency from 9KHz to 25GHz (tenth harmonic of fundamental frequency) was investigated
- (5) For final emissions measurements at each frequency of interest, the EUT were rotated and the antenna height was varied between 1m and 4m in order to maximize the emission. Measurements in both horizontal and vertical polarities were made and the data was recorded. In order to find the maximum emission, the relative positions of equipments and all of the interface cables were changed according to ANSI C63.10: 2013on Radiated Emission test.
- (6) For emissions above 1GHz, both Peak and Average level were measured with Spectrum Analyzer, and the RBW is set at 1MHz, VBW is set at 3MHz for Peak measure; RBW is set at 1MHz, VBW is set at 10Hz for Average measure.

8.4. Test Result

We have scanned the 10th harmonic from 9KHz to the EUT's highest frequency..
Detailed information please see the following page.

From 9KHz to 30MHz: Conclusion: PASS

Note: The amplitude of spurious emissions which are attenuated by more than 20dB below the permissible value has no need to be reported.

From 30MHz to 1000MHz: Conclusion: PASS

Polarization: *Vertical*

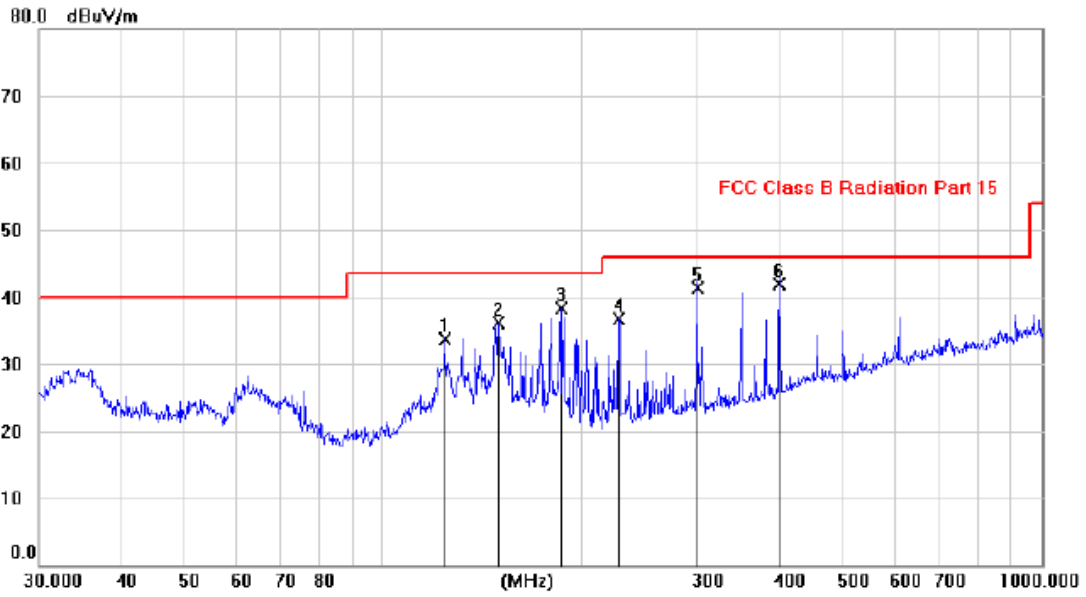

No.	Mk.	Freq.	Reading Level	Correct Factor	Measurement	Limit	Margin	Antenna Height	Table Degree	
		MHz	dBuV	dB	dBuV/m	dBuV/m	dB	cm	degree	Comment
1		124.1329	20.52	13.27	33.79	43.50	-9.71			peak
2		149.7478	21.07	15.04	36.11	43.50	-7.39			peak
3		186.1793	26.38	11.93	38.31	43.50	-5.19			peak
4		228.4103	24.56	12.22	36.78	46.00	-9.22			peak
5		300.0514	27.16	14.10	41.26	46.00	-4.74			QP
6	*	400.0108	25.58	16.24	41.82	46.00	-4.18			QP

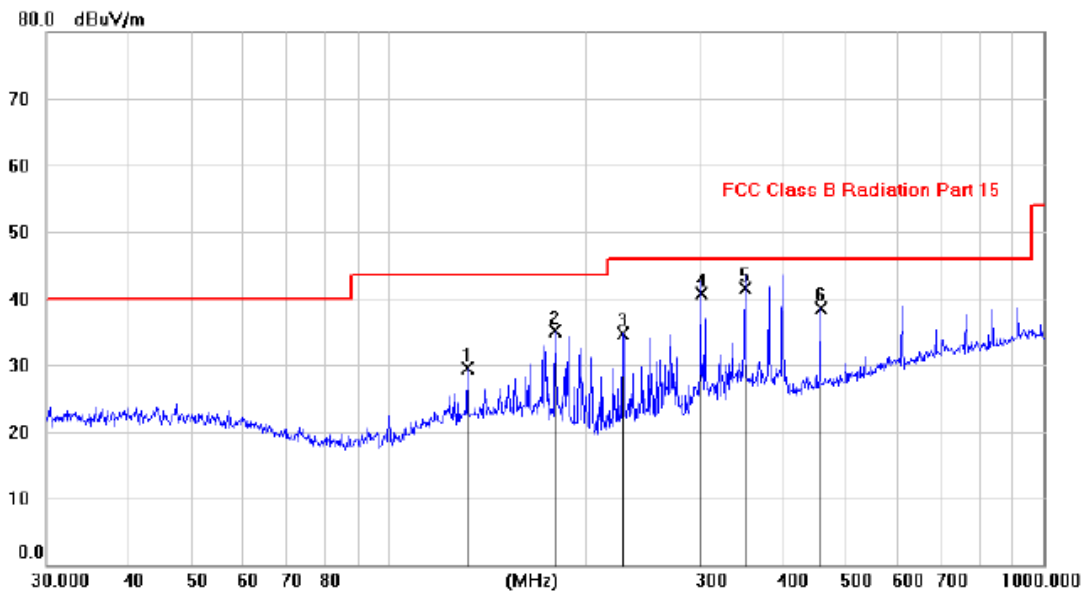
Polarization: *Horizontal*

No.	Mk.	Freq. MHz	Reading Level dBuV	Correct Factor dB	Measure- ment dBuV/m	Limit dBuV/m	Margin dB	Antenna Height cm	Table Degree	Comment
1		131.9889	15.77	13.73	29.50	43.50	-14.00			peak
2		179.8900	22.32	12.70	35.02	43.50	-8.48			peak
3		228.4103	22.46	12.22	34.68	46.00	-11.32			peak
4		300.0514	26.58	14.10	40.68	46.00	-5.32			QP
5	*	349.9854	26.20	15.23	41.43	46.00	-4.57			QP
6		456.8659	20.80	17.63	38.43	46.00	-7.57			peak

Remark: All modes have been tested, and only worst data of GFSK Channel low mode was listed in this report.

From 1G-25GHz

Test Mode: GFSK TX Low									
Freq (MHz)	Read Level (dBuV/m)	Polar (H/V)	Antenna Factor (dB/m)	Cable loss(dB)	Amp Factor (dB)	Result (dBuV/m)	Limit (dBuV/m)	Margin (dB)	Remark
4820	42.57	V	33.98	10.22	34.25	52.52	74	21.48	PK
4820	32.45	V	33.98	10.22	34.25	42.40	54	11.60	AV
7230	/	V	33.98	10.22	34.25	/	74	/	/
9620	/	V	33.98	10.22	34.25	/	74	/	/
4820	42.25	H	33.98	10.22	34.25	52.20	74	21.80	PK
4820	31.50	H	33.98	10.22	34.25	41.45	54	12.55	AV
7230	/	H	33.98	10.22	34.25	/	74	/	/
9620	/	H	33.98	10.22	34.25	/	74	/	/
Test Mode: GFSK TX Mid									
4882	42.06	V	33.98	10.22	34.25	52.01	74	21.99	PK
4882	32.81	V	33.98	10.22	34.25	42.76	54	11.24	AV
7323	/	V	33.98	10.22	34.25	/	74	/	/
9764	/	V	33.98	10.22	34.25	/	74	/	/
4882	42.51	H	33.98	10.22	34.25	52.46	74	21.54	PK
4882	31.38	H	33.98	10.22	34.25	41.33	54	12.67	AV
7323	/	H	33.98	10.22	34.25	/	74	/	/
9764	/	H	33.98	10.22	34.25	/	74	/	/
Test Mode: GFSK TX High									
4954	42.64	V	33.98	10.22	34.25	52.59	74	21.41	PK
4954	32.66	V	33.98	10.22	34.25	42.61	54	11.39	AV
7431	/	V	33.98	10.22	34.25	/	74	/	/
9912	/	V	33.98	10.22	34.25	/	74	/	/
4954	42.20	H	33.98	10.22	34.25	52.15	74	21.85	PK
4954	32.09	H	33.98	10.22	34.25	42.04	54	11.96	AV
7431	/	H	33.98	10.22	34.25	/	74	/	/
9912	/	H	33.98	10.22	34.25	/	74	/	/
Note:									
1, Result = Read level + Antenna factor + cable loss-Amp factor									
2, All the other emissions not reported were too low to read and deemed to comply with FCC limit.									

9. BAND EDGE COMPLIANCE

9.1. Block Diagram of Test Setup

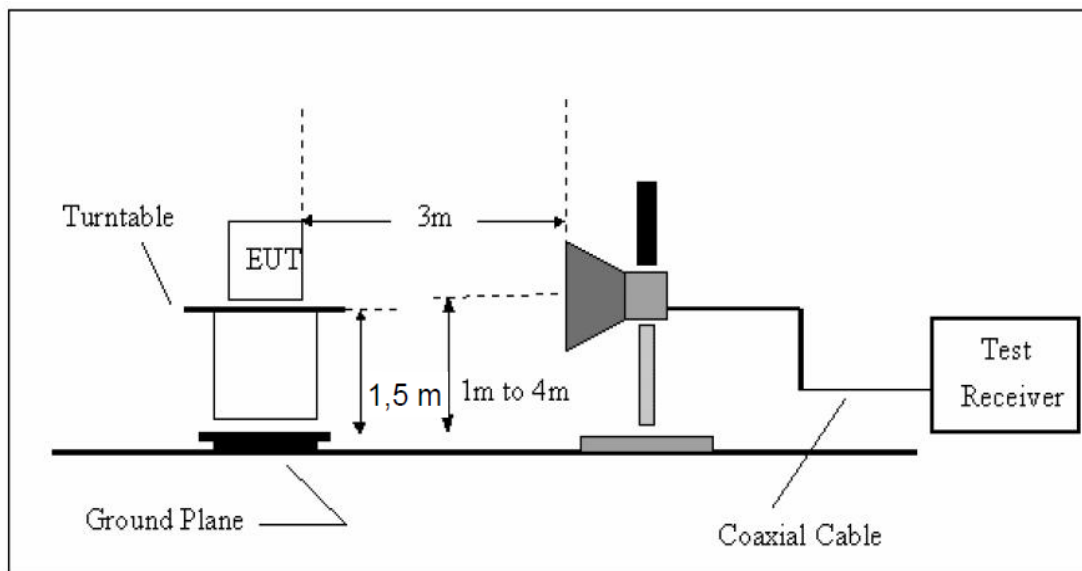

9.2. Limit

All the lower and upper band-edges emissions appearing within restricted frequency bands shall not exceed the limits shown in 15.209, all the other emissions outside operation shall be at least 20dB below the fundamental emissions, or comply with 15.209 limits.

9.3. Test Procedure

All restriction band and non- restriction band have been tested , only worse case is reported.

9.4. Test Result

PASS. (See below detailed test data)

No-hopping
CH-L

Horizontally

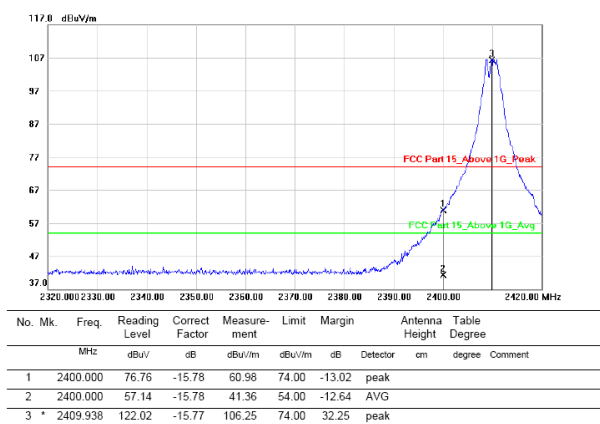

Vertically

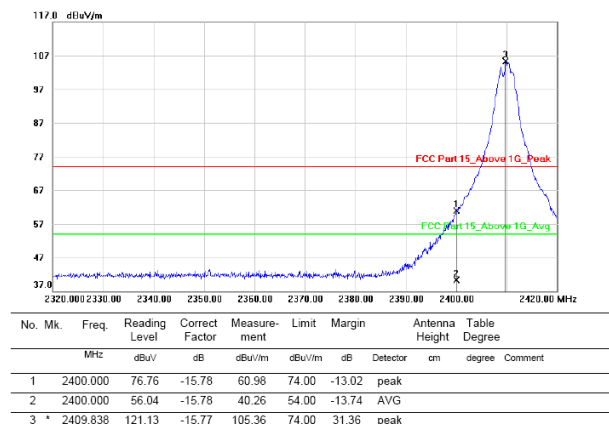

CH-H

Horizontally

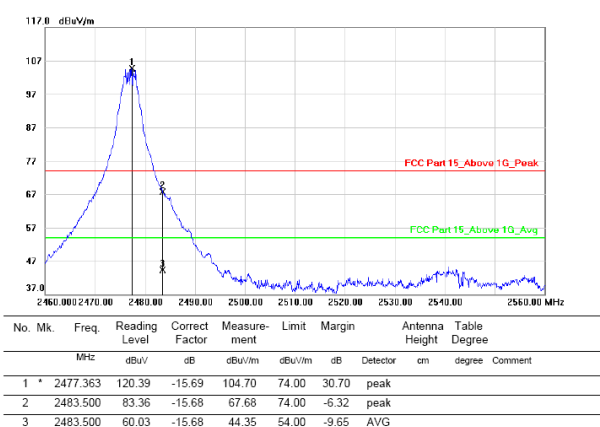

Vertically

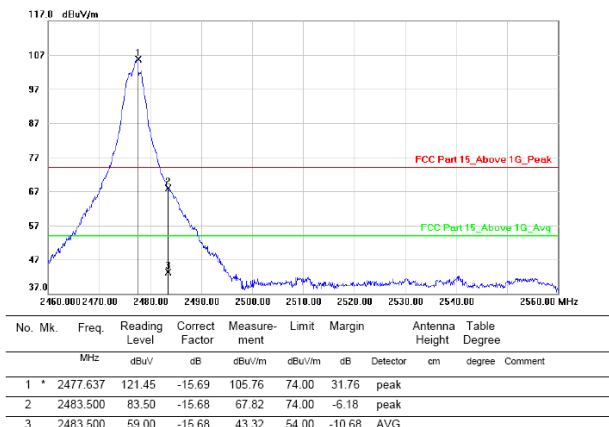

Hopping
CH-L

Horizontally

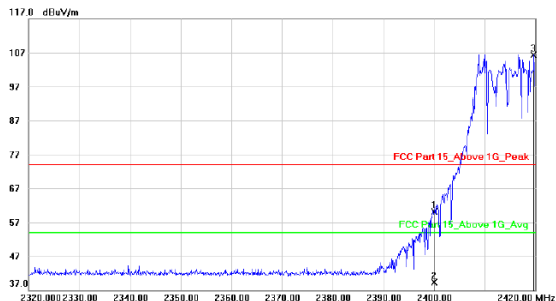

No.	Mk.	Freq.	Reading Level	Correct Factor	Measurement	Limit	Margin	Antenna Height	Table Degree	Comment
		MHz	dBuV	dB	dBuV/m	dBuV/m	dB	cm	degree	
1	*	2400.000	75.91	-15.78	60.13	74.00	-13.87			peak
2		2400.000	54.99	-15.78	39.21	54.00	-14.79			AVG
3	*	2419.725	122.02	-15.76	106.26	74.00	32.26			peak

Vertically

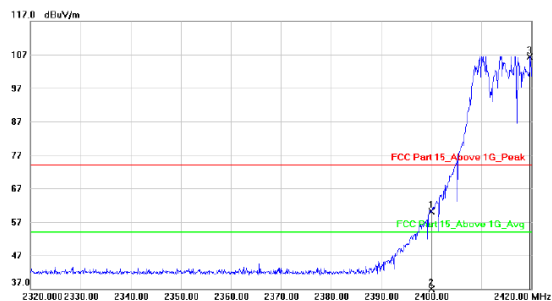

No.	Mk.	Freq.	Reading Level	Correct Factor	Measurement	Limit	Margin	Antenna Height	Table Degree	Comment
		MHz	dBuV	dB	dBuV/m	dBuV/m	dB	cm	degree	
1		2400.000	75.96	-15.78	60.18	74.00	-13.82			peak
2		2400.000	52.04	-15.78	36.26	54.00	-17.74			AVG
3	*	2419.713	122.02	-15.76	106.26	74.00	32.26			peak

CH-H

Horizontally

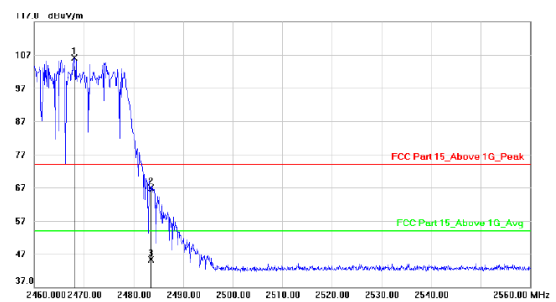

No.	Mk.	Freq.	Reading Level	Correct Factor	Measurement	Limit	Margin	Antenna Height	Table Degree	Comment
		MHz	dBuV	dB	dBuV/m	dBuV/m	dB	cm	degree	
1	*	2468.113	121.80	-15.71	106.09	74.00	32.09			peak
2		2483.500	82.58	-15.68	66.90	74.00	-7.10			peak
3		2483.500	60.91	-15.68	45.23	54.00	-8.77			AVG

Vertically

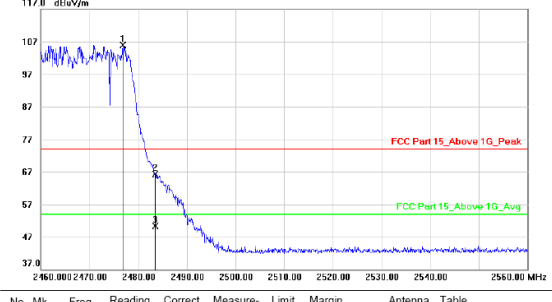

No.	Mk.	Freq.	Reading Level	Correct Factor	Measurement	Limit	Margin	Antenna Height	Table Degree	Comment
		MHz	dBuV	dB	dBuV/m	dBuV/m	dB	cm	degree	
1	*	2476.838	121.50	-15.69	105.81	74.00	31.81			peak
2		2483.500	82.00	-15.68	66.32	74.00	-7.68			peak
3		2483.500	65.94	-15.68	50.26	54.00	-3.74			AVG

No-hopping

CH-L

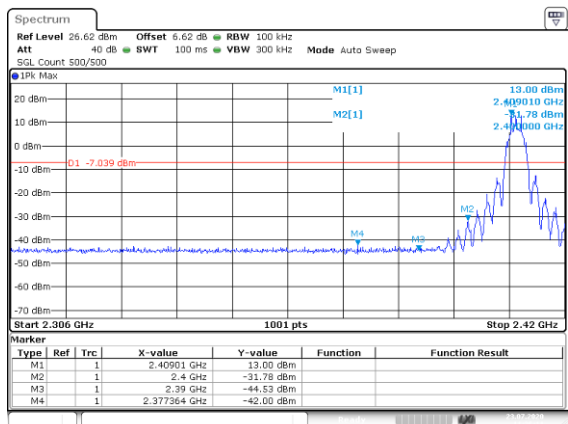

CH-H

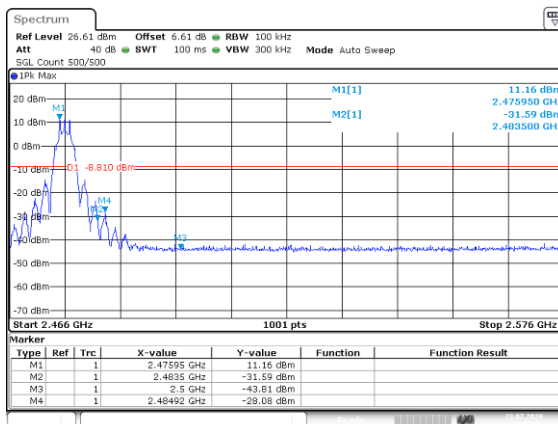

Hopping

CH-L

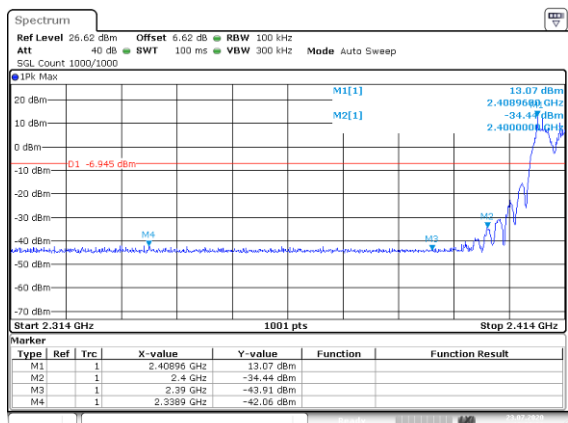

CH-H

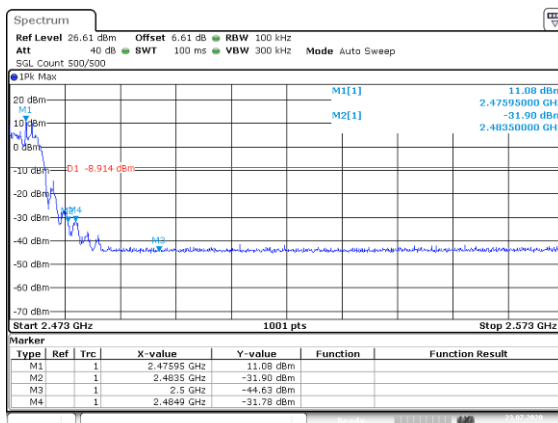

10. POWER LINE CONDUCTED EMISSIONS

10.1. Block Diagram of Test Setup

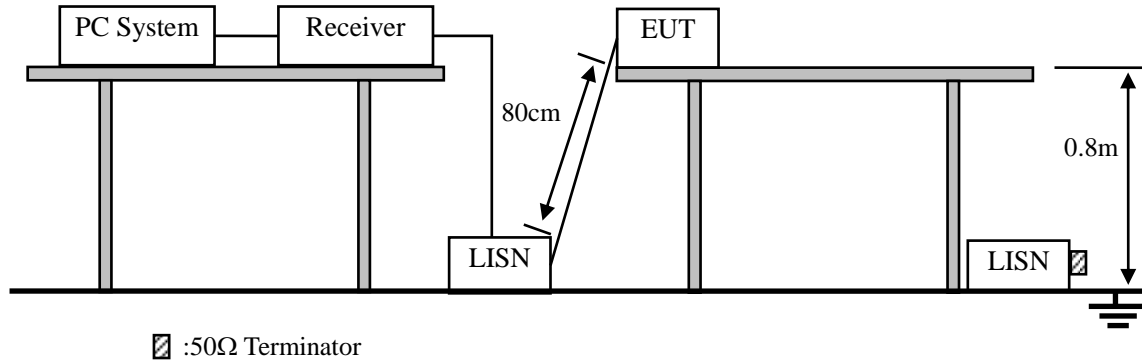

☒ :50Ω Terminator

10.2. Limit

Frequency	Maximum RF Line Voltage	
	Quasi-Peak Level dB(μV)	Average Level dB(μV)
150kHz ~ 500kHz	66 ~ 56*	56 ~ 46*
500kHz ~ 5MHz	56	46
5MHz ~ 30MHz	60	50

Notes: 1. * Decreasing linearly with logarithm of frequency.

2. The lower limit shall apply at the transition frequencies.

10.3. Test Procedure

- (1) The EUT was placed on a non-metallic table, 80cm above the ground plane.
- (2) Setup the EUT and simulator as shown in 10.1
- (3) The EUT Power connected to the power mains through a power adapter and a line impedance stabilization network (L.I.S.N1). The other peripheral devices power cord connected to the power mains through a line impedance stabilization network (L.I.S.N2), this provided a 50-ohm coupling impedance for the EUT (Please refer to the block diagram of the test setup and photographs). Both sides of power line were checked for maximum conducted interference. In order to find the maximum emission, the relative positions of equipments and all of the interface cables were changed according to ANSI C63.10: 2013on conducted Emission test.
- (4) The bandwidth of test receiver is set at 10KHz.
- (5) The frequency range from 150 KHz to 30MHz is checked.

10.4. Test Result

Pass

The results are shown on the next page.

Polarization: *L*

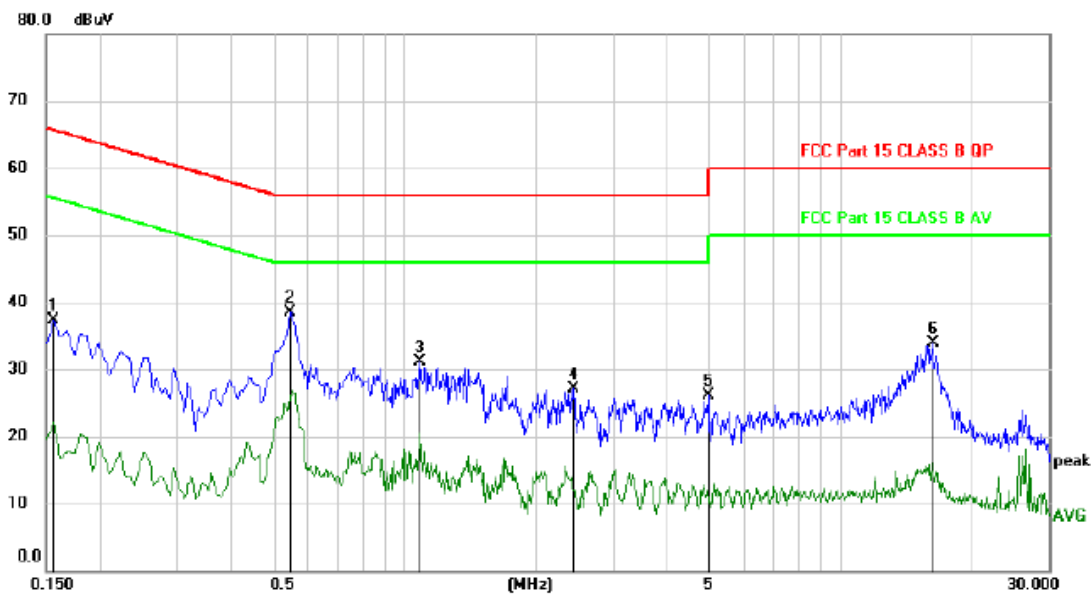

No. Mk.	Freq. MHz	Reading Level dBuV	Correct Factor dB	Measurement dBuV	Limit dBuV	Margin dB	Detector	Comment
1	0.1560	27.43	9.94	37.37	65.67	-28.30	peak	
2 *	0.5460	28.57	9.94	38.51	56.00	-17.49	peak	
3	1.0859	21.23	9.91	31.14	56.00	-24.86	peak	
4	2.4360	17.12	9.90	27.02	56.00	-28.98	peak	
5	4.9680	16.10	10.04	26.14	56.00	-29.86	peak	
6	16.2300	23.46	10.36	33.82	60.00	-26.18	peak	

Polarization: **N**

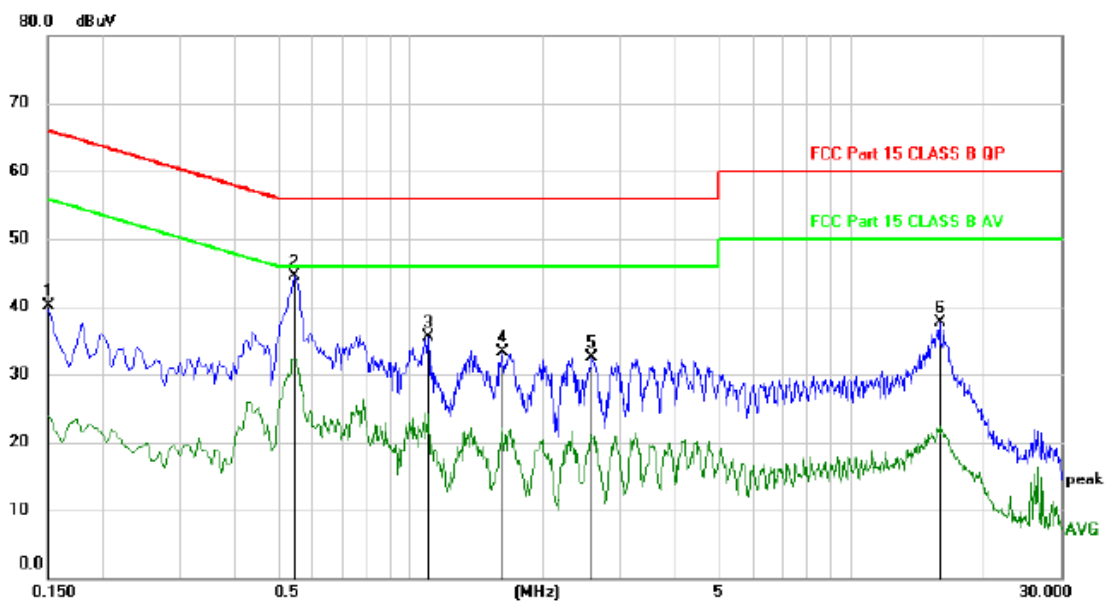

No. Mk.	Freq. MHz	Reading Level dBuV	Correct Factor dB	Measurement dBuV	Limit dBuV	Margin dB	Detector	Comment
1	0.1500	30.10	9.94	40.04	66.00	-25.96	peak	
2 *	0.5460	34.54	9.94	44.48	56.00	-11.52	peak	
3	1.0980	25.58	9.91	35.49	56.00	-20.51	peak	
4	1.6140	23.43	9.90	33.33	56.00	-22.67	peak	
5	2.5860	22.52	9.92	32.44	56.00	-23.56	peak	
6	15.9000	27.29	10.36	37.65	60.00	-22.35	peak	

Remark: All modes have been tested, and only worst data of GFSK Channel low mode was listed in this report.

11. ANTENNA REQUIREMENTS

11.1. Limit

For intentional device, according to FCC 47 CFR Section 15.203, an intentional radiator shall be designed to ensure that no antenna other than that furnished by the responsible party shall be used with the device. And according to FCC 47 CFR Section 15.247 (b), if transmitting antennas of directional gain greater than 6dBi are used, the power shall be reduced by the amount in dB that the directional gain of the antenna exceeds 6dBi.

11.2. Result

The EUT antenna is fixed antenna. It complies with the standard requirement.

12. TEST SETUP PHOTO

12.1. Photos of Radiated emission

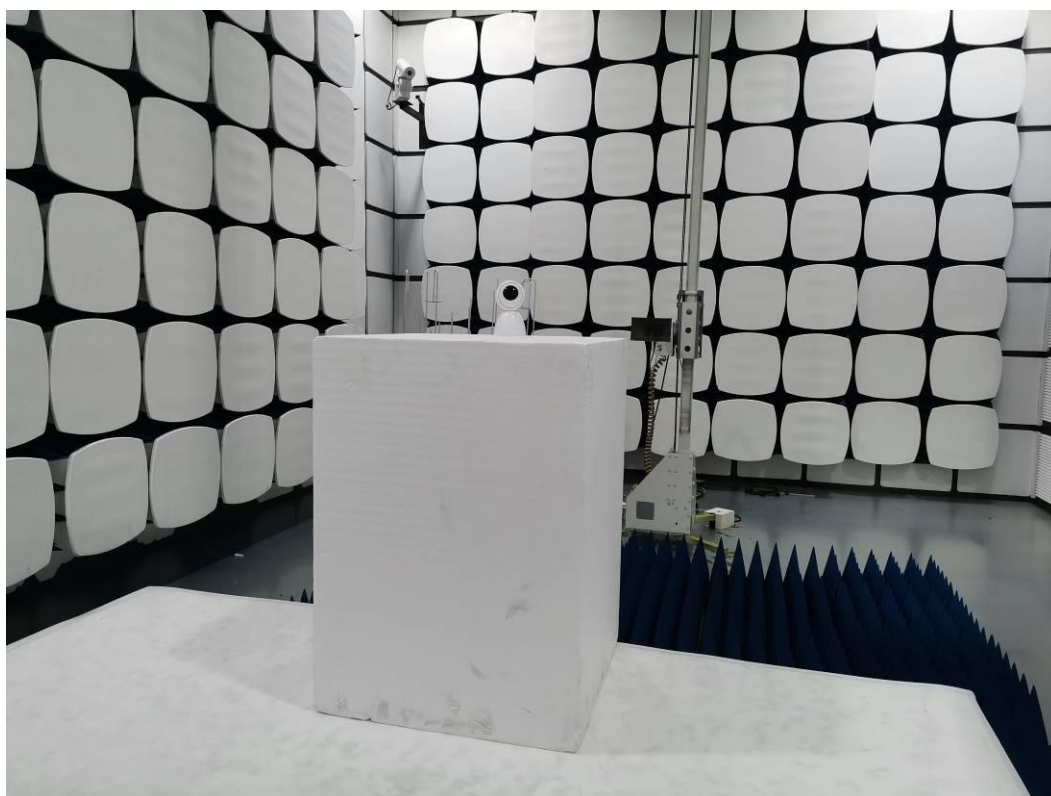
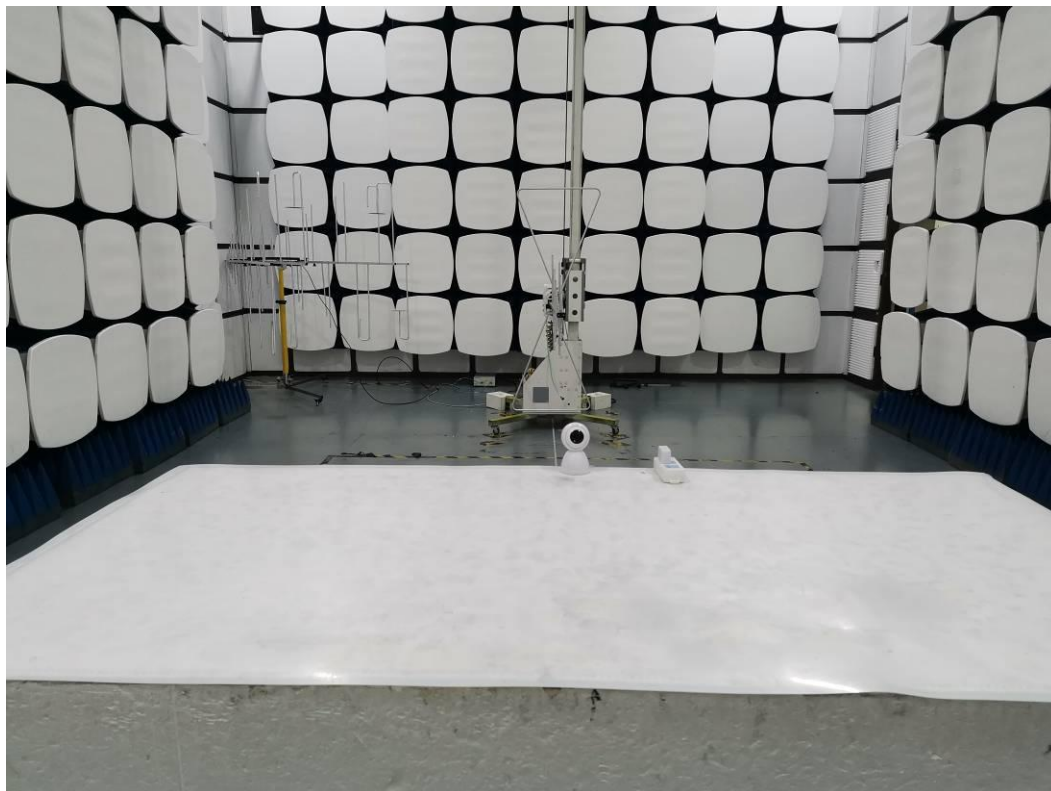

12.2.Photos of Power Line Conducted Emission Test

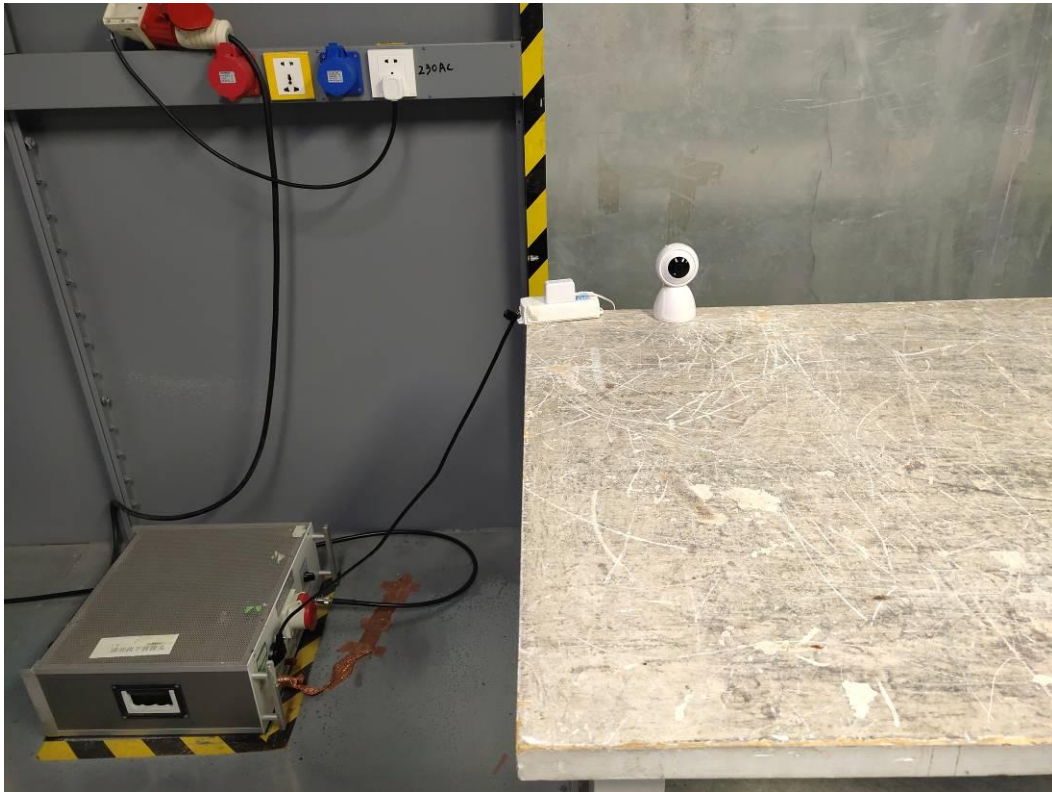

13. PHOTOS OF EUT



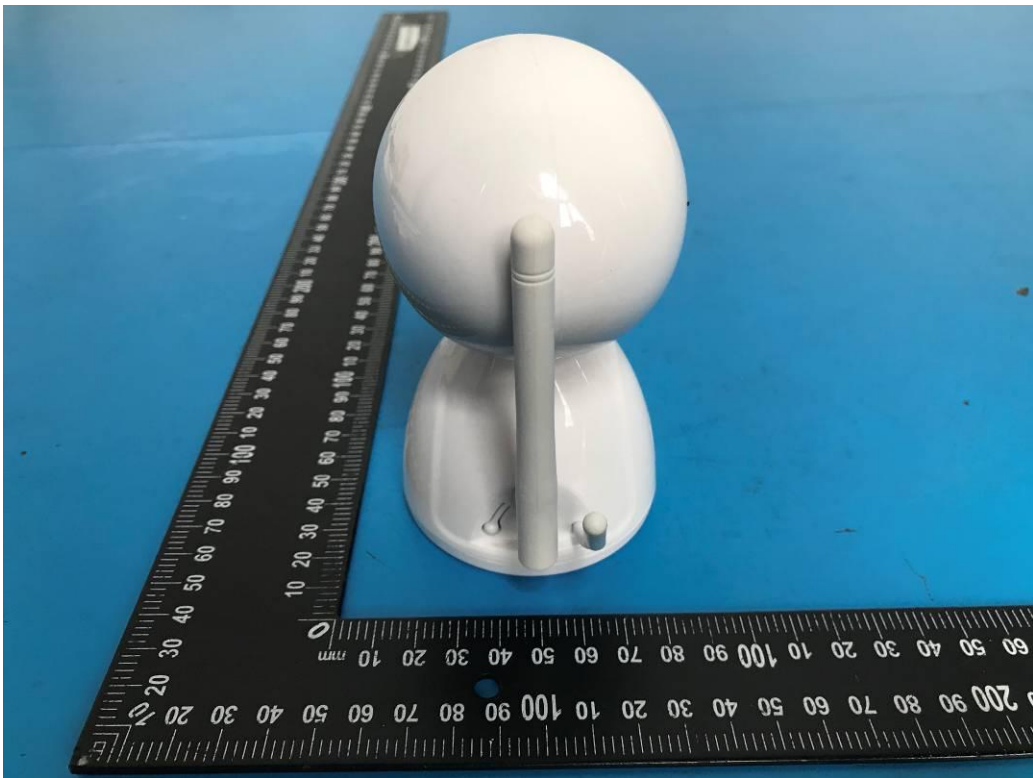

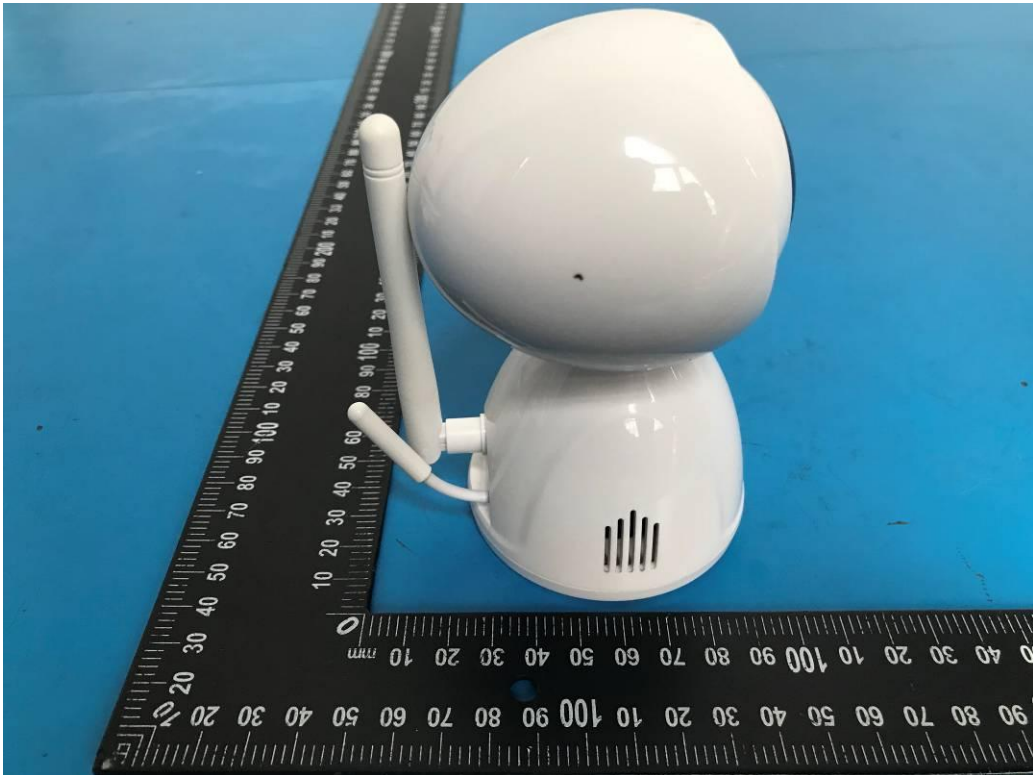



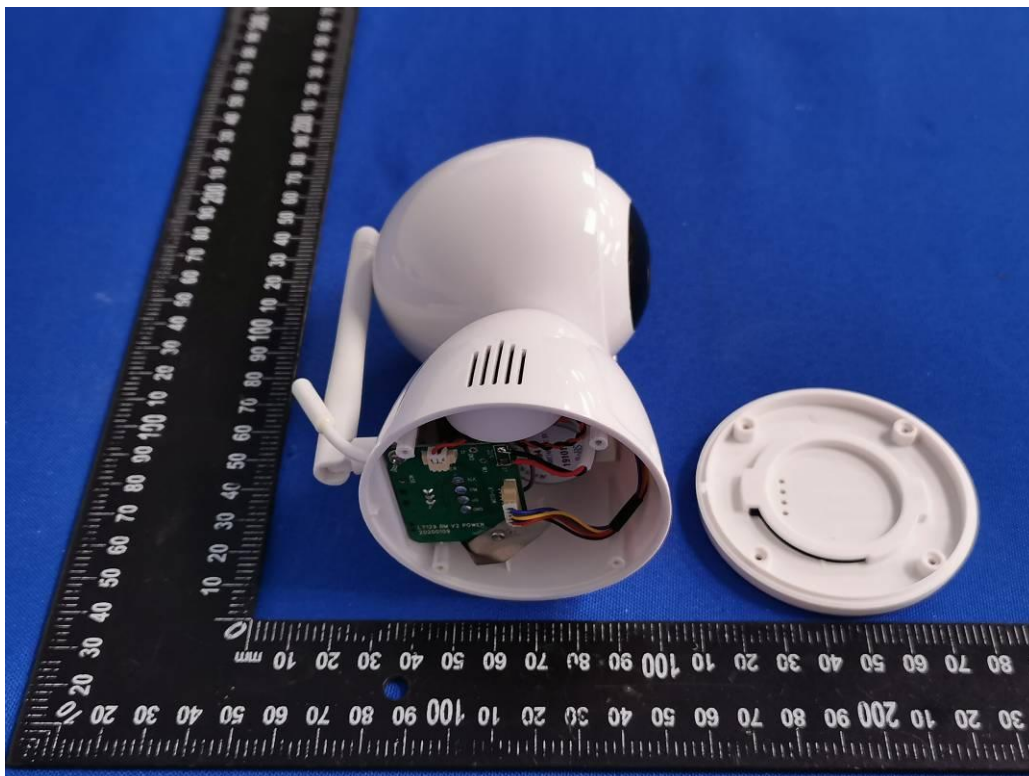

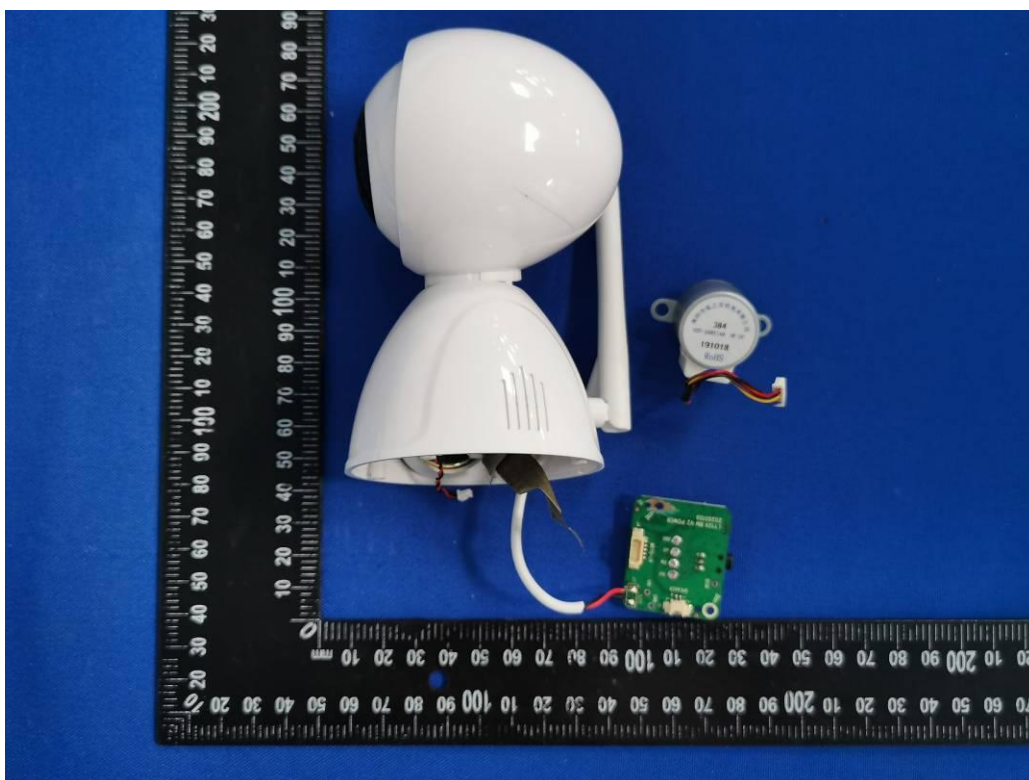
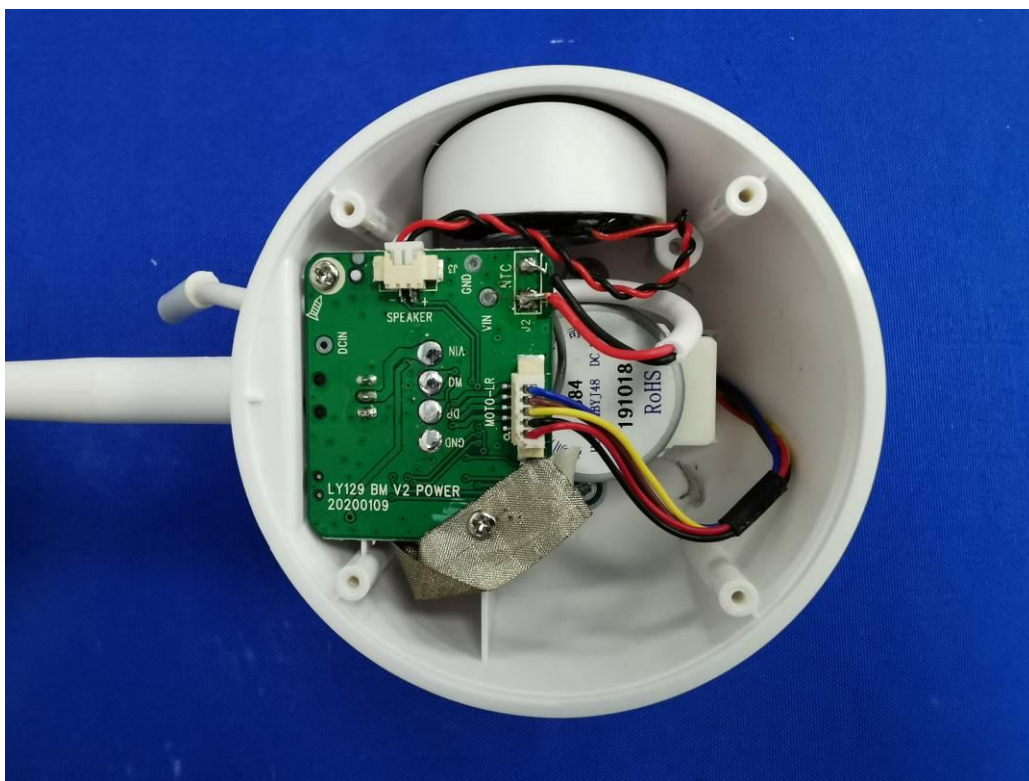

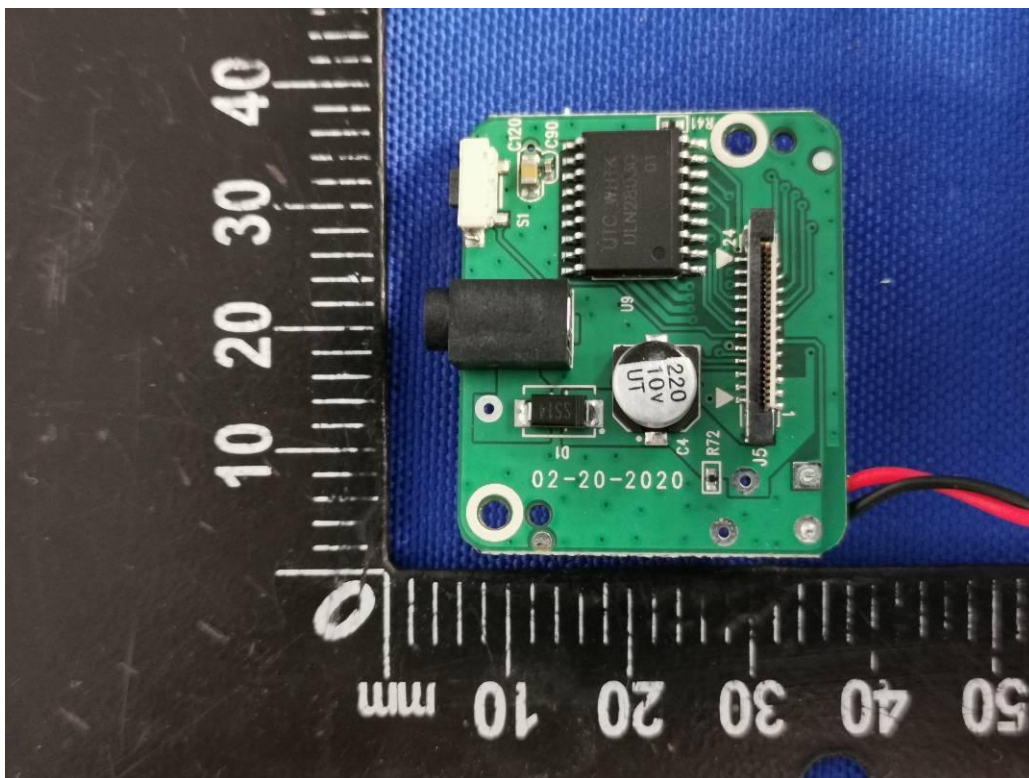
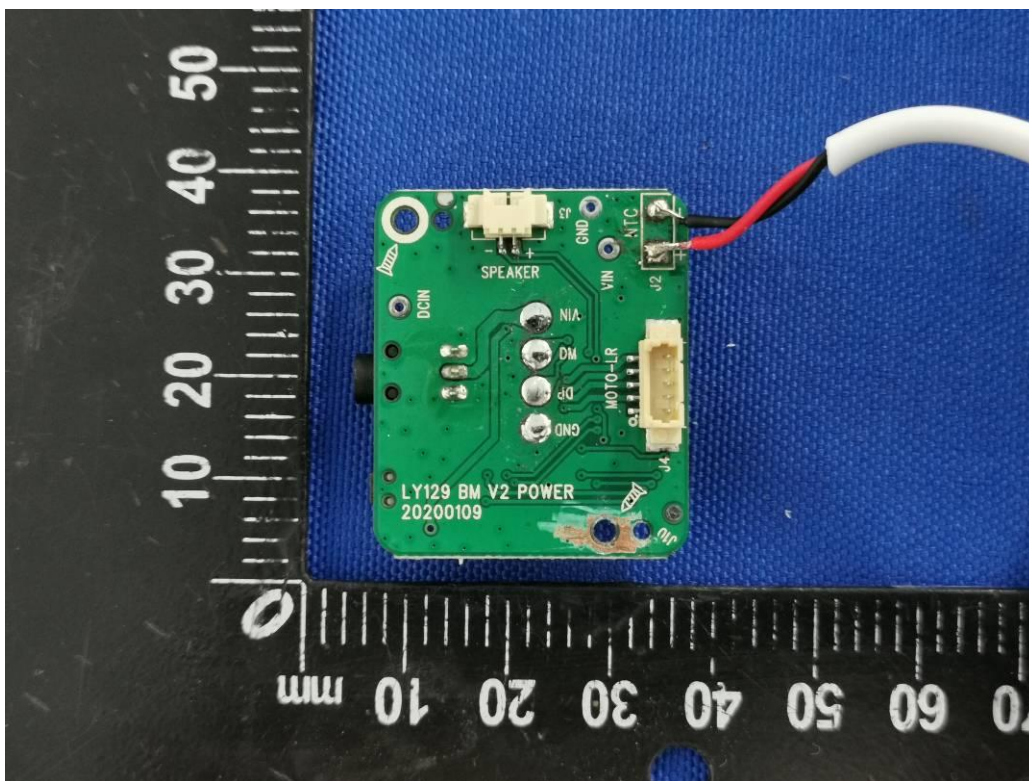

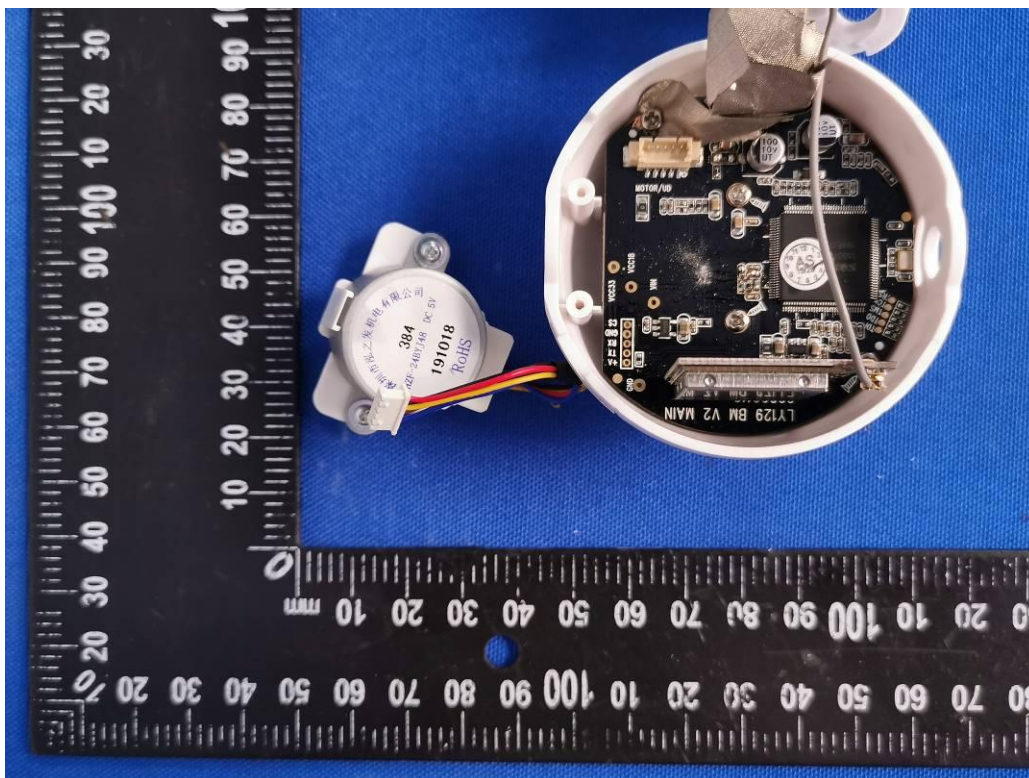
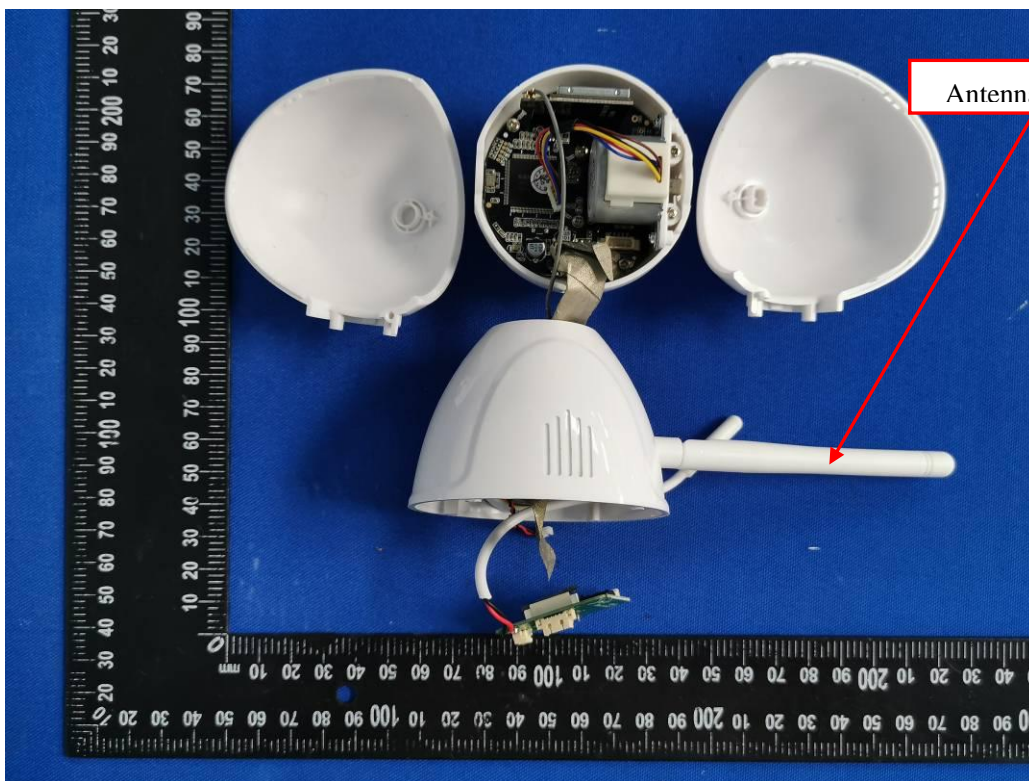

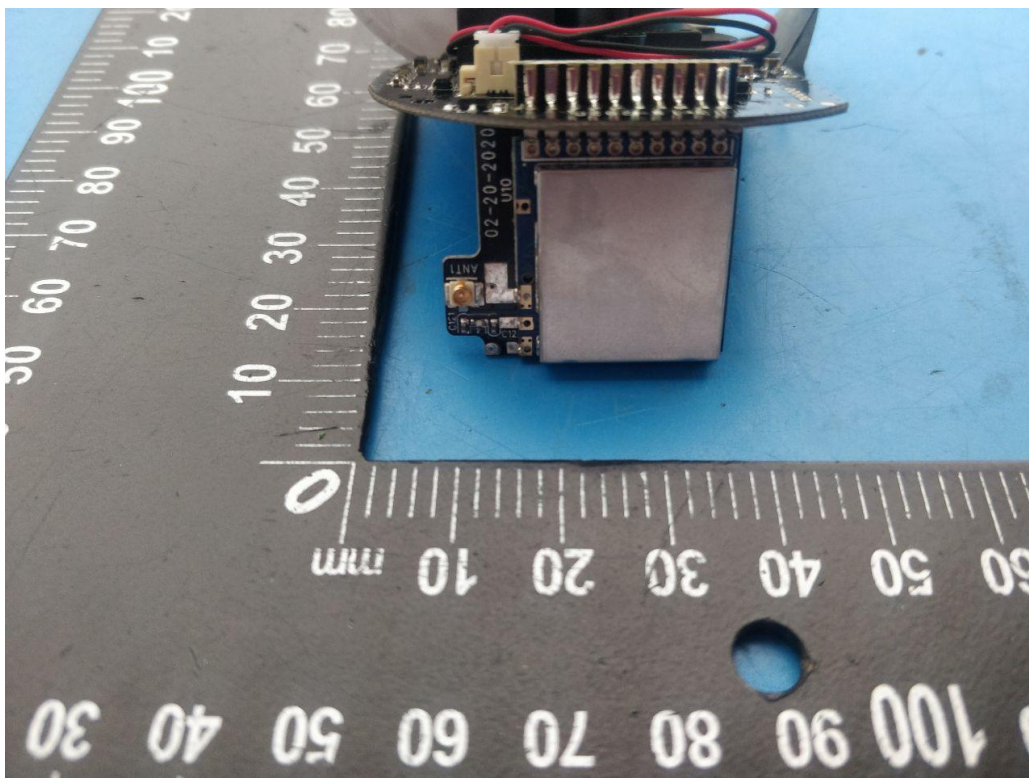

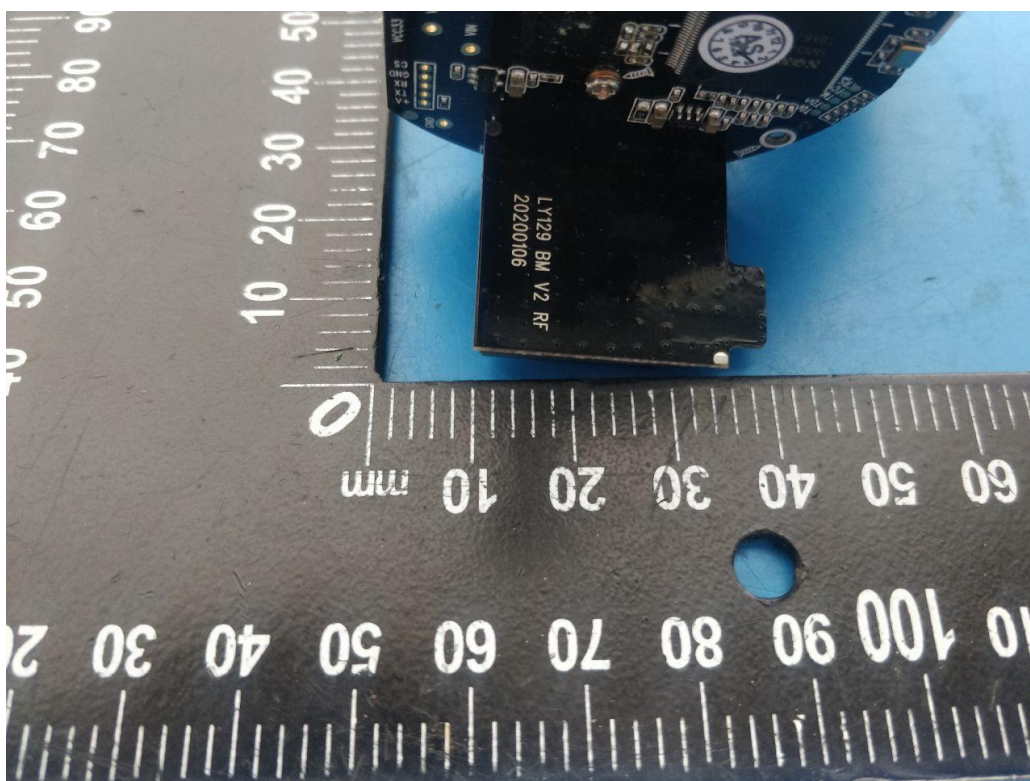
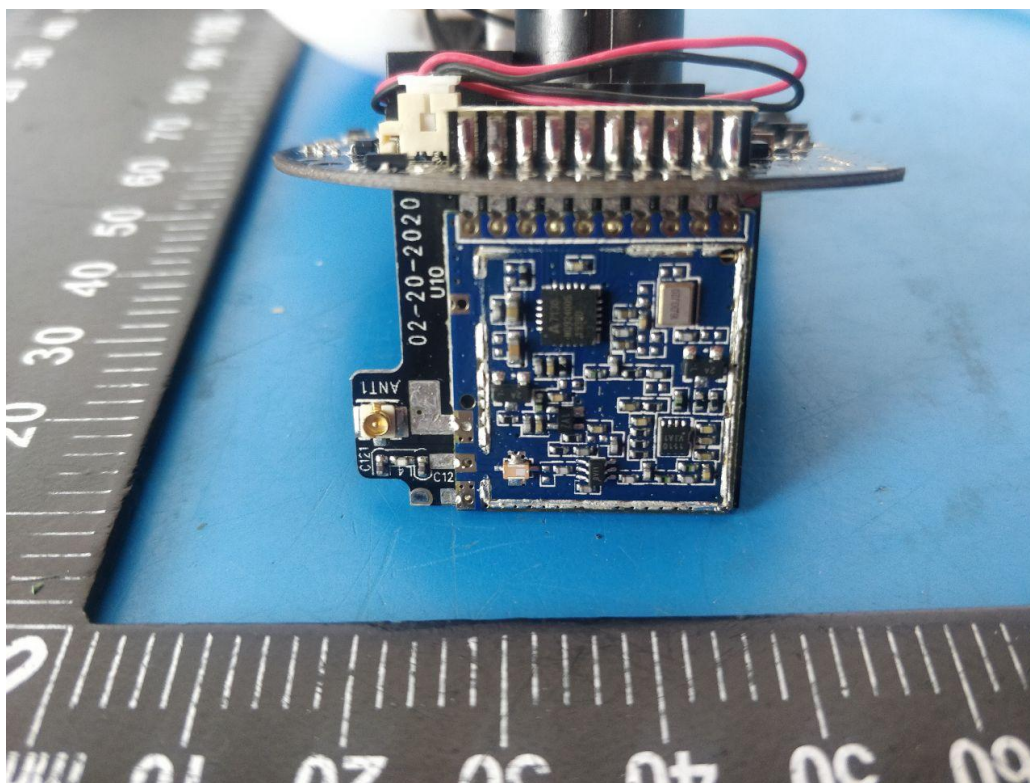

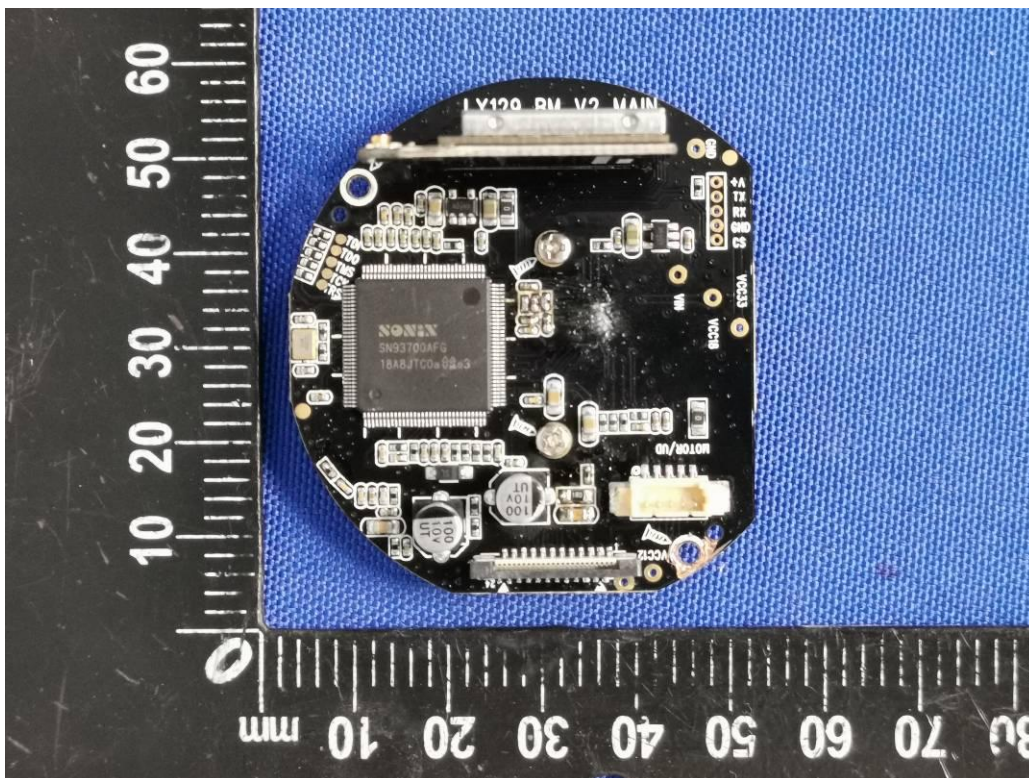
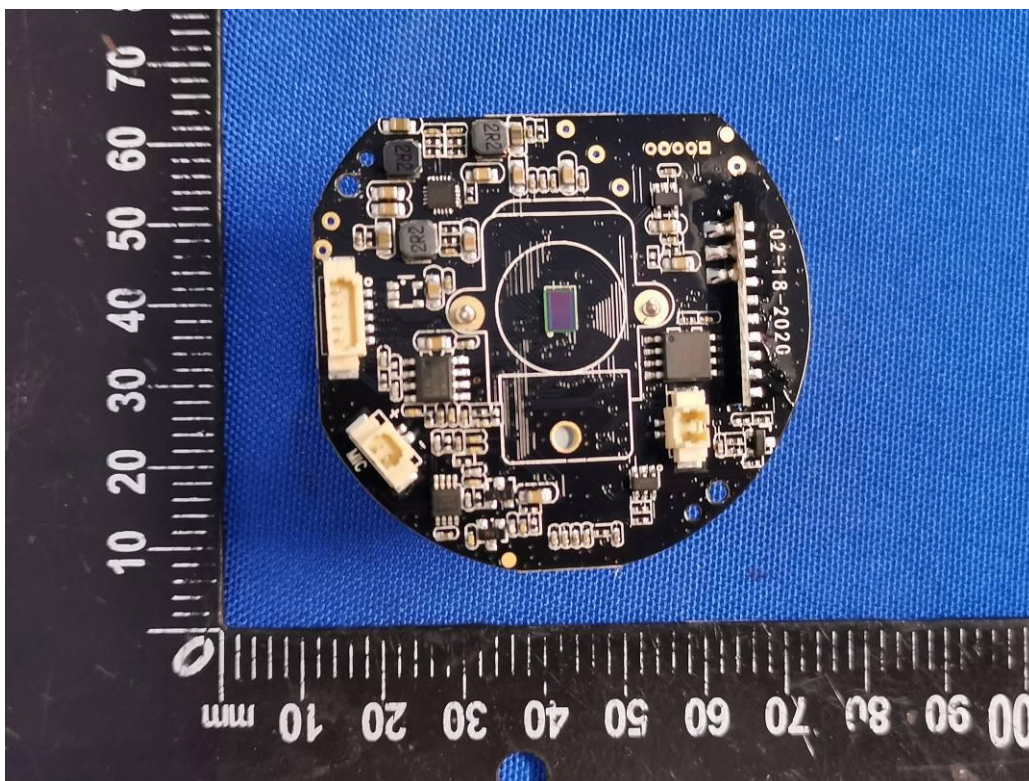

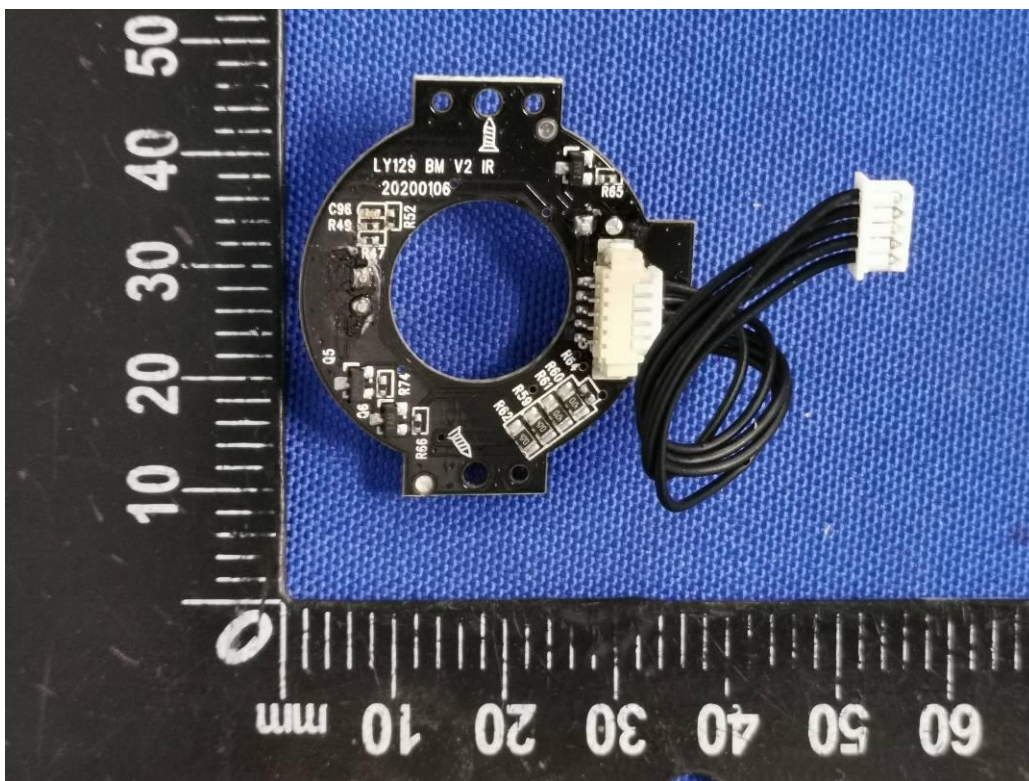

-----THE END OF REPORT-----