

FCC Report (WIFI)

Applicant: Shenzhen SDMC Technology Co., Ltd

Address of Applicant: 7/F, W2-A Bld, Gaoxin S. Av. 4, Hi-tech Park, Nanshan, Shenzhen, China

Equipment Under Test (EUT)

Product Name: Play STB

Model No.: DV7819, MAS707

Trade Mark: SDMC

FCC ID: 2AFC2-DV7819

Applicable standards: FCC CFR Title 47 Part 15 Subpart C Section 15.247:2014

Date of sample receipt: August 12, 2015

Date of Test: August 13-14, 2015

Date of report issued: August 17, 2015

Test Result : PASS *

* In the configuration tested, the EUT complied with the standards specified above.

Authorized Signature:

A circular logo for GTS Global Testing Services Co., Ltd. is overlaid with a handwritten signature in black ink. The logo contains the text 'GTS', 'GLOBAL TESTING', and 'TECHNOLOGY SERVICES CO., LTD.' around the perimeter.

Robinson Lo

Laboratory Manager

This report details the results of the testing carried out on one sample. The results contained in this test report do not relate to other samples of the same product and does not permit the use of the GTS product certification mark. The manufacturer should ensure that all products in series production are in conformity with the product sample detailed in this report.

This report may only be reproduced and distributed in full. If the product in this report is used in any configuration other than that detailed in the report, the manufacturer must ensure the new system complies with all relevant standards. Any mention of GTS or testing done by GTS in connection with, distribution or use of the product described in this report must be approved by GTS in writing.

This document cannot be reproduced except in full, without prior written approval of the Company. Any unauthorized alteration, forgery or falsification of the content or appearance of this document is unlawful and offenders may be prosecuted to the fullest extent of the law. Unless otherwise stated the results shown in this test report refer only to the sample(s) tested and such sample(s) are retained for 90 days only.

2 Version

Version No.	Date	Description
00	August 17, 2015	Original

Prepared By: Sam. Gao **Date:** August 17, 2015
Project Engineer

Check By: Hank. yan **Date:** August 17, 2015
Reviewer

3 Contents

	Page
1 COVER PAGE.....	1
2 VERSION.....	2
3 CONTENTS	3
4 TEST SUMMARY	4
4.1 MEASUREMENT UNCERTAINTY	4
5 GENERAL INFORMATION.....	5
5.1 CLIENT INFORMATION	5
5.2 GENERAL DESCRIPTION OF EUT	5
5.3 TEST MODE	6
5.4 DESCRIPTION OF SUPPORT UNITS	6
5.5 TEST FACILITY.....	7
5.6 TEST LOCATION	7
6 TEST INSTRUMENTS LIST	8
7 TEST RESULTS AND MEASUREMENT DATA.....	9
7.1 ANTENNA REQUIREMENT	9
7.2 CONDUCTED EMISSIONS	10
7.3 CONDUCTED PEAK OUTPUT POWER.....	13
7.4 CHANNEL BANDWIDTH	15
7.5 POWER SPECTRAL DENSITY	24
7.6 BAND EDGES.....	33
7.6.1 Conducted Emission Method.....	33
7.6.2 Radiated Emission Method.....	38
7.7 SPURIOUS EMISSION.....	43
7.7.1 Conducted Emission Method.....	43
7.7.2 Radiated Emission Method.....	52
8 TEST SETUP PHOTO	67
9 EUT CONSTRUCTIONAL DETAILS	69

4 Test Summary

Test Item	Section in CFR 47	Result
Antenna requirement	15.203/15.247 (c)	Pass
AC Power Line Conducted Emission	15.207	Pass
Conducted Peak Output Power	15.247 (b)(3)	Pass
Channel Bandwidth	15.247 (a)(2)	Pass
Power Spectral Density	15.247 (e)	Pass
Band Edge	15.247(d)	Pass
Spurious Emission	15.205/15.209	Pass

Pass: The EUT complies with the essential requirements in the standard.

Remark: Test according to ANSI C63.4-2014 and ANSI C63.10-2013

4.1 Measurement Uncertainty

Test Item	Frequency Range	Measurement Uncertainty	Notes
Radiated Emission	9kHz ~ 30MHz	± 4.34dB	(1)
Radiated Emission	30MHz ~ 1000MHz	± 4.24dB	(1)
Radiated Emission	1GHz ~ 26.5GHz	± 4.68dB	(1)
AC Power Line Conducted Emission	0.15MHz ~ 30MHz	± 3.45dB	(1)

Note (1): The measurement uncertainty is for coverage factor of k=2 and a level of confidence of 95%.

5 General Information

5.1 Client Information

Applicant:	Shenzhen SDMC Technology Co., Ltd
Address of Applicant:	7/F, W2-A Bld, Gaoxin S. Av. 4, Hi-tech Park, Nanshan, Shenzhen, China
Manufacturer/Factory:	Shenzhen SDMC Technology Co., Ltd
Address of Manufacturer/Factory:	7/F, W2-A Bld, Gaoxin S. Av. 4, Hi-tech Park, Nanshan, Shenzhen, China

5.2 General Description of EUT

Product Name:	Play STB
Model No.:	DV7819, MAS707
Operation Frequency:	802.11b/802.11g/802.11n(HT20): 2412MHz~2462MHz 802.11n(HT40): 2422MHz~2452MHz
Channel numbers:	802.11b/802.11g /802.11n(HT20): 11 802.11(HT40): 7
Channel separation:	5MHz
Modulation technology:	802.11b: Direct Sequence Spread Spectrum (DSSS) 802.11g/802.11n(H20)/802.11n(H40): Orthogonal Frequency Division Multiplexing (OFDM)
Antenna Type:	Integral antenna
Antenna gain:	2.0dBi(declare by Applicant)
Power supply:	Adapter: Model No.: QX30W050300FU Input: AC 100-240V, 50/60Hz, 0.8A Output: DC 5.0V, 3A

Remark:

Antenna number : 2(MIMO technology)
Directional Antenna gain: 2+10log2=5.01dBi

Operation Frequency each of channel							
Channel	Frequency	Channel	Frequency	Channel	Frequency	Channel	Frequency
1	2412MHz	4	2427MHz	7	2442MHz	10	2457MHz
2	2417MHz	5	2432MHz	8	2447MHz	11	2462MHz
3	2422MHz	6	2437MHz	9	2452MHz	X	

Note:

In section 15.31(m), regards to the operating frequency range over 10 MHz, the Lowest frequency, the middle frequency, and the highest frequency of channel were selected to perform the test, and the selected channel see below:

Test channel	Frequency (MHz)	
	802.11b/802.11g/802.11n(HT20)	802.11n(HT40)
Lowest channel	2412MHz	2422MHz
Middle channel	2437MHz	2437MHz
Highest channel	2462MHz	2452MHz

5.3 Test mode

Transmitting mode	Keep the EUT in continuously transmitting mode
<i>Remark: During the test, dutycycle>98%,the test voltage was tuned from 85% to 115% of the nominal rated supply voltage, and found that the worst case was under the nominal rated supply condition. So the report just shows that condition's data.</i>	

We have verified the construction and function in typical operation. All the test modes were carried out with the EUT in transmitting operation, which was shown in this test report and defined as follows:

Per-scan all kind of data rate in lowest channel, and found the follow list which it was worst case.

Mode	802.11b	802.11g	802.11n(HT20)	802.11n(HT40)
Data rate	1Mbps	6Mbps	6.5Mbps	13Mbps

5.4 Description of Support Units

Manufacturer	Description	Model	Serial Number	FCC ID/DoC
PHILIPS	LCD TV	19PFL3120/T3	AU1A1212002906	DoC

5.5 Test Facility

The test facility is recognized, certified, or accredited by the following organizations:

- **FCC —Registration No.: 600491**

Global United Technology Services Co., Ltd., Shenzhen EMC Laboratory has been registered and fully described in a report filed with the (FCC) Federal Communications Commission. The acceptance letter from the FCC is maintained in files. Registration 600491, June 28, 2013.

- **Industry Canada (IC) —Registration No.: 9079A-2**

The 3m Semi-anechoic chamber of Global United Technology Services Co., Ltd. has been registered by Certification and Engineering Bureau of Industry Canada for radio equipment testing with Registration No.: 9079A-2, June 26, 2013.

5.6 Test Location

All tests were performed at:

Global United Technology Services Co., Ltd.

Address: Room 301-309, 3th Floor, Block A, Huafeng Jinyuan Business Building, No. 300 Laodong Industrial Zone, Xixiang Road, Baoan District, Shenzhen 518102

Tel: 0755-27798480

Fax: 0755-27798960

6 Test Instruments list

Radiated Emission:						
Item	Test Equipment	Manufacturer	Model No.	Inventory No.	Cal.Date (mm-dd-yy)	Cal.Due date (mm-dd-yy)
1	3m Semi- Anechoic Chamber	ZhongYu Electron	9.2(L)*6.2(W)* 6.4(H)	GTS250	Mar. 27 2015	Mar. 26 2016
2	Control Room	ZhongYu Electron	6.2(L)*2.5(W)* 2.4(H)	GTS251	N/A	N/A
3	Spectrum Analyzer	Agilent	E4440A	GTS533	Dec. 4 2014	Dec. 3 2015
4	EMI Test Receiver	Rohde & Schwarz	ESU26	GTS203	June 30 2015	June 29 2016
5	BiConiLog Antenna	SCHWARZBECK MESS-ELEKTRONIK	VULB9163	GTS214	June 30 2015	June 29 2016
6	Double -ridged waveguide horn	SCHWARZBECK MESS-ELEKTRONIK	9120D-829	GTS208	June 26 2015	June 25 2016
7	Horn Antenna	ETS-LINDGREN	3160	GTS217	Mar. 27 2015	Mar. 26 2016
8	EMI Test Software	AUDIX	E3	N/A	N/A	N/A
9	Coaxial Cable	GTS	N/A	GTS213	Mar. 28 2015	Mar. 27 2016
10	Coaxial Cable	GTS	N/A	GTS211	Mar. 28 2015	Mar. 27 2016
11	Coaxial cable	GTS	N/A	GTS210	Mar. 28 2015	Mar. 27 2016
12	Coaxial Cable	GTS	N/A	GTS212	Mar. 28 2015	Mar. 27 2016
13	Amplifier(100kHz-3GHz)	HP	8347A	GTS204	June 30 2015	June 29 2016
14	Amplifier(2GHz-20GHz)	HP	8349B	GTS206	June 30 2015	June 29 2016
15	Amplifier (18-26GHz)	Rohde & Schwarz	AFS33-18002 650-30-8P-44	GTS218	June 26 2015	June 25 2016
16	Band filter	Amindeon	82346	GTS219	Mar. 28 2015	Mar. 27 2016
17	Power Meter	Anritsu	ML2495A	GTS540	June 30 2015	June 29 2016
18	Power Sensor	Anritsu	MA2411B	GTS541	June 30 2015	June 29 2016

Conducted Emission:						
Item	Test Equipment	Manufacturer	Model No.	Inventory No.	Cal.Date (mm-dd-yy)	Cal.Due date (mm-dd-yy)
1	Shielding Room	ZhongYu Electron	7.0(L)x3.0(W)x3.0(H)	GTS264	Sep. 07 2013	Sep. 06 2015
2	EMI Test Receiver	Rohde & Schwarz	ESCS30	GTS223	June 30 2015	June 29 2016
3	10dB Pulse Limita	Rohde & Schwarz	N/A	GTS224	June 30 2015	June 29 2016
4	Coaxial Switch	ANRITSU CORP	MP59B	GTS225	June 30 2015	June 29 2016
5	LISN	SCHWARZBECK MESS-ELEKTRONIK	NSLK 8127	GTS226	June 30 2015	June 29 2016
6	Coaxial Cable	GTS	N/A	GTS227	June 30 2015	June 29 2016
7	EMI Test Software	AUDIX	E3	N/A	N/A	N/A

General used equipment:						
Item	Test Equipment	Manufacturer	Model No.	Inventory No.	Cal.Date (mm-dd-yy)	Cal.Due date (mm-dd-yy)
1	Barometer	ChangChun	DYM3	GTS257	July 07 2015	July 06 2016

7 Test results and Measurement Data

7.1 Antenna requirement

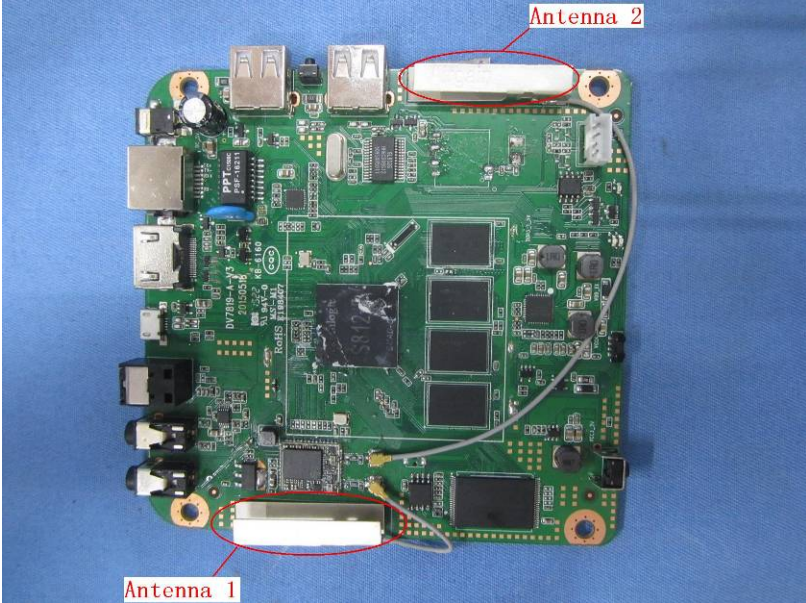
Standard requirement:	FCC Part15 C Section 15.203 /247(c)
<p>15.203 requirement:</p> <p>An intentional radiator shall be designed to ensure that no antenna other than that furnished by the responsible party shall be used with the device. The use of a permanently attached antenna or of an antenna that uses a unique coupling to the intentional radiator, the manufacturer may design the unit so that a broken antenna can be replaced by the user, but the use of a standard antenna jack or electrical connector is prohibited.</p> <p>15.247(c) (1)(i) requirement:</p> <p>(i) Systems operating in the 2400-2483.5 MHz band that is used exclusively for fixed. Point-to-point operations may employ transmitting antennas with directional gain greater than 6dBi provided the maximum conducted output power of the intentional radiator is reduced by 1 dB for every 3 dB that the directional gain of the antenna exceeds 6dBi.</p>	
E.U.T Antenna:	
<p><i>The antenna is Integral antenna, the best case gain of the antenna is 2dBi</i></p> 	

7.2 Conducted Emissions

Test Requirement:	FCC Part15 C Section 15.207														
Test Method:	ANSI C63.10:2013														
Test Frequency Range:	150KHz to 30MHz														
Class / Severity:	Class B														
Receiver setup:	RBW=9KHz, VBW=30KHz, Sweep time=auto														
Limit:	<table border="1"> <thead> <tr> <th rowspan="2">Frequency range (MHz)</th> <th colspan="2">Limit (dBuV)</th> </tr> <tr> <th>Quasi-peak</th> <th>Average</th> </tr> </thead> <tbody> <tr> <td>0.15-0.5</td> <td>66 to 56*</td> <td>56 to 46*</td> </tr> <tr> <td>0.5-5</td> <td>56</td> <td>46</td> </tr> <tr> <td>5-30</td> <td>60</td> <td>50</td> </tr> </tbody> </table> <p>* Decreases with the logarithm of the frequency.</p>	Frequency range (MHz)	Limit (dBuV)		Quasi-peak	Average	0.15-0.5	66 to 56*	56 to 46*	0.5-5	56	46	5-30	60	50
Frequency range (MHz)	Limit (dBuV)														
	Quasi-peak	Average													
0.15-0.5	66 to 56*	56 to 46*													
0.5-5	56	46													
5-30	60	50													
Test setup:	<p><i>Remark</i> E.U.T: Equipment Under Test LISN: Line Impedance Stabilization Network Test table height=0.8m</p>														
Test procedure:	<ol style="list-style-type: none"> 1. The E.U.T and simulators are connected to the main power through a line impedance stabilization network (L.I.S.N.). This provides a 50ohm/50uH coupling impedance for the measuring equipment. 2. The peripheral devices are also connected to the main power through a LISN that provides a 50ohm/50uH coupling impedance with 50ohm termination. (Please refer to the block diagram of the test setup and photographs). 3. Both sides of A.C. line are checked for maximum conducted interference. In order to find the maximum emission, the relative positions of equipment and all of the interface cables must be changed according to ANSI C63.10:2013 on conducted measurement. 														
Test Instruments:	Refer to section 6.0 for details														
Test mode:	Refer to section 5.3 for details (KEEPING MIMO Transmitter mode)														
Test results:	Pass														

Measurement data

Line:

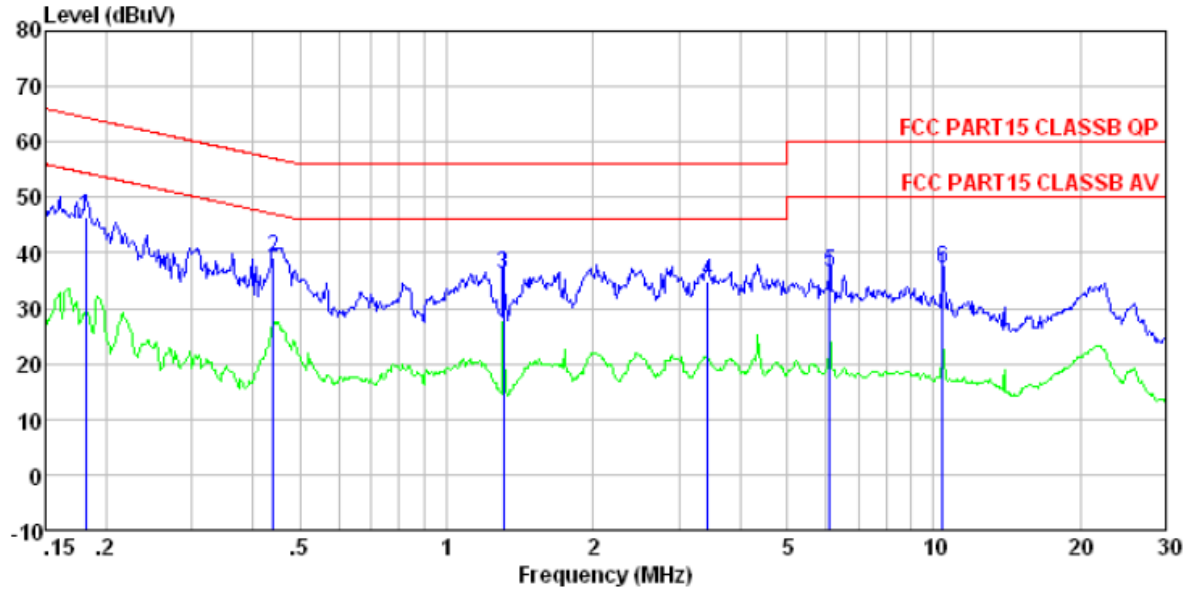

Condition : FCC PART15 CLASSB QP LISN-2013 LINE
 Job No. : 1269RF
 Test mode : WiFi mode
 Test Engineer: Song

	Read Freq	LISN Level	Cable Factor	Cable Loss	Level	Limit Line	Over Limit	Remark
	MHz	dBuV	dB	dB	dBuV	dBuV	dB	
1	0.182	46.06	0.14	0.13	46.33	64.42	-18.09	QP
2	0.440	39.01	0.12	0.11	39.24	57.07	-17.83	QP
3	1.310	35.76	0.12	0.13	36.01	56.00	-19.99	QP
4	3.436	34.36	0.18	0.15	34.69	56.00	-21.31	QP
5	6.121	36.26	0.23	0.16	36.65	60.00	-23.35	QP
6	10.452	36.59	0.30	0.19	37.08	60.00	-22.92	QP

Neutral:

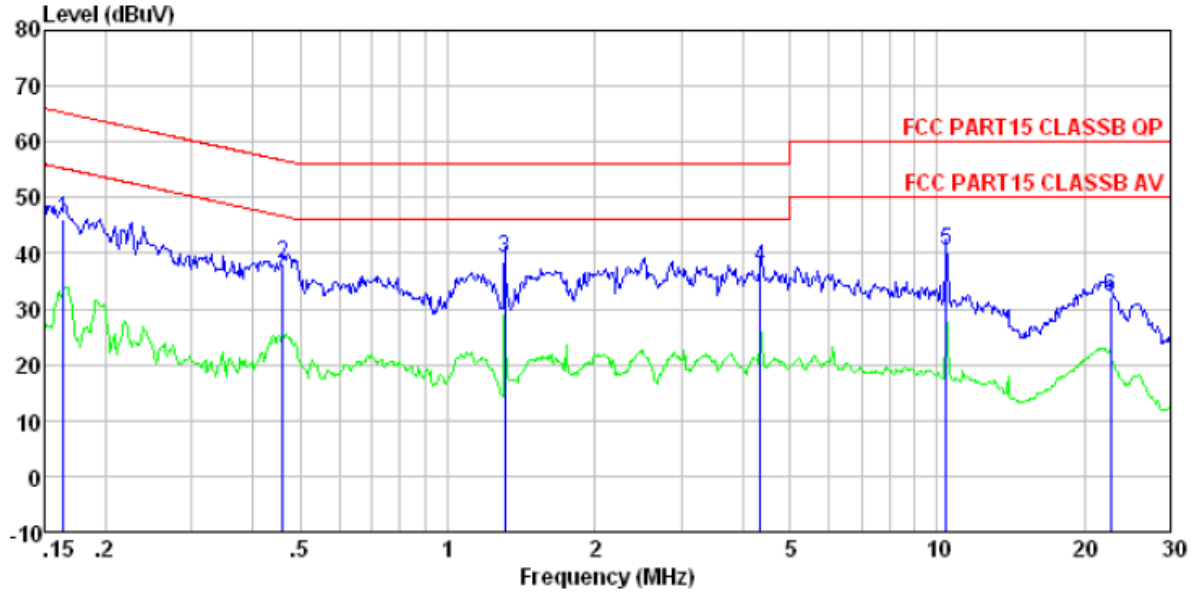

Condition : FCC PART15 CLASSB QP LISN-2013 NEUTRAL
 Job No. : 1269RF
 Test mode : WiFi mode
 Test Engineer: Song

	Freq	Read Level	LISN Factor	Cable Loss	Level	Limit Line	Over Limit	Remark
	MHz	dBuV	dB	dB	dBuV	dBuV	dB	
1	0.164	45.77	0.07	0.12	45.96	65.25	-19.29	QP
2	0.461	37.99	0.06	0.11	38.16	56.67	-18.51	QP
3	1.310	38.81	0.09	0.13	39.03	56.00	-16.97	QP
4	4.361	37.30	0.15	0.15	37.60	56.00	-18.40	QP
5	10.452	40.01	0.25	0.19	40.45	60.00	-19.55	QP
6	22.655	31.07	0.82	0.23	32.12	60.00	-27.88	QP

Notes:

1. An initial pre-scan was performed on the line and neutral lines with peak detector.
2. Quasi-Peak and Average measurement were performed at the frequencies with maximized peak emission.
3. Final Level = Receiver Read level + LISN Factor + Cable Loss
4. If the average limit is met when using a quasi-peak detector receiver, the EUT shall be deemed to meet both limits and measurement with the average detector receiver is unnecessary.

7.3 Conducted Peak Output Power

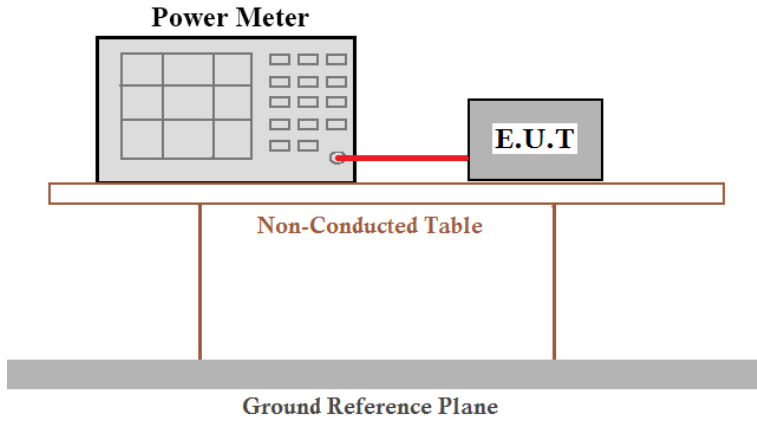
Test Requirement:	FCC Part15 C Section 15.247 (b)(3)
Test Method:	ANSI C63.10:2013 and KDB558074 D01 DTS Meas Guidance V03
Limit:	30dBm
Test setup:	 <p>The diagram illustrates the test setup. A Power Meter is connected to an E.U.T. (Equipment Under Test) via a red cable. Both are placed on a Non-Conducted Table, which sits on a Ground Reference Plane.</p>
Test Instruments:	Refer to section 6.0 for details
Test mode:	Refer to section 5.3 for details
Test results:	Pass

Measurement Data

Test mode	Channel	Read Level (dBm)		Read Level (mW)	Total Peak Output Power (mW)	Total Peak Output Power (dBm)	Limit (dBm)	Result
802.11b	Lowest	ANT1	17.26	53.21	93.21	19.69	30	Pass
		ANT2	16.02	39.99				
	Middle	ANT1	17.11	51.40	90.76	19.58		
		ANT2	15.95	39.36				
	Highest	ANT1	17.05	50.70	89.87	19.54		
		ANT2	15.93	39.17				
802.11g	Lowest	ANT1	15.77	37.76	67.20	18.27		
		ANT2	14.69	29.44				
	Middle	ANT1	15.70	37.15	66.13	18.20		
		ANT2	14.62	28.97				
	Highest	ANT1	15.62	36.48	65.18	18.14		
		ANT2	14.58	28.71				
802.11n (HT20)	Lowest	ANT1	15.27	33.65	59.83	17.77		
		ANT2	14.18	26.18				
	Middle	ANT1	15.19	33.04	58.74	17.69		
		ANT2	14.10	25.70				
	Highest	ANT1	15.11	32.43	57.67	17.61		
		ANT2	14.02	25.23				
802.11n (HT40)	Lowest	ANT1	12.34	17.14	31.26	14.95		
		ANT2	11.50	14.13				
	Middle	ANT1	12.28	16.90	30.77	14.88		
		ANT2	11.42	13.87				
	Highest	ANT1	12.15	16.41	30.02	14.77		
		ANT2	11.34	13.61				

7.4 Channel Bandwidth

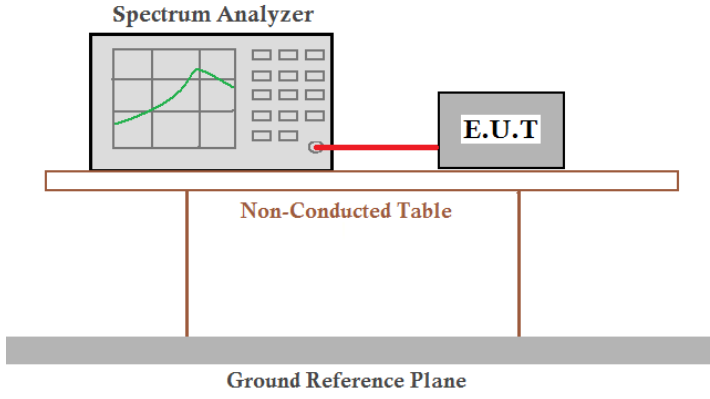
Test Requirement:	FCC Part15 C Section 15.247 (a)(2)
Test Method:	ANSI C63.10:2013 and KDB558074 D01 DTS Meas Guidance V03
Limit:	>500KHz
Test setup:	 <p>The diagram shows a Spectrum Analyzer on the left and an E.U.T. on the right, connected by a red cable. They are both on a table labeled 'Non-Conducted Table'. Below the table is a 'Ground Reference Plane'.</p>
Test Instruments:	Refer to section 6.0 for details
Test mode:	Refer to section 5.3 for details
Test results:	Pass

Measurement Data

ANT1:

Test CH	Channel Bandwidth (MHz)				Limit(KHz)	Result
	802.11b	802.11g	802.11n(HT20)	802.11n(HT40)		
Lowest	9.140	15.059	16.360	35.549	>500	Pass
Middle	9.579	15.121	15.081	35.287		
Highest	10.036	15.213	16.903	35.344		

ANT2:

Test CH	Channel Bandwidth (MHz)				Limit(KHz)	Result
	802.11b	802.11g	802.11n(HT20)	802.11n(HT40)		
Lowest	9.136	15.148	17.634	36.128	>500	Pass
Middle	9.112	13.935	17.659	35.904		
Highest	9.160	15.882	17.623	36.150		

Test plot as follows:

ANT1:

Test mode:	802.11b
------------	---------

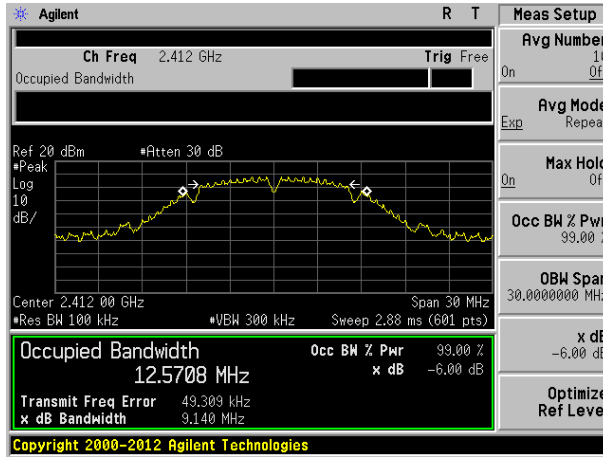

Lowest channel

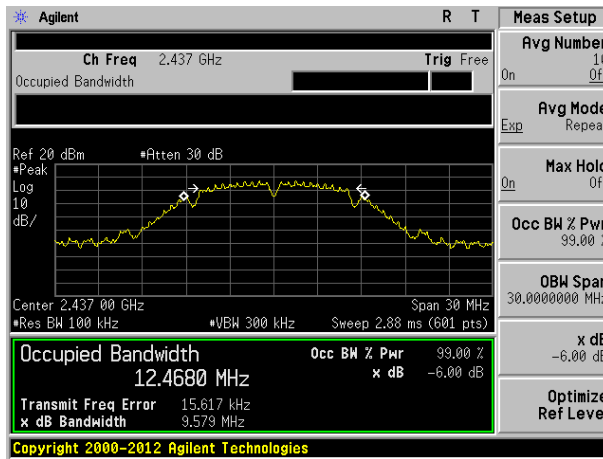

Middle channel

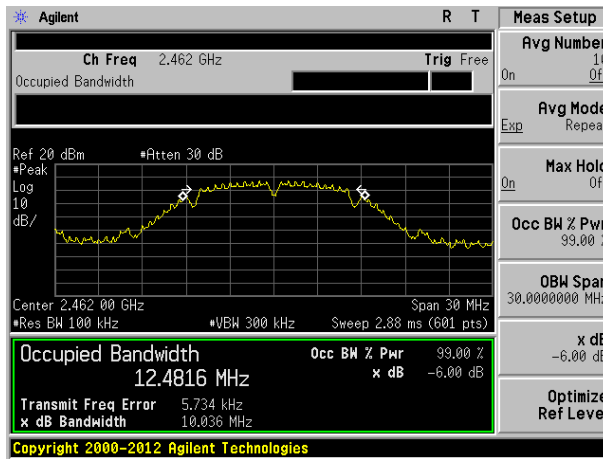

Highest channel

Test mode: 802.11g

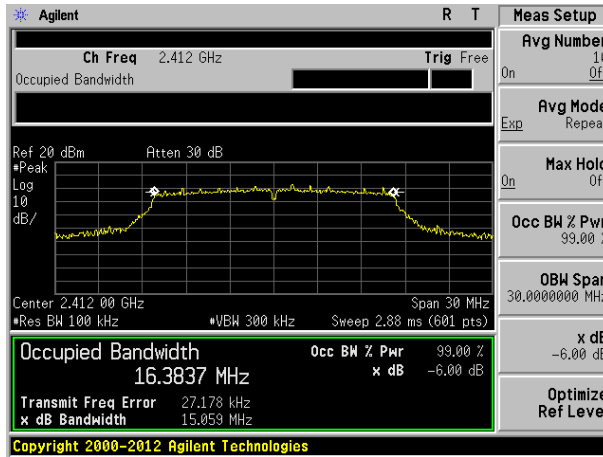

Lowest channel

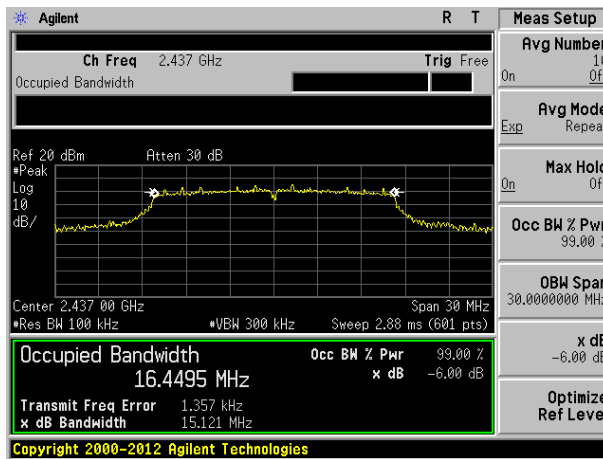

Middle channel

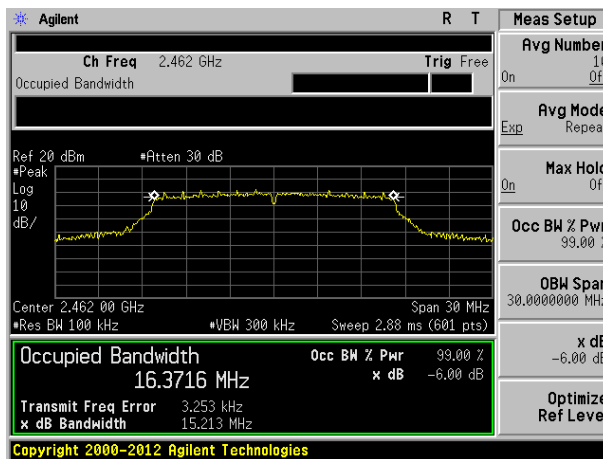

Highest channel

Test mode: 802.11n(HT20)

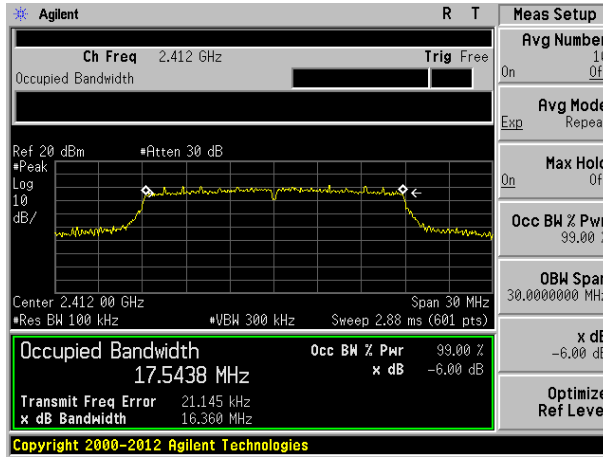

Lowest channel

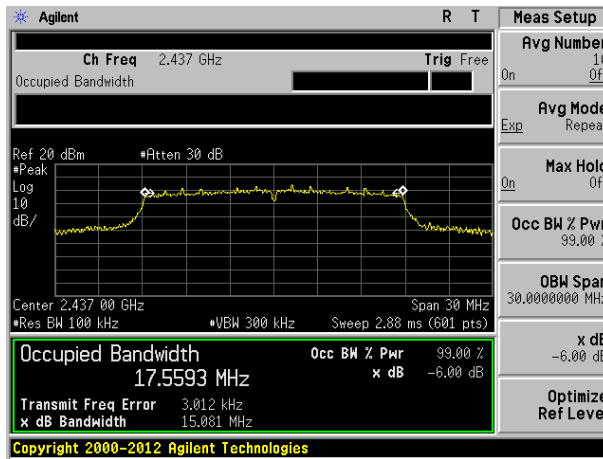

Middle channel

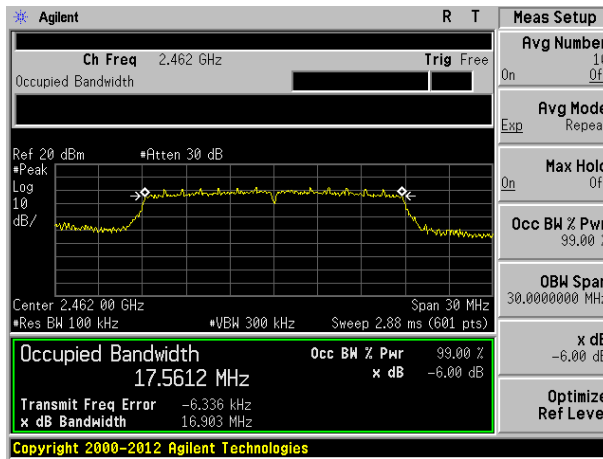

Highest channel

Test mode: 802.11n(HT40)

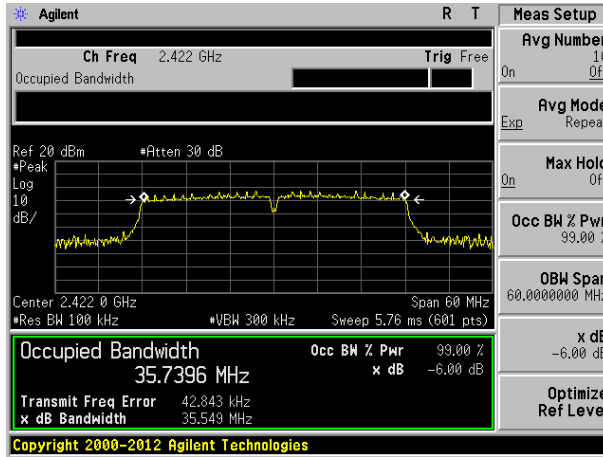

Lowest channel

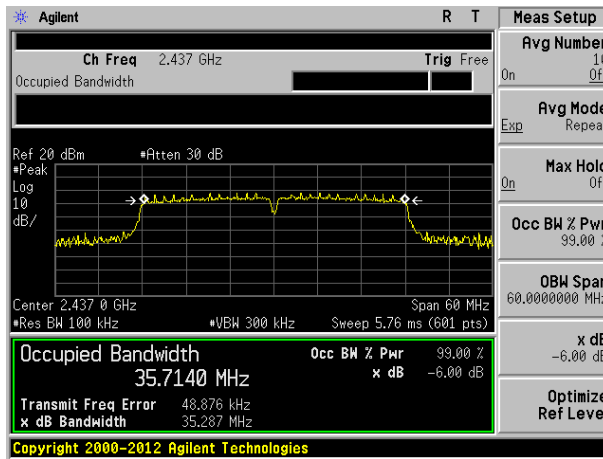

Middle channel

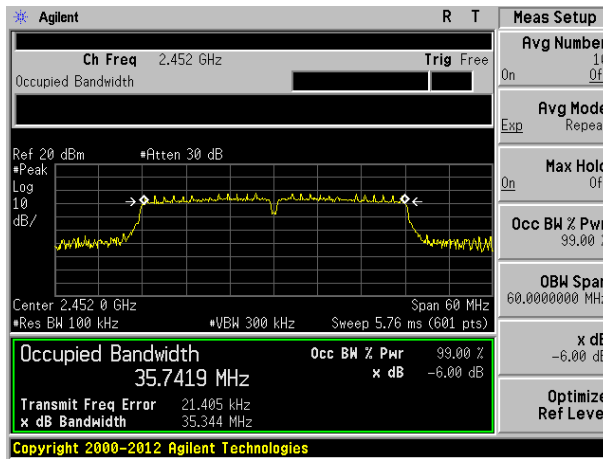

Highest channel

ANT2:

Test mode:	802.11b
------------	---------

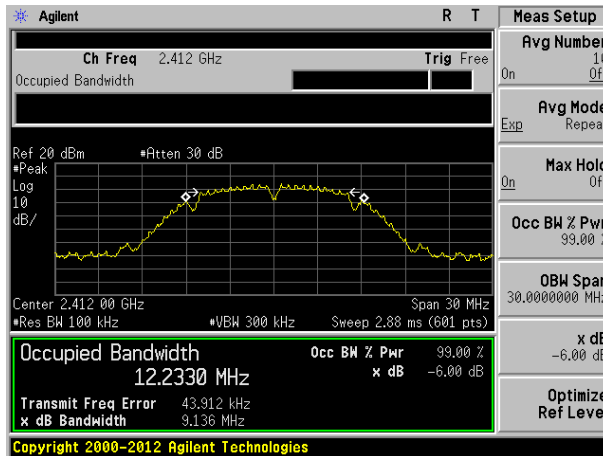

Lowest channel

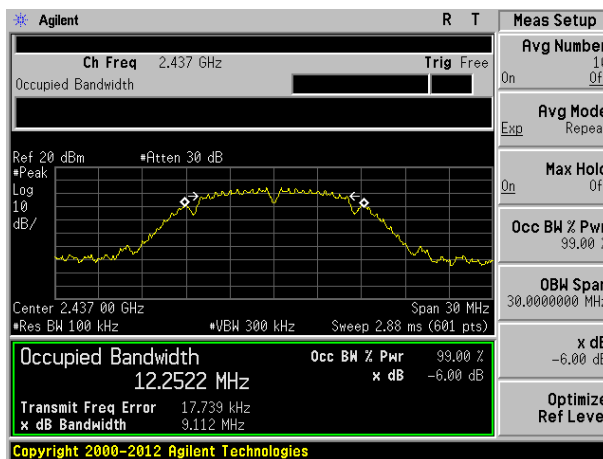

Middle channel

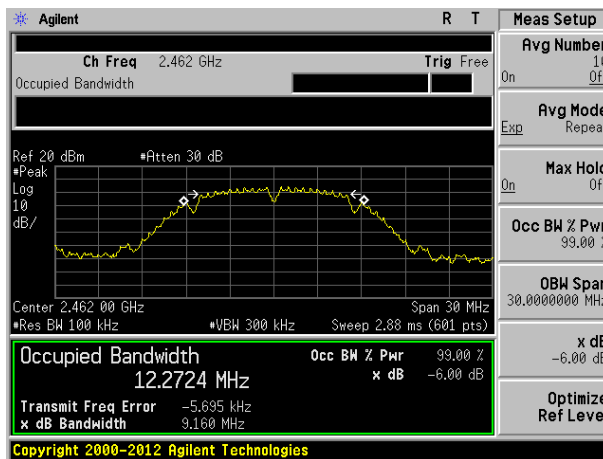

Highest channel

Test mode: 802.11g

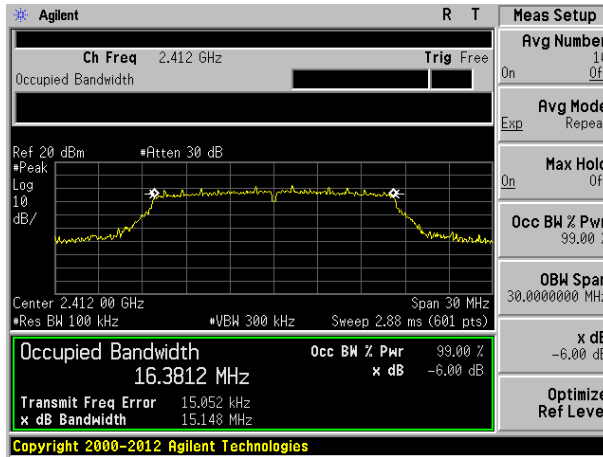

Lowest channel

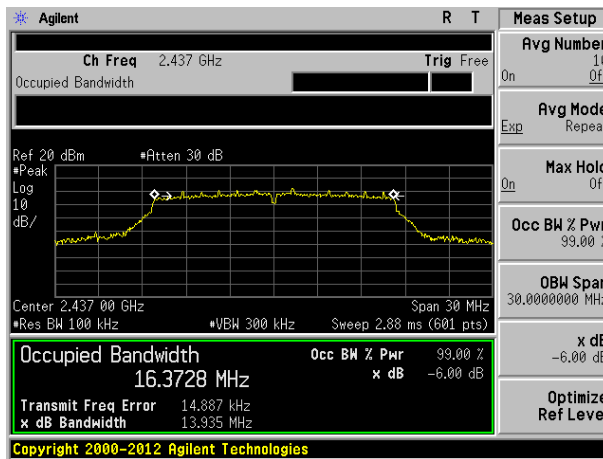

Middle channel

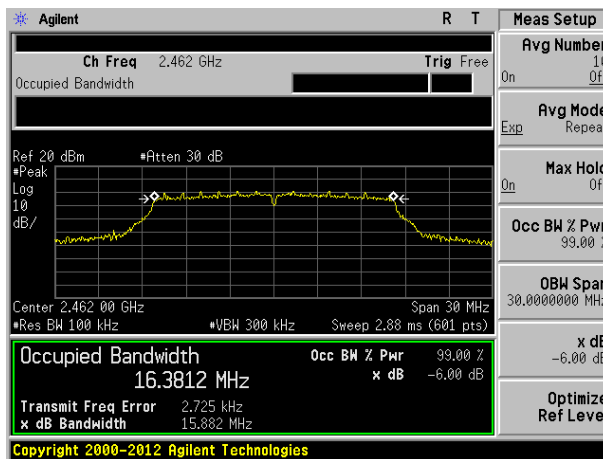

Highest channel

Test mode: 802.11n(HT20)

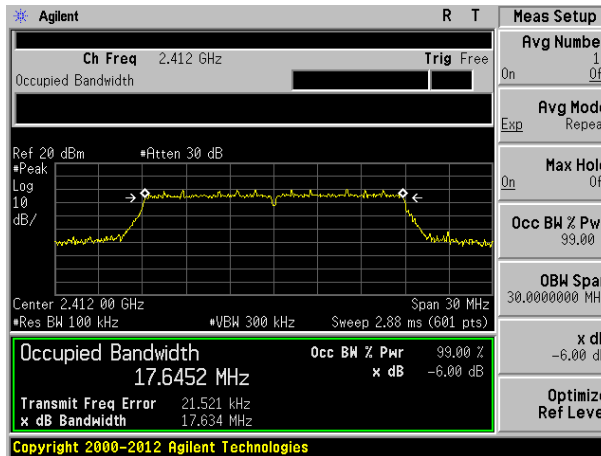

Lowest channel

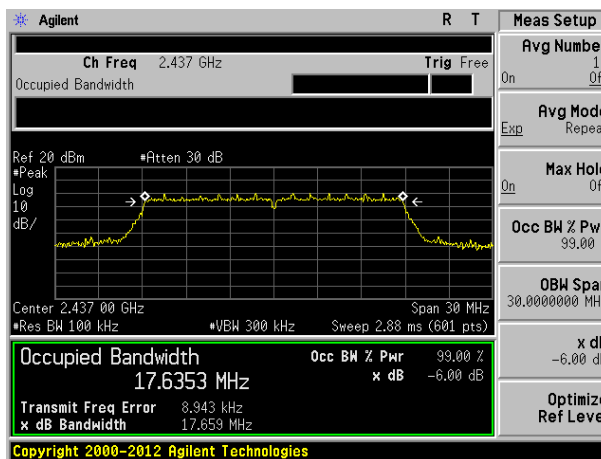

Middle channel

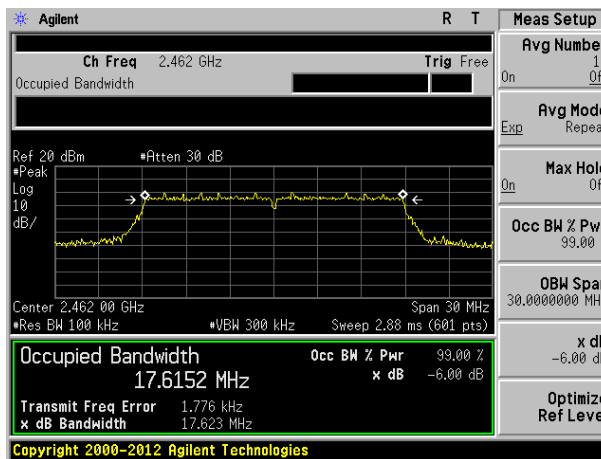

Highest channel

Test mode: 802.11n(HT40)

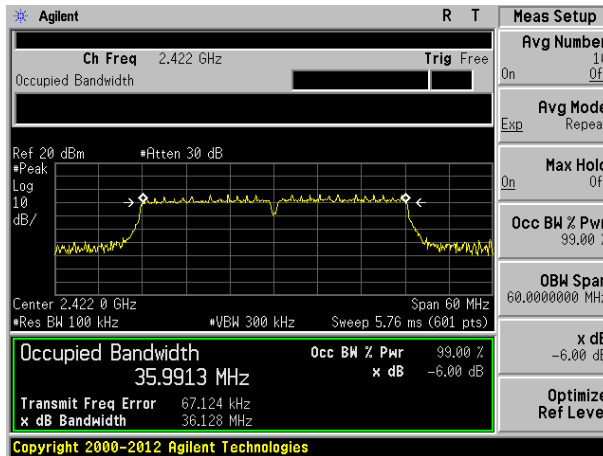

Lowest channel

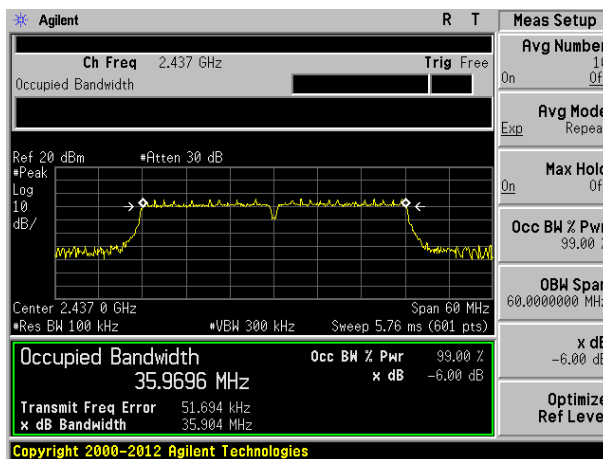

Middle channel

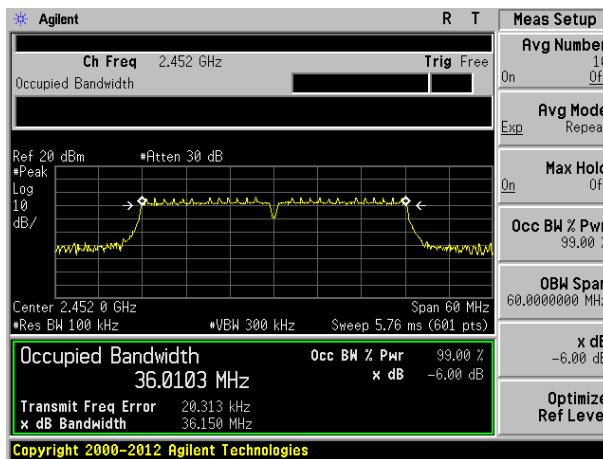

Highest channel

7.5 Power Spectral Density

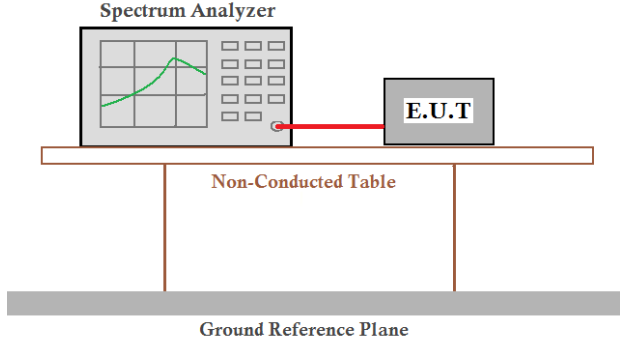
Test Requirement:	FCC Part15 C Section 15.247 (e)
Test Method:	ANSI C63.10:2013 and KDB558074 D01 DTS Meas Guidance V03
Limit:	8dBm
Test setup:	 <p>The diagram illustrates the test setup. A Spectrum Analyzer is connected via a red cable to an E.U.T. (Equipment Under Test). Both are placed on a Non-Conducted Table. Below the table is a Ground Reference Plane.</p>
Test Instruments:	Refer to section 6.0 for details
Test mode:	Refer to section 5.3 for details
Test results:	Pass

Measurement Data

ANT1

Test CH	Power Spectral Density (dBm)				Limit(dBm/3kHz)	Result
	802.11b	802.11g	802.11n(HT20)	802.11n(HT40)		
Lowest	-6.89	-12.37	-11.57	-18.28	8.00	Pass
Middle	-6.64	-11.34	-11.74	-16.66		
Highest	-7.20	-12.58	-12.57	-17.00		

ANT2

Test CH	Power Spectral Density (dBm)				Limit(dBm/3kHz)	Result
	802.11b	802.11g	802.11n(HT20)	802.11n(HT40)		
Lowest	-8.35	-12.41	-15.77	-17.97	8.00	Pass
Middle	-8.35	-13.01	-15.51	-18.67		
Highest	-8.08	-11.72	-15.20	-17.74		

Remark:

worse case of two ANT ports is -6.64dBm

$10\log 2 = 3.01$

So PSD is $-6.64 + 3.01 = -3.63\text{dBm} < 8\text{dBm}$

Test plot as follows:

ANT1:

Test mode:	802.11b
------------	---------

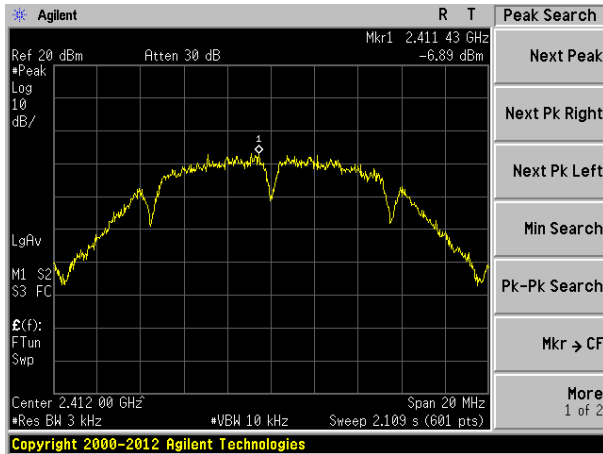

Lowest channel

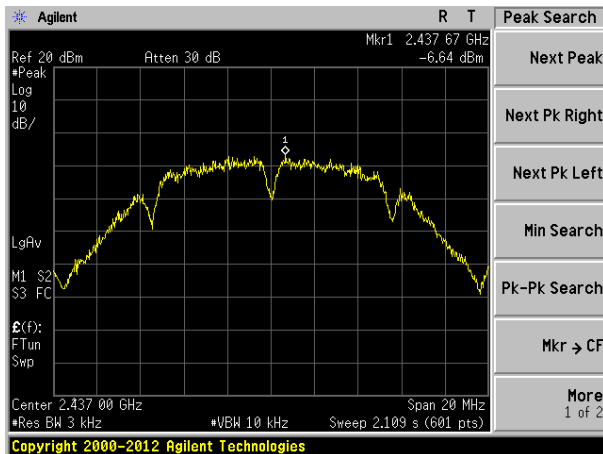

Middle channel

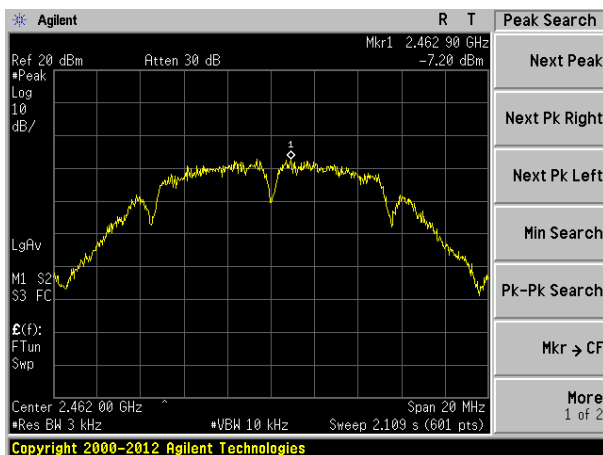

Highest channel

Test mode: 802.11g

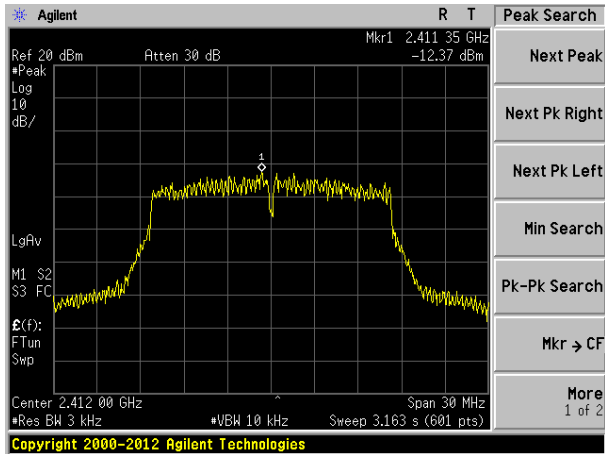

Lowest channel

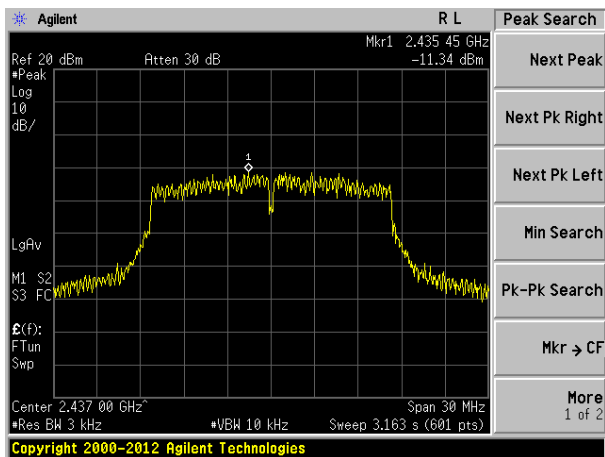

Middle channel

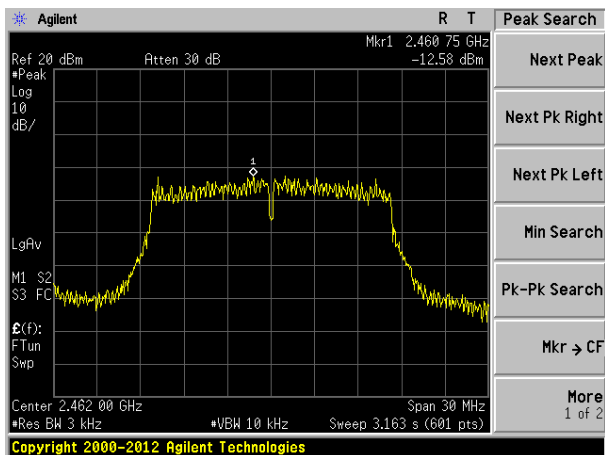

Highest channel

Test mode: 802.11n(HT20)

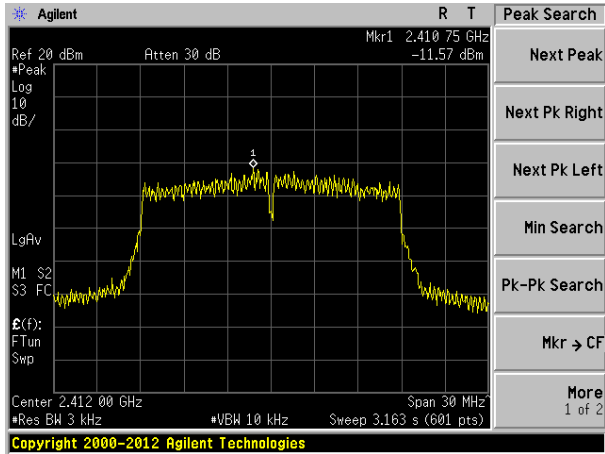

Lowest channel

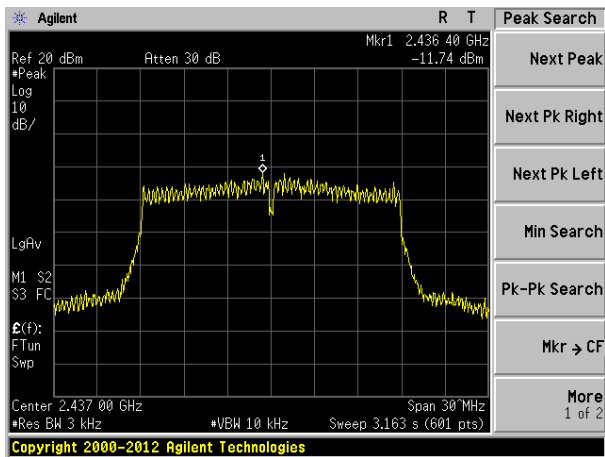

Middle channel

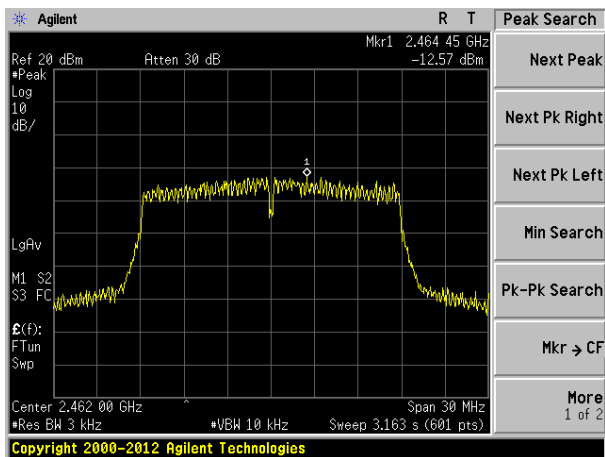

Highest channel

Test mode: 802.11n(HT40)

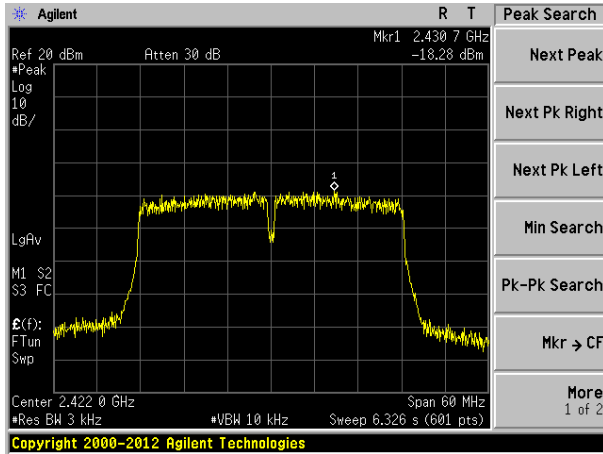

Lowest channel

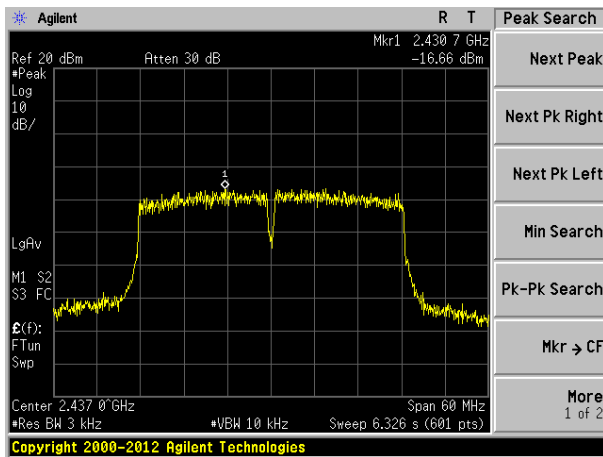

Middle channel

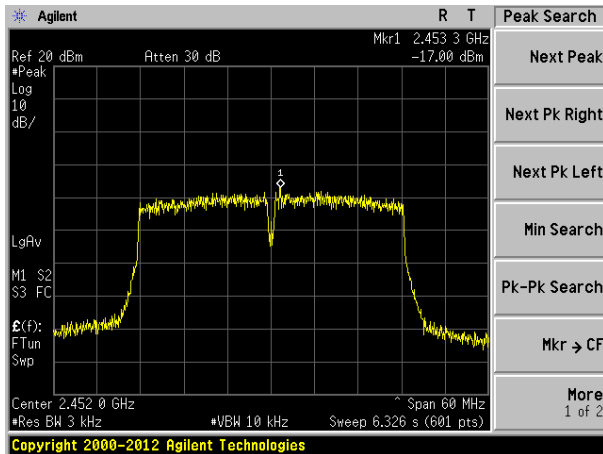

Highest channel

ANT2:

Test mode:	802.11b
------------	---------

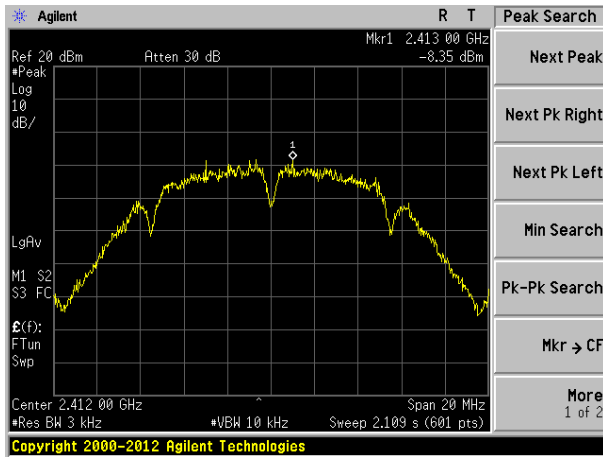

Lowest channel

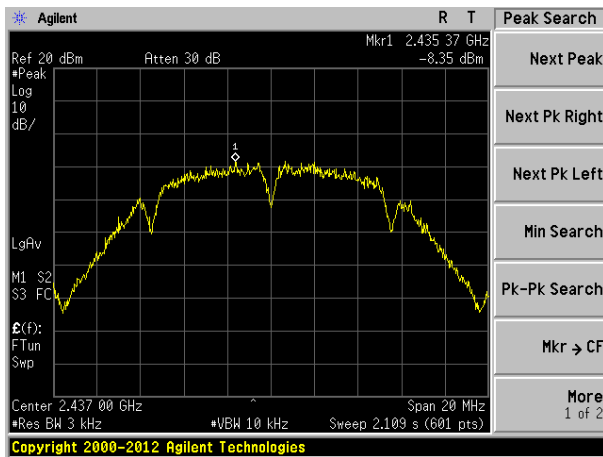

Middle channel

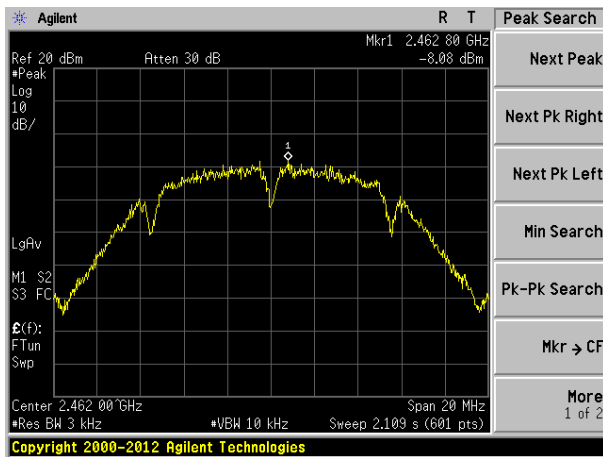

Highest channel

Test mode: 802.11g

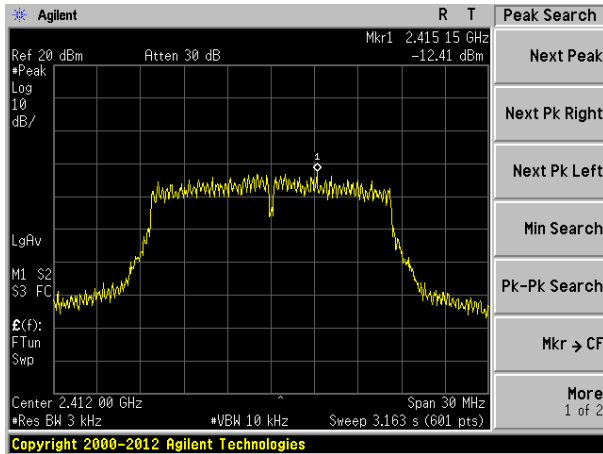

Lowest channel

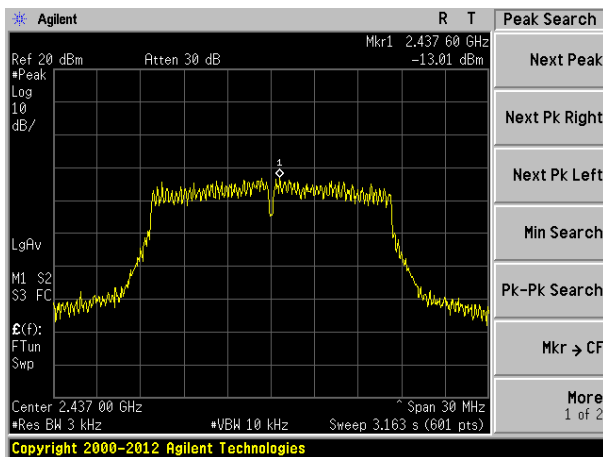

Middle channel

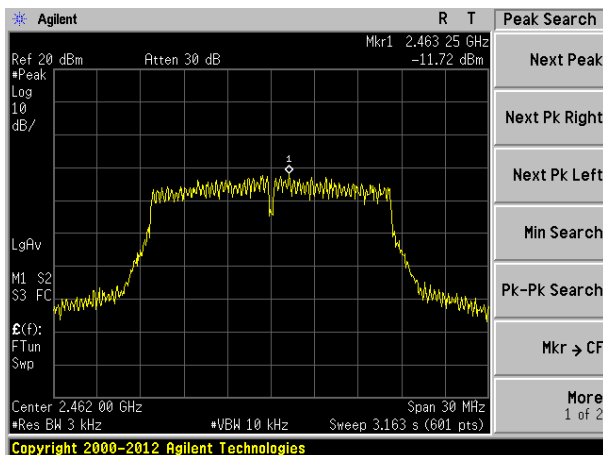

Highest channel

Test mode:	802.11n(HT20)
------------	---------------

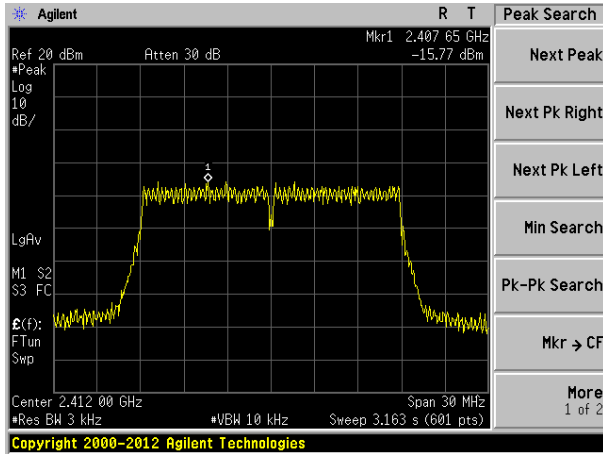

Lowest channel

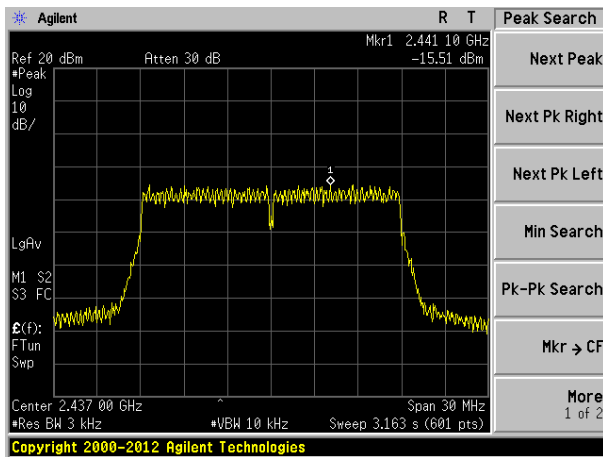

Middle channel

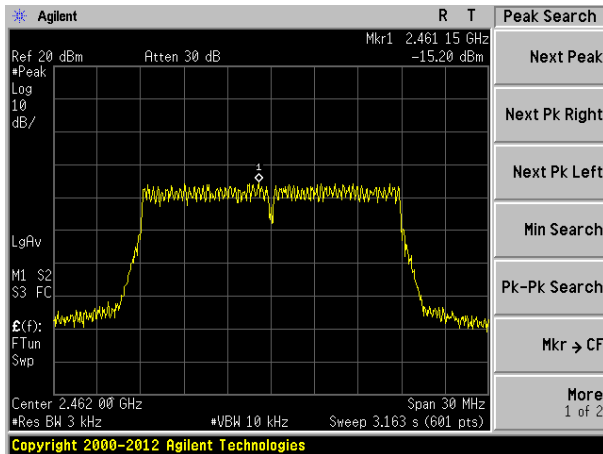

Highest channel

Test mode: 802.11n(HT40)

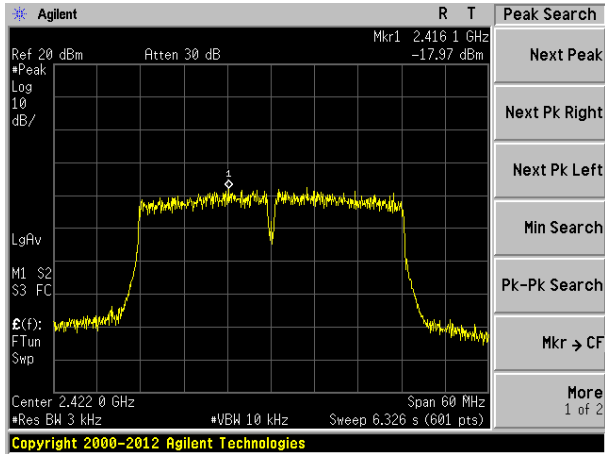

Lowest channel

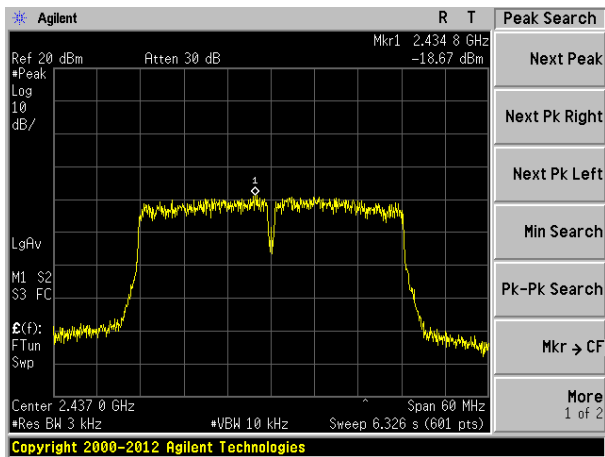

Middle channel

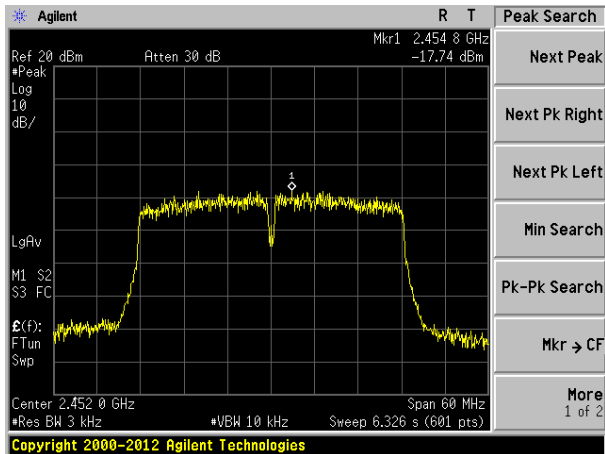

Highest channel

7.6 Band edges

7.6.1 Conducted Emission Method

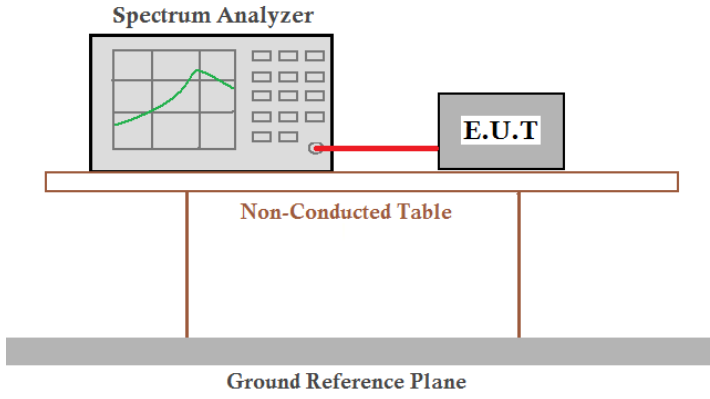
Test Requirement:	FCC Part15 C Section 15.247 (d)
Test Method:	ANSI C63.10:2013 and KDB558074 D01 DTS Meas Guidance V03
Limit:	In any 100 kHz bandwidth outside the frequency band in which the spread spectrum intentional radiator is operating, the radio frequency power that is produced by the intentional radiator shall be at least 20 dB below that in the 100 kHz bandwidth within the band that contains the highest level of the desired power, based on either an RF conducted or a radiated measurement.
Test setup:	 <p>The diagram illustrates the test setup. A Spectrum Analyzer is connected to an E.U.T. (Equipment Under Test) via a red cable. Both are placed on a Non-Conducted Table, which is supported by two legs. Below the table is a Ground Reference Plane.</p>
Test Instruments:	Refer to section 6.0 for details
Test mode:	Refer to section 5.3 for details
Test results:	Pass

Test plot as follows:

ANT1:

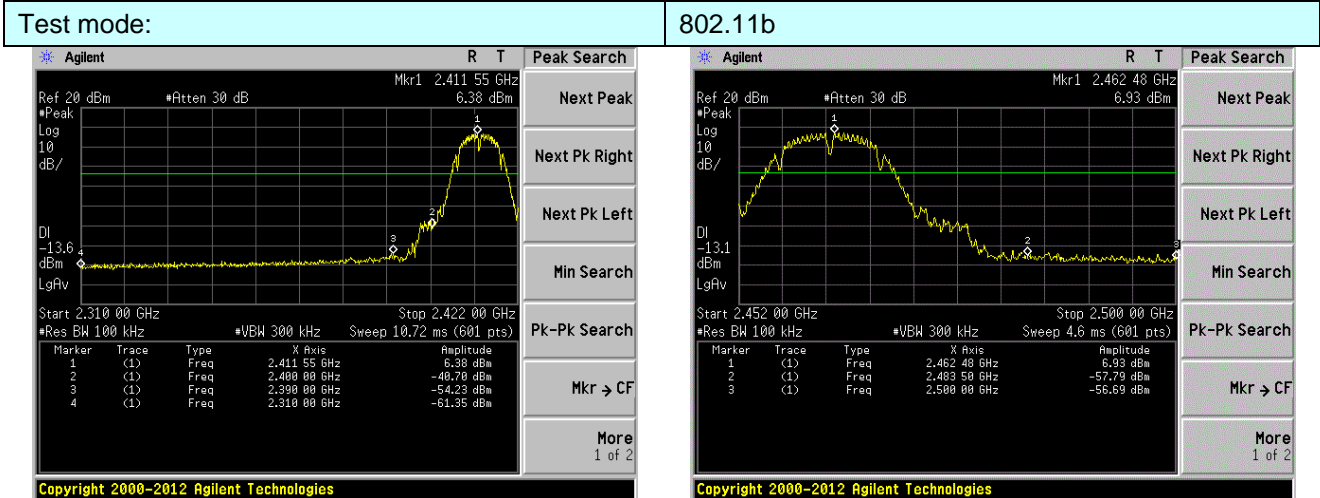

Lowest channel

Highest channel

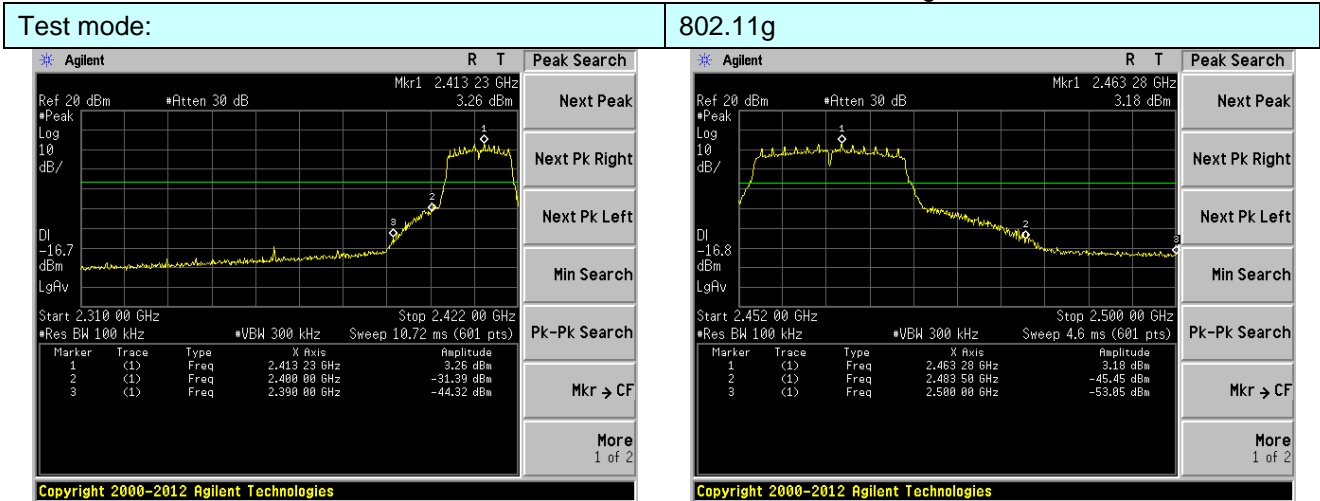

Lowest channel

Highest channel

Test mode: 802.11n(HT20)

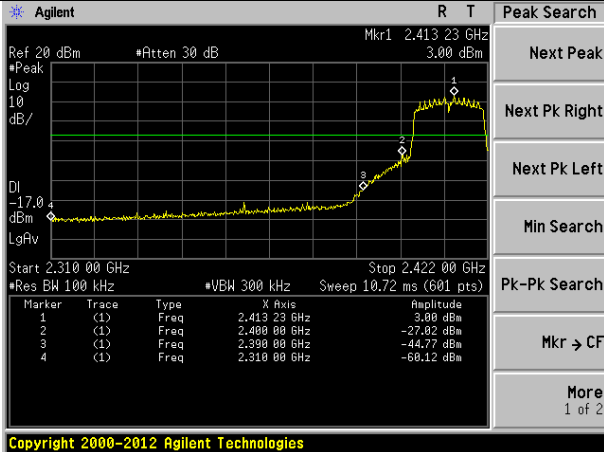

Lowest channel

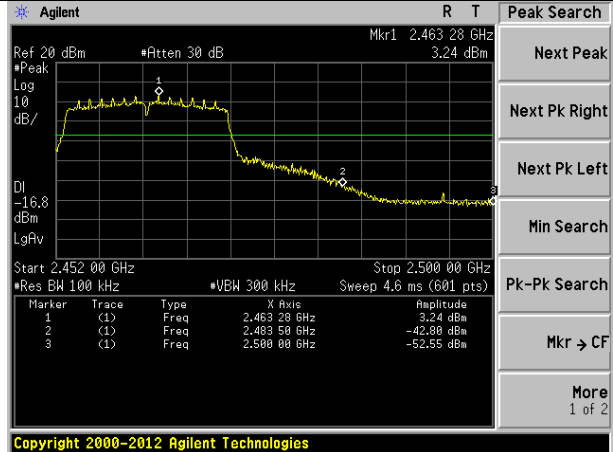

Highest channel

Test mode: 802.11n(HT40)

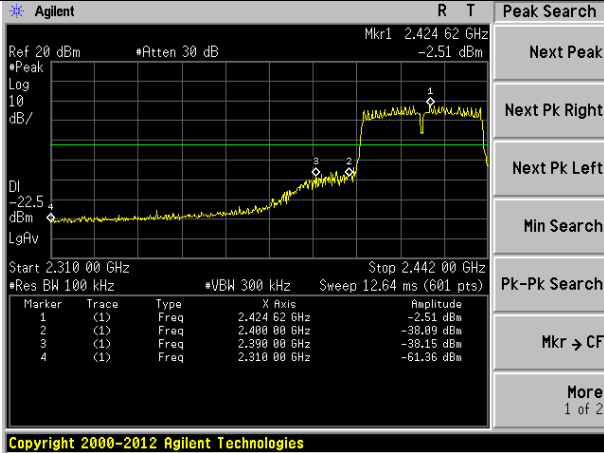

Lowest channel

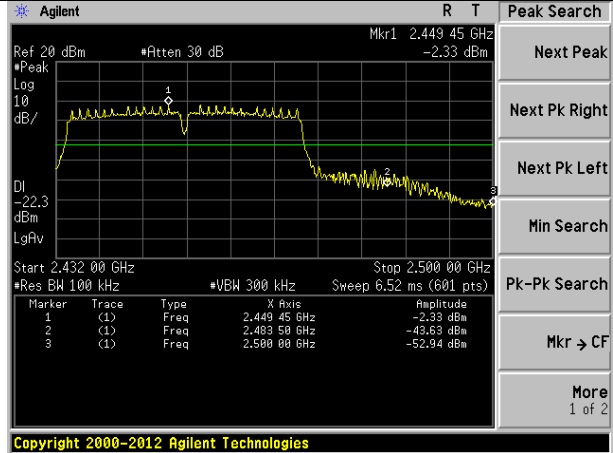

Highest channel

ANT2:

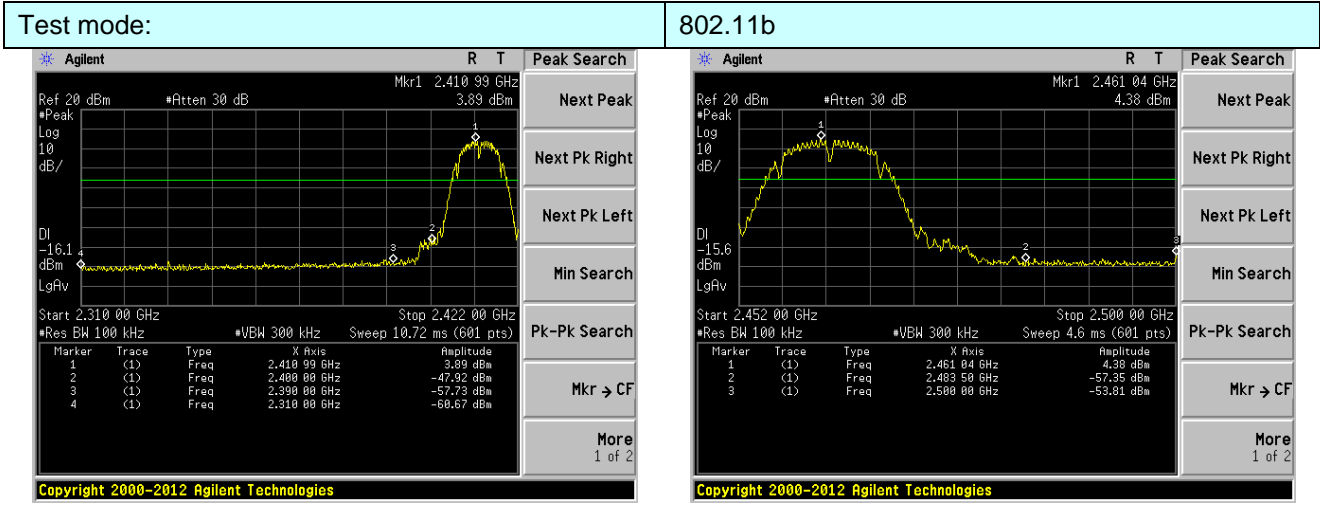

Lowest channel

Highest channel

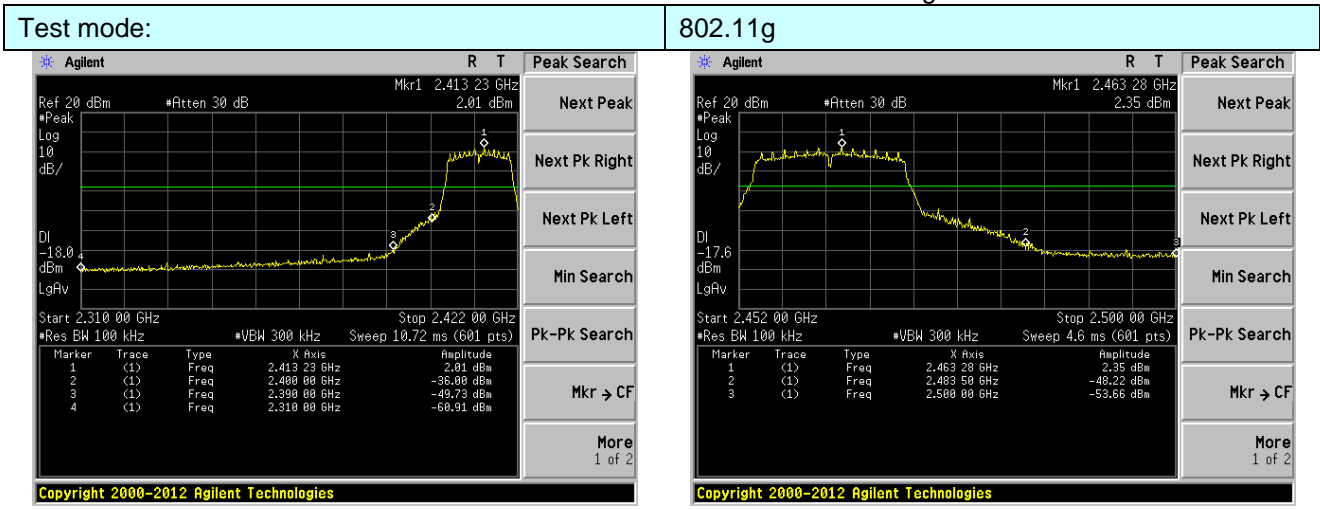

Lowest channel

Highest channel

Test mode: 802.11n(HT20)

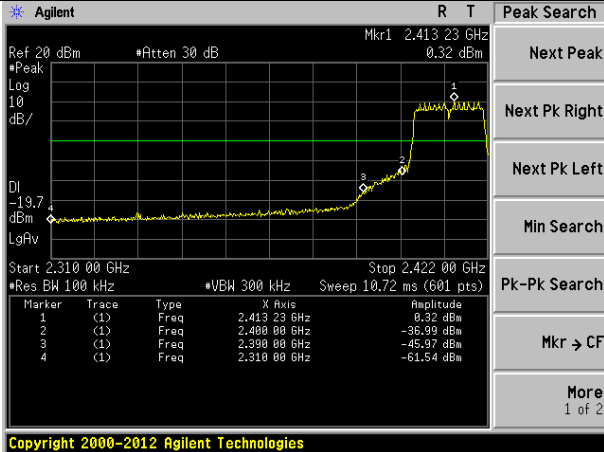

Lowest channel

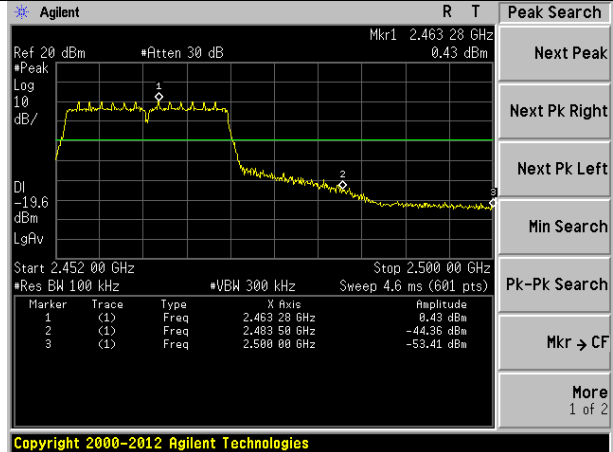

Highest channel

Test mode: 802.11n(HT40)

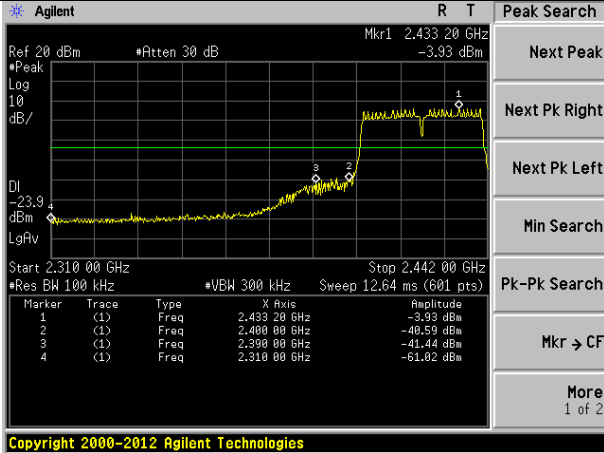

Lowest channel

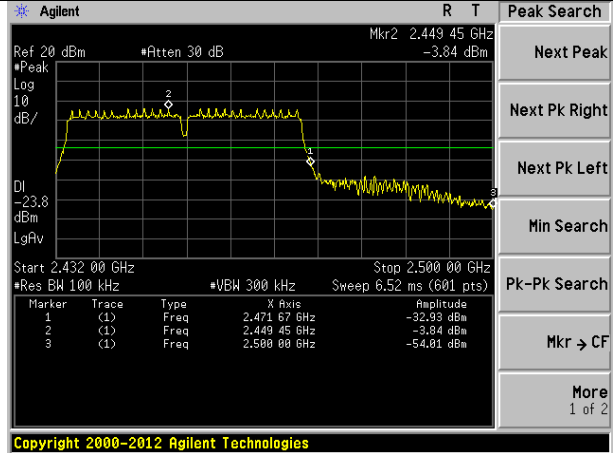

Highest channel

7.6.2 Radiated Emission Method

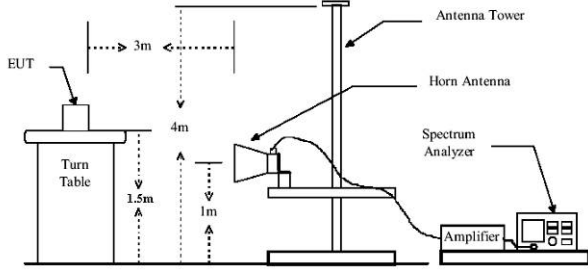
Test Requirement:	FCC Part15 C Section 15.209 and 15.205				
Test Method:	ANSI C63.10:2013				
Test Frequency Range:	All of the restrict bands were tested, only the worst band's (2310MHz to 2500MHz) data was showed.				
Test site:	Measurement Distance: 3m				
Receiver setup:	Frequency	Detector	RBW	VBW	Value
	Above 1GHz	Peak	1MHz	3MHz	Peak
		RMS	1MHz	3MHz	Average
Limit:	Frequency		Limit (dBuV/m @3m)		Value
	Above 1GHz		54.00		Average
			74.00		Peak
Test setup:					
Test Procedure:	<ol style="list-style-type: none"> 1. The EUT was placed on the top of a rotating table 1.5 meters above the ground at a 3 meter camber. The table was rotated 360 degrees to determine the position of the highest radiation. 2. The EUT was set 3 meters away from the interference-receiving antenna, which was mounted on the top of a variable-height antenna tower. 3. The antenna height is varied from one meter to four meters above the ground to determine the maximum value of the field strength. Both horizontal and vertical polarizations of the antenna are set to make the measurement. 4. For each suspected emission, the EUT was arranged to its worst case and then the antenna was tuned to heights from 1 meter to 4 meters and the rota table was turned from 0 degrees to 360 degrees to find the maximum reading. 5. The test-receiver system was set to Peak Detect Function and Specified Bandwidth with Maximum Hold Mode. 6. If the emission level of the EUT in peak mode was 10dB lower than the limit specified, then testing could be stopped and the peak values of the EUT would be reported. Otherwise the emissions that did not have 10dB margin would be re-tested one by one using peak, quasi-peak or average method as specified and then reported in a data sheet. 7. The radiation measurements are performed in X, Y, Z axis positioning. And found the Y axis positioning which it is worse case, only the test worst case mode is recorded in the report. 				
Test Instruments:	Refer to section 6.0 for details				
Test mode:	KEEPING MIMO Transmitter mode				
Test results:	Pass				

Measurement data:

Remark: The pre-test were performed on lowest, middle and highest frequencies, only the worst case's (lowest and highest frequencies) data was showed.

ANT1+ANT2:

Test mode:	802.11b	Test channel:	Lowest
------------	---------	---------------	--------

Peak value:

Frequency (MHz)	Read Level (dBuV)	Antenna Factor (dB/m)	Cable Loss (dB)	Preamp Factor (dB)	Level (dBuV/m)	Limit Line (dBuV/m)	Over Limit (dB)	Polarization
2390.00	50.71	27.59	5.38	30.18	53.50	74.00	-20.50	Horizontal
2400.00	58.00	27.58	5.39	30.18	60.79	74.00	-13.21	Horizontal
2390.00	52.32	27.59	5.38	30.18	55.11	74.00	-18.89	Vertical
2400.00	60.95	27.58	5.39	30.18	63.74	74.00	-10.26	Vertical

Average value:

Frequency (MHz)	Read Level (dBuV)	Antenna Factor (dB/m)	Cable Loss (dB)	Preamp Factor (dB)	Level (dBuV/m)	Limit Line (dBuV/m)	Over Limit (dB)	Polarization
2390.00	37.74	27.59	5.38	30.18	40.53	54.00	-13.47	Horizontal
2400.00	42.40	27.58	5.39	30.18	45.19	54.00	-8.81	Horizontal
2390.00	39.48	27.59	5.38	30.18	42.27	54.00	-11.73	Vertical
2400.00	44.98	27.58	5.39	30.18	47.77	54.00	-6.23	Vertical

Test mode:	802.11b	Test channel:	Highest
------------	---------	---------------	---------

Peak value:

Frequency (MHz)	Read Level (dBuV)	Antenna Factor (dB/m)	Cable Loss (dB)	Preamp Factor (dB)	Level (dBuV/m)	Limit Line (dBuV/m)	Over Limit (dB)	Polarization
2483.50	50.96	27.53	5.47	29.93	54.03	74.00	-19.97	Horizontal
2500.00	47.09	27.55	5.49	29.93	50.20	74.00	-23.80	Horizontal
2483.50	53.02	27.53	5.47	29.93	56.09	74.00	-17.91	Vertical
2500.00	49.42	27.55	5.49	29.93	52.53	74.00	-21.47	Vertical

Average value:

Frequency (MHz)	Read Level (dBuV)	Antenna Factor (dB/m)	Cable Loss (dB)	Preamp Factor (dB)	Level (dBuV/m)	Limit Line (dBuV/m)	Over Limit (dB)	Polarization
2483.50	37.96	27.53	5.47	29.93	41.03	54.00	-12.97	Horizontal
2500.00	34.24	27.55	5.49	29.93	37.35	54.00	-16.65	Horizontal
2483.50	39.82	27.53	5.47	29.93	42.89	54.00	-11.11	Vertical
2500.00	36.09	27.55	5.49	29.93	39.20	54.00	-14.80	Vertical

Remark:

1. Final Level = Receiver Read level + Antenna Factor + Cable Loss – Pre-amplifier Factor
2. The emission levels of other frequencies are very lower than the limit and not show in test report.

Test mode:	802.11g	Test channel:	Lowest
------------	---------	---------------	--------

Peak value:

Frequency (MHz)	Read Level (dBuV)	Antenna Factor (dB/m)	Cable Loss (dB)	Preamp Factor (dB)	Level (dBuV/m)	Limit Line (dBuV/m)	Over Limit (dB)	Polarization
2390.00	49.85	27.59	5.38	30.18	52.64	74.00	-21.36	Horizontal
2400.00	58.26	27.58	5.39	30.18	61.05	74.00	-12.95	Horizontal
2390.00	51.41	27.59	5.38	30.18	54.20	74.00	-19.80	Vertical
2400.00	59.58	27.58	5.39	30.18	62.37	74.00	-11.63	Vertical

Average value:

Frequency (MHz)	Read Level (dBuV)	Antenna Factor (dB/m)	Cable Loss (dB)	Preamp Factor (dB)	Level (dBuV/m)	Limit Line (dBuV/m)	Over Limit (dB)	Polarization
2390.00	37.13	27.59	5.38	30.18	39.92	54.00	-14.08	Horizontal
2400.00	42.45	27.58	5.39	30.18	45.24	54.00	-8.76	Horizontal
2390.00	38.81	27.59	5.38	30.18	41.60	54.00	-12.40	Vertical
2400.00	43.89	27.58	5.39	30.18	46.68	54.00	-7.32	Vertical

Test mode:	802.11g	Test channel:	Highest
------------	---------	---------------	---------

Peak value:

Frequency (MHz)	Read Level (dBuV)	Antenna Factor (dB/m)	Cable Loss (dB)	Preamp Factor (dB)	Level (dBuV/m)	Limit Line (dBuV/m)	Over Limit (dB)	Polarization
2483.50	49.74	27.53	5.47	29.93	52.81	74.00	-21.19	Horizontal
2500.00	46.14	27.55	5.49	29.93	49.25	74.00	-24.75	Horizontal
2483.50	51.63	27.53	5.47	29.93	54.70	74.00	-19.30	Vertical
2500.00	48.31	27.55	5.49	29.93	51.42	74.00	-22.58	Vertical

Average value:

Frequency (MHz)	Read Level (dBuV)	Antenna Factor (dB/m)	Cable Loss (dB)	Preamp Factor (dB)	Level (dBuV/m)	Limit Line (dBuV/m)	Over Limit (dB)	Polarization
2483.50	37.22	27.53	5.47	29.93	40.29	54.00	-13.71	Horizontal
2500.00	33.67	27.55	5.49	29.93	36.78	54.00	-17.22	Horizontal
2483.50	39.01	27.53	5.47	29.93	42.08	54.00	-11.92	Vertical
2500.00	35.48	27.55	5.49	29.93	38.59	54.00	-15.41	Vertical

Remark:

1. Final Level = Receiver Read level + Antenna Factor + Cable Loss – Pre-amplifier Factor
2. The emission levels of other frequencies are very lower than the limit and not show in test report.

Test mode:	802.11n(HT20)	Test channel:	Lowest
------------	---------------	---------------	--------

Peak value:

Frequency (MHz)	Read Level (dBuV)	Antenna Factor (dB/m)	Cable Loss (dB)	Preamp Factor (dB)	Level (dBuV/m)	Limit Line (dBuV/m)	Over Limit (dB)	Polarization
2390.00	49.67	27.59	5.38	30.18	52.46	74.00	-21.54	Horizontal
2400.00	58.01	27.58	5.39	30.18	60.80	74.00	-13.20	Horizontal
2390.00	51.21	27.59	5.38	30.18	54.00	74.00	-20.00	Vertical
2400.00	59.28	27.58	5.39	30.18	62.07	74.00	-11.93	Vertical

Average value:

Frequency (MHz)	Read Level (dBuV)	Antenna Factor (dB/m)	Cable Loss (dB)	Preamp Factor (dB)	Level (dBuV/m)	Limit Line (dBuV/m)	Over Limit (dB)	Polarization
2390.00	37.00	27.59	5.38	30.18	39.79	54.00	-14.21	Horizontal
2400.00	42.99	27.58	5.39	30.18	45.78	54.00	-8.22	Horizontal
2390.00	38.66	27.59	5.38	30.18	41.45	54.00	-12.55	Vertical
2400.00	43.03	27.58	5.39	30.18	45.82	54.00	-8.18	Vertical

Test mode:	802.11n(HT20)	Test channel:	Highest
------------	---------------	---------------	---------

Peak value:

Frequency (MHz)	Read Level (dBuV)	Antenna Factor (dB/m)	Cable Loss (dB)	Preamp Factor (dB)	Level (dBuV/m)	Limit Line (dBuV/m)	Over Limit (dB)	Polarization
2483.50	49.47	27.53	5.47	29.93	52.54	74.00	-21.46	Horizontal
2500.00	45.93	27.55	5.49	29.93	49.04	74.00	-24.96	Horizontal
2483.50	51.32	27.53	5.47	29.93	54.39	74.00	-19.61	Vertical
2500.00	48.07	27.55	5.49	29.93	51.18	74.00	-22.82	Vertical

Average value:

Frequency (MHz)	Read Level (dBuV)	Antenna Factor (dB/m)	Cable Loss (dB)	Preamp Factor (dB)	Level (dBuV/m)	Limit Line (dBuV/m)	Over Limit (dB)	Polarization
2483.50	37.06	27.53	5.47	29.93	40.13	54.00	-13.87	Horizontal
2500.00	33.54	27.55	5.49	29.93	36.65	54.00	-17.35	Horizontal
2483.50	38.83	27.53	5.47	29.93	41.90	54.00	-12.10	Vertical
2500.00	35.35	27.55	5.49	29.93	38.46	54.00	-15.54	Vertical

Remark:

1. Final Level = Receiver Read level + Antenna Factor + Cable Loss – Pre-amplifier Factor
2. The emission levels of other frequencies are very lower than the limit and not show in test report.

Test mode:	802.11n(HT40)	Test channel:	Lowest
------------	---------------	---------------	--------

Peak value:

Frequency (MHz)	Read Level (dBuV)	Antenna Factor (dB/m)	Cable Loss (dB)	Preamp Factor (dB)	Level (dBuV/m)	Limit Line (dBuV/m)	Over Limit (dB)	Polarization
2390.00	49.20	27.59	5.38	30.18	51.99	74.00	-22.01	Horizontal
2400.00	57.39	27.58	5.39	30.18	60.18	74.00	-13.82	Horizontal
2390.00	50.71	27.59	5.38	30.18	53.50	74.00	-20.50	Vertical
2400.00	58.53	27.58	5.39	30.18	61.32	74.00	-12.68	Vertical

Average value:

Frequency (MHz)	Read Level (dBuV)	Antenna Factor (dB/m)	Cable Loss (dB)	Preamp Factor (dB)	Level (dBuV/m)	Limit Line (dBuV/m)	Over Limit (dB)	Polarization
2390.00	36.67	27.59	5.38	30.18	39.46	54.00	-14.54	Horizontal
2400.00	42.12	27.58	5.39	30.18	44.91	54.00	-9.09	Horizontal
2390.00	38.29	27.59	5.38	30.18	41.08	54.00	-12.92	Vertical
2400.00	42.45	27.58	5.39	30.18	45.24	54.00	-8.76	Vertical

Test mode:	802.11n(HT40)	Test channel:	Highest
------------	---------------	---------------	---------

Peak value:

Frequency (MHz)	Read Level (dBuV)	Antenna Factor (dB/m)	Cable Loss (dB)	Preamp Factor (dB)	Level (dBuV/m)	Limit Line (dBuV/m)	Over Limit (dB)	Polarization
2483.50	48.80	27.53	5.47	29.93	51.87	74.00	-22.13	Horizontal
2500.00	45.42	27.55	5.49	29.93	48.53	74.00	-25.47	Horizontal
2483.50	50.56	27.53	5.47	29.93	53.63	74.00	-20.37	Vertical
2500.00	47.46	27.55	5.49	29.93	50.57	74.00	-23.43	Vertical

Average value:

Frequency (MHz)	Read Level (dBuV)	Antenna Factor (dB/m)	Cable Loss (dB)	Preamp Factor (dB)	Level (dBuV/m)	Limit Line (dBuV/m)	Over Limit (dB)	Polarization
2483.50	36.66	27.53	5.47	29.93	39.73	54.00	-14.27	Horizontal
2500.00	33.23	27.55	5.49	29.93	36.34	54.00	-17.66	Horizontal
2483.50	38.39	27.53	5.47	29.93	41.46	54.00	-12.54	Vertical
2500.00	35.01	27.55	5.49	29.93	38.12	54.00	-15.88	Vertical

Remark:

1. Final Level = Receiver Read level + Antenna Factor + Cable Loss – Pre-amplifier Factor
2. The emission levels of other frequencies are very lower than the limit and not show in test report.

7.7 Spurious Emission

7.7.1 Conducted Emission Method

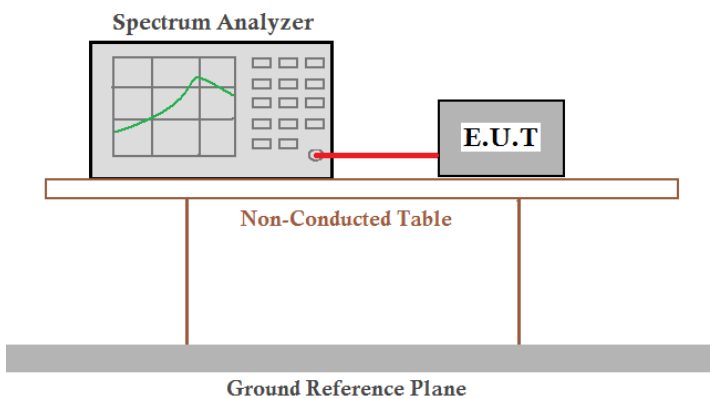
Test Requirement:	FCC Part15 C Section 15.247 (d)
Test Method:	ANSI C63.10:2013 and KDB558074 D01 DTS Meas Guidance V03
Limit:	In any 100 kHz bandwidth outside the frequency band in which the spread spectrum intentional radiator is operating, the radio frequency power that is produced by the intentional radiator shall be at least 20 dB below that in the 100 kHz bandwidth within the band that contains the highest level of the desired power, based on either an RF conducted or a radiated measurement.
Test setup:	 <p>The diagram illustrates the test setup. A Spectrum Analyzer is connected to an E.U.T. (Equipment Under Test) via a red cable. Both are placed on a Non-Conducted Table, which is supported by two legs. Below the table is a Ground Reference Plane.</p>
Test Instruments:	Refer to section 6.0 for details
Test mode:	Refer to section 5.3 for details
Test results:	Pass

Test plot as follows:

ANT1:

Test mode:	802.11b
------------	---------

Lowest channel

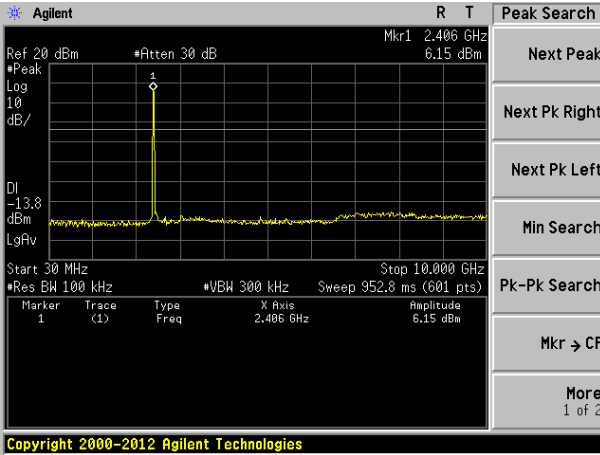

30MHz~10GHz

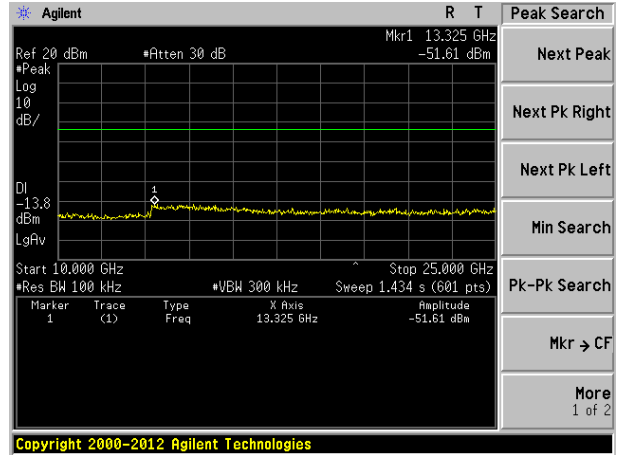

10GHz~25GHz

Middle channel

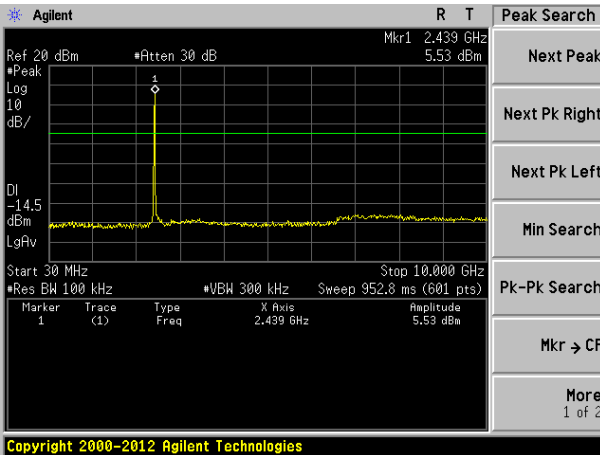

30MHz~10GHz

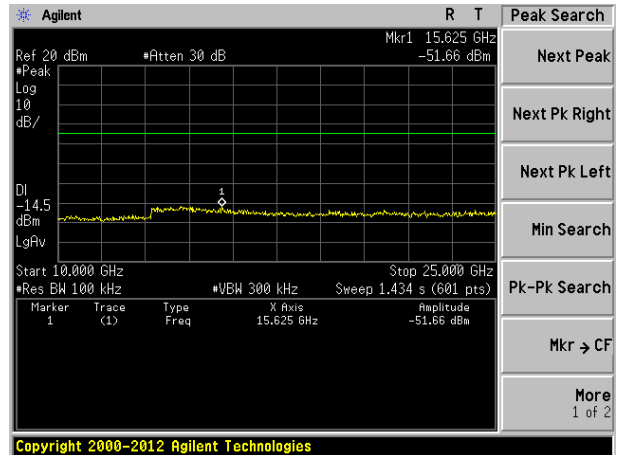

10GHz~25GHz

Highest channel

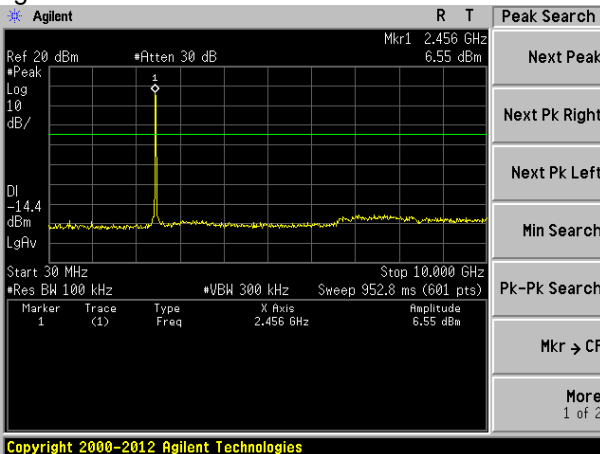

30MHz~10GHz

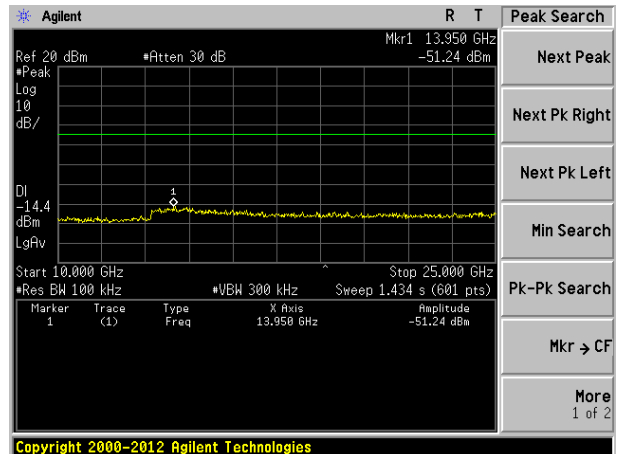

10GHz~25GHz

Test mode: 802.11g

Lowest channel

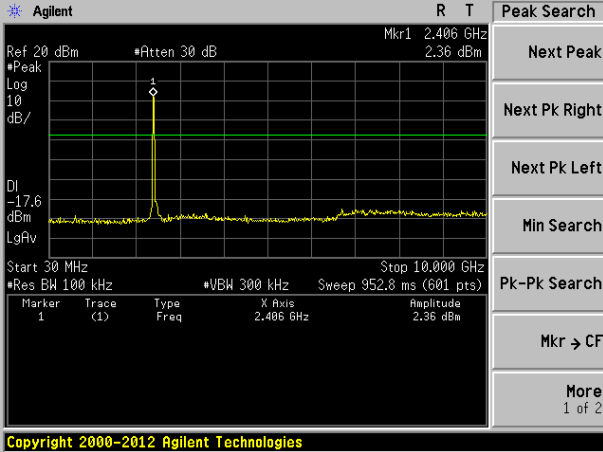

30MHz~10GHz

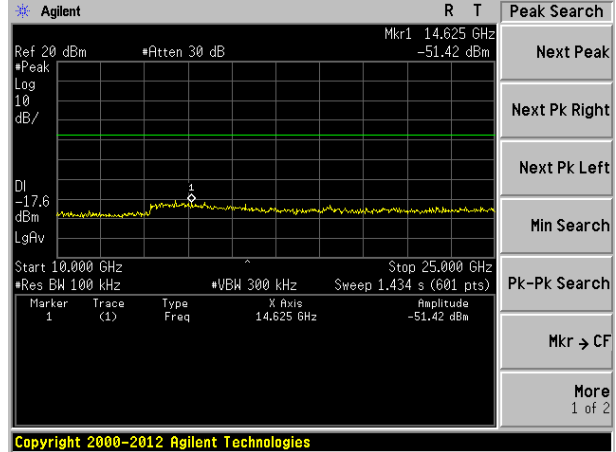

10GHz~25GHz

Middle channel

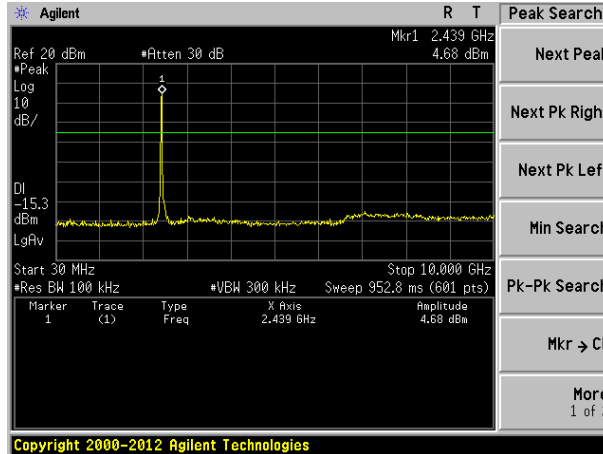

30MHz~10GHz

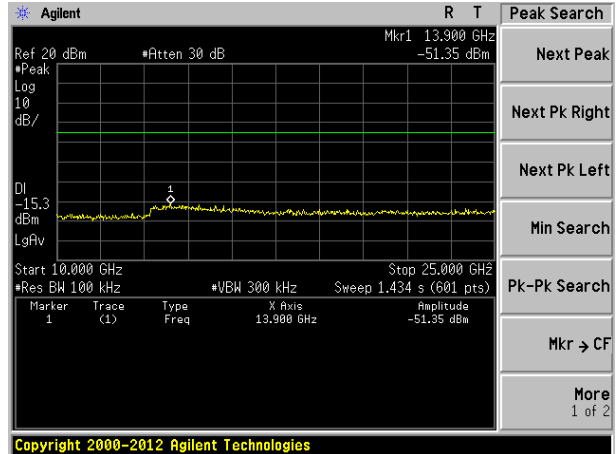

10GHz~25GHz

Highest channel

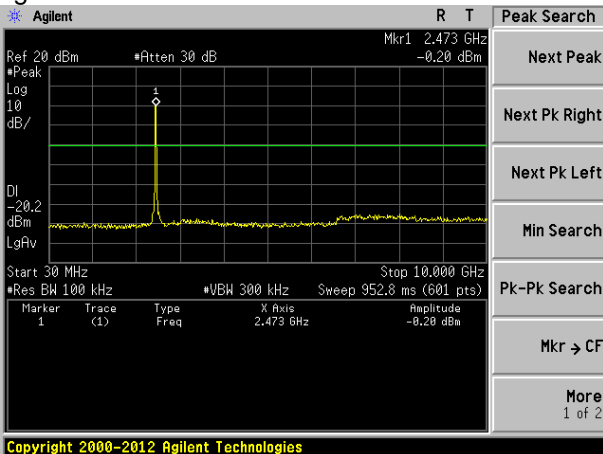

30MHz~10GHz

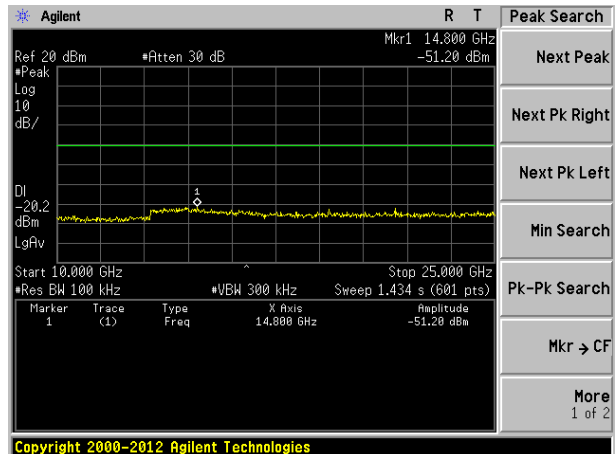

10GHz~25GHz

Test mode: 802.11n(HT20)

Lowest channel

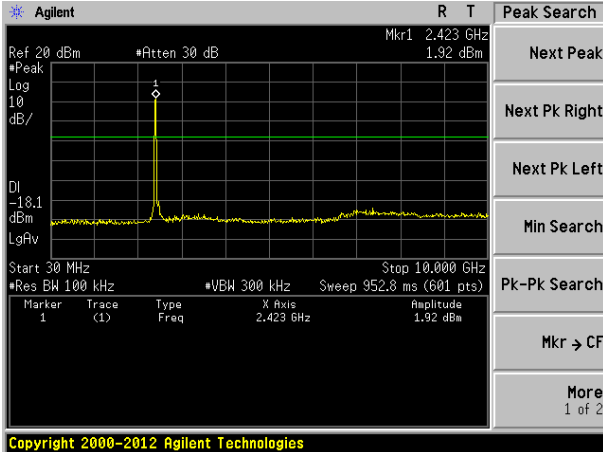

30MHz~10GHz

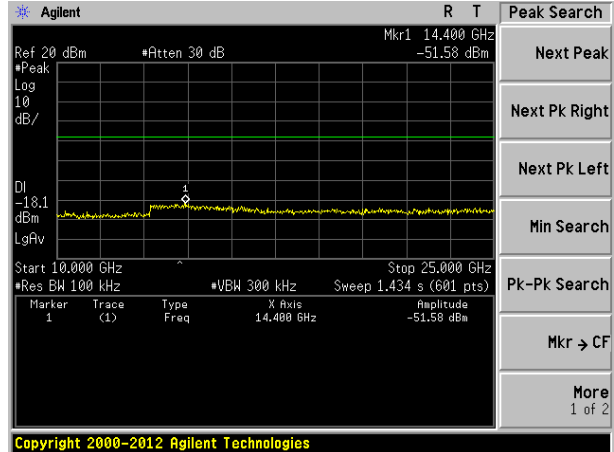

10GHz~25GHz

Middle channel

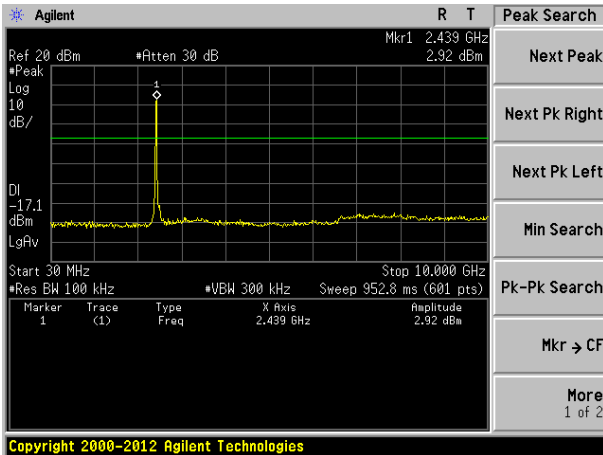

30MHz~10GHz

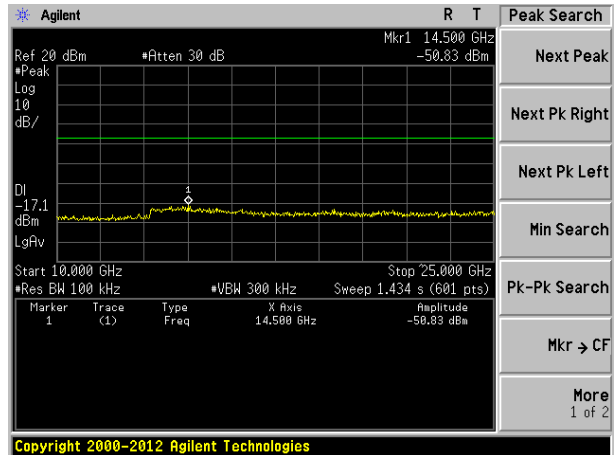

10GHz~25GHz

Highest channel

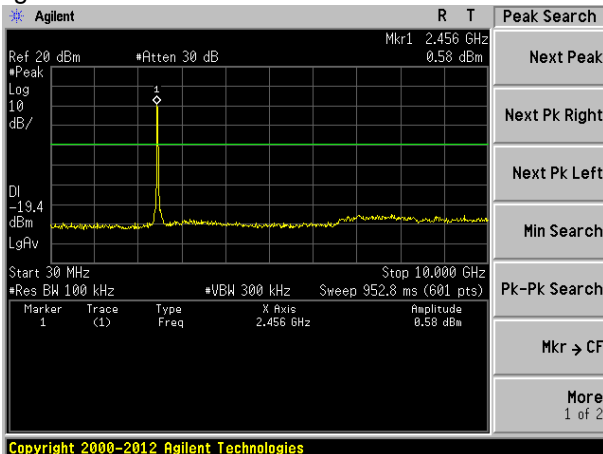

30MHz~10GHz

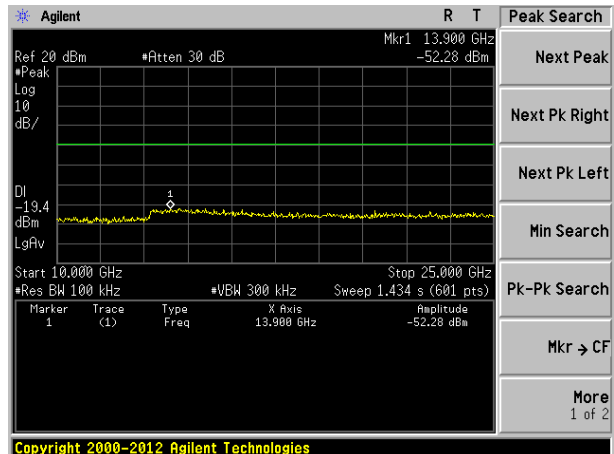

10GHz~25GHz

Test mode: 802.11n(HT40)

Lowest channel

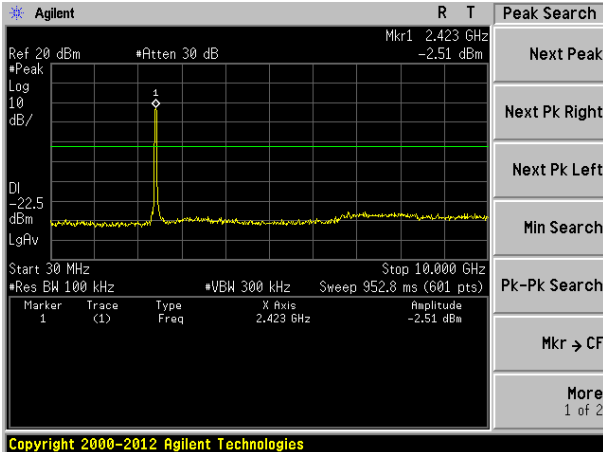

30MHz~10GHz

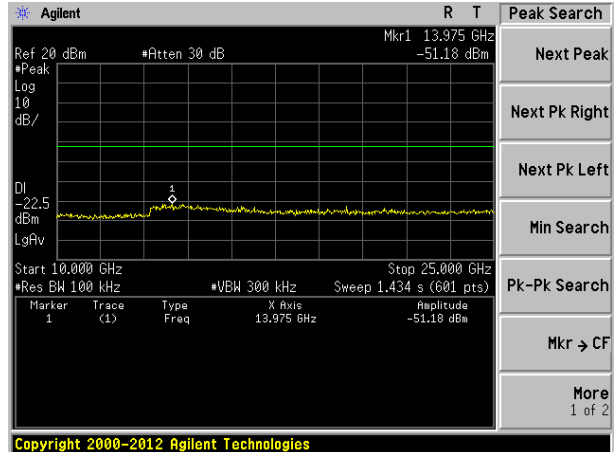

10GHz~25GHz

Middle channel

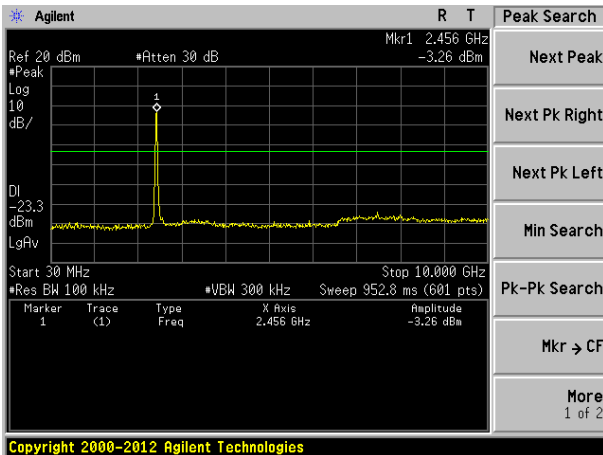

30MHz~10GHz

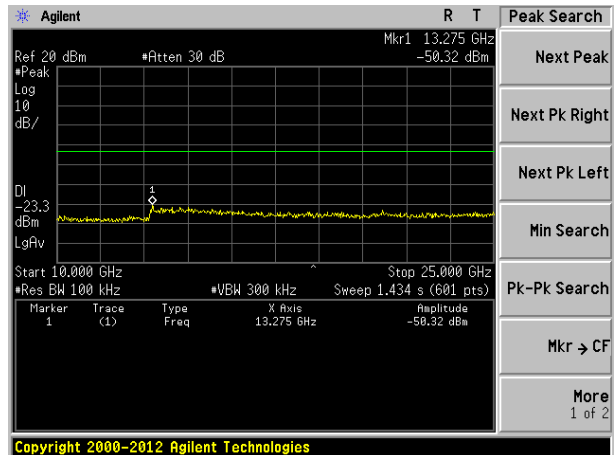

10GHz~25GHz

Highest channel

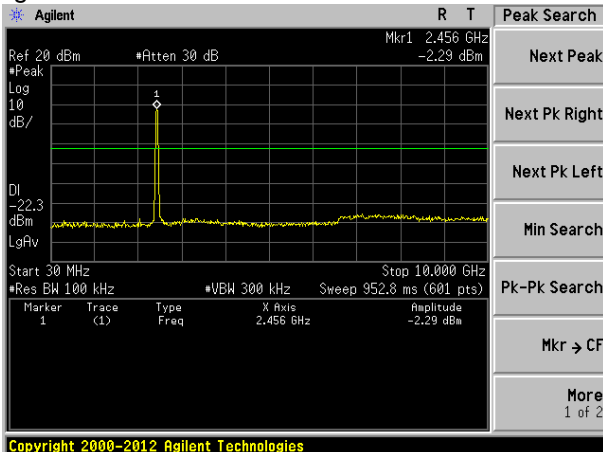

30MHz~10GHz

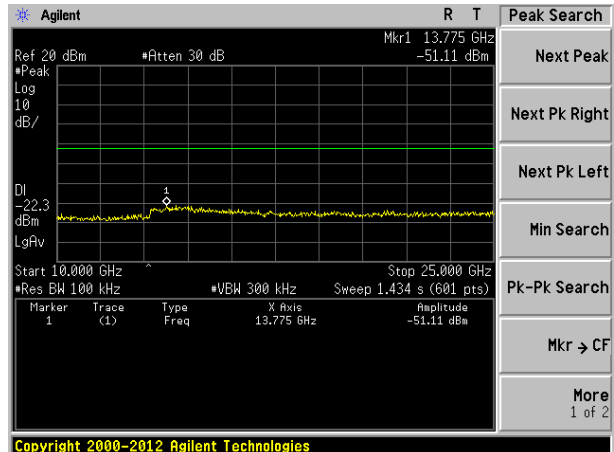

10GHz~25GHz

ANT2:

Test mode:	802.11b
------------	---------

Lowest channel

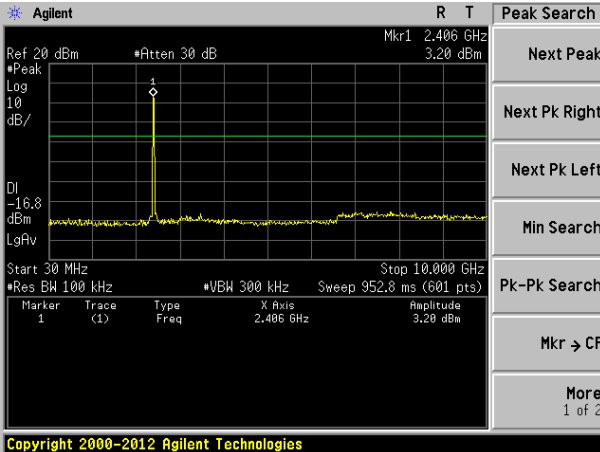

30MHz~10GHz

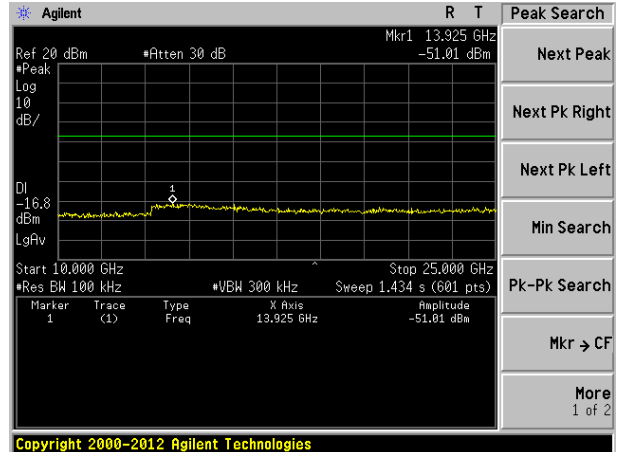

10GHz~25GHz

Middle channel

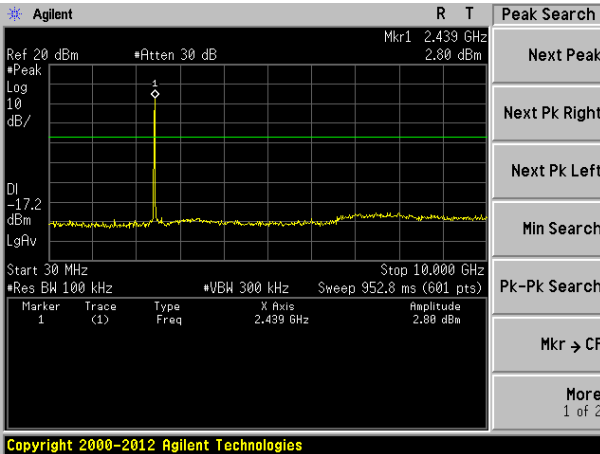

30MHz~10GHz

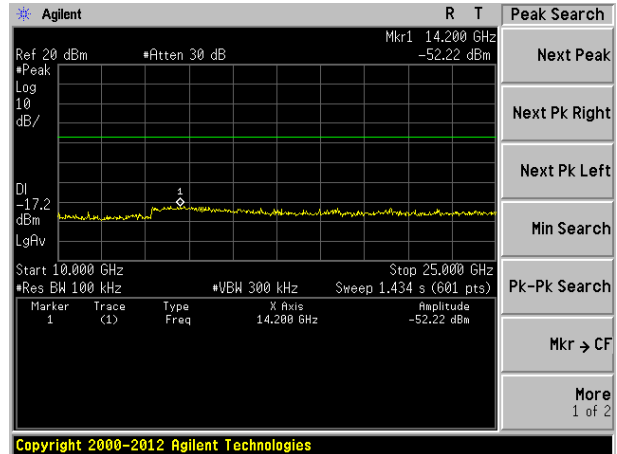

10GHz~25GHz

Highest channel

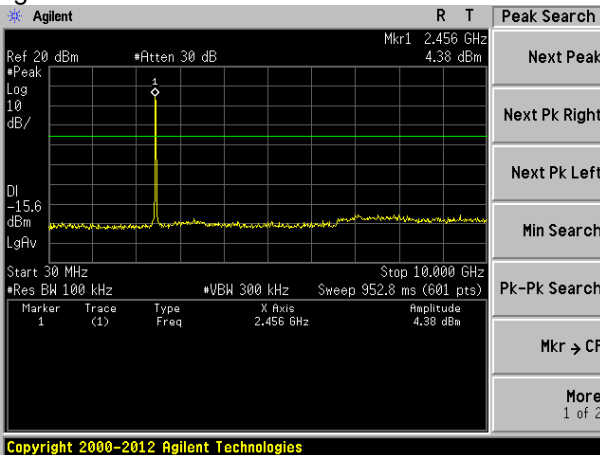

30MHz~10GHz

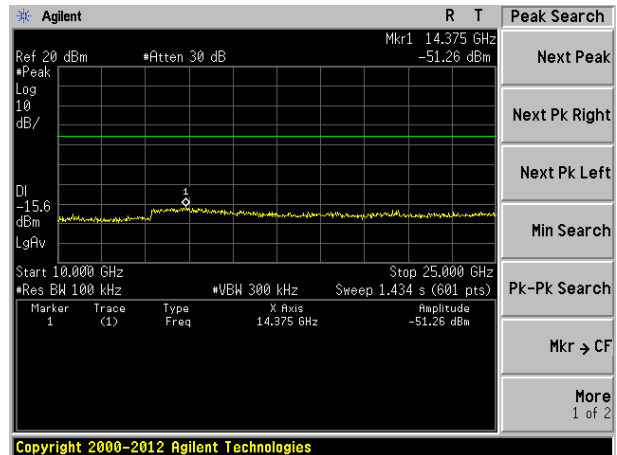

10GHz~25GHz

Test mode: 802.11g

Lowest channel

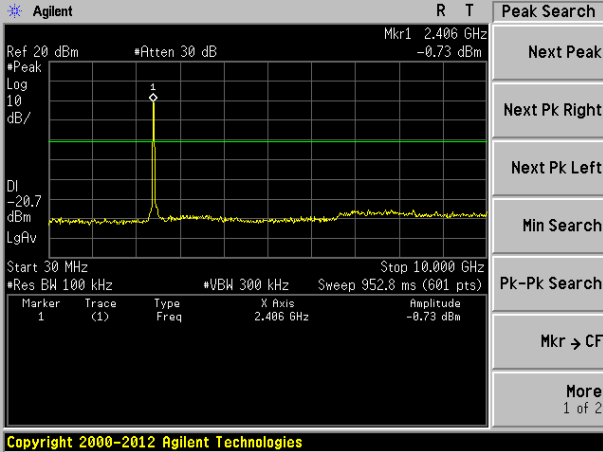

30MHz~10GHz

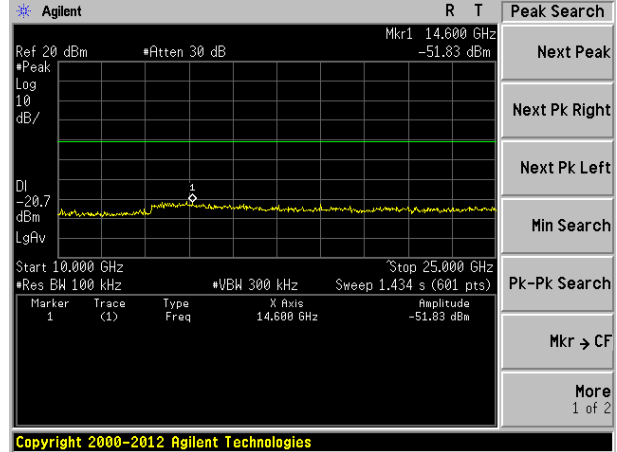

10GHz~25GHz

Middle channel

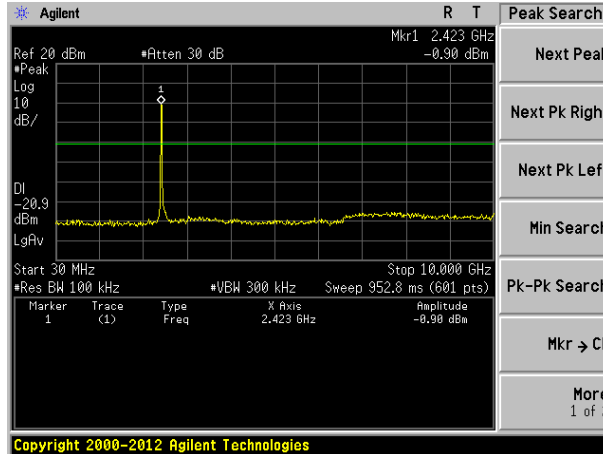

30MHz~10GHz

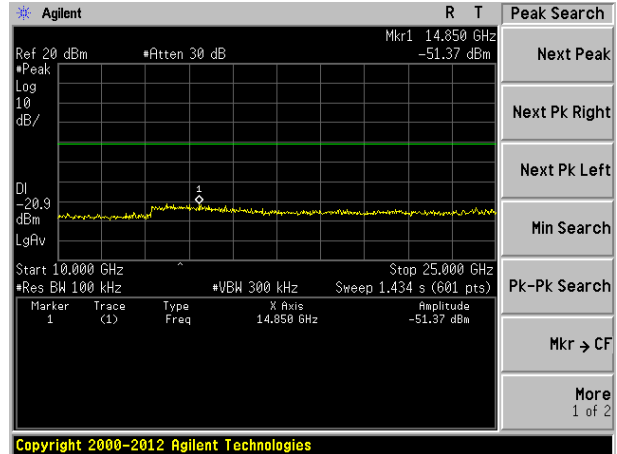

10GHz~25GHz

Highest channel

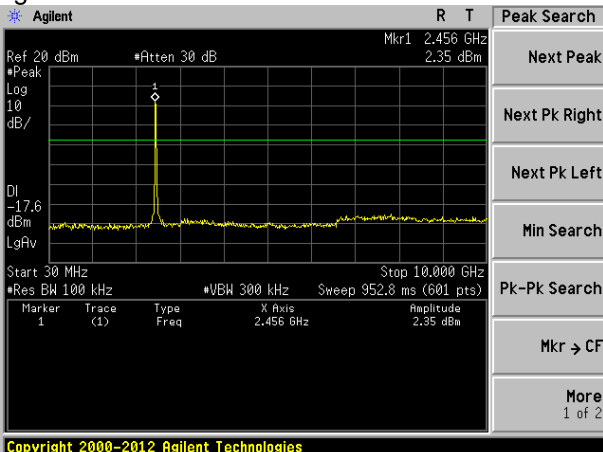

30MHz~10GHz

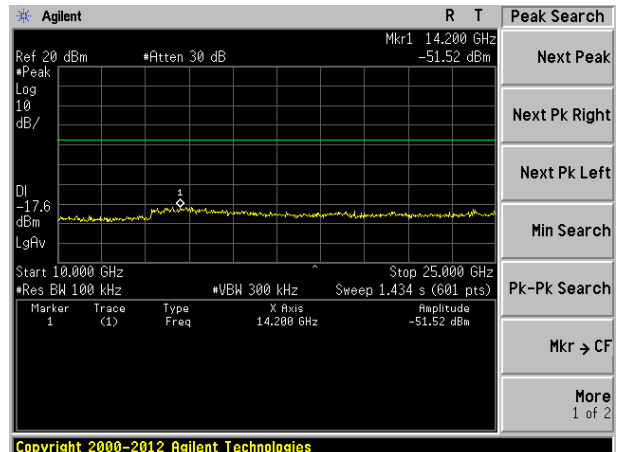

10GHz~25GHz

Test mode: 802.11n(HT20)

Lowest channel

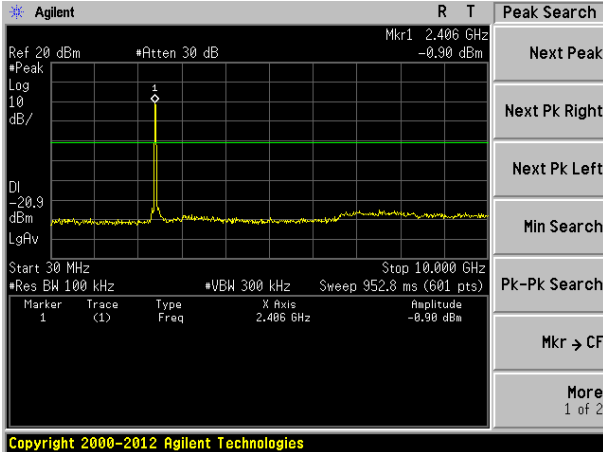

30MHz~10GHz

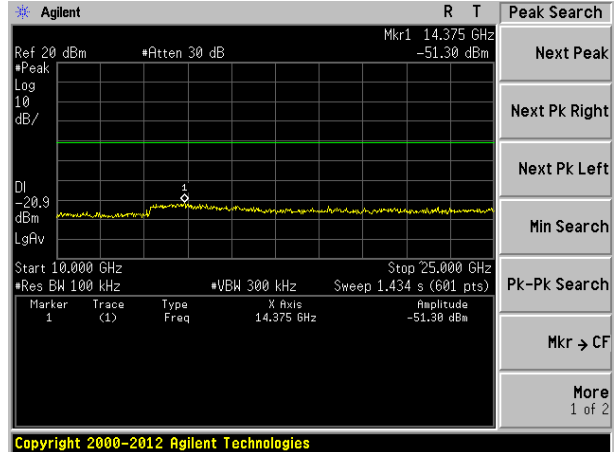

10GHz~25GHz

Middle channel

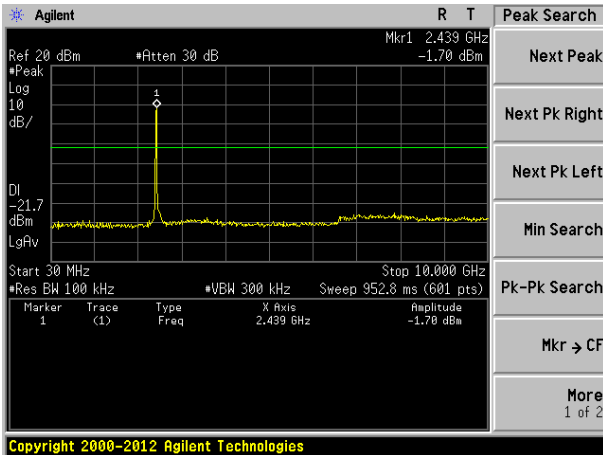

30MHz~10GHz

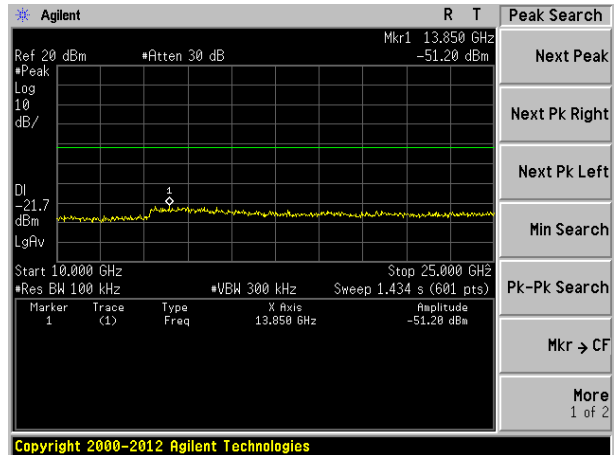

10GHz~25GHz

Highest channel

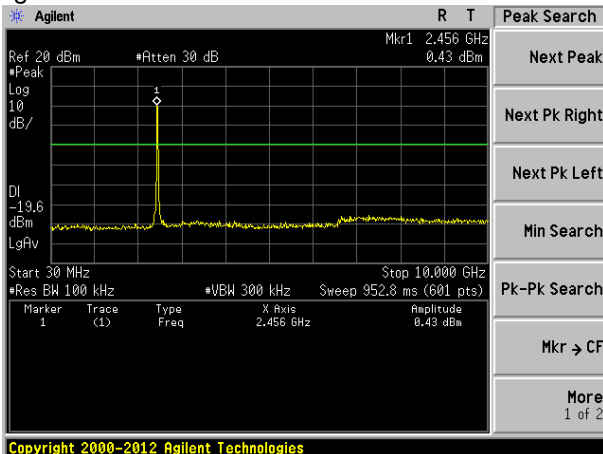

30MHz~10GHz

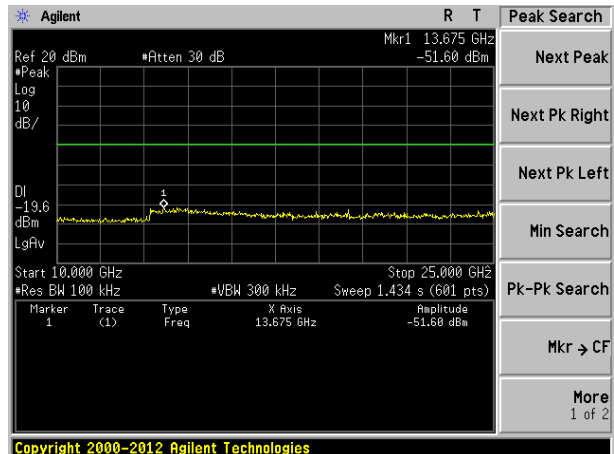

10GHz~25GHz

Test mode: 802.11n(HT40)

Lowest channel

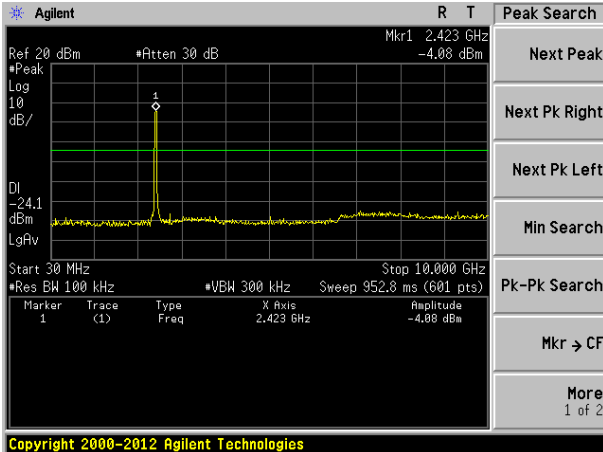

30MHz~10GHz

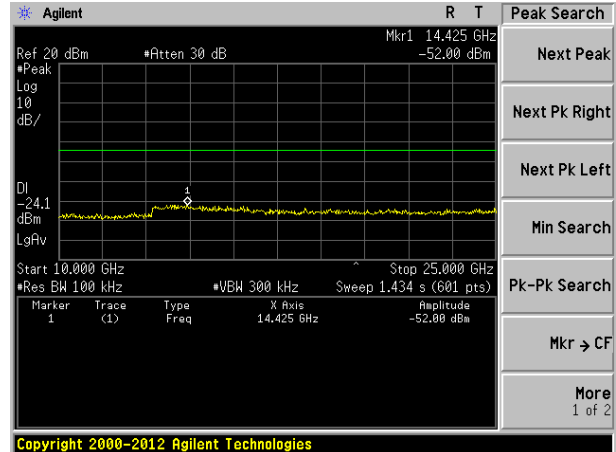

10GHz~25GHz

Middle channel

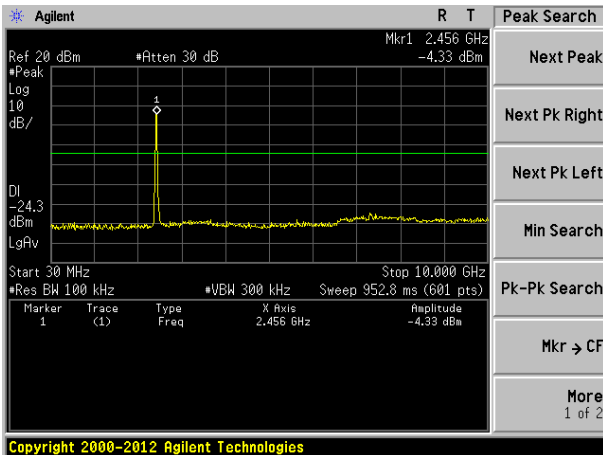

30MHz~10GHz

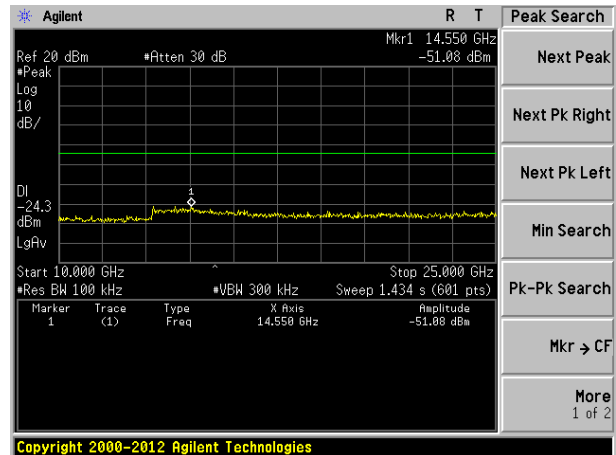

10GHz~25GHz

Highest channel

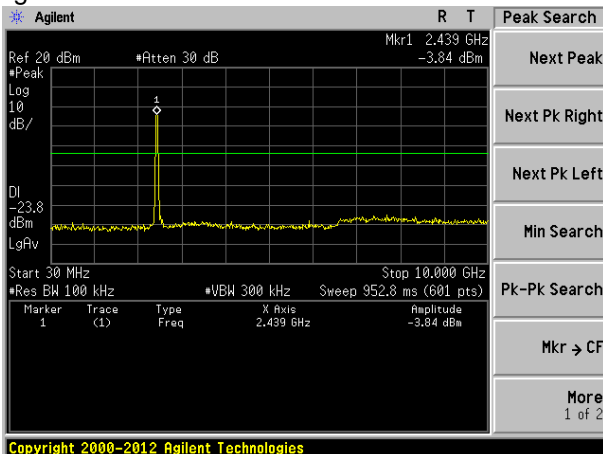

30MHz~10GHz

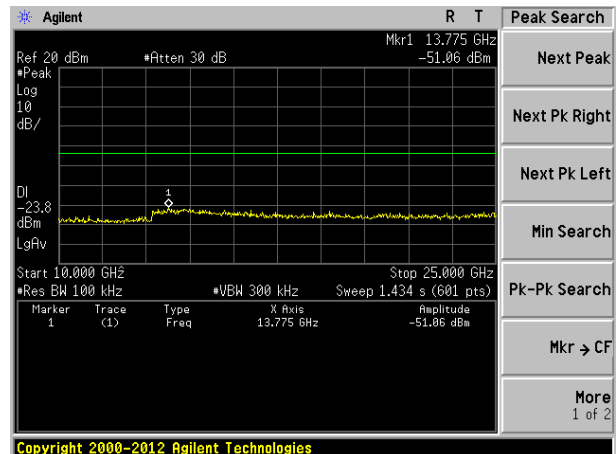

10GHz~25GHz

7.7.2 Radiated Emission Method

Test Requirement:	FCC Part15 C Section 15.209			
Test Method:	ANSI C63.10:2013			
Test Frequency Range:	30MHz to 25GHz			
Test site:	Measurement Distance: 3m			
Receiver setup:	Frequency	Detector	RBW	VBW
	30MHz-1GHz	Quasi-peak	120KHz	300KHz
	Above 1GHz	Peak	1MHz	3MHz
RMS		1MHz	3MHz	
Limit:	Frequency	Limit (dBuV/m @3m)	Value	
	30MHz-88MHz	40.00	Quasi-peak	
	88MHz-216MHz	43.50	Quasi-peak	
	216MHz-960MHz	46.00	Quasi-peak	
	960MHz-1GHz	54.00	Quasi-peak	
	Above 1GHz	54.00	Average	
74.00		Peak		
Test setup:	Below 1GHz			
Test setup:	Above 1GHz			

<p>Test Procedure:</p>	<ol style="list-style-type: none"> 1. The EUT was placed on the top of a rotating table (0.8 meters for below 1GHz and 1.5 meters for above 1GHz) above the ground at a 3 meter camber. The table was rotated 360 degrees to determine the position of the highest radiation. 2. The EUT was set 3 meters away from the interference-receiving antenna, which was mounted on the top of a variable-height antenna tower. 3. The antenna height is varied from one meter to four meters above the ground to determine the maximum value of the field strength. Both horizontal and vertical polarizations of the antenna are set to make the measurement. 4. For each suspected emission, the EUT was arranged to its worst case and then the antenna was tuned to heights from 1 meter to 4 meters and the rota table was turned from 0 degrees to 360 degrees to find the maximum reading. 5. The test-receiver system was set to Peak Detect Function and Specified Bandwidth with Maximum Hold Mode. 6. If the emission level of the EUT in peak mode was 10dB lower than the limit specified, then testing could be stopped and the peak values of the EUT would be reported. Otherwise the emissions that did not have 10dB margin would be re-tested one by one using peak, quasi-peak or average method as specified and then reported in a data sheet. 7. The radiation measurements are performed in X, Y, Z axis positioning. And found the Y axis positioning which it is worse case, only the test worst case mode is recorded in the report.
<p>Test Instruments:</p>	<p>Refer to section 6.0 for details</p>
<p>Test mode:</p>	<p>KEEPING MIMO Transmitter mode</p>
<p>Test results:</p>	<p>Pass</p>

Remark:

Pre-scan all kind of the place mode (X-axis, Y-axis, Z-axis), and found the Y-axis which it is worse case.

Measurement Data

■ Below 1GHz

ANT1+ANT2:

Frequency (MHz)	Read Level (dBuV)	Antenna Factor (dB/m)	Cable Loss (dB)	Preamp Factor (dB)	Level (dBuV/m)	Limit Line (dBuV/m)	Over Limit (dB)	polarization
42.01	43.49	15.57	0.69	30.03	29.72	40.00	-10.28	Vertical
61.56	39.51	14.03	0.87	29.91	24.50	40.00	-15.50	Vertical
114.52	37.90	13.42	1.31	29.60	23.03	43.50	-20.47	Vertical
202.81	38.11	12.64	1.86	29.23	23.38	43.50	-20.12	Vertical
383.93	42.50	16.68	2.78	29.57	32.39	46.00	-13.61	Vertical
556.77	42.18	19.67	3.55	29.30	36.10	46.00	-9.90	Vertical
55.61	37.71	14.97	0.82	29.95	23.55	40.00	-16.45	Horizontal
98.14	36.38	15.03	1.18	29.71	22.88	43.50	-20.62	Horizontal
229.29	47.70	13.62	2.01	29.47	33.86	46.00	-12.14	Horizontal
372.01	46.08	16.53	2.72	29.63	35.70	46.00	-10.30	Horizontal
568.61	37.51	19.93	3.59	29.30	31.73	46.00	-14.27	Horizontal
766.06	38.54	21.63	4.33	29.20	35.30	46.00	-10.70	Horizontal

■ Above 1GHz

ANT1+ANT2:

Test mode:	802.11b	Test channel:	Lowest
------------	---------	---------------	--------

Peak value:

Frequency (MHz)	Read Level (dBuV)	Antenna Factor (dB/m)	Cable Loss (dB)	Preamp Factor (dB)	Level (dBuV/m)	Limit Line (dBuV/m)	Over Limit (dB)	polarization
4824.00	40.73	31.79	8.62	32.10	49.04	74.00	-24.96	Vertical
7236.00	34.49	36.19	11.68	31.97	50.39	74.00	-23.61	Vertical
9648.00	32.91	38.07	14.16	31.56	53.58	74.00	-20.42	Vertical
12060.00	*					74.00		Vertical
14472.00	*					74.00		Vertical
16884.00	*					74.00		Vertical
4824.00	39.33	31.79	8.62	32.10	47.64	74.00	-26.36	Horizontal
7236.00	34.21	36.19	11.68	31.97	50.11	74.00	-23.89	Horizontal
9648.00	32.47	38.07	14.16	31.56	53.14	74.00	-20.86	Horizontal
12060.00	*					74.00		Horizontal
14472.00	*					74.00		Horizontal
16884.00	*					74.00		Horizontal

Average value:

Frequency (MHz)	Read Level (dBuV)	Antenna Factor (dB/m)	Cable Loss (dB)	Preamp Factor (dB)	Level (dBuV/m)	Limit Line (dBuV/m)	Over Limit (dB)	polarization
4824.00	29.78	31.79	8.62	32.10	38.09	54.00	-15.91	Vertical
7236.00	23.35	36.19	11.68	31.97	39.25	54.00	-14.75	Vertical
9648.00	23.25	38.07	14.16	31.56	43.92	54.00	-10.08	Vertical
12060.00	*					54.00		Vertical
14472.00	*					54.00		Vertical
16884.00	*					54.00		Vertical
4824.00	28.85	31.79	8.62	32.10	37.16	54.00	-16.84	Horizontal
7236.00	22.78	36.19	11.68	31.97	38.68	54.00	-15.32	Horizontal
9648.00	22.21	38.07	14.16	31.56	42.88	54.00	-11.12	Horizontal
12060.00	*					54.00		Horizontal
14472.00	*					54.00		Horizontal
16884.00	*					54.00		Horizontal

Remark:

1. Final Level = Receiver Read level + Antenna Factor + Cable Loss – Preamplifier Factor
2. “*”, means this data is the too weak instrument of signal is unable to test.

Test mode:	802.11b	Test channel:	Middle
------------	---------	---------------	--------

Peak value:

Frequency (MHz)	Read Level (dBuV)	Antenna Factor (dB/m)	Cable Loss (dB)	Preamp Factor (dB)	Level (dBuV/m)	Limit Line (dBuV/m)	Over Limit (dB)	polarization
4874.00	39.71	31.85	8.66	32.12	48.10	74.00	-25.90	Vertical
7311.00	34.52	36.37	11.71	31.91	50.69	74.00	-23.31	Vertical
9748.00	33.90	38.27	14.25	31.56	54.86	74.00	-19.14	Vertical
12185.00	*					74.00		Vertical
14622.00	*					74.00		Vertical
17059.00	*					74.00		Vertical
4874.00	40.13	31.85	8.66	32.12	48.52	74.00	-25.48	Horizontal
7311.00	33.13	36.37	11.71	31.91	49.30	74.00	-24.70	Horizontal
9748.00	33.77	38.27	14.25	31.56	54.73	74.00	-19.27	Horizontal
12185.00	*					74.00		Horizontal
14622.00	*					74.00		Horizontal
17059.00	*					74.00		Horizontal

Average value:

Frequency (MHz)	Read Level (dBuV)	Antenna Factor (dB/m)	Cable Loss (dB)	Preamp Factor (dB)	Level (dBuV/m)	Limit Line (dBuV/m)	Over Limit (dB)	polarization
4874.00	30.54	31.85	8.66	32.12	38.93	54.00	-15.07	Vertical
7311.00	22.83	36.37	11.71	31.91	39.00	54.00	-15.00	Vertical
9748.00	23.14	38.27	14.25	31.56	44.10	54.00	-9.90	Vertical
12185.00	*					54.00		Vertical
14622.00	*					54.00		Vertical
17059.00	*					54.00		Vertical
4874.00	30.23	31.85	8.66	32.12	38.62	54.00	-15.38	Horizontal
7311.00	22.21	36.37	11.71	31.91	38.38	54.00	-15.62	Horizontal
9748.00	23.48	38.27	14.25	31.56	44.44	54.00	-9.56	Horizontal
12185.00	*					54.00		Horizontal
14622.00	*					54.00		Horizontal
17059.00	*					54.00		Horizontal

Remark:

1. Final Level = Receiver Read level + Antenna Factor + Cable Loss – Pre-amplifier Factor
2. “*”, means this data is too weak instrument of signal is unable to test.

Test mode:	802.11b	Test channel:	Highest
------------	---------	---------------	---------

Peak value:

Frequency (MHz)	Read Level (dBuV)	Antenna Factor (dB/m)	Cable Loss (dB)	Preamp Factor (dB)	Level (dBuV/m)	Limit Line (dBuV/m)	Over Limit (dB)	polarization
4924.00	45.50	31.90	8.70	32.15	53.95	74.00	-20.05	Vertical
7386.00	35.36	36.49	11.76	31.83	51.78	74.00	-22.22	Vertical
9848.00	37.31	38.62	14.31	31.77	58.47	74.00	-15.53	Vertical
12310.00	*					74.00		Vertical
14772.00	*					74.00		Vertical
17234.00	*					74.00		Vertical
4924.00	44.71	31.90	8.70	32.15	53.16	74.00	-20.84	Horizontal
7386.00	34.21	36.49	11.76	31.83	50.63	74.00	-23.37	Horizontal
9848.00	33.46	38.62	14.31	31.77	54.62	74.00	-19.38	Horizontal
12310.00	*					74.00		Horizontal
14772.00	*					74.00		Horizontal
17234.00	*					74.00		Horizontal

Average value:

Frequency (MHz)	Read Level (dBuV)	Antenna Factor (dB/m)	Cable Loss (dB)	Preamp Factor (dB)	Level (dBuV/m)	Limit Line (dBuV/m)	Over Limit (dB)	polarization
4924.00	36.37	31.90	8.70	32.15	44.82	54.00	-9.18	Vertical
7386.00	25.26	36.49	11.76	31.83	41.68	54.00	-12.32	Vertical
9848.00	23.80	38.62	14.31	31.77	44.96	54.00	-9.04	Vertical
12310.00	*					54.00		Vertical
14772.00	*					54.00		Vertical
17234.00	*					54.00		Vertical
4924.00	35.04	31.90	8.70	32.15	43.49	54.00	-10.51	Horizontal
7386.00	23.59	36.49	11.76	31.83	40.01	54.00	-13.99	Horizontal
9848.00	22.71	38.62	14.31	31.77	43.87	54.00	-10.13	Horizontal
12310.00	*					54.00		Horizontal
14772.00	*					54.00		Horizontal
17234.00	*					54.00		Horizontal

Remark:

1. Final Level = Receiver Read level + Antenna Factor + Cable Loss – Pre-amplifier Factor
2. “*”, means this data is too weak instrument of signal is unable to test.

Test mode:	802.11g	Test channel:	lowest
------------	---------	---------------	--------

Peak value:

Frequency (MHz)	Read Level (dBuV)	Antenna Factor (dB/m)	Cable Loss (dB)	Preamp Factor (dB)	Level (dBuV/m)	Limit Line (dBuV/m)	Over Limit (dB)	polarization
4824.00	39.27	31.79	8.62	32.10	47.58	74.00	-26.42	Vertical
7236.00	33.57	36.19	11.68	31.97	49.47	74.00	-24.53	Vertical
9648.00	32.25	38.07	14.16	31.56	52.92	74.00	-21.08	Vertical
12060.00	*					74.00		Vertical
14472.00	*					74.00		Vertical
16884.00	*					74.00		Vertical
4824.00	38.09	31.79	8.62	32.10	46.40	74.00	-27.60	Horizontal
7236.00	33.40	36.19	11.68	31.97	49.30	74.00	-24.70	Horizontal
9648.00	31.86	38.07	14.16	31.56	52.53	74.00	-21.47	Horizontal
12060.00	*					74.00		Horizontal
14472.00	*					74.00		Horizontal
16884.00	*					74.00		Horizontal

Average value:

Frequency (MHz)	Read Level (dBuV)	Antenna Factor (dB/m)	Cable Loss (dB)	Preamp Factor (dB)	Level (dBuV/m)	Limit Line (dBuV/m)	Over Limit (dB)	polarization
4824.00	28.43	31.79	8.62	32.10	36.74	54.00	-17.26	Vertical
7236.00	22.46	36.19	11.68	31.97	38.36	54.00	-15.64	Vertical
9648.00	22.61	38.07	14.16	31.56	43.28	54.00	-10.72	Vertical
12060.00	*					54.00		Vertical
14472.00	*					54.00		Vertical
16884.00	*					54.00		Vertical
4824.00	27.69	31.79	8.62	32.10	36.00	54.00	-18.00	Horizontal
7236.00	22.00	36.19	11.68	31.97	37.90	54.00	-16.10	Horizontal
9648.00	21.63	38.07	14.16	31.56	42.30	54.00	-11.70	Horizontal
12060.00	*					54.00		Horizontal
14472.00	*					54.00		Horizontal
16884.00	*					54.00		Horizontal

Remark:

1. Final Level = Receiver Read level + Antenna Factor + Cable Loss – Pre-amplifier Factor
2. “*”, means this data is too weak instrument of signal is unable to test.

Test mode:	802.11g	Test channel:	Middle
------------	---------	---------------	--------

Peak value:

Frequency (MHz)	Read Level (dBuV)	Antenna Factor (dB/m)	Cable Loss (dB)	Preamp Factor (dB)	Level (dBuV/m)	Limit Line (dBuV/m)	Over Limit (dB)	polarization
4874.00	38.50	31.85	8.66	32.12	46.89	74.00	-27.11	Vertical
7311.00	33.75	36.37	11.71	31.91	49.92	74.00	-24.08	Vertical
9748.00	33.35	38.27	14.25	31.56	54.31	74.00	-19.69	Vertical
12185.00	*					74.00		Vertical
14622.00	*					74.00		Vertical
17059.00	*					74.00		Vertical
4874.00	39.11	31.85	8.66	32.12	47.50	74.00	-26.50	Horizontal
7311.00	32.46	36.37	11.71	31.91	48.63	74.00	-25.37	Horizontal
9748.00	33.27	38.27	14.25	31.56	54.23	74.00	-19.77	Horizontal
12185.00	*					74.00		Horizontal
14622.00	*					74.00		Horizontal
17059.00	*					74.00		Horizontal

Average value:

Frequency (MHz)	Read Level (dBuV)	Antenna Factor (dB/m)	Cable Loss (dB)	Preamp Factor (dB)	Level (dBuV/m)	Limit Line (dBuV/m)	Over Limit (dB)	polarization
4874.00	29.42	31.85	8.66	32.12	37.81	54.00	-16.19	Vertical
7311.00	22.09	36.37	11.71	31.91	38.26	54.00	-15.74	Vertical
9748.00	22.62	38.27	14.25	31.56	43.58	54.00	-10.42	Vertical
12185.00	*					54.00		Vertical
14622.00	*					54.00		Vertical
17059.00	*					54.00		Vertical
4874.00	29.27	31.85	8.66	32.12	37.66	54.00	-16.34	Horizontal
7311.00	21.56	36.37	11.71	31.91	37.73	54.00	-16.27	Horizontal
9748.00	23.00	38.27	14.25	31.56	43.96	54.00	-10.04	Horizontal
12185.00	*					54.00		Horizontal
14622.00	*					54.00		Horizontal
17059.00	*					54.00		Horizontal

Remark:

1. Final Level = Receiver Read level + Antenna Factor + Cable Loss – Pre-amplifier Factor
2. “*”, means this data is too weak instrument of signal is unable to test.

Test mode:	802.11g	Test channel:	Highest
------------	---------	---------------	---------

Peak value:

Frequency (MHz)	Read Level (dBuV)	Antenna Factor (dB/m)	Cable Loss (dB)	Preamp Factor (dB)	Level (dBuV/m)	Limit Line (dBuV/m)	Over Limit (dB)	polarization
4924.00	43.41	31.90	8.70	32.15	51.86	74.00	-22.14	Vertical
7386.00	34.04	36.49	11.76	31.83	50.46	74.00	-23.54	Vertical
9848.00	36.37	38.62	14.31	31.77	57.53	74.00	-16.47	Vertical
12310.00	*					74.00		Vertical
14772.00	*					74.00		Vertical
17234.00	*					74.00		Vertical
4924.00	42.95	31.90	8.70	32.15	51.40	74.00	-22.60	Horizontal
7386.00	33.06	36.49	11.76	31.83	49.48	74.00	-24.52	Horizontal
9848.00	32.59	38.62	14.31	31.77	53.75	74.00	-20.25	Horizontal
12310.00	*					74.00		Horizontal
14772.00	*					74.00		Horizontal
17234.00	*					74.00		Horizontal

Average value:

Frequency (MHz)	Read Level (dBuV)	Antenna Factor (dB/m)	Cable Loss (dB)	Preamp Factor (dB)	Level (dBuV/m)	Limit Line (dBuV/m)	Over Limit (dB)	polarization
4924.00	34.44	31.90	8.70	32.15	42.89	54.00	-11.11	Vertical
7386.00	23.99	36.49	11.76	31.83	40.41	54.00	-13.59	Vertical
9848.00	22.90	38.62	14.31	31.77	44.06	54.00	-9.94	Vertical
12310.00	*					54.00		Vertical
14772.00	*					54.00		Vertical
17234.00	*					54.00		Vertical
4924.00	33.39	31.90	8.70	32.15	41.84	54.00	-12.16	Horizontal
7386.00	22.47	36.49	11.76	31.83	38.89	54.00	-15.11	Horizontal
9848.00	21.87	38.62	14.31	31.77	43.03	54.00	-10.97	Horizontal
12310.00	*					54.00		Horizontal
14772.00	*					54.00		Horizontal
17234.00	*					54.00		Horizontal

Remark:

1. Final Level = Receiver Read level + Antenna Factor + Cable Loss – Pre-amplifier Factor
2. “*”, means this data is too weak instrument of signal is unable to test.

Test mode:	802.11n(HT20)	Test channel:	Lowest
------------	---------------	---------------	--------

Peak value:

Frequency (MHz)	Read Level (dBuV)	Antenna Factor (dB/m)	Cable Loss (dB)	Preamp Factor (dB)	Level (dBuV/m)	Limit Line (dBuV/m)	Over Limit (dB)	polarization
4824.00	38.78	31.79	8.62	32.10	47.09	74.00	-26.91	Vertical
7236.00	33.26	36.19	11.68	31.97	49.16	74.00	-24.84	Vertical
9648.00	32.03	38.07	14.16	31.56	52.70	74.00	-21.30	Vertical
12060.00	*					74.00		Vertical
14472.00	*					74.00		Vertical
16884.00	*					74.00		Vertical
4824.00	37.69	31.79	8.62	32.10	46.00	74.00	-28.00	Horizontal
7236.00	33.13	36.19	11.68	31.97	49.03	74.00	-24.97	Horizontal
9648.00	31.66	38.07	14.16	31.56	52.33	74.00	-21.67	Horizontal
12060.00	*					74.00		Horizontal
14472.00	*					74.00		Horizontal
16884.00	*					74.00		Horizontal

Average value:

Frequency (MHz)	Read Level (dBuV)	Antenna Factor (dB/m)	Cable Loss (dB)	Preamp Factor (dB)	Level (dBuV/m)	Limit Line (dBuV/m)	Over Limit (dB)	polarization
4824.00	27.98	31.79	8.62	32.10	36.29	54.00	-17.71	Vertical
7236.00	22.16	36.19	11.68	31.97	38.06	54.00	-15.94	Vertical
9648.00	22.40	38.07	14.16	31.56	43.07	54.00	-10.93	Vertical
12060.00	*					54.00		Vertical
14472.00	*					54.00		Vertical
16884.00	*					54.00		Vertical
4824.00	27.30	31.79	8.62	32.10	35.61	54.00	-18.39	Horizontal
7236.00	21.74	36.19	11.68	31.97	37.64	54.00	-16.36	Horizontal
9648.00	21.43	38.07	14.16	31.56	42.10	54.00	-11.90	Horizontal
12060.00	*					54.00		Horizontal
14472.00	*					54.00		Horizontal
16884.00	*					54.00		Horizontal

Remark:

1. $Final\ Level = Receiver\ Read\ level + Antenna\ Factor + Cable\ Loss - Preamplifier\ Factor$
2. “*”, means this data is the too weak instrument of signal is unable to test.

Test mode:	802.11n(HT20)	Test channel:	Middle
------------	---------------	---------------	--------

Peak value:

Frequency (MHz)	Read Level (dBuV)	Antenna Factor (dB/m)	Cable Loss (dB)	Preamp Factor (dB)	Level (dBuV/m)	Limit Line (dBuV/m)	Over Limit (dB)	polarization
4874.00	38.10	31.85	8.66	32.12	46.49	74.00	-27.51	Vertical
7311.00	33.50	36.37	11.71	31.91	49.67	74.00	-24.33	Vertical
9748.00	33.17	38.27	14.25	31.56	54.13	74.00	-19.87	Vertical
12185.00	*					74.00		Vertical
14622.00	*					74.00		Vertical
17059.00	*					74.00		Vertical
4874.00	38.77	31.85	8.66	32.12	47.16	74.00	-26.84	Horizontal
7311.00	32.24	36.37	11.71	31.91	48.41	74.00	-25.59	Horizontal
9748.00	33.10	38.27	14.25	31.56	54.06	74.00	-19.94	Horizontal
12185.00	*					74.00		Horizontal
14622.00	*					74.00		Horizontal
17059.00	*					74.00		Horizontal

Average value:

Frequency (MHz)	Read Level (dBuV)	Antenna Factor (dB/m)	Cable Loss (dB)	Preamp Factor (dB)	Level (dBuV/m)	Limit Line (dBuV/m)	Over Limit (dB)	polarization
4874.00	29.05	31.85	8.66	32.12	37.44	54.00	-16.56	Vertical
7311.00	21.84	36.37	11.71	31.91	38.01	54.00	-15.99	Vertical
9748.00	22.44	38.27	14.25	31.56	43.40	54.00	-10.60	Vertical
12185.00	*					54.00		Vertical
14622.00	*					54.00		Vertical
17059.00	*					54.00		Vertical
4874.00	28.95	31.85	8.66	32.12	37.34	54.00	-16.66	Horizontal
7311.00	21.35	36.37	11.71	31.91	37.52	54.00	-16.48	Horizontal
9748.00	22.83	38.27	14.25	31.56	43.79	54.00	-10.21	Horizontal
12185.00	*					54.00		Horizontal
14622.00	*					54.00		Horizontal
17059.00	*					54.00		Horizontal

Remark:

1. Final Level = Receiver Read level + Antenna Factor + Cable Loss – Pre-amplifier Factor
2. “*”, means this data is the too weak instrument of signal is unable to test.

Test mode:	802.11n(HT20)	Test channel:	Highest
------------	---------------	---------------	---------

Peak value:

Frequency (MHz)	Read Level (dBuV)	Antenna Factor (dB/m)	Cable Loss (dB)	Preamp Factor (dB)	Level (dBuV/m)	Limit Line (dBuV/m)	Over Limit (dB)	polarization
4924.00	42.72	31.90	8.70	32.15	51.17	74.00	-22.83	Vertical
7386.00	33.60	36.49	11.76	31.83	50.02	74.00	-23.98	Vertical
9848.00	36.05	38.62	14.31	31.77	57.21	74.00	-16.79	Vertical
12310.00	*					74.00		Vertical
14772.00	*					74.00		Vertical
17234.00	*					74.00		Vertical
4924.00	42.37	31.90	8.70	32.15	50.82	74.00	-23.18	Horizontal
7386.00	32.67	36.49	11.76	31.83	49.09	74.00	-24.91	Horizontal
9848.00	32.30	38.62	14.31	31.77	53.46	74.00	-20.54	Horizontal
12310.00	*					74.00		Horizontal
14772.00	*					74.00		Horizontal
17234.00	*					74.00		Horizontal

Average value:

Frequency (MHz)	Read Level (dBuV)	Antenna Factor (dB/m)	Cable Loss (dB)	Preamp Factor (dB)	Level (dBuV/m)	Limit Line (dBuV/m)	Over Limit (dB)	polarization
4924.00	33.81	31.90	8.70	32.15	42.26	54.00	-11.74	Vertical
7386.00	23.57	36.49	11.76	31.83	39.99	54.00	-14.01	Vertical
9848.00	22.60	38.62	14.31	31.77	43.76	54.00	-10.24	Vertical
12310.00	*					54.00		Vertical
14772.00	*					54.00		Vertical
17234.00	*					54.00		Vertical
4924.00	32.84	31.90	8.70	32.15	41.29	54.00	-12.71	Horizontal
7386.00	22.10	36.49	11.76	31.83	38.52	54.00	-15.48	Horizontal
9848.00	21.59	38.62	14.31	31.77	42.75	54.00	-11.25	Horizontal
12310.00	*					54.00		Horizontal
14772.00	*					54.00		Horizontal
17234.00	*					54.00		Horizontal

Remark:

- 1 Final Level = Receiver Read level + Antenna Factor + Cable Loss – Preamplifier Factor
- 2 “*”, means this data is the too weak instrument of signal is unable to test.

Test mode:	802.11n(HT40)	Test channel:	Lowest
------------	---------------	---------------	--------

Peak value:

Frequency (MHz)	Read Level (dBuV)	Antenna Factor (dB/m)	Cable Loss (dB)	Preamp Factor (dB)	Level (dBuV/m)	Limit Line (dBuV/m)	Over Limit (dB)	polarization
4844.00	38.35	31.81	8.63	32.11	46.68	74.00	-27.32	Vertical
7266.00	32.99	36.28	11.69	31.94	49.02	74.00	-24.98	Vertical
9688.00	31.84	38.13	14.21	31.52	52.66	74.00	-21.34	Vertical
12060.00	*					74.00		Vertical
14472.00	*					74.00		Vertical
16884.00	*					74.00		Vertical
4844.00	37.32	31.81	8.63	32.11	45.65	74.00	-28.35	Horizontal
7266.00	32.89	36.28	11.69	31.94	48.92	74.00	-25.08	Horizontal
9688.00	31.48	38.13	14.21	31.52	52.30	74.00	-21.70	Horizontal
12060.00	*					74.00		Horizontal
14472.00	*					74.00		Horizontal
16884.00	*					74.00		Horizontal

Average value:

Frequency (MHz)	Read Level (dBuV)	Antenna Factor (dB/m)	Cable Loss (dB)	Preamp Factor (dB)	Level (dBuV/m)	Limit Line (dBuV/m)	Over Limit (dB)	polarization
4844.00	27.59	31.81	8.63	32.11	35.92	54.00	-18.08	Vertical
7266.00	21.90	36.28	11.69	31.94	37.93	54.00	-16.07	Vertical
9688.00	22.22	38.13	14.21	31.52	43.04	54.00	-10.96	Vertical
12060.00	*					54.00		Vertical
14472.00	*					54.00		Vertical
16884.00	*					54.00		Vertical
4844.00	26.96	31.81	8.63	32.11	35.29	54.00	-18.71	Horizontal
7266.00	21.51	36.28	11.69	31.94	37.54	54.00	-16.46	Horizontal
9688.00	21.26	38.13	14.21	31.52	42.08	54.00	-11.92	Horizontal
12060.00	*					54.00		Horizontal
14472.00	*					54.00		Horizontal
16884.00	*					54.00		Horizontal

Remark:

1. Final Level = Receiver Read level + Antenna Factor + Cable Loss – Pre-amplifier Factor
2. “*”, means this data is the too weak instrument of signal is unable to test.

Test mode:	802.11n(HT40)	Test channel:	Middle
------------	---------------	---------------	--------

Peak value:

Frequency (MHz)	Read Level (dBuV)	Antenna Factor (dB/m)	Cable Loss (dB)	Preamp Factor (dB)	Level (dBuV/m)	Limit Line (dBuV/m)	Over Limit (dB)	polarization
4874.00	37.74	31.85	8.66	32.12	46.13	74.00	-27.87	Vertical
7311.00	33.27	36.37	11.71	31.91	49.44	74.00	-24.56	Vertical
9748.00	33.01	38.27	14.25	31.56	53.97	74.00	-20.03	Vertical
12185.00	*					74.00		Vertical
14622.00	*					74.00		Vertical
17059.00	*					74.00		Vertical
4874.00	38.47	31.85	8.66	32.12	46.86	74.00	-27.14	Horizontal
7311.00	32.04	36.37	11.71	31.91	48.21	74.00	-25.79	Horizontal
9748.00	32.95	38.27	14.25	31.56	53.91	74.00	-20.09	Horizontal
12185.00	*					74.00		Horizontal
14622.00	*					74.00		Horizontal
17059.00	*					74.00		Horizontal

Average value:

Frequency (MHz)	Read Level (dBuV)	Antenna Factor (dB/m)	Cable Loss (dB)	Preamp Factor (dB)	Level (dBuV/m)	Limit Line (dBuV/m)	Over Limit (dB)	polarization
4874.00	28.72	31.85	8.66	32.12	37.11	54.00	-16.89	Vertical
7311.00	21.62	36.37	11.71	31.91	37.79	54.00	-16.21	Vertical
9748.00	22.29	38.27	14.25	31.56	43.25	54.00	-10.75	Vertical
12185.00	*					54.00		Vertical
14622.00	*					54.00		Vertical
17059.00	*					54.00		Vertical
4874.00	28.67	31.85	8.66	32.12	37.06	54.00	-16.94	Horizontal
7311.00	21.16	36.37	11.71	31.91	37.33	54.00	-16.67	Horizontal
9748.00	22.69	38.27	14.25	31.56	43.65	54.00	-10.35	Horizontal
12185.00	*					54.00		Horizontal
14622.00	*					54.00		Horizontal
17059.00	*					54.00		Horizontal

Remark:

1. Final Level = Receiver Read level + Antenna Factor + Cable Loss – Preamplifier Factor
2. “*”, means this data is the too weak instrument of signal is unable to test.

Test mode:	802.11n(HT40)	Test channel:	Highest
------------	---------------	---------------	---------

Peak value:

Frequency (MHz)	Read Level (dBuV)	Antenna Factor (dB/m)	Cable Loss (dB)	Preamp Factor (dB)	Level (dBuV/m)	Limit Line (dBuV/m)	Over Limit (dB)	polarization
4904.00	42.11	31.88	8.68	32.13	50.54	74.00	-23.46	Vertical
7356.00	33.21	36.45	11.75	31.86	49.55	74.00	-24.45	Vertical
9808.00	35.78	38.43	14.29	31.68	56.82	74.00	-17.18	Vertical
12310.00	*					74.00		Vertical
14772.00	*					74.00		Vertical
17234.00	*					74.00		Vertical
4904.00	41.85	31.88	8.68	32.13	50.28	74.00	-23.72	Horizontal
7356.00	32.33	36.45	11.75	31.86	48.67	74.00	-25.33	Horizontal
9808.00	32.04	38.43	14.29	31.68	53.08	74.00	-20.92	Horizontal
12310.00	*					74.00		Horizontal
14772.00	*					74.00		Horizontal
17234.00	*					74.00		Horizontal

Average value:

Frequency (MHz)	Read Level (dBuV)	Antenna Factor (dB/m)	Cable Loss (dB)	Preamp Factor (dB)	Level (dBuV/m)	Limit Line (dBuV/m)	Over Limit (dB)	polarization
4904.00	33.24	31.88	8.68	32.13	41.67	54.00	-12.33	Vertical
7356.00	23.19	36.45	11.75	31.86	39.53	54.00	-14.47	Vertical
9808.00	22.33	38.43	14.29	31.68	43.37	54.00	-10.63	Vertical
12310.00	*					54.00		Vertical
14772.00	*					54.00		Vertical
17234.00	*					54.00		Vertical
4904.00	32.35	31.88	8.68	32.13	40.78	54.00	-13.22	Horizontal
7356.00	21.77	36.45	11.75	31.86	38.11	54.00	-15.89	Horizontal
9808.00	21.35	38.43	14.29	31.68	42.39	54.00	-11.61	Horizontal
12310.00	*					54.00		Horizontal
14772.00	*					54.00		Horizontal
17234.00	*					54.00		Horizontal

Remark:

- 1 Final Level = Receiver Read level + Antenna Factor + Cable Loss – Preamplifier Factor
- 2 “*”, means this data is the too weak instrument of signal is unable to test.

8 Test Setup Photo

Radiated Emission

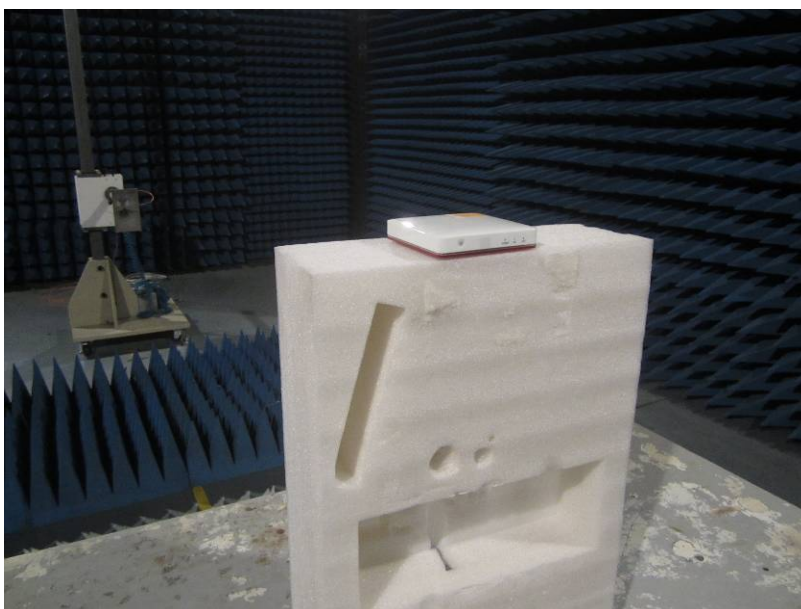

Conducted Emission



9 EUT Constructional Details

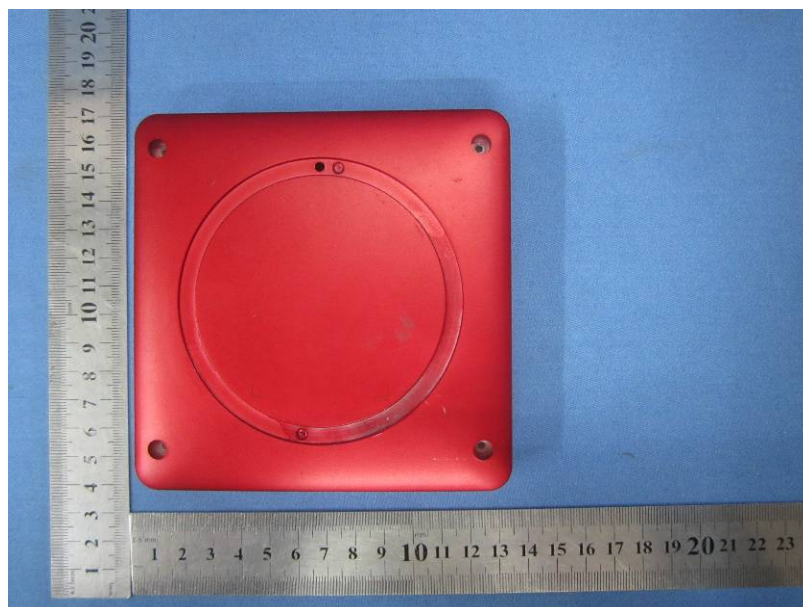
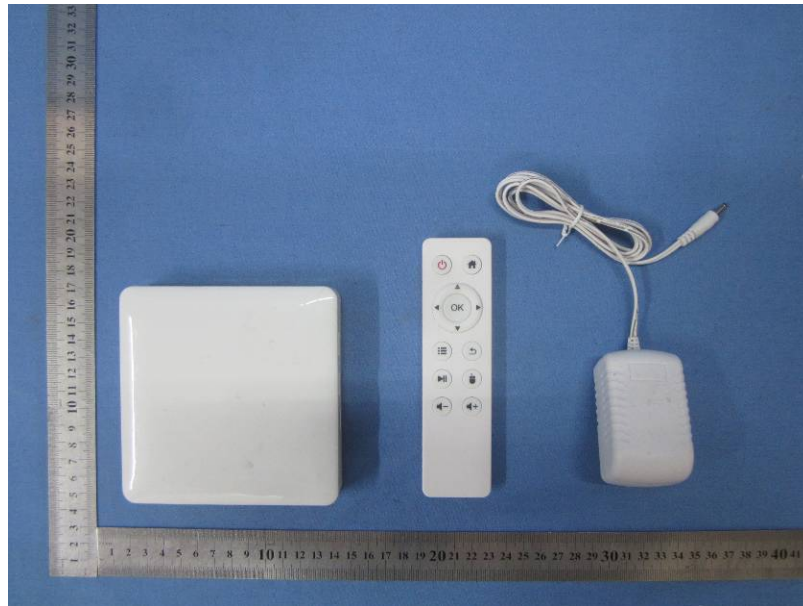

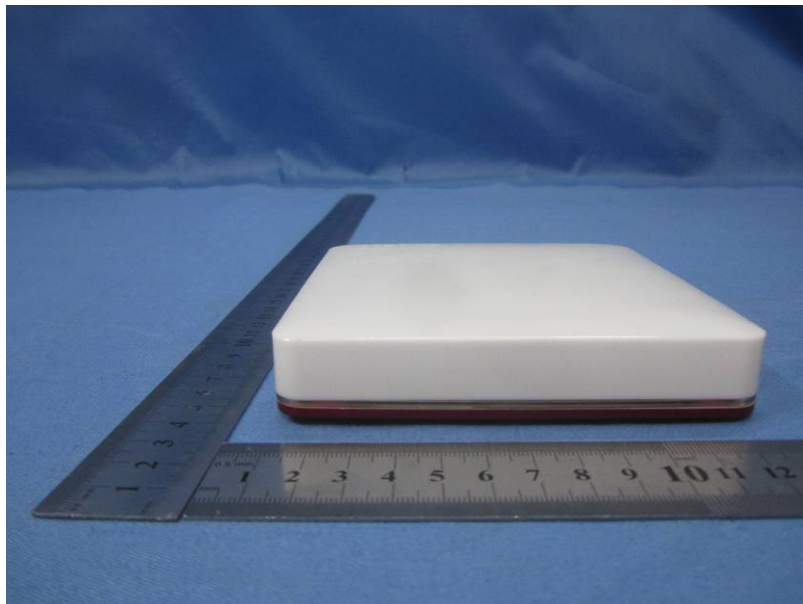
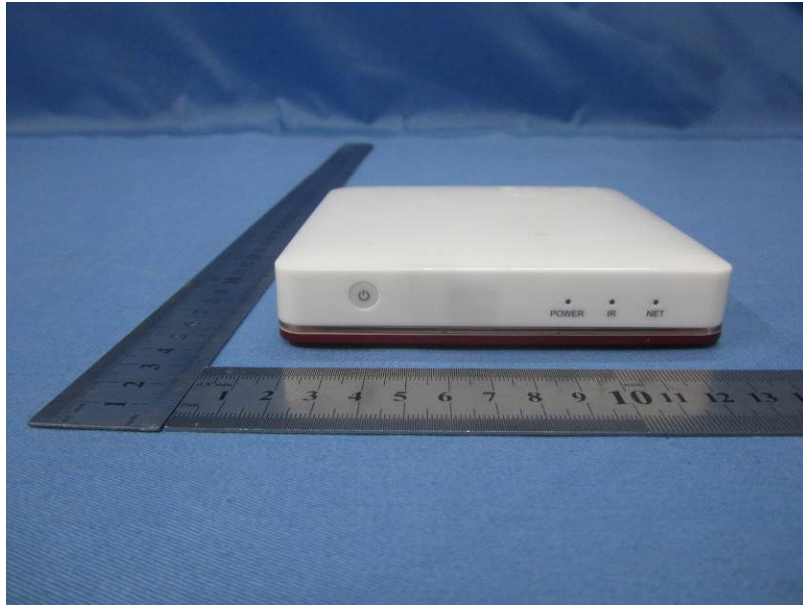



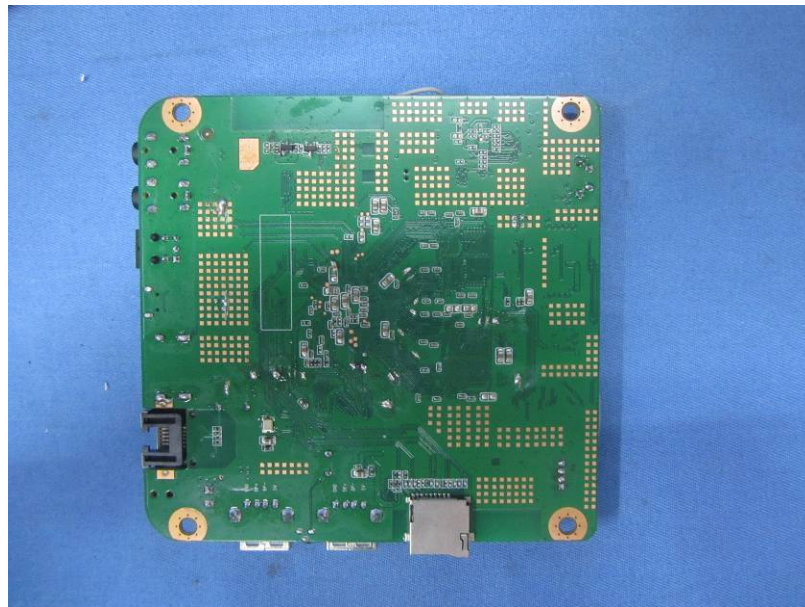
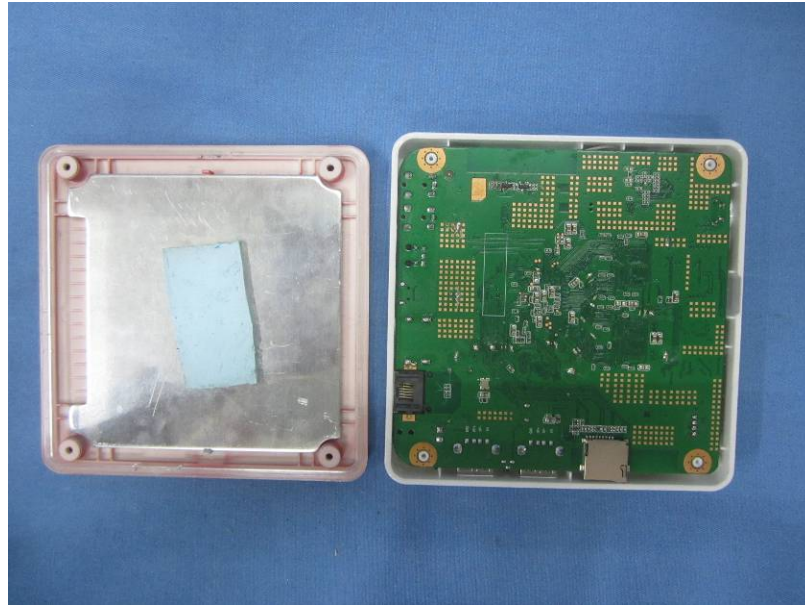

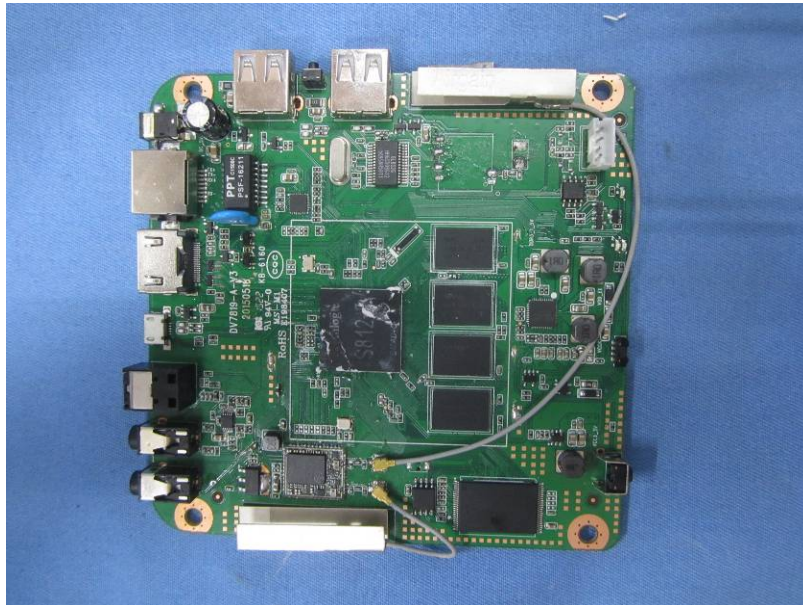
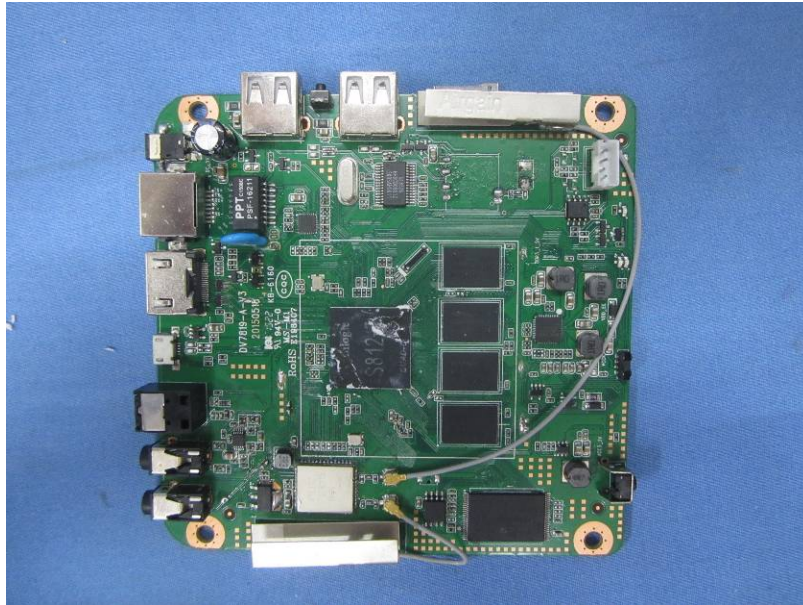



-----end-----