

FCC Test Report

Part 15 subpart C

Client Information:

Applicant: BoomPods (HK) LTD.
Applicant add.: RM 303-304 Hankow Centre 5-15, Hankow Road T.S.T. Kowloon, HONG KONG.

Product Information:

EUT Name: Sport Bluetooth headset
Model No.: sportpods RACE, sportpods ENDURO
Brand Name: BoomPods
FCC ID: 2AFAX-SPR-SPE

Standards: FCC PART 15 Subpart C: 2016 section 15.247

Test procedure used: ANSI C63.10-2013

Prepared By:

ATS Electronic Technology Co., Ltd.

Add. : 3/F, Building A, No. 1 Hedong Three Road, Jinxia Community, Changan Town,
DongGuan City, GuangDong, P.R.China

Date of Receipt: May 15, 2016 Date of Test: May 16~22, 2016
Date of Issue: May 23, 2016 Test Result: Pass

This device described above has been tested by ATS Electronic Technology Co., Ltd., and the test results show that the equipment under test (EUT) is in compliance with the FCC requirements. And it is applicable only to the tested sample identified in the report.

*This test report must not be used by the client to claim product endorsement by any agency of the U.S. government.

Reviewed by: Vera Wang

Approved by: Simon Zeng

1 Contents

	Page
COVER PAGE	
1 CONTENTS	2
2 TEST SUMMARY	4
2.1 COMPLIANCE WITH FCC PART 15 SUBPART C	4
2.2 MEASUREMENT UNCERTAINTY	5
2.3 TEST LOCATION	5
3 GENERAL INFORMATION	6
3.1 GENERAL DESCRIPTION OF EUT	6
3.2 DESCRIPTION OF TEST CONDITIONS	8
3.3 TEST PERIPHERAL LIST	9
3.4 EUT PERIPHERAL LIST	9
4 EQUIPMENTS LIST FOR ALL TEST ITEMS	10
5 TEST RESULT	11
5.1 ANTENNA REQUIREMENT	11
5.1.1 Standard requirement	11
5.1.2 EUT Antenna	11
5.2 CONDUCTION EMISSIONS MEASUREMENT	12
5.2.1 Applied procedures / Limit	12
5.2.2 Test procedure	12
5.2.3 Test setup	12
5.2.4 Test results	13
5.3 RADIATED EMISSIONS MEASUREMENT	15
5.3.1 Applied procedures / Limit	15
5.3.2 Test setup	15
5.3.3 Test procedure	18
5.3.4 Test Result	19
5.3.5 TEST RESULTS (Restricted Bands Requirements)	27
5.4 BANDWIDTH TEST	28
5.4.1 Applied procedures / Limit	28
5.4.2 Test procedure	28
5.4.3 Deviation from standard	28
5.4.4 Test setup	28
5.4.5 Test results	29
5.5 CARRIER FREQUENCIES SEPARATED	33
5.5.1 Applied procedures / Limit	33
5.5.2 Test procedure	33

5.5.3	Deviation from standard.....	33
5.5.4	Test setup	33
5.5.5	Test results	34
5.6	HOPPING CHANNEL NUMBER.....	38
5.6.1	Applied procedures / Limit	38
5.6.2	Test procedure.....	38
5.6.3	Deviation from standard.....	38
5.6.4	Test setup	38
5.6.5	Test result	39
5.7	DWELL TIME.....	41
5.7.1	Applied procedures / Limit	41
5.7.2	Test procedure.....	41
5.7.3	Deviation from standard.....	41
5.7.4	Test setup	41
5.7.5	Test result	42
5.8	MAXIMUM PEAK OUTPUT POWER.....	46
5.8.1	Applied procedures / Limit	46
5.8.2	Test procedure.....	46
5.8.3	Deviation from standard.....	46
5.8.4	Test setup	46
5.8.5	Test results	47
5.9	BAND EDGE	51
5.9.1	Applied procedures / Limit	51
5.9.2	Test procedure.....	51
5.9.3	Deviation from standard.....	51
5.9.4	Test setup	51
5.9.5	Test results	52
5.10	CONDUCTED SPURIOUS EMISSIONS	56
5.10.1	Applied procedures / Limit	56
5.10.2	Test procedure.....	56
5.10.3	Deviation from standard.....	56
5.10.4	Test setup	56
5.10.5	Test results	57
6	PHOTOGRAPHS.....	69
6.1	RADIATED SPURIOUS EMISSION TEST SETUP	69
6.2	CONDUCTED EMISSION TEST SETUP.....	70
7	APPENDIX-PHOTOGRAPHS OF EUT CONSTRUCTIONAL DETAILS	71

2 Test Summary

2.1 Compliance with FCC Part 15 subpart C

Test	Test Requirement	Standard Paragraph	Result
Antenna Requirement	FCC Part 15 C:2016	Section 15.247(c)	PASS
Conduction Emissions	FCC Part 15 C:2016	Section 15.207(a)	PASS
Radiated Emissions	FCC Part 15 C:2016	Section 15.247(d)	PASS
Carrier Frequencies Separated	FCC Part 15 C:2016	Section 15.247(a)(1)	PASS
Hopping Channel Number	FCC Part 15 C:2016	Section 15.247(a)(1) (iii)	PASS
Dwell Time	FCC Part 15 C:2016	Section 15.247(a)(1) (iii)	PASS
Maximum Peak Output Power	FCC Part 15 C:2016	Section 15.247(b)	PASS
Band edge	FCC Part 15 C:2016	Section 15.247(d)	PASS
Conducted Spurious Emissions	FCC Part 15 C:2016	Section 15.247(d)	PASS
<p>2. The product support for Bluetooth 4.0 Dual-mode(including Bluetooth Basic rate / EDR and low energy), this report is Basic rate / EDR connection test mode, for low energy connection mode please refers to the report number ATS160501612.</p>			

2.2 Measurement Uncertainty

All measurements involve certain levels of uncertainties, The following measurements uncertainty Levels have estimated based on ANSI C63.10:2013, the maximum value of the uncertainty as below

No.	Item	Uncertainty
1	Conducted Emission Test	1.20dB
2	Radiated Emission Test	3.30dB

2.3 Test Location

All tests were performed at:

Dongguan Yaxu (AiT) Technology Limited
No.22, Jinqianling Third Street, Jitigang, Huangjiang,Dongguan, Guangdong, China
Tel.: +86.769.82020499 Fax.: +86.769.82020495

The FCC Registration No. of Dongguan Yaxu (AiT) Technology Limited is 248337.

3 General Information

3.1 General Description of EUT

Manufacturer:	Dongguan Linyar Technology Co.,Ltd.
Manufacturer Address:	No.2,PujiangRoad,DaningCommunity,Humen,Dongguan,Guangdong,China.
EUT Name:	Sport Bluetooth headset
Model No:	sportpods RACE
Derivative model No.:	sportpods ENDURO
Brand Name:	Boompods
Operation frequency:	2402 MHz to 2480 MHz
NUMBER OF CHANNEL:	79
Modulation Technology:	GFSK, $\pi/4$ -DQPSK, 8DPSK(1/2/3Mbps)
Bluetooth version:	Bluetooth 4.0 Smart (Dual-mode mode)
H/W No.:	Ver 3.0
S/W No.:	V1.0
Antenna Type:	Integral Antenna
Antenna Gain:	Maximum 3.7 dBi
Power Supply Range:	DC 5V from micro-USB or DC 3.7V from battery
Power Supply:	DC 5V from adapter, AC 120V/60Hz for adapter, DC 3.7V from battery
Power Cord:	N/A
Output power (max) :	1Mbps: -1.16dBm
	3Mbps: -0.9dBm
Model description:	According to the declaration from the applicant, the electrical circuit design, layout, components used and internal wiring were identical for all models, with only difference being the model name and battery capacity(sportpods RACE-80mAH, sportpods ENDURO-180mAH). Therefore only one model sportpods RACE was tested in this report.
Note:	
	1. For a more detailed features description, please refer to the manufacturer's specifications or the User's Manual.

Description of Channel:					
Channel	Frequency (MHz)	Channel	Frequency (MHz)	Channel	Frequency (MHz)
00	2402	27	2429	54	2456
01	2403	28	2430	55	2457
02	2404	29	2431	56	2458
03	2405	30	2432	57	2459
04	2406	31	2433	58	2460
05	2407	32	2434	59	2461
06	2408	33	2435	60	2462
07	2409	34	2436	61	2463
08	2410	35	2437	62	2464
09	2411	36	2438	63	2465
10	2412	37	2439	64	2466
11	2413	38	2440	65	2467
12	2414	39	2441	66	2468
13	2415	40	2442	67	2469
14	2416	41	2443	68	2470
15	2417	42	2444	69	2471
16	2418	43	2445	70	2472
17	2419	44	2446	71	2473
18	2420	45	2447	72	2474
19	2421	46	2448	73	2475
20	2422	47	2449	74	2476
21	2423	48	2450	75	2477
22	2424	49	2451	76	2478
23	2425	50	2452	77	2479
24	2426	51	2453	78	2480
25	2427	52	2454		
26	2428	53	2455		

3.2 Description of Test conditions

- (1) EUT was tested in normal configuration (Please See following Block diagram)

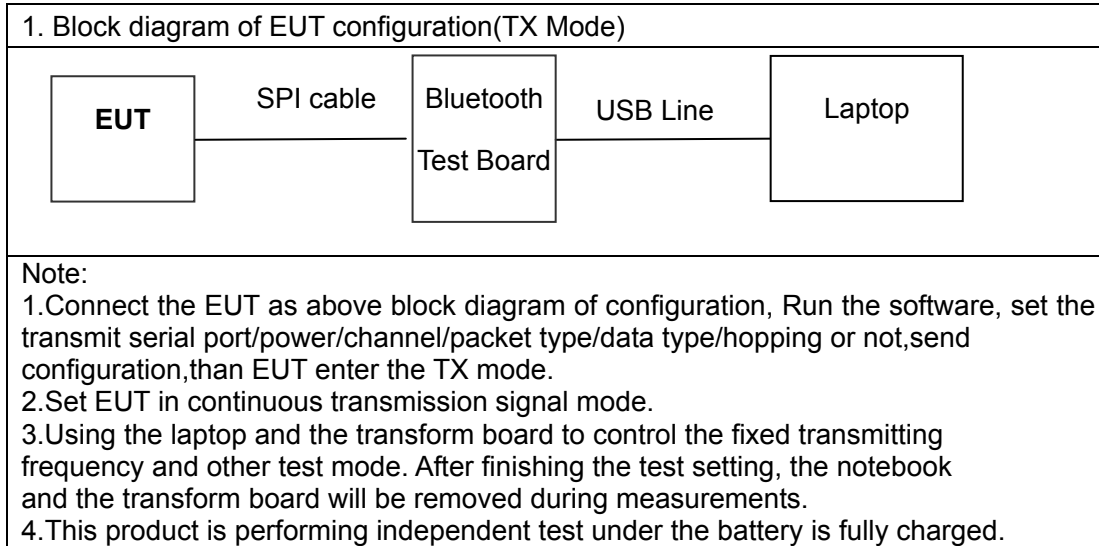

- (2) E.U.T. test conditions:

15.31(e): For intentional radiators, measurements of the variation of the input power or the radiated signal level of the fundamental frequency component of the emission, as appropriate, shall be performed with the supply voltage varied between 85% and 115% of the nominal rated supply voltage. For battery operated equipment, the equipment tests shall be performed using a new battery.

- (3) Test frequencies:

According to the 15.31(m) Measurements on intentional radiators or receivers, other than TV broadcast receivers, shall be performed and. If required reported for each band in which the device can be operated with the device operating at the number of frequencies in each band specified in the following table:

Frequency range over which device operates	Number of frequencies	Location in the range of operation
1 MHz or less	1	Middle
1 to 10 MHz	2	1 near top and 1 near bottom
More than 10 MHz	3	1 near top, 1 near middle and 1 near bottom

- (4) Frequency range of radiated measurements:

According to the 15.33, the test range will be up to the tenth harmonic of the highest fundamental frequency.

- (5) Pre-test the EUT in all transmitting mode at the lowest (2402 MHz), middle (2441 MHz) and highest (2480 MHz) channel with different data packet and conducted to determine the worst-case mode, only the worst-case results(1Mbps/3Mbps) are recorded in this report.
- (6) The radiation measurements are performed in X, Y, Z axis positioning. And found the X axis positioning which it is worse case, only the test worst case mode is recorded in the report.

3.3 Test Peripheral List

No.	Equipment	Manufacturer	EMC Compliance	Model No.	Serial No.	Power cord	signal cable
1	Lap top	ASUS	N/A	X401A	X16-96072	N/A	N/A
2	AC adapter	Stos	CE	QX6.5W7 5100FG	N/A	N/A	N/A

3.4 EUT Peripheral List

No.	Equipment	Manufacturer	EMC Compliance	Model No.	Serial No.	Power cord	signal cable
1	USB cable	N/A	N/A	N/A	N/A	0.8m/unshielded /detachable	N/A

4 Equipments List for All Test Items

No	Test Equipment	Manufacturer	Model No	Serial No	Cal. Date	Cal. Due Date
1	Spectrum Analyzer	ADVANTEST	R3182	150900201	2015.06.29	2016.06.28
2	EMI Measuring Receiver	Schaffner	SCR3501	235	2015.06.29	2016.06.28
3	Low Noise Pre Amplifier	Tsj	MLA-10K01-B01-27	1205323	2015.06.29	2016.06.28
4	Low Noise Pre Amplifier	Tsj	MLA-0120-A02-34	2648A04738	2015.06.29	2016.06.28
5	TRILOG Super Broadband test Antenna	SCHWARZBECK	VULB9160	9160-3206	2015.06.29	2016.06.28
6	Broadband Horn Antenna	SCHWARZBECK	BBHA9120D	452	2015.06.29	2016.06.28
7	SHF-EHF Horn Antenna	SCHWARZBECK	BBHA9170	BBHA9170367	2015.06.29	2016.06.28
8	50Ω Coaxial Switch	Anritsu	MP59B	6200264416	2015.06.29	2016.06.28
9	EMI Test Receiver	R&S	ESCI	100124	2015.06.29	2016.06.28
10	LISN	Kyoritsu	KNW-242	8-837-4	2015.06.29	2016.06.28
11	LISN	Kyoritsu	KNW-407	8-1789-3	2015.06.29	2016.06.28
12	50Ω Coaxial Switch	Anritsu	MP59B	6200264417	2015.06.29	2016.06.28
13	Loop Antenna	ARA	PLA-1030/B	1029	2015.06.29	2016.06.28
14	EMI Test Receiver	Rohde & Schwarz	ESIB26	100394	2015.06.29	2016.06.28
15	Radiated Cable 1# (30MHz-1GHz)	FUJIKURA	5D-2W	01	2016.01.04	2017.01.03
16	Radiated Cable 2# (1GHz -25GHz)	FUJIKURA	10D2W	02	2015.12.25	2016.12.24
17	Conducted Cable 1#(9KHz-30MHz)	FUJIKURA	1D-2W	01	2016.01.04	2017.01.03
18	SMA Antenna connector (Impedance:50OHM, cable loss:0.5dBm)	Dosin	Dosin-SMA	N/A	N/A	N/A

Note: The temporary antenna connector is soldered on the PCB board in order to perform conducted tests and this temporary antenna connector is listed in the equipment list.

5 Test Result

5.1 Antenna Requirement

5.1.1 Standard requirement

15.203 requirement: For intentional device, according to 15.203: an intentional radiator shall be designed to ensure that no antenna other than that furnished by the responsible party shall be used with the device.

15.247(c) (1)(i) requirement: (i) Systems operating in the 2400-2483.5 MHz band that is used exclusively for fixed. Point-to-point operations may employ transmitting antennas with directional gain greater than 6dBi provided the maximum conducted output power of the intentional radiator is reduced by 1 dB for every 3 dB that the directional gain of the antenna exceeds 6dBi.

5.1.2 EUT Antenna

The antenna is Integral Antenna and no consideration of replacement. Antenna gain is Maximum 3.7dbi from 2.4GHz to 2.5GHz.

5.2 Conduction Emissions Measurement

5.2.1 Applied procedures / Limit

Frequency of Emission (MHz)	Conducted Limit (dB μ V)	
	Quasi-peak	Average
0.15-0.5	66 to 56 *	56 to 46 *
0.5-5	56	46
5-30	60	50

Note: Decreases with the logarithm of the frequency.

5.2.2 Test procedure

EUT was placed upon a wooden test table 0.8m above the horizontal metal reference plane and 0.4m from the vertical ground plane, and it was connected to an AMN. The closest distance between the boundary of the EUT and the surface of the AMN is 0.8m. All peripherals were connected to another AMN, and placed at a distance of 10cm from each other. A spectrum and receiver was connected to the RF output port of the AMN. Both average and quasi-peak value were detected.

5.2.3 Test setup

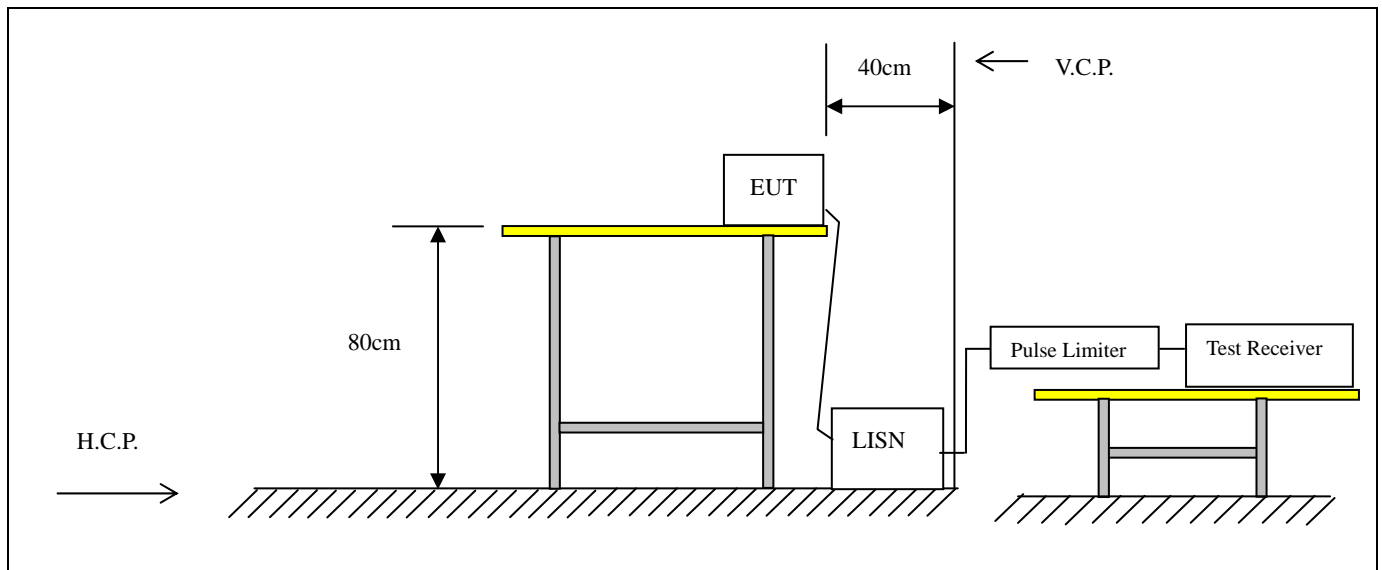

5.2.4 Test results

EUT:	Sport Bluetooth headset	Model Name. :	sportpods RACE
Temperature:	26 °C	Relative Humidity:	54%
Pressure:	1010hPa	Test Date :	2016-05-18
Test Mode:	TX (1Mbps) CH00 (worst case)	Phase :	Line
Test Voltage :	DC 5V from adapter, AC 120V/60Hz for adapter		

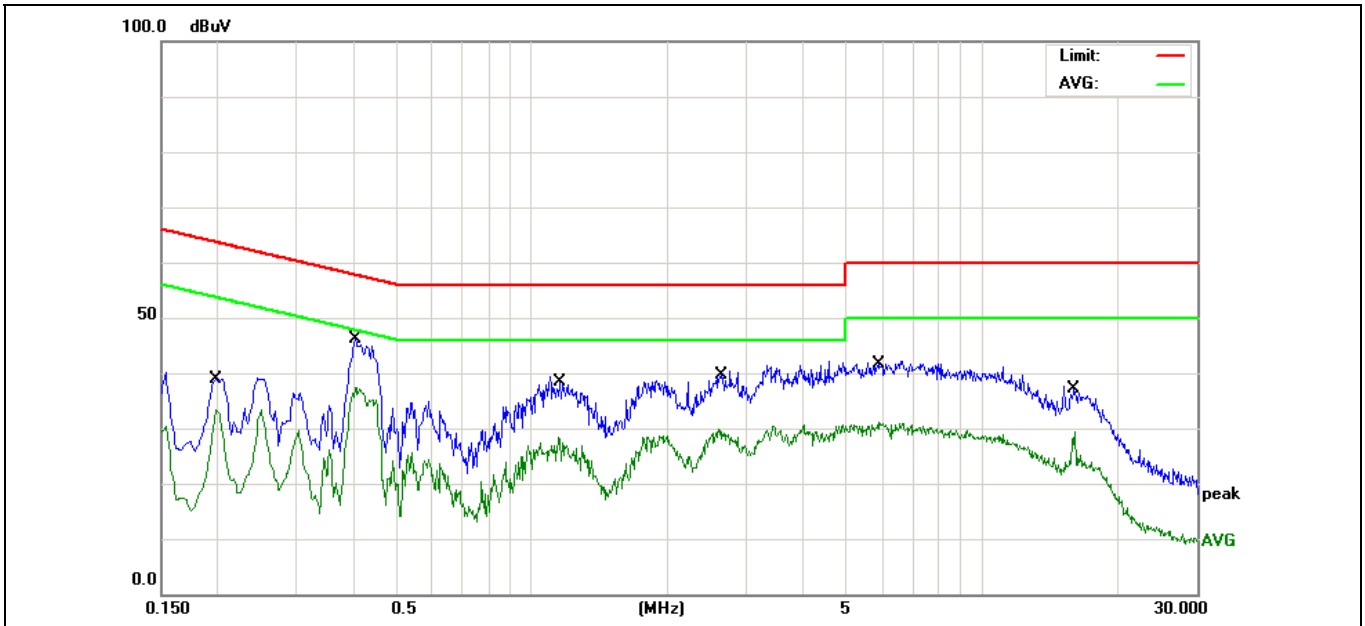

Remark: Factor = LISN factor + Cable Loss + Pulse limiter factor.

No. Mk.	Freq. MHz	Reading Level dBuV	Correct Factor dB	Measure- ment dBuV	Limit dBuV	Over dB	Detector
1	0.1980	27.83	11.16	38.99	63.69	-24.70	QP
2	0.1980	22.30	11.16	33.46	53.69	-20.23	AVG
3	0.4060	36.10	10.12	46.22	57.73	-11.51	QP
4 *	0.4060	27.29	10.12	37.41	47.73	-10.32	AVG
5	1.1419	25.82	9.94	35.76	56.00	-20.24	QP
6	1.1419	18.50	9.94	28.44	46.00	-17.56	AVG
7	2.5979	28.77	10.01	38.78	56.00	-17.22	QP
8	2.5979	19.93	10.01	29.94	46.00	-16.06	AVG
9	5.8799	31.44	10.12	41.56	60.00	-18.44	QP
10	5.8799	21.08	10.12	31.20	50.00	-18.80	AVG
11	16.0619	35.10	1.54	36.64	60.00	-23.36	QP
12	16.0619	27.74	1.54	29.28	50.00	-20.72	AVG

EUT:	Sport Bluetooth headset	Model Name. :	sportpods RACE
Temperature:	26 °C	Relative Humidity:	54%
Pressure:	1010hPa	Test Date :	2016-05-18
Test Mode:	TX (1Mbps) CH00 (worst case)	Phase :	Neutral
Test Voltage :	DC 5V from adapter, AC 120V/60Hz for adapter		

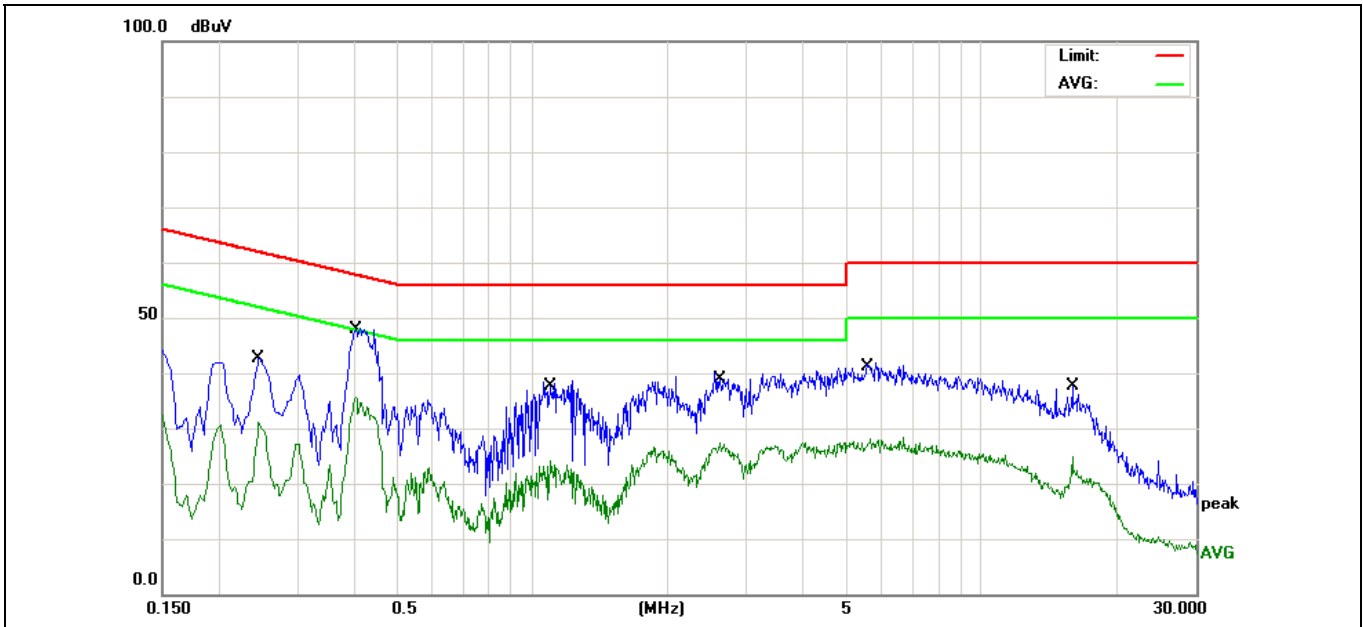

Remark: Factor = LISN factor + Cable Loss + Pulse limiter factor.

No. Mk.	Freq. MHz	Reading Level dBuV	Correct Factor dB	Measurement dBuV	Limit dBuV	Over dB	Detector
1	0.2459	31.85	10.90	42.75	61.89	-19.14	QP
2	0.2459	20.16	10.90	31.06	51.89	-20.83	AVG
3 *	0.4060	37.84	10.12	47.96	57.73	-9.77	QP
4	0.4060	25.41	10.12	35.53	47.73	-12.20	AVG
5	1.0940	27.78	9.94	37.72	56.00	-18.28	QP
6	1.0940	14.27	9.94	24.21	46.00	-21.79	AVG
7	2.6179	28.79	10.01	38.80	56.00	-17.20	QP
8	2.6179	17.47	10.01	27.48	46.00	-18.52	AVG
9	5.6578	30.99	10.12	41.11	60.00	-18.89	QP
10	5.6578	18.13	10.12	28.25	50.00	-21.75	AVG
11	15.9618	36.00	1.52	37.52	60.00	-22.48	QP
12	15.9618	23.35	1.52	24.87	50.00	-25.13	AVG

5.3 Radiated Emissions Measurement

5.3.1 Applied procedures / Limit

15.247(d) In any 100 kHz bandwidth outside the frequency band in which the spread spectrum or digitally modulated intentional radiator is operating, the radio frequency power that is produced by the intentional radiator shall be at least 20 dB below that in the 100 kHz bandwidth within the band that contains the highest level of the desired power, based on either an RF conducted or a radiated measurement, provided the transmitter demonstrates compliance with the peak conducted power limits. If the transmitter complies with the conducted power limits based on the use of RMS averaging over a time interval, as permitted under paragraph (b)(3) of this section, the attenuation required under this paragraph shall be 30 dB instead of 20 dB. Attenuation below the general limits specified in Section 15.209(a) is not required. In addition, radiated emissions which fall in the restricted bands, as defined in Section 15.205(a), must also comply with the radiated emission limits specified in Section 15.209(a) (see Section 15.205(c)).

Frequency of Emission (MHz)	Field Strength		Measurement Distance (meters)
	$\mu\text{V/m}$	$\text{dB}\mu\text{V/m}$	
0.009-0.49	2400/F(kHz)		300
0.49-1.705	24000/F(kHz)		30
1.705-30	30		30
30-88	100	40	3
88-216	150	43.5	3
216-960	200	46	3
Above 960	500	54	3

5.3.2 Test setup

Test Configuration:

1) 9 kHz to 30 MHz emissions:

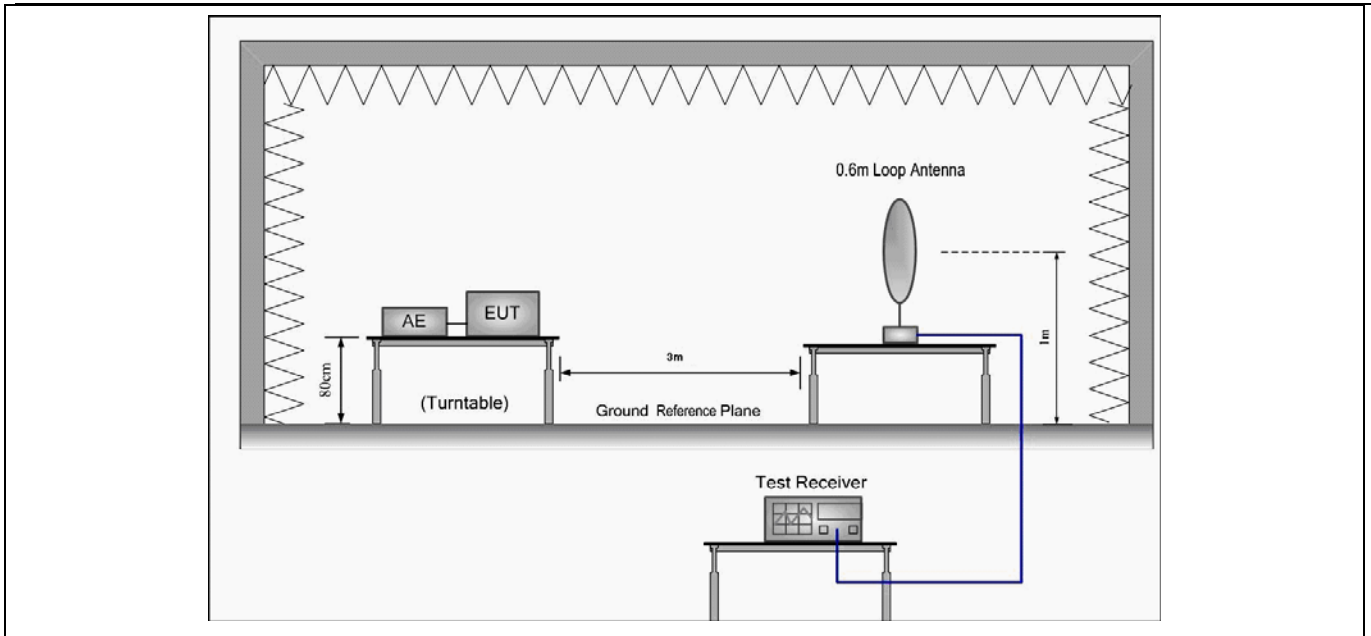

2) 30 MHz to 1 GHz emissions:

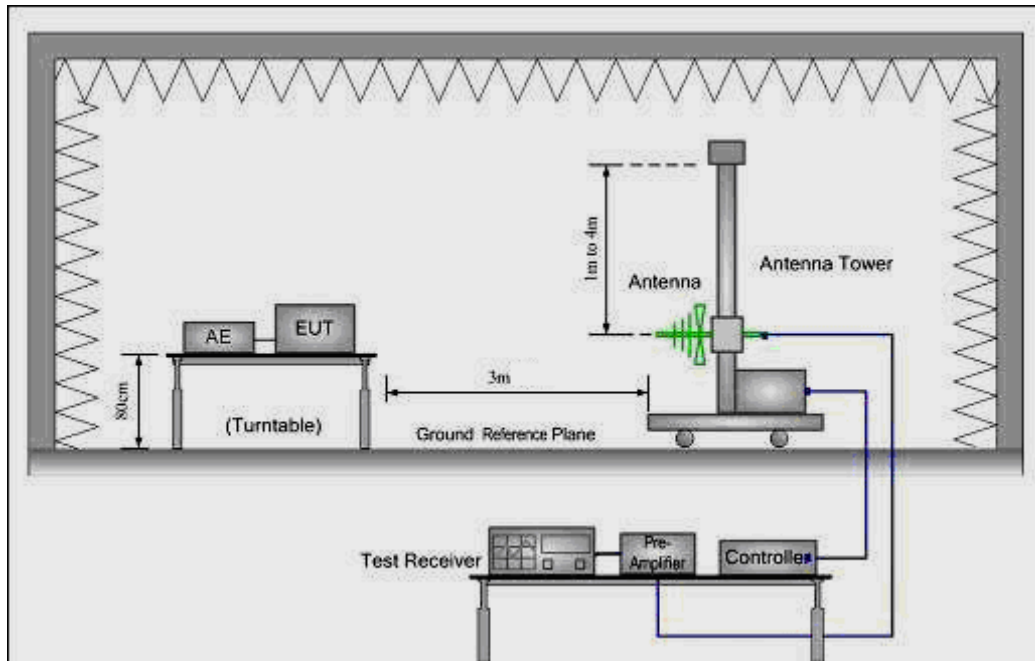

3) 1 GHz to 25 GHz emissions:

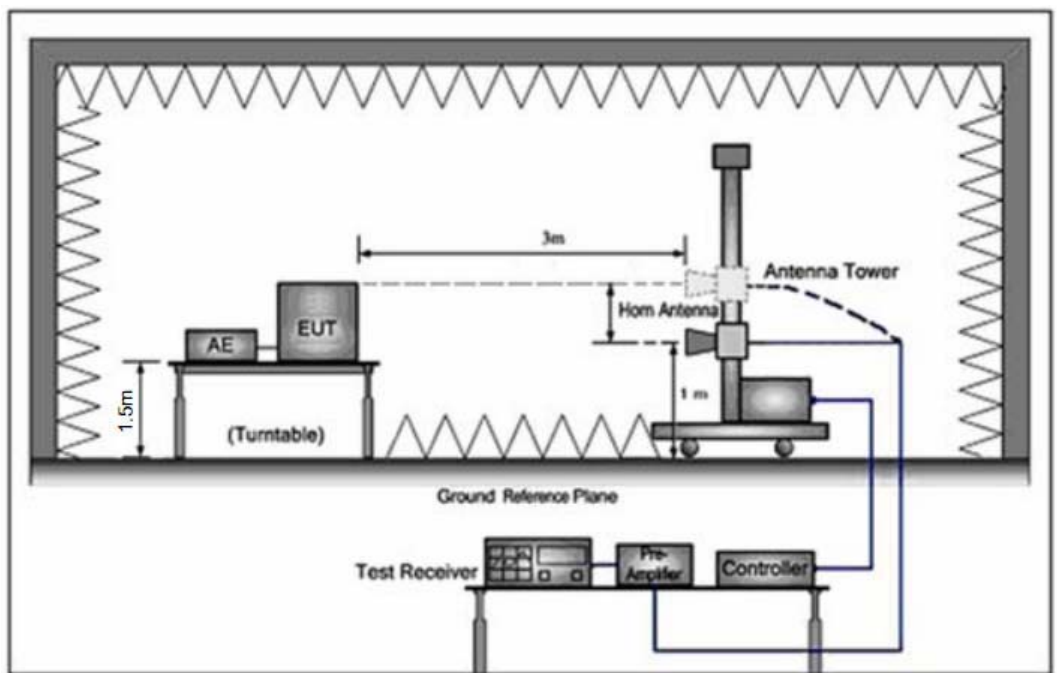

5.3.3 Test procedure

EUT was placed upon a wooden test table which was placed on the turn table and operating in the mode as mentioned above. For emissions testing at or below 1 GHz, the table height shall be 80 cm above the reference ground plane. For emission measurements above 1 GHz, the table height shall be 1.5 m. A receiving antenna was placed 3m away from the EUT. During testing, turn around the turn table and move the antenna from 1m to 4m to find the maximum field-strength reading. All peripherals were placed at a distance of 10cm between each other. Both horizontal and vertical antenna polarities were tested. The worst case emissions were reported.

For measurement at frequency above 1GHz

Place the measurement antenna away from each area of the EUT determined to be a source of emissions at the specified measurement distance, while keeping the measurement antenna aimed at the source of emissions at each frequency of significant emissions, with polarization oriented for maximum response. The measurement antenna may have to be higher or lower than the EUT, depending on the radiation pattern of the emission and staying aimed at the emission source for receiving the maximum signal. The final measurement antenna elevation shall be that which maximizes the emissions. The measurement antenna elevation for maximum emissions shall be restricted to a range of heights of from 1 m to 4 m above the ground or reference ground plane.

5.3.4 Test Result

Radiated Emissions Test Data Below 30MHz

EUT:	Sport Bluetooth headset	Model Name :	sportpods RACE
Temperature:	25 °C	Test Data	2016-05-18
Pressure:	1005 hPa	Relative Humidity:	60%
Test Mode :	TX	Test Voltage :	DC 3.7V from battery
Measurement Distance	3 m	Frenqucy Range	9KHz to 30MHz
RBW/VBW	9KHz~150KHz/RB 200Hz for QP, 150KHz~30MHz/RB 9KHz for QP		

No emission found between lowest internal used/generated frequencies to 30MHz.

Radiated Emissions Test Data Below 1GHz

EUT:	Sport Bluetooth headset	Model Name :	sportpods RACE
Temperature:	25 °C	Test Data	2016-05-18
Pressure:	1010 hPa	Relative Humidity:	60%
Test Mode :	TX (1Mbps) CH00 (worst case)	Test Voltage :	DC 3.7V from battery
Measurement Distance	3 m	Frenqucy Range	30MHz to 1GHz
RBW/VBW	100KHz / 300KHz for spectrum, RBW=120KHz for receiver.		

(a) Antenna polarization: Horizontal

Frequency (MHz)	Reading Level (dBuV)	Correct Factor (dB)	Measure Level (dBuV/m)	Limit (dBuV/m)	Over (dB)	Detector Type
59.6493	30.51	-19.45	11.06	40.00	-28.94	QP
109.4116	30.41	-13.42	16.99	43.50	-26.51	QP
195.1365	31.18	-14.60	16.58	43.50	-26.92	QP
270.3748	30.38	-11.02	19.36	46.00	-26.64	QP
434.0651	29.82	-6.61	23.21	46.00	-22.79	QP
804.6028	29.04	2.82	31.86	46.00	-14.14	QP

(b) Antenna polarization: vertical

Frequency (MHz)	Reading Level (dBuV)	Correct Factor (dB)	Measure Level (dBuV/m)	Limit (dBuV/m)	Over (dB)	Detector Type
45.0583	28.12	-14.49	13.63	40.00	-26.37	QP
100.9339	29.70	-15.92	13.78	43.50	-29.72	QP
184.4898	30.14	-11.16	18.98	43.50	-24.52	QP
280.0237	29.92	-10.26	19.66	46.00	-26.34	QP
400.4319	28.88	-6.89	21.99	46.00	-24.01	QP
706.6999	30.23	-0.16	30.07	46.00	-15.93	QP

Note:

Measurement Level = Reading Level + Factor

Remark: Factor = Antenna Factor + Cable Loss–Pre-amplifier

Radiated Emissions Test Data Above 1GHz

EUT:	Sport Bluetooth headset	Model Name :	sportpods RACE
Temperature:	25 °C	Test Data	2016-05-18
Pressure:	1010 hPa	Relative Humidity:	60%
Test Mode :	1Mbps	Test Voltage :	DC 3.7V from battery
Measurement Distance	3 m	Frenqucy Range	1GHz to 25GHz
RBW/VBW	Spurious emission: 1MHz/3MHz for Peak, 1MHz/10Hz for Average. non-restricted band: 100KHz/300KHz for Peak.		

(a) Antenna polarization: Horizontal

Frequency (MHz)	Reading Level (dBuV)	Correct Factor (dB)	Measure Level (dBuV/m)	Limit (dBuV/m)	Over (dB)	Detector Type
4804.000	53.76	5.06	58.82	74.00	-15.18	peak
4804.000	41.58	5.06	46.64	54.00	-7.36	AVG
7206.000	47.14	7.03	54.17	74.00	-19.83	peak
7206.000	35.25	7.03	42.28	54.00	-11.72	AVG

(b) Antenna polarization: Vertical

Frequency (MHz)	Reading Level (dBuV)	Correct Factor (dB)	Measure Level (dBuV/m)	Limit (dBuV/m)	Over (dB)	Detector Type
4804.000	51.24	5.06	56.30	74.00	-17.70	peak
4804.000	40.85	5.06	45.91	54.00	-8.09	AVG
7206.000	46.98	7.03	54.01	74.00	-19.99	peak
7206.000	35.26	7.03	42.29	54.00	-11.71	AVG

Note:

8~25GHz at least have 20dB margin. No recording in the test report.

Measurement Level = Reading Level + Factor

Remark: Factor = Antenna Factor + Cable Loss–Pre-amplifier

Lowest channel: 2402 MHz

Data rate: 1Mbps

(a) Antenna polarization: Horizontal

Frequency (MHz)	Reading Level (dBuV)	Correct Factor (dB)	Measure Level (dBuV/m)	Limit (dBuV/m)	Over (dB)	Detector Type
4882.000	52.70	5.14	57.84	74.00	-16.16	peak
4882.000	41.66	5.14	46.80	54.00	-7.20	AVG
7323.000	46.72	7.54	54.26	74.00	-19.74	peak
7323.000	35.38	7.54	42.92	54.00	-11.08	AVG

(b) Antenna polarization: Vertical

Frequency (MHz)	Reading Level (dBuV)	Correct Factor (dB)	Measure Level (dBuV/m)	Limit (dBuV/m)	Over (dB)	Detector Type
4882.000	51.94	5.14	57.08	74.00	-16.92	peak
4882.000	40.28	5.14	45.42	54.00	-8.58	AVG
7323.000	45.09	7.54	52.63	74.00	-21.37	peak
7323.000	34.76	7.54	42.30	54.00	-11.70	AVG

Note:

8~25GHz at least have 20dB margin. No recording in the test report.

Measurement Level = Reading Level + Factor

Remark: Factor = Antenna Factor + Cable Loss–Pre-amplifier

Middle Channel: 2441 MHz

Data rate: 1Mbps

(a) Antenna polarization: Horizontal

Frequency (MHz)	Reading Level (dBuV)	Correct Factor (dB)	Measure Level (dBuV/m)	Limit (dBuV/m)	Over (dB)	Detector Type
4960.000	52.64	5.22	57.86	74.00	-16.14	peak
4960.000	41.23	5.22	46.45	54.00	-7.55	AVG
7440.000	45.19	8.06	53.25	74.00	-20.75	peak
7440.000	34.38	8.06	42.44	54.00	-11.56	AVG

(b) Antenna polarization: Vertical

Frequency (MHz)	Reading Level (dBuV)	Correct Factor (dB)	Measure Level (dBuV/m)	Limit (dBuV/m)	Over (dB)	Detector Type
4960.000	52.59	5.22	57.81	74.00	-16.19	peak
4960.000	39.40	5.22	44.62	54.00	-9.38	AVG
7440.000	46.37	8.06	54.43	74.00	-19.57	peak
7440.000	34.67	8.06	42.73	54.00	-11.27	AVG

Note:

8~25GHz at least have 20dB margin. No recording in the test report.

Measurement Level = Reading Level + Factor

Remark: Factor = Antenna Factor + Cable Loss–Pre-amplifier

Highest Channel: 2480 MHz

Data rate: 1Mbps

EUT:	Sport Bluetooth headset	Model Name :	sportpods RACE
Temperature:	25 °C	Test Data	2016-05-18
Pressure:	1010 hPa	Relative Humidity:	60%
Test Mode :	3Mbps	Test Voltage :	DC 3.7V from battery
Measurement Distance	3 m	Frenqucy Range	1GHz to 25GHz
RBW/VBW	Spurious emission: 1MHz/3MHz for Peak, 1MHz/10Hz for Average. non-restricted band: 100KHz/300KHz for Peak.		

(a) Antenna polarization: Horizontal

Frequency (MHz)	Reading Level (dBuV)	Correct Factor (dB)	Measure Level (dBuV/m)	Limit (dBuV/m)	Over (dB)	Detector Type
4804.000	52.15	5.06	57.21	74.00	-16.79	peak
4804.000	40.68	5.06	45.74	54.00	-8.26	AVG
7206.000	46.39	7.03	53.42	74.00	-20.58	peak
7206.000	35.12	7.03	42.15	54.00	-11.85	AVG

(b) Antenna polarization: Vertical

Frequency (MHz)	Reading Level (dBuV)	Correct Factor (dB)	Measure Level (dBuV/m)	Limit (dBuV/m)	Over (dB)	Detector Type
4804.000	52.19	5.06	57.25	74.00	-16.75	peak
4804.000	41.63	5.06	46.69	54.00	-7.31	AVG
7206.000	46.87	7.03	53.90	74.00	-20.10	peak
7206.000	35.24	7.03	42.27	54.00	-11.73	AVG

Note:

8~25GHz at least have 20dB margin. No recording in the test report.

Measurement Level = Reading Level + Factor

Remark: Factor = Antenna Factor + Cable Loss–Pre-amplifier

Lowest Channel: 2402 MHz

Data rate: 3Mbps

(a) Antenna polarization: Horizontal

Frequency (MHz)	Reading Level (dBuV)	Correct Factor (dB)	Measure Level (dBuV/m)	Limit (dBuV/m)	Over (dB)	Detector Type
4882.000	53.34	5.14	58.48	74.00	-15.52	peak
4882.000	42.76	5.14	47.90	54.00	-6.10	AVG
7323.000	45.48	7.54	53.02	74.00	-20.98	peak
7323.000	33.91	7.54	41.45	54.00	-12.55	AVG

(b) Antenna polarization: Vertical

Frequency (MHz)	Reading Level (dBuV)	Correct Factor (dB)	Measure Level (dBuV/m)	Limit (dBuV/m)	Over (dB)	Detector Type
4882.000	52.16	5.14	57.30	74.00	-16.70	peak
4882.000	41.47	5.14	46.61	54.00	-7.39	AVG
7323.000	46.35	7.54	53.89	74.00	-20.11	peak
7323.000	34.98	7.54	42.52	54.00	-11.48	AVG

Note:

8~25GHz at least have 20dB margin. No recording in the test report.

Measurement Level = Reading Level + Factor

Remark: Factor = Antenna Factor + Cable Loss–Pre-amplifier

Middle Channel: 2441 MHz

Data rate: 3Mbps

(a) Antenna polarization: Horizontal

Frequency (MHz)	Reading Level (dBuV)	Correct Factor (dB)	Measure Level (dBuV/m)	Limit (dBuV/m)	Over (dB)	Detector Type
4960.000	51.81	5.22	57.03	74.00	-16.97	peak
4960.000	40.36	5.22	45.58	54.00	-8.42	AVG
7440.000	45.27	8.06	53.33	74.00	-20.67	peak
7440.000	34.49	8.06	42.55	54.00	-11.45	AVG

(b) Antenna polarization: Vertical

Frequency (MHz)	Reading Level (dBuV)	Correct Factor (dB)	Measure Level (dBuV/m)	Limit (dBuV/m)	Over (dB)	Detector Type
4960.000	51.90	5.22	57.12	74.00	-16.88	PEAK
4960.000	40.34	5.22	45.56	54.00	-8.44	AVERAGE
7440.000	45.28	8.06	53.34	74.00	-20.66	PEAK
7440.000	34.61	8.06	42.67	54.00	-11.33	AVERAGE

Note:

8~25GHz at least have 20dB margin. No recording in the test report.

Measurement Level = Reading Level + Factor

Remark: Factor = Antenna Factor + Cable Loss–Pre-amplifier

Highest channel: 2480 MHz

Data rate: 3Mbps

5.3.5 TEST RESULTS (Restricted Bands Requirements)

EUT:	Sport Bluetooth headset	Model Name :	sportpods RACE
Temperature:	25 °C	Test Data	2016-05-18
Pressure:	1010 hPa	Relative Humidity:	60%
Test Mode :	TX 1Mbps\ 3Mbps	Test Voltage :	DC 3.7V from battery
RBW/VBW	1MHz/3MHz for Peak, 1MHz/10Hz for Average.		
Note:	<p>1. The transmitter was setup to transmit at the lowest channel. Then the field strength was measured at 2310-2390 MHz.</p> <p>2. The transmitter was setup to transmit at the highest channel. Then the field strength was measured at 2483.5-2500 MHz.</p> <p>3. The data of 2390MHz and 2483.5MHz was the worst.</p>		

Test Mode	Ant.Pol. H/V	Freq. (MHz)	Reading		Ant/CF CF(dB)	Act		Limit	
			Peak (dBuv)	AV (dBuv)		Peak (dBuv/m)	AV (dBuv/m)	Peak (dBuv/m)	AV (dBuv/m)
Data rate 1Mbps	V	2390	43.57	32.42	-5.79	37.78	26.63	74.00	54.00
	H	2390	42.69	31.64	-5.79	36.90	25.85	74.00	54.00
	V	2483.5	43.43	30.84	-4.98	38.45	25.86	74.00	54.00
	H	2483.5	42.72	31.51	-4.98	37.74	26.53	74.00	54.00
Data rate 3Mbps	V	2390	44.26	32.54	-5.79	38.47	26.75	74.00	54.00
	H	2390	43.59	32.70	-5.79	37.80	26.91	74.00	54.00
	V	2483.5	42.76	31.68	-4.98	37.78	26.70	74.00	54.00
	H	2483.5	43.15	30.22	-4.98	38.17	25.24	74.00	54.00

Remark:	
(1)	Radiated emissions measured in frequency range above 1000MHz were made with an instrument using Peak detector mode.
(2)	During the measurements above 1 GHz it is taken care of that the EUT is always within the 3 dB cone of radiation BW of the used antenna
(3)	Corr.Factor = Antenna Factor + Cable Loss – Pre-amplifier.

5.4 BANDWIDTH TEST

5.4.1 Applied procedures / Limit

For frequency hopping system operating in the 2400-2483.5MHz, If the 20dB bandwidth of hopping channel is greater than 25kHz, two-thirds 20dB bandwidth of hopping channel shall be a minimum limit for the hopping channel separation.

5.4.2 Test procedure

- a. The EUT was directly connected to the spectrum analyzer and antenna output port as show in the block diagram below.
- b. Span = approximately 2 to 3 times the 20 dB bandwidth, centered on a hopping channel
RBW \geq 1% of the 20 dB bandwidth, VBW \geq RBW, Sweep = auto, Detector function = peak
Trace = max hold

5.4.3 Deviation from standard

No deviation.

5.4.4 Test setup

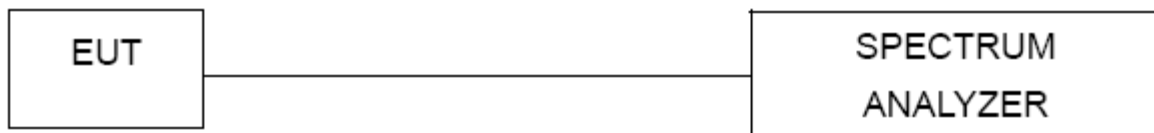

5.4.5 Test results

EUT:	Sport Bluetooth headset	Model Name :	sportpods RACE
Temperature:	26 °C	Relative Humidity:	53%
Pressure:	1010 hPa	Test Power :	DC 3.7V from battery
Test Mode :	TX 1Mbps/ 3Mbps		

Channel		Channel frequency (MHz)	20dB bandwidth (KHz)	Limit (KHz)	Conclusion
1Mbps	Low	2402	1059.3	N/A	Pass
	Middle	2441	1059.3	N/A	Pass
	High	2480	1063.7	N/A	Pass
3Mbps	Low	2402	1315.5	N/A	Pass
	Middle	2441	1315.5	N/A	Pass
	High	2480	1319.8	N/A	Pass

CH00-1Mbps

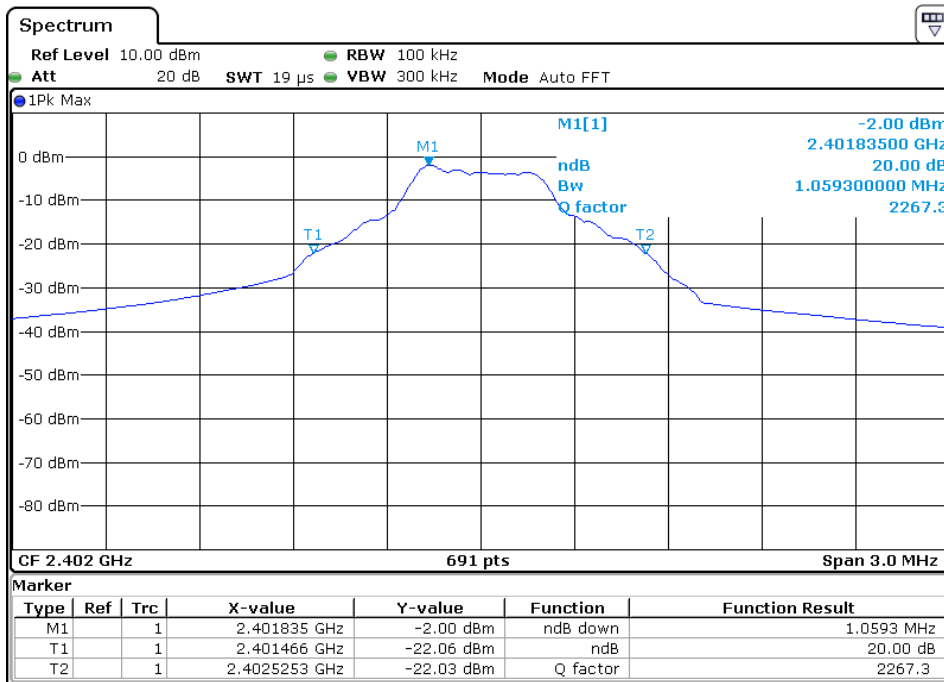

CH 39-1Mbps

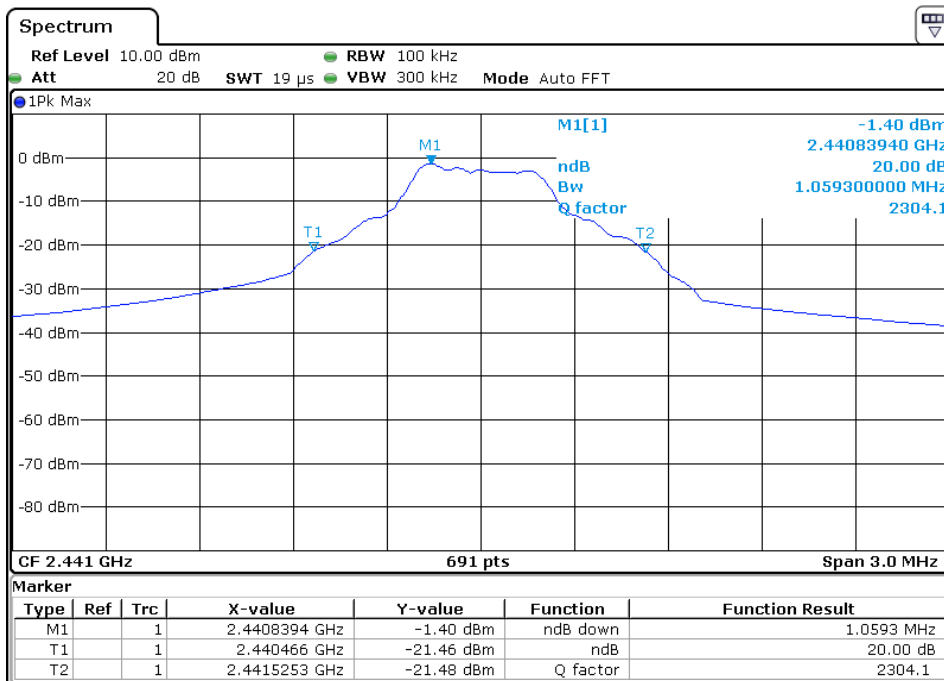

CH 78-1Mbps

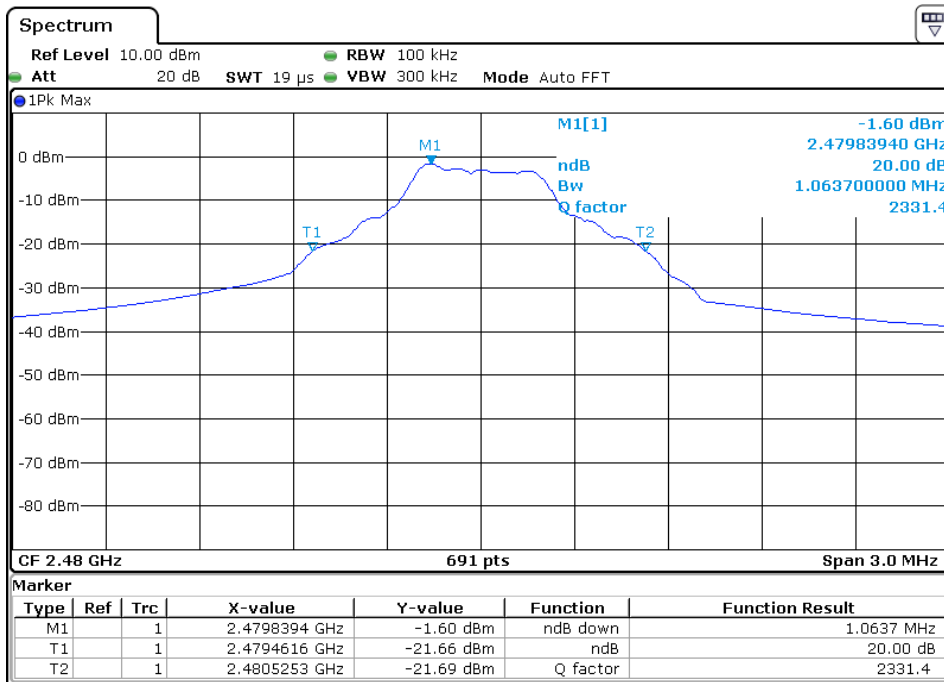

CH 00-3Mbps

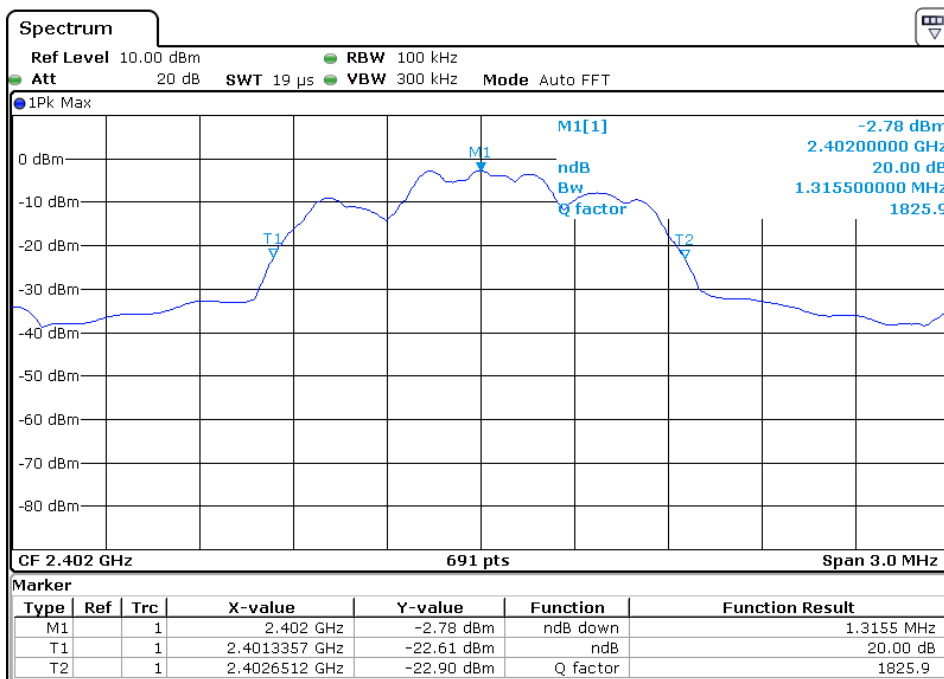

CH 39-3Mbps

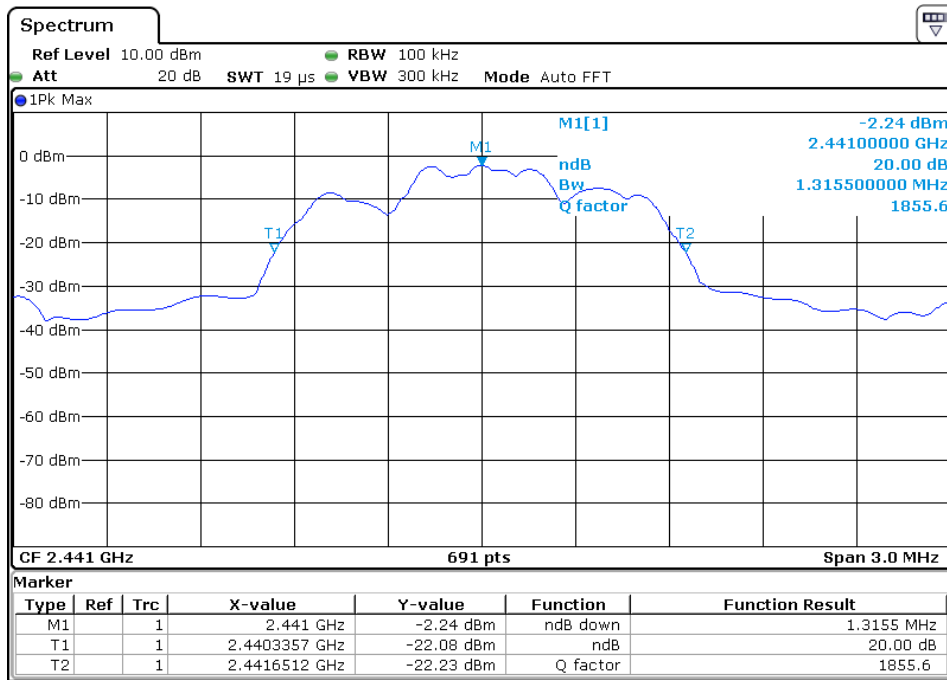

CH 78-3Mbps

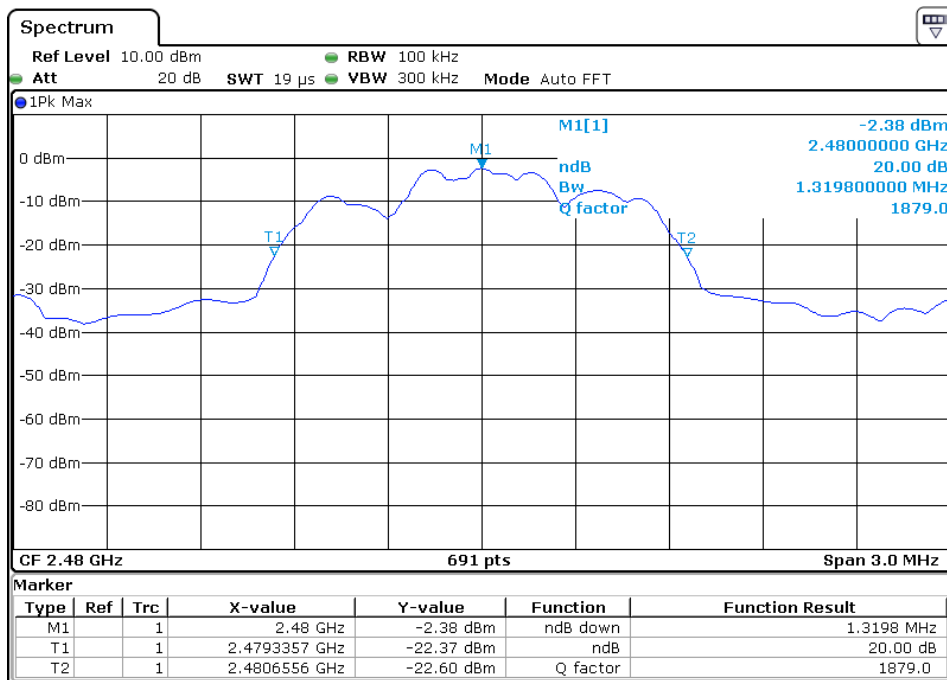

5.5 Carrier Frequencies Separated

5.5.1 Applied procedures / Limit

15.247(a) (1) Frequency hopping systems shall have hopping channel carrier frequencies separated by a minimum of 25 kHz or the 20 dB bandwidth of the hopping channel, whichever is greater. Alternatively, frequency hopping systems operating in the 2400-2483.5 MHz band may have hopping channel carrier frequencies that are separated by 25 kHz or two-thirds of the 20 dB bandwidth of the hopping channel, whichever is greater, provided the systems operate with an output power no greater than 125 mW.

5.5.2 Test procedure

- (1) Connected the antenna port to the Spectrum Analyzer, set the Spectrum Analyzer as
Span = wide enough to capture the peaks of two adjacent channels, Resolution (or IF)
Bandwidth (RBW) \geq 1% of the span, Video (or Average) Bandwidth (VBW) \geq RBW
Sweep = auto, Detector function = peak, Trace = max hold
- (2) The EUT should be transmitting at its maximum data rate. Use the marker-delta function to determine the separation between the peaks of the adjacent channels.
- (3) The above procedure shall be repeated at the lowest, the middle, and the highest frequency of the stated frequency range with modulated mode. also shall be performed at different modes of operation.

5.5.3 Deviation from standard

No deviation.

5.5.4 Test setup



5.5.5 Test results

EUT:	Sport Bluetooth headset	Model Name :	sportpods RACE
Temperature:	26 °C	Relative Humidity:	53%
Pressure:	1010 hPa	Test Power :	DC 3.7V from battery
Test Mode :	TX 1Mbps/ 3Mbps		

Channel		Channel frequency (MHz)	Channel Separation (MHz)	Conclusion
1Mbps	Low	2402	1002.9	Pass
	Middle	2441	1002.9	Pass
	Highest	2480	998.6	Pass
3Mbps	Low	2402	1002.9	Pass
	Middle	2441	1002.9	Pass
	Highest	2480	1007.2	Pass

Ch. Separation >2/3(20dB bandwidth)

CH 00-1Mbps

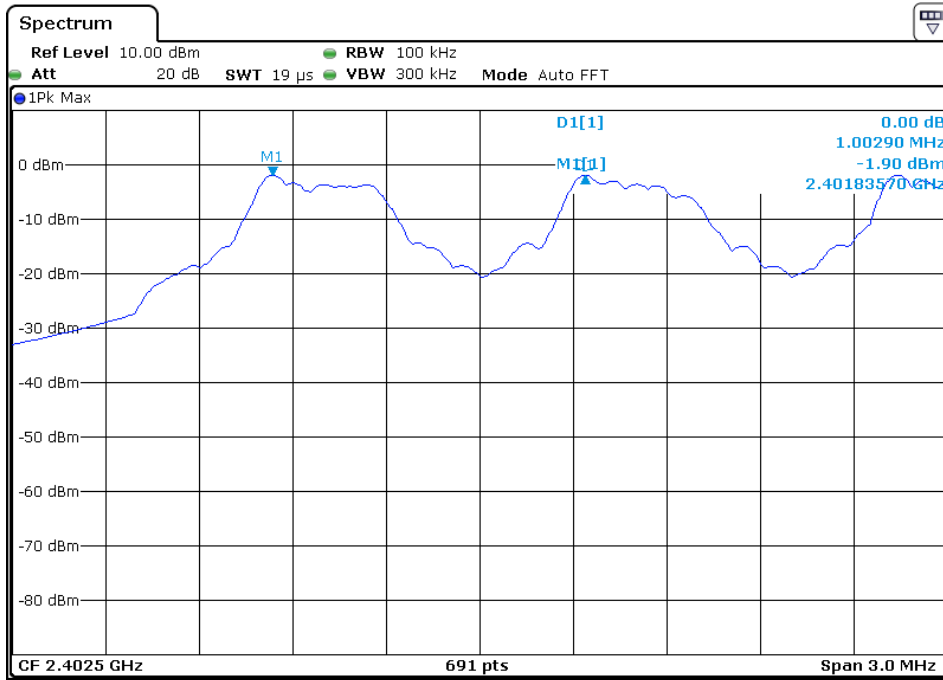

CH 39-1Mbps

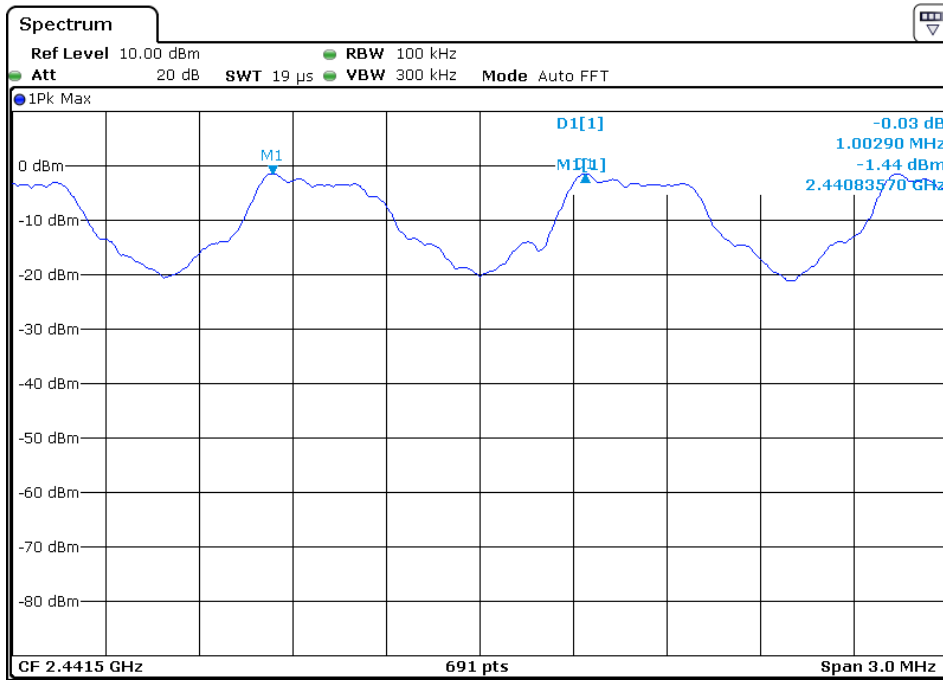

CH 78-1Mbps

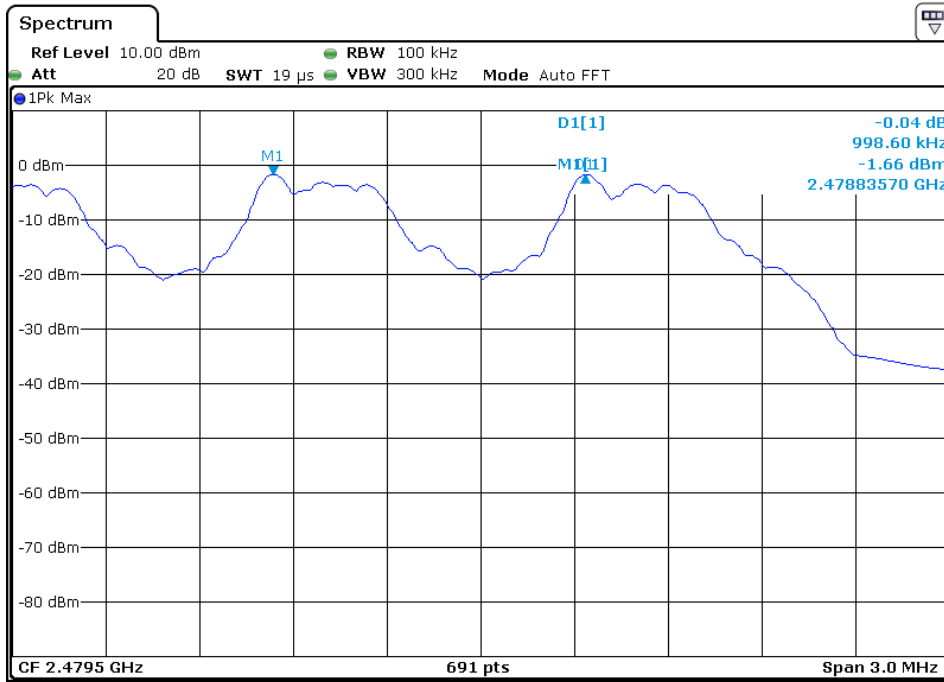

CH 00-3Mbps

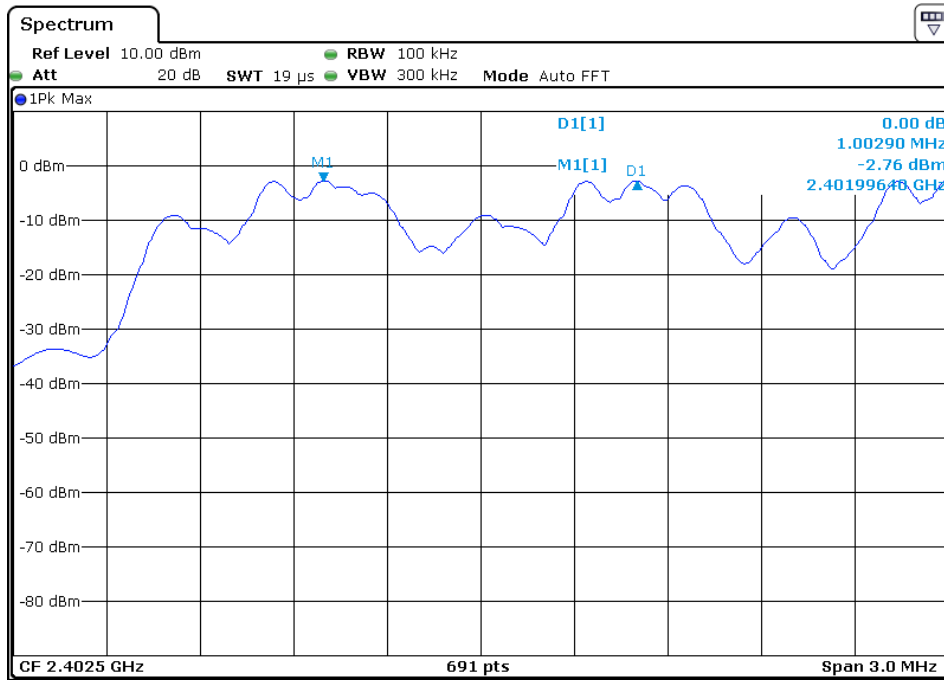

CH 39-3Mbps

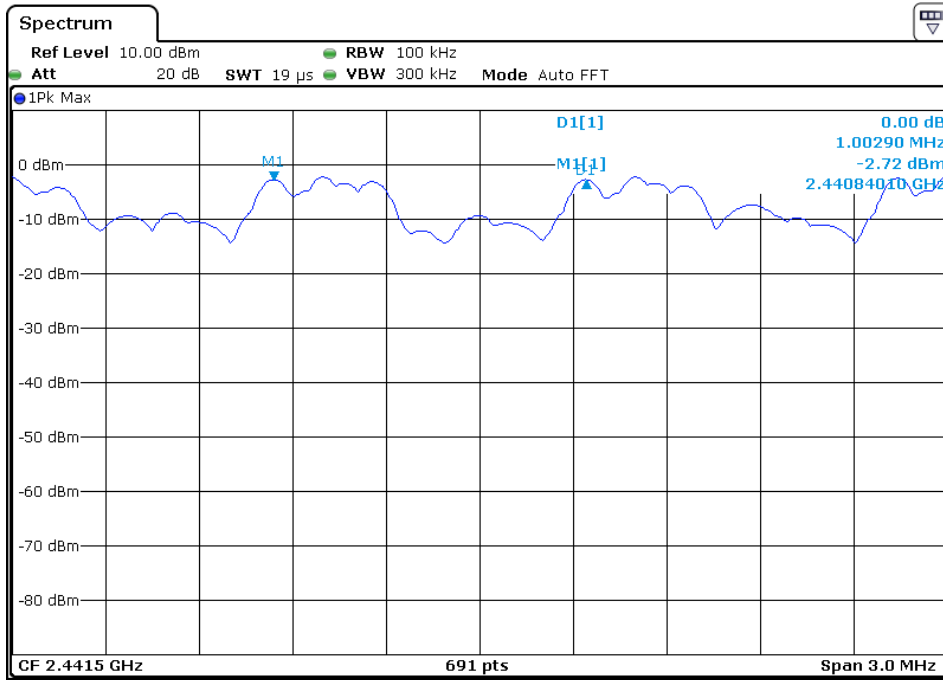

CH 78-3Mbps

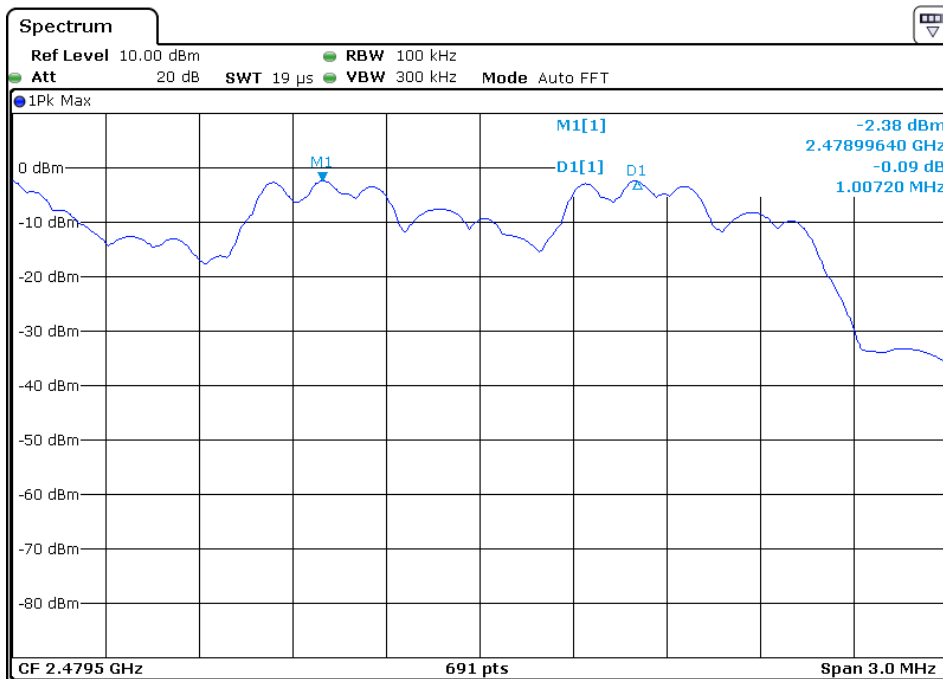

5.6 Hopping Channel Number

5.6.1 Applied procedures / Limit

15.247(a) (1) (iii) Frequency hopping systems in the 2400-2483.5 MHz band shall use at least 15 channels. The average time of occupancy on any channel shall not be greater than 0.4 seconds within a period of 0.4 seconds multiplied by the number of hopping channels employed. Frequency hopping systems may avoid or suppress transmissions on a particular hopping frequency provided that a minimum of 15 channels are used.

5.6.2 Test procedure

- (1) Connected the antenna port to the Spectrum Analyzer , set the Spectrum Analyzer as
Span = the frequency band of operation, $RBW \geq 1\%$ of the span, $VBW \geq RBW$ Sweep = auto
Detector function = peak, Trace = max hold
- (2) The EUT should be have its hopping function enabled. Maxhold and record hopping channels It may prove necessary to break the span up to sections, in order to clearly show all of the hopping frequencies.

5.6.3 Deviation from standard

No deviation.

5.6.4 Test setup



5.6.5 Test result

Hopping Channel Number result		
Operating Mode: 1Mbps/ 3Mbps Mode		Test date:2016-05-18
Result	Limit	Conclusion
79	15	Pass

EUT:	Sport Bluetooth headset	Model Name :	sportpods RACE
Temperature:	26 °C	Relative Humidity:	53%
Pressure:	1010 hPa	Test Power :	DC 3.7V from battery
Test Mode :	TX 1Mbps/ 3Mbps		

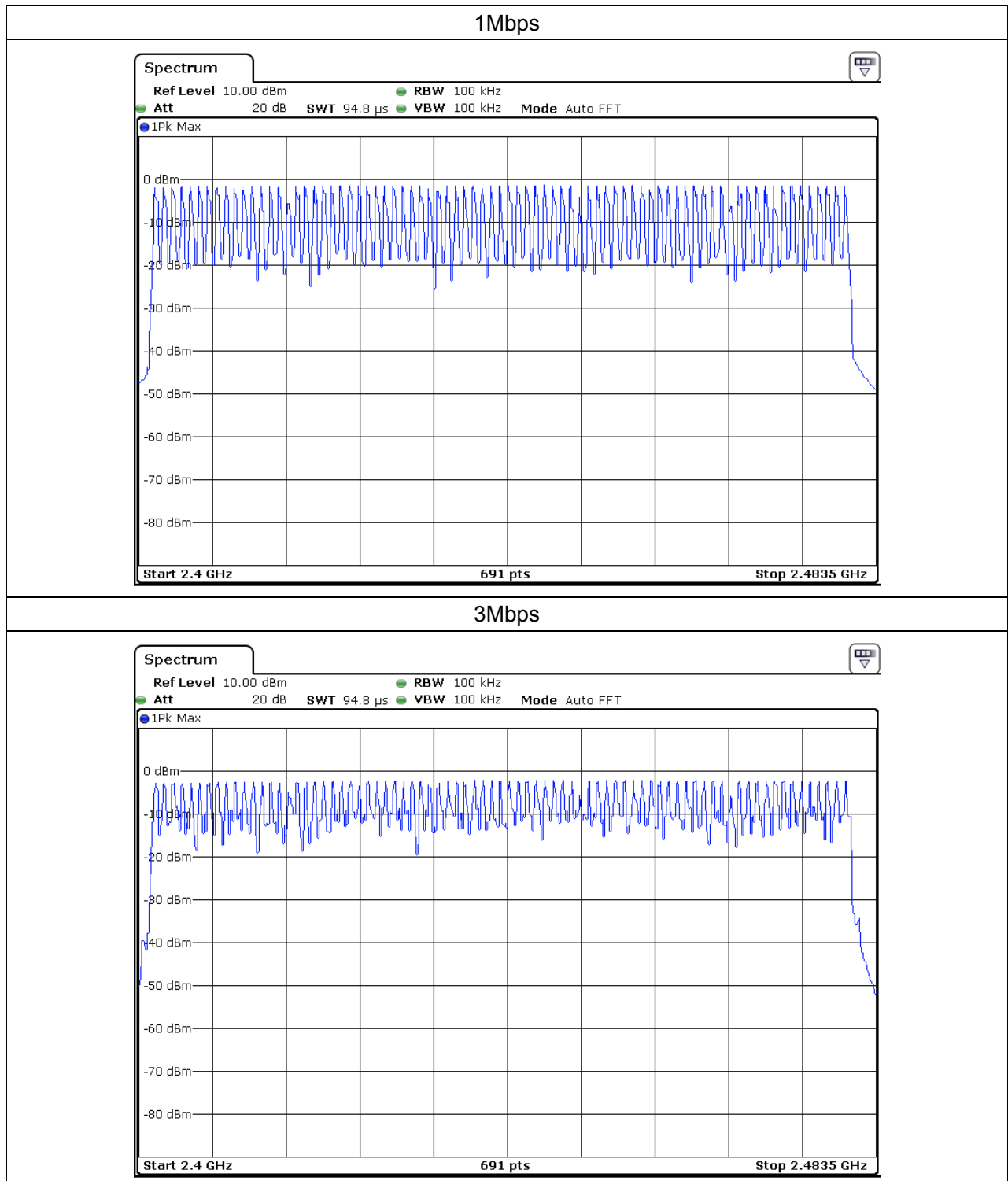

5.7 Dwell time

5.7.1 Applied procedures / Limit

15.247(a) (1) (iii) Frequency hopping systems in the 2400-2483.5 MHz band shall use at least 15 channels. The average time of occupancy on any channel shall not be greater than 0.4 seconds within a period of 0.4 seconds multiplied by the number of hopping channels employed. Frequency hopping systems may avoid or suppress transmissions on a particular hopping frequency provided that a minimum of 15 channels are used.

5.7.2 Test procedure

- (1) Place the EUT on the table in the chamber or connect the antenna port of the EUT to spectrum analyzer and set it in transmitting mode.
- (2) Set RBW of spectrum analyzer to 1MHz, VBW \geq RBW
- (3) Use a video trigger with the trigger level set to enable triggering only on full pulses.
- (4) Sweep Time is more than once pulse time.
- (5) Set the center frequency on any frequency would be measure and set the frequency span to zero span.
- (6) Measure the maximum time duration of one single pulse.
- (7) Set the EUT for DH5, DH3 and DH1 packet transmitting.
- (8) Measure the maximum time duration of one single pulse.
- (9) A Period Time = $79 \times 0.4 = 31.6$ S
DH1 Time Slot: Reading * $(1600/2) \times 31.6/79$
DH3 Time Slot: Reading * $(1600/4) \times 31.6/79$
DH5 Time Slot: Reading * $(1600/6) \times 31.6/79$

5.7.3 Deviation from standard

No deviation.

5.7.4 Test setup



5.7.5 Test result

EUT:	Sport Bluetooth headset	Model Name :	sportpods RACE
Temperature:	26 °C	Relative Humidity:	53%
Pressure:	1010 hPa	Test Power :	DC 3.7V from battery
Test Mode :	CH00-DH1/DH3/DH5 (1Mbps Mode)		

Data Packet	Frequency	Pulse Duration (ms)	Dwell Time (ms)	Limits (s)
DH1	2402 MHz	0.417	0.133	0.4000
DH3	2402 MHz	1.686	0.269	0.4000
DH5	2402 MHz	2.915	0.310	0.4000

CH 00- DH1

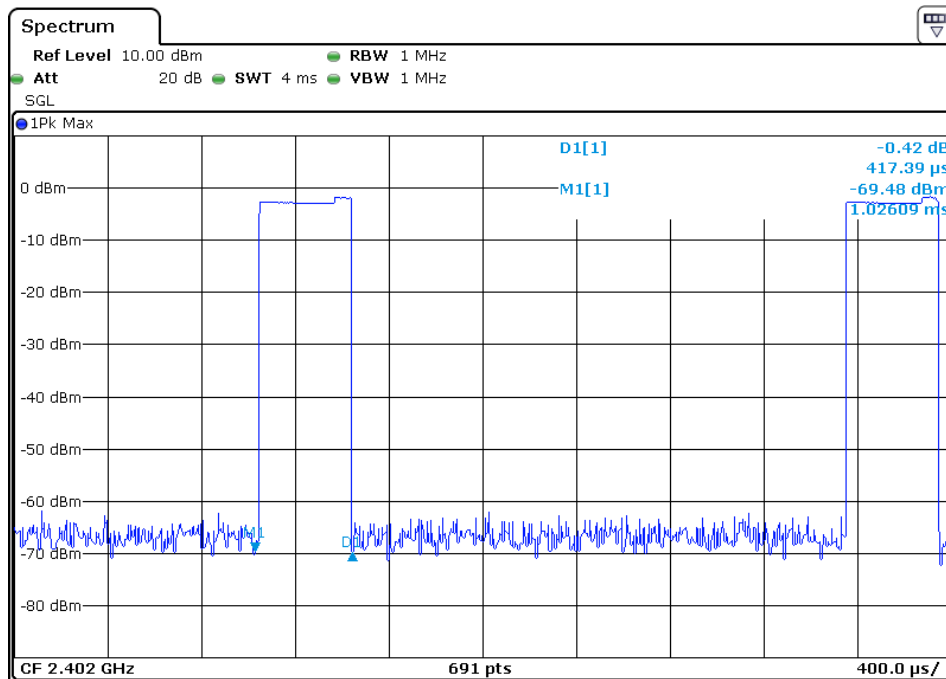

CH 00- DH3

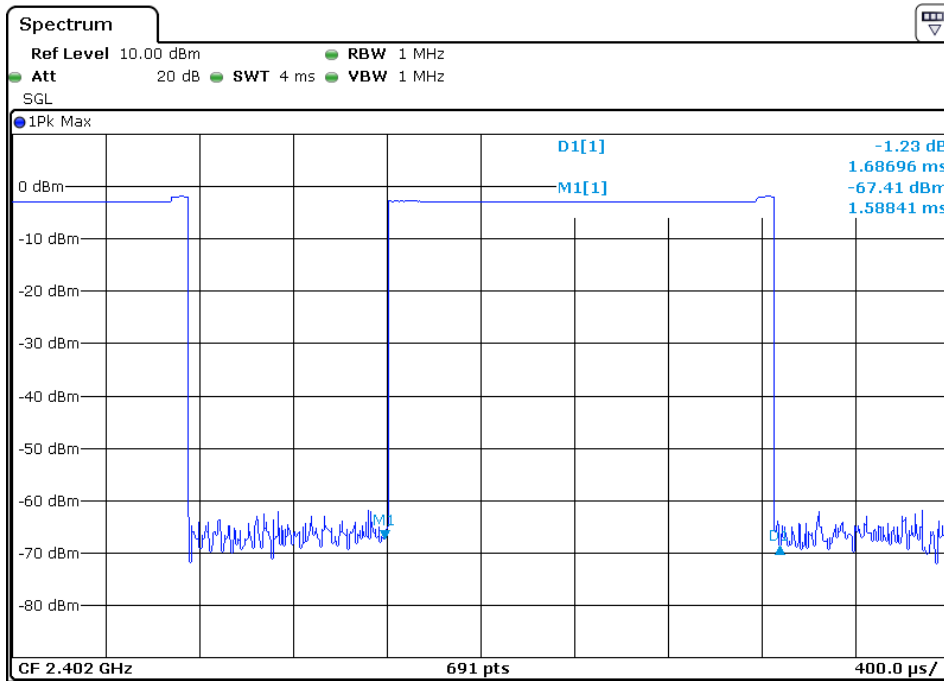

CH 00- DH5

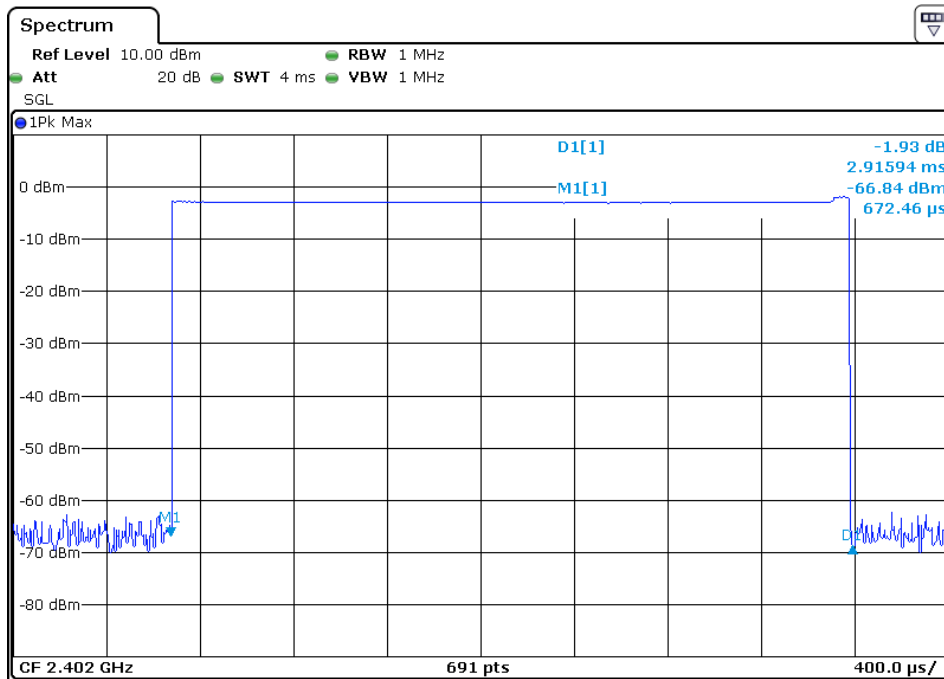

EUT:	Sport Bluetooth headset	Model Name :	sportpods RACE
Temperature:	26 °C	Relative Humidity:	53%
Pressure:	1010 hPa	Test Power :	DC 3.7V from battery
Test Mode :	CH00-3DH1/3DH3/3DH5 (3Mbps Mode)		

Data Packet	Frequency	Pulse Duration (ms)	Dwell Time (ms)	Limits (s)
3DH1	2402 MHz	0.417	0.133	0.4000
3DH3	2402 MHz	1.657	0.265	0.4000
3DH5	2402 MHz	2.915	0.310	0.4000

CH 00- DH1

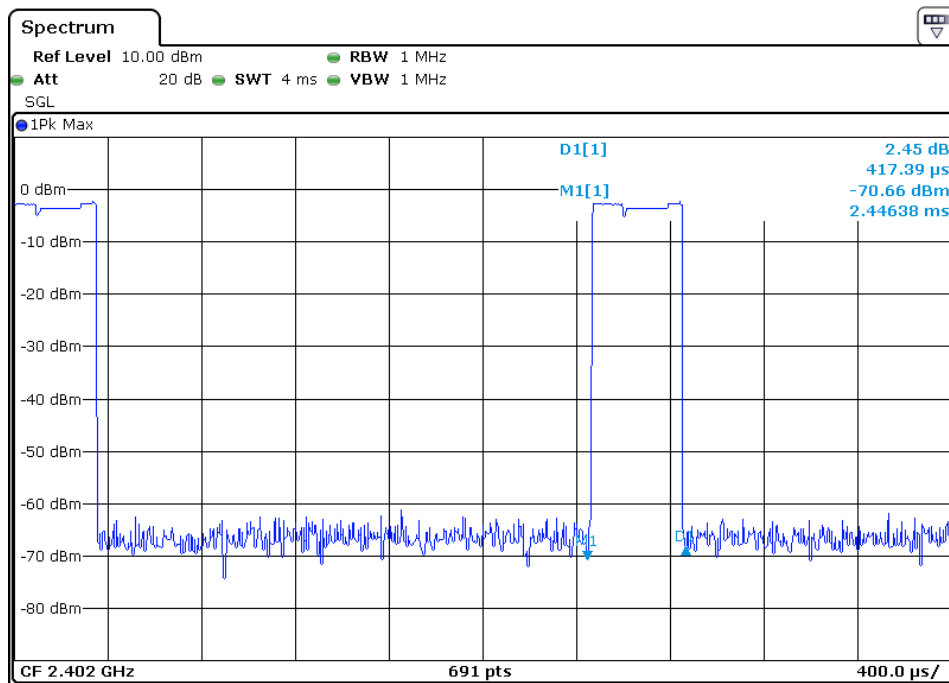

CH 00- DH3

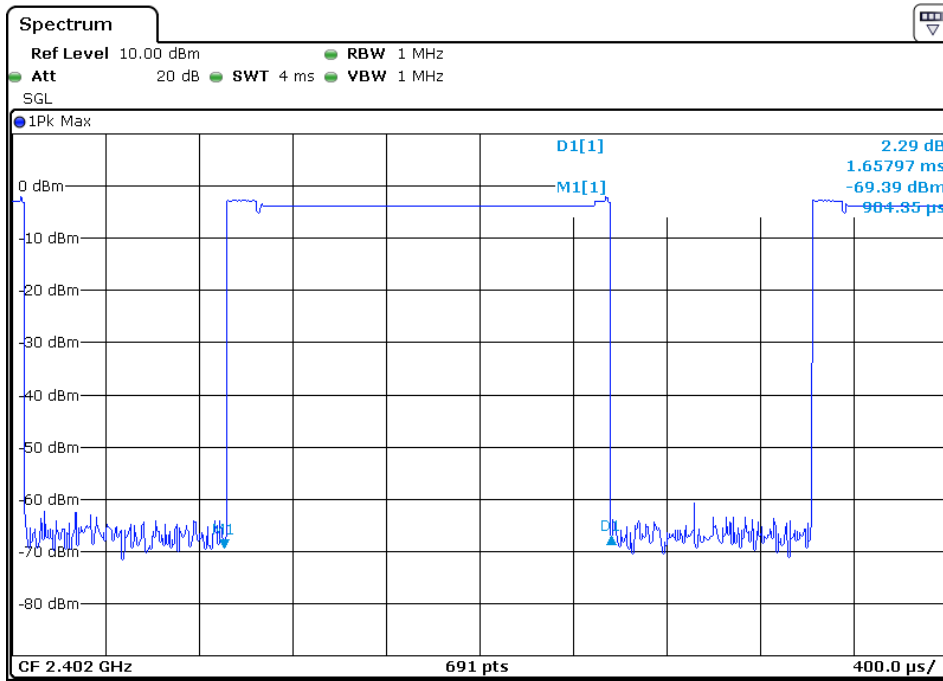

CH 00- DH5

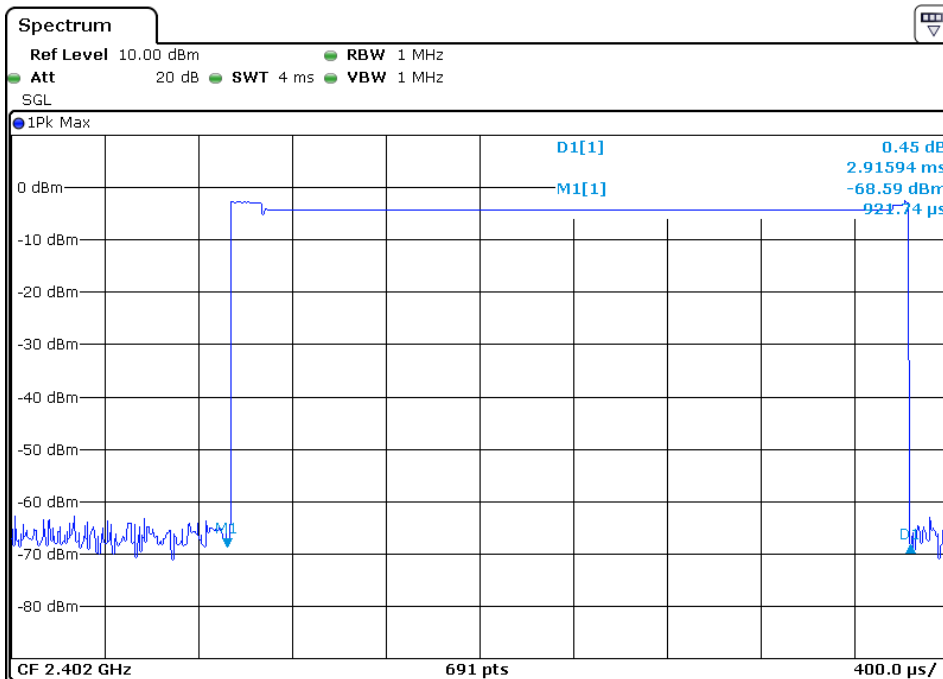

5.8 Maximum Peak Output Power

5.8.1 Applied procedures / Limit

15.247(a) (1) Frequency hopping systems shall have hopping channel carrier frequencies separated by a minimum of 25 kHz or the 20 dB bandwidth of the hopping channel, whichever is greater. Alternatively, frequency hopping systems operating in the 2400–2483.5 MHz band may have hopping channel carrier frequencies that are separated by 25 kHz or two-thirds of the 20 dB bandwidth of the hopping channel, whichever is greater, provided the systems operate with an output power no greater than 125 mW.

15.247(b) (1) For frequency hopping systems operating in the 2400-2483.5 MHz band employing at least 75 non-overlapping hopping channels, and all frequency hopping systems in the 5725-5850 MHz band: 1watt. For all other frequency hopping systems in the 2400-2483.5 MHz band: 0.125 watts.

5.8.2 Test procedure

- (1) Connected the antenna port to the Spectrum Analyzer, set the Spectrum Analyzer as
Span = approximately 5 times the 20 dB bandwidth, centered on a hopping channel
RBW > the 20 dB bandwidth of the emission being measured, VBW \geq RBW, Sweep = auto
Detector function = peak, Trace = max hold
- (2) The EUT should be transmitting at its maximum data rate. Allow the trace to stabilize. Use the marker-to-peak function to set the marker to the peak of the emission. The indicated level is the peak output power.
- (3) The above procedure shall be repeated at the lowest, the middle, and the highest frequency of the stated frequency range with modulated mode. Also shall be performed at different modes of operation.

5.8.3 Deviation from standard

No deviation.

5.8.4 Test setup

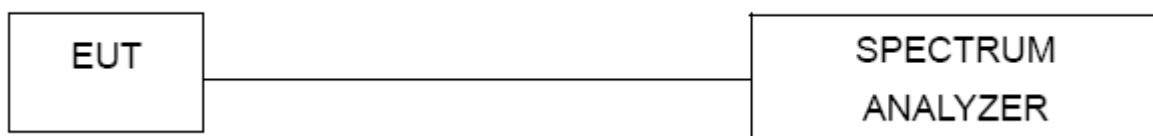

5.8.5 Test results

EUT:	Sport Bluetooth headset	Model Name :	sportpods RACE
Temperature:	26 °C	Relative Humidity:	60%
Pressure:	1010 hPa	Test Voltage :	DC 3.7V from battery
Test Mode :	TX		
Note: All the data rates have be tested and the worst-case as the table below.			

Test Mode	Frequency	Peak Output Power (dBm)	Limit (dBm)	Result
Data rate 1Mbps	2402 MHz	-1.58	21	Pass
	2441 MHz	-1.16	21	Pass
	2480 MHz	-1.25	21	Pass
Data rate 3Mbps	2402 MHz	-1.26	21	Pass
	2441 MHz	-0.90	21	Pass
	2480 MHz	-1.06	21	Pass
Cable loss = 1.0 dBm				

CH 00-1Mbps

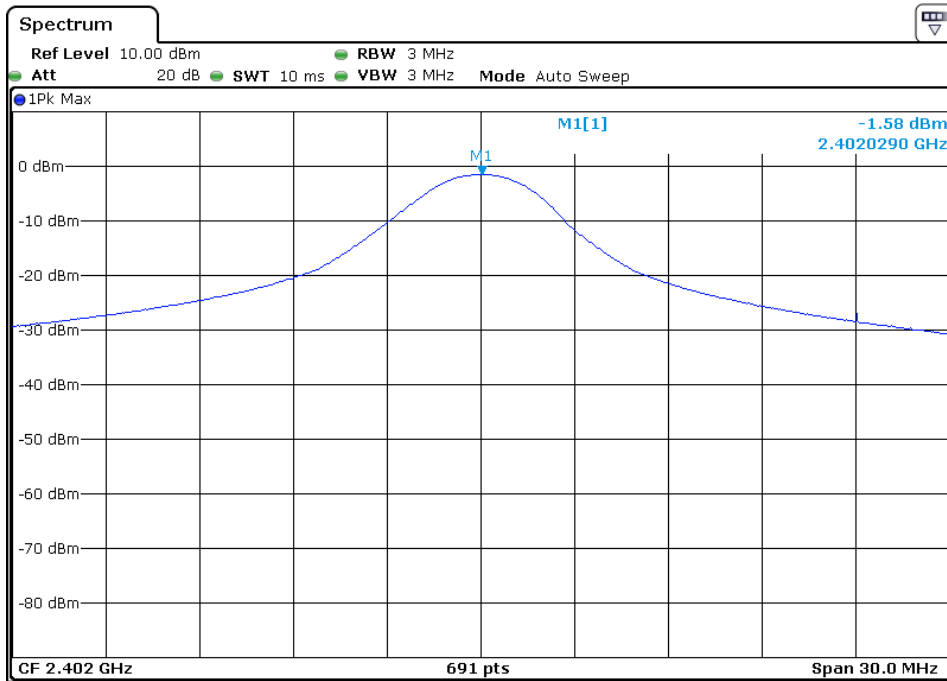

CH 39-1Mbps

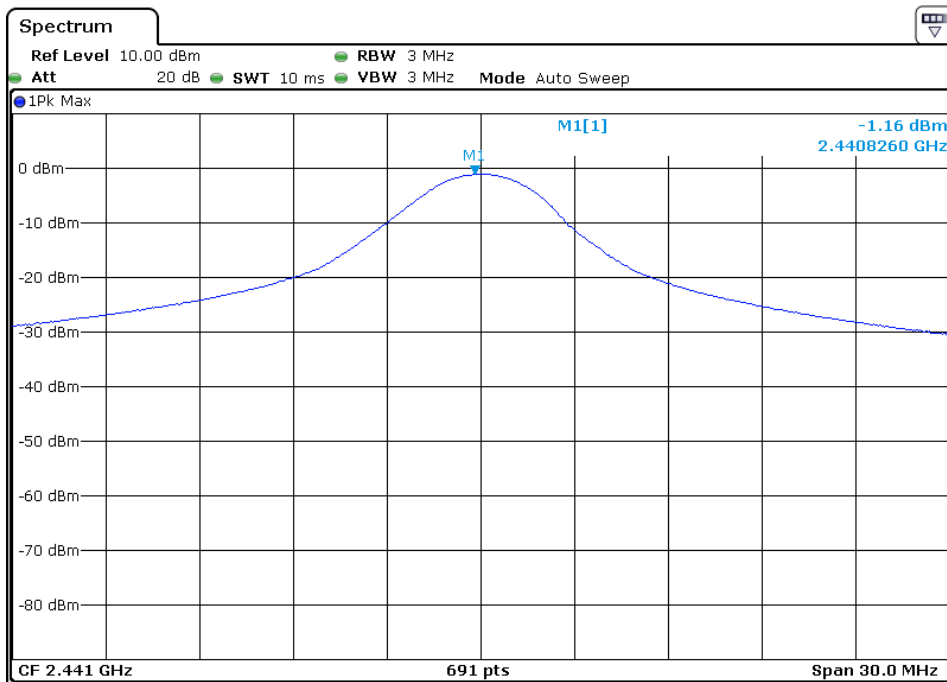

CH 78-1Mbps

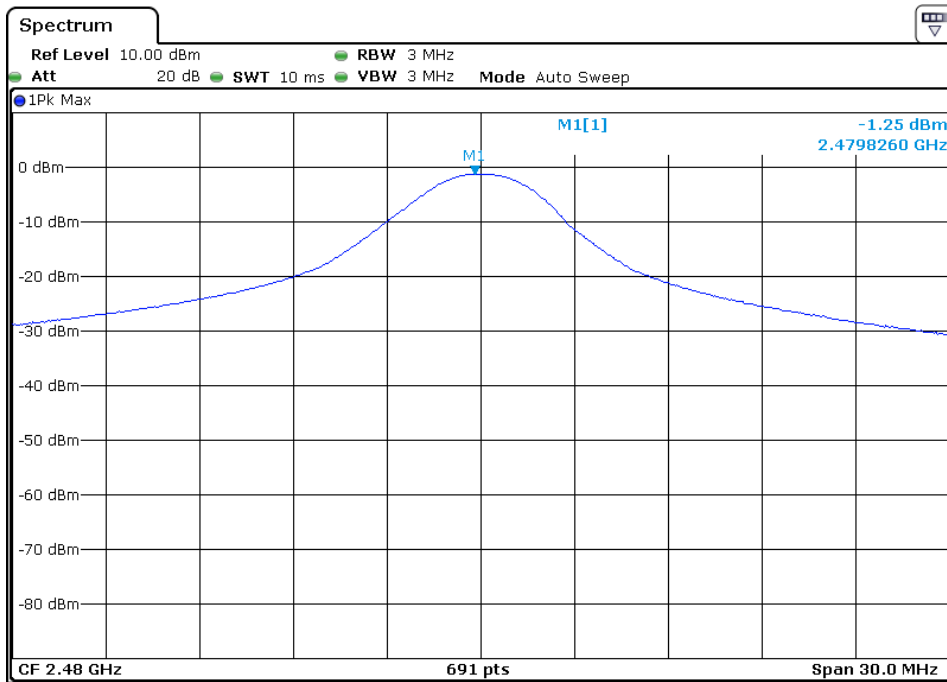

CH 00-3Mbps

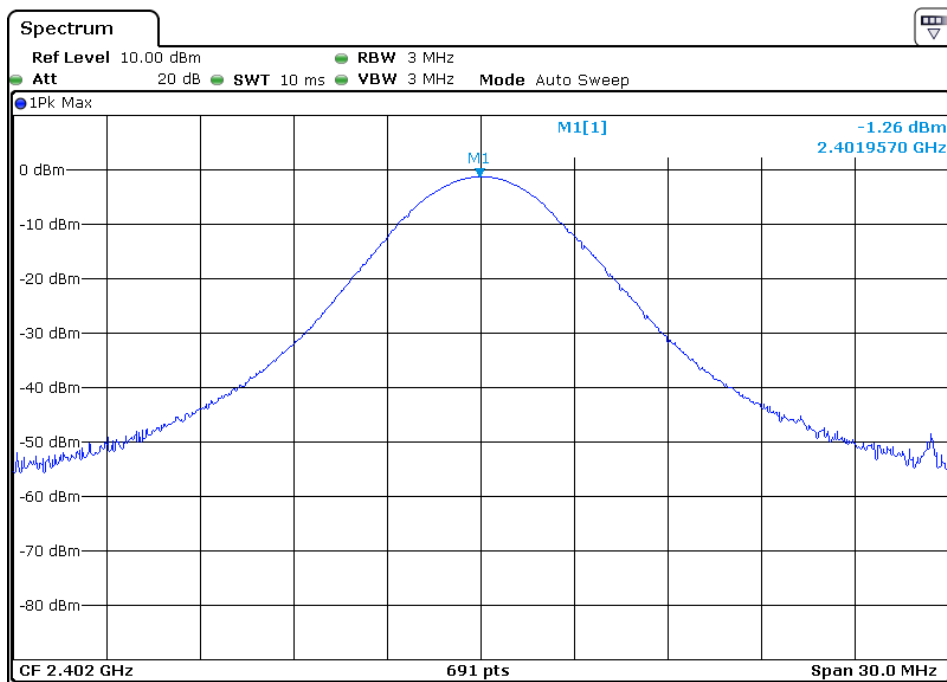

CH 39-3Mbps

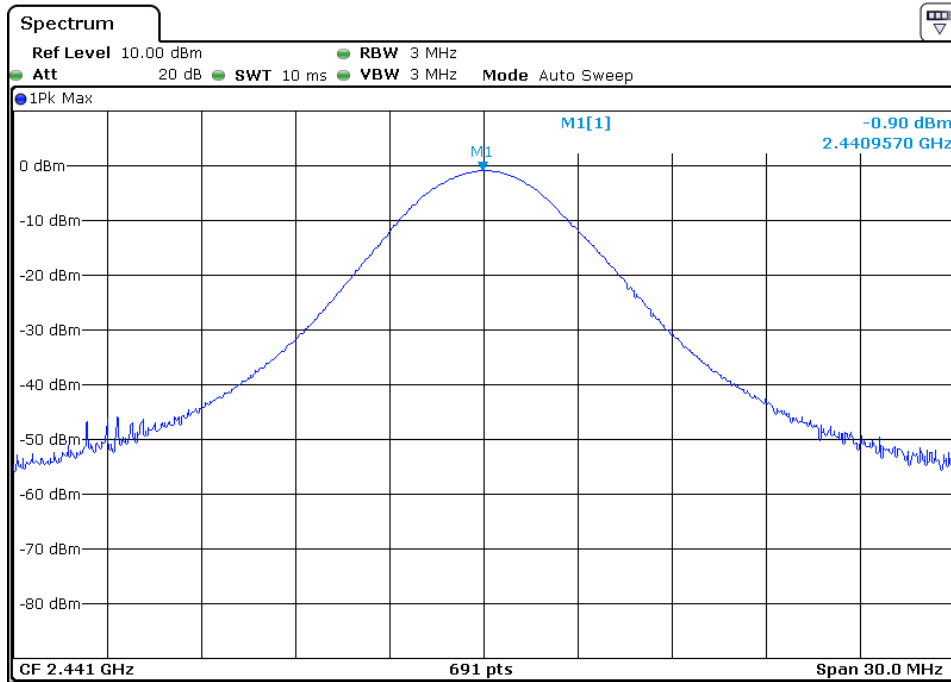

CH 78-3Mbps

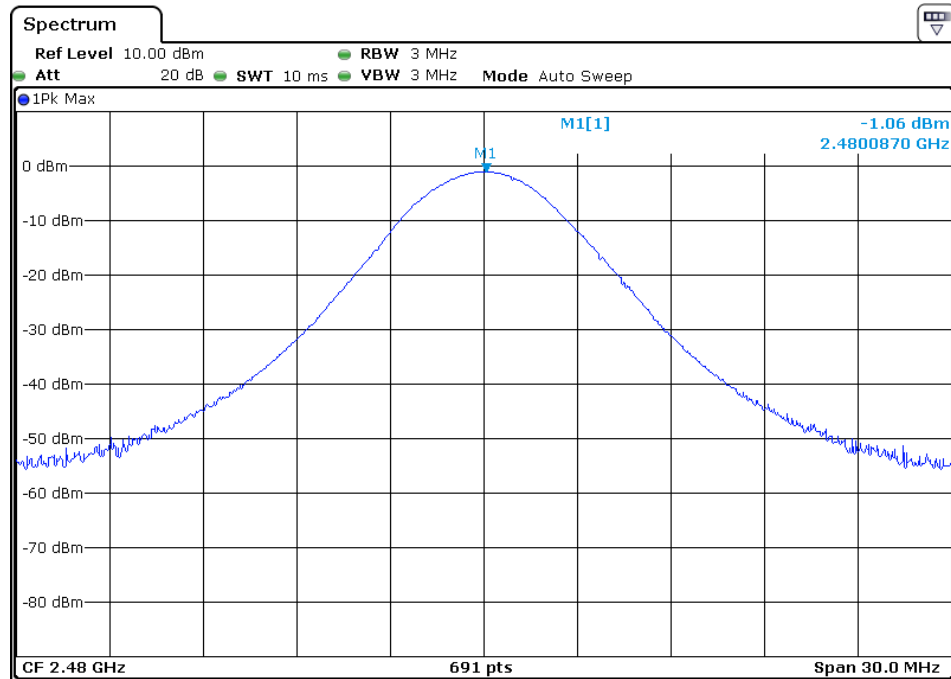

5.9 Band edge

5.9.1 Applied procedures / Limit

15.247(d) In any 100 kHz bandwidth outside the frequency band in which the spread spectrum or digitally modulated intentional radiator is operating, the radio frequency power that is produced by the intentional radiator shall be at least 20 dB below that in the 100 kHz bandwidth within the band that contains the highest level of the desired power, based on either an RF conducted or a radiated measurement, provided the transmitter demonstrates compliance with the peak conducted power limits. If the transmitter complies with the conducted power limits based on the use of RMS averaging over a time interval, as permitted under paragraph (b)(3) of this section, the attenuation required under this paragraph shall be 30 dB instead of 20 dB. Attenuation below the general limits specified in Section 15.209(a) is not required. In addition, radiated emissions which fall in the restricted bands, as defined in Section 15.205(a), must also comply with the radiated emission limits specified in Section 15.209(a) (see Section 15.205(c)).

5.9.2 Test procedure

- a. The EUT was directly connected to the spectrum analyzer and antenna output port as show in the block diagram below.
- b. Span = wide enough to capture the peak level of the emission operating on the channel closest to the bandedge, as well as any modulation products which fall outside of the authorized band of operation, $RBW \geq 1\%$ of the span, $VBW \geq RBW$, Sweep = auto, Detector function = peak, Trace = max hold

5.9.3 Deviation from standard

No deviation.

5.9.4 Test setup

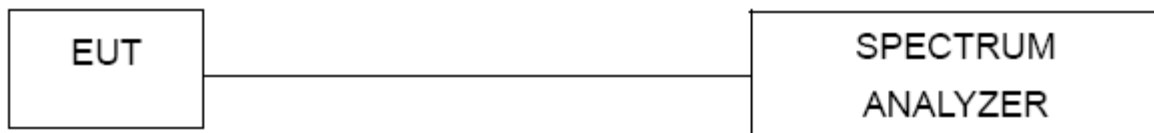

5.9.5 Test results

CH00 (Lower) Data rate 1Mbps

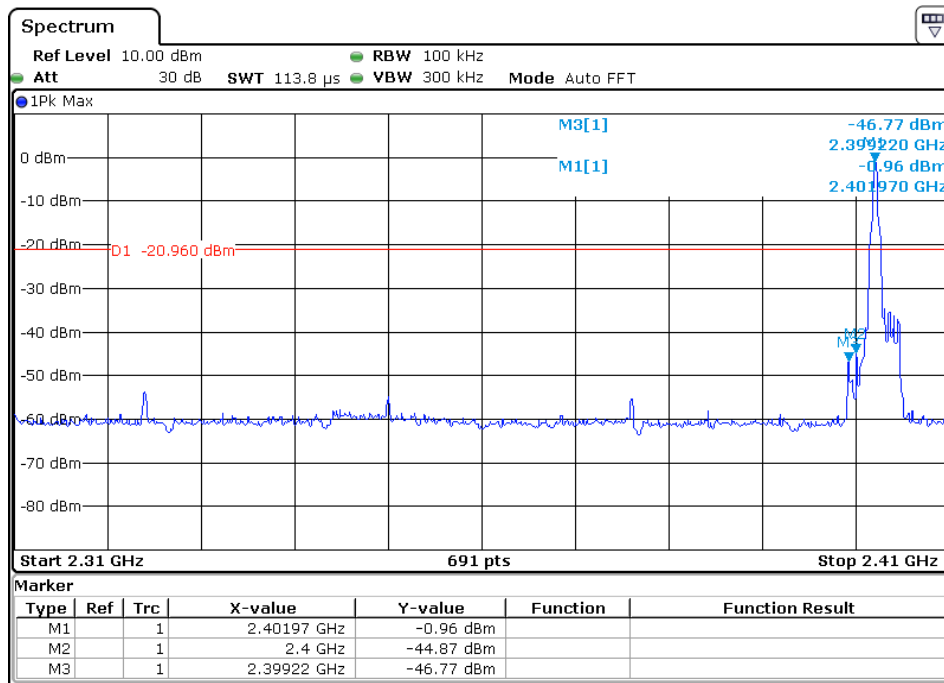

CH 78 (Upper) Data rate 1Mbps

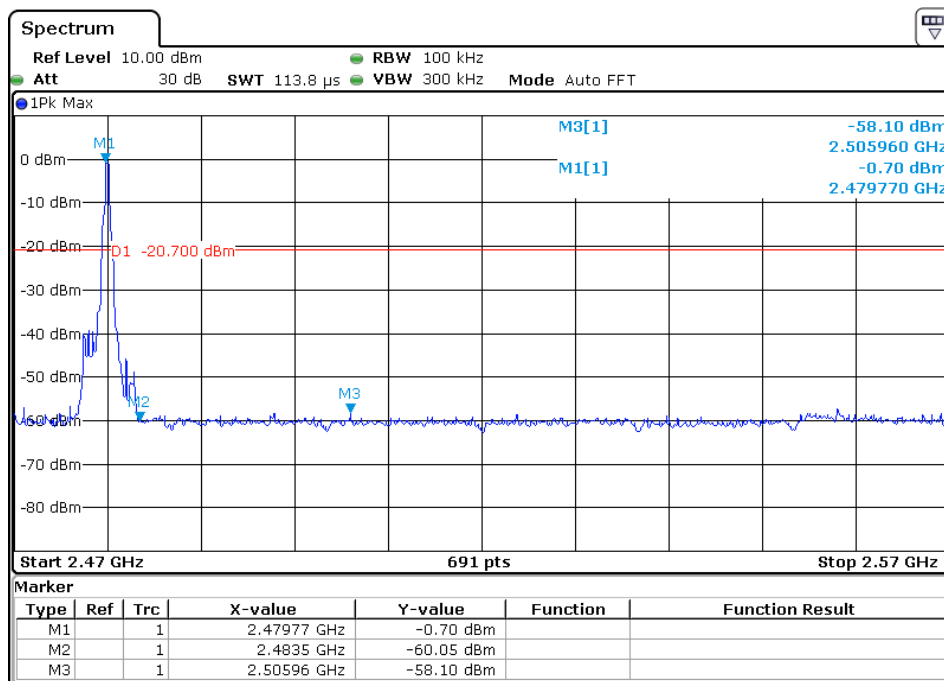

CH00 (Lower) Data rate 3Mbps

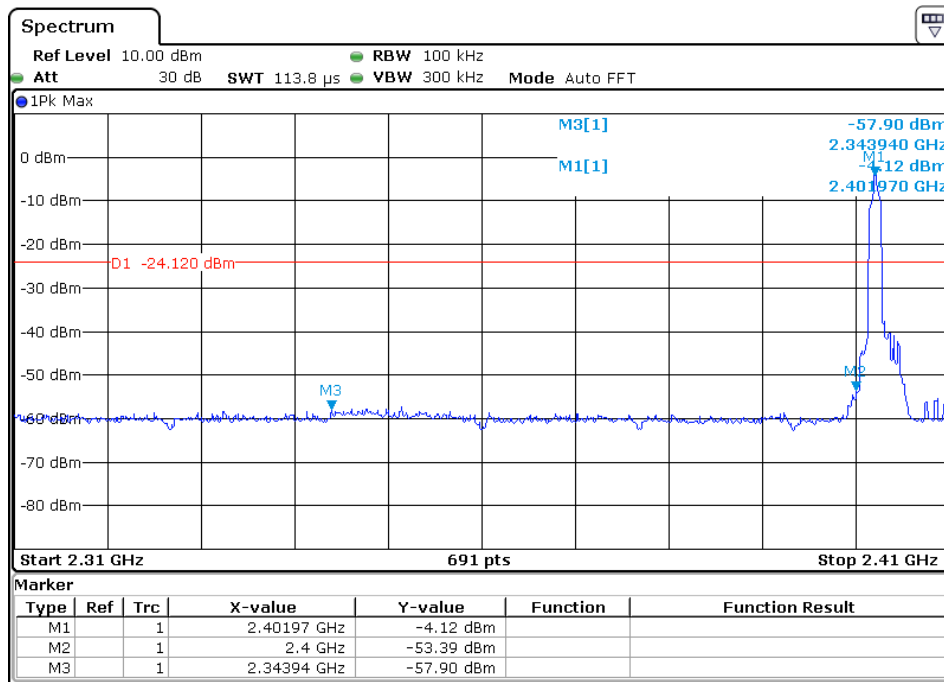

CH 78 (Upper) Data rate 3Mbps

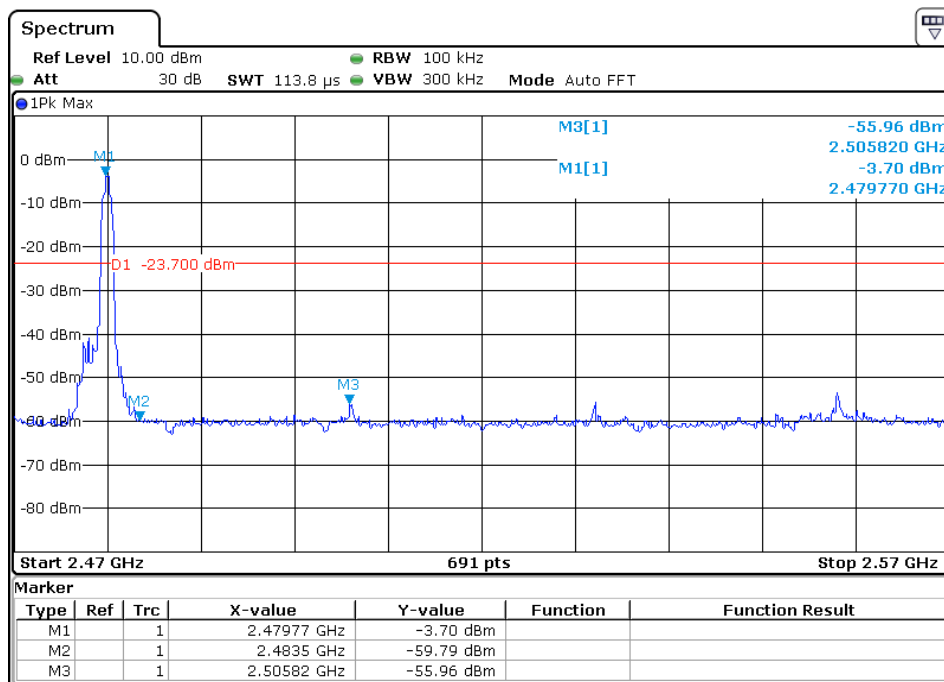

CH00 (Lower) Data rate 1Mbps

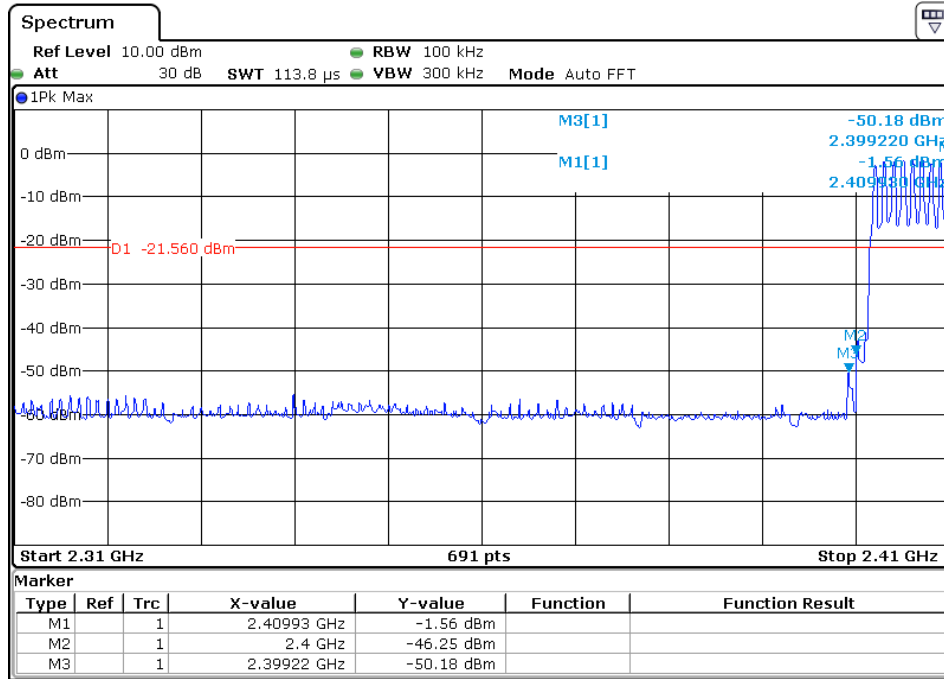

CH 78 (Upper) Data rate 1Mbps

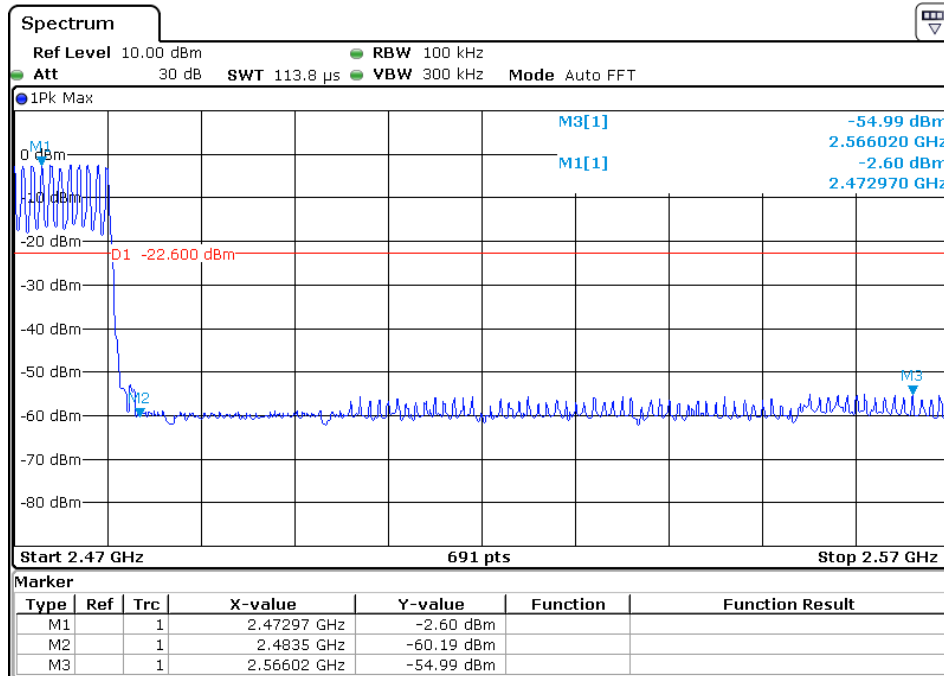

CH00 (Lower) Data rate 3Mbps

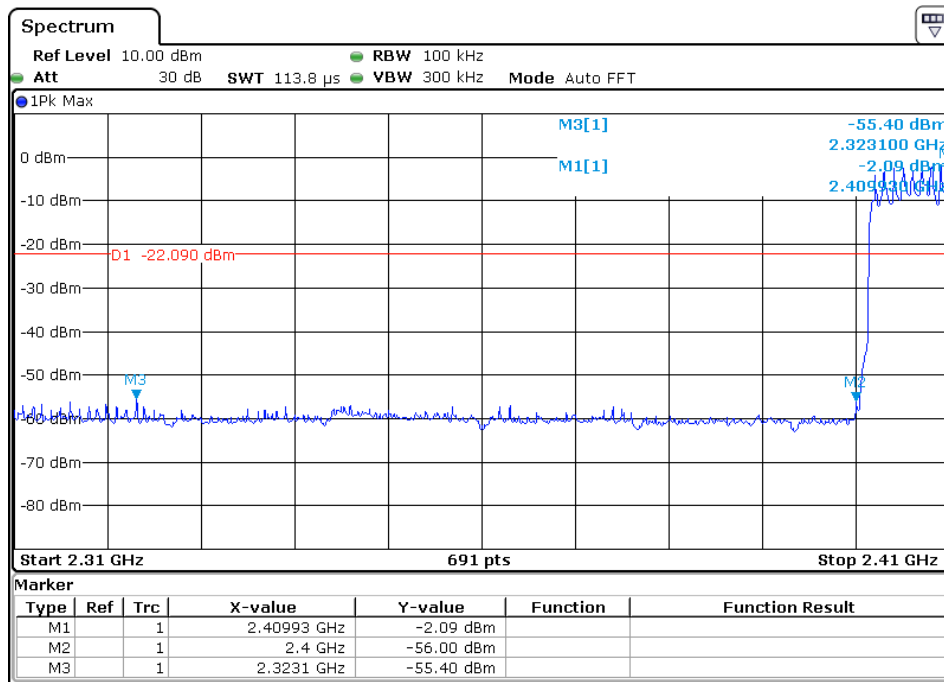

CH 78 (Upper) Data rate 3Mbps

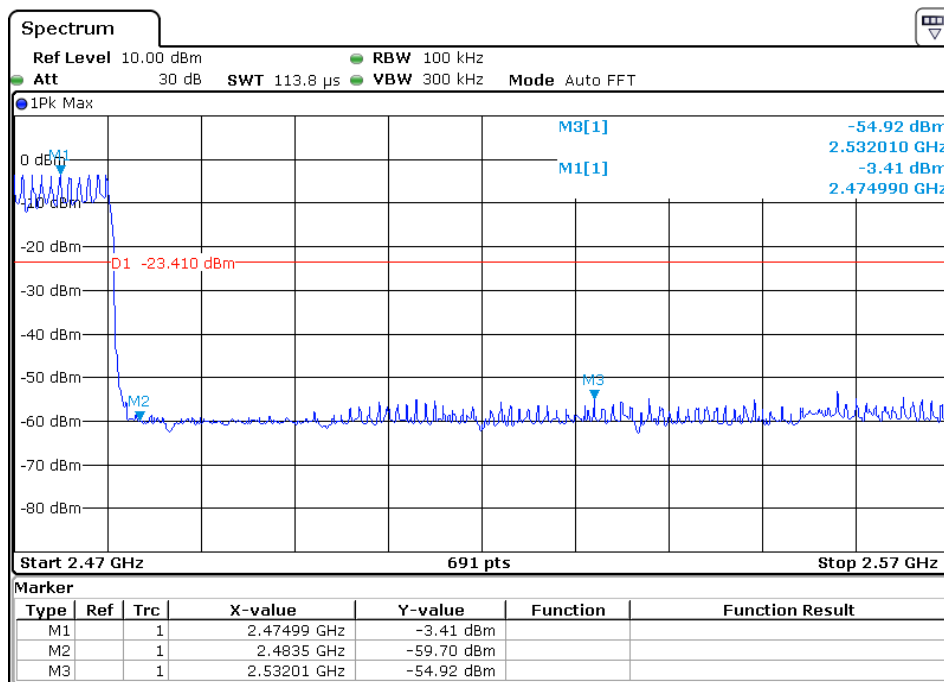

5.10 Conducted Spurious Emissions

5.10.1 Applied procedures / Limit

15.247(d) In any 100 kHz bandwidth outside the frequency band in which the spread spectrum or digitally modulated intentional radiator is operating, the radio frequency power that is produced by the intentional radiator shall be at least 20 dB below that in the 100 kHz bandwidth within the band that contains the highest level of the desired power, based on either an RF conducted or a radiated measurement, provided the transmitter demonstrates compliance with the peak conducted power limits. If the transmitter complies with the conducted power limits based on the use of RMS averaging over a time interval, as permitted under paragraph (b)(3) of this section, the attenuation required under this paragraph shall be 30 dB instead of 20 dB. Attenuation below the general limits specified in Section 15.209(a) is not required. In addition, radiated emissions which fall in the restricted bands, as defined in Section 15.205(a), must also comply with the radiated emission limits specified in Section 15.209(a) (see Section 15.205(c)).

5.10.2 Test procedure

- a. The EUT was directly connected to the spectrum analyzer and antenna output port as show in the block diagram below.
- b. Span = wide enough to capture the peak level of the in-band emission and all spurious emissions (e.g., harmonics) from the lowest frequency generated in the EUT up through the 10th harmonic. Typically, several plots are required to cover this entire span. RBW = 100 kHz
VBW \geq RBW, Sweep = auto, Detector function = peak, Trace = max hold
sweep points \geq investigated frequency range/RBW.

5.10.3 Deviation from standard

No deviation.

5.10.4 Test setup



5.10.5 Test results

CH00 Data rate 1Mbps

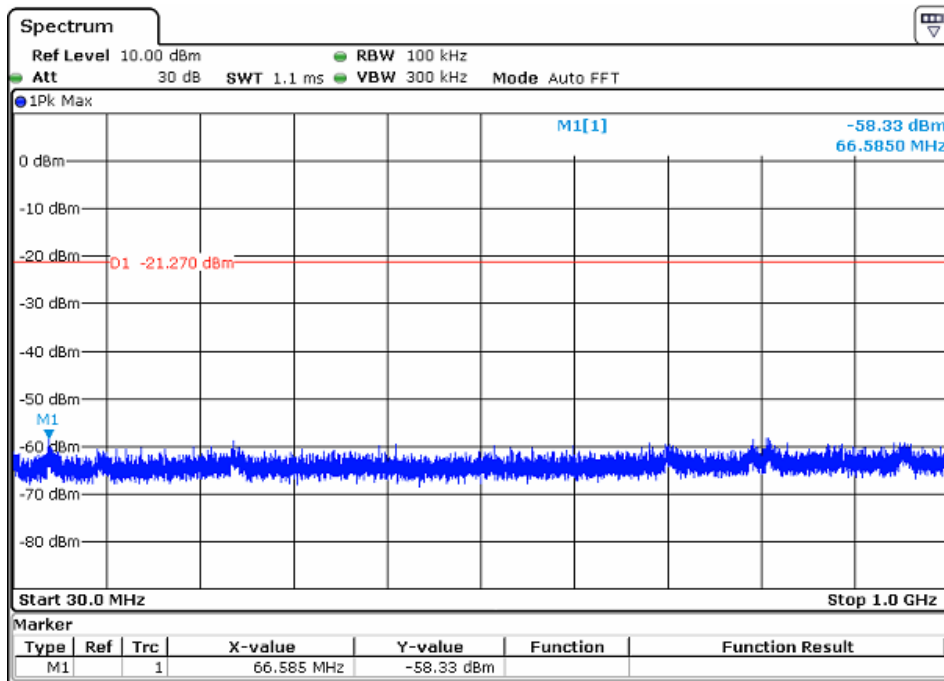

Note: Sweep Points=9700
CH00 Data rate 1Mbps

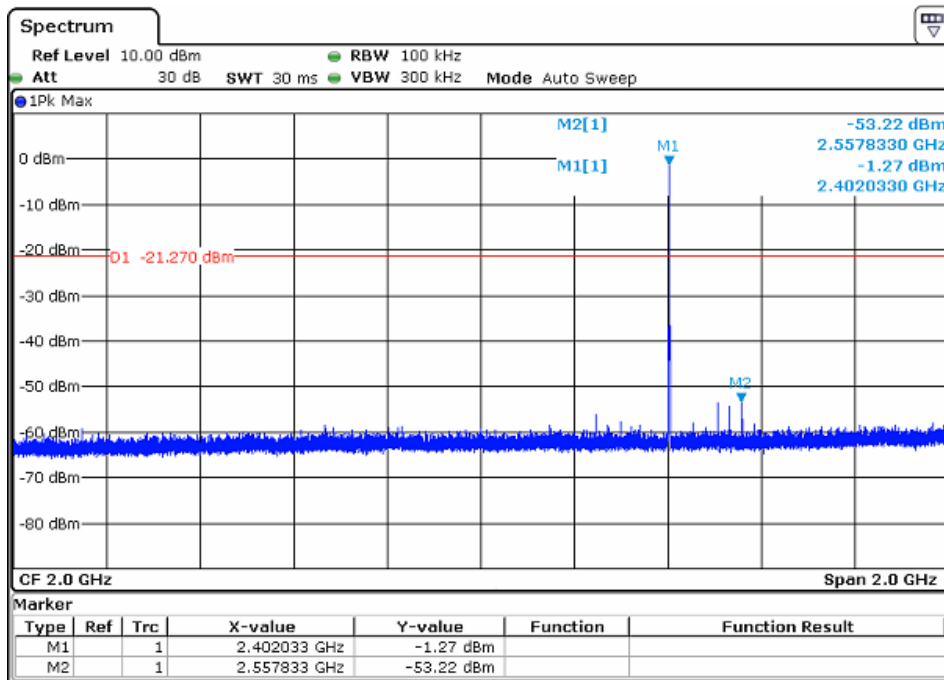

Note: Sweep Points=20000

CH00 Data rate 1Mbps

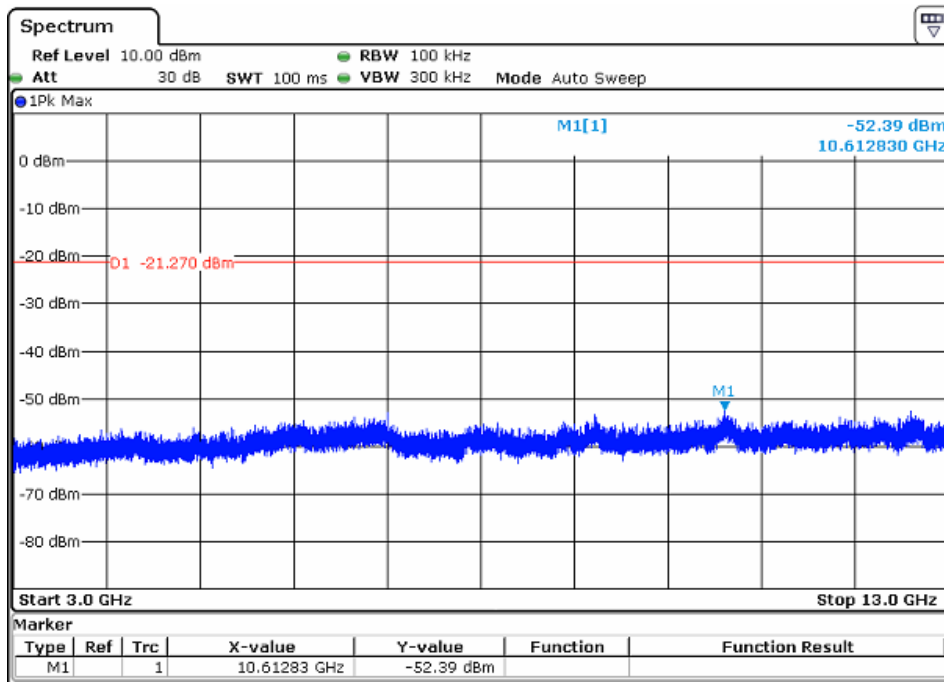

Note: Sweep Points=100000

CH00 Data rate 1Mbps

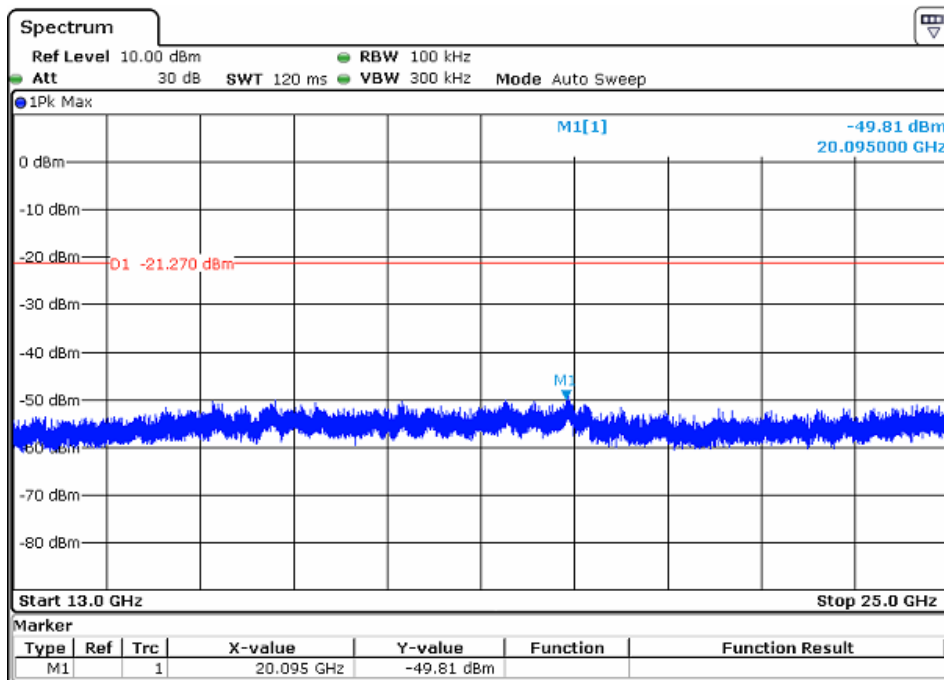

Note: Sweep Points=120000

CH39 Data rate 1Mbps

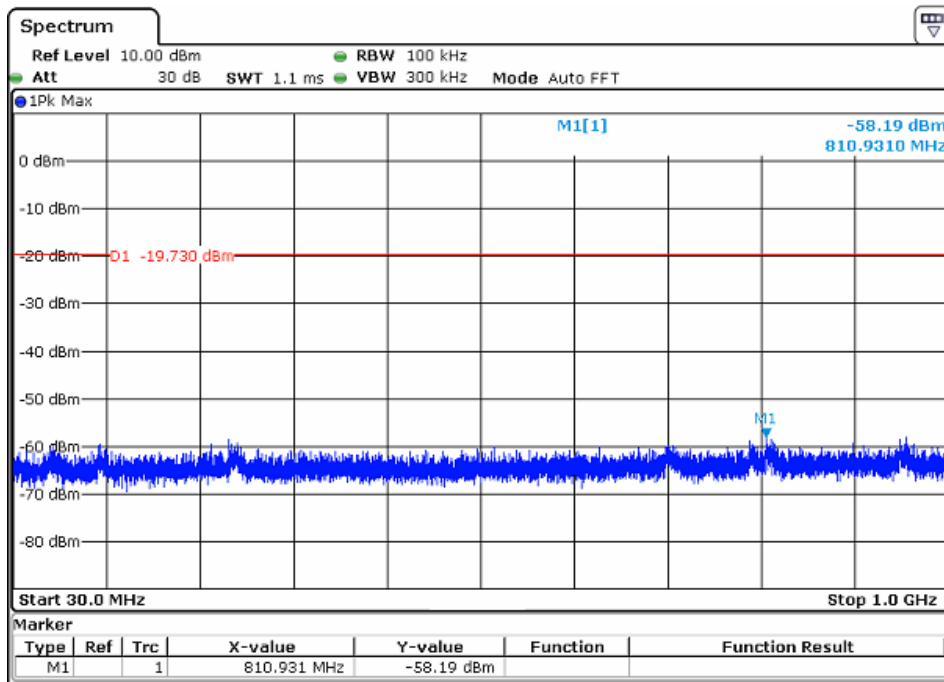

Note: Sweep Points=9700

CH39 Data rate 1Mbps

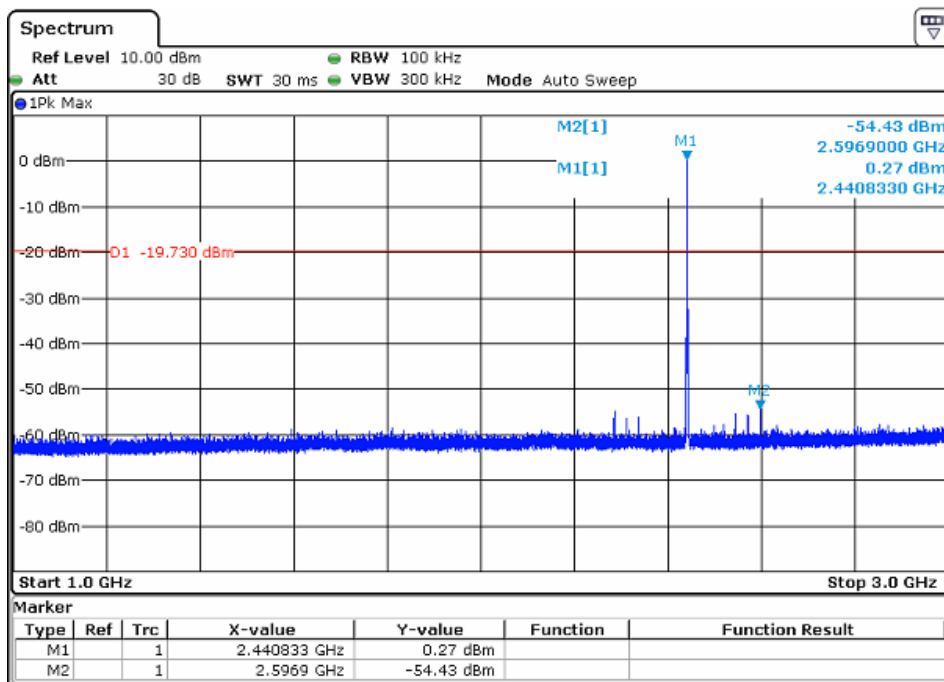

Note: Sweep Points=20000

CH39 Data rate 1Mbps

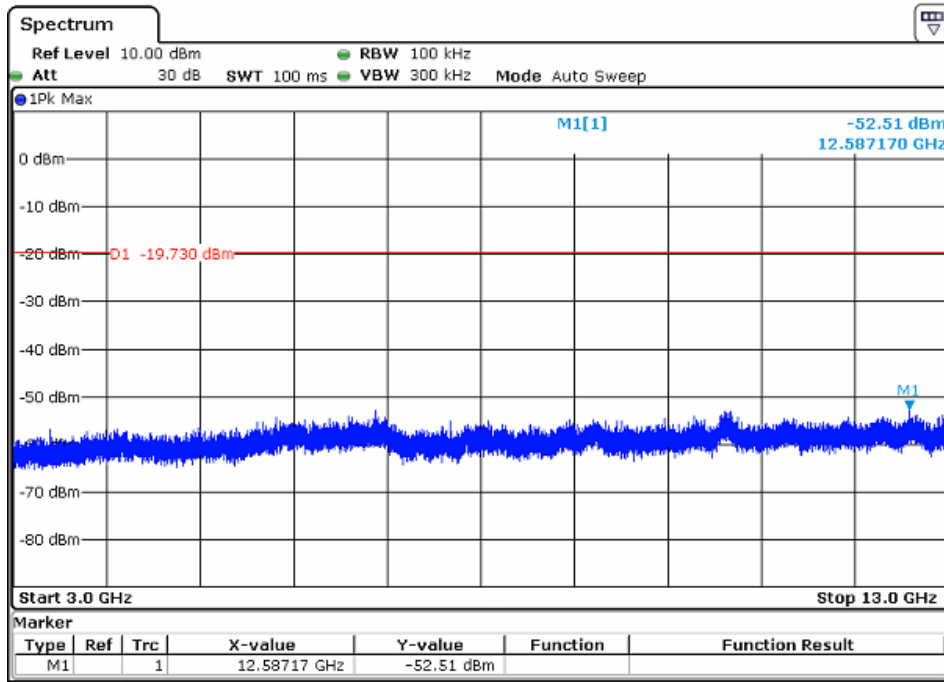

Note: Sweep Points=100000

CH39 Data rate 1Mbps

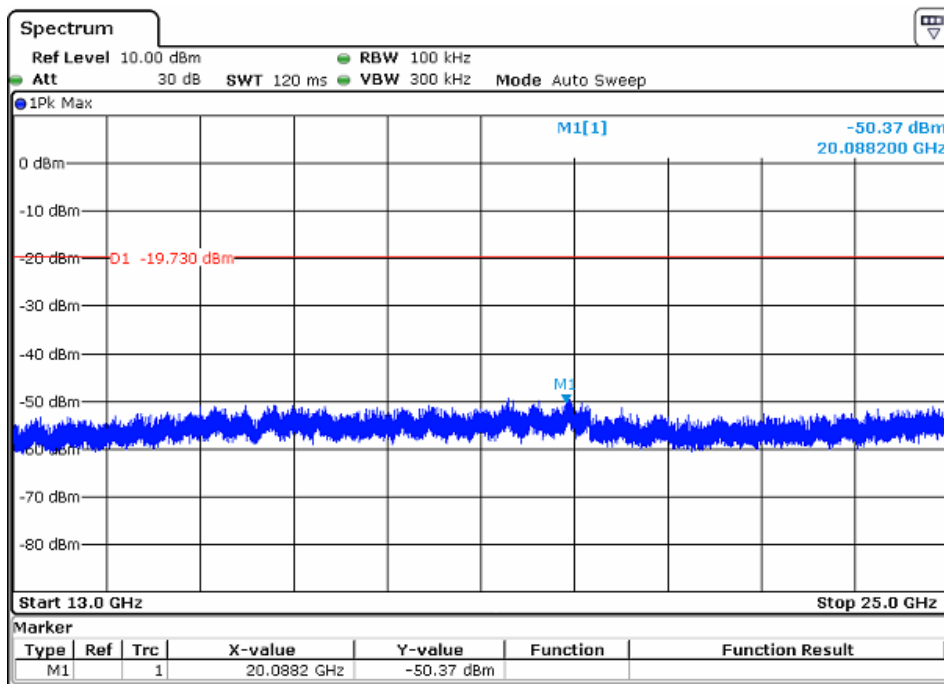

Note: Sweep Points=120000

CH78 Data rate 1Mbps

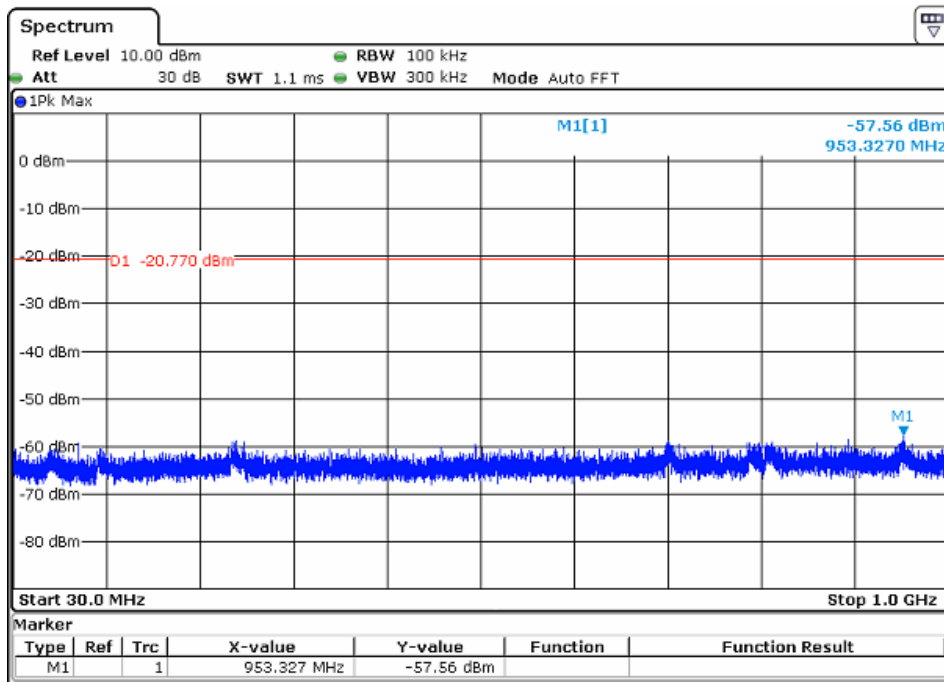

Note: Sweep Points=9700

CH78 Data rate 1Mbps

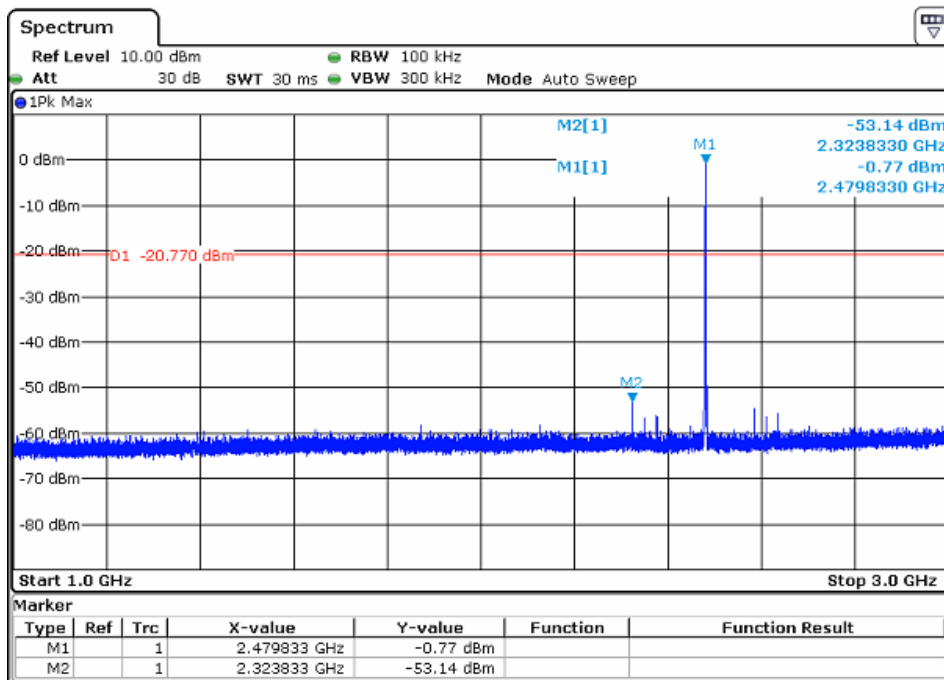

Note: Sweep Points=20000

CH78 Data rate 1Mbps

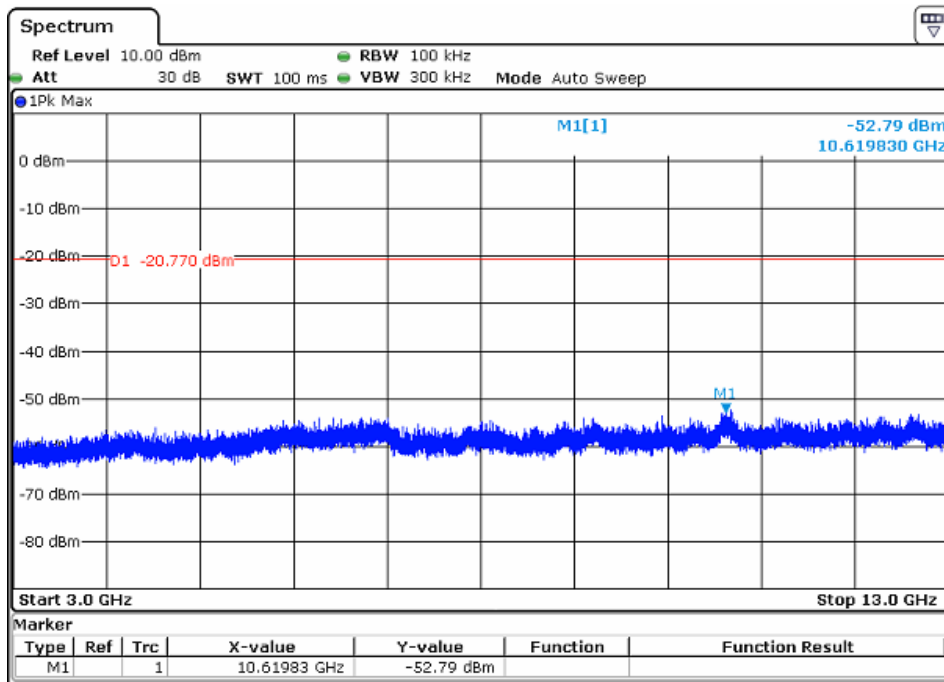

Note: Sweep Points=100000

CH78 Data rate 1Mbps

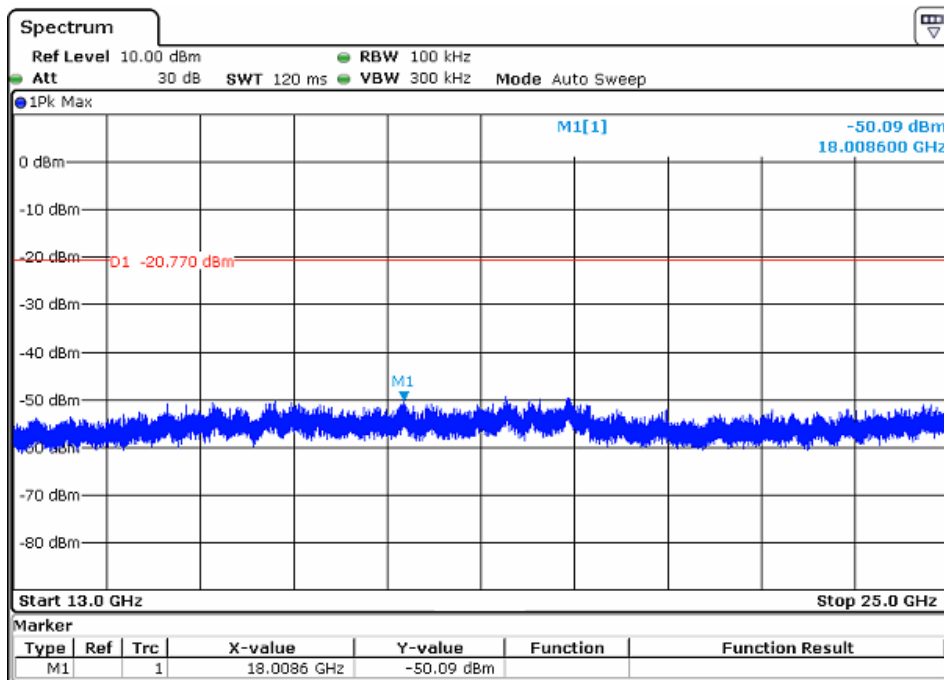

Note: Sweep Points=120000

CH00 Data rate 3Mbps

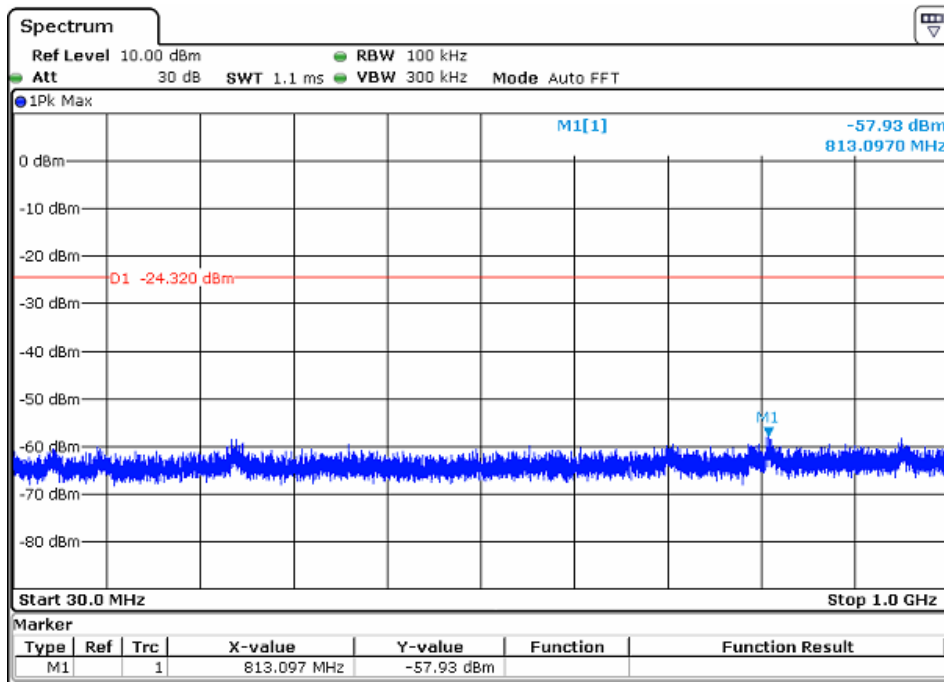

Note: Sweep Points=9700

CH00 Data rate 3Mbps

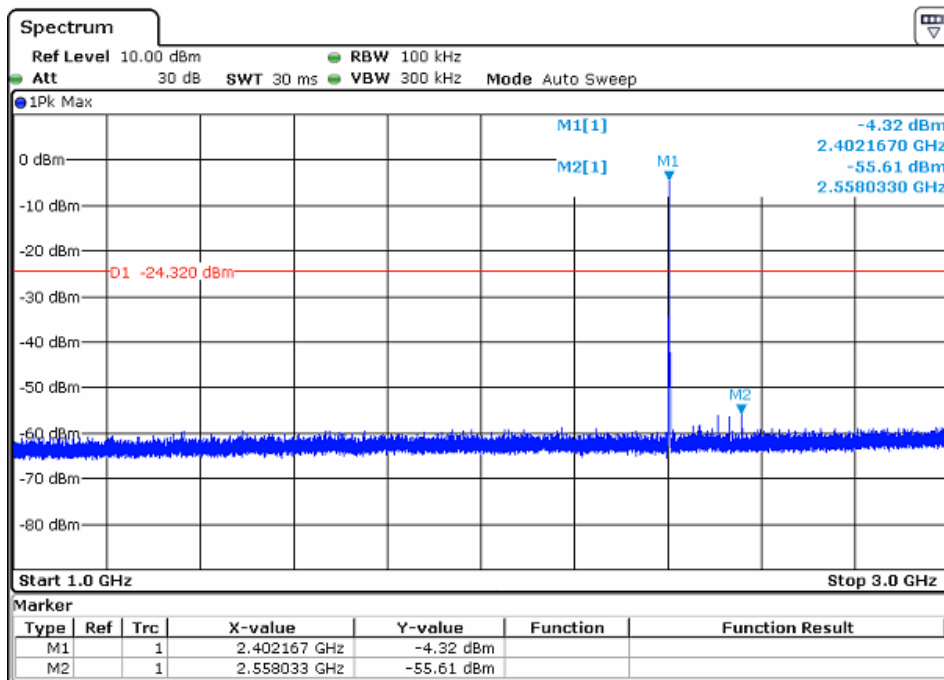

Note: Sweep Points=20000

CH00 Data rate 3Mbps

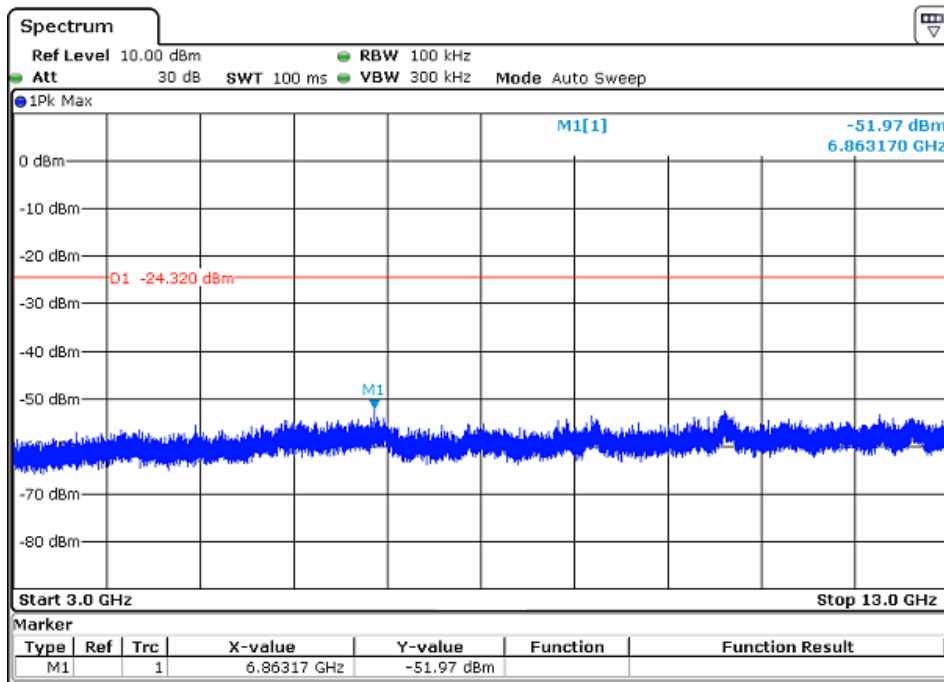

Note: Sweep Points=100000

CH00 Data rate 3Mbps

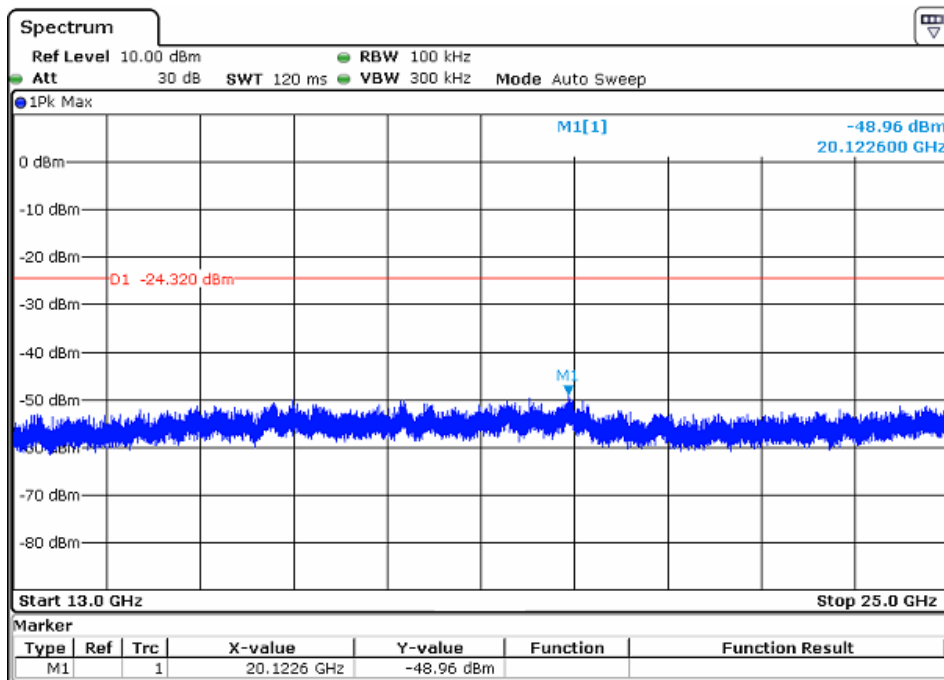

Note: Sweep Points=120000

CH39 Data rate 3Mbps

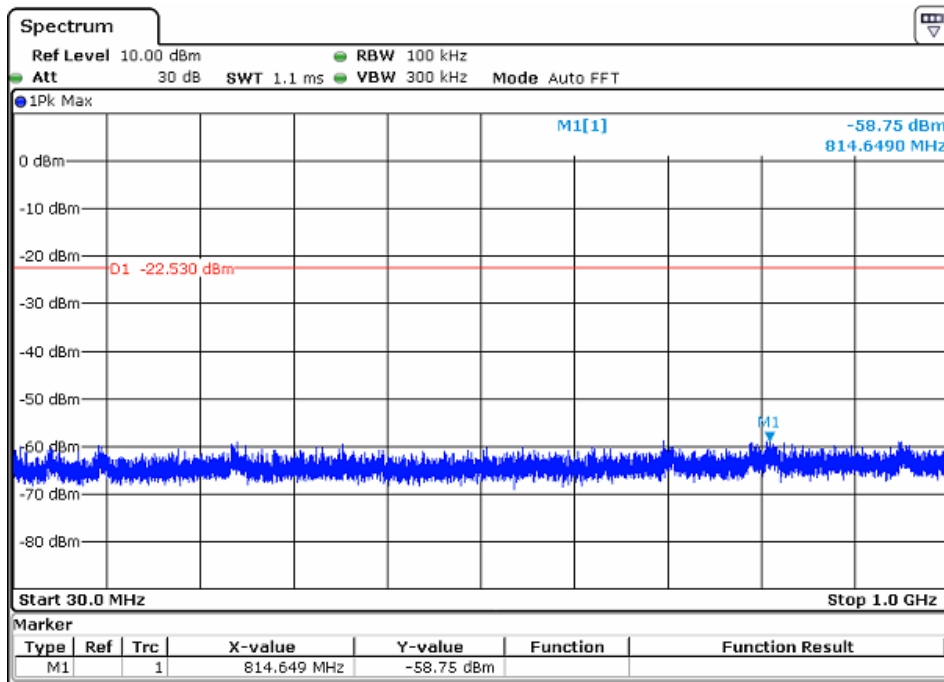

Note: Sweep Points=9700

CH39 Data rate 3Mbps

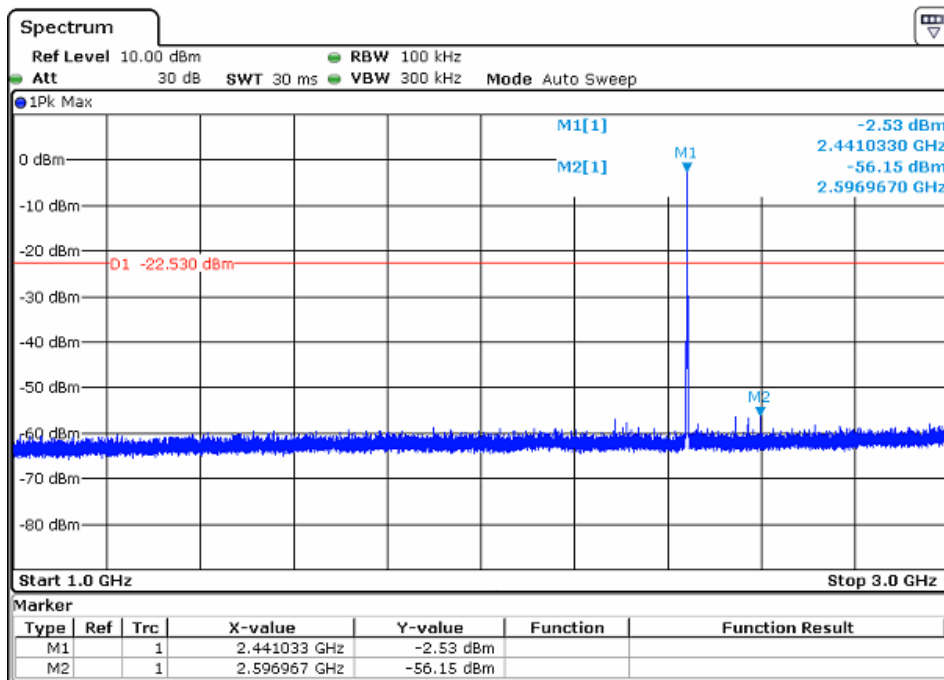

Note: Sweep Points=20000

CH39 Data rate 3Mbps

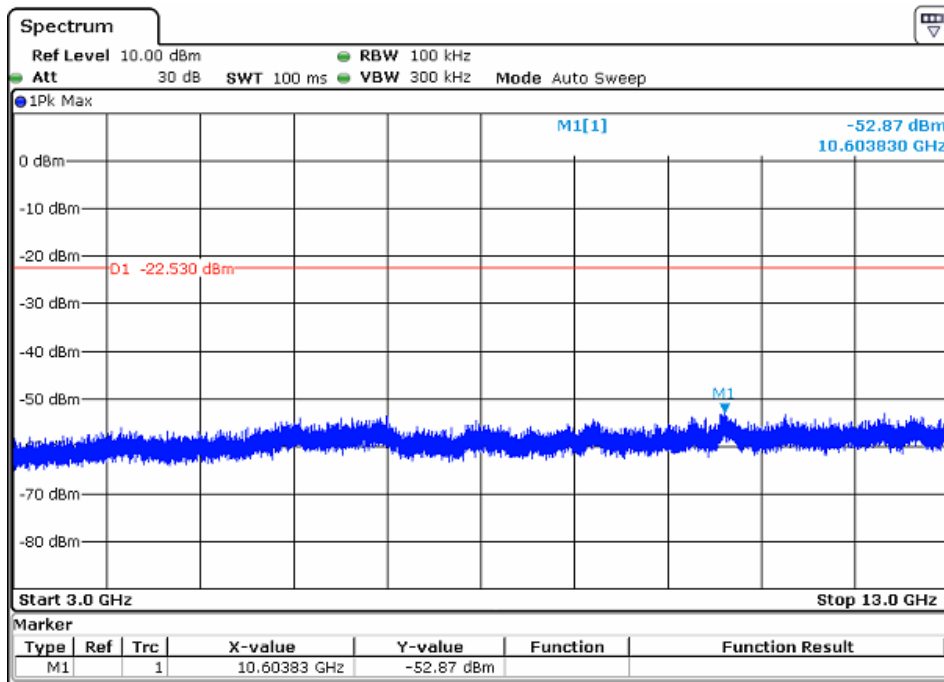

Note: Sweep Points=100000

CH39 Data rate 3Mbps

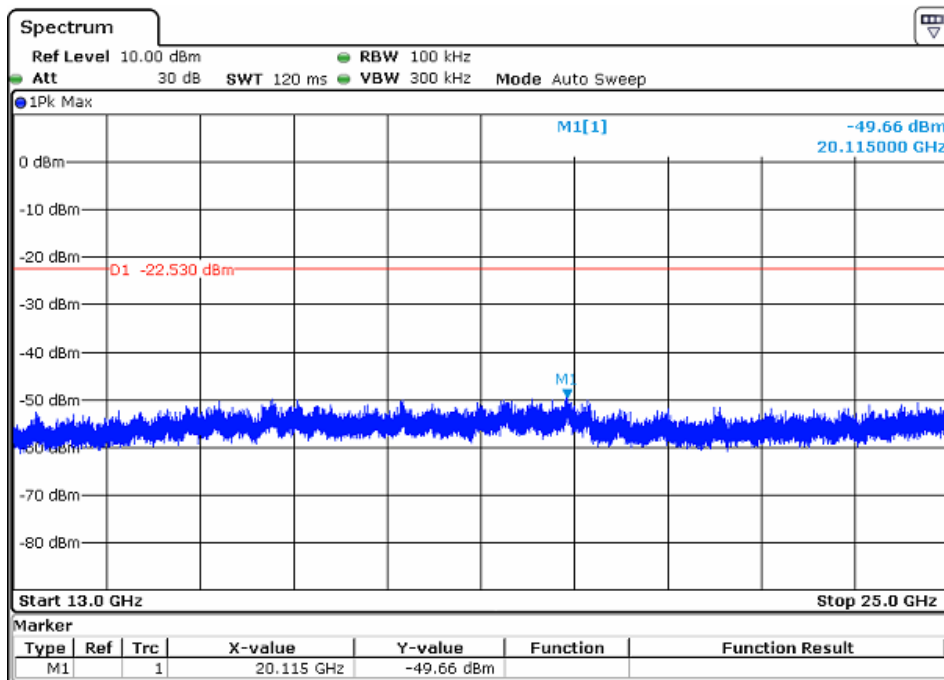

Note: Sweep Points=120000

CH78 Data rate 3Mbps

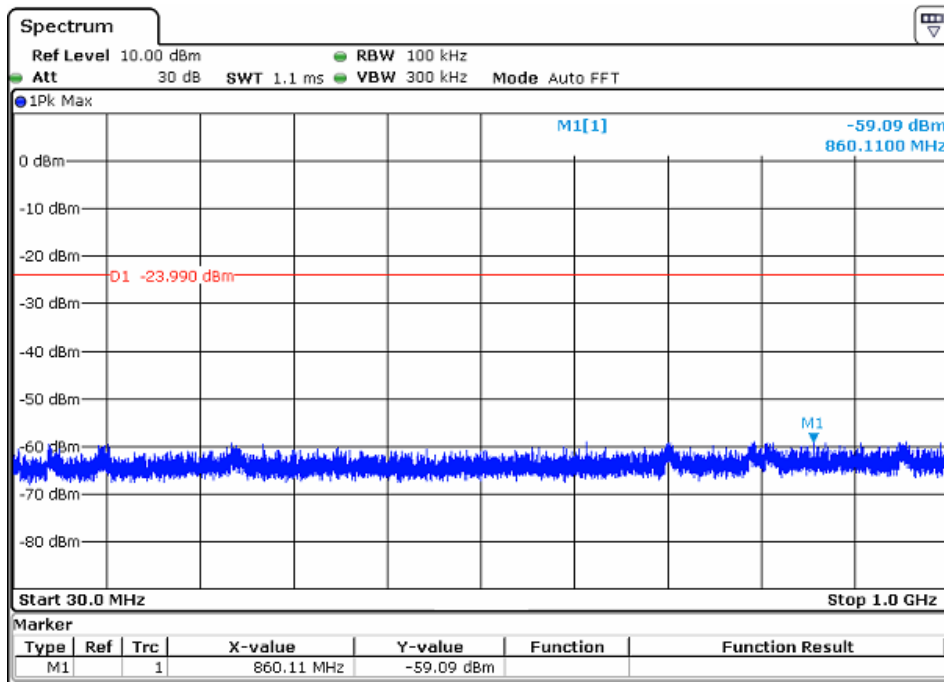

Note: Sweep Points=9700

CH78 Data rate 3Mbps

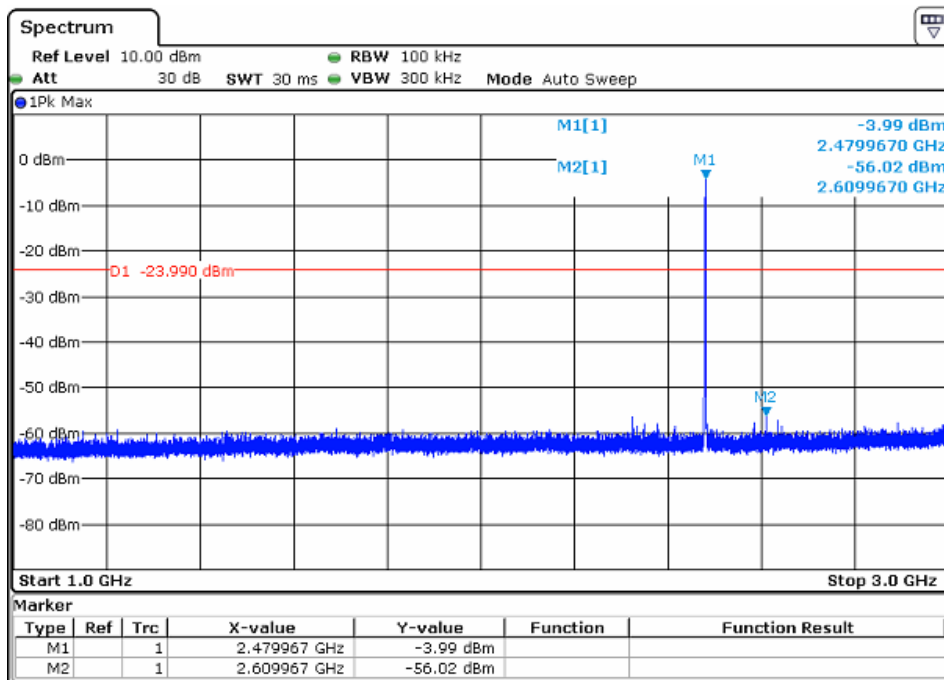

Note: Sweep Points=20000

CH78 Data rate 3Mbps

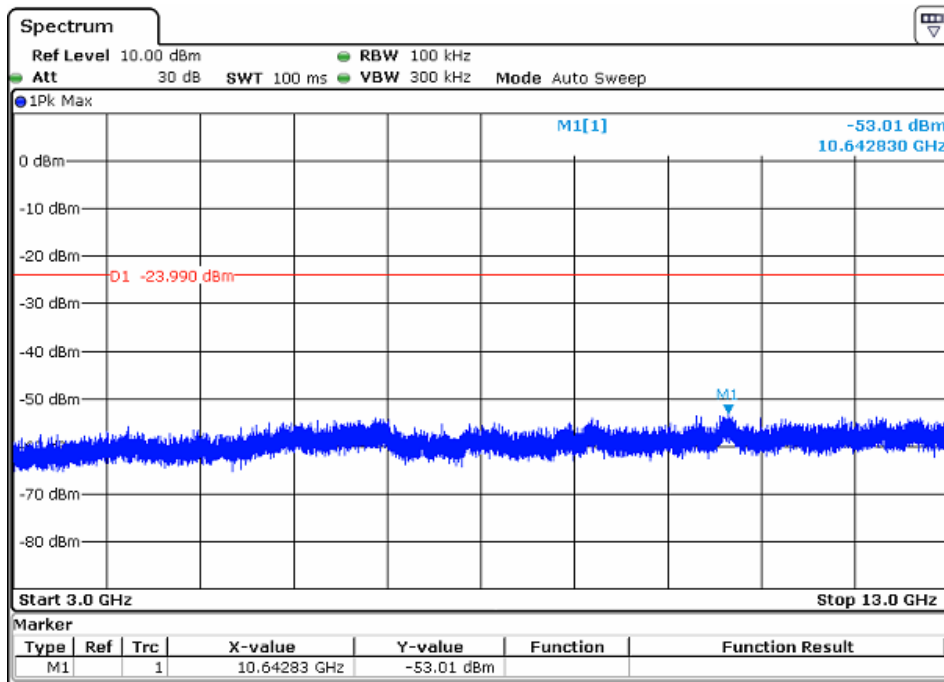

Note: Sweep Points=100000

CH78 Data rate 3Mbps

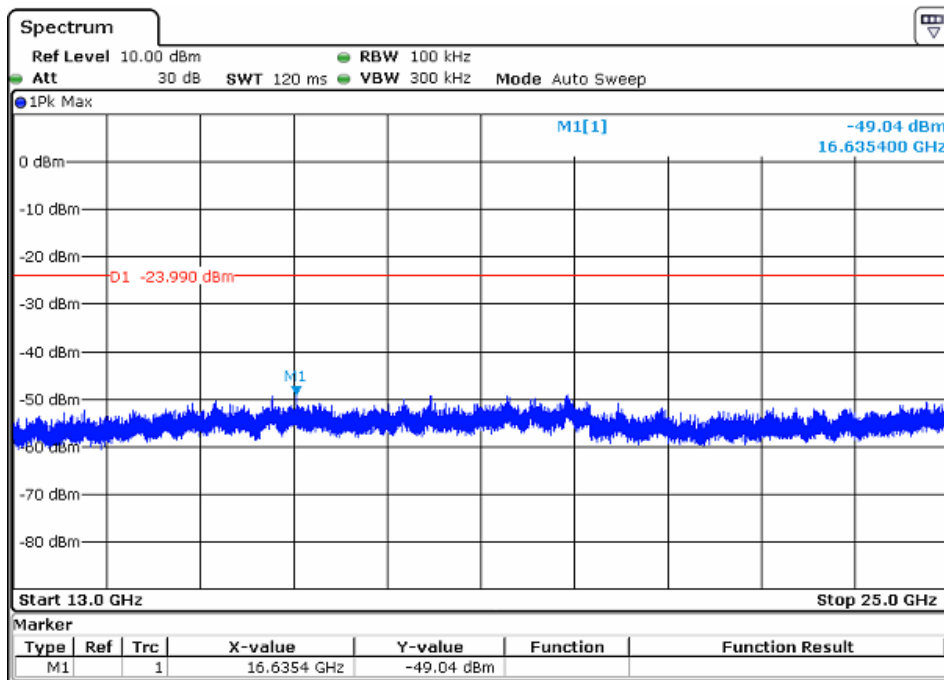

Note: Sweep Points=120000

6 Photographs

6.1 Radiated Spurious Emission Test Setup

Below 1GHz:

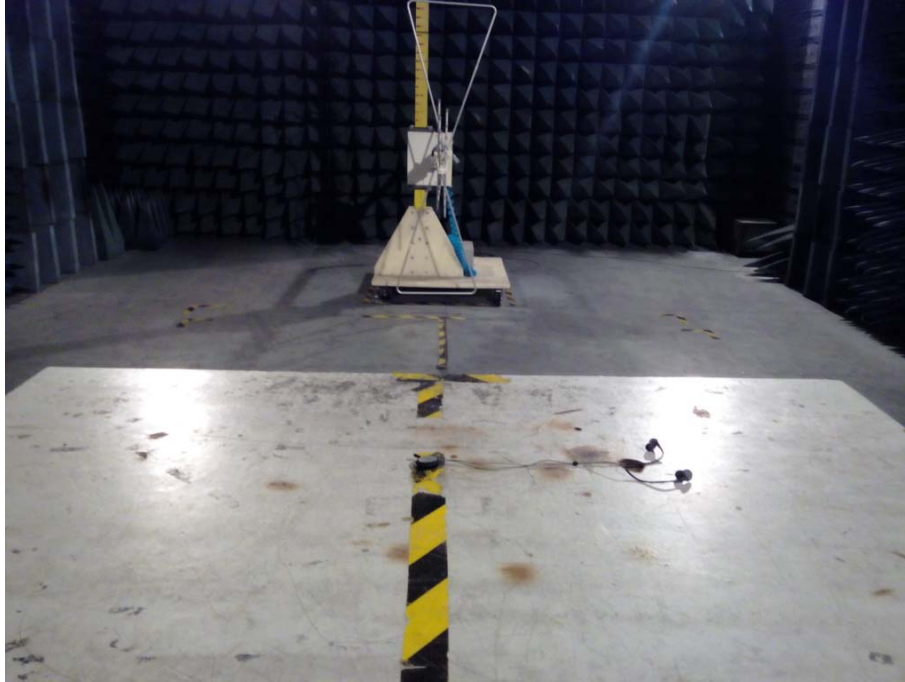

Above 1GHz:

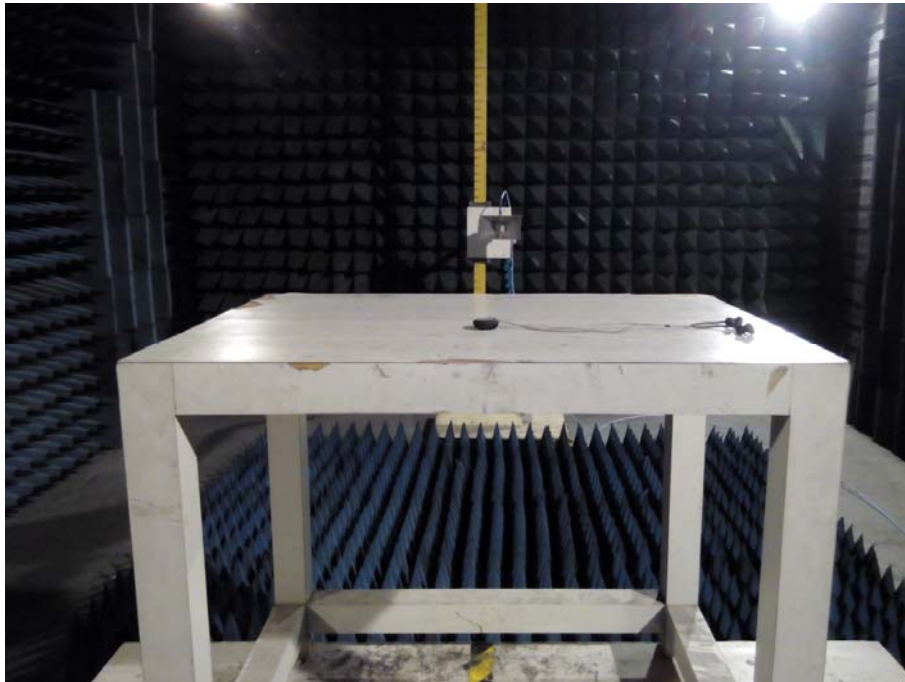

6.2 Conducted Emission Test Setup

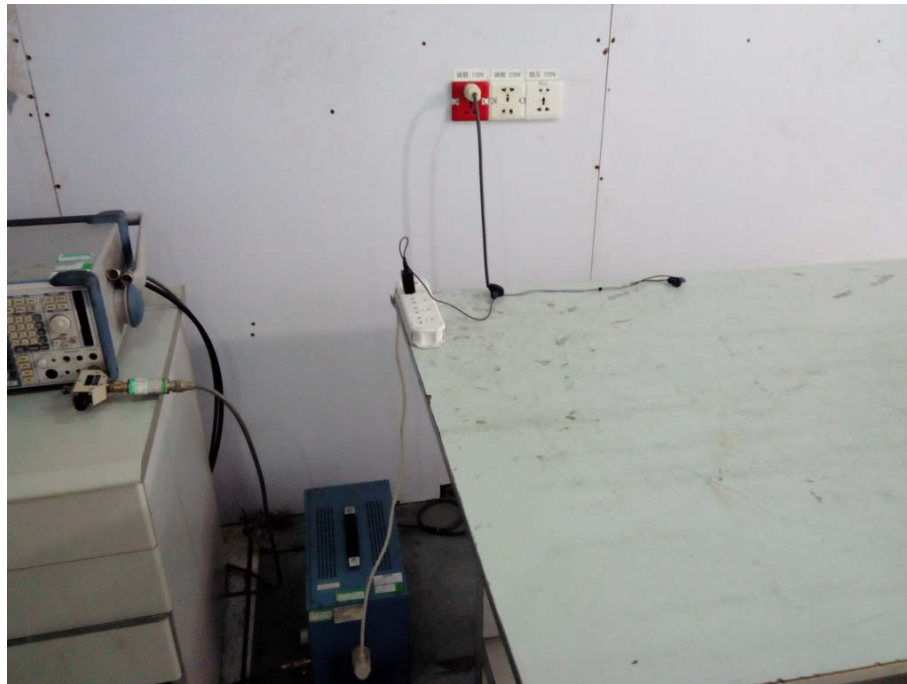

7 APPENDIX-Photographs of EUT Constructional Details



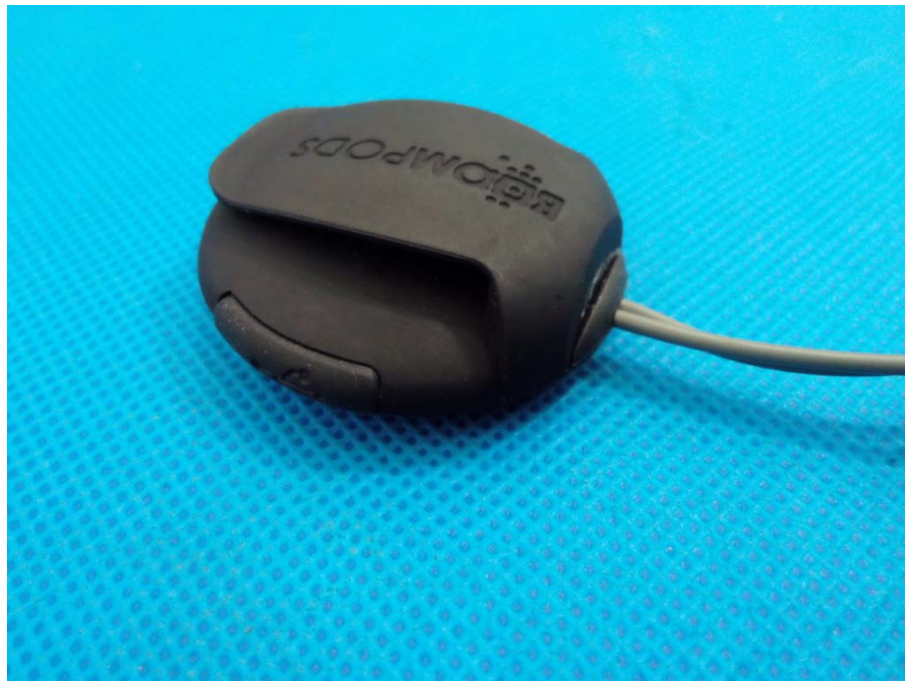
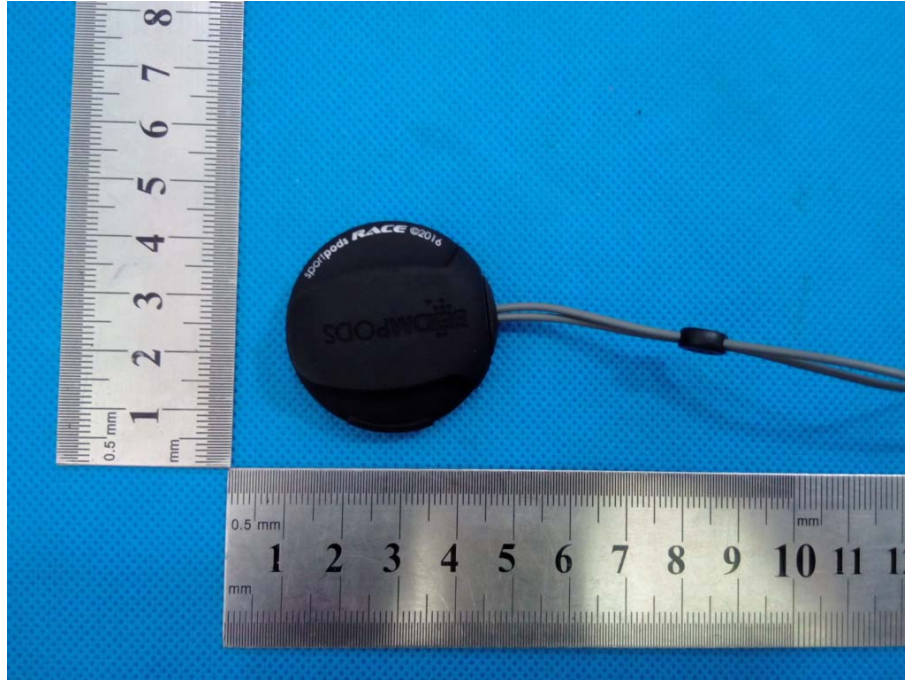

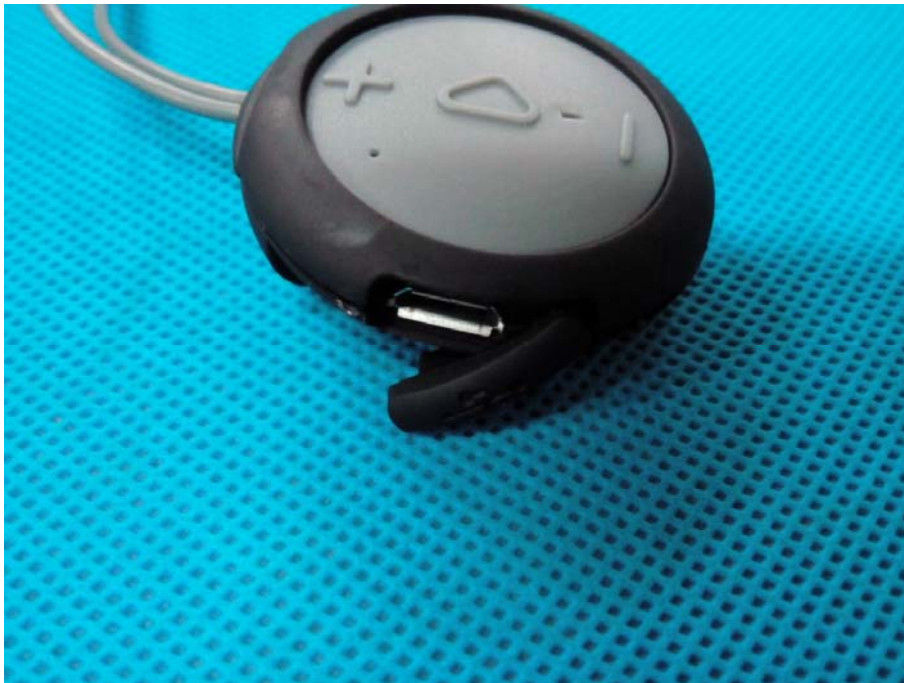

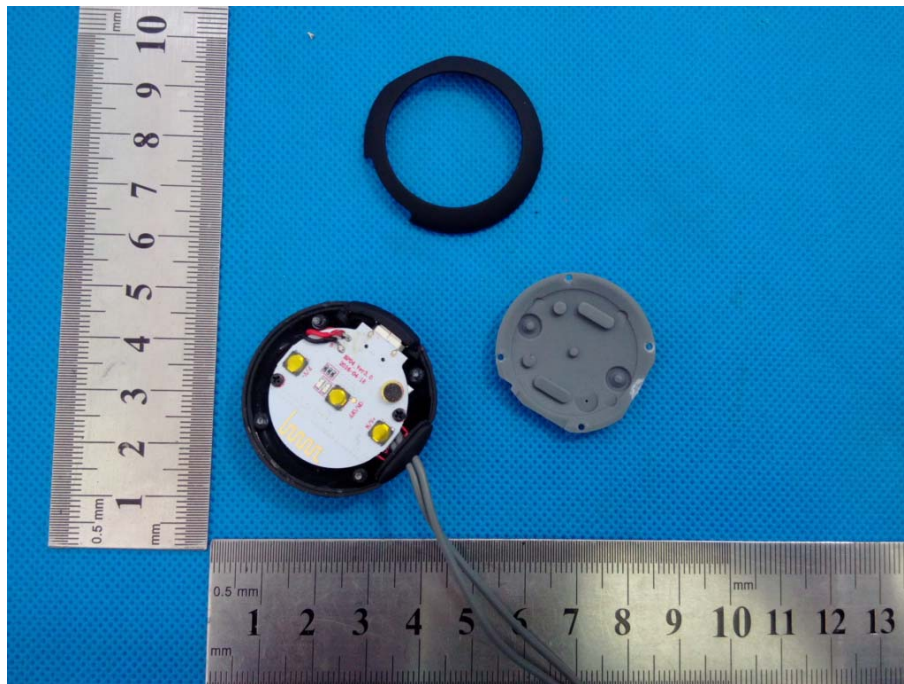

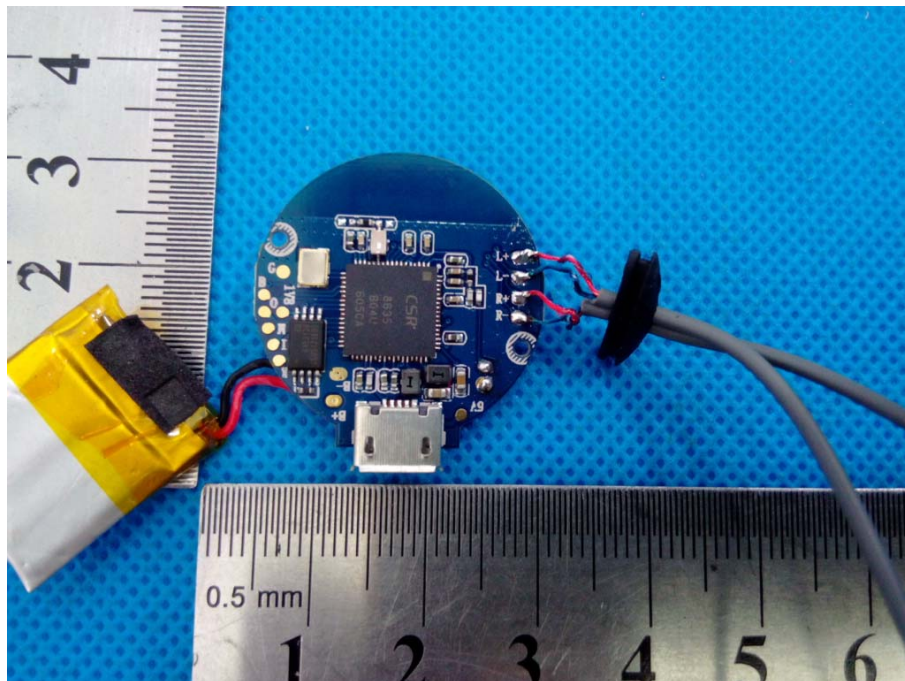
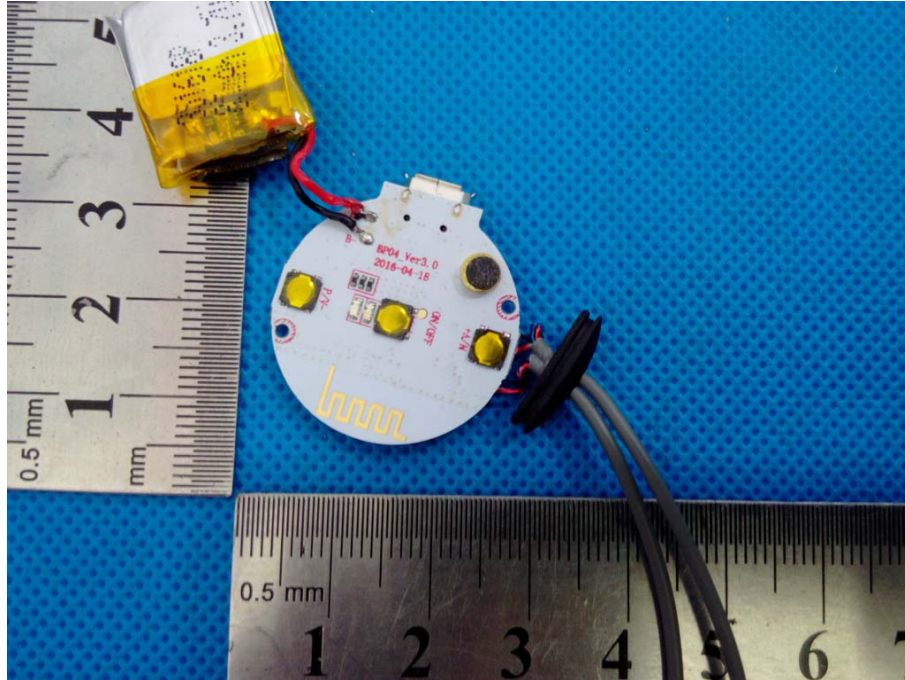

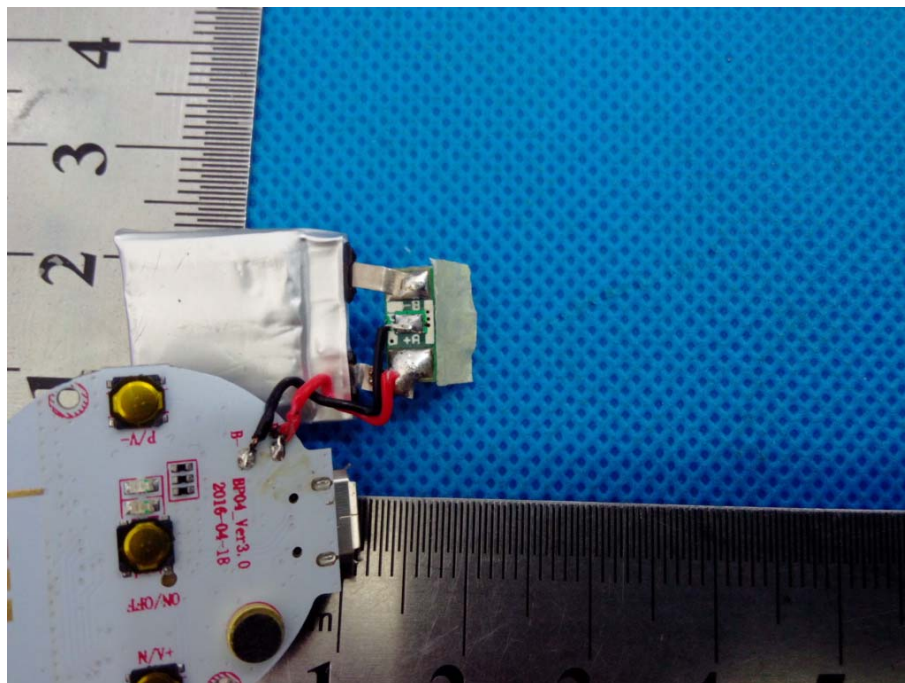
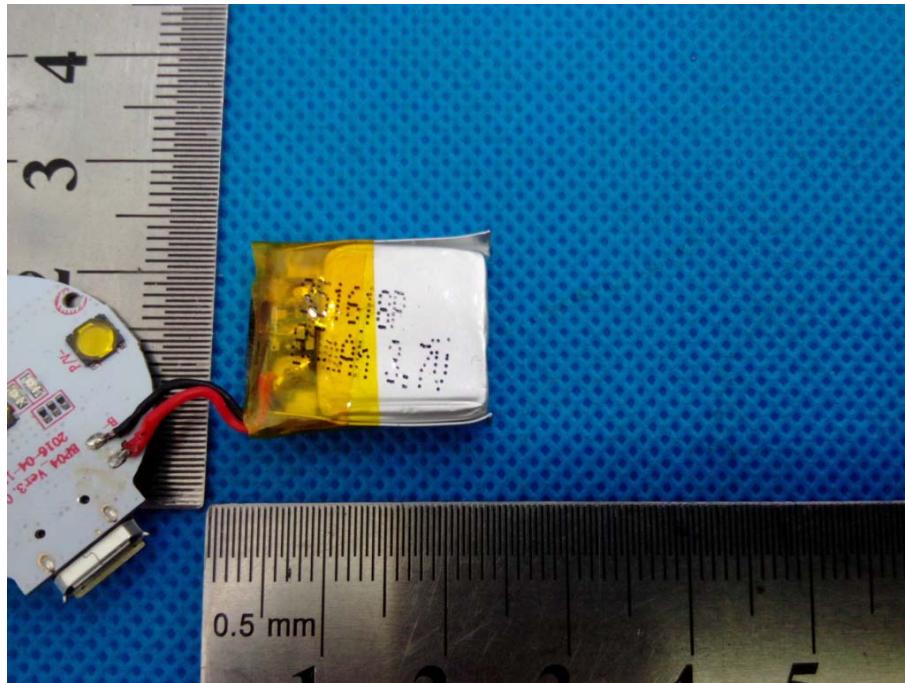

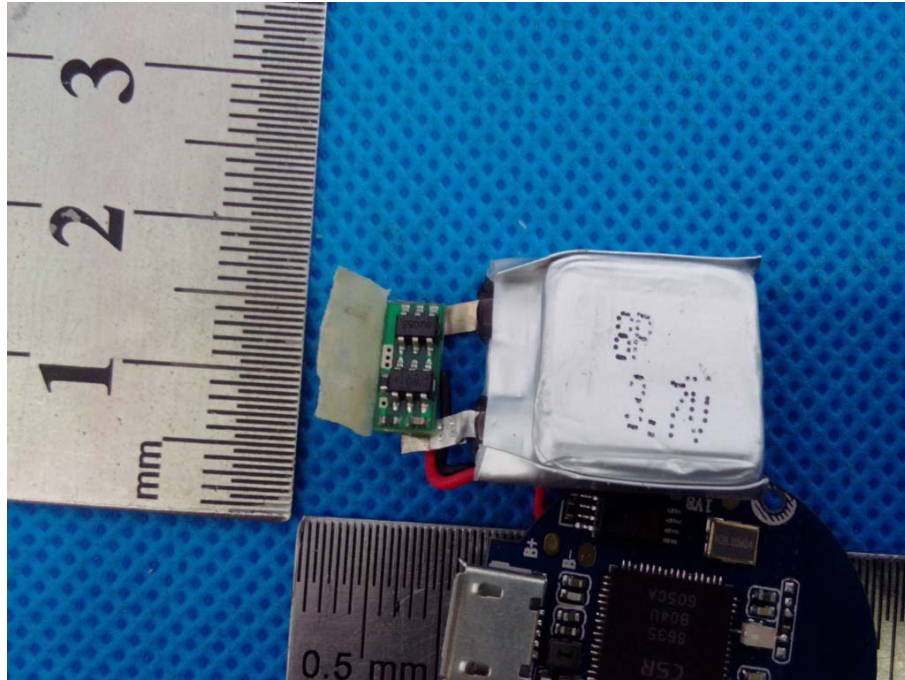

** End of report **