



**FCC 47 CFR PART 15 SUBPART C 15.247  
TEST REPORT  
FOR  
TWS BLUETOOTH EARBUDS**

Model : BOOMBUDS

Trade Name : N/A

Issued to  
BOOMPODS(HK) LTD.

RM 303-304 Hankow Centre 5-15,Hankow Road T.S.T. Kowloon,HONG KONG.

Issued by  
WH Technology Corp.



<b>Open Site</b>		<b>No.120, Ln. 5, Hudong St., Xizhi Dist., New Taipei City 221, Taiwan (R.O.C.)</b>
<b>EMC Test Site</b>	<b>Xizhi Office and Lab</b>	<b>7F., No.262, Sec. 3, Datong Rd., Xizhi Dist., New Taipei City 221, Taiwan (R.O.C.)</b>
<b>Tel.: +886-2-7729-7707 Fax: +886-2- 8648-1311</b>		
<b>Test Firm Registration: 749714</b>		

*Note: This test refers exclusively to the test presented test model and sample. This report shall not be reproduced except in full, without the written approval of WH Technology Corp. This document may be altered or revised by WH Technology Corp. Personnel only, and shall be noted in the revision section of the document.*



---

## Contents

<b>2.</b>	<b>Report of Measurements and Examinations</b> .....	<b>5</b>
2.1	List of Measurements and Examinations.....	5
<b>3.</b>	<b>Test Configuration of Equipment under Test</b> .....	<b>6</b>
3.1	Description of the tested samples.....	6
3.2	Carrier Frequency of Channels.....	7
3.3	Test Mode and Test Software.....	8
3.4	TEST Methodology & General Test Procedures.....	9
3.5	Measurement Uncertainty.....	10
3.6	Description of the Support Equipments.....	10
<b>4.</b>	<b>Test and measurement equipment</b> .....	<b>11</b>
4.1	calibration.....	11
4.2	equipment.....	11
<b>5.</b>	<b>Antenna Requirements</b> .....	<b>14</b>
5.1	Standard Applicable.....	14
5.2	Antenna Construction and Directional Gain.....	14
<b>6.</b>	<b>Test of Conducted Emission</b> .....	<b>15</b>
6.1	Test Limit.....	15
6.2	Test Procedures.....	15
6.3	Typical Test Setup.....	16
6.4	Test Result and Data.....	17
<b>7.</b>	<b>Test of Radiated Emission</b> .....	<b>19</b>
7.1	Test Limit.....	19
7.2	Test Procedures.....	19
7.3	Typical Test Setup.....	20
7.4	Test Result and Data (9kHz ~ 30MHz).....	22
7.5	Test Result and Data (30MHz ~ 1GHz, worst emissions found).....	22
7.6	Test Result and Data (Above 1GHz).....	24
7.7	Restrict Band Emission Measurement Data.....	33
<b>8.</b>	<b>Bandwidth Measurement Data</b> .....	<b>36</b>
8.1	Test Limit.....	36
8.2	Test Procedures.....	36
8.3	Test Setup Layout.....	36
8.4	Test Result and Data.....	37
<b>9.</b>	<b>Maximum Peak Output Power</b> .....	<b>42</b>
9.1	Test Limit.....	42
9.2	Test Procedures.....	42
9.3	Test Setup Layout.....	42



---

9.4	Test Result and Data .....	43
<b>10.</b>	<b>Carrier Frequency Separation .....</b>	<b>44</b>
10.1	Test Limit .....	44
10.2	Test Procedures .....	44
10.3	Test Setup Layout .....	44
10.4	Test Result and Data .....	45
<b>11.</b>	<b>Number Of Hopping Channel.....</b>	<b>51</b>
11.1	Test Limit .....	51
11.2	Test Procedure .....	51
11.3	Test Setup Layout .....	51
11.4	Test Result and Data .....	52
<b>12.</b>	<b>Dwell Time .....</b>	<b>53</b>
12.1	Test Limit .....	53
12.2	Test Procedure .....	53
12.3	Test Setup Layout .....	53
12.4	Test Result and Data .....	54
<b>13.</b>	<b>Band Edges Measurement .....</b>	<b>69</b>
13.1	Test Limit .....	69
13.2	Test Procedure .....	69
13.3	Test Setup Layout .....	69
13.4	Test Result and Data .....	70
<b>14.</b>	<b>Restricted Bands of Operation .....</b>	<b>76</b>
14.1	Labeling Requirement .....	76
<b>15.</b>	<b>Conducted Spurious Emissions.....</b>	<b>77</b>
15.1	Applied procedures / Limit.....	77
15.2	Test procedure .....	77
15.3	Deviation from standard .....	77
15.4	Test setup .....	77
15.5	Test results .....	78

**APPENDIX 1 PHOTOS OF TEST CONFIGURATION**

**PHOTOS OF EUT**



---

## 1. General Information

**Applicant** : BOOMPODS (HK) LTD.  
**Address** : RM 303-304 Hankow Centre 5-15,Hankow Road T.S.T. Kowloon,  
HONG KONG.  
**Manufacturer** : Shenzhen SZENXIN Technology CO., LTD  
**Address** : 4/F NO.42 building, Xicheng Industrial area, Bao'an  
district,Shenzhen,China.  
**EUT** : TWS BLUETOOTH EARBUDS  
**Model Name** : BOOMBUDS  
**Model Differences** : N/A

Is here with confirmed to comply with the requirements set out in the FCC Rules and Regulations Part 15 Subpart C and the measurement procedures were according to ANSI C63.10-2013. The said equipment in the configuration described in this report shows the maximum emission levels emanating

### FCC part 15 subpart C

Receipt Date : 06/26/2018

Final Test Date : 07/10/2018

**Tested By:**

**Reviewed by:**

Jul 12, 2018

**Date**

Bing Chang/ Engineer

Jul 12, 2018

**Date**

Bell Wei/ Manager  
Designation Number: TW2954



## 2. Report of Measurements and Examinations

### 2.1 List of Measurements and Examinations

FCC Rule	Description of Test	Result
Maximum Peak Output Power	FCC Part 15: 15.247(b)(1) RSS-247 5.4(2) & ANSI C63.10 :2013	Pass
Bandwidth	FCC Part 15: 15.215 RSS-247 5.1(2) & ANSI C63.10 :2013	Pass
Carrier Frequency Separation	FCC Part 15: 15.247(a)(1) RSS-247 5.1(2) & ANSI C63.10 :2013	Pass
Number Of Hopping Channel	FCC Part 15: 15.247(a)(1)(iii) RSS-247 5.1(4) & ANSI C63.10 :2013	Pass
Dwell Time	FCC Part 15: 15.247(a)(1)(iii) RSS-247 5.1(4) & ANSI C63.10 :2013	Pass
Radiated Emission	FCC Part 15: 15.209 FCC Part 15: 15.247(d) RSS-247 Section 5.5& ANSI C63.10 :2013	Pass
Band Edge Compliance	FCC Part 15: 15.247(d) RSS-247 Section 5.5& ANSI C63.10 :2013	Pass
Power Line Conducted Emissions	FCC Part 15: 15.207 IC RSS Gen, Section 7.2.4& ANSI C63.10 :2013	Pass
Antenna requirement	FCC Part 15: 15.203 &IC RSS Gen, Section 7.1.4	Pass



### 3. Test Configuration of Equipment under Test

#### 3.1 Description of the tested samples

EUT Name : TWS BLUETOOTH EARBUDS

Model Number : BOOMBUDS

FCC ID : 2AFAX-BOOMBUDS

Receipt Date : 06/26/2018

Power From : Inside Outside  
Adaptor Battery AC Power Source  
DC Power Source Support Unit PC or NB

Operate Frequency : Refer to the channel list as described below (2.402 ~2.480 GHz)

Hardware Version : V1.1

Software Version : V1.0

Modulation Technique : GFSK,  $\pi/4$ -DQPSK, 8DPSK

Bluetooth Version : V5.0 Without BLE mode

Number of Channels : 79

Channel spacing : N/A  1 MHz

Operating Mode : Simplex  Half Duplex

Antenna Type : Chip antenna

Antenna gain : 4.97 dBi



### 3.2 Carrier Frequency of Channels

Channel	Frequency (MHz)	Channel	Frequency (MHz)	Channel	Frequency (MHz)
00	2402	27	2429	54	2456
01	2403	28	2430	55	2457
02	2404	29	2431	56	2458
03	2405	30	2432	57	2459
04	2406	31	2433	58	2460
05	2407	32	2434	59	2461
06	2408	33	2435	60	2462
07	2409	34	2436	61	2463
08	2410	35	2437	62	2464
09	2411	36	2438	63	2465
10	2412	37	2439	64	2466
11	2413	38	2440	65	2467
12	2414	39	2441	66	2468
13	2415	40	2442	67	2469
14	2416	41	2443	68	2470
15	2417	42	2444	69	2471
16	2418	43	2445	70	2472
17	2419	44	2446	71	2473
18	2420	45	2447	72	2474
19	2421	46	2448	73	2475
20	2422	47	2449	74	2476
21	2423	48	2450	75	2477
22	2424	49	2451	76	2478
23	2425	50	2452	77	2479
24	2426	51	2453	78	2480
25	2427	52	2454	--	--
26	2428	53	2455	--	--



### **3.3 Test Mode and Test Software**

- a. During testing, the interface cables and equipment positions were varied according to ANSI C63.10.
- b. The complete test system included Notebook and EUT for RF test.
- c. Test Software: Radio Test.exe
- d. New Battery was used for all testing and the worst radiated emission case from X,Y and Z axis evaluation was selected for testing.
- e. For battery operated equipment, the equipment tests shall be performed using a new battery.
- f. The following test modes were performed for test:
  - BT: CH00: 2402MHz, CH39: 2441MHz, CH78: 2480MHz





### **3.4 TEST Methodology & General Test Procedures**

All testing as described bellowed were performed in accordance with ANSI C63.10:2013.

#### **Conducted Emissions**

The EUT is placed on a wood table, which is at 0.8 m above ground plane acceding to clause 15.207 and requirements of ANSI C63.10:2013. Conducted emissions from the EUT measured in the frequency range between 0.15 MHz and 30MHz are using CISPR Quasi-Peak / Average detectors.

#### **Radiated Emissions**

The EUT is a placed on a turn table, which is 0.8 m or 1.5m above ground plane. The turntable was rotated through 360 degrees to determine the position of maximum emission level. The EUT is placed at 3m away from the receiving antenna, which varied from 1m to 4m to find out the highest emission. Each emission was to be maximized by changing the polarization of receiving antenna both horizontal and vertical.

- 1) Putting the EUT on the platform and turning on the EUT (on/off button on the bottom of the EUT).
- 2) Setting test channel described as “Channel setting and operating condition”, and testing channel by channel.
- 3) For the maximum output power measurement, we followed the method of measurement KDB558074 D01 v03r5.
- 4) For the spurious emission test based on ANSI C63.10-2013, at the frequency where below 1GHz used quasi-peak detector mode; where above 1GHz used the peak and average detector mode. IF the peak value may be under average limit, the average mode will not be performed.



### 3.5 Measurement Uncertainty

Measurement Item	Uncertainty
Peak Output Power(conducted)	±1.345dB
Power Spectral Density	±1.347dB
Radiated emission(1G-25GHz)	±5.00dB
Radiated emission(0.009M-1GHz)	±3.89dB
Conducted emission	±1.81dB

### 3.6 Description of the Support Equipments

#### Setup Diagram

See test photographs attached in appendix 1 for the actual connections between EUT and support equipment.

#### Support Equipment

Peripherals Devices:

OUTSIDE SUPPORT EQUIPMENT							
No.	Equipment	Model	Serial No.	FCC ID/ BSMI ID	Trade name	Data Cable	Power Cord
1.	Lap top	7457	7457A82	DOC	lenovo	N/A	N/A
2.	AC adapter	QX6.5W7510 0FG	N/A	VOC	Stos	N/A	N/A
INSIDE SUPPORT EQUIPMENT							
No.	Equipment	Model	Serial No.	FCC ID/ BSMI ID	Trade name	Data Cable	Power Cord
1.	N/A	N/A	N/A	N/A	N/A	N/A	N/A

**Note:** All the above equipment /cable were placed in worse case position to maximize emission signals during emission test

**Grounding:** Grounding was in accordance with the manufacturer's requirement and conditions for the intended use.



## **4. Test and measurement equipment**

### **4.1 calibration**

The measuring equipment utilized to perform the tests documented in the report has been calibrated once a year or in accordance with the manufacturer's recommendations, and is traceable to recognized national standards.

### **4.2 equipment**

The following list contains measurement equipment used for testing. The equipment conforms to the requirement of CISPR 16-1, ANSI C63.10 and other required standards.

Calibration of all test and measurement, including any accessories that may effect such calibration, is checked frequently to ensure the accuracy. Adjustments are made and correction factors are applied in accordance with the instructions contained in the respective.



**TABLELIST OF TEST AND MEASUREMENT EQUIPMENT**

Test Site	Instrument	Manufacturer	Model No.	S/N	Next Cal. Date
Conduction	Spectrum (9K--3GHz)	R&S	FSP3	833387/010	2018/09/20
	EMI Receiver	R&S	ESHS10	830223/008	2019/05/22
	LISN	Rolf Heine Hochfrequenztechnik	NNB-2/16z	98062	2019/05/25
	ISN	Schwarzbeck	8-Wire ISN CAT5	CAT5-8158-0094	2018/09/21
	RF Cable	N/A	N/A	EMI-3	2018/10/19
Radiation	Bilog antenna(30M-1G)	ETC	MCTD2786B	BLB16M04004/J B-5-004	2019/05/03
	Double Ridged Guide Horn antenna(1G-18G)	ETC	MCTD 1209	DRH15N0 2009	2018/11/23
	Horn antenna (18G-26G)	com-power	AH-826	81000	2018/08/15
	LOOP Antenna (Below 30M)	com-power	AL-130	17117	2018/10/04
	Pre amplifier (30M-1G)	EMC INSTRUMENT	EMC9135	980334	2019/05/04
	Microwave Preamplifier (1G-18G)	EMC INSTRUMENT	EMC051845	980108&AT -18001	2018/10/23
	Pre amplifier (18G~26G)	MITEQ	JS4-18002600-3 0-5A	808329	2018/08/10
	EMI Test	R&S	ESVS30	826006/002	2018/11/28



---

	Receiver		(20M-1000MHz)		
	RF Cable (open site)	EMCI	N male on end of both sides (EMI4)	30m	2018/10/19
	RF CABLE (1~26.5G)	HARBOUR INDUSTRIES	LL142MI(4M+4M)	NA	2019/03/08
	RF CABLE (1~26.5G)	HARBOUR INDUSTRIES	LL142MI(7M)	NA	2018/08/11
	Spectrum (9K--7GHz)	R&S	FSP7	830180/006	2019/03/25
	Spectrum (9K--40GHz)	AGILENT	8564EC	4046A0032	2019/03/01
Software	e3	AUDIX	N/A	N/A	N/A

**\*CALIBRATION INTERVAL OF INSTRUMENTS LISTED ABOVE IS ONE YEAR**



## **5. Antenna Requirements**

### **5.1 Standard Applicable**

For intentional device, according to FCC 47 CFR Section 15.203, an intentional radiator shall be designed to ensure that no antenna other than that furnished by the responsible party shall be used with the device.

And according to FCC 47 CFR Section 15.247 (b), if transmitting antennas of directional gain greater than 6dBi are used, the power shall be reduced by the amount in dB that the directional gain of the antenna exceeds 6dBi.

### **5.2 Antenna Construction and Directional Gain**

Antenna Type: Chip Antenna

Antenna Gain: 4.97 dBi



## 6. Test of Conducted Emission

### 6.1 Test Limit

Conducted Emissions were measured from 150 kHz to 30 MHz with a bandwidth of 9 KHz on the 110 VAC power and return leads of the EUT according to the methods defined in ANSI C63.10-2013 Section 3.1. The EUT was placed on a nonmetallic stand in a shielded room 0.8 meters above the ground plane as shown in section 2.2. The interface cables and equipment positioning were varied within limits of reasonable applications to determine the position produced maximum conducted emissions.

Frequency (MHz)	Quasi Peak (dB $\mu$ V)	Average (dB $\mu$ V)
0.15 – 0.5	66-56*	56-46*
0.5 – 5.0	56	46
5.0 – 30.0	60	50

\*Decreases with the logarithm of the frequency.

### 6.2 Test Procedures

- a. The EUT was placed 0.4 meter from the conducting wall of the shielding room was kept at least 80 centimeters from any other grounded conducting surface.
- b. Connect EUT to the power mains through a line impedance stabilization network (LISN).
- c. All the support units are connecting to the other LISN.
- d. The LISN provides 50 ohm coupling impedance for the measuring instrument.
- e. The FCC states that a 50 ohm, 50 micro-Henry LISN should be used.
- f. Both sides of AC line were checked for maximum conducted interference.
- g. The frequency range from 150 kHz to 30 MHz was searched.
- h. Set the test-receiver system to Peak Detect Function and Specified Bandwidth with Maximum Hold Mode.



### 6.3 Typical Test Setup

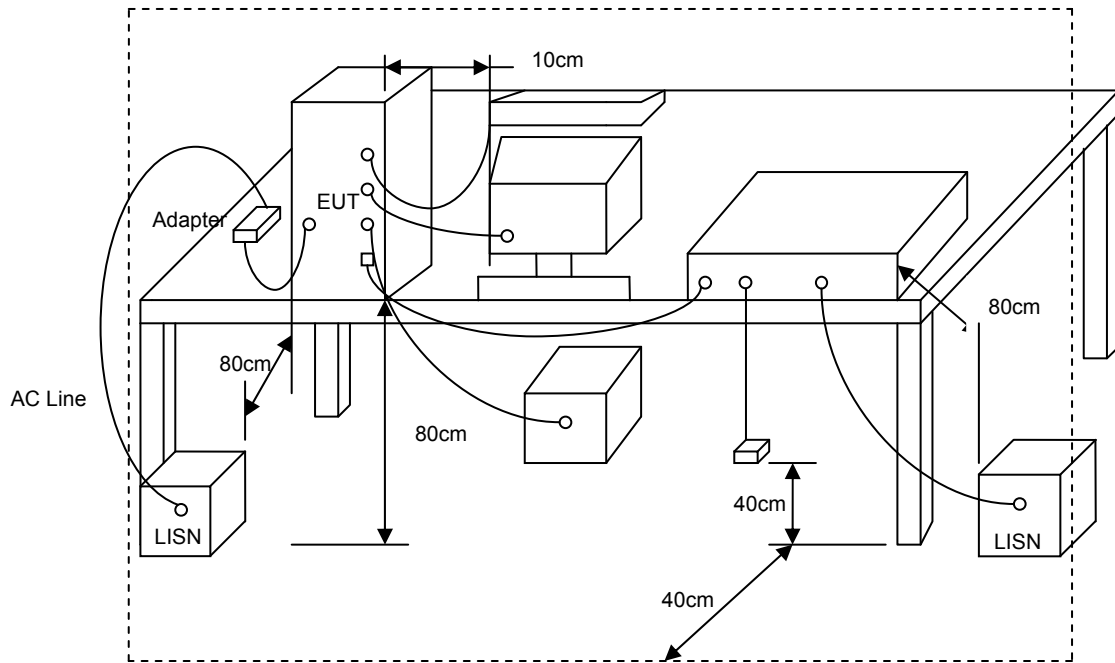





## 6.4 Test Result and Data

Power	: AC 120V/60Hz	Pol/Phase	: LINE
Test Mode	: TX (GFSK) CH79 (worst case)	Temperature	: 24.6 °C
Memo	:	Humidity	: 57 %

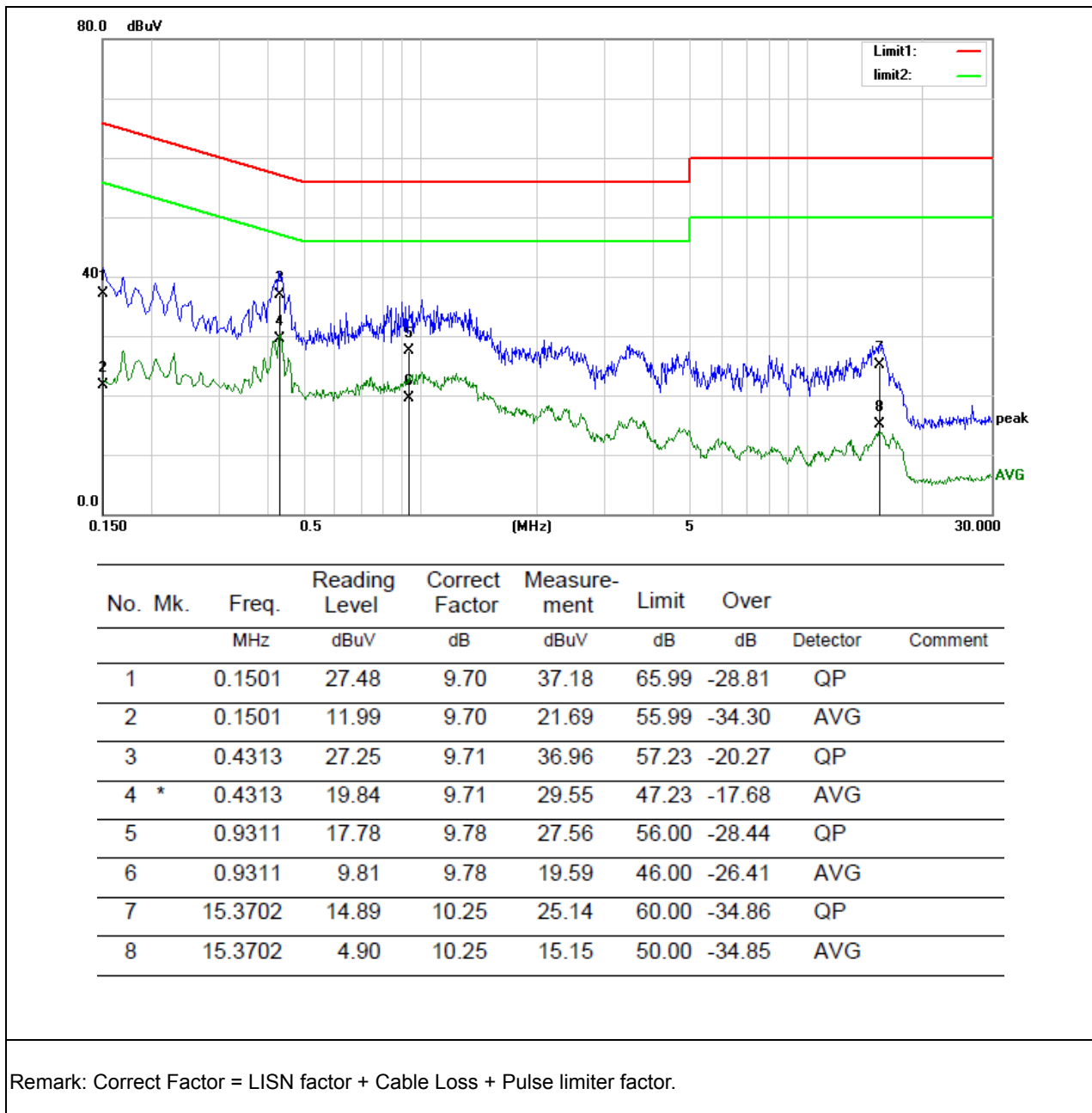



Power	: AC 120V/60Hz	Pol/Phase	: NEUTRAL
Test Mode	: TX (GFSK) CH79 (worst case)	Temperature	: 24.6 °C
Memo	:	Humidity	: 57 %

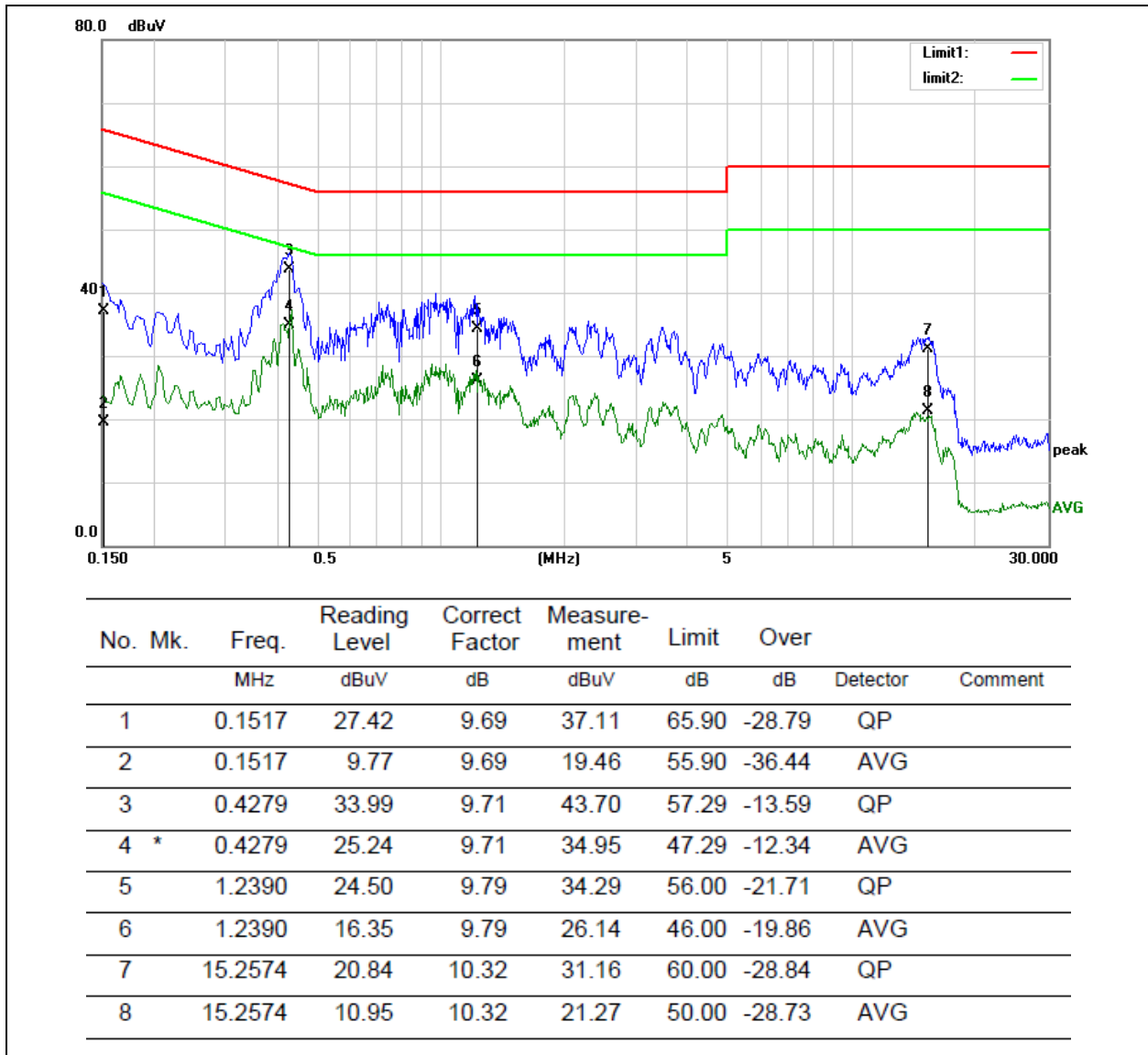

Remark: Correct Factor = LISN factor + Cable Loss + Pulse limiter factor.



## 7. Test of Radiated Emission

### 7.1 Test Limit

In any 100kHz bandwidth outside the frequency band in which the spread spectrum or digitally modulated intentional radiator is operating, the radio frequency power that is produced by the intentional radiator shall be at least 20dB below that in the 100kHz bandwidth within the band that contains the highest level of the desired power, based on either an RF conducted or a radiated measurement. If the transmitter measurement is based on the maximum conducted output power, the attenuation required under this paragraph shall be 30dB instead of 20dB. In addition, radiated emissions which fall in section 15.205(a) the restricted bands must also comply with the radiated emission limit specified in section 15.209(a).

Frequency (MHz)	Field Strength (microvolt/meter)	Measurement Distance (meters)
0.009 ~ 0.490	2400/F(kHz)	300
0.490 ~ 1.705	24000/F(kHz)	30
1.705 ~ 30.0	30	30
30 ~ 88	100	3
88 ~ 216	150	3
216 ~ 960	200	3
Above 960	500	3

### 7.2 Test Procedures

- The EUT was placed on a rotatable table top 0.8 meter above ground.
- The EUT was set 3 meters from the interference receiving antenna which was mounted on the top of a variable height antenna tower.
- The table was rotated 360 degrees to determine the position of the highest radiation.
- The antenna is a broadband antenna and its height is varied between one meter and four meters above ground to find the maximum value of the field strength both horizontal polarization and vertical polarization of the antenna are set to make the measurement.
- For each suspected emission the EUT was arranged to its worst case and then tune the antenna tower (from 1 M to 4 M) and turn table (from 0 degree to 360 degrees) to find the maximum reading.
- Set the test-receiver system to Peak or CISPR quasi-peak Detect Function and specified bandwidth with Maximum Hold Mode.
- If the emission level of the EUT in peak mode was 3 dB lower than the limit specified, then testing will be stopped and peak values of EUT will be reported, otherwise, the emissions which do not have 3 dB margin will be repeated one by one using the quasi-peak method and reported.
- For testing above 1GHz, the emission level of the EUT in peak mode was 20dB lower than



average limit (that means the emission level in peak mode also complies with the limit in average mode), then testing will be stopped and peak values of EUT will be reported, otherwise, the emissions will be measured in average mode again and reported.

- i. "Cone of radiation" has been considered to be 3dB bandwidth of the measurement antenna.

### 7.3 Typical Test Setup

For radiated emissions below 30MHz

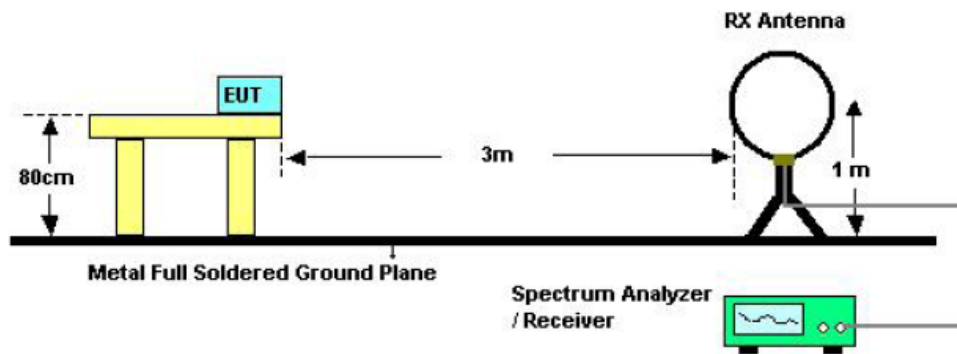

For radiated emissions above 30MHz

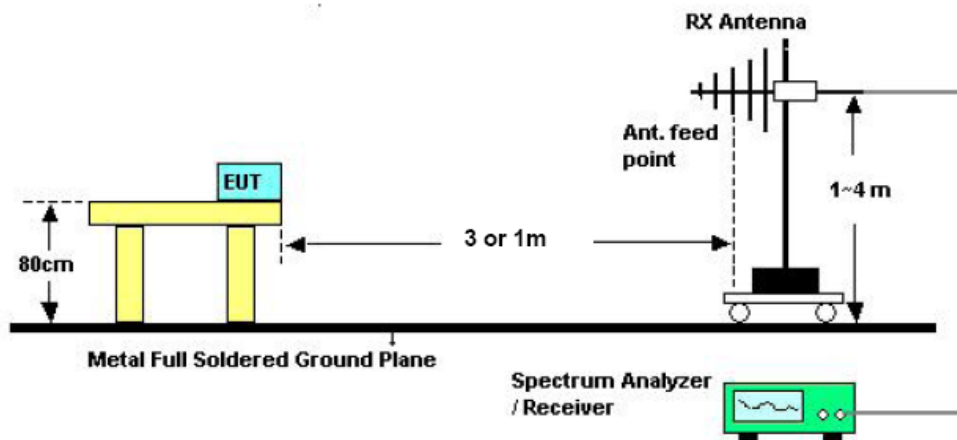



For radiated emissions frequency above 1GHz

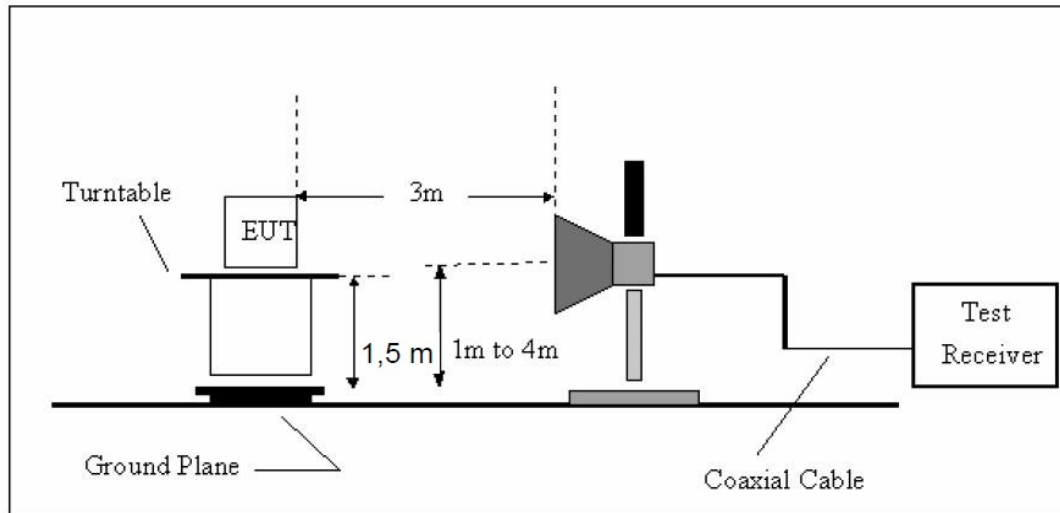

Above 10 GHz shall be extrapolated to the specified distance using an extrapolation factor of 20 dB/decade from 3m to 1m.

Distance extrapolation factor =  $20 \log (\text{specific distance [3m]} / \text{test distance [1m]})$  (dB);

Limit line = specific limits (dBuV) + distance extrapolation factor [9.54 dB].



## 7.4 Test Result and Data (9kHz ~ 30MHz)

The 9kHz - 30MHz spurious emission is under limit 20dB more.

## 7.5 Test Result and Data (30MHz ~ 1GHz, worst emissions found)

Power	: DC 3.7V	Pol/Phase	: HORIZONTAL
Test Mode	: TX (GFSK) CH00 (worst case)	Temperature	: 24 °C
Memo	:	Humidity	: 59%

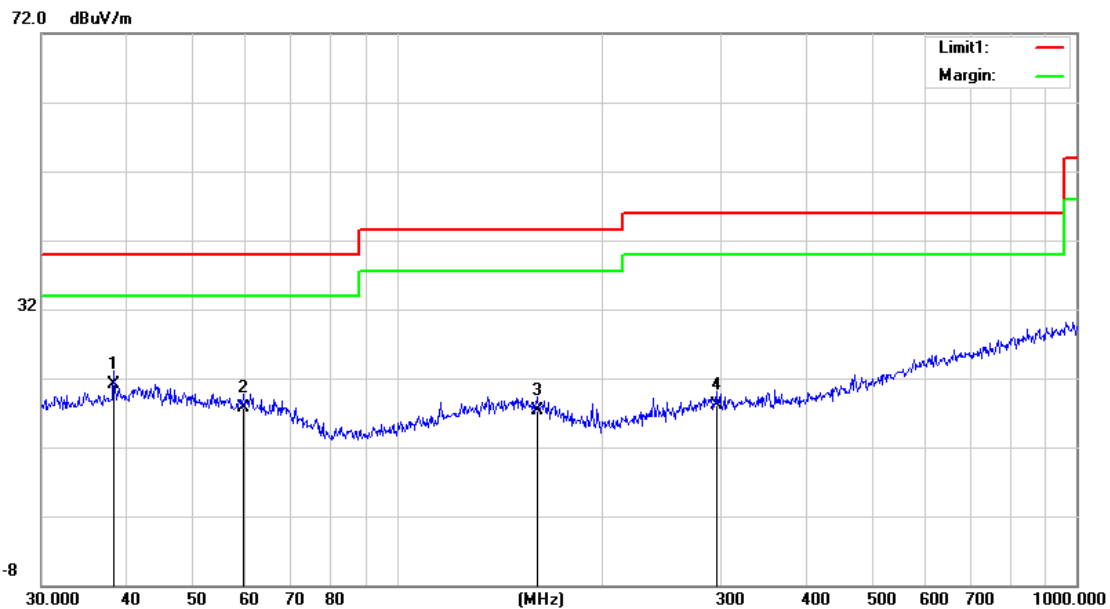

No.	Mk.	Freq.	Reading Level	Correct Factor	Measurement	Limit	Over	Detector	Comment
		MHz	dBuV	dB	dBuV/m	dB/m	dB		
1	*	38.3462	5.83	15.27	21.10	40.00	-18.90	QP	
2		59.4405	3.71	13.96	17.67	40.00	-22.33	QP	
3		160.9089	2.70	14.61	17.31	43.50	-26.19	QP	
4		295.1469	3.37	14.83	18.20	46.00	-27.80	QP	



Power	: DC 3.7V	Pol/Phase	: VERTICAL
Test Mode	: TX (GFSK) CH00 (worst case)	Temperature	: 24 °C
Memo	:	Humidity	: 59%

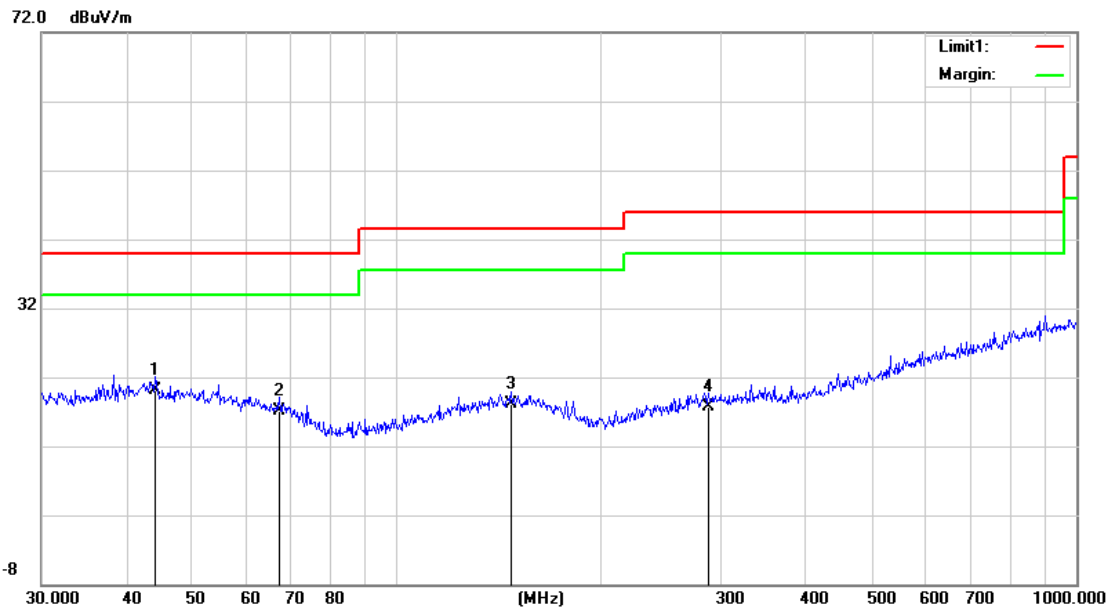

No.	Mk.	Freq.	Reading Level	Correct Factor	Measurement	Limit	Over	Detector	Comment
		MHz	dBuV	dB	dBuV/m	dB/m	dB		
1	*	44.1202	4.85	15.29	20.14	40.00	-19.86	QP	
2		67.2022	3.98	13.11	17.09	40.00	-22.91	QP	
3		147.4036	3.57	14.45	18.02	43.50	-25.48	QP	
4		286.9823	3.05	14.70	17.75	46.00	-28.25	QP	



## 7.6 Test Result and Data (Above 1GHz)

Power	: DC 3.7V	Pol/Phase	: H/V
Test Mode	: TX CH00 GFSK	Temperature	: 24 °C
Memo	:	Humidity	: 59 %

### (a) Antenna polarization: Horizontal

Frequency (MHz)	Reading Level (dBuV)	Correct Factor (dB)	Measure Level (dBuV/m)	Limit (dBuV/m)	Over (dB)	Detector Type
4804.00	62.94	-6.06	56.88	74.00	-17.12	peak
4804.00	50.55	-6.06	44.49	54.00	-9.51	AVG
7206.00	45.64	0.18	45.82	74.00	-28.18	peak
7206.00	40.92	0.18	41.10	54.00	-12.90	AVG

### (b) Antenna polarization: Vertical

Frequency (MHz)	Reading Level (dBuV)	Correct Factor (dB)	Measure Level (dBuV/m)	Limit (dBuV/m)	Over (dB)	Detector Type
4804.00	66.33	-6.06	60.27	74.00	-13.73	peak
4804.00	51.16	-6.06	45.10	54.00	-8.90	AVG
7206.00	60.26	0.18	60.44	74.00	-13.56	peak
7206.00	38.44	0.18	38.62	54.00	-15.38	AVG





Power	: DC 3.7V	Pol/Phase	: H/V
Test Mode	: TX CH39 GFSK	Temperature	: 24 °C
Memo	:	Humidity	: 59 %

(a) Antenna polarization: Horizontal

Frequency (MHz)	Reading Level (dBuV)	Correct Factor (dB)	Measure Level (dBuV/m)	Limit (dBuV/m)	Over (dB)	Detector Type
4882.00	66.97	-5.92	61.05	74.00	-12.95	peak
4882.00	52.73	-5.92	46.81	54.00	-7.19	AVG
7323.00	55.97	0.53	56.50	74.00	-17.50	peak
7323.00	39.00	0.53	39.53	54.00	-14.47	AVG

(b) Antenna polarization: Vertical

Frequency (MHz)	Reading Level (dBuV)	Correct Factor (dB)	Measure Level (dBuV/m)	Limit (dBuV/m)	Over (dB)	Detector Type
4882.00	63.36	-5.92	57.44	74.00	-16.56	peak
4882.00	49.11	-5.92	43.19	54.00	-10.81	AVG
7323.00	58.76	0.53	59.29	74.00	-14.71	peak
7323.00	37.07	0.53	37.60	54.00	-16.40	AVG



Power	: DC 3.7V	Pol/Phase	: H/V
Test Mode	: TX CH78 GFSK	Temperature	: 24 °C
Memo	:	Humidity	: 59 %

(a) Antenna polarization: Horizontal

Frequency (MHz)	Reading Level (dBuV)	Correct Factor (dB)	Measure Level (dBuV/m)	Limit (dBuV/m)	Over (dB)	Detector Type
4960.00	67.33	-5.67	61.66	74.00	-12.34	peak
4960.00	52.60	-5.67	46.93	54.00	-7.07	AVG
7440.00	54.09	0.82	54.91	74.00	-19.09	peak
7440.00	38.45	0.82	39.27	54.00	-14.73	AVG

(b) Antenna polarization: Vertical

Frequency (MHz)	Reading Level (dBuV)	Correct Factor (dB)	Measure Level (dBuV/m)	Limit (dBuV/m)	Over (dB)	Detector Type
4960.00	61.16	-5.67	55.49	74.00	-18.51	peak
4960.00	47.89	-5.67	42.22	54.00	-11.78	AVG
7440.00	58.27	0.82	59.09	74.00	-14.91	peak
7440.00	42.35	0.82	43.17	54.00	-10.83	AVG



Power	: DC 3.7V	Pol/Phase	: H/V
Test Mode	: TX CH00 $\pi/4$ DQPSK	Temperature	: 24 °C
Memo	:	Humidity	: 59 %

(a) Antenna polarization: Horizontal

Frequency (MHz)	Reading Level (dBuV)	Correct Factor (dB)	Measure Level (dBuV/m)	Limit (dBuV/m)	Over (dB)	Detector Type
4804.00	57.27	-6.06	51.21	74.00	-22.79	peak
4804.00	44.99	-6.06	38.93	54.00	-15.07	AVG
7206.00	55.93	0.18	56.11	74.00	-17.89	peak
7206.00	42.19	0.18	42.37	54.00	-11.63	AVG

(b) Antenna polarization: Vertical

Frequency (MHz)	Reading Level (dBuV)	Correct Factor (dB)	Measure Level (dBuV/m)	Limit (dBuV/m)	Over (dB)	Detector Type
4804.00	63.72	-6.06	57.66	74.00	-16.34	peak
4804.00	52.69	-6.06	46.63	54.00	-7.37	AVG
7206.00	60.06	0.18	60.24	74.00	-13.76	peak
7206.00	40.19	0.18	40.37	54.00	-13.63	AVG



Power	: DC 3.7V	Pol/Phase	: H/V
Test Mode	: TX CH39 $\pi/4$ DQPSK	Temperature	: 24 °C
Memo	:	Humidity	: 59 %

(a) Antenna polarization: Horizontal

Frequency (MHz)	Reading Level (dBuV)	Correct Factor (dB)	Measure Level (dBuV/m)	Limit (dBuV/m)	Over (dB)	Detector Type
4882.00	58.17	-5.92	52.25	74.00	-21.75	peak
4882.00	47.80	-5.92	41.88	54.00	-12.12	AVG
7323.00	51.77	0.53	52.30	74.00	-21.70	peak
7323.00	36.98	0.53	37.51	54.00	-16.49	AVG

(b) Antenna polarization: Vertical

Frequency (MHz)	Reading Level (dBuV)	Correct Factor (dB)	Measure Level (dBuV/m)	Limit (dBuV/m)	Over (dB)	Detector Type
4882.00	64.76	-5.92	58.84	74.00	-15.16	peak
4882.00	52.73	-5.92	46.81	54.00	-7.19	AVG
7323.00	51.34	0.53	51.87	74.00	-22.13	peak
7323.00	36.47	0.53	37.00	54.00	-17.00	AVG



Power	:	DC 3.7V	Pol/Phase	:	H/V
Test Mode	:	TX CH78 $\pi/4$ DQPSK	Temperature	:	24 °C
Memo	:		Humidity	:	59 %

(a) Antenna polarization: Horizontal

Frequency (MHz)	Reading Level (dBuV)	Correct Factor (dB)	Measure Level (dBuV/m)	Limit (dBuV/m)	Over (dB)	Detector Type
4960.00	55.31	-5.67	49.64	74.00	-24.36	peak
4960.00	47.25	-5.67	41.58	54.00	-12.42	AVG
7440.00	55.85	0.82	56.67	74.00	-17.33	peak
7440.00	40.88	0.82	41.70	54.00	-12.30	AVG

(b) Antenna polarization: Vertical

Frequency (MHz)	Reading Level (dBuV)	Correct Factor (dB)	Measure Level (dBuV/m)	Limit (dBuV/m)	Over (dB)	Detector Type
4960.00	65.57	-5.67	59.90	74.00	-14.10	peak
4960.00	51.77	-5.67	46.10	54.00	-7.90	AVG
7440.00	55.18	0.82	56.00	74.00	-18.00	peak
7440.00	40.35	0.82	41.17	54.00	-12.83	AVG



Power	:	DC 3.7V	Pol/Phase	:	H/V
Test Mode	:	TX CH00 8-DPSK	Temperature	:	24 °C
Memo	:		Humidity	:	59 %

(a) Antenna polarization: Horizontal

Frequency (MHz)	Reading Level (dBuV)	Correct Factor (dB)	Measure Level (dBuV/m)	Limit (dBuV/m)	Over (dB)	Detector Type
4804.00	66.00	-6.06	59.94	74.00	-14.06	peak
4804.00	53.04	-6.06	46.98	54.00	-7.02	AVG
7206.00	56.58	0.18	56.76	74.00	-17.24	peak
7206.00	41.98	0.18	42.16	54.00	-11.84	AVG

(b) Antenna polarization: Vertical

Frequency (MHz)	Reading Level (dBuV)	Correct Factor (dB)	Measure Level (dBuV/m)	Limit (dBuV/m)	Over (dB)	Detector Type
4804.00	57.19	-6.06	51.13	74.00	-22.87	peak
4804.00	50.06	-6.06	44.00	54.00	-10.00	AVG
7206.00	56.94	0.18	57.12	74.00	-16.88	peak
7206.00	42.70	0.18	42.88	54.00	-11.12	AVG



Power	: DC 3.7V	Pol/Phase	: H/V
Test Mode	: TX CH39 8-DPSK	Temperature	: 24 °C
Memo	:	Humidity	: 59 %

(a) Antenna polarization: Horizontal

Frequency (MHz)	Reading Level (dBuV)	Correct Factor (dB)	Measure Level (dBuV/m)	Limit (dBuV/m)	Over (dB)	Detector Type
4882.00	67.40	-5.92	61.48	74.00	-12.52	peak
4882.00	49.87	-5.92	43.95	54.00	-10.05	AVG
7323.00	57.32	0.53	57.85	74.00	-16.15	peak
7323.00	37.51	0.53	38.04	54.00	-15.96	AVG

(b) Antenna polarization: Vertical

Frequency (MHz)	Reading Level (dBuV)	Correct Factor (dB)	Measure Level (dBuV/m)	Limit (dBuV/m)	Over (dB)	Detector Type
4882.00	65.20	-5.92	59.28	74.00	-14.72	peak
4882.00	49.50	-5.92	43.58	54.00	-10.42	AVG
7323.00	60.32	0.53	60.85	74.00	-13.15	peak
7323.00	43.88	0.53	44.41	54.00	-9.59	AVG



Power	: DC 3.7V	Pol/Phase	: H/V
Test Mode	: TX CH78 8-DPSK	Temperature	: 24 °C
Memo	:	Humidity	: 59 %

(a) Antenna polarization: Horizontal

Frequency (MHz)	Reading Level (dBuV)	Correct Factor (dB)	Measure Level (dBuV/m)	Limit (dBuV/m)	Over (dB)	Detector Type
4960.00	63.45	-5.67	57.78	74.00	-16.22	peak
4960.00	51.95	-5.67	46.28	54.00	-7.72	AVG
7440.00	47.20	0.82	48.02	74.00	-25.98	peak
7440.00	33.34	0.82	34.16	54.00	-19.84	AVG

(b) Antenna polarization: Vertical

Frequency (MHz)	Reading Level (dBuV)	Correct Factor (dB)	Measure Level (dBuV/m)	Limit (dBuV/m)	Over (dB)	Detector Type
4960.00	66.24	-5.67	60.57	74.00	-13.43	peak
4960.00	49.31	-5.67	43.64	54.00	-10.36	AVG
7440.00	54.53	0.82	55.35	74.00	-18.65	peak
7440.00	37.41	0.82	38.23	54.00	-15.77	AVG

Note:

Measurement Level = Reading Level + Correct Factor

Remark: Factor = Antenna Factor + Cable Loss–Pre-amplifier





7.7 Restrict Band Emission Measurement Data

Radiated Method

Power	: DC 3.7V	Pol/Phase	: H/V
Test Mode	: GFSK / $\pi/4$ DQPSK / 8-DPSK	Temperature	: 24 °C
Memo	:	Humidity	: 59 %

GFSK

Channel 0						Fundamental Frequency: 2402 MHz				
Frequency (MHz)	Ant-Pol H/V	Reading Level (dBuV)	Corrected Factor (dB)	Result (dBuV/m)	Remark	Limit (dBuV/m)		Margin (dB)	Table Deg.	Ant High (m)
						Peak	Ave			
2390.00	H	58.64	-14.08	44.56	Peak	74.00	--	-29.44	0	1.5
2390.00	H	46.62	-14.08	32.54	Ave	--	54.00	-21.46	0	1.5
2330.50	V	60.92	-14.05	46.87	Peak	74.00	--	-27.13	359	1.5
2330.50	V	49.56	-14.05	35.51	Ave	--	54.00	-18.49	359	1.5
Channel 78						Fundamental Frequency: 2480 MHz				
Frequency (MHz)	Ant-Pol H/V	Reading Level (dBuV)	Corrected Factor (dB)	Result (dBuV/m)	Remark	Limit (dBuV/m)		Margin (dB)	Table Deg.	Ant High (m)
						Peak	Ave			
2483.50	H	55.71	-13.79	41.92	Peak	74.00	--	-32.08	0	1.5
2483.50	H	47.43	-13.79	33.64	Ave	--	54.00	-20.36	0	1.5
2486.48	V	56.74	-13.83	42.91	Peak	74.00	--	-31.09	0	1.5
2486.48	V	47.38	-13.83	33.55	Ave	--	54.00	-20.45	0	1.5



### π/4 DQPSK

Channel 0						Fundamental Frequency: 2402 MHz				
Frequency (MHz)	Ant-Pol H/V	Reading Level (dBuV)	Corrected Factor (dB)	Result (dBuV/m)	Remark	Limit (dBuV/m)		Margin (dB)	Table Deg.	Ant High (m)
						Peak	Ave			
2390.00	H	60.69	-14.08	46.61	Peak	74.00	--	-27.39	0	1.5
2390.00	H	49.40	-14.08	35.32	Ave	--	54.00	-18.68	0	1.5
2328.17	V	62.27	-14.05	48.22	Peak	74.00	--	-25.78	360	1.5
2328.17	V	52.23	-14.05	38.18	Ave	--	54.00	-15.82	360	1.5
Channel 78						Fundamental Frequency: 2480 MHz				
Frequency (MHz)	Ant-Pol H/V	Reading Level (dBuV)	Corrected Factor (dB)	Result (dBuV/m)	Remark	Limit (dBuV/m)		Margin (dB)	Table Deg.	Ant High (m)
						Peak	Ave			
2483.50	H	60.10	-13.79	46.31	Peak	74.00	--	-27.69	5	1.5
2483.50	H	48.49	-13.79	34.70	Ave	--	54.00	-19.30	5	1.5
2488.97	V	57.30	-13.83	43.47	Peak	74.00	--	-30.53	0	1.5
2488.97	V	46.50	-13.83	32.67	Ave	--	54.00	-21.33	0	1.5

### 8-DPSK

Channel 0						Fundamental Frequency: 2402 MHz				
Frequency (MHz)	Ant-Pol H/V	Reading Level (dBuV)	Corrected Factor (dB)	Result (dBuV/m)	Remark	Limit (dBuV/m)		Margin (dB)	Table Deg.	Ant High (m)
						Peak	Ave			
2390.00	H	60.29	-14.08	46.21	Peak	74.00	--	-27.79	10	1.5
2390.00	H	46.91	-14.08	32.83	Ave	--	54.00	-21.17	10	1.5
2382.83	V	60.13	-14.03	46.10	Peak	74.00	--	-27.90	0	1.5
2382.83	V	53.96	-14.03	39.93	Ave	--	54.00	-14.07	0	1.5
Channel 78						Fundamental Frequency: 2480 MHz				
Frequency (MHz)	Ant-Pol H/V	Reading Level (dBuV)	Corrected Factor (dB)	Result (dBuV/m)	Remark	Limit (dBuV/m)		Margin (dB)	Table Deg.	Ant High (m)
						Peak	Ave			
2483.50	H	55.38	-13.79	41.59	Peak	74.00	--	-32.41	0	1.5
2483.50	H	49.56	-13.79	35.77	Ave	--	54.00	-18.23	0	1.5
2488.45	V	60.66	-13.83	46.83	Peak	74.00	--	-27.17	0	1.5
2488.45	V	48.12	-13.83	34.29	Ave	--	54.00	-19.71	0	1.5



Note:

1. Result = Reading Level + Correction factor
2. Correction factor : Antenna factor, Cable loss, Pre-Amp, etc.
3. All emissions as described above were determining by rotating the EUT through three orthogonal axes to maximizing the emissions if the EUT belongs to hand-held or body-worn devices.
4. Measurements above 1000 MHz, Peak detector setting:  
1 MHz RBW with 1 MHz VBW (Peak Detector).
5. Measurements above 1000 MHz, Average detector setting:  
1 MHz RBW with 10Hz VBW (RMS Detector).
6. Peak detector measurement data will represent the worst case results.

Where limits are specified for both average and peak detector functions, if the peak measured value complies with the average limit, it is unnecessary to perform an average measurement.



## 8. Bandwidth Measurement Data

### 8.1 Test Limit

Please refer RSS-247 & section15.247.

### 8.2 Test Procedures

- a. The transmitter output was connected to the spectrum analyzer.
- b. Set RBW of spectrum analyzer to 30 KHz and VBW  $\geq$  3x RBW.
- c. The 20 dB bandwidth is defined as the total spectrum the power of which is higher than peak power minus 20 dB.
- d. The 20dB Bandwidth was measured and recorded.

### 8.3 Test Setup Layout

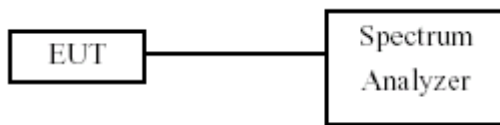



## 8.4 Test Result and Data

Test Date: Jul. 7, 2018

Temperature: 26°C

Atmospheric pressure: 1000 hPa

Humidity: 55%

Modulation Standard	Channel	Frequency (MHz)	20dB Bandwidth (KHz)
GFSK	0	2402	972
	39	2441	972
	78	2480	972
$\pi/4$ DQPSK	0	2402	1374
	39	2441	1374
	78	2480	1374
8-DPSK	0	2402	1356
	39	2441	1356
	78	2480	1362

Modulation Standard: GFSK  
Channel: 0

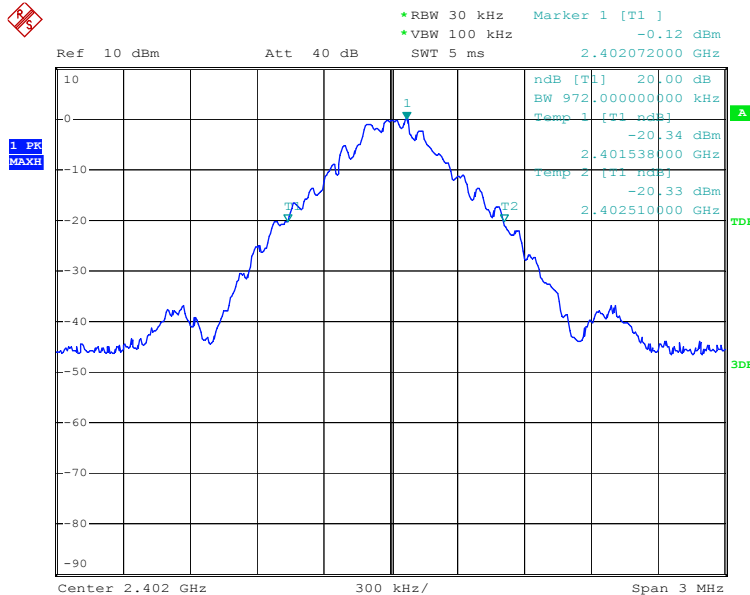

Date: 7.JUL.2018 16:59:36



Modulation Standard: GFSK

Channel: 39

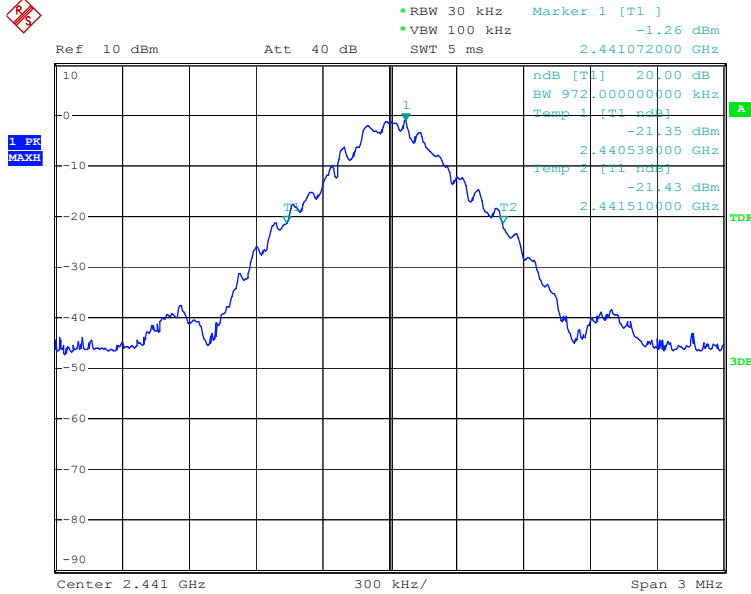

Date: 7.JUL.2018 17:00:11

Modulation Standard: GFSK

Channel: 78

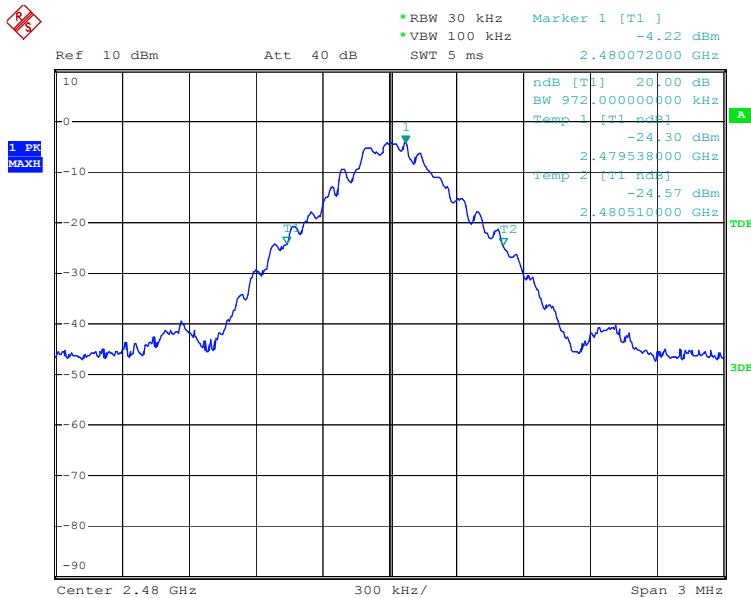

Date: 7.JUL.2018 17:00:40



Modulation Standard:  $\pi/4$  DQPSK

Channel: 0

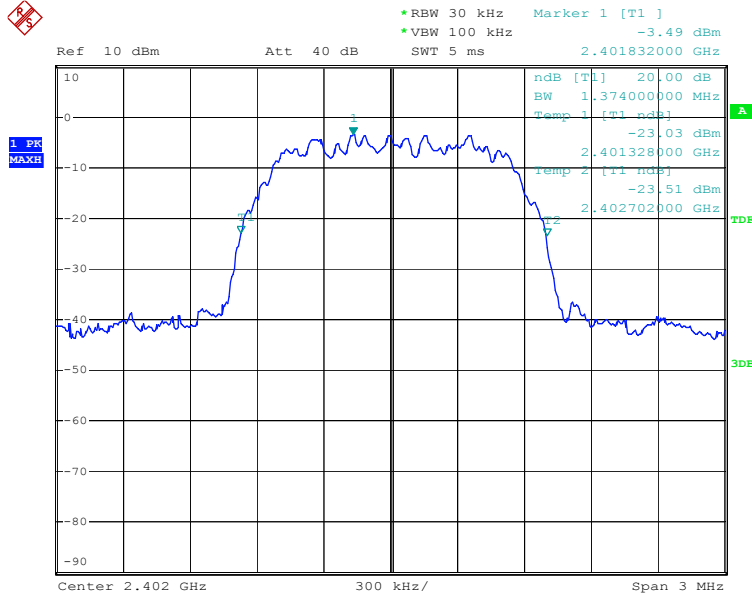

Date: 7.JUL.2018 17:01:28

Modulation Standard:  $\pi/4$  DQPSK

Channel: 39

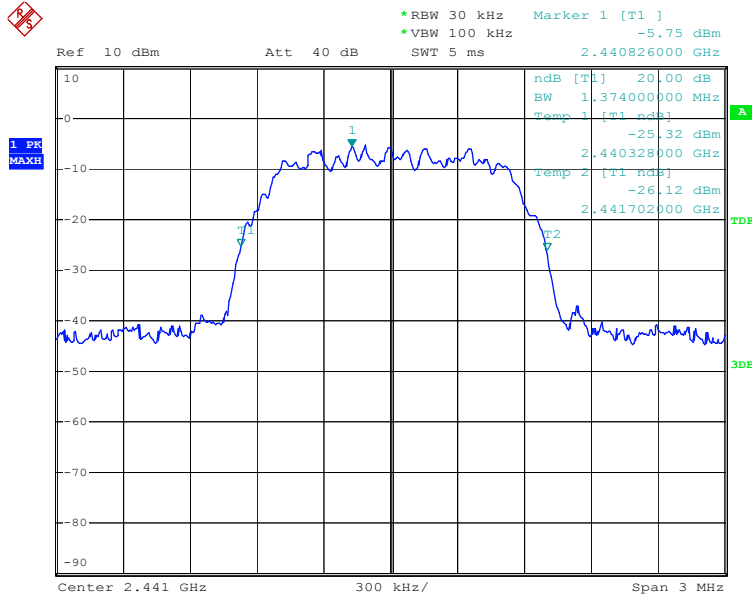

Date: 7.JUL.2018 17:02:18



Modulation Standard:  $\pi/4$  DQPSK  
Channel: 78

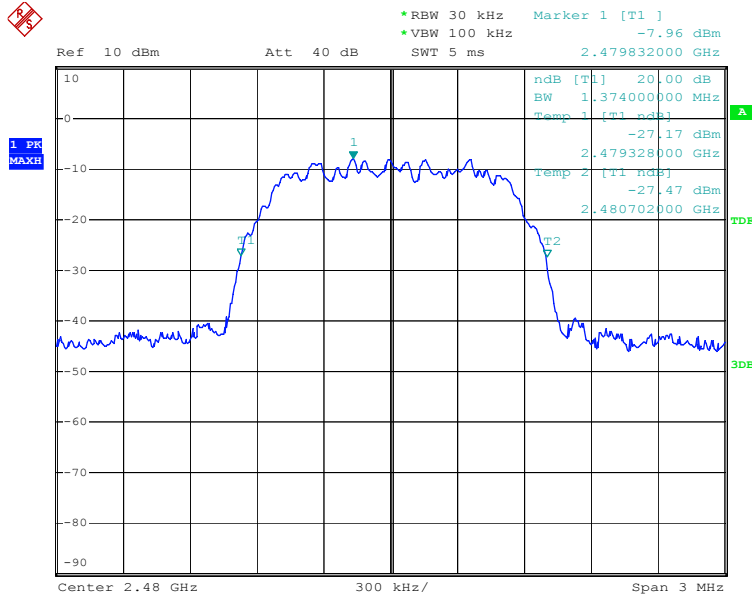

Date: 7.JUL.2018 17:02:54

Modulation Standard: 8-DPSK  
Channel: 0

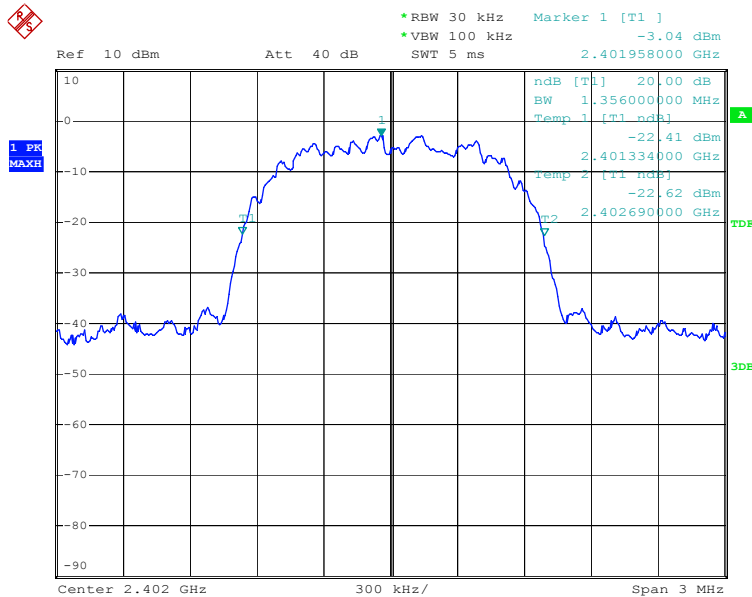

Date: 7.JUL.2018 17:04:16





Modulation Standard: 8-DPSK

Channel: 39

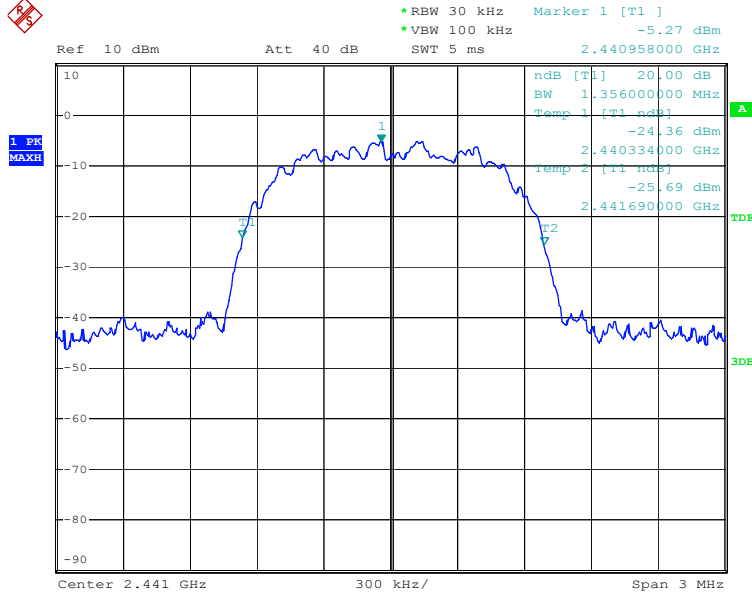

Date: 7.JUL.2018 17:05:19

Modulation Standard: 8-DPSK

Channel: 78

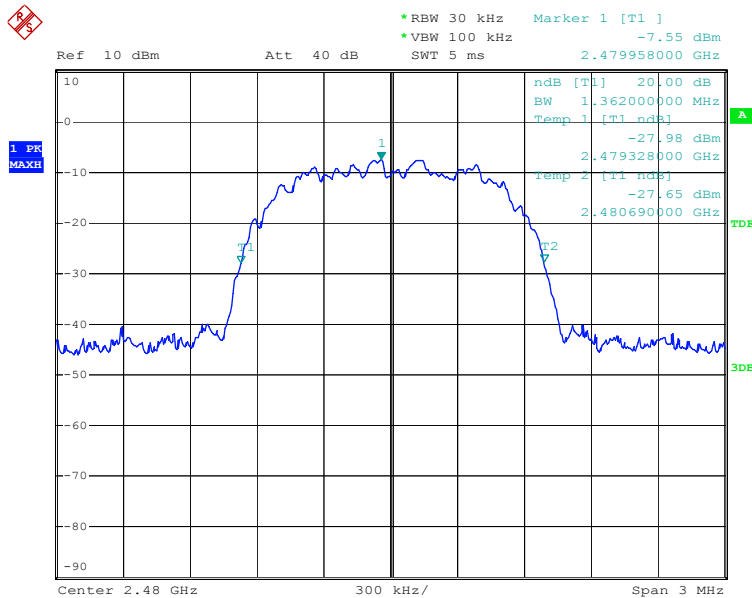

Date: 7.JUL.2018 17:06:13



## **9. Maximum Peak Output Power**

### **9.1 Test Limit**

15.247(b) (1) For frequency hopping systems operating in the 2400-2483.5 MHz band employing at least 75 non-overlapping hopping channels, and all frequency hopping systems in the 5725-5850 MHz band: 1watt. For all other frequency hopping systems in the 2400-2483.5 MHz band: 0.125 watts.

### **9.2 Test Procedures**

- a. Peak power is measured using the wideband power meter.
- b. Power is integrated over a bandwidth greater than or equal to the 99% bandwidth.
- c. The Peak Output Power was measured and recorded.

### **9.3 Test Setup Layout**

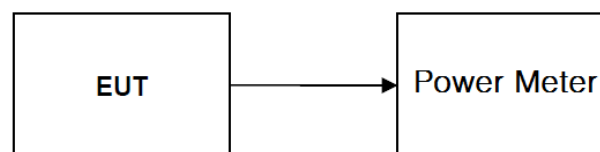



#### 9.4 Test Result and Data

Test Date: Jul. 7, 2018

Temperature: 26°C

Atmospheric pressure: 1000hPa

Humidity: 55%

Modulation Standard	Channel	Peak Output Power (dBm)	Peak Output Power (mW)	Limit (mW)	Result
GFSK	0	2.56	1.80	125	Pass
	39	1.86	1.53	125	Pass
	78	0.25	1.06	125	Pass
$\pi/4$ DQPSK	0	2.84	1.92	125	Pass
	39	1.58	1.44	125	Pass
	78	0.22	1.05	125	Pass
8-DPSK	0	2.71	1.87	125	Pass
	39	1.24	1.33	125	Pass
	78	0.34	1.08	125	Pass



## 10. Carrier Frequency Separation

### 10.1 Test Limit

- a. Frequency hopping systems shall have hopping channel carrier frequencies separated by a minimum of 25 kHz or the 20 dB bandwidth of the hopping channel, whichever is greater. Alternatively, frequency hopping systems operating in the 2400-2483.5 MHz band may have hopping channel carrier frequencies that are separated by 25 kHz or two-thirds of the 20 dB bandwidth of the hopping channel, whichever is greater, provided the systems operate with an output power no greater than 125 mW.

### 10.2 Test Procedures

- b. The transmitter output was connected to spectrum analyzer.
- c. The spectrum analyzer's resolution bandwidth were set at 100KHz RBW and 300KHz VBW as that of the fundamental frequency. Set the sweep time=auto couple.
- d. The Carrier Frequency Separation was measured and recorded.

### 10.3 Test Setup Layout

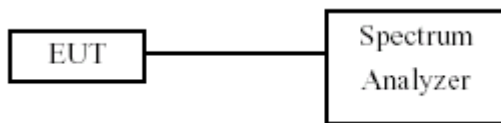



**10.4 Test Result and Data**

Test Date: Jul. 7, 2018

Temperature: 26°C

Atmospheric pressure: 1000 hPa

Humidity: 55%

Modulation Standard	Channel	Channel separation (KHz)	20dB Bandwidth (KHz)	Limit (KHz) 2/3 20dB bandwidth	Conclusion
GFSK	0	1002	972	648	PASS
	39	996	972	648	PASS
	78	1002	972	648	PASS
$\pi/4$ DQPSK	0	1002	1374	916	PASS
	39	1002	1374	916	PASS
	78	1008	1374	916	PASS
8-DPSK	0	1188	1356	904	PASS
	39	999	1356	904	PASS
	78	1002	1362	908	PASS



Modulation Standard: GFSK  
Channel: 0

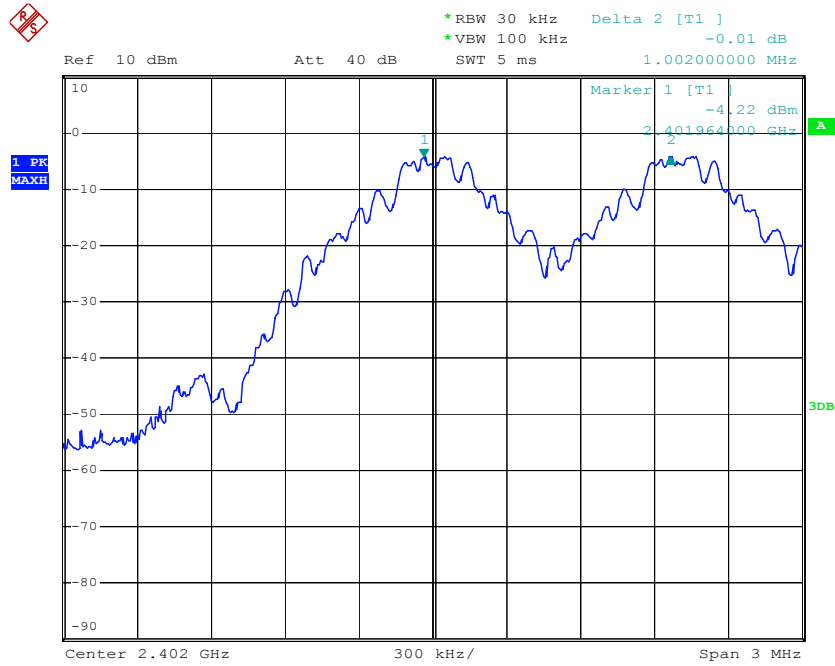

Modulation Standard: GFSK  
Channel: 39

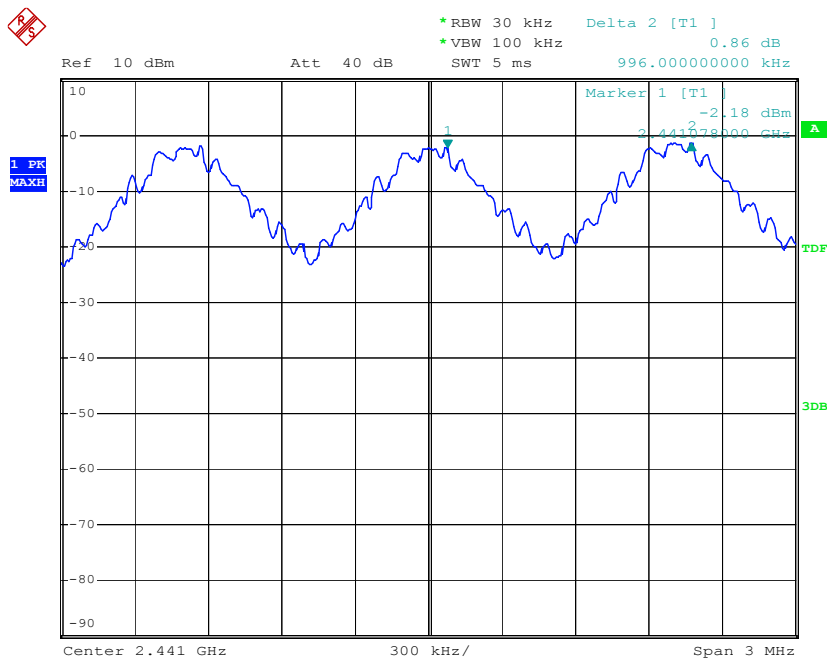



Modulation Standard: GFSK  
Channel: 78

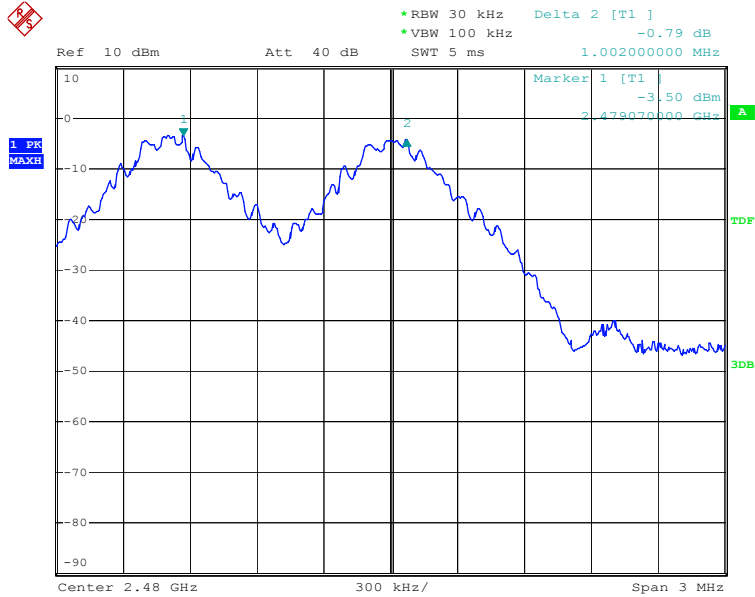

Date: 7.JUL.2018 17:09:39

Modulation Standard:  $\pi/4$  DQPSK  
Channel: 0

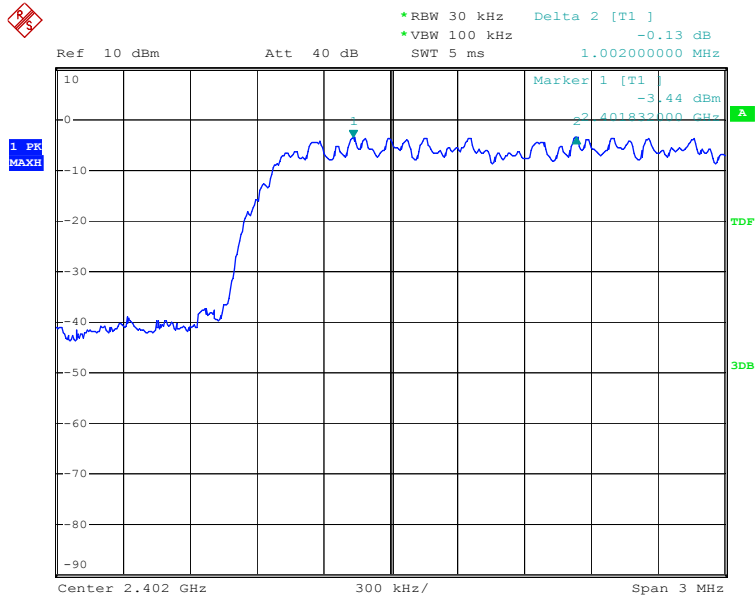

Date: 7.JUL.2018 17:12:13



Modulation Standard:  $\pi/4$  DQPSK  
Channel: 39

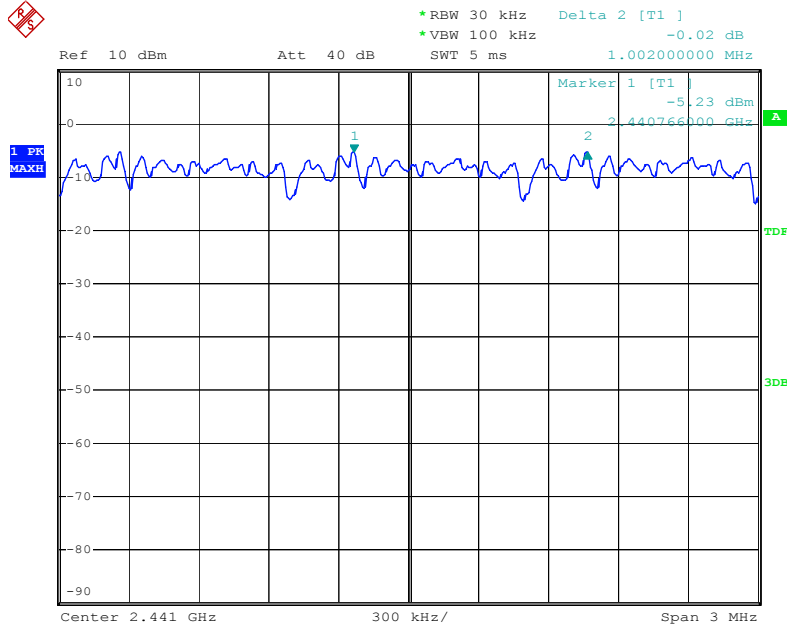

Modulation Standard:  $\pi/4$  DQPSK  
Channel: 78

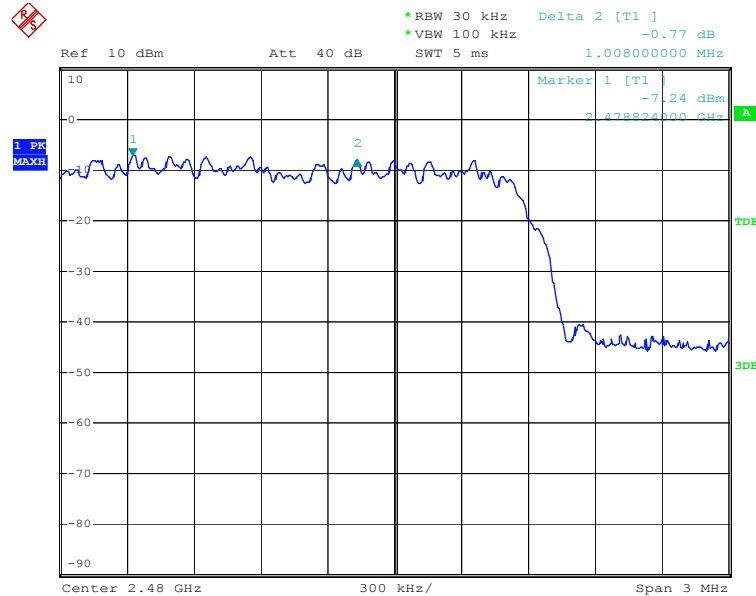

Date: 7.JUL.2018 17:16:05





Modulation Standard: 8-DPSK  
Channel: 0

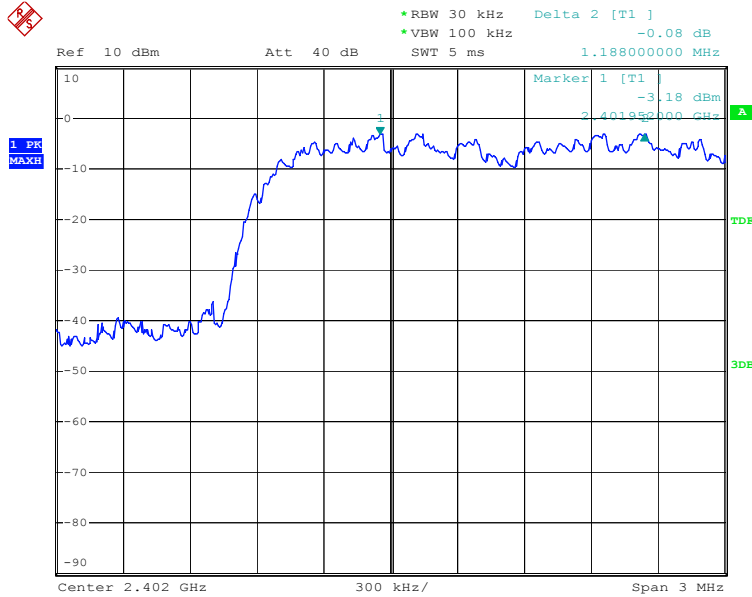

Date: 7.JUL.2018 17:16:47

Modulation Standard: 8-DPSK  
Channel: 39

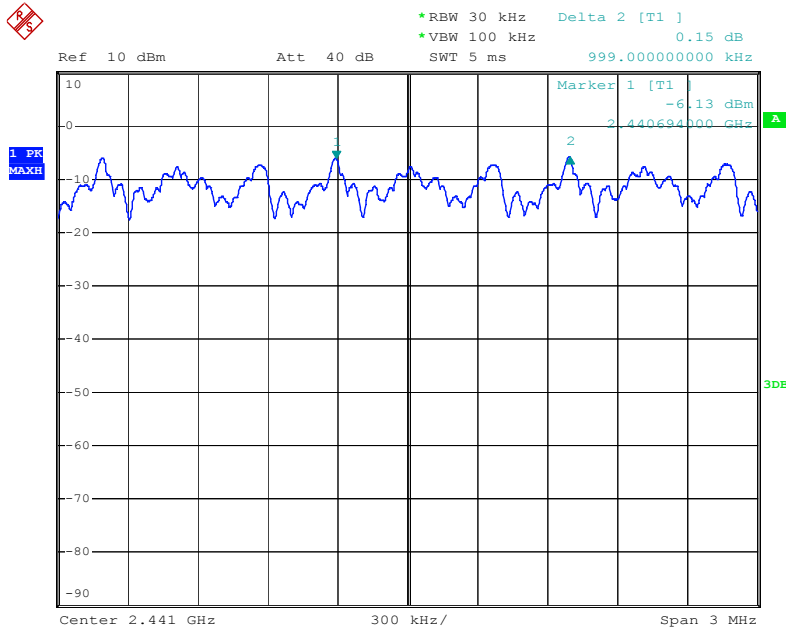



Modulation Standard: 8-DPSK  
Channel: 78

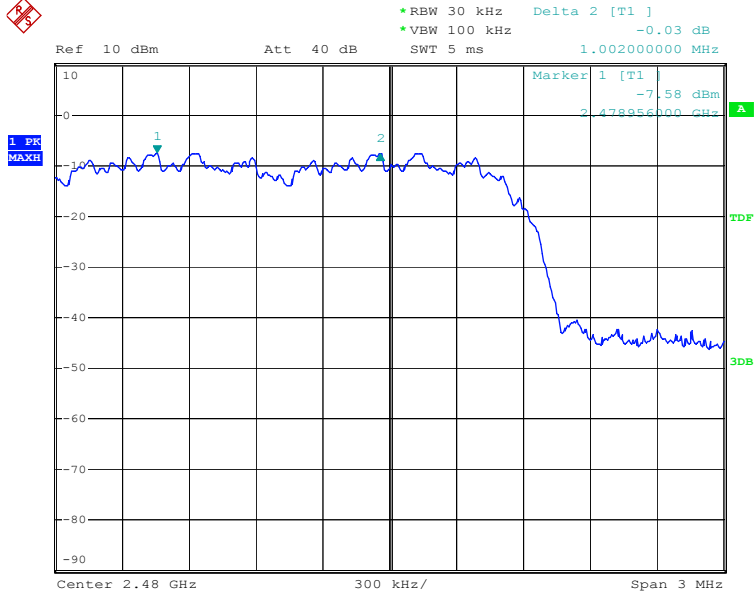

Date: 7.JUL.2018 17:17:58



## 11. Number Of Hopping Channel

### 11.1 Test Limit

Frequency hopping systems in the 2400-2483.5 MHz band shall use at least 15 channels

### 11.2 Test Procedure

- a. The transmitter output was connected to the spectrum analyzer via a low loss cable.
- b. The transmitter output was coupled to a spectrum analyzer via a antenna. The number of hopping channel was measured by spectrum analyzer with 300kHz RBW and 1MHz VBW.
- c. The number of hopping channel was measured and recorded.

### 11.3 Test Setup Layout

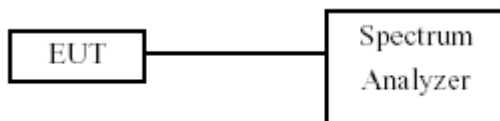





## 12. Dwell Time

### 12.1 Test Limit

Please refer RSS-247 & section15.247

### 12.2 Test Procedure

- d. The transmitter output was connected to the spectrum analyzer via a low lose cable.
- e. The transmitter output was coupled to a spectrum analyzer via a antenna. Set center frequency of spectrum analyzer = operating frequency
- f. Set the spectrum analyzer as RBW, VBW=1MHz, Span = 0Hz, Sweep = auto.
- g. Repeat above procedures until all frequency measured were complete

### 12.3 Test Setup Layout

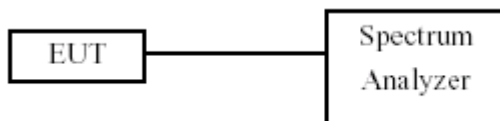



**12.4 Test Result and Data**

Original test data see the following page.

Mode	Data Packet	Frequency (MHz)	Pulse Duration (ms)	Dwell Time (s)	Limit (s)	Conclusion
GFSK	DH1	2402 MHz	0.392	0.125	<0.4	PASS
	DH3	2402 MHz	1.666	0.267	<0.4	PASS
	DH5	2402 MHz	2.946	0.314	<0.4	PASS
	DH1	2441 MHz	0.392	0.125	<0.4	PASS
	DH3	2441 MHz	1.660	0.266	<0.4	PASS
	DH5	2441 MHz	2.940	0.314	<0.4	PASS
	DH1	2480 MHz	0.392	0.125	<0.4	PASS
	DH3	2480 MHz	1.660	0.266	<0.4	PASS
	DH5	2480 MHz	2.940	0.314	<0.4	PASS
π/4 DQPSK	2DH1	2402 MHz	0.396	0.127	<0.4	PASS
	2DH3	2402 MHz	1.680	0.269	<0.4	PASS
	2DH5	2402 MHz	2.940	0.314	<0.4	PASS
	2DH1	2441 MHz	0.404	0.129	<0.4	PASS
	2DH3	2441 MHz	1.670	0.267	<0.4	PASS
	2DH5	2441 MHz	2.920	0.311	<0.4	PASS
	2DH1	2480 MHz	0.400	0.128	<0.4	PASS
	2DH3	2480 MHz	1.670	0.267	<0.4	PASS
	2DH5	2480 MHz	2.940	0.314	<0.4	PASS
8-DPSK	3DH1	2402 MHz	0.400	0.128	<0.4	PASS
	3DH3	2402 MHz	1.670	0.267	<0.4	PASS
	3DH5	2402 MHz	2.940	0.314	<0.4	PASS
	3DH1	2441 MHz	0.404	0.129	<0.4	PASS
	3DH3	2441 MHz	1.660	0.266	<0.4	PASS
	3DH5	2441 MHz	2.940	0.314	<0.4	PASS
	3DH1	2480 MHz	0.400	0.128	<0.4	PASS
	3DH3	2480 MHz	1.670	0.267	<0.4	PASS
	3DH5	2480 MHz	2.940	0.314	<0.4	PASS

Note:

A Period Time =  $79 \times 0.4 = 31.6$  S

DH1 Time Slot: Reading \*  $(1600/2) \times 31.6/79$

DH3 Time Slot: Reading \*  $(1600/4) \times 31.6/79$

DH5 Time Slot: Reading \*  $(1600/6) \times 31.6/79$



## GFSK CH0 DH1/DH3/DH5

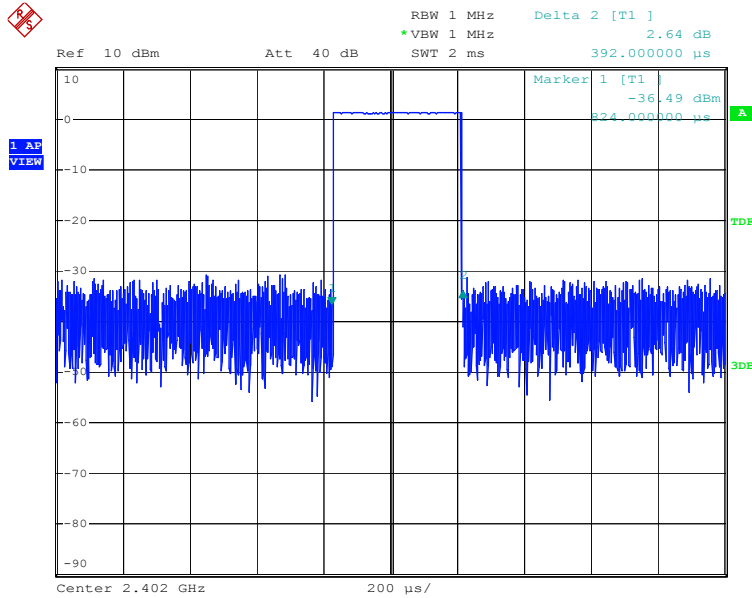

Date: 7.JUL.2018 17:28:19

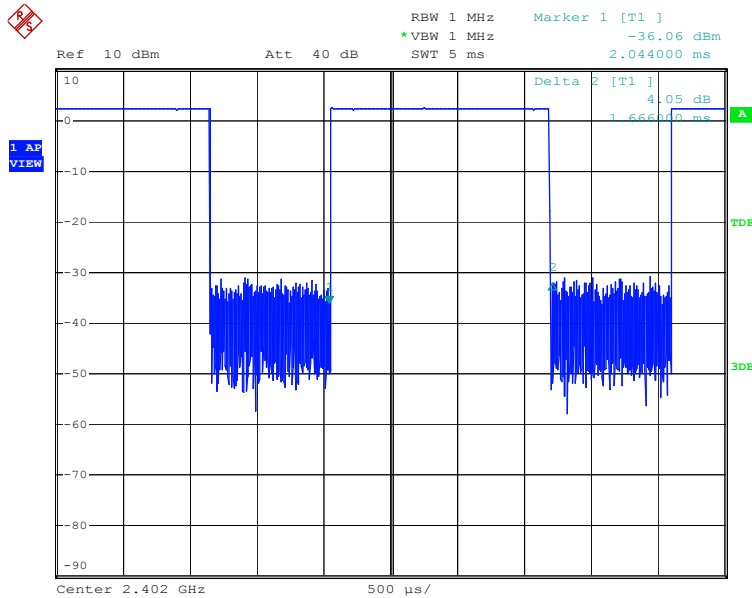

Date: 7.JUL.2018 17:29:09

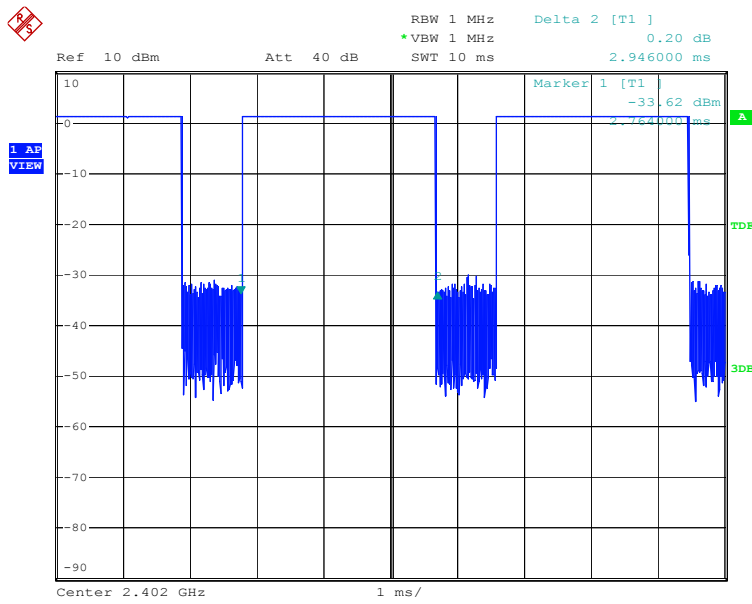

Date: 7.JUL.2018 17:29:53

GFSK CH39 DH1/DH3/DH5

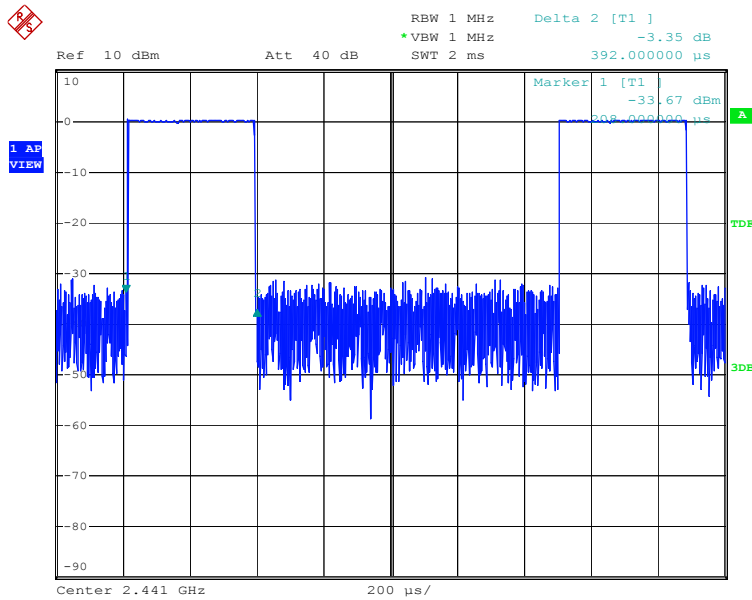

Date: 7.JUL.2018 17:35:10



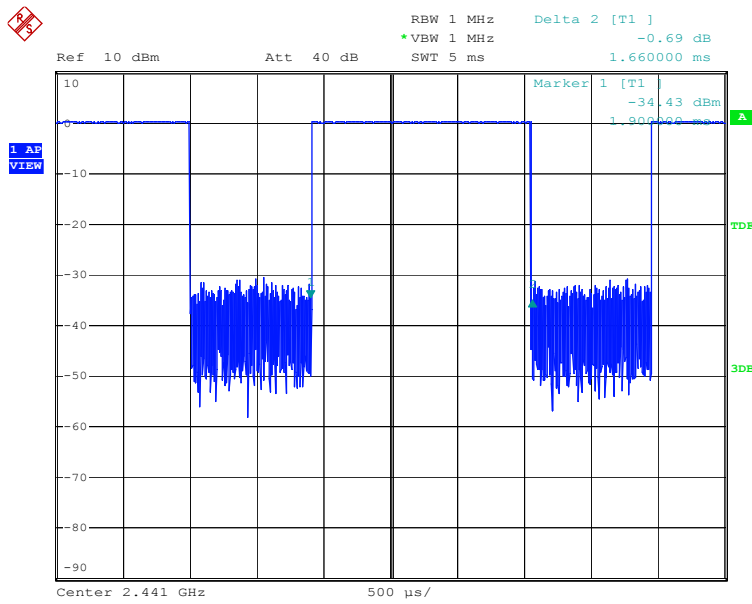

Date: 7.JUL.2018 17:35:40

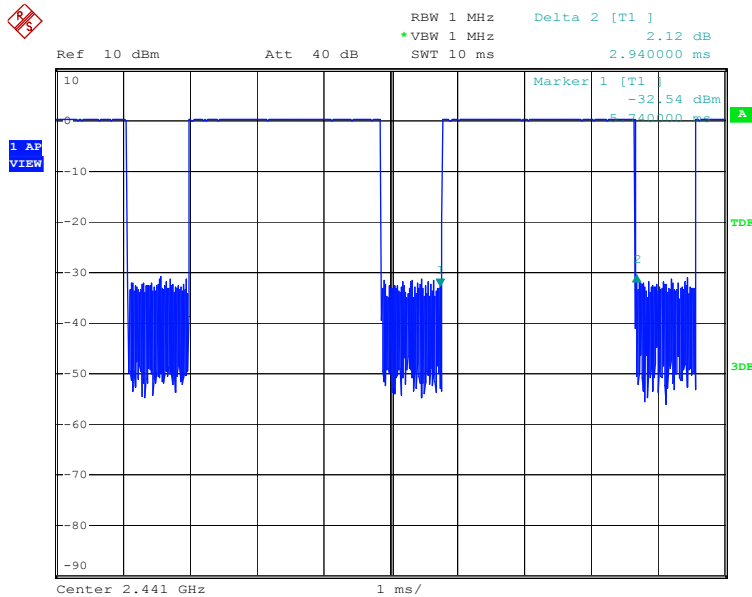

Date: 7.JUL.2018 17:36:11



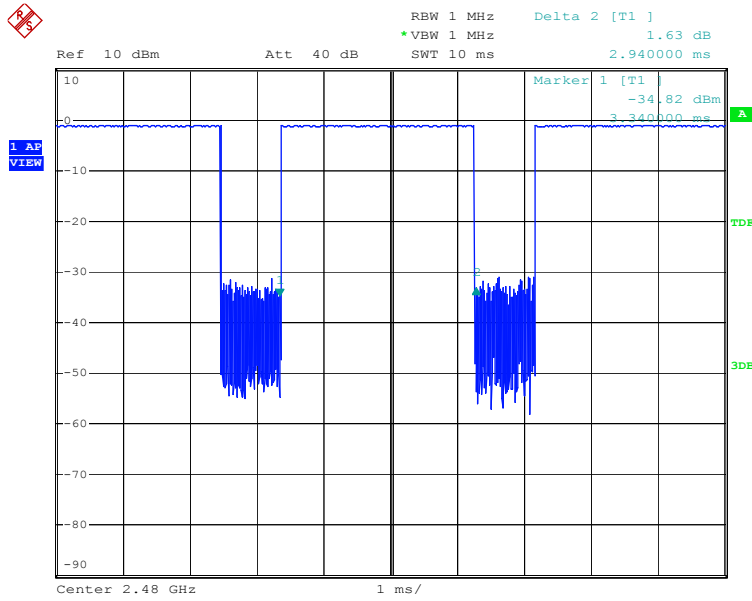

Date: 7.JUL.2018 17:42:19

$\pi/4$  DQPSK CH0 2DH1/2DH3/2DH5

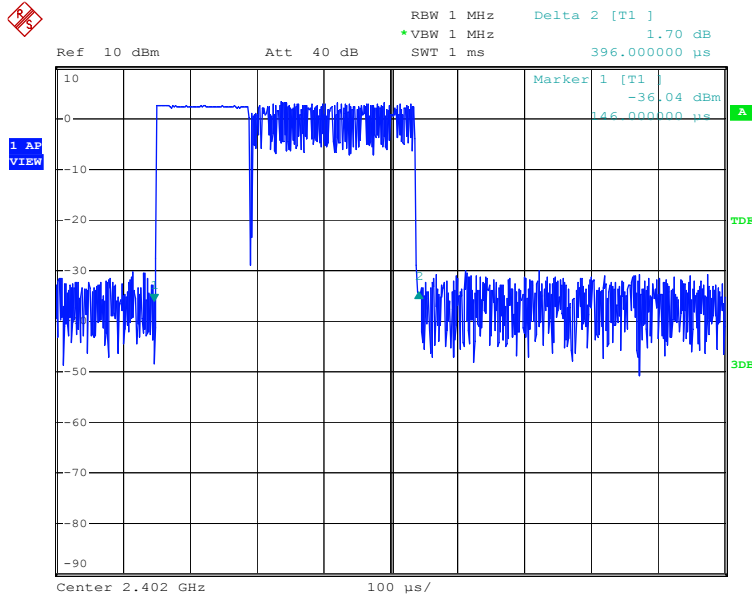

Date: 7.JUL.2018 17:31:09

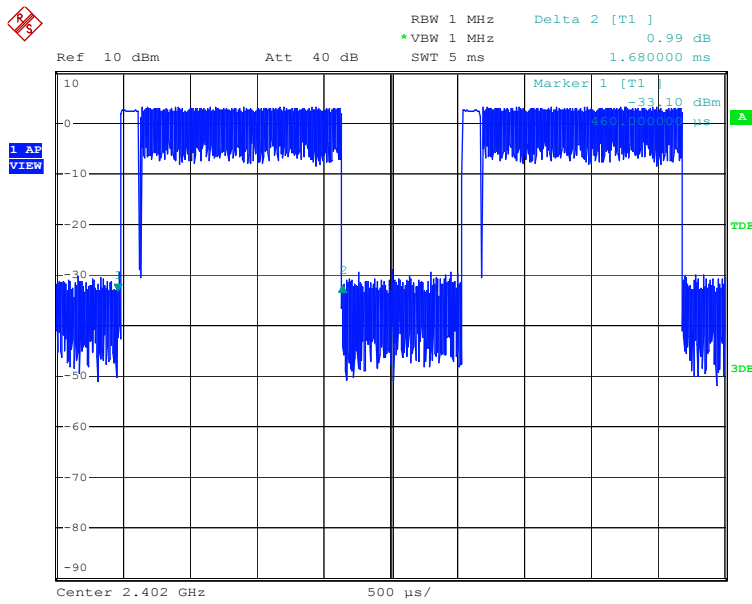

Date: 7.JUL.2018 17:31:44

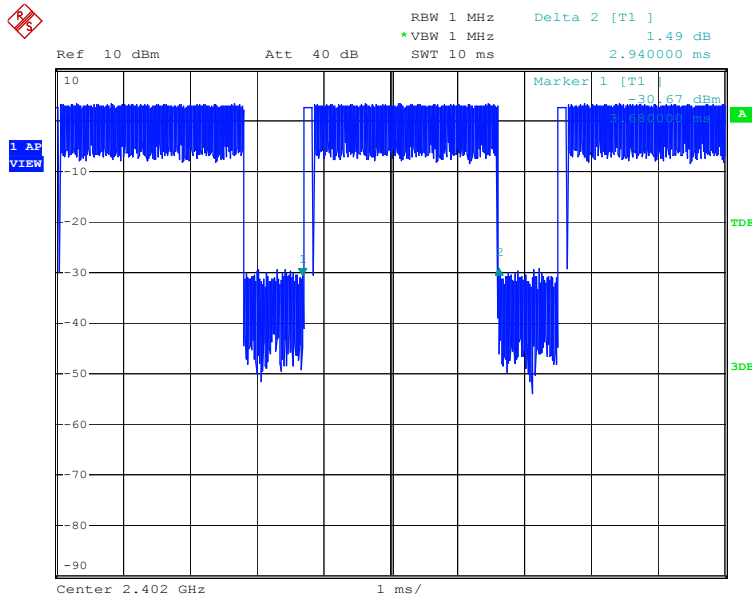

Date: 7.JUL.2018 17:32:21



## $\pi/4$ DQPSK CH39 2DH1/2DH3/2DH5

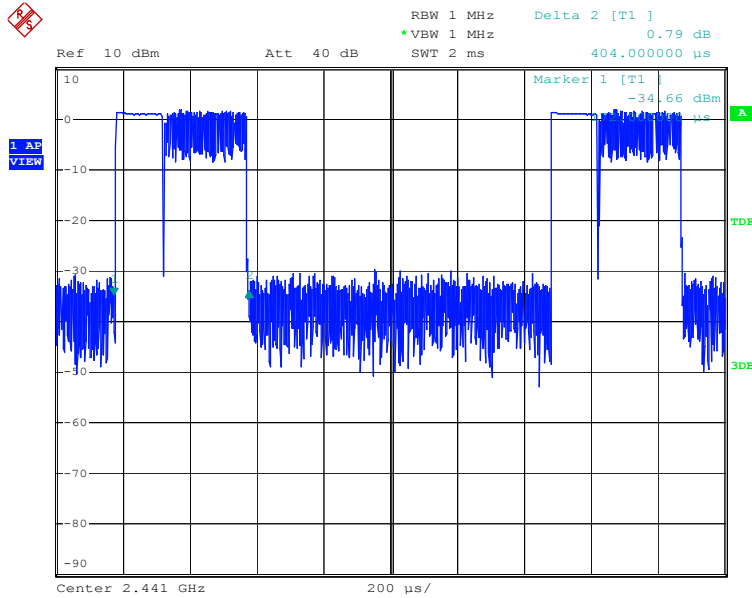

Date: 7.JUL.2018 17:36:52

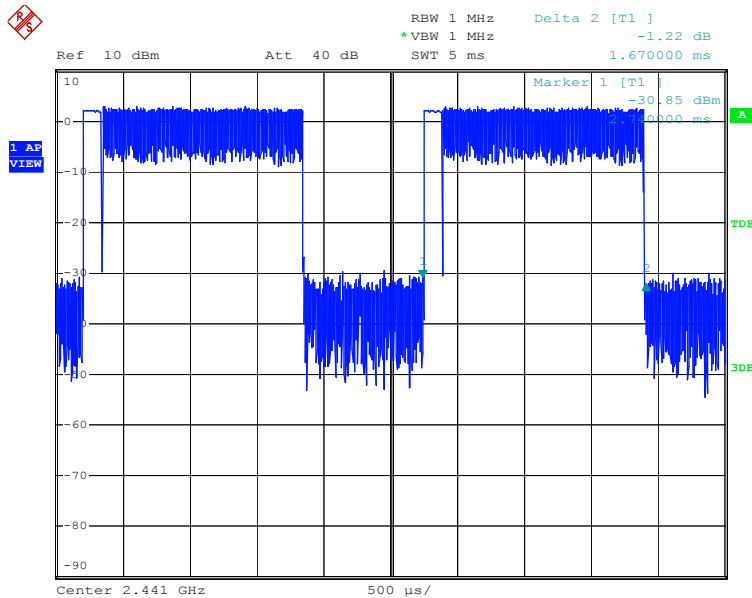

Date: 7.JUL.2018 17:37:24

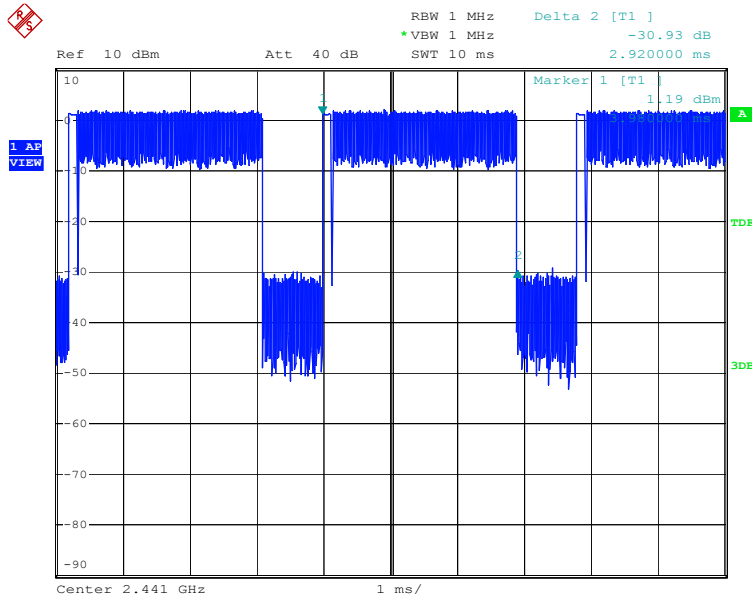

Date: 7.JUL.2018 17:37:46

$\pi/4$  DQPSK CH78 2DH1/2DH3/2DH5

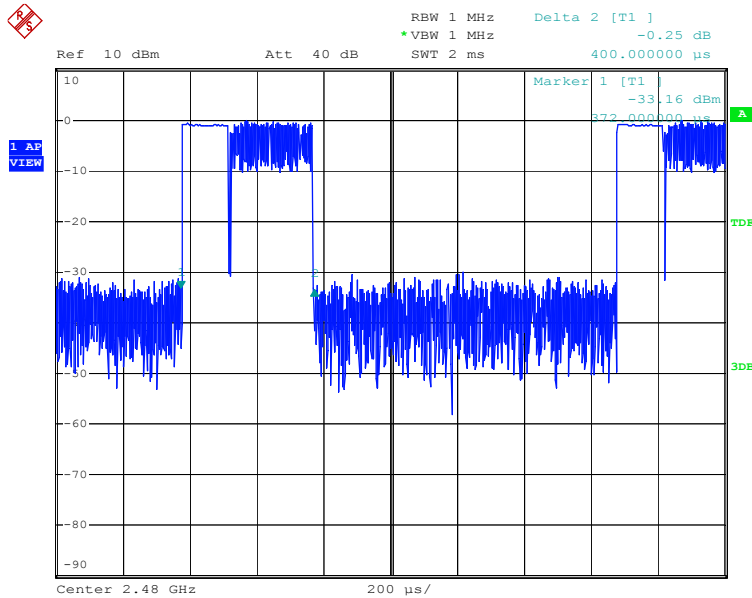

Date: 7.JUL.2018 17:45:00

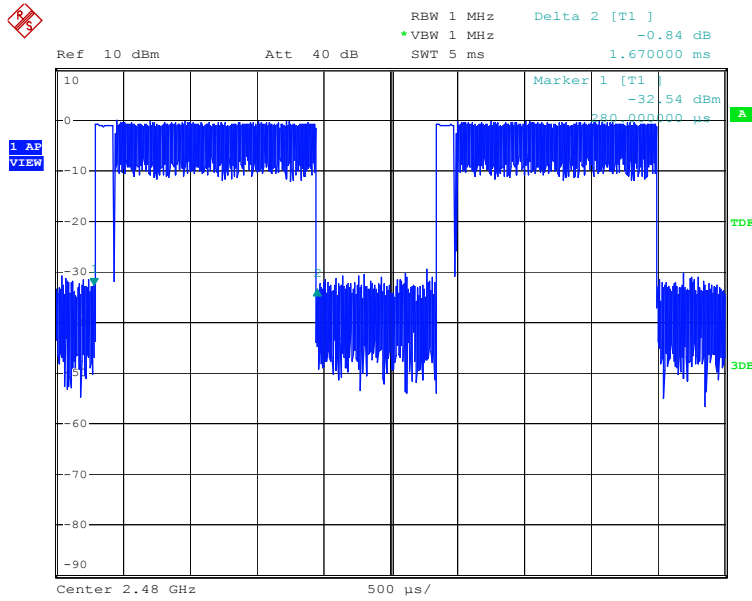

Date: 7.JUL.2018 17:45:27

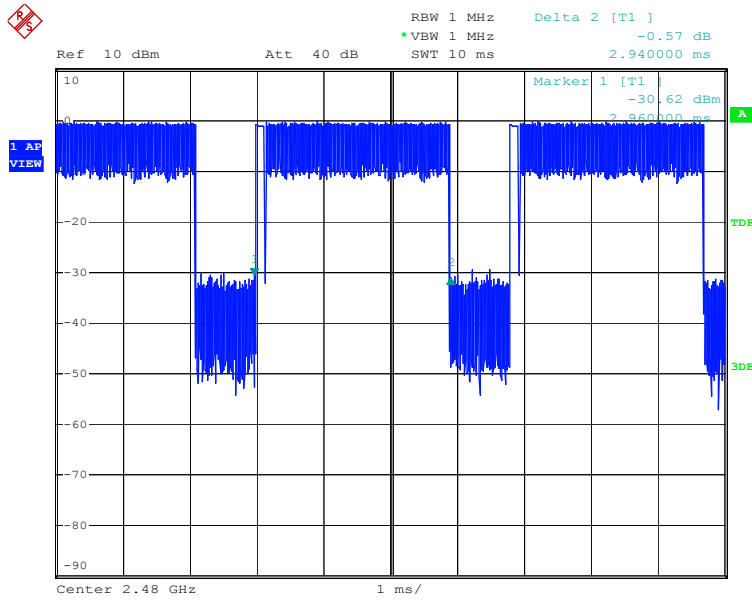

Date: 7.JUL.2018 17:45:51



8-DPSK CH0 3DH1/3DH3/3DH5

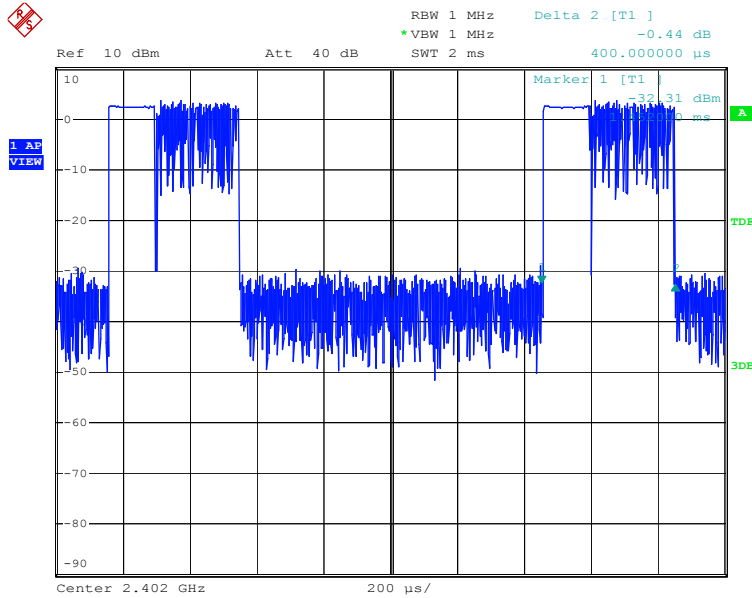

Date: 7.JUL.2018 17:33:10

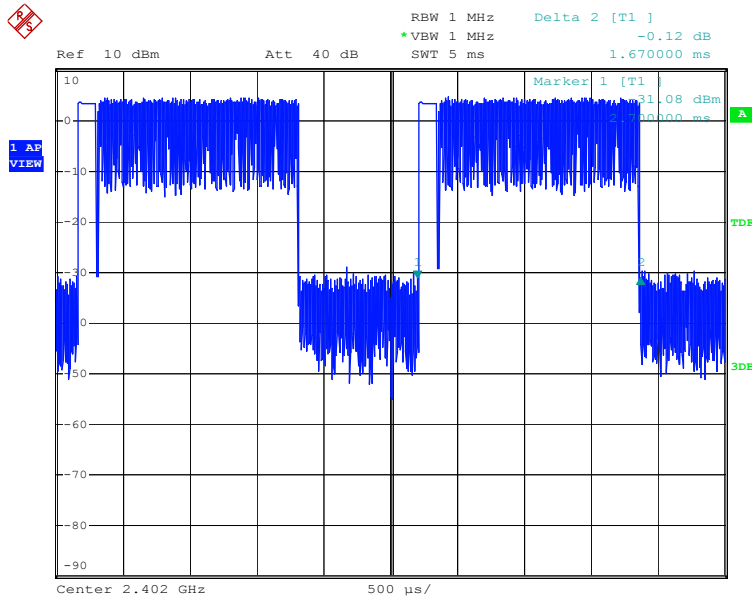

Date: 7.JUL.2018 17:33:39



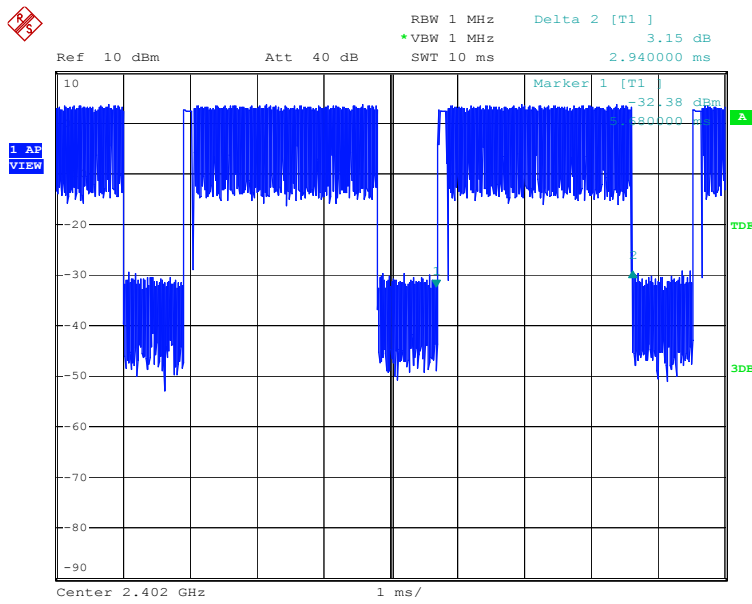

Date: 7.JUL.2018 17:34:07

8-DPSK CH39 3DH1/3DH3/3DH5

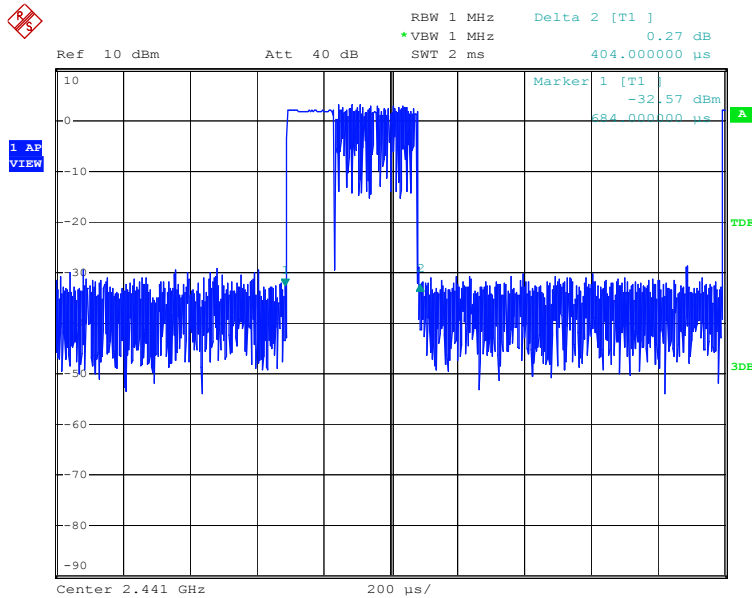

Date: 7.JUL.2018 17:38:37

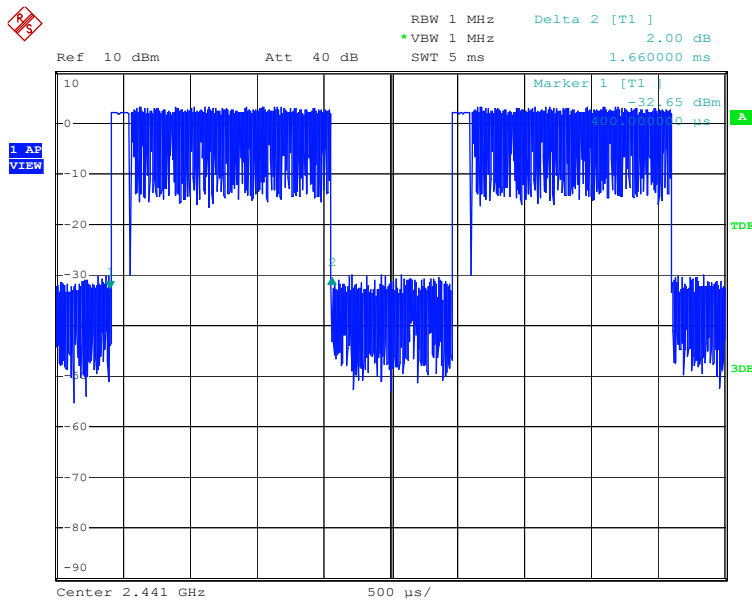

Date: 7.JUL.2018 17:39:04

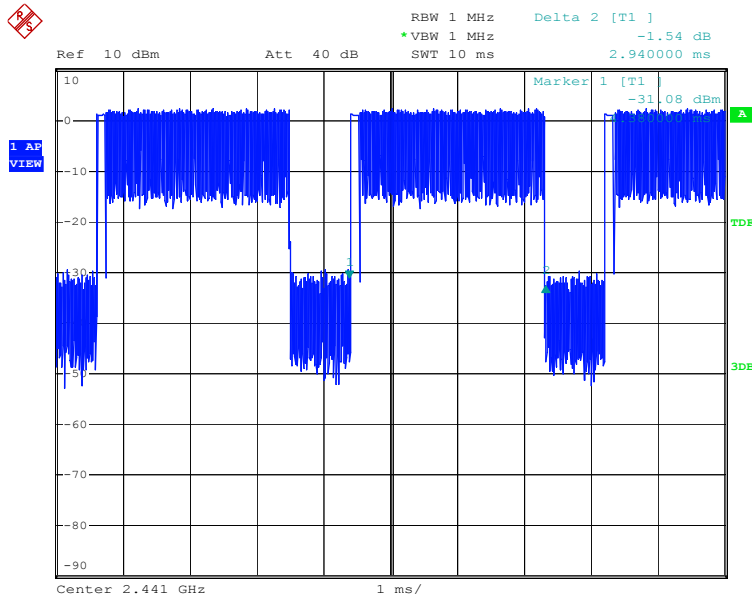

Date: 7.JUL.2018 17:39:31



8-DPSK CH78 3DH1/3DH3/3DH5

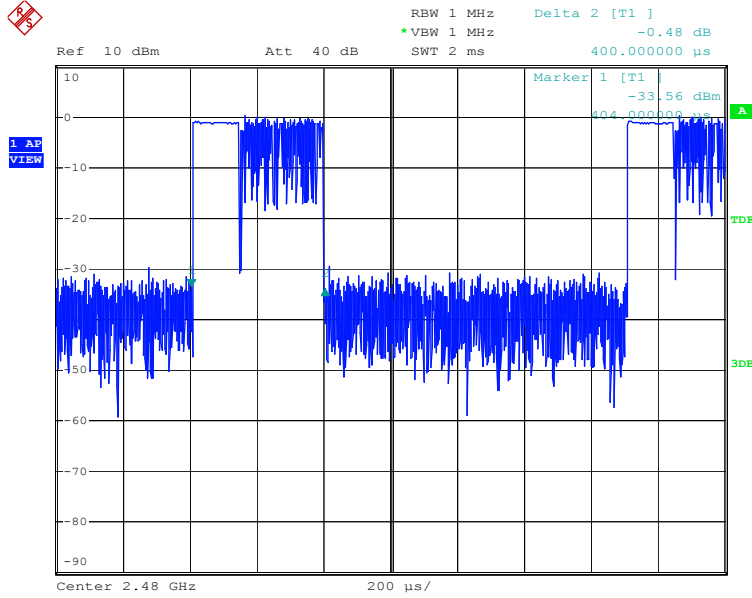

Date: 7.JUL.2018 17:46:23

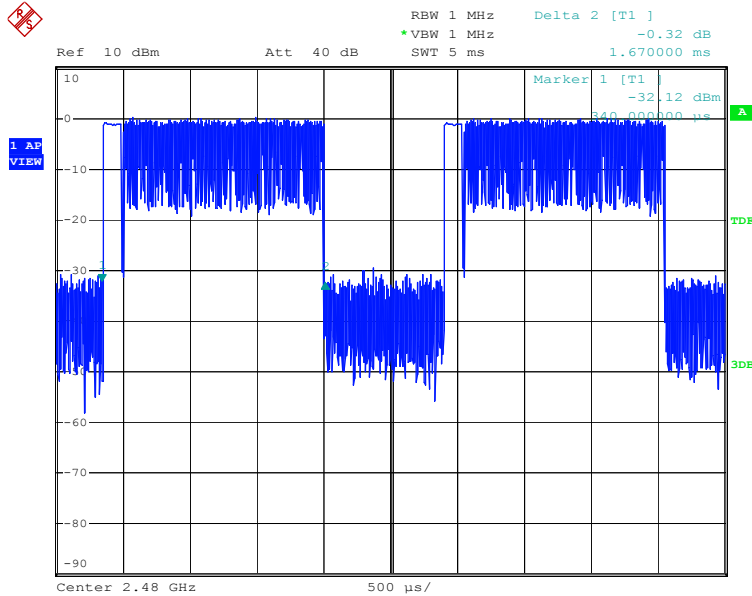

Date: 7.JUL.2018 17:46:50

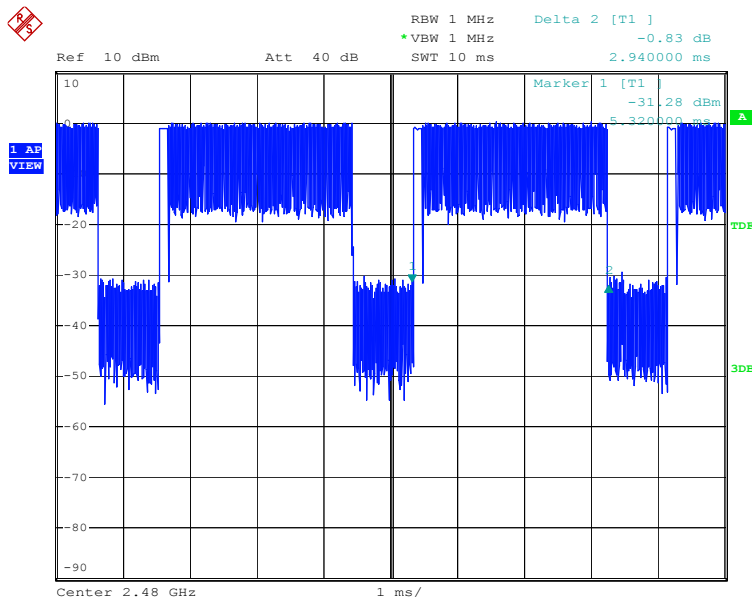

Date: 7.JUL.2018 17:47:15



## 13. Band Edges Measurement

### 13.1 Test Limit

Below -20dB of the highest emission level of operating band (In 100 kHz Resolution Bandwidth)

### 13.2 Test Procedure

- h. The transmitter output was connected to the spectrum analyzer via a low lose cable.
- i. Set RBW of spectrum analyzer to 100 KHz and VBW of spectrum analyzer to 300 KHz with convenient frequency span including 100 KHz bandwidth from band edge.
- j. Peak conducted output power measured within any 100 kHz outside the authorized frequency band shall be attenuated by at least 20dB relative to the maximum measured in-band peak PSD level.
- k. The band edges was measured and recorded.

### 13.3 Test Setup Layout

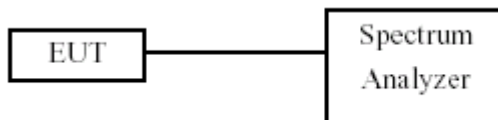



### 13.4 Test Result and Data

Test Date: Jul. 7, 2018

Temperature: 26°C

Atmospheric pressure: 1000hPa

Humidity: 55%

Modulation Standard: GFSK

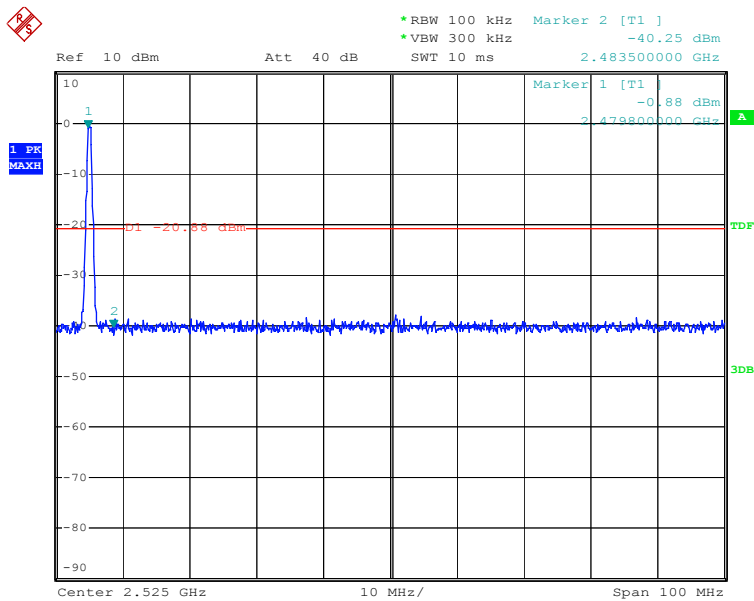
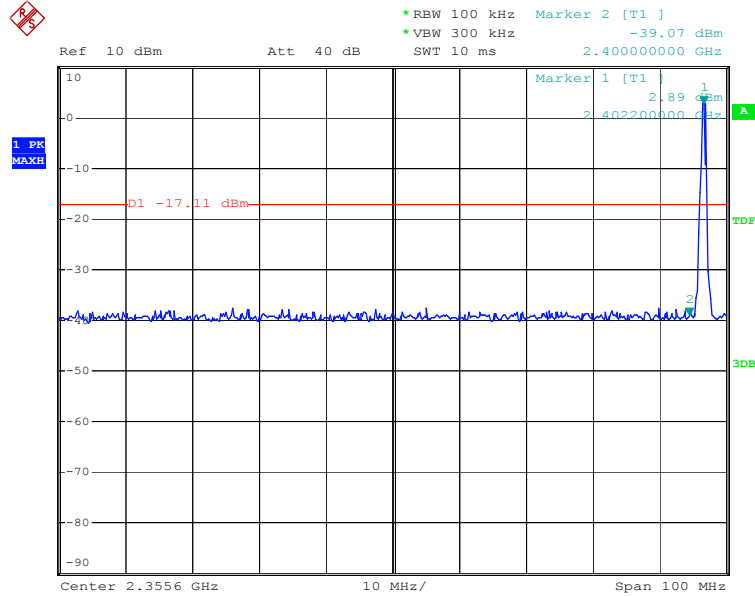

Date: 7.JUL.2018 17:58:27



## Modulation Standard: $\pi/4$ DQPSK

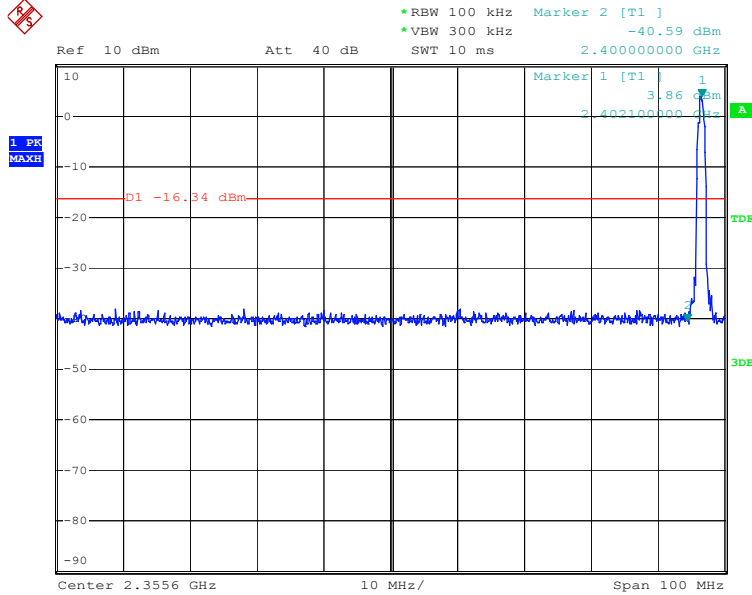

Date: 7.JUL.2018 18:00:07

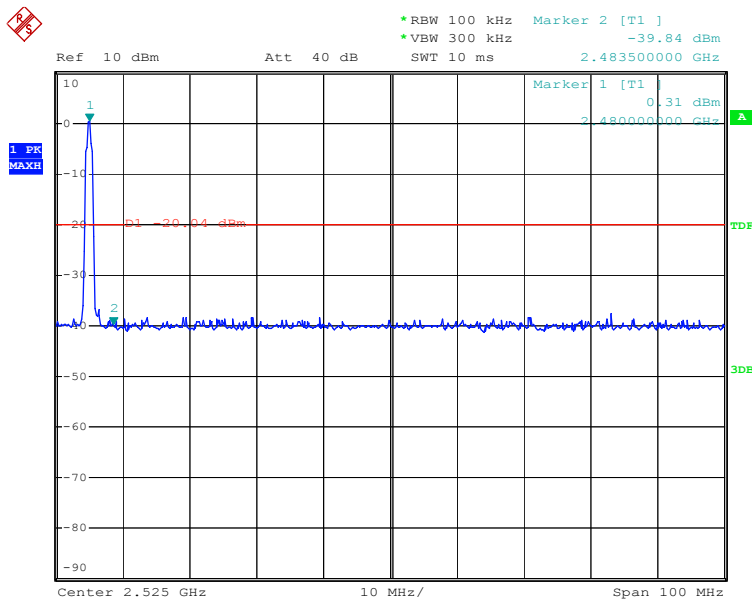

Date: 7.JUL.2018 18:03:07



Modulation Standard: 8-DPSK

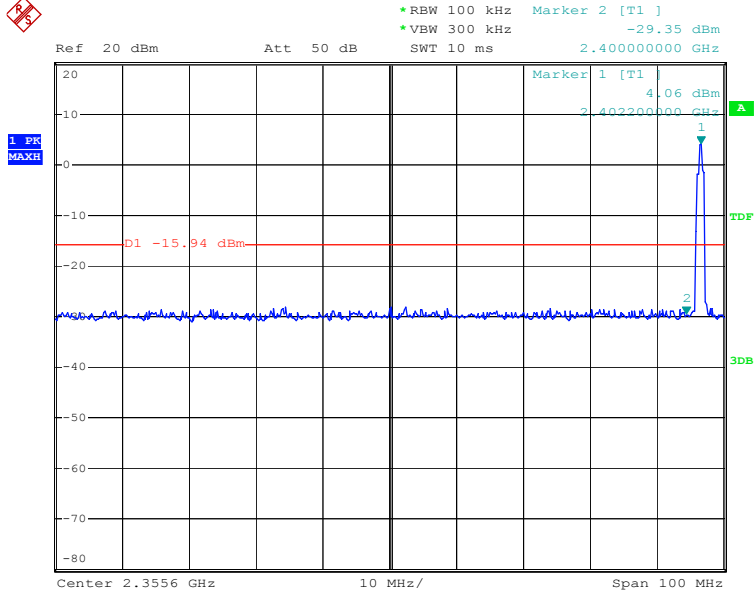

Date: 7.JUL.2018 18:15:52

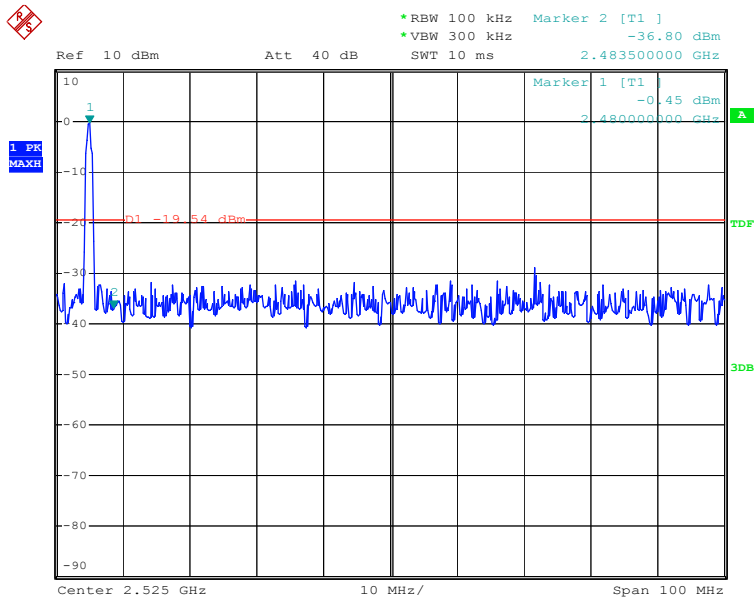

Date: 7.JUL.2018 18:17:29





## Hopping

Modulation Standard: GFSK

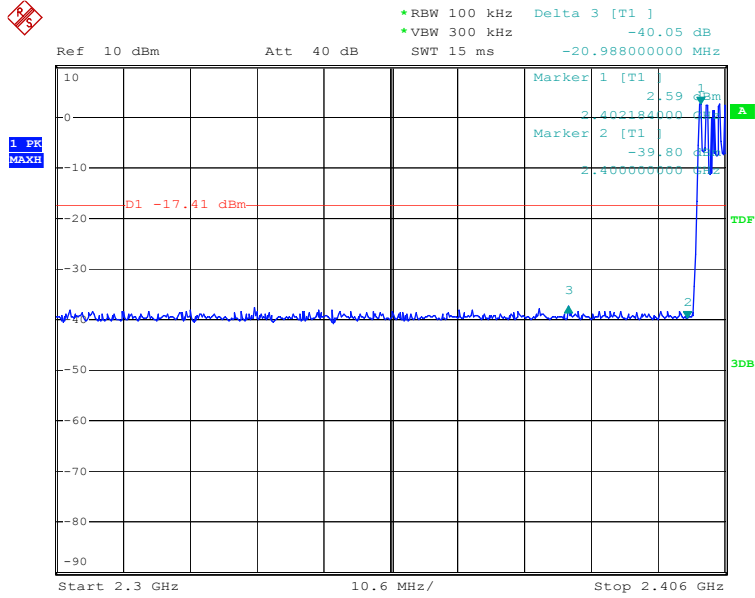

Date: 7.JUL.2018 18:25:59

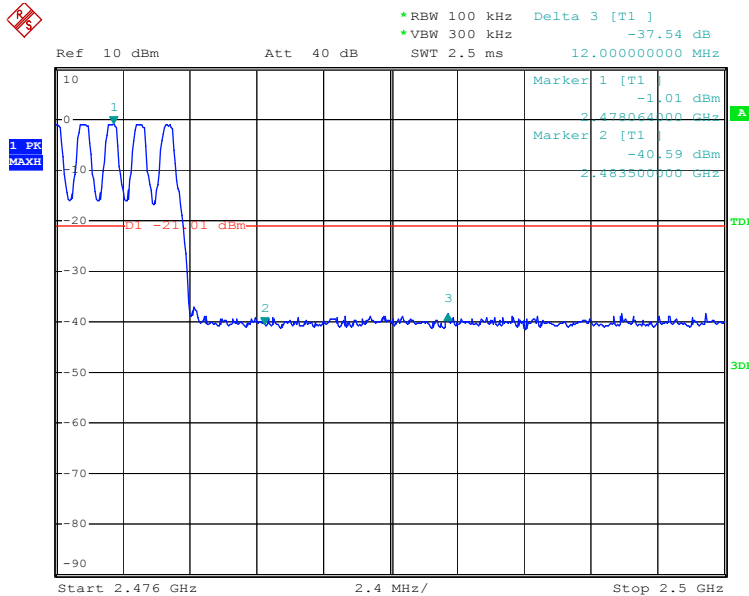

Date: 7.JUL.2018 18:28:51



## Modulation Standard: $\pi/4$ DQPSK

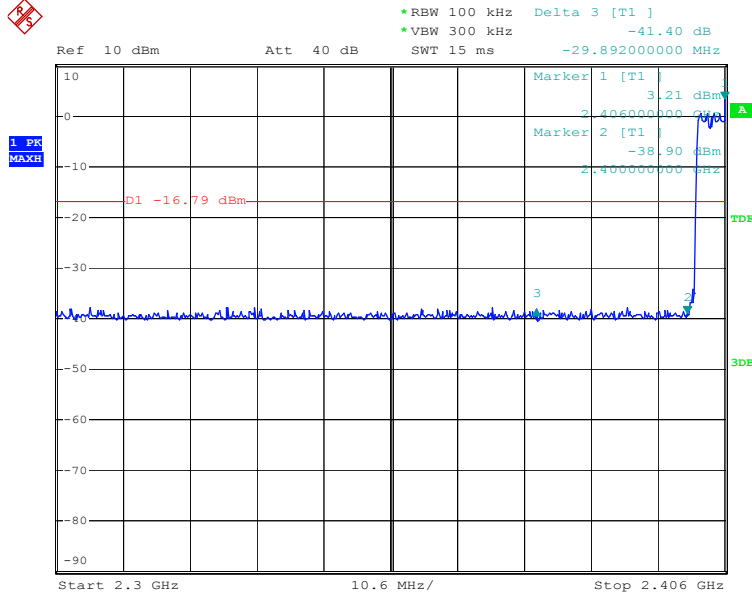

Date: 7.JUL.2018 18:31:07

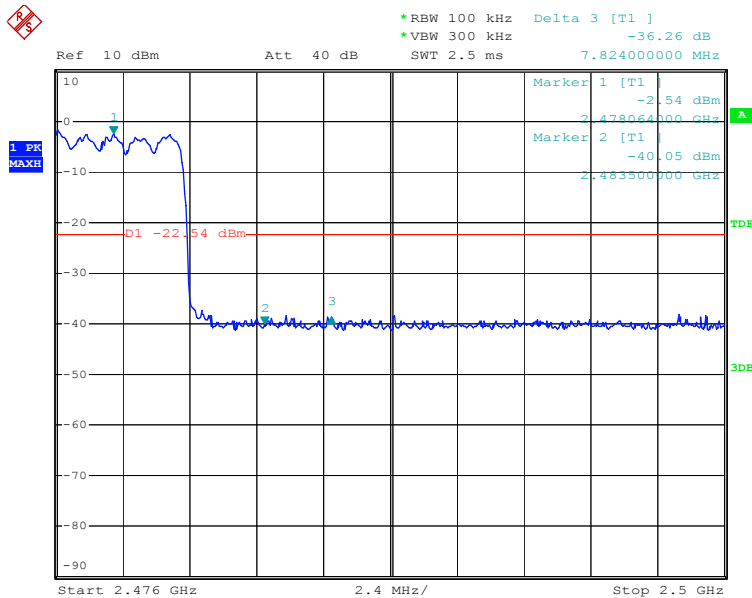

Date: 7.JUL.2018 18:32:43



## Modulation Standard: 8-DPSK

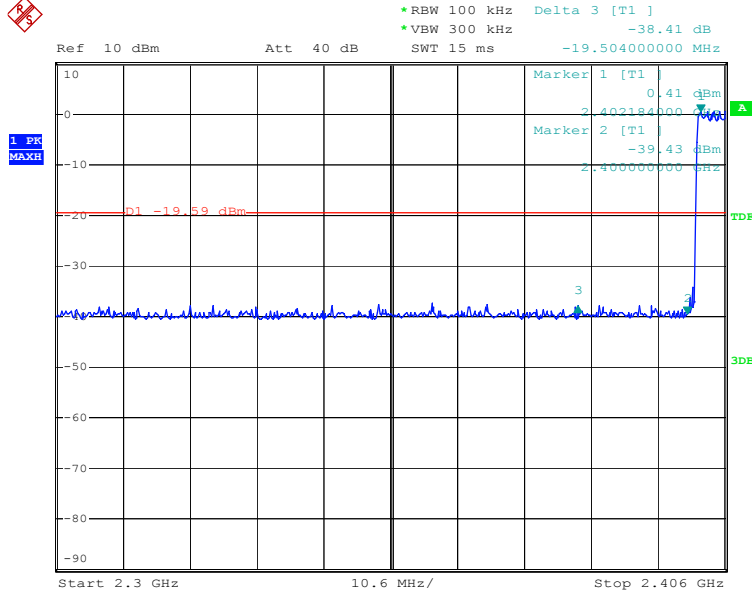

Date: 7.JUL.2018 18:34:18

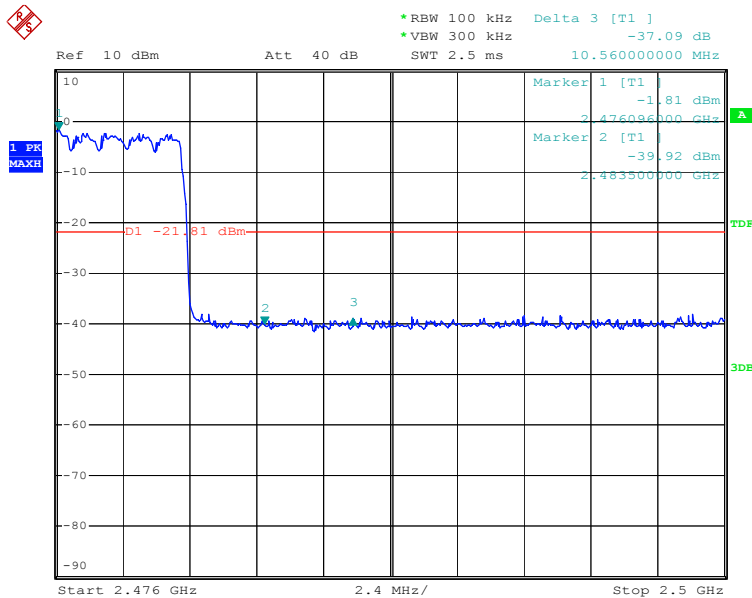

Date: 7.JUL.2018 18:36:04



## 14. Restricted Bands of Operation

Only spurious emissions are permitted in any of the frequency bands listed below:

MHz	MHz	MHz	GHz
0.09000 – 0.11000	16.42000 – 16.42300	399.9 – 410.0	4.500 – 5.150
0.49500 – 0.505**	16.69475 – 16.69525	608.0 – 614.0	5.350 – 5.460
2.17350 – 2.19050	16.80425 – 16.80475	960.0 – 1240.0	7.250 – 7.750
4.12500 – 4.12800	25.50000 – 25.67000	1300.0 – 1427.0	8.025 – 8.500
4.17725 – 4.17775	37.50000 – 38.25000	1435.0 – 1626.5	9.000 – 9.200
4.20725 – 4.20775	73.00000 – 74.60000	1645.5 – 1646.5	9.300 – 9.500
6.21500 – 6.21800	74.80000 – 75.20000	1660.0 – 1710.0	10.600 – 12.700
6.26775 – 6.26825	108.00000 – 121.94000	1718.8 – 1722.2	13.250 – 13.400
6.31175 – 6.31225	123.00000 – 138.00000	2200.0 – 2300.0	14.470 – 14.500
8.29100 – 8.29400	149.90000 – 150.05000	2310.0 – 2390.0	15.350 – 16.200
8.36200 – 8.36600	156.52475 – 156.52525	2483.5 – 2500.0	17.700 – 21.400
8.37625 – 8.38675	156.70000 – 156.90000	2655.0 – 2900.0	22.010 – 23.120
8.41425 – 8.41475	162.01250 – 167.17000	3260.0 – 3267.0	23.600 – 24.000
12.29000 – 12.29300	167.72000 – 173.20000	3332.0 – 3339.0	31.200 – 31.800
12.51975 – 12.52025	240.00000 – 285.00000	3345.8 – 3358.0	36.430 – 36.500
12.57675 – 12.57725	322.00000 – 335.40000	3600.0 – 4400.0	Above 38.6
13.36000 – 13.41000			

\*\* : Until February 1, 1999, this restricted band shall be 0.490-0.510 MHz

### 14.1 Labeling Requirement

The device shall bear the following statement in a conspicuous location on the device:

This device complies with part 15 of the FCC Rules. Operation is subject to the following two conditions: (1) This device may not cause harmful interference, and (2) this device must accept any interference received, including interference that may cause undesired operation.



## 15. Conducted Spurious Emissions

### 15.1 Applied procedures / Limit

15.247(d) In any 100 kHz bandwidth outside the frequency band in which the spread spectrum or digitally modulated intentional radiator is operating, the radio frequency power that is produced by the intentional radiator shall be at least 20 dB below that in the 100 kHz bandwidth within the band that contains the highest level of the desired power, based on either an RF conducted or a radiated measurement, provided the transmitter demonstrates compliance with the peak conducted power limits. If the transmitter complies with the conducted power limits based on the use of RMS averaging over a time interval, as permitted under paragraph (b)(3) of this section, the attenuation required under this paragraph shall be 30 dB instead of 20 dB. Attenuation below the general limits specified in Section 15.209(a) is not required. In addition, radiated emissions which fall in the restricted bands, as defined in Section 15.205(a), must also comply with the radiated emission limits specified in Section 15.209(a) (see Section 15.205(c)).

### 15.2 Test procedure

- a. The EUT was directly connected to the spectrum analyzer and antenna output port as show in the block diagram below.
- b. Span = wide enough to capture the peak level of the in-band emission and all spurious emissions (e.g., harmonics) from the lowest frequency generated in the EUT up through the 10<sup>th</sup> harmonic. Typically, several plots are required to cover this entire span. RBW = 100 kHz  
VBW ≥ RBW, Sweep = auto, Detector function = peak, Trace = max hold  
sweep points ≥ investigated frequency range/RBW.

### 15.3 Deviation from standard

No deviation.

### 15.4 Test setup

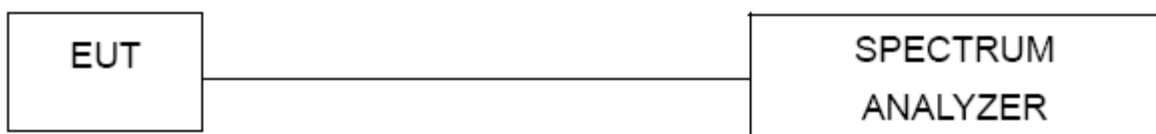



15.5 Test results

GFSK CH00 Data rate 1Mbps

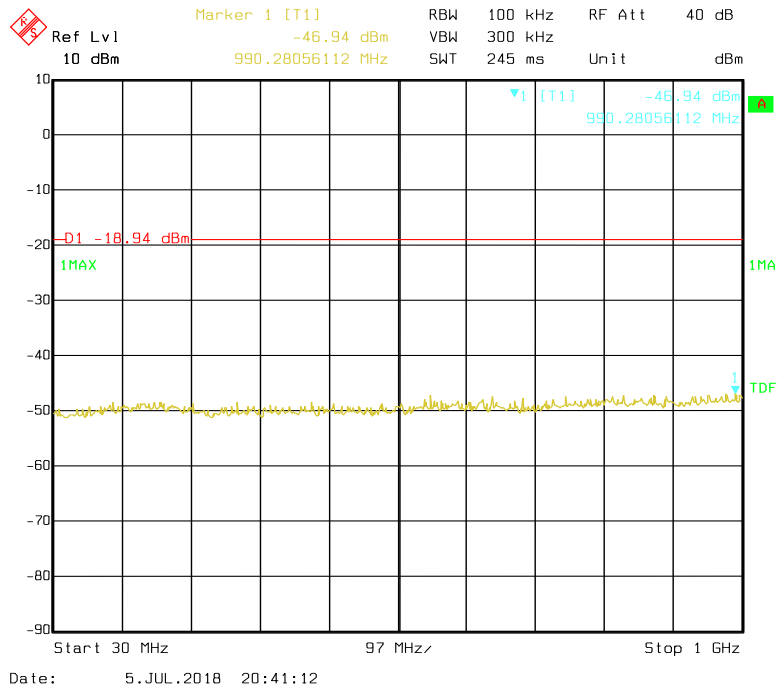

GFSK CH00 Data rate 1Mbps

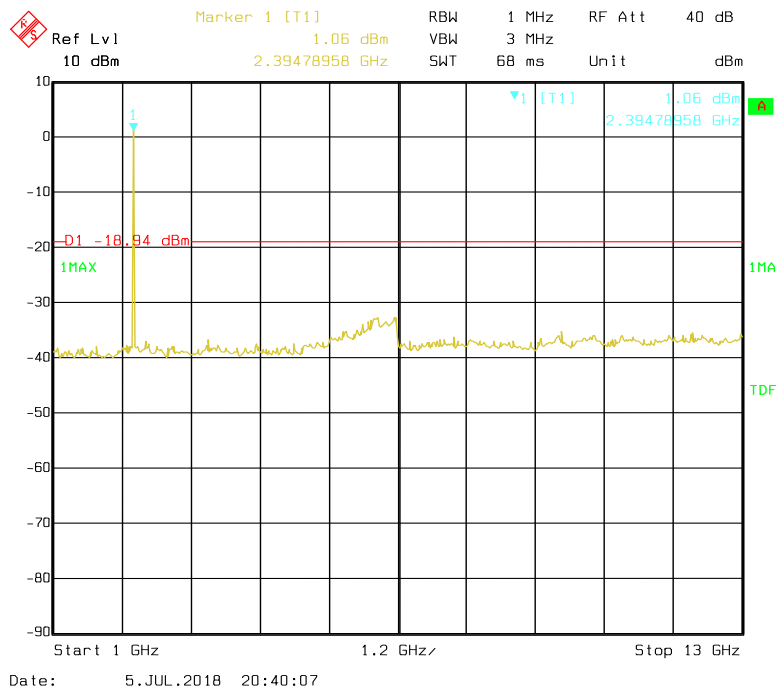



### GFSK CH00 Data rate 1Mbps

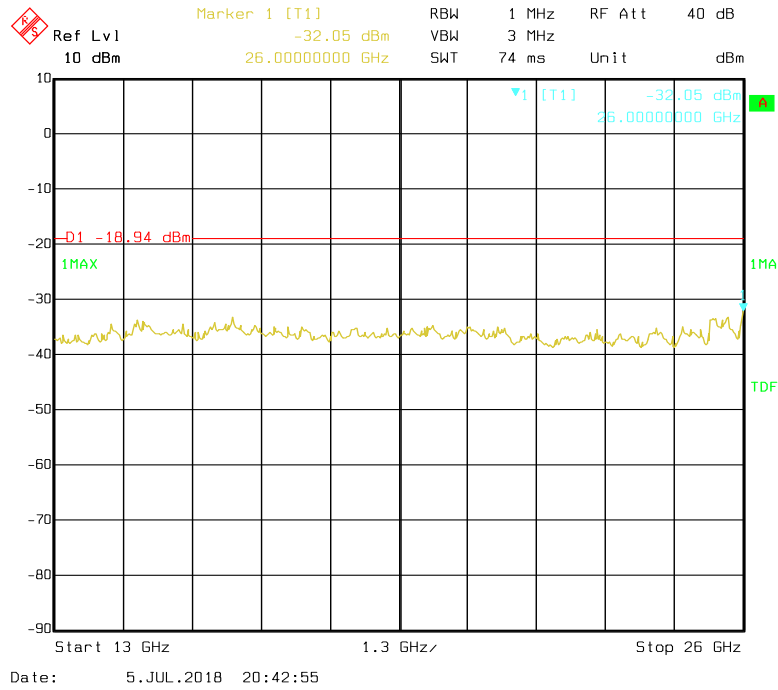

### GFSK CH39 Data rate 1Mbps

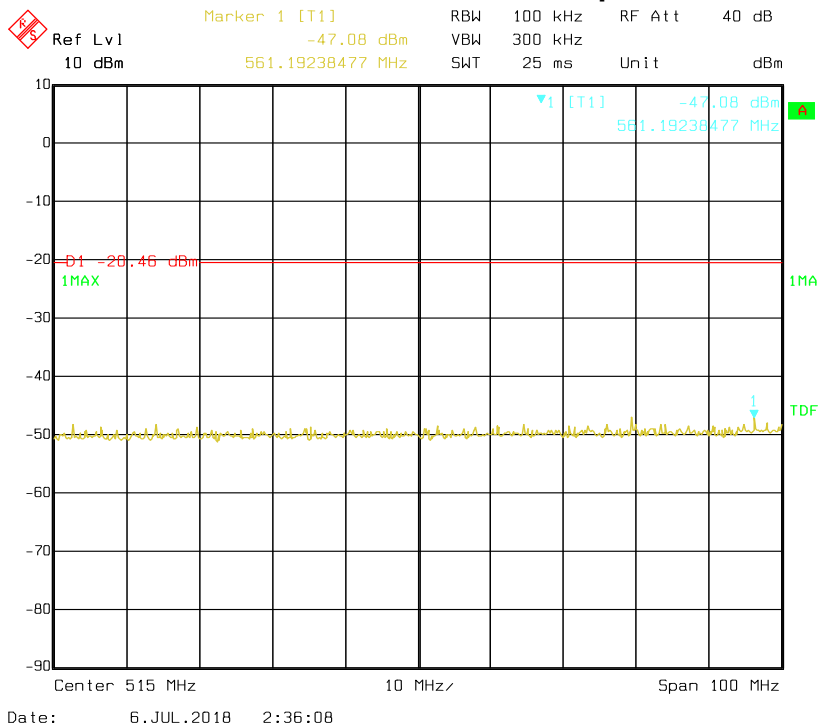



## GFSK CH39 Data rate 1Mbps

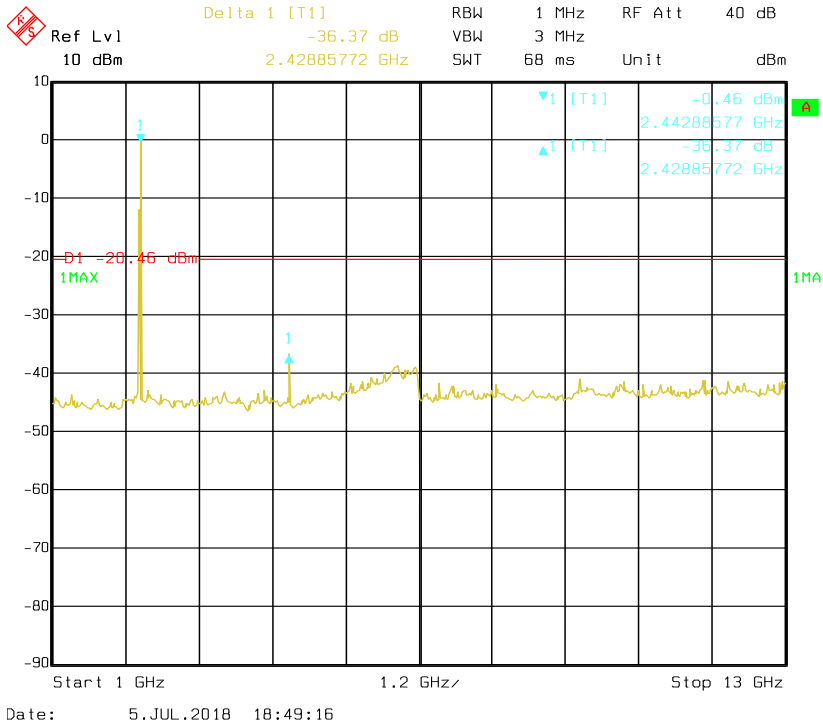

## GFSK CH39 Data rate 1Mbps

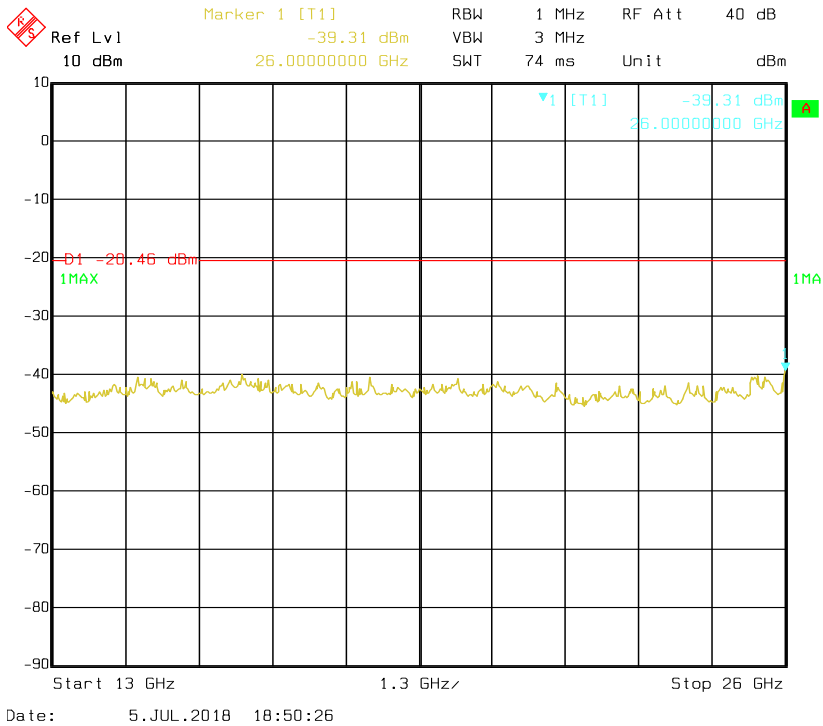





### GFSK CH78 Data rate 1Mbps

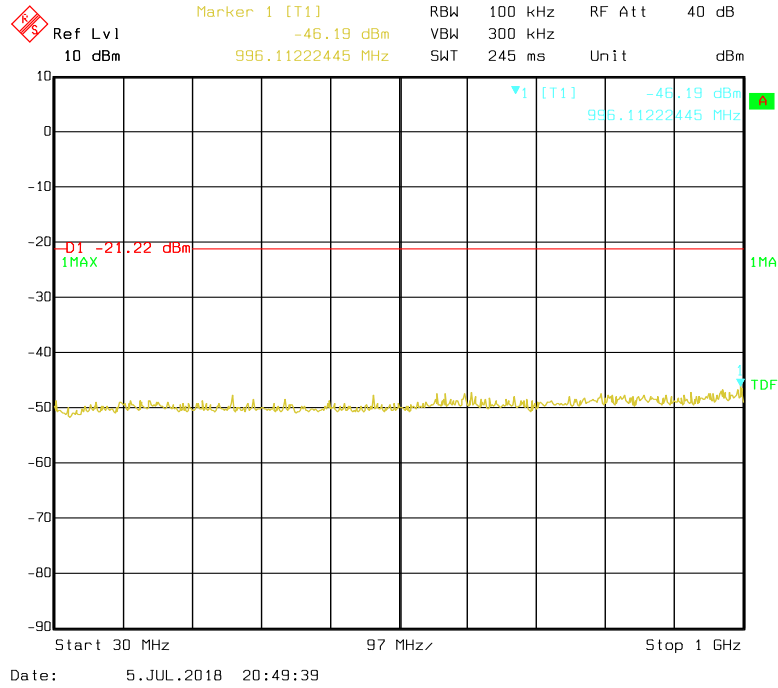

### GFSK CH78 Data rate 1Mbps

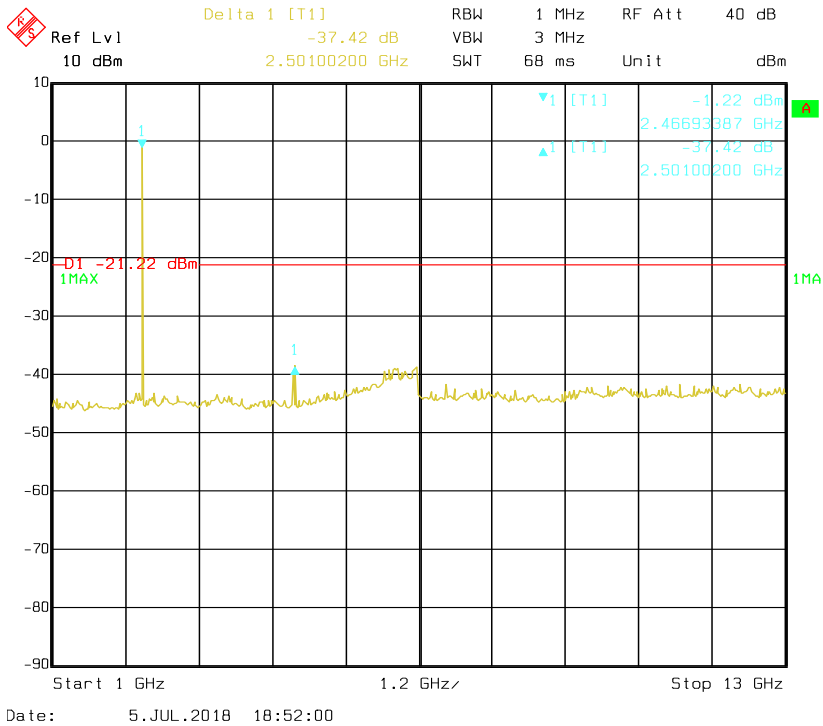



## GFSK CH78 Data rate 1Mbps

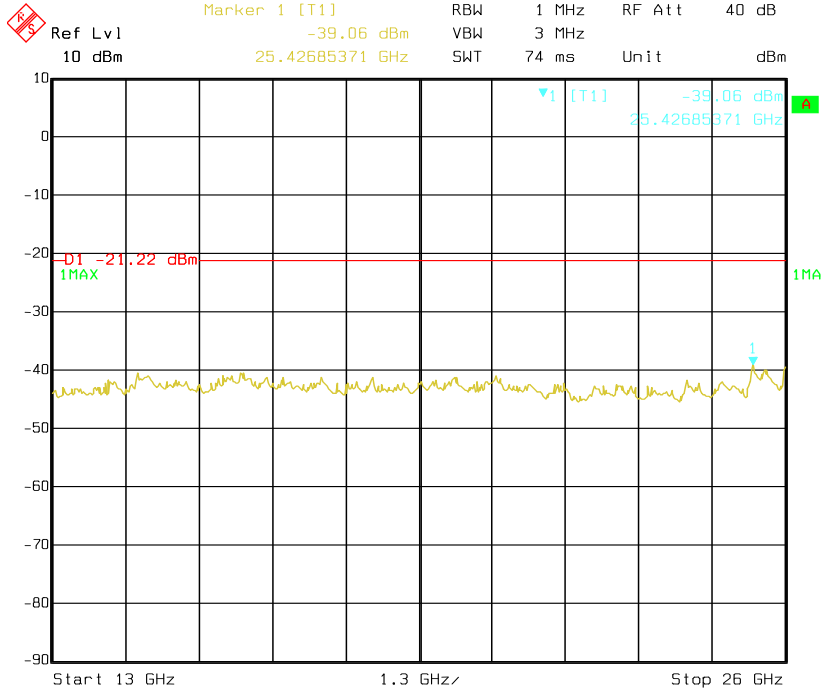

Date: 5.JUL.2018 18:53:07

## $\pi/4$ DQPSK CH00 Data rate 2Mbps

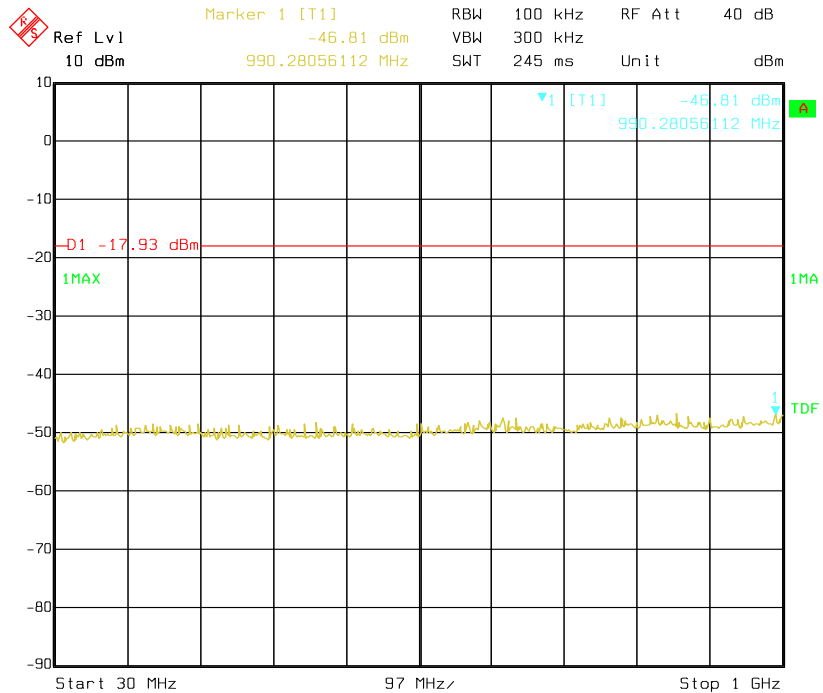

Date: 5.JUL.2018 20:51:10



**$\pi/4$  DQPSK CH00 Data rate 2Mbps**

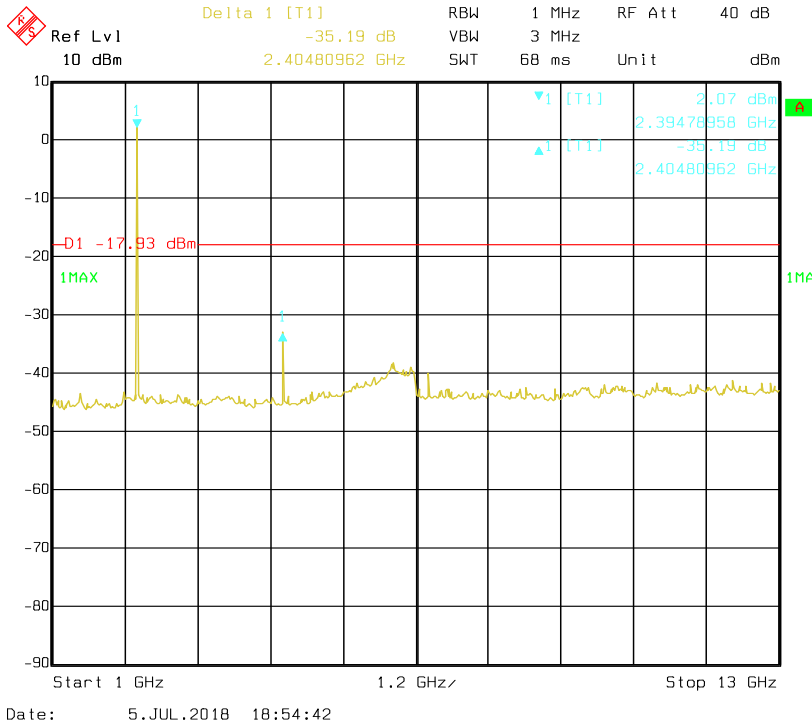

**$\pi/4$  DQPSK CH00 Data rate 2Mbps**

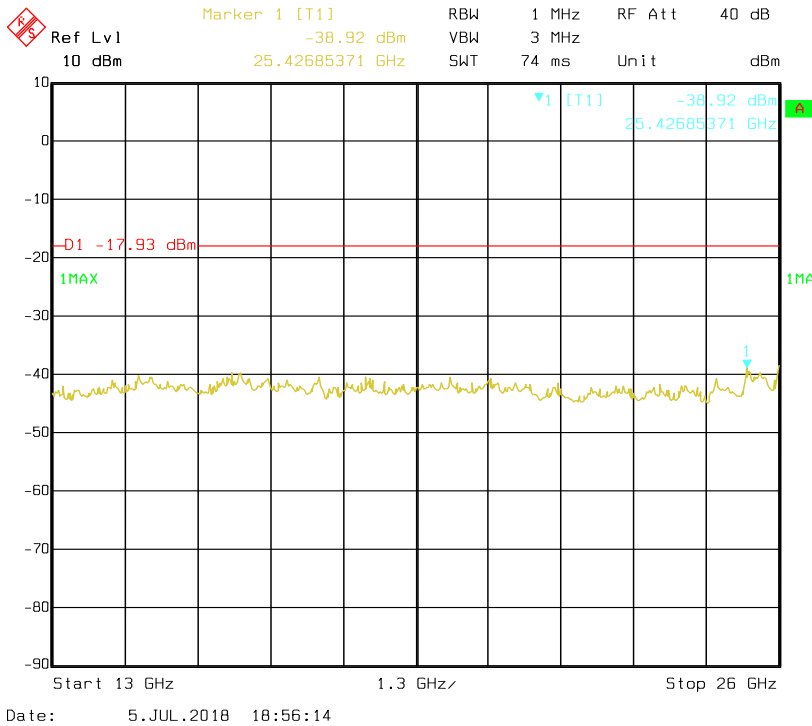



## $\pi/4$ DQPSK CH39 Data rate 2Mbps

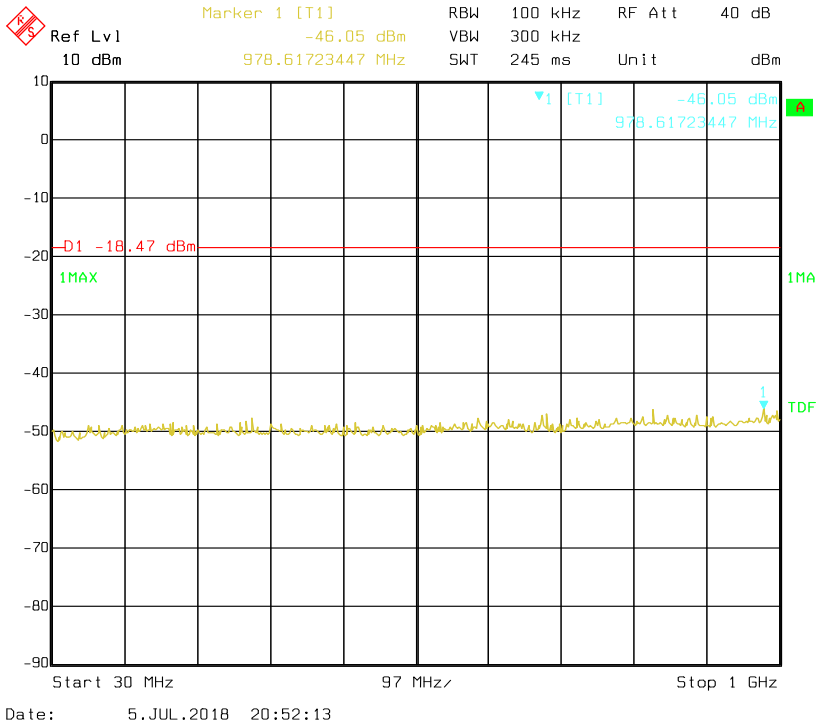

## $\pi/4$ DQPSK CH39 Data rate 2Mbps

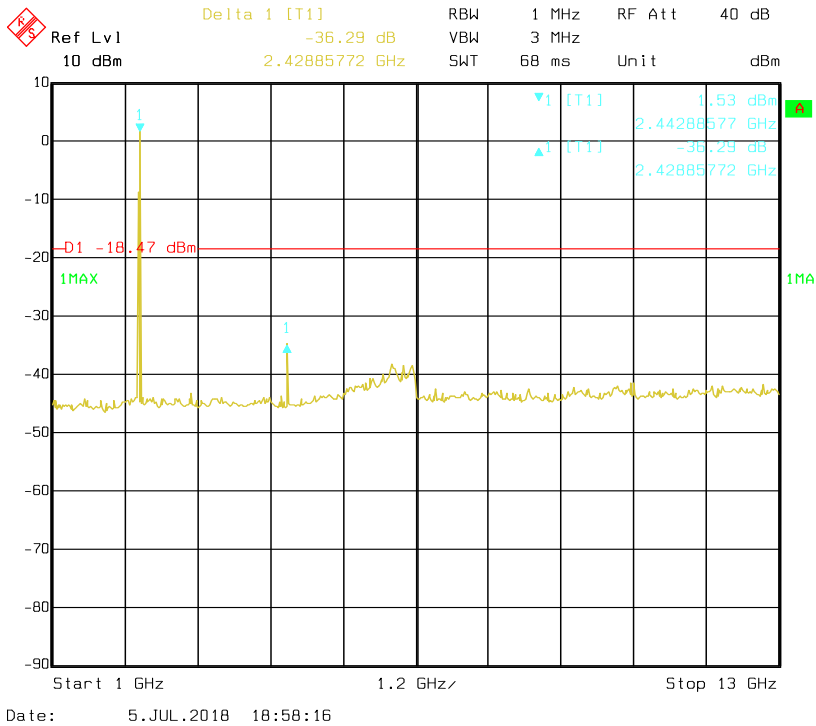



### $\pi/4$ DQPSK CH39 Data rate 2Mbps

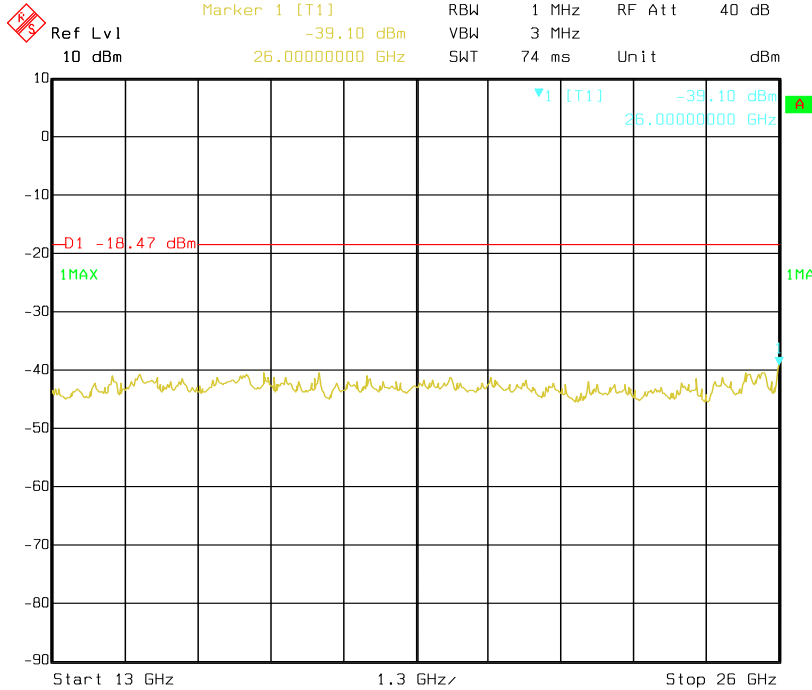

Date: 5.JUL.2018 18:59:28

### $\pi/4$ DQPSK CH78 Data rate 2Mbps

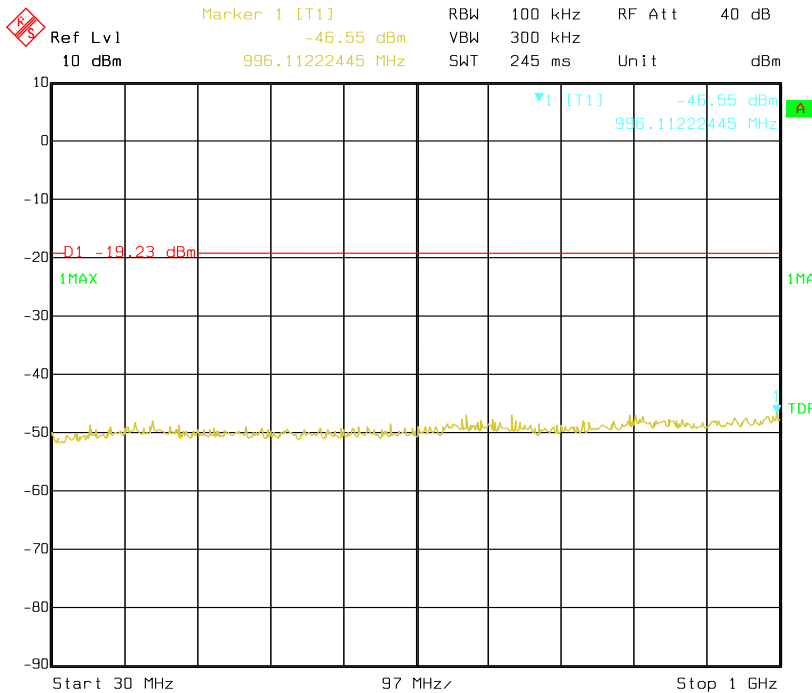

Date: 5.JUL.2018 20:53:22



### $\pi/4$ DQPSK CH78 Data rate 2Mbps

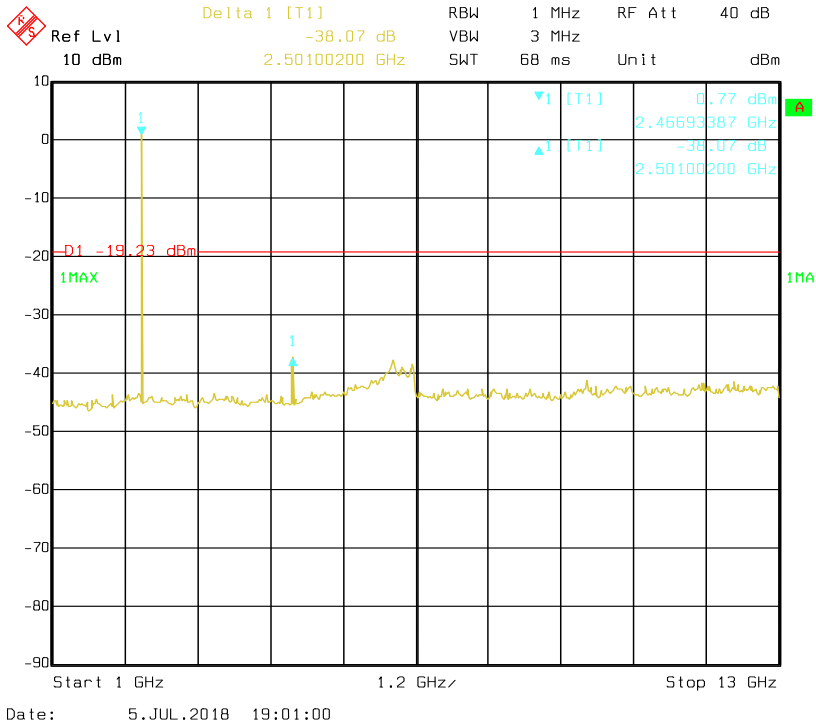

### $\pi/4$ DQPSK CH78 Data rate 2Mbps

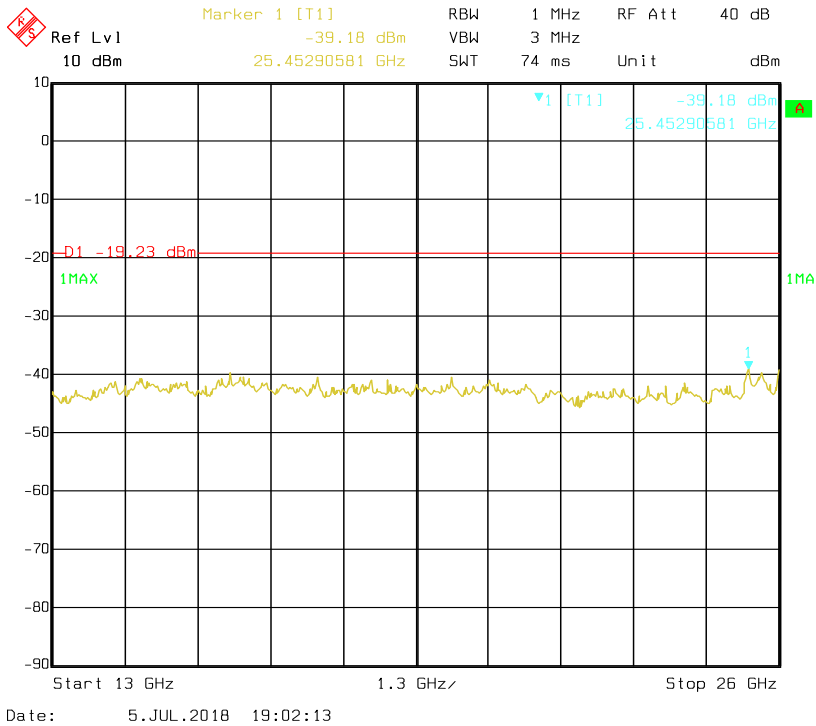



## 8-DPSK CH00 Data rate 3Mbps

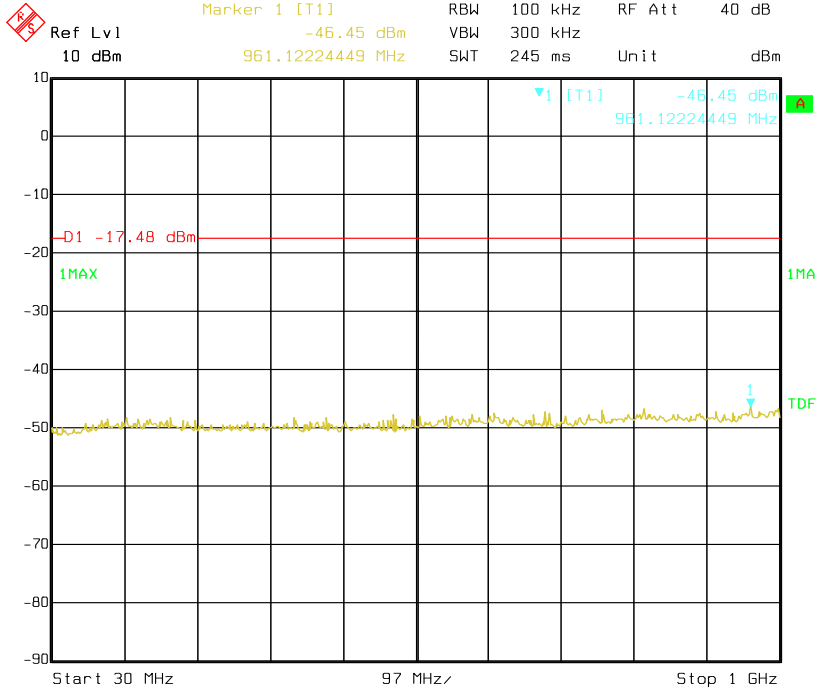

Date: 5.JUL.2018 20:58:44

## 8-DPSK CH00 Data rate 3Mbps

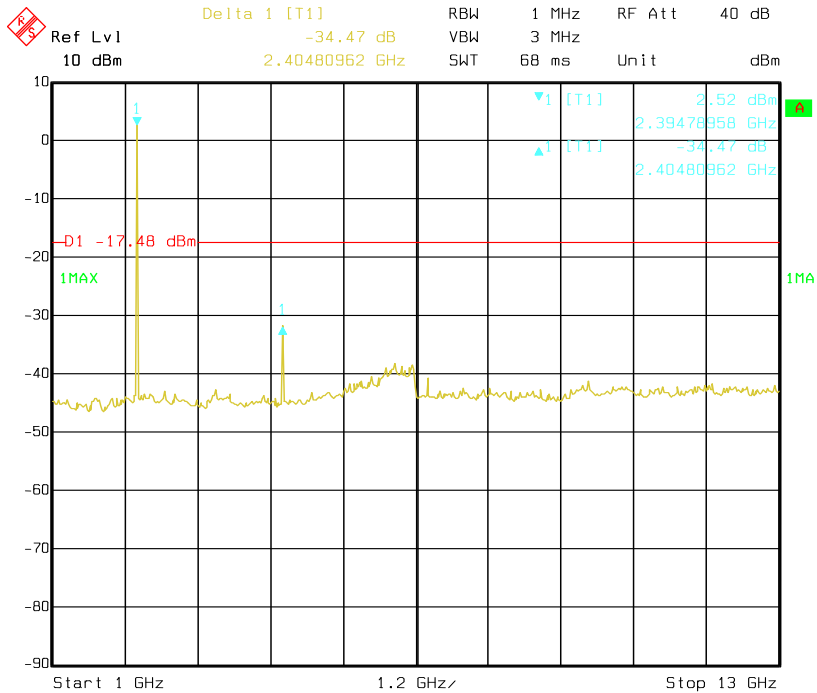

Date: 5.JUL.2018 19:03:56



## 8-DPSK CH00 Data rate 3Mbps

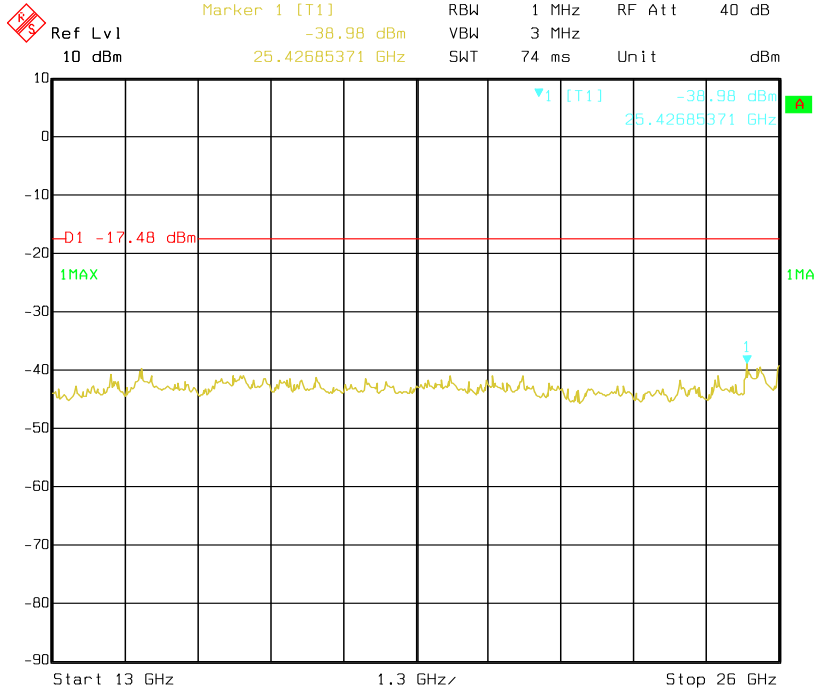

Date: 5.JUL.2018 19:05:02

## 8-DPSK CH39 Data rate 3Mbps

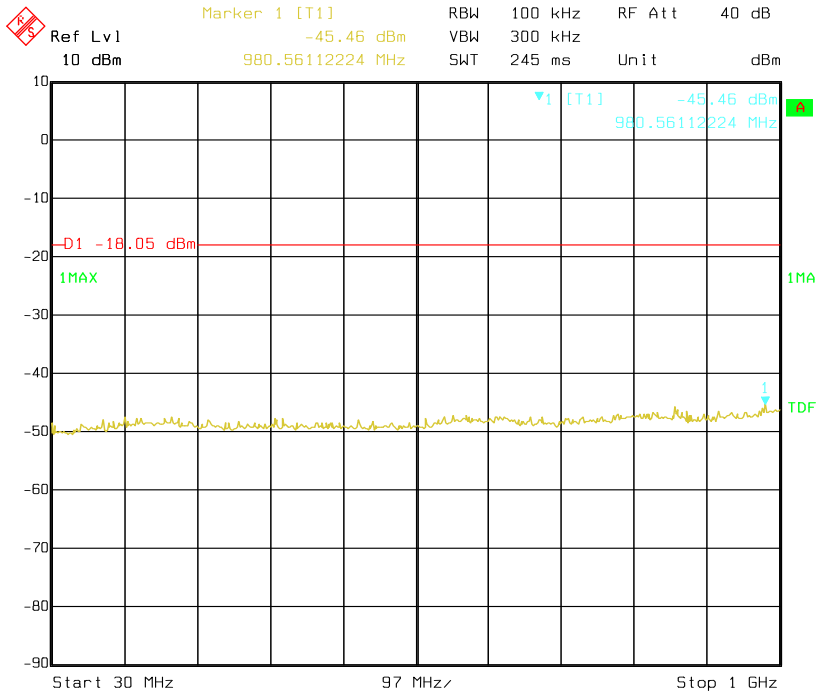

Date: 5.JUL.2018 21:02:58





### 8-DPSK CH39 Data rate 3Mbps

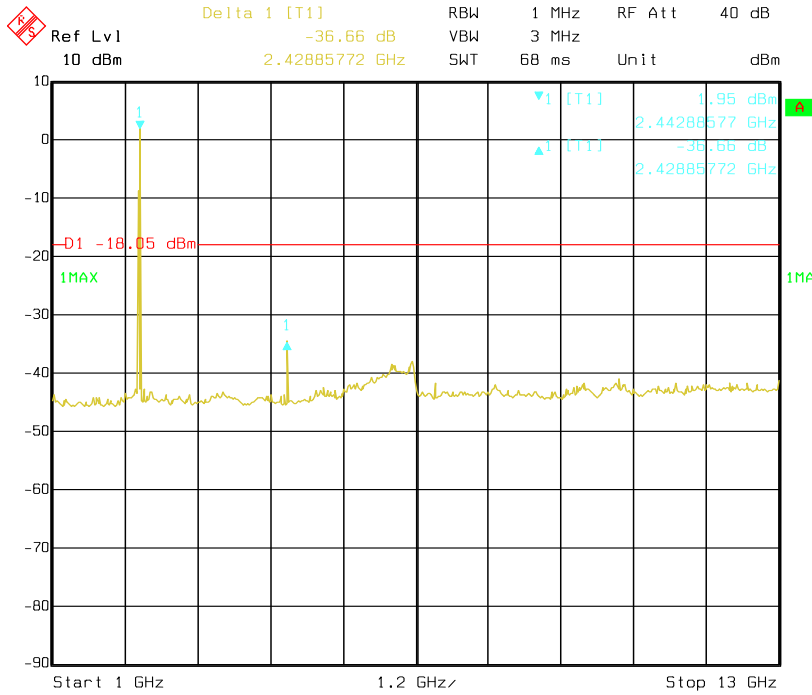

Date: 5.JUL.2018 19:09:24

### 8-DPSK CH39 Data rate 3Mbps

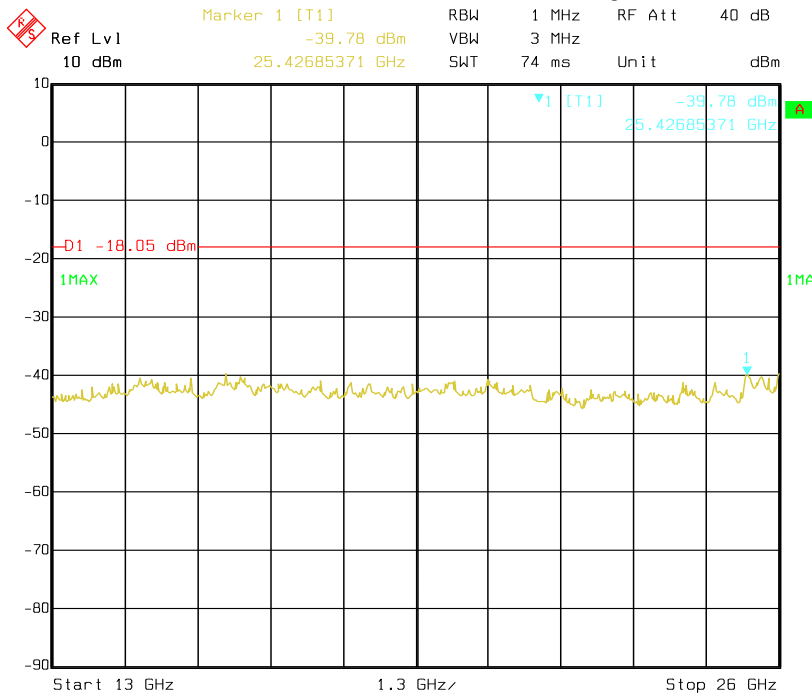

Date: 5.JUL.2018 19:10:49



## 8-DPSK CH78 Data rate 3Mbps

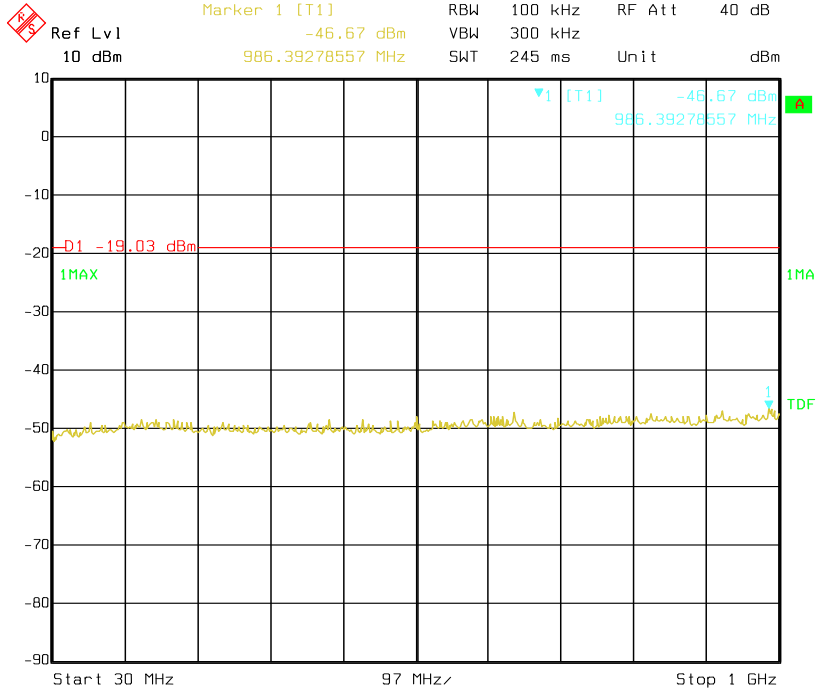

Date: 5.JUL.2018 21:07:29

## 8-DPSK CH78 Data rate 3Mbps

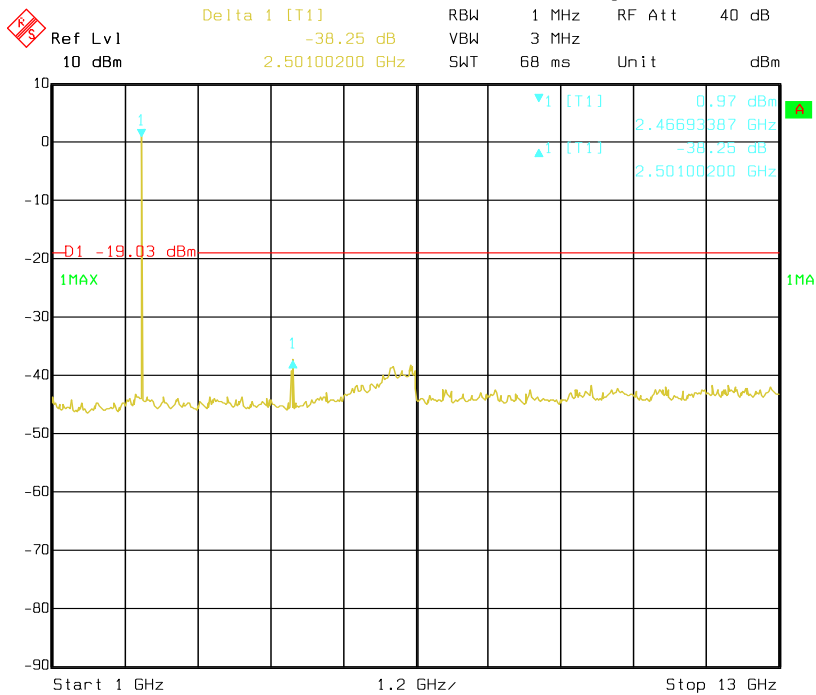

Date: 5.JUL.2018 19:12:14



8-DPSK CH78 Data rate 3Mbps

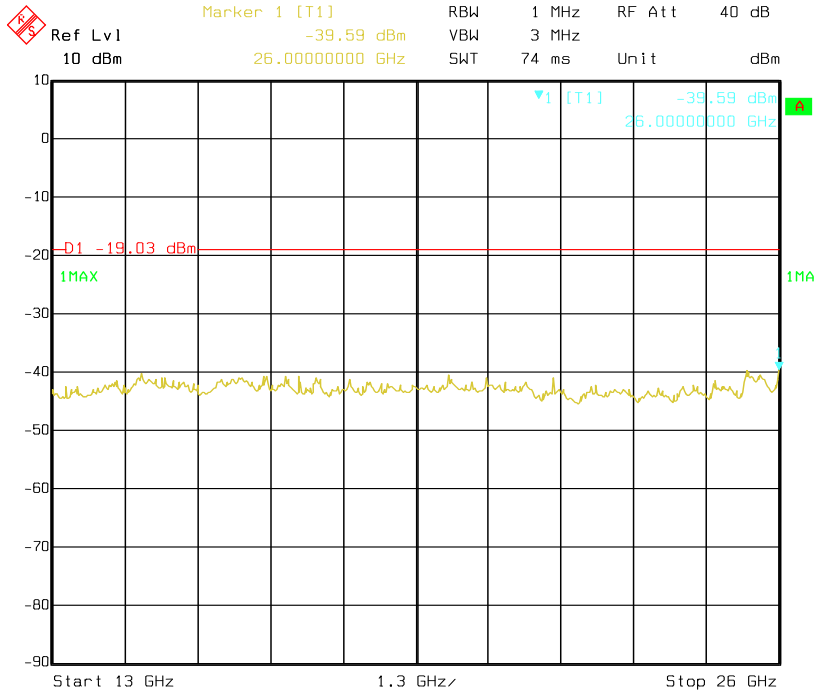

Date: 5.JUL.2018 19:13:34



---

**APPENDIX 1 PHOTOS OF TEST CONFIGURATION**

**Radiated Spurious Emission Test Setup**

**1GHz below**



**1GHz above**





**Conducted Emission Test Setup**





**PHOTOS OF EUT**

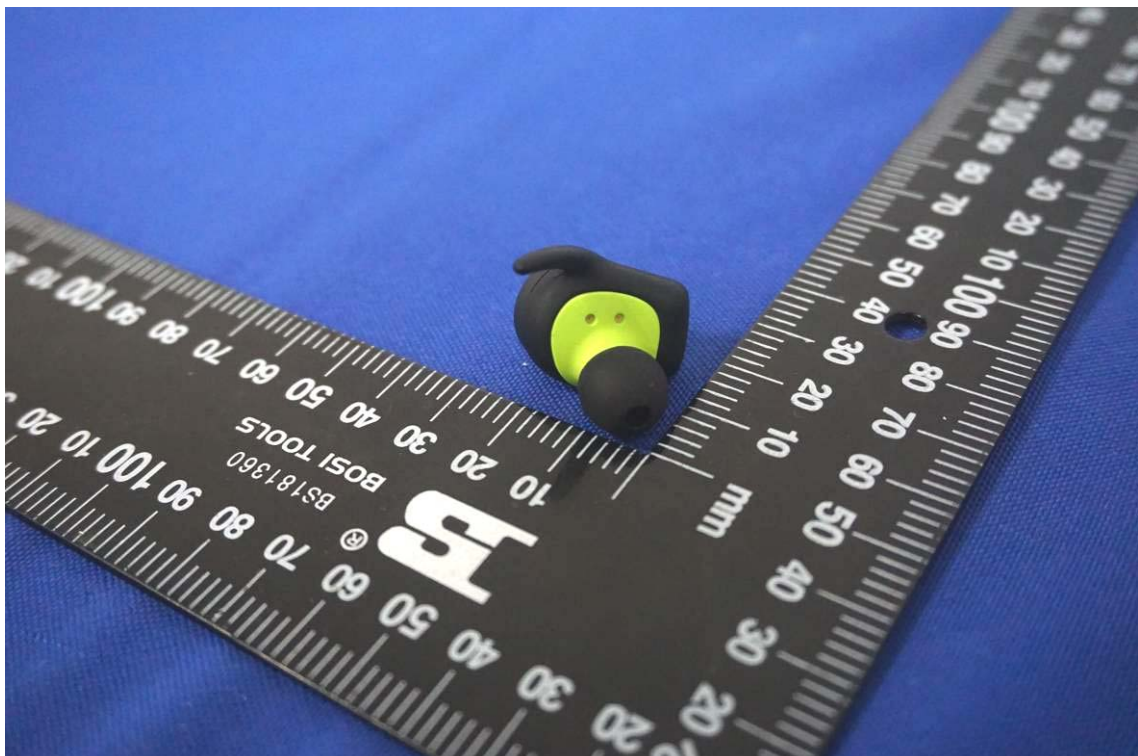
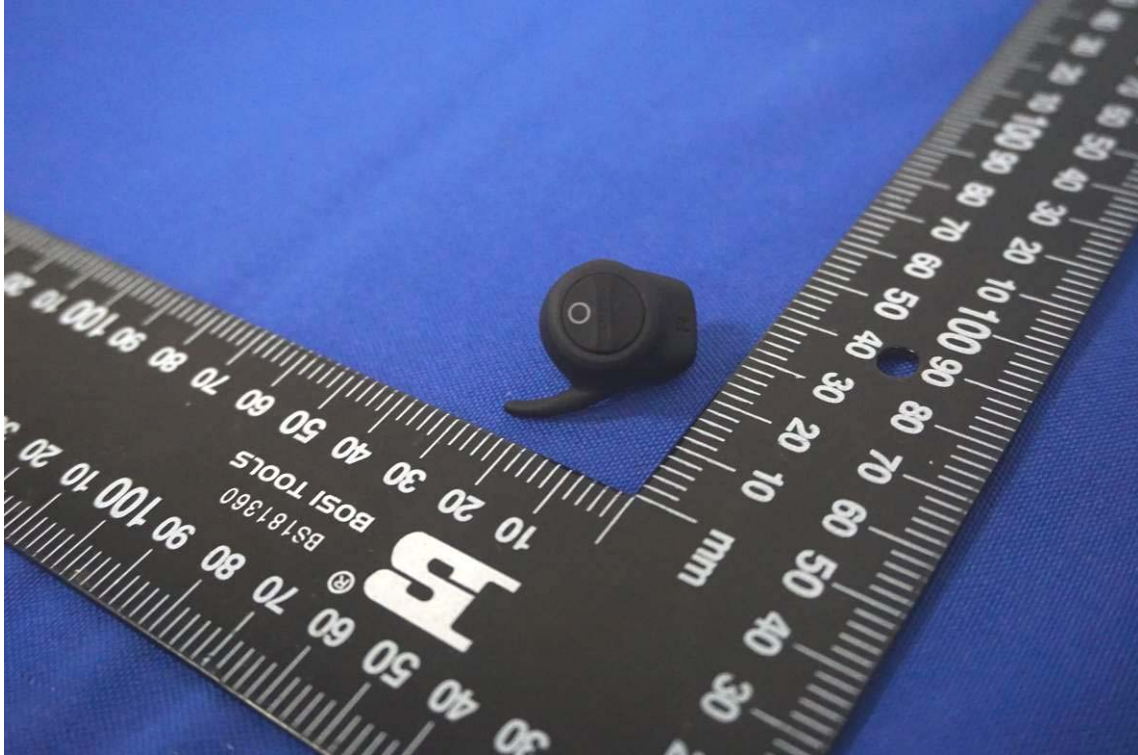

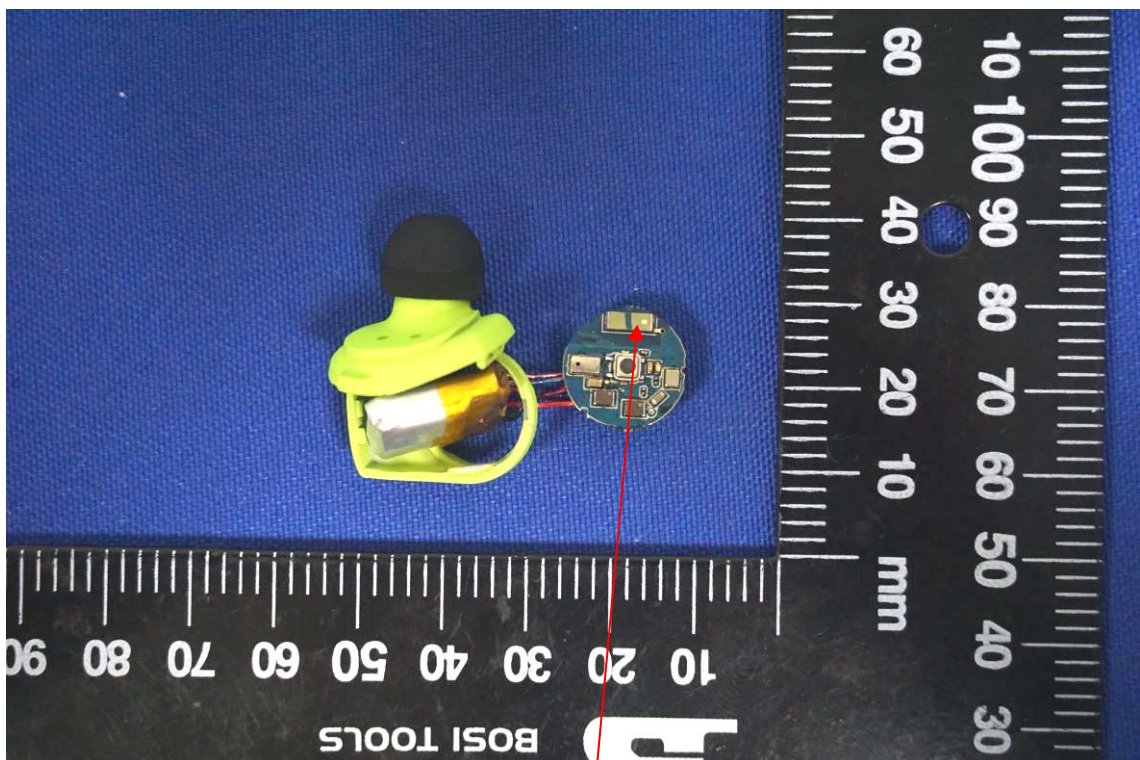

Antenna

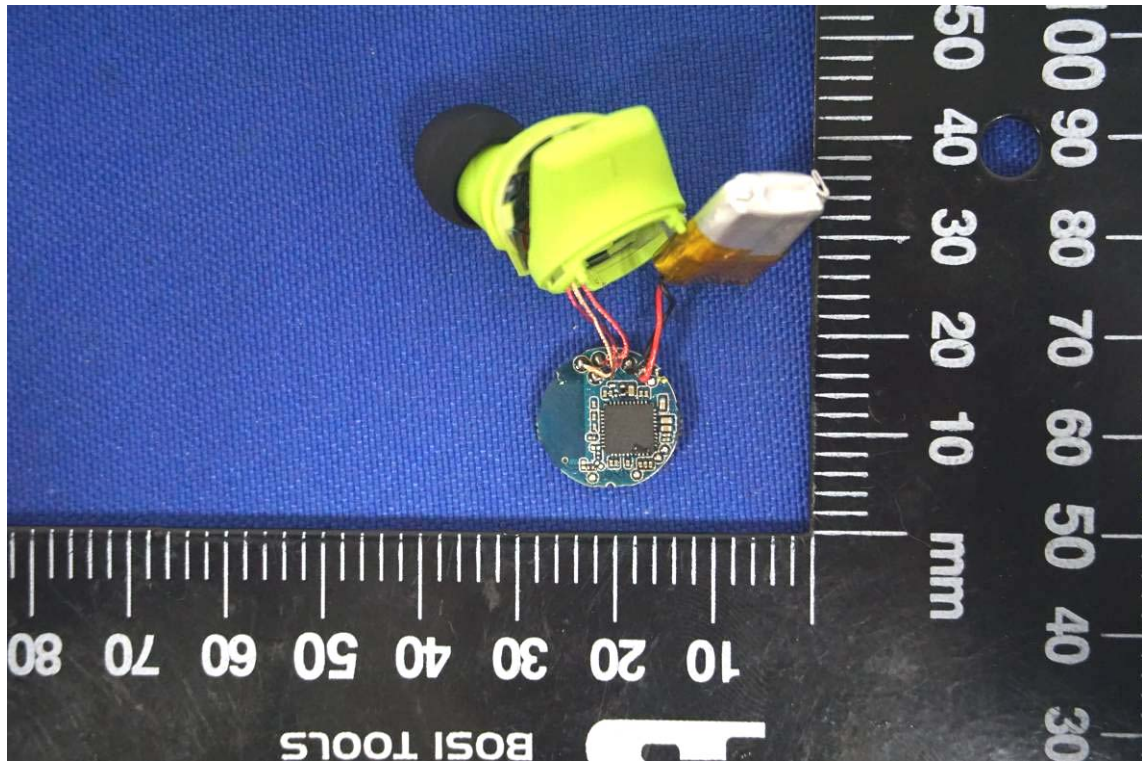

**\*\* End of report \*\***