

# FCC Radio Test Report

## FCC ID: 2AFAX-BLANC

### The report concerns: Original Grant

Report Reference No.....: 21EFSS11038 09781

Date Sample(s) Received.....: 2021-11-10

Date of Tested.....: From 2021-11-11 to 2021-11-20

Date of issue.....: 2021-11-23

Testing Laboratory .....: DongGuan ShuoXin Electronic Technology Co., Ltd.  
Zone A, 1F, No. 6, XinGang Road YuanGang Street,  
Address .....: XinAn District, ChangAn Town, DongGuan City,  
GuangDong, China

Applicant's name .....: BOOMPODS (HK) LTD.  
Address .....: RM 303 Hankow Centre 5-15, Hankow Road  
T.S.T.Kowloon, HONG KONG.

Manufacturer.....: Dongguan Linyar Technology Co., Ltd.

Equipment.....: tws earphones

Trade Mark .....: BOOMPODS

Model .....: BASSLINE

Ratings .....: I/P: 5Vdc  
O/P: --

Test Engineer:  
  
Blue Qiu

Responsible Engineer :  
  
Smile Wang

Authorized Signatory:  
  
King Wang

## Table of Contents

	Page
<b>1 TEST REPORT DECLARE</b>	4
<b>2 SUMMARY OF TEST RESULTS</b>	5
2.1 MEASUREMENT UNCERTAINTY	6
<b>3 GENERAL INFORMATION</b>	7
3.1 GENERAL DESCRIPTION OF EUT	7
3.2 DESCRIPTION OF TEST MODES	9
3.3 PARAMETERS OF TEST SOFTWARE	10
3.4 BLOCK DIAGRAM SHOWING THE CONFIGURATION OF SYSTEM TESTED	10
3.5 SUPPORT UNITS	10
3.6 TEST ENVIRONMENT CONDITIONS	11
<b>4 AC POWER LINE CONDUCTED EMISSIONS TEST</b>	12
4.1 LIMIT	12
4.2 TEST PROCEDURE	12
4.3 MEASUREMENT INSTRUMENTS LIST	12
4.4 TESTSETUP	13
4.5 EUT OPERATING CONDITIONS	13
4.6 TEST RESULTS	14
<b>5 RADIATED EMISSION TEST</b>	16
5.1 LIMIT	16
5.2 TEST PROCEDURE AND SETTING	17
5.3 MEASUREMENT INSTRUMENTS LIST	18
5.4 TESTSETUP	18
5.5 EUT OPERATING CONDITIONS	19
5.6 TEST RESULTS - 9 KHZ TO 30MHZ	20
5.7 TEST RESULTS- 30 MHZ TO 1000MHZ	21
5.8 TEST RESULTS - ABOVE 1000MHZ (BAND EDGE)	23
5.9 TEST RESULTS - ABOVE 1000MHZ(HARMONIC)	31
<b>6 NUMBER OF HOPPING FREQUENCY</b>	43
6.1 LIMIT	43
6.2 TEST PROCEDURE AND SETTING	43
6.3 MEASUREMENT INSTRUMENTS LIST	43
6.4 TEST SETUP	43
6.5 EUT OPERATION CONDITIONS	43
6.6 TEST RESULTS	44
<b>7 AVERAGE TIME OF OCCUPANCY</b>	45
7.1 LIMIT	45
7.2 TEST PROCEDURE AND SETTING	45
7.3 MEASUREMENT INSTRUMENTS LIST	45
7.4 TEST SETUP	45
7.5 EUT OPERATION CONDITIONS	45
7.6 TEST RESULTS	46
<b>8 HOPPING CHANNEL SEPARATION MEASUREMENT</b>	48
8.1 LIMIT	48

**Table of Contents****Page**

<b>8.2 TEST PROCEDURE AND SETTING</b>	<b>48</b>
<b>8.3 MEASUREMENT INSTRUMENTS LIST</b>	<b>48</b>
<b>8.4 TEST SETUP</b>	<b>48</b>
<b>8.5 EUT OPERATION CONDITIONS</b>	<b>48</b>
<b>8.6 TEST RESULTS</b>	<b>49</b>
<b>9 BANDWIDTH TEST</b>	<b>51</b>
<b>9.1 LIMIT</b>	<b>51</b>
<b>9.2 TEST PROCEDURE AND SETTING</b>	<b>51</b>
<b>9.3 MEASUREMENT INSTRUMENTS LIST</b>	<b>51</b>
<b>9.4 TEST SETUP</b>	<b>51</b>
<b>9.5 EUT OPERATION CONDITIONS</b>	<b>51</b>
<b>9.6 TEST RESULTS</b>	<b>52</b>
<b>10 MAXIMUM OUTPUT POWER</b>	<b>54</b>
<b>10.1 LIMIT</b>	<b>54</b>
<b>10.2 TEST PROCEDURE AND SETTING</b>	<b>54</b>
<b>10.3 MEASUREMENT INSTRUMENTS LIST</b>	<b>54</b>
<b>10.4 TEST SETUP</b>	<b>54</b>
<b>10.5 EUT OPERATION CONDITIONS</b>	<b>54</b>
<b>10.6 TEST RESULTS</b>	<b>55</b>
<b>11 CONDUCTED SPURIOUS EMISSION</b>	<b>58</b>
<b>11.1 LIMIT</b>	<b>58</b>
<b>11.2 TEST PROCEDURE AND SETTING</b>	<b>58</b>
<b>11.3 MEASUREMENT INSTRUMENTS LIST</b>	<b>58</b>
<b>11.4 TEST SETUP</b>	<b>58</b>
<b>11.5 EUT OPERATION CONDITIONS</b>	<b>58</b>
<b>11.6 TEST RESULTS</b>	<b>59</b>

**1 TEST REPORT DECLARE**

Applicant	BOOMPODS (HK) LTD.
Address	RM 303 Hankow Centre 5-15, Hankow Road T.S.T.Kowloon, HONG KONG.
Manufacturer	Dongguan Linyar Technology Co.,Ltd.
Address	No.2, PujiangRoad, DaningCommunity, Humen, Dongguan, Guangdong, China.
Factory	Dongguan Linyar Technology Co.,Ltd.
Address	No.2, PujiangRoad, DaningCommunity, Humen, Dongguan, Guangdong, China.
Equipment	twos earphones
Model No.	BASSLINE
Trade Mark	BOOMPODS
Standard	FCC Part15, Subpart C (15.247) ANSI C63.10-2013

**We Declare:**

The equipment described above is tested by DongGuan ShuoXin Electronic Technology Co., Ltd(ATT). and in the configuration tested the equipment complied with the standards specified above. The test results are contained in this test report and DongGuan ShuoXin Electronic Technology Co., Ltd.(ATT) is assumed of full responsibility for the accuracy and completeness of these tests.

ATT is not responsible for the sampling stage, so the results only apply to the sample as received.

ATT's reports apply only to the specific samples tested under conditions. It is manufacture's responsibility to ensure that additional production units of this model are manufactured with the identical electrical and mechanical components. ATT shall have no liability for any declarations, inferences or generalizations drawn by the client or others from ATT issued reports.

**2SUMMARY OF TEST RESULTS**

The EUT have been tested according to the applicable standards as referenced below:

Standard(s) Section	Test Item	Judgment	Remark
<b>FCC</b>			
15.207	AC Power Line Conducted Emissions	PASS	-----
15.247(d) 15.205(a) 15.209(a)	Radiated Emission	PASS	-----
15.247(a)(1)(iii)	Number of Hopping Frequency	PASS	-----
15.247(a)(1)(iii)	Average Time Of Occupancy	PASS	-----
15.247(a)(1)	Hopping Channel Separation	PASS	-----
15.247(a)(1)	Bandwidth	PASS	-----
15.247(a)(1)	Maximum Output Power	PASS	-----
15.247(d)	Conducted Spurious Emission	PASS	-----
15.203	Antenna Requirement	PASS	Note(2)

Note:

- (1) "N/A" denotes test is not applicable in this test report
- (2) The device what use a permanently attached antenna were considered sufficient to comply with the provisions of 15.203.

**2.1 MEASUREMENT UNCERTAINTY**

Test Item	Uncertainty
Uncertainty for Conduction emission test (9kHz-150kHz)	3.7 dB
Uncertainty for Conduction emission test (150kHz-30MHz)	3.3 dB
Uncertainty for Radiation Emission test (30MHz-200MHz)	4.60 dB (Polarize: V)
	4.60 dB (Polarize: H)
Uncertainty for Radiation Emission test (200MHz-1GHz)	6.10 dB (Polarize: V)
	5.08 dB (Polarize: H)
Uncertainty for Radiation Emission test (1GHz-6GHz)	5.01 dB (Polarize: V)
	5.01 dB (Polarize: H)
Uncertainty for Radiation Emission test (6GHz-18GHz)	5.26 dB (Polarize: V)
	5.26 dB (Polarize: H)
Uncertainty for Radiation Emission test (18GHz-40GHz)	5.06 dB (Polarize: V)
	5.06 dB (Polarize: H)
Uncertainty for radio frequency	±0.048kHz
Uncertainty for conducted RF Power	±0.32dB

**Note:**

This uncertainty represents an expanded uncertainty expressed at approximately the 95% confidence level using a coverage factor of k=2.

**Test Facility:**

The Test site used by DongGuan ShuoXin Electronic Technology Co., Ltd. to collect test data is located on the Zone A, 1F, No. 6, XinGang Road YuanGang Street, XinAn District, ChangAn Town, DongGuan City, GuangDong, China

The test facility is recognized, certified, or accredited by the following organizations:

Item	Registration No.	Expiration Date
CNAS	L3098	2024-08-27
A2LA	4893.01	2022-06-30
Innovation, Science and Economic Development Canada (ISED)	11033A CAB identifier:CN0083	2022-06-30
Federal Communications Commission (FCC)	171688 Designation No.:CN1235	2022-06-30

### 3 GENERAL INFORMATION

#### 3.1 GENERAL DESCRIPTION OF EUT

Equipment	tws earphones	
Brand Name	BOOMPODS	
Test Model	BASSLINE	
Series Model	N/A	
Model Difference(s)	N/A	
Hardware Version	BH817-V1.1	
Software Version	V1.0	
Power Source	Supplied from battery (3.7V, 55mAh).	
Power Rating	DC 3.7V	
Operation Frequency	2402 MHz ~ 2480 MHz	
Modulation Technology	GFSK, $\pi/4$ -DQPSK, 8-DPSK	
Bit Rate of Transmitter	1Mbps /2Mbps /3Mbps	
Antenna Information	Antenna Type: Ceramic Chip Antenna	Maximum Peak Gain:1.8dBi
Max. Output Power	1Mbps: 4.584dBm (0.002873W) 2Mbps: 4.599dBm (0.002883W) 3Mbps: 4.635dBm (0.002907W)	

Note:

1. For a more detailed features description, please refer to the manufacturer's specifications or the user's manual.

2. Channel List:

Channel	Frequency (MHz)	Channel	Frequency (MHz)	Channel	Frequency (MHz)
00	2402	27	2429	54	2456
01	2403	28	2430	55	2457
02	2404	29	2431	56	2458
03	2405	30	2432	57	2459
04	2406	31	2433	58	2460
05	2407	32	2434	59	2461
06	2408	33	2435	60	2462
07	2409	34	2436	61	2463
08	2410	35	2437	62	2464
09	2411	36	2438	63	2465
10	2412	37	2439	64	2466
11	2413	38	2440	65	2467
12	2414	39	2441	66	2468
13	2415	40	2442	67	2469
14	2416	41	2443	68	2470
15	2417	42	2444	69	2471
16	2418	43	2445	70	2472
17	2419	44	2446	71	2473
18	2420	45	2447	72	2474
19	2421	46	2448	73	2475
20	2422	47	2449	74	2476
21	2423	48	2450	75	2477
22	2424	49	2451	76	2478
23	2425	50	2452	77	2479
24	2426	51	2453	78	2480
25	2427	52	2454		
26	2428	53	2455		



### 3.2 DESCRIPTION OF TEST MODES

The test system was pre-tested based on the consideration of all possible combinations of EUT operation mode.

Prefest Mode	Description
Mode 1	TX Mode <b>NOTE (1)</b>
Mode 2	TX Mode Channel 00 _3Mbps

Following mode(s) was (were) found to be the worst case(s) and selected for the final test.

<b>AC power line conducted emissions test</b>	
Final Test Mode	Description
Mode 2	TX Mode Channel 00 _3Mbps

<b>Radiated emissions test - Below 1GHz</b>	
Final Test Mode	Description
Mode 2	TX Mode Channel 00 _3Mbps

<b>Radiated emissions test - Above 1GHz</b>	
Final Test Mode	Description
Mode 1	TX Mode <b>NOTE (1)</b>

<b>Conducted test</b>	
Final Test Mode	Description
Mode 1	TX Mode <b>NOTE (1)</b>

Note:

- (1) The measurements are performed at the high, middle, low available channels.
- (2) The measurements for Hopping Channel Separation, Bandwidth and Maximum Output Power were tested during 1Mbps, 2Mbps and 3Mbps, the worst case are 1Mbps and 3Mbps, only worst case was documented.

### 3.3PARAMETERS OF TEST SOFTWARE

During testing, channel & power controlling software provided by the customer was used to control the operating channel as well as the output power level. The RF output power selection is for the setting of RF output power expected by the customer and is going to be fixed on the firmware of the final end product power parameters of FHSS

Test Software	N/A		
Frequency (MHz)	2402	2441	2480
Parameters(1Mbps)	Default	Default	Default
Parameters(3Mbps)	Default	Default	Default

### 3.4BLOCK DIAGRAM SHOWING THE CONFIGURATION OF SYSTEM TESTED

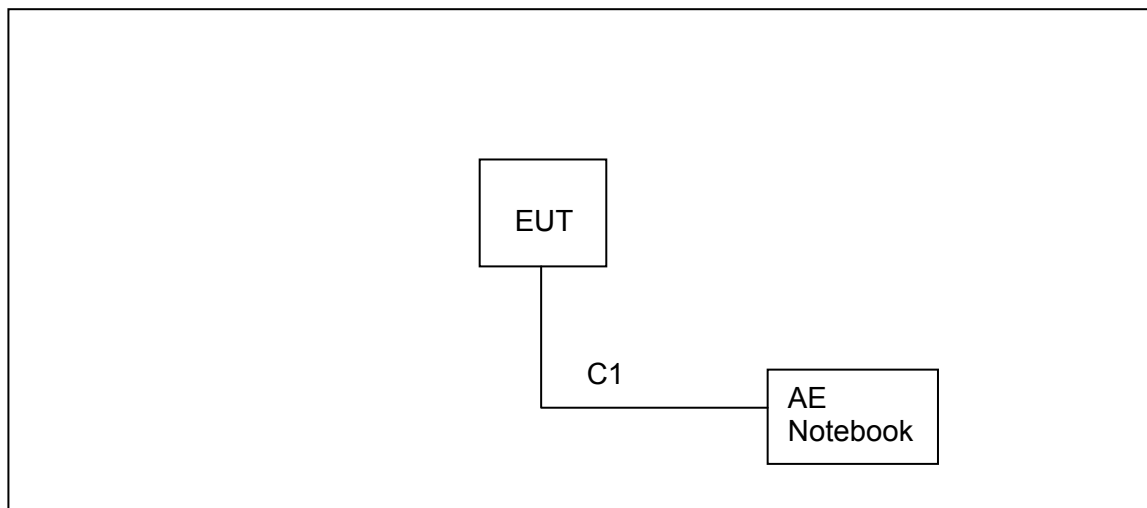

### 3.5SUPPORT UNITS

Item	Equipment	Brand	Model No.	Series No.
AE	Notebook	Lenovo	/	/

Item	Cable Type	Shielded Type	Ferrite Core	Length
C1	DC Cable	NO	NO	0.8m

**3.6 TEST ENVIRONMENT CONDITIONS**

Test Item	Temperature	Humidity	Test Voltage
AC Power Line Conducted Emissions	25°C	53%	AC 120V/60Hz
Radiated Emissions-9K-30MHz	25°C	60%	DC 3.7V
Radiated Emissions-30 MHz to 1GHz	24°C	68%	DC 3.7V
Radiated Emissions-Above 1000 MHz	24°C	68%	DC 3.7V
Number of Hopping Frequency	24.8°C	40.9%	DC 3.7V
Average Time Of Occupancy	24.8°C	40.9%	DC 3.7V
Hopping Channel Separation	24.8°C	40.9%	DC 3.7V
Bandwidth	24.8°C	40.9%	DC 3.7V
Maximum Output Power	24.8°C	40.9%	DC 3.7V
Conducted Spurious Emission	24.8°C	40.9%	DC 3.7V

### 4AC POWER LINE CONDUCTED EMISSIONS TEST

#### 4.1LIMIT

Frequency of Emission (MHz)	Limit (dBµV)	
	Quasi-peak	Average
0.15 - 0.50	66 to 56*	56 to 46*
0.50 - 5.0	56	46
5.0 - 30.0	60	50

Note:

- (1) The tighter limit applies at the band edges.
- (2) The limit of " \* " marked band means the limitation decreases linearly with the logarithm of the frequency in the range.

The following table is the setting of the receiver

Receiver Parameters	Setting
Attenuation	10 dB
Start Frequency	0.15 MHz
Stop Frequency	30 MHz
IF Bandwidth	9 kHz

#### 4.2TEST PROCEDURE

- a. The EUT was placed 0.8 meters from the horizontal ground plane with EUT being connected to the power mains through a line impedance stabilization network (LISN). All other support equipment powered from additional LISN(s). The LISN provide 50 Ohm/ 50uH of coupling impedance for the measuring instrument.
- b. Interconnecting cables that hang closer than 40 cm to the ground plane shall be folded back and forth in the center forming a bundle 30 to 40 cm long.
- c. I/O cables that are not connected to a peripheral shall be bundled in the center. The end of the cable may be terminated, if required, using the correct terminating impedance. The overall length shall not exceed 1 m.
- d. LISN at least 80 cm from nearest part of EUT chassis.

#### 4.3MEASUREMENT INSTRUMENTS LIST

Item	Kind of Equipment	Manufacturer	Type No.	Serial No.	Calibrated until
1	Pulse Limiter	MTS-systemtechnik	MTS-IMP-136	261115-010-0024	12/11/2021
2	EMI Test Receiver	R&S	ESCI	101308	12/12/2021
3	LISN	AFJ	LS16	16011103219	06/09/2022
4	LISN	Schwarzbeck	NSLK 8127	8127-432	12/11/2021
5	Measurement Software	Farad	EZ-EMC (Ver.ATT-03A)	N/A	N/A

#### 4.4 TEST SETUP

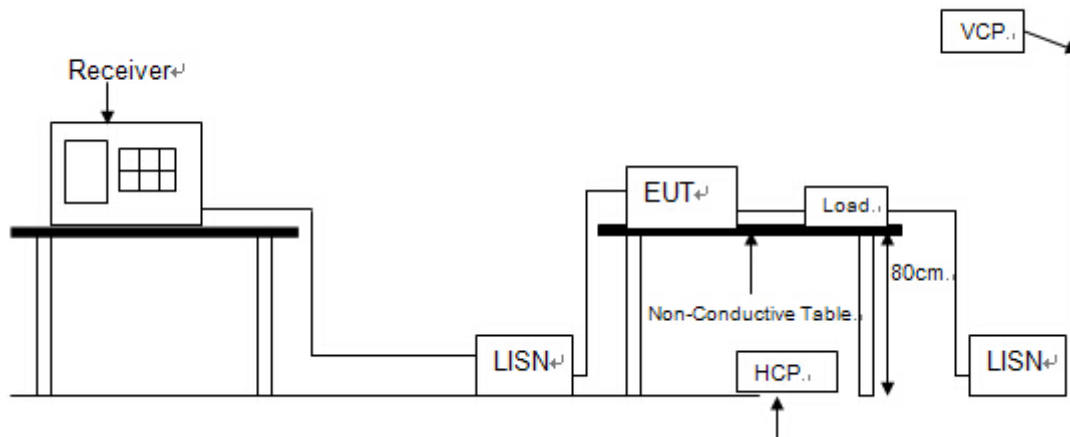

#### 4.5 EUT OPERATING CONDITIONS

The EUT was configured for testing in a typical function (as a customer would normally use it), EUT was programmed to be in continuously transmitting data or hopping on mode.

### 4.6 TEST RESULTS

Test Mode: TX Mode Channel 00 \_3Mbps

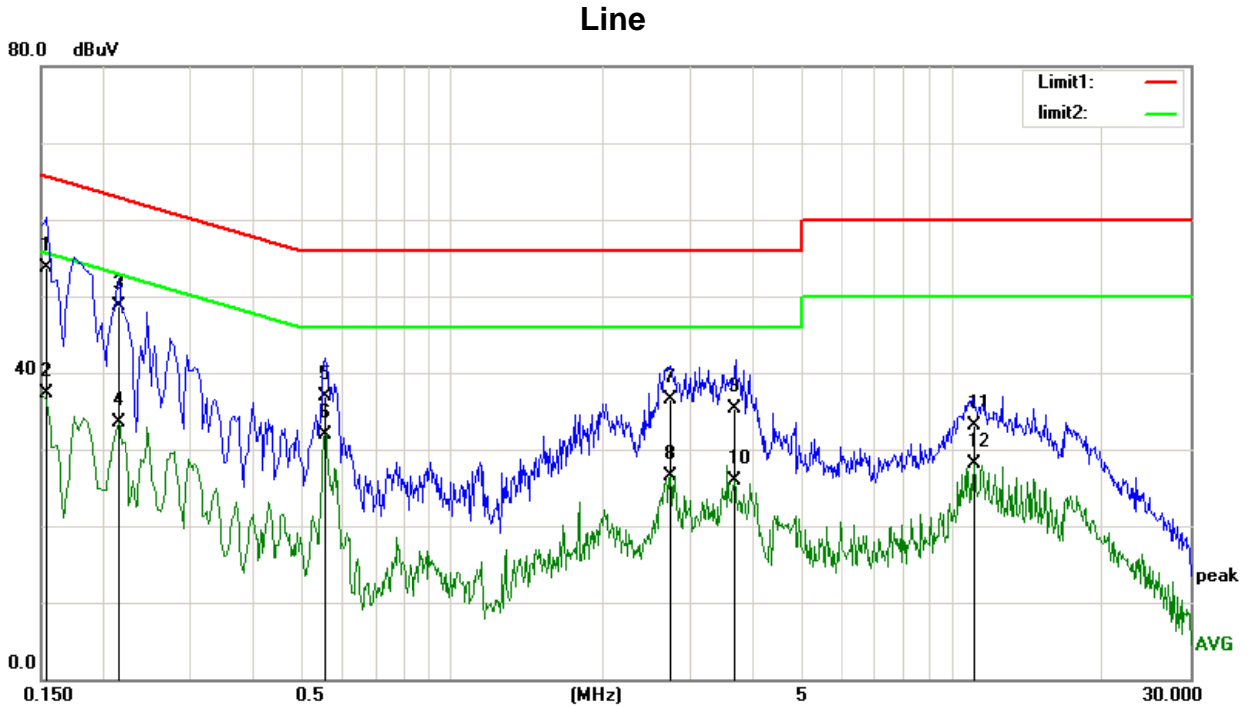

No.	Frequency (MHz)	Reading (dBuV)	Correct Factor(dB)	Result (dBuV)	Limit (dBuV)	Margin (dB)	Remark
1	0.1539	42.12	11.50	53.62	65.78	-12.16	QP
2	0.1539	25.83	11.50	37.33	55.78	-18.45	AVG
3	0.2140	37.52	11.10	48.62	63.04	-14.42	QP
4	0.2140	22.48	11.10	33.58	53.04	-19.46	AVG
5	0.5580	26.68	10.27	36.95	56.00	-19.05	QP
6	0.5580	21.67	10.27	31.94	46.00	-14.06	AVG
7	2.7260	26.23	10.22	36.45	56.00	-19.55	QP
8	2.7260	16.36	10.22	26.58	46.00	-19.42	AVG
9	3.6780	25.02	10.23	35.25	56.00	-20.75	QP
10	3.6780	15.73	10.23	25.96	46.00	-20.04	AVG
11	11.0460	22.93	10.20	33.13	60.00	-26.87	QP
12	11.0460	17.88	10.20	28.08	50.00	-21.92	AVG

Remarks:

- (1) Measurement Value = Reading Level + Correct Factor.
- (2) Margin Level = Measurement Value - Limit Value.

Test Mode: TX Mode Channel 00 \_3Mbps

### Neutral

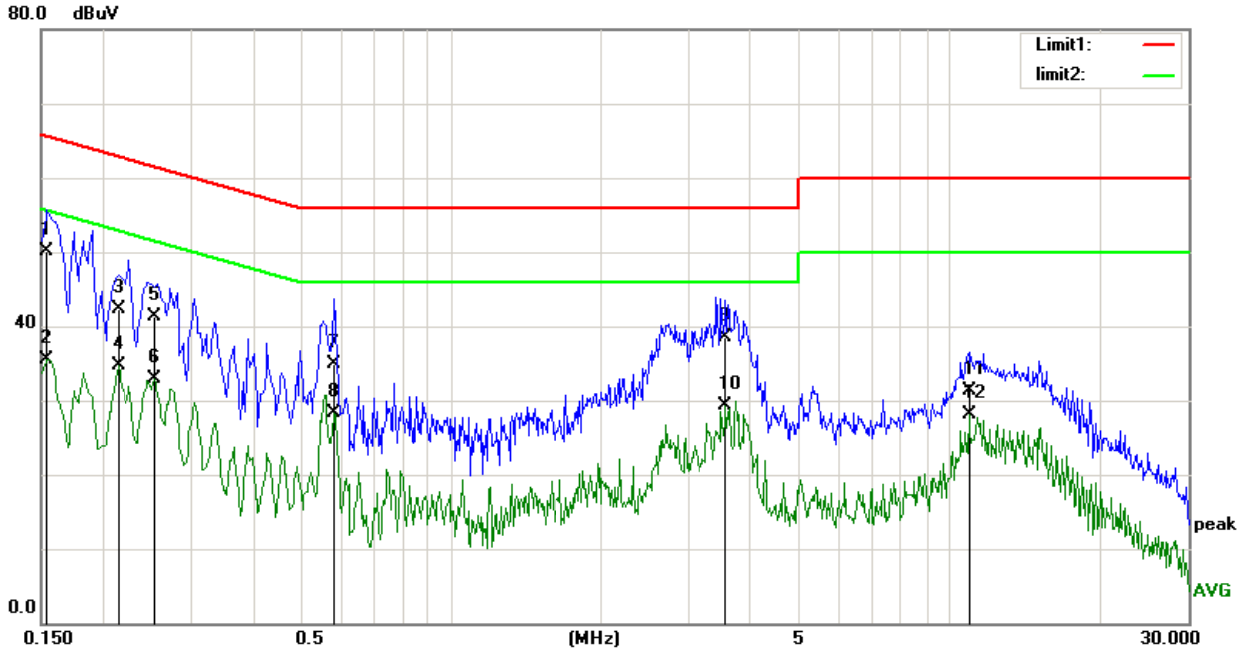

No.	Frequency (MHz)	Reading (dBuV)	Correct Factor(dB)	Result (dBuV)	Limit (dBuV)	Margin (dB)	Remark
1	0.1539	38.69	11.50	50.19	65.78	-15.59	QP
2	0.1539	24.08	11.50	35.58	55.78	-20.20	AVG
3	0.2140	31.24	11.10	42.34	63.04	-20.70	QP
4	0.2140	23.58	11.10	34.68	53.04	-18.36	AVG
5	0.2540	30.42	10.82	41.24	61.62	-20.38	QP
6	0.2540	22.05	10.82	32.87	51.62	-18.75	AVG
7	0.5820	24.58	10.27	34.85	56.00	-21.15	QP
8	0.5820	17.94	10.27	28.21	46.00	-17.79	AVG
9	3.5540	28.29	10.23	38.52	56.00	-17.48	QP
10	3.5540	19.04	10.23	29.27	46.00	-16.73	AVG
11	10.8819	21.07	10.20	31.27	60.00	-28.73	QP
12	10.8819	17.98	10.20	28.18	50.00	-21.82	AVG

**Remarks:**

- (1) Measurement Value = Reading Level + Correct Factor.
- (2) Margin Level = Measurement Value - Limit Value.

## 5 RADIATED EMISSION TEST

### 5.1 LIMIT

In case the emission fall within the restricted band specified on 15.205(a), then the 15.209(a) limit in the table below has to be followed.

#### LIMITS OF RADIATED EMISSION MEASUREMENT (9 kHz-1000MHz)

Frequency (MHz)	Field Strength (microvolts/meter)	Measurement Distance (meters)
0.009-0.490	2400/F(kHz)	300
0.490-1.705	24000/F(kHz)	30
1.705-30.0	30	30
30-88	100	3
88-216	150	3
216-960	200	3
Above 960	500	3

#### LIMITS OF RADIATED EMISSION MEASUREMENT (9 kHz-30 MHz)

Frequency (MHz)	Magnetic field strength (H-Field) (μA/m)	Measurement Distance (meters)
0.009-0.490	6.37/F(kHz)	300
0.490-1.705	6.37/F(kHz)	30
1.705-30.0	0.08	30

#### LIMITS OF RADIATED EMISSION MEASUREMENT (30 MHz-1000MHz)

Frequency (MHz)	Field Strength (μV/m at 3m)
30-88	100
88-216	150
216-960	200
Above 960	500

#### LIMITS OF RADIATED EMISSION MEASUREMENT (Above 1000MHz)

Frequency (MHz)	(dBuV/m at 3 m)	
	Peak	Average
Above 1000	74	54

**Note:**

- (1) The limit for radiated test was performed according to FCC PART 15C and RSS-247.
- (2) The tighter limit applies at the band edges.
- (3) Emission level (dBuV/m)=20log Emission level (uV/m).



**5.2 TEST PROCEDURE AND SETTING**

- a. The measuring distance of 3 m shall be used for measurements. The EUT was placed on the top of a rotating table 0.8 meter above the ground at a 3 meter semi-anechoic chamber. The table was rotated 360 degrees to determine the position of the highest radiation.(below 1GHz)
- b. The measuring distance of 3 m shall be used for measurements. The EUT was placed on the top of a rotating table 1.5 meter above the ground at a 3 meter semi-anechoic chamber. The table was rotated 360 degrees to determine the position of the highest radiation.(above 1GHz)
- c. The height of the equipment or of the substitution antenna shall be 0.8m or 1.5m; the height of the test antenna shall vary between 1 m to 4 m. Both horizontal and vertical polarizations of the antenna are set to make the measurement.
- d. For each suspected emission, the EUT was arranged to its worst case and then the antenna was tuned to heights find the maximum reading (used Bore sight function).
- e. The receiver system was set to peak and average detect function and specified bandwidth with maximum hold mode when the test frequency is above 1GHz.
- f. The initial step in collecting radiated emission data is a receiver peak detector mode pre-scanning the measurement frequency range. Significant peaks are then marked and then Quasi Peak detector mode re-measured.
- g. All readings are Peak unless otherwise stated QP in column of Note. Peak denotes that the Peak reading compliance with the QP Limits and then QP Mode measurement didn't perform. (below 1GHz)
- h. All readings are Peak Mode value unless otherwise stated AVG in column of Note. If the Peak Mode Measured value compliance with the Peak Limits and lower than AVG Limits, the EUT shall be deemed to meet both Peak & AVG Limits and then only Peak Mode was measured, but AVG Mode didn't perform. (above 1GHz)
- i. The test result is calculated as the following:
  - (1) Result = Reading + Correct Factor
  - (2) Correct Factor = Antenna Factor + Cable Loss – Amplifier Gain + Attenuator
  - (3) Margin = Result - Limit

Spectrum Parameter	Setting
Attenuation	Auto
Start Frequency	1000 MHz
Stop Frequency	10th carrier harmonic
RBW / VBW (Emission in restricted band)	RBW 1MHz VBW 3MHz peak detector for Pk value RMS detector for AV value

Receiver Parameter	Setting
Attenuation	Auto
Start ~ Stop Frequency	9 kHz~90 kHz for PK/AVG detector
Start ~ Stop Frequency	90 kHz~110 kHz for QP detector
Start ~ Stop Frequency	110 kHz~490 kHz for PK/AVG detector
Start ~ Stop Frequency	490 kHz~30 MHz for QP detector
Start ~ Stop Frequency	30MHz~1000MHz for QP detector

### 5.3 MEASUREMENT INSTRUMENTS LIST

Item	Equipment	Manufacturer	Model No.	Serial No.	Calibrated until
1	EMI Test Receiver	R&S	ESCI	101307	12/12/2021
2	Spectrum Analyzer	Agilent	E4407B	US40240708	11/16/2022
3	Loop antenna	SCHWARZBECK K	FMZB1519	1519-062	12/14/2021
4	Broadband antenna	SCHWARZBECK	VULB9168	VULB9168-192	08/05/2022
5	HORN ANTENNA	SCHWARZBECK	BBHA9120D	9120D 1065	04/21/2022
6	Preamplifier Amplifier	HP	8447F	3113A05680	12/11/2021
7	PRE-AMPLIFIER	CY	EMC011830	980136	12/11/2021
8	RF Cable	R&S	Test Cable 4	4	12/11/2021
9	RF Cable	R&S	Test Cable 5	5	12/11/2021
10	RF Cable	R&S	Test Cable 9	9	04/21/2022
11	RF Cable	R&S	Test Cable 10	10	12/11/2021
12	Measurement Software	Farad	EZ-EMC (Ver.ATT-03A)	N/A	N/A

### 5.4 TEST SETUP

#### 9 kHz-30 MHz

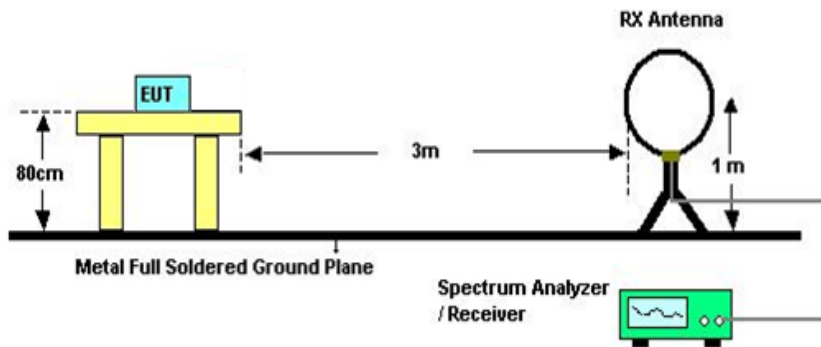

#### 30 MHz to 1 GHz

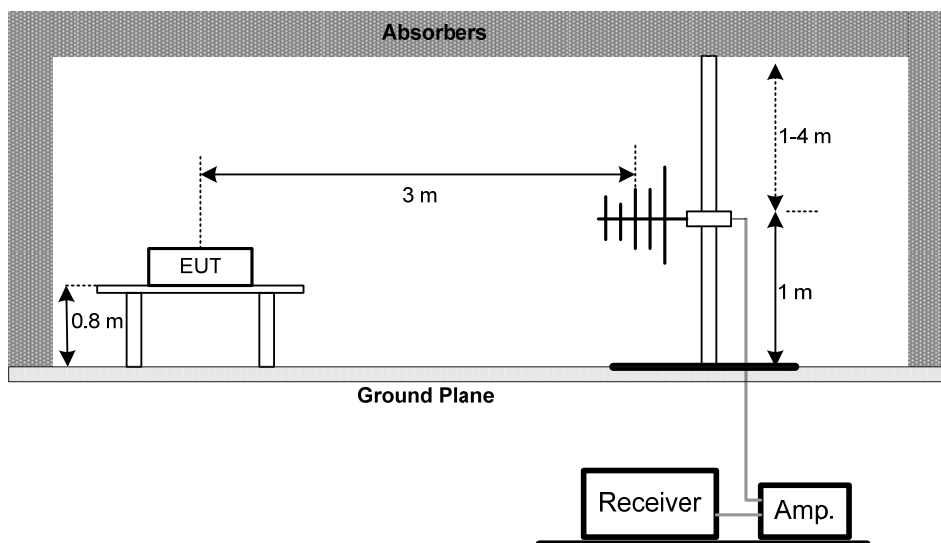

### Above 1 GHz

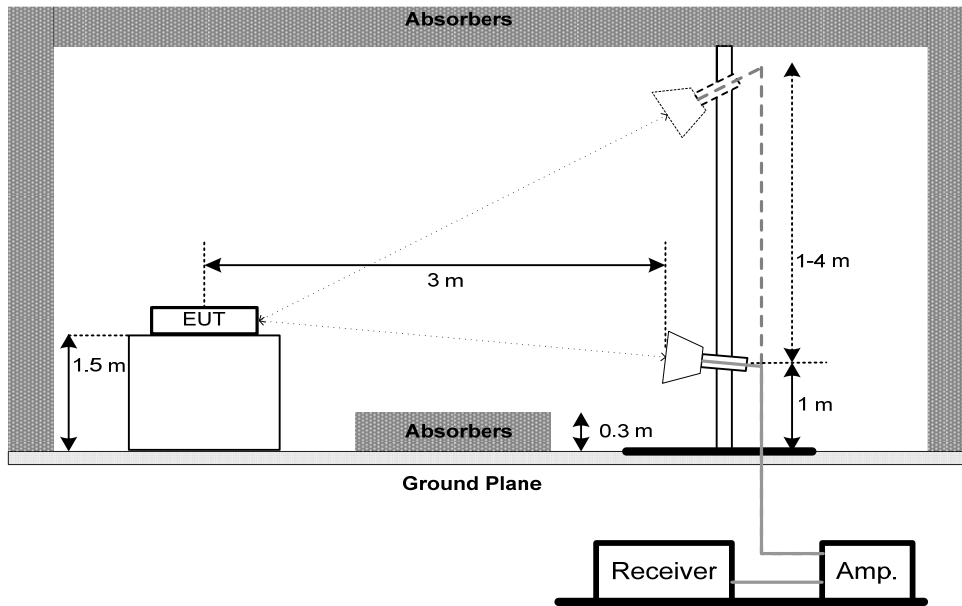

### 5.5 EUT OPERATING CONDITIONS

The EUT was programmed to be in continuously transmitting mode.

**5.6 TEST RESULTS - 9 kHz TO 30MHz**

Test Mode:	TX Mode Channel 00 _3Mbps
------------	---------------------------

Freq.	Reading	Limit	Margin	State
(MHz)	(dBuV/m)	(dBuV/m)	(dB)	P/F
--	--	--	--	P
--	--	--	--	P

**Note:**

The amplitude of spurious emissions which are attenuated by more than 20dB below the permissible value has no need to be reported.

Distance extrapolation factor =  $20 \log(\text{specific distance}/\text{test distance})$ (dB);

Limit line = specific limits(dBuv) + distance extrapolation factor

## 5.7 TEST RESULTS- 30 MHz TO 1000MHz

Test Mode: TX Mode Channel 00 \_3Mbps

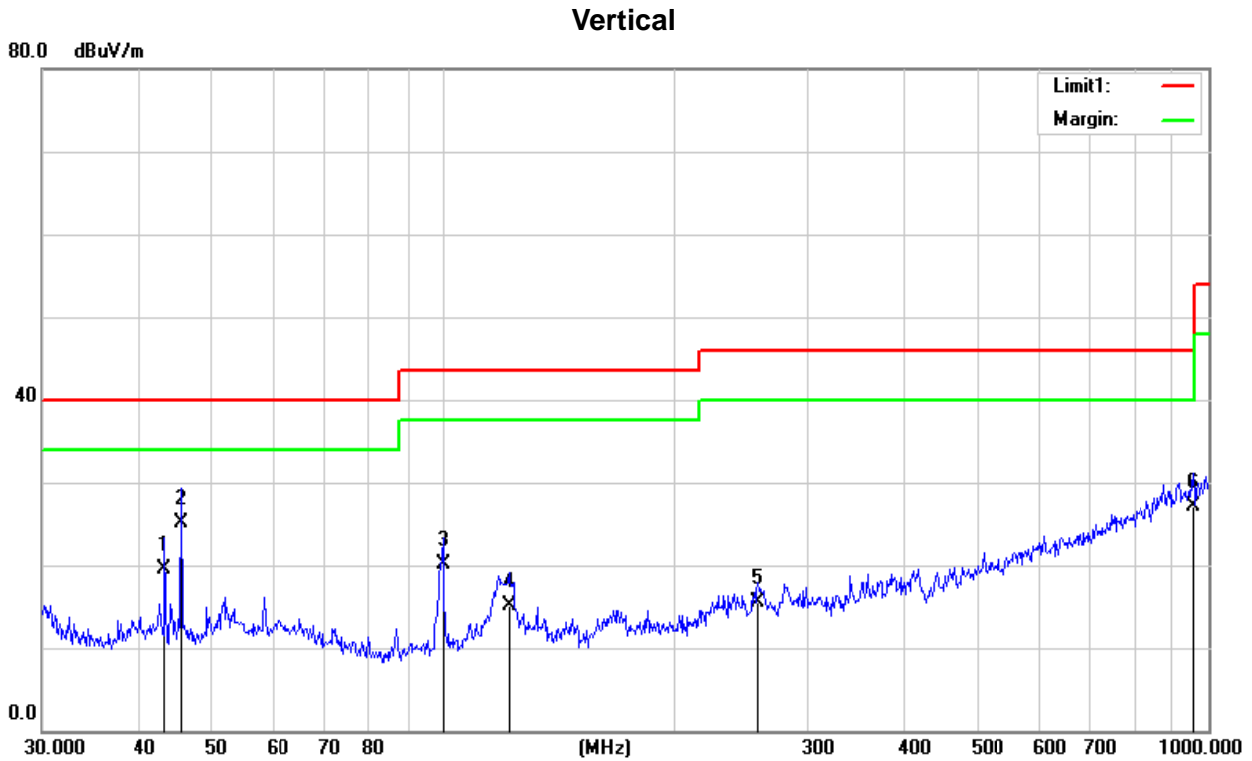

No.	Frequency (MHz)	Reading (dBuV/m)	Correct Factor(dB/m)	Result (dBuV/m)	Limit (dBuV/m)	Margin (dB)	Remark
1	43.3534	33.21	-13.61	19.60	40.00	-20.40	QP
2	45.5347	39.03	-13.89	25.14	40.00	-14.86	QP
3	100.2286	34.53	-14.47	20.06	43.50	-23.44	QP
4	121.9754	27.39	-12.33	15.06	43.50	-28.44	QP
5	258.3263	22.04	-6.62	15.42	46.00	-30.58	QP
6	955.4380	23.22	3.95	27.17	46.00	-18.83	QP

Test Mode: TX Mode Channel 00 \_3Mbps

### Horizontal

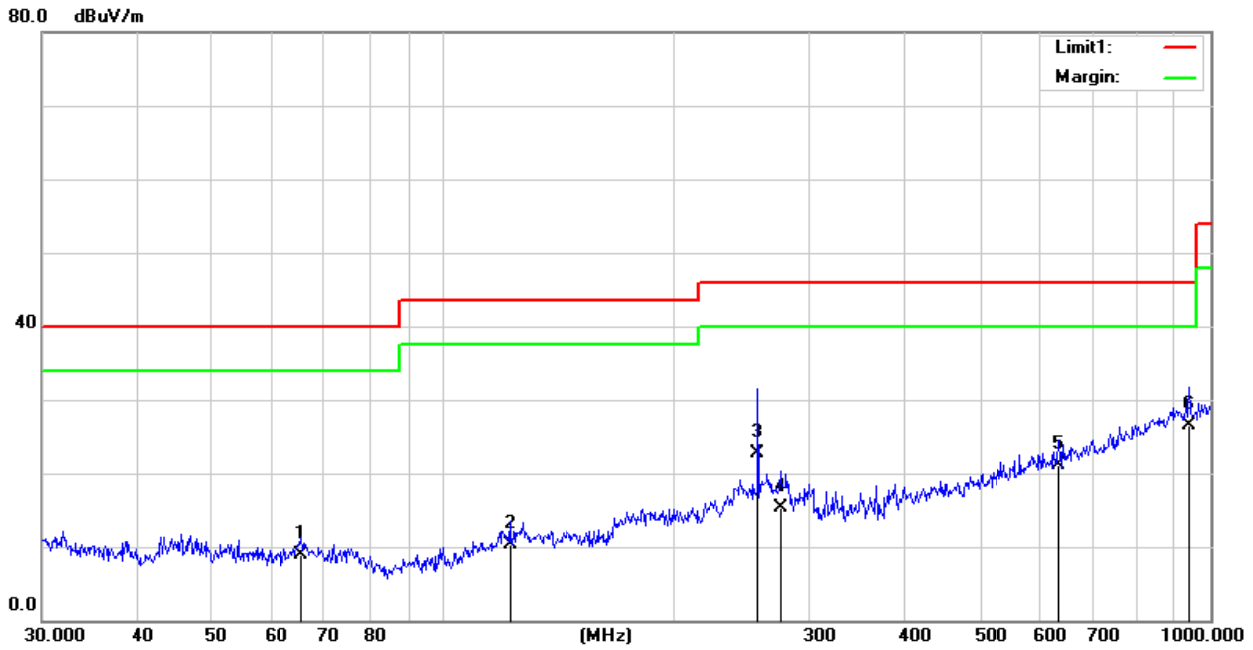

No.	Frequency (MHz)	Reading (dBuV/m)	Correct Factor(dB/m)	Result (dBuV/m)	Limit (dBuV/m)	Margin (dB)	Remark
1	65.3431	24.44	-15.44	9.00	40.00	-31.00	QP
2	121.9754	23.56	-13.33	10.23	43.50	-33.27	QP
3	257.4221	28.10	-5.48	22.62	46.00	-23.38	QP
4	275.1569	20.57	-5.27	15.30	46.00	-30.70	QP
5	633.9072	23.92	-2.78	21.14	46.00	-24.86	QP
6	938.8325	22.71	3.85	26.56	46.00	-19.44	QP

## 5.8TEST RESULTS - ABOVE 1000MHz (BAND EDGE)

Test Mode: TX 2402 MHz\_CH00\_1Mbps

### Vertical

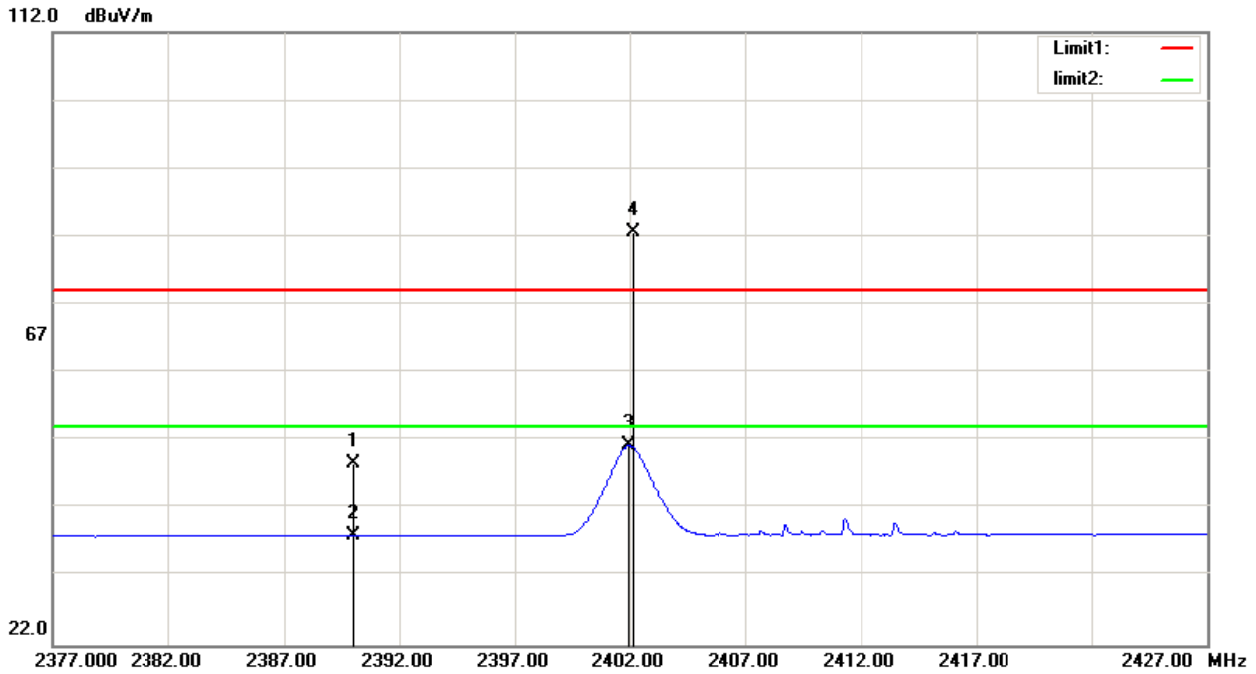

No.	Frequency (MHz)	Reading (dBuV/m)	Correct Factor(dB/m)	Result (dBuV/m)	Limit (dBuV/m)	Margin (dB)	Remark
1	2390.000	20.56	28.19	48.75	74.00	-25.25	peak
2	2390.000	9.83	28.19	38.02	54.00	-15.98	AVG
3	2401.950	23.07	28.23	51.30	/	/	AVG
4	2402.150	54.38	28.23	82.61	/	/	peak

Test Mode: TX 2402 MHz\_CH00\_1Mbps

### Horizontal

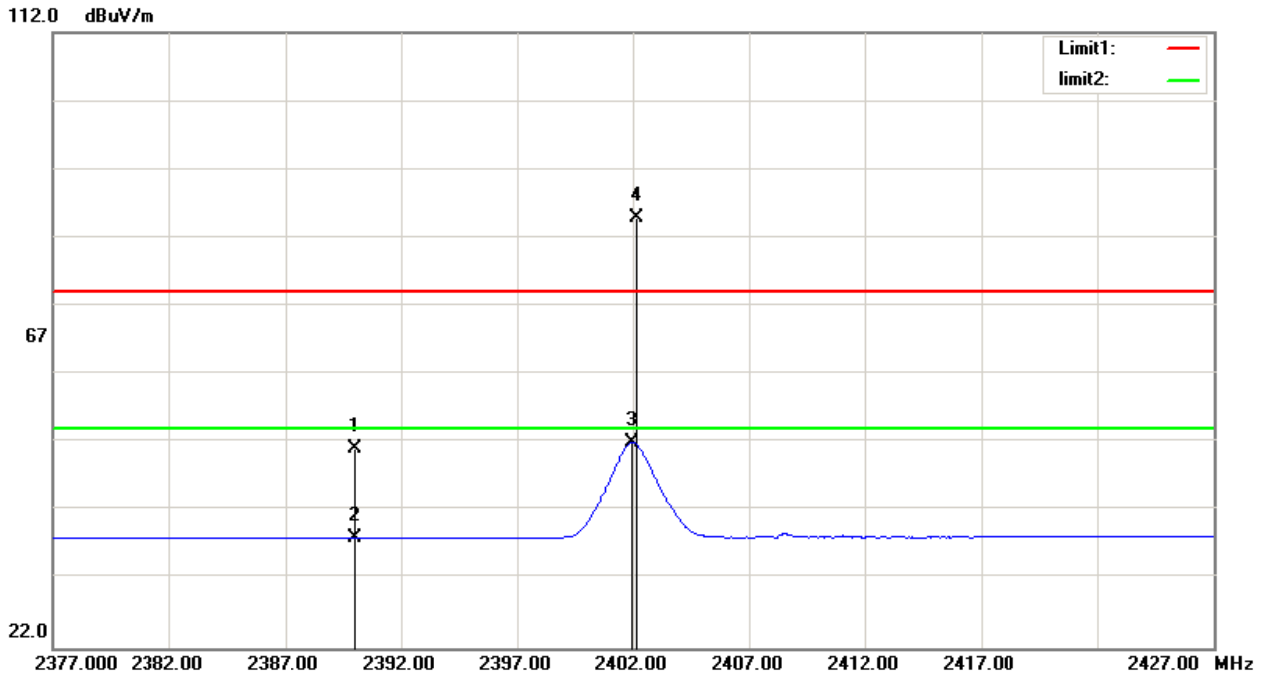

No.	Frequency (MHz)	Reading (dBuV/m)	Correct Factor(dB/m)	Result (dBuV/m)	Limit (dBuV/m)	Margin (dB)	Remark
1	2390.000	23.04	28.19	51.23	74.00	-22.77	peak
2	2390.000	9.90	28.19	38.09	54.00	-15.91	AVG
3	2401.950	23.80	28.23	52.03	/	/	AVG
4	2402.150	56.77	28.23	85.00	/	/	peak



Test Mode: TX 2480 MHz\_CH78\_1Mbps

### Vertical

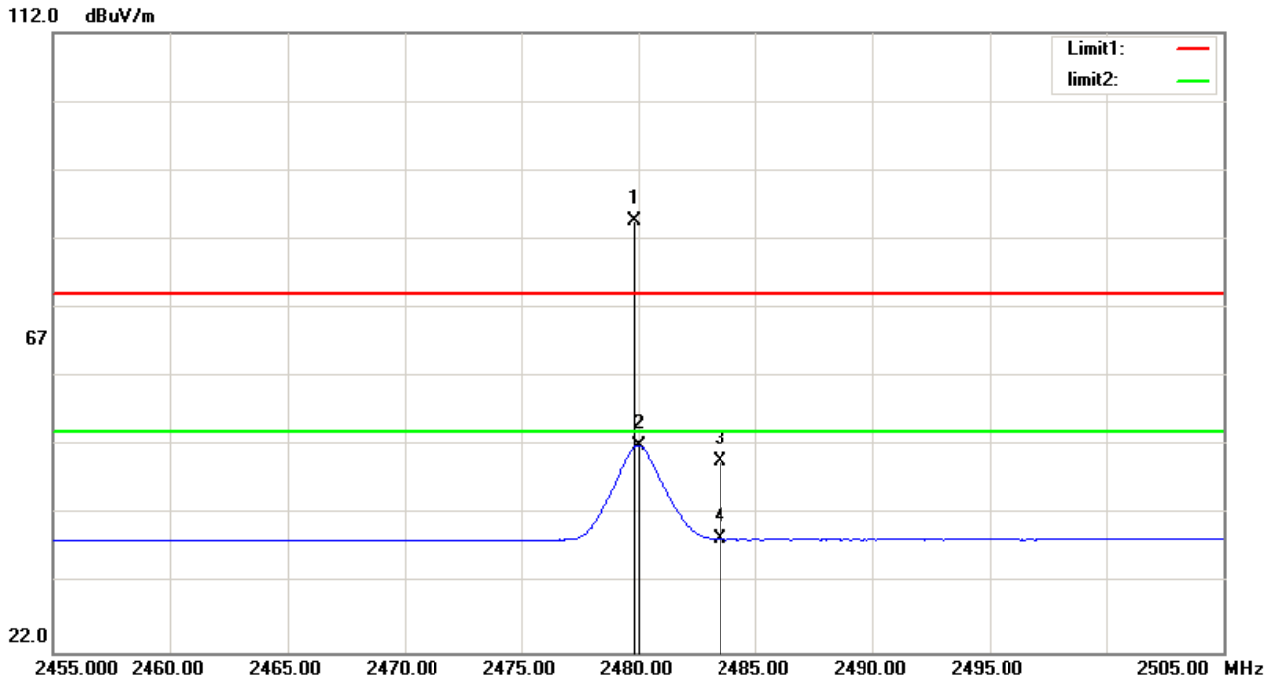

No.	Frequency (MHz)	Reading (dBuV/m)	Correct Factor(dB/m)	Result (dBuV/m)	Limit (dBuV/m)	Margin (dB)	Remark
1	2479.800	56.23	28.42	84.65	/	/	peak
2	2480.000	23.66	28.42	52.08	/	/	AVG
3	2483.500	21.29	28.43	49.72	74.00	-24.28	peak
4	2483.500	10.08	28.43	38.51	54.00	-15.49	AVG

Test Mode: TX 2480 MHz\_CH78\_1Mbps

### Horizontal

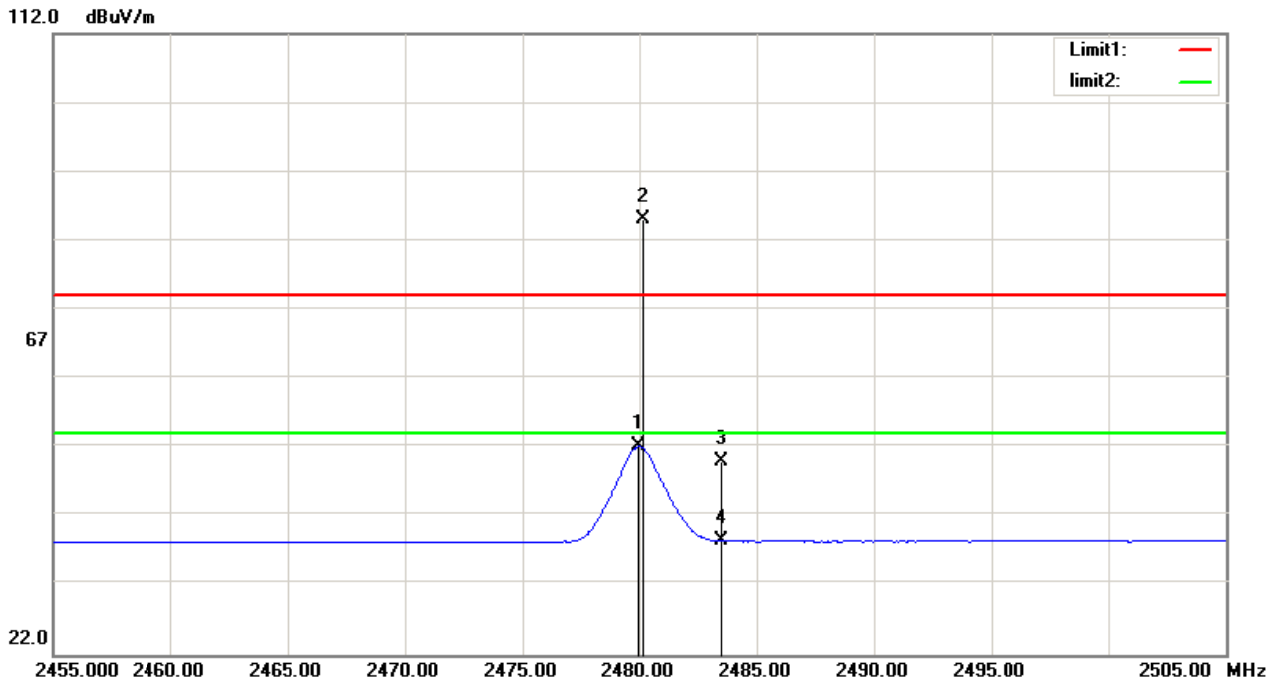

No.	Frequency (MHz)	Reading (dBuV/m)	Correct Factor(dB/m)	Result (dBuV/m)	Limit (dBuV/m)	Margin (dB)	Remark
1	2479.950	23.75	28.42	52.17	/	/	AVG
2	2480.150	56.63	28.42	85.05	/	/	peak
3	2483.500	21.53	28.43	49.96	74.00	-24.04	peak
4	2483.500	10.06	28.43	38.49	54.00	-15.51	AVG

Test Mode: TX 2402 MHz\_CH00\_3Mbps

### Vertical

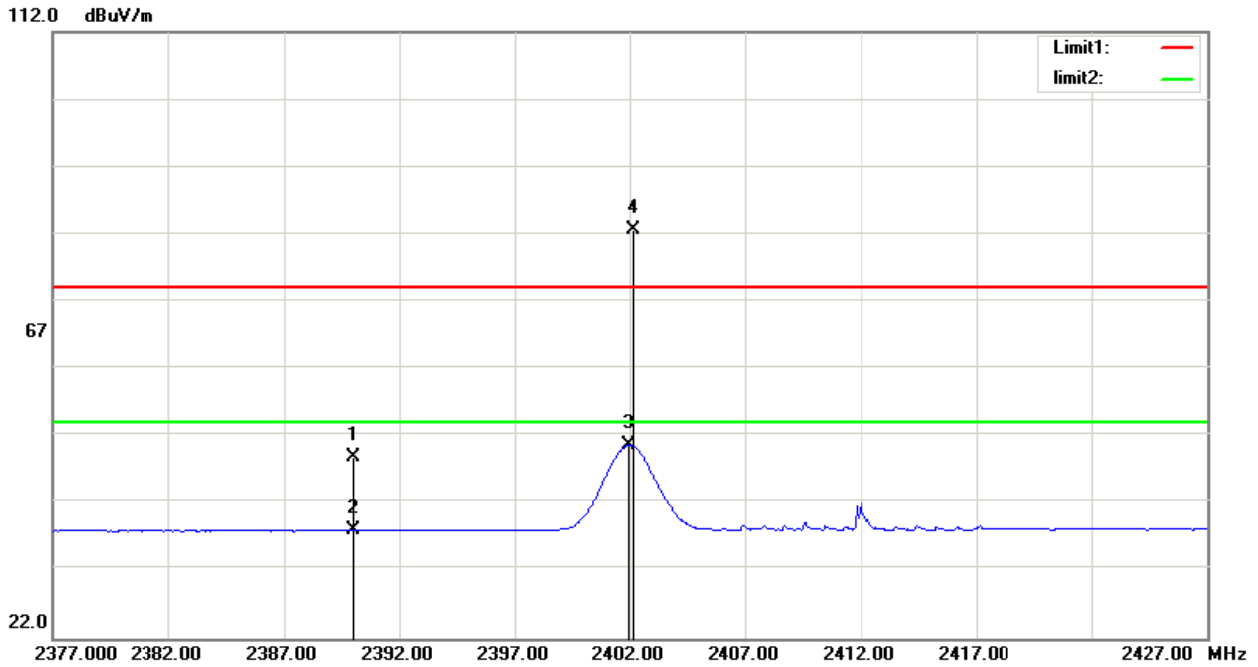

No.	Frequency (MHz)	Reading (dBuV/m)	Correct Factor(dB/m)	Result (dBuV/m)	Limit (dBuV/m)	Margin (dB)	Remark
1	2390.000	20.64	28.19	48.83	74.00	-25.17	peak
2	2390.000	9.86	28.19	38.05	54.00	-15.95	AVG
3	2401.950	22.44	28.23	50.67	/	/	AVG
4	2402.200	54.36	28.23	82.59	/	/	peak

Test Mode: TX 2402 MHz\_CH00\_3Mbps

### Horizontal

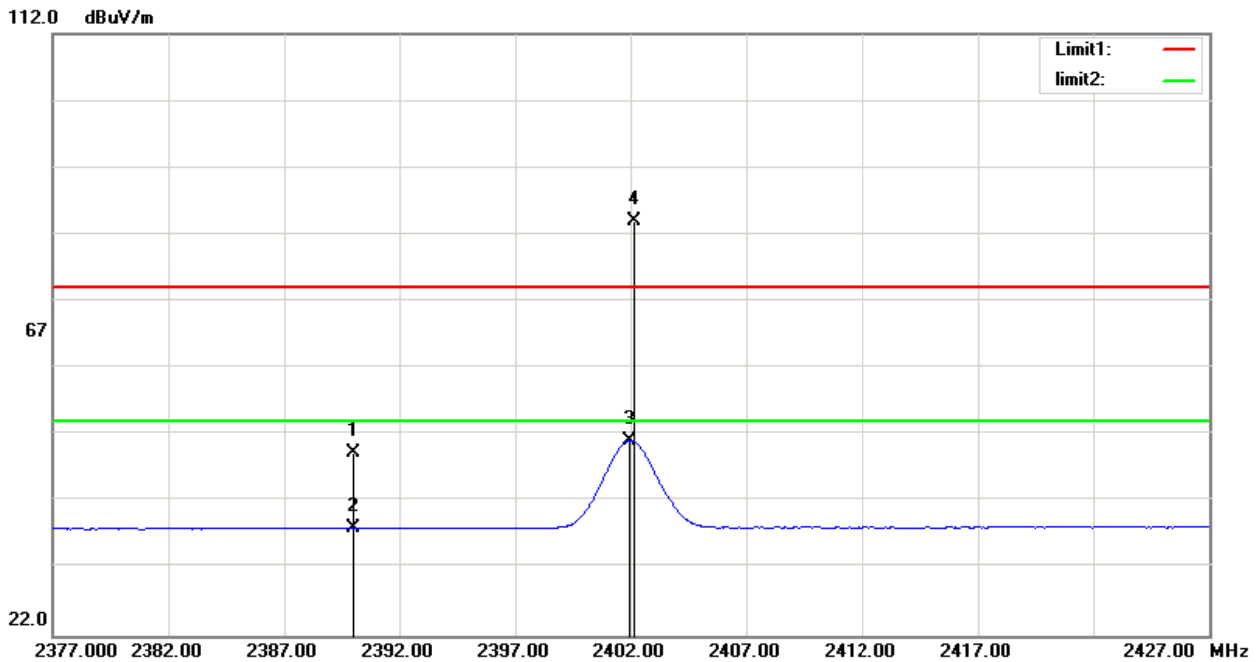

No.	Frequency (MHz)	Reading (dBuV/m)	Correct Factor(dB/m)	Result (dBuV/m)	Limit (dBuV/m)	Margin (dB)	Remark
1	2390.000	21.17	28.19	49.36	74.00	-24.64	peak
2	2390.000	9.82	28.19	38.01	54.00	-15.99	AVG
3	2401.950	22.91	28.23	51.14	/	/	AVG
4	2402.200	55.87	28.23	84.10	/	/	peak

Test Mode: TX 2480 MHz\_CH78\_3Mbps

### Vertical

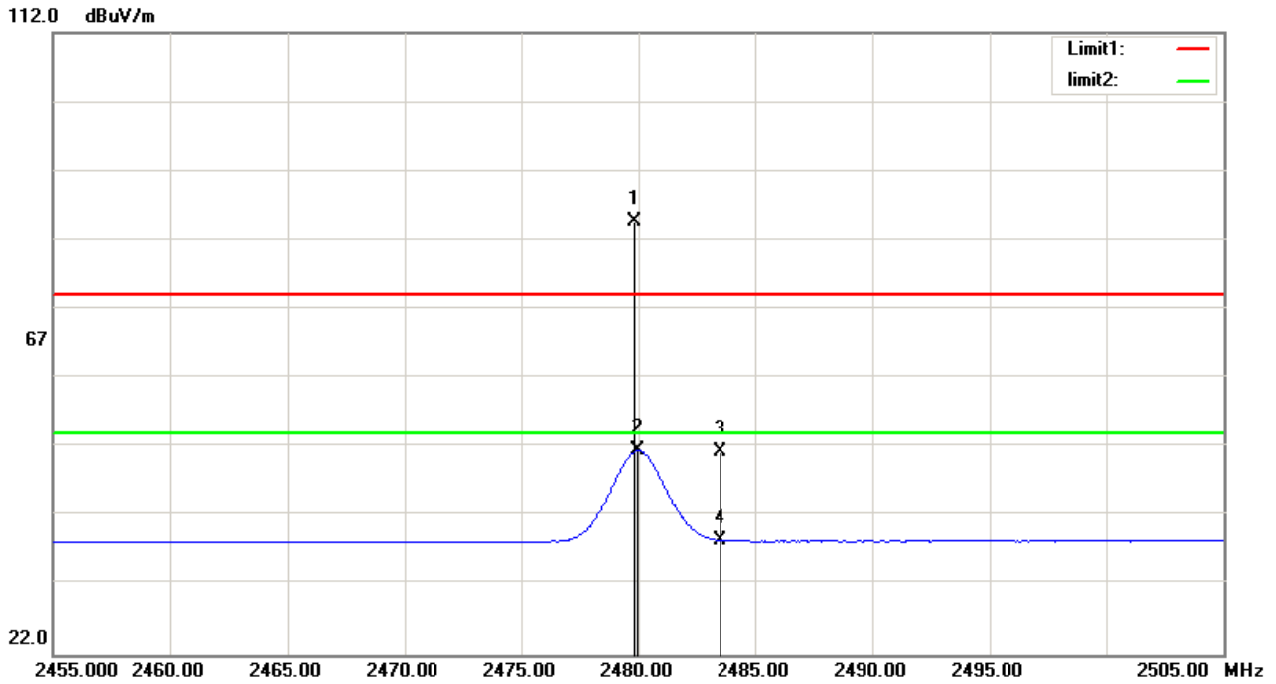

No.	Frequency (MHz)	Reading (dBuV/m)	Correct Factor(dB/m)	Result (dBuV/m)	Limit (dBuV/m)	Margin (dB)	Remark
1	2479.850	56.16	28.42	84.58	/	/	peak
2	2479.950	23.12	28.42	51.54	/	/	AVG
3	2483.500	22.89	28.43	51.32	74.00	-22.68	peak
4	2483.500	10.12	28.43	38.55	54.00	-15.45	AVG

Test Mode: TX 2480 MHz\_CH78\_3Mbps

### Horizontal

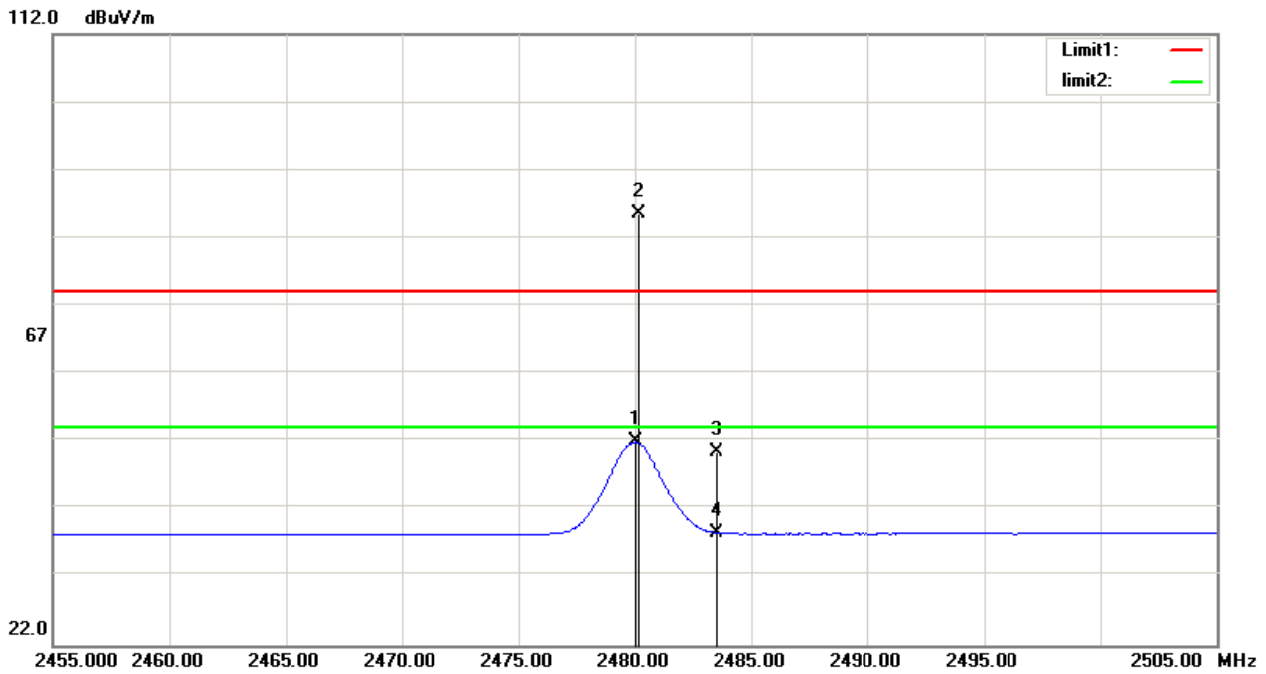

No.	Frequency (MHz)	Reading (dBuV/m)	Correct Factor(dB/m)	Result (dBuV/m)	Limit (dBuV/m)	Margin (dB)	Remark
1	2480.000	23.51	28.42	51.93	/	/	AVG
2	2480.200	57.22	28.42	85.64	/	/	peak
3	2483.500	22.06	28.43	50.49	74.00	-23.51	peak
4	2483.500	10.13	28.43	38.56	54.00	-15.44	AVG

## 5.9 TEST RESULTS - ABOVE 1000MHz(HARMONIC)

Test Mode: TX 2402 MHz\_CH00\_1Mbps

### Vertical

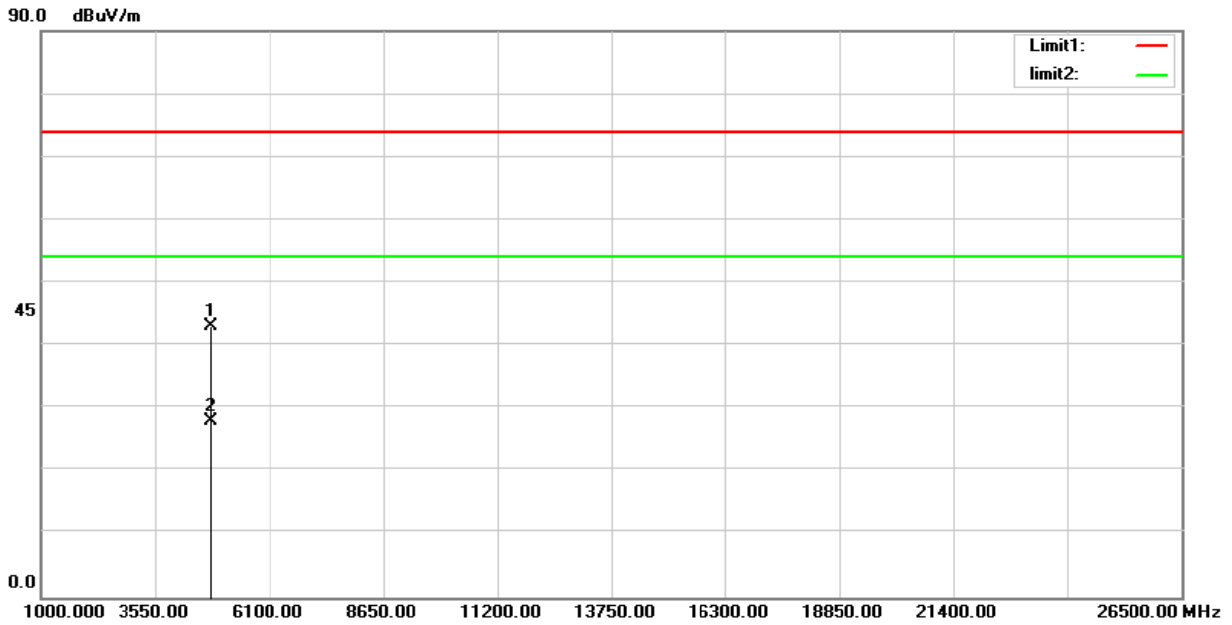

No.	Frequency (MHz)	Reading (dBuV/m)	Correct Factor(dB/m)	Result (dBuV/m)	Limit (dBuV/m)	Margin (dB)	Remark
1	4804.000	52.43	-9.26	43.17	74.00	-30.83	peak
2	4804.000	37.37	-9.26	28.11	54.00	-25.89	AVG

Test Mode: TX 2402 MHz\_CH00\_1Mbps

### Horizontal

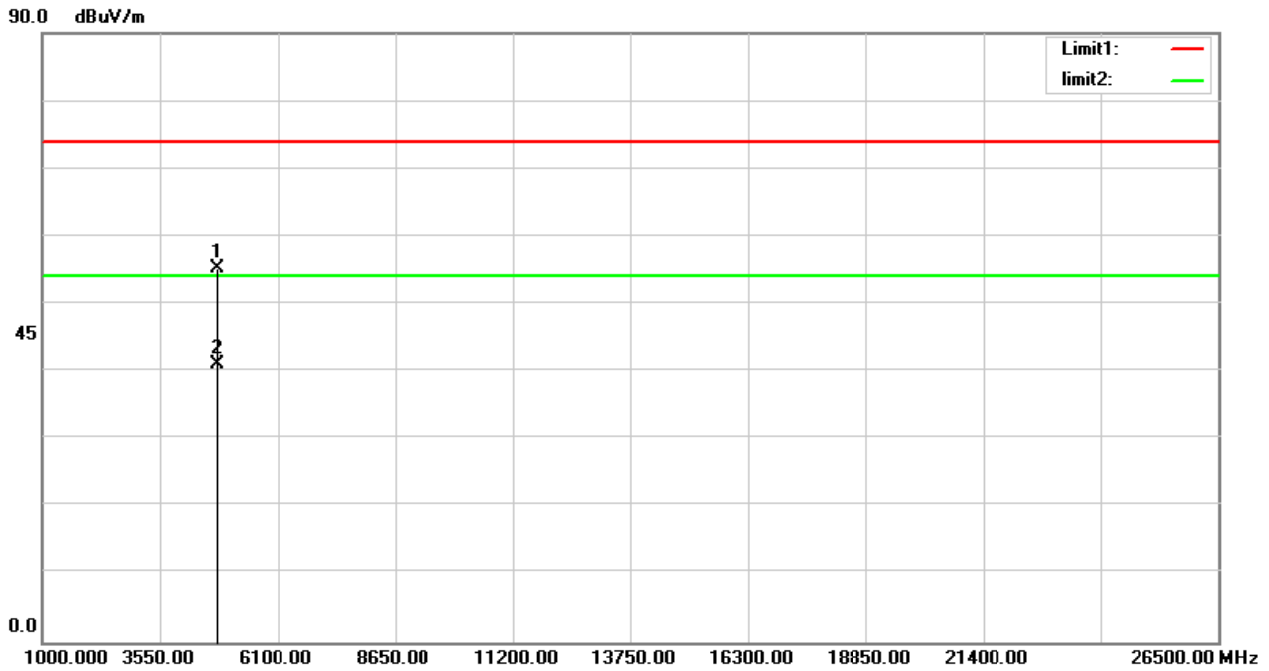

No.	Frequency (MHz)	Reading (dBuV/m)	Correct Factor(dB/m)	Result (dBuV/m)	Limit (dBuV/m)	Margin (dB)	Remark
1	4804.000	64.55	-9.26	55.29	74.00	-18.71	peak
2	4804.000	50.40	-9.26	41.14	54.00	-12.86	AVG



Test Mode: TX 2441 MHz\_CH39\_1Mbps

### Vertical

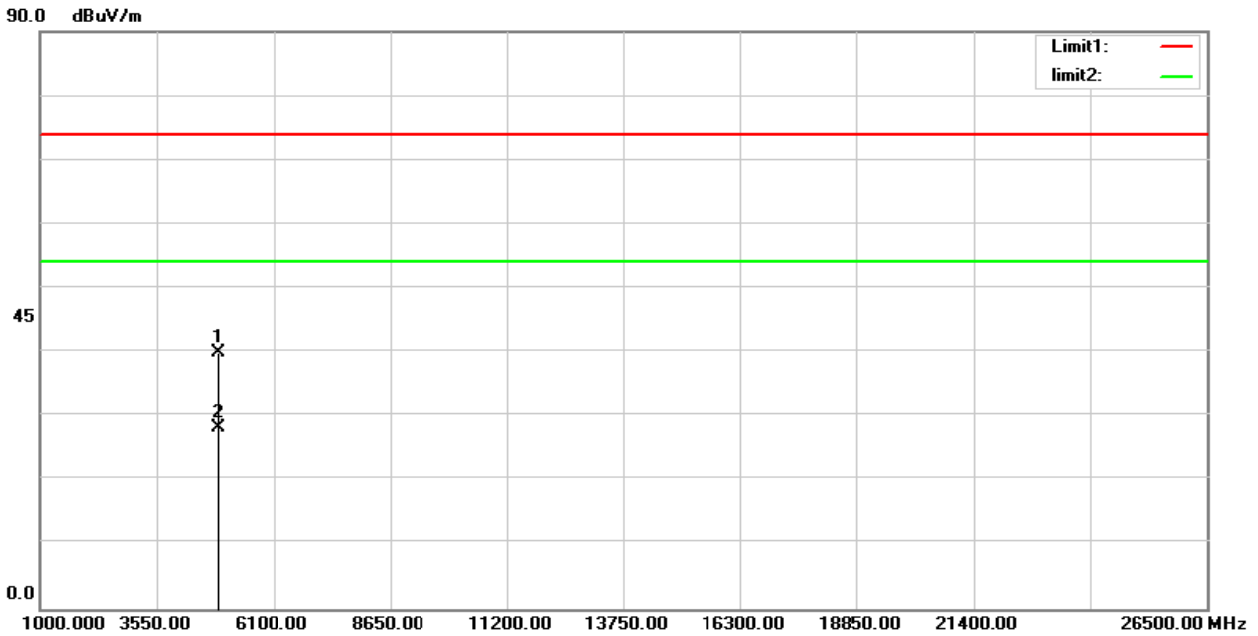

No.	Frequency (MHz)	Reading (dBuV/m)	Correct Factor(dB/m)	Result (dBuV/m)	Limit (dBuV/m)	Margin (dB)	Remark
1	4882.050	48.88	-9.02	39.86	74.00	-34.14	peak
2	4882.050	37.33	-9.02	28.31	54.00	-25.69	AVG

Test Mode: TX 2441 MHz\_CH39\_1Mbps

### Horizontal

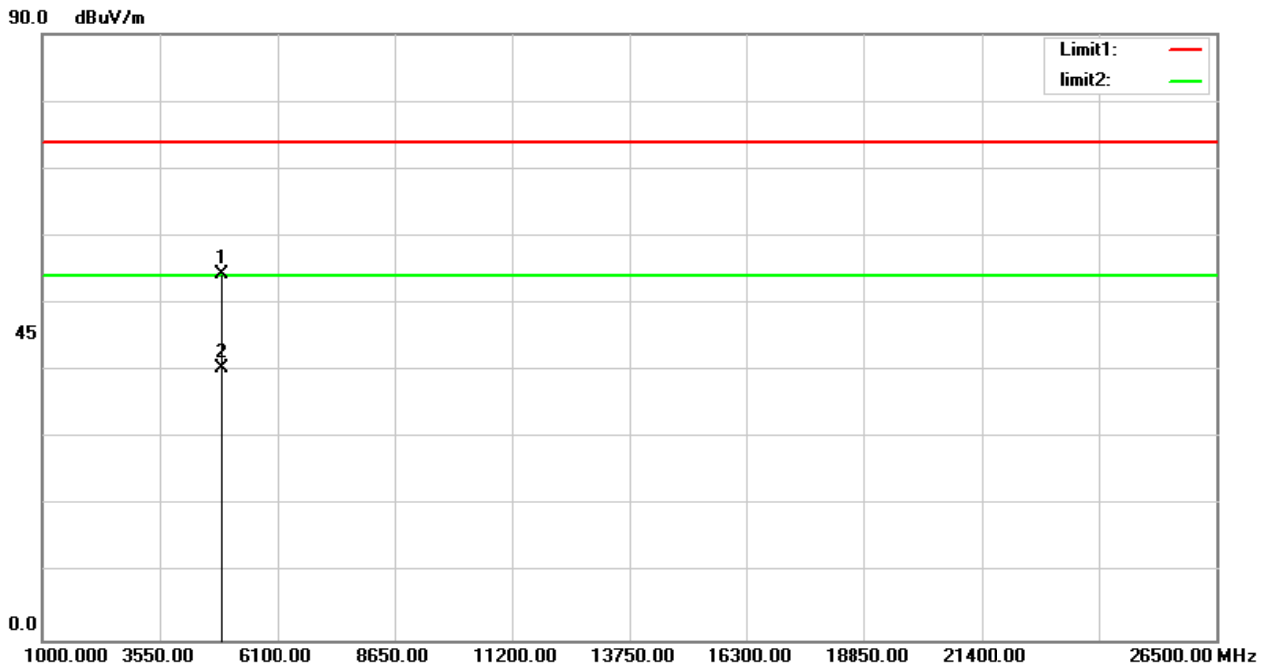

No.	Frequency (MHz)	Reading (dBuV/m)	Correct Factor(dB/m)	Result (dBuV/m)	Limit (dBuV/m)	Margin (dB)	Remark
1	4882.050	63.29	-9.02	54.27	74.00	-19.73	peak
2	4882.050	49.34	-9.02	40.32	54.00	-13.68	AVG

Test Mode: TX 2480 MHz\_CH78\_1Mbps

### Vertical

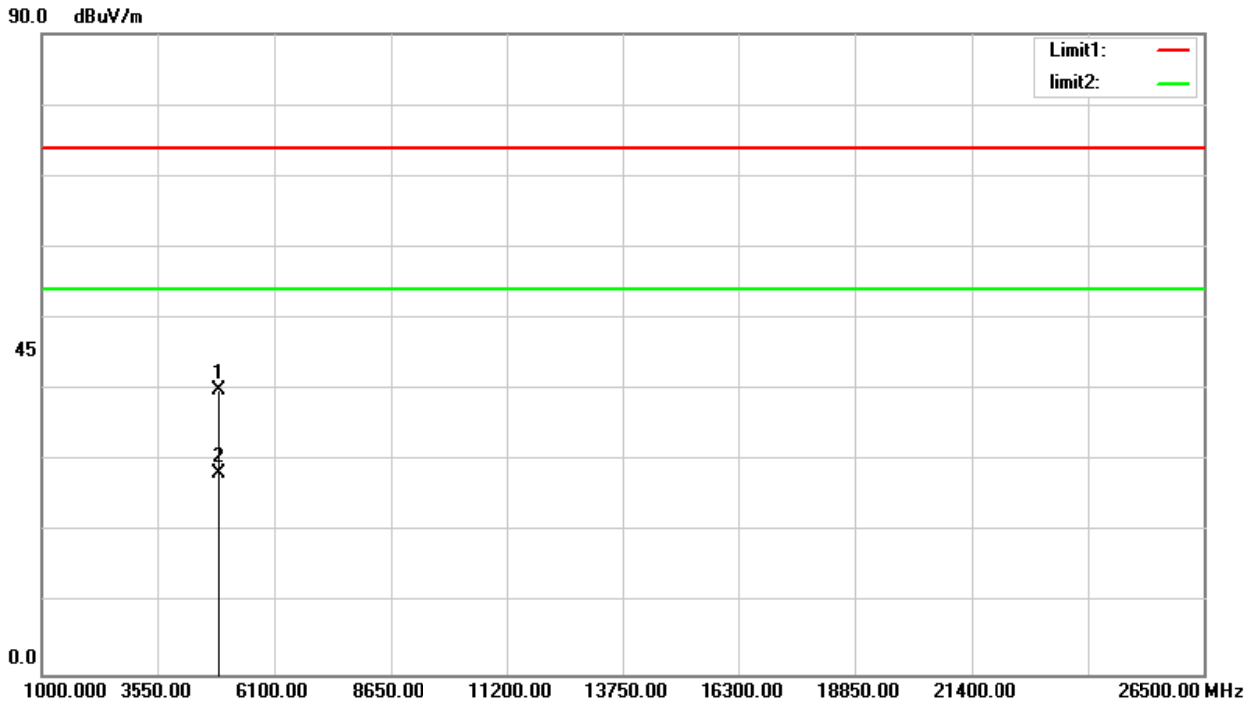

No.	Frequency (MHz)	Reading (dBuV/m)	Correct Factor(dB/m)	Result (dBuV/m)	Limit (dBuV/m)	Margin (dB)	Remark
1	4882.050	48.88	-9.02	39.86	74.00	-34.14	peak
2	4882.050	37.33	-9.02	28.31	54.00	-25.69	AVG

Test Mode: TX 2480 MHz\_CH78\_1Mbps

### Horizontal

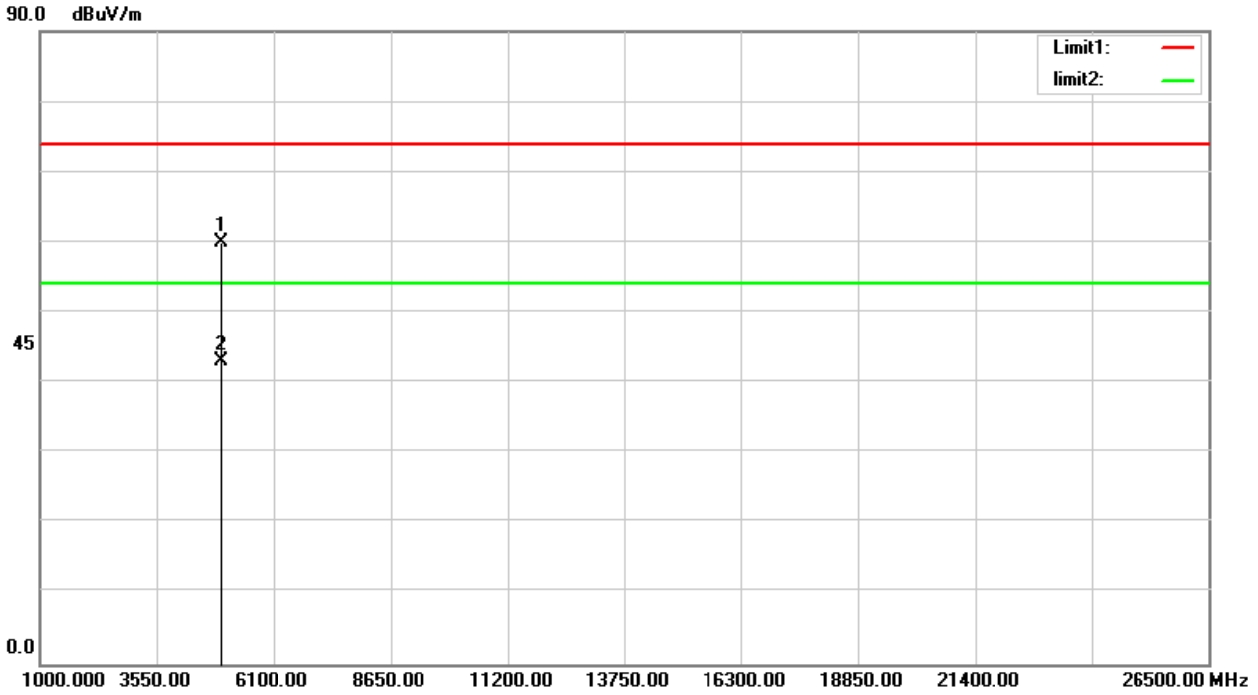

No.	Frequency (MHz)	Reading (dBuV/m)	Correct Factor(dB/m)	Result (dBuV/m)	Limit (dBuV/m)	Margin (dB)	Remark
1	4960.000	68.67	-8.79	59.88	74.00	-14.12	peak
2	4960.000	51.95	-8.79	43.16	54.00	-10.84	AVG

Test Mode: TX 2402 MHz\_CH00\_3Mbps

### Vertical

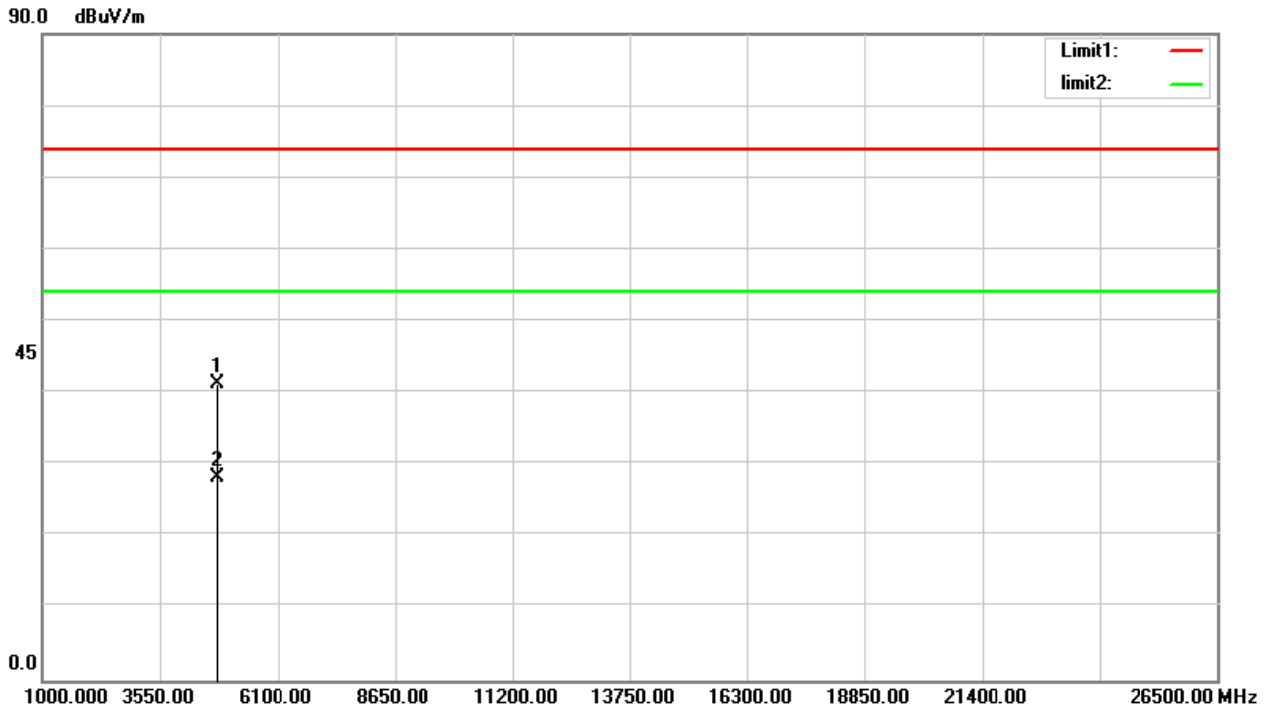

No.	Frequency (MHz)	Reading (dBuV/m)	Correct Factor(dB/m)	Result (dBuV/m)	Limit (dBuV/m)	Margin (dB)	Remark
1	4804.000	50.49	-9.26	41.23	74.00	-32.77	peak
2	4804.000	37.51	-9.26	28.25	54.00	-25.75	AVG

Test Mode: TX 2402 MHz\_CH00\_3Mbps

### Horizontal

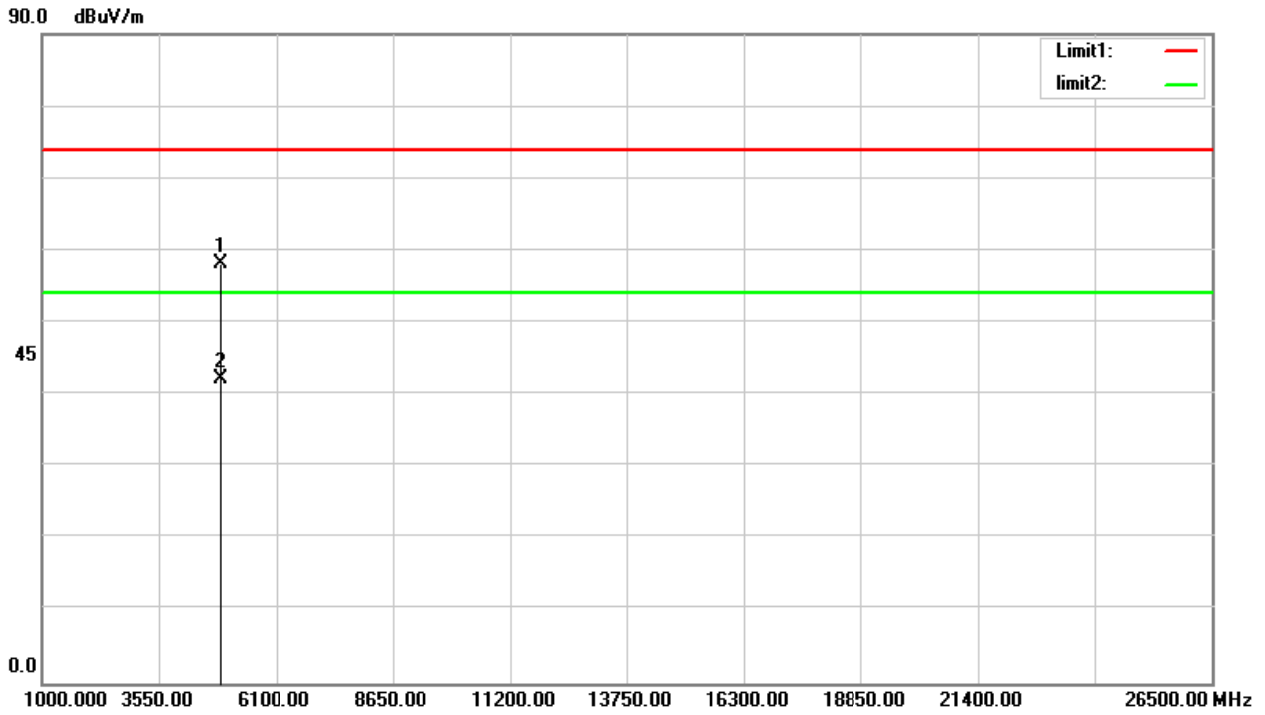

No.	Frequency (MHz)	Reading (dBuV/m)	Correct Factor(dB/m)	Result (dBuV/m)	Limit (dBuV/m)	Margin (dB)	Remark
1	4882.050	67.08	-9.02	58.06	74.00	-15.94	peak
2	4882.050	51.16	-9.02	42.14	54.00	-11.86	AVG

Test Mode: TX 2441 MHz\_CH39\_3Mbps

### Vertical

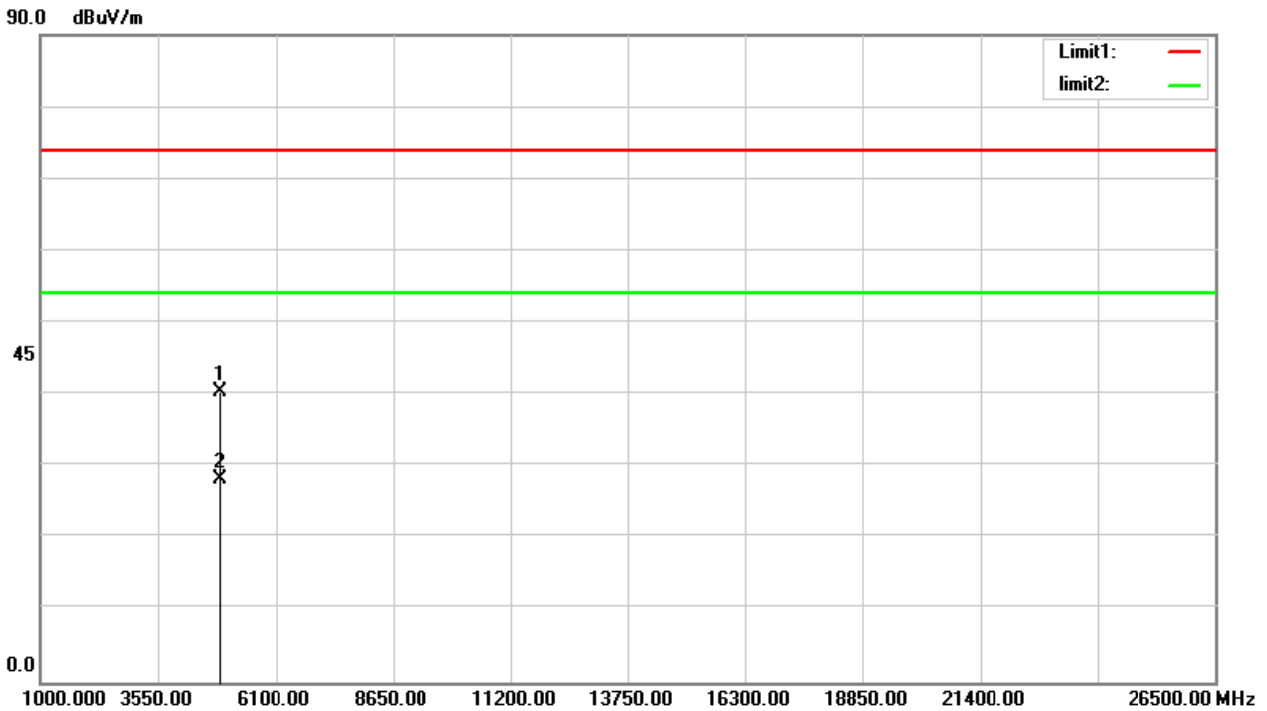

No.	Frequency (MHz)	Reading (dBuV/m)	Correct Factor(dB/m)	Result (dBuV/m)	Limit (dBuV/m)	Margin (dB)	Remark
1	4882.050	49.33	-9.02	40.31	74.00	-33.69	peak
2	4882.050	37.19	-9.02	28.17	54.00	-25.83	AVG

Test Mode: TX 2441 MHz\_CH39\_3Mbps

### Horizontal

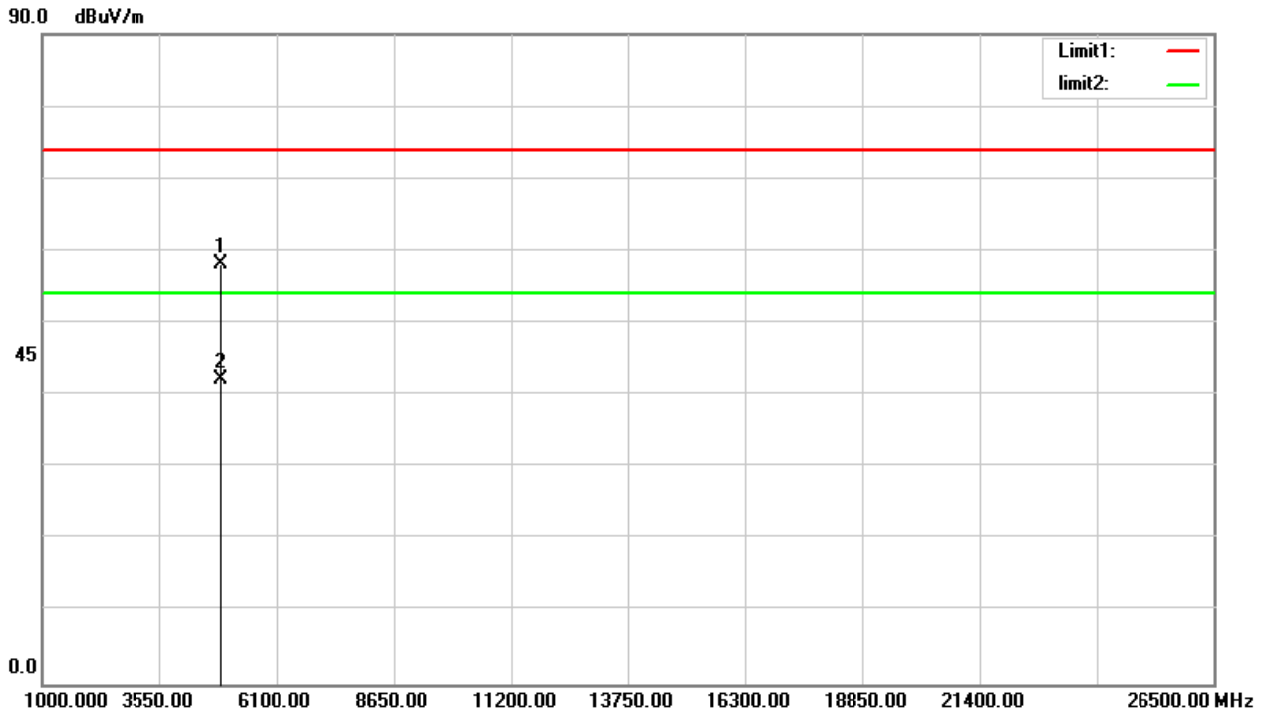

No.	Frequency (MHz)	Reading (dBuV/m)	Correct Factor(dB/m)	Result (dBuV/m)	Limit (dBuV/m)	Margin (dB)	Remark
1	4882.050	67.08	-9.02	58.06	74.00	-15.94	peak
2	4882.050	51.16	-9.02	42.14	54.00	-11.86	AVG



Test Mode: TX 2480 MHz\_CH78\_3Mbps

### Vertical

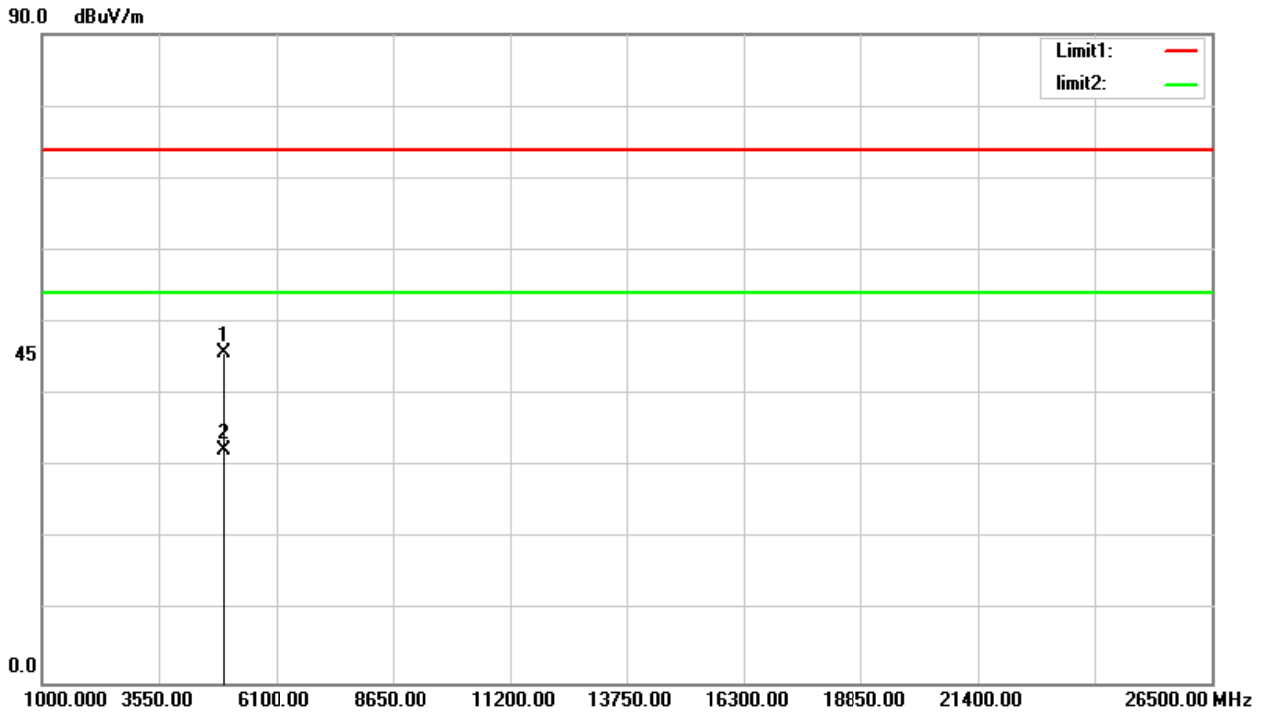

No.	Frequency (MHz)	Reading (dBuV/m)	Correct Factor(dB/m)	Result (dBuV/m)	Limit (dBuV/m)	Margin (dB)	Remark
1	4960.000	54.57	-8.79	45.78	74.00	-28.22	peak
2	4960.000	41.00	-8.79	32.21	54.00	-21.79	AVG

Test Mode: TX 2480 MHz\_CH78\_3Mbps

### Horizontal

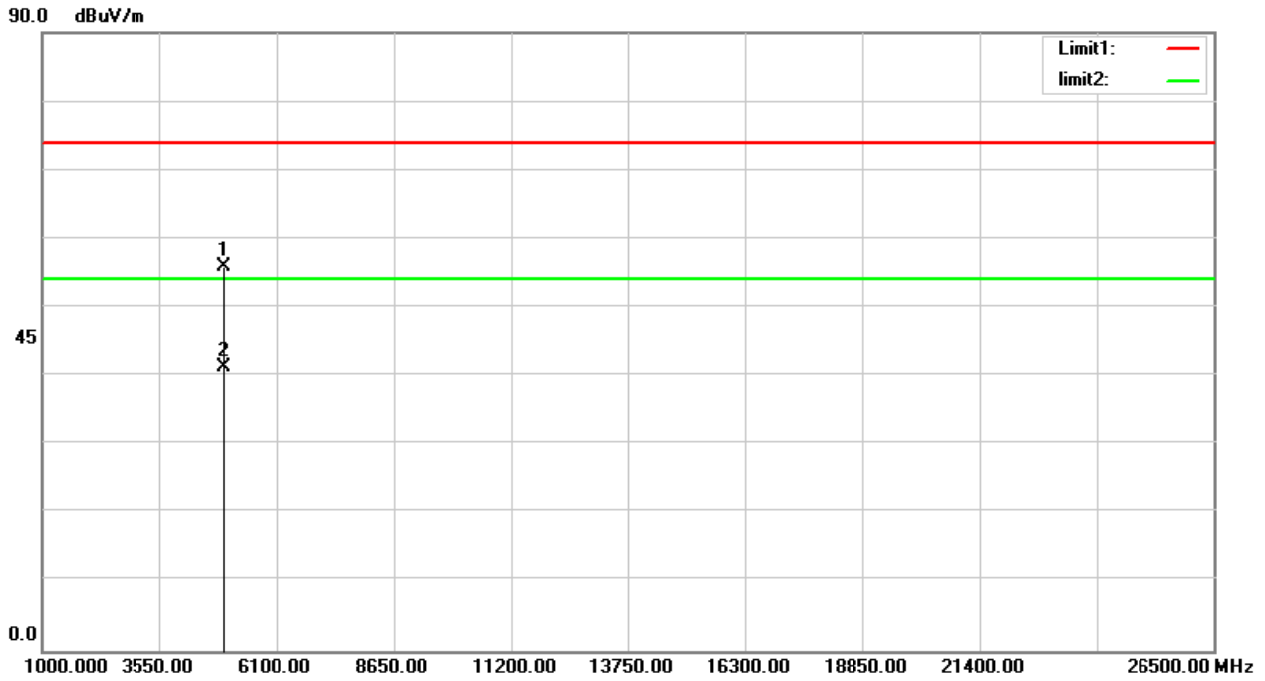

No.	Frequency (MHz)	Reading (dBuV/m)	Correct Factor(dB/m)	Result (dBuV/m)	Limit (dBuV/m)	Margin (dB)	Remark
1	4960.000	64.77	-8.79	55.98	74.00	-18.02	peak
2	4960.000	50.17	-8.79	41.38	54.00	-12.62	AVG

## 6. NUMBER OF HOPPING FREQUENCY

### 6.1 LIMIT

FCC Part15, Subpart C (15.247)&RSS-247	
Section	Test Item
15.247(a)(1)(iii)	Number of Hopping Frequency

### 6.2 TEST PROCEDURE AND SETTING

- The EUT was directly connected to the spectrum analyzer and antenna output port as show in the block diagram below.
- Spectrum Setting: RBW=100 kHz, VBW=300 kHz, Sweep time = Auto.

Spectrum Parameters	Setting
Attenuation	Auto
Span Frequency	> Operating Frequency Range
RBW	100kHz
VBW	300kHz
Detector	Peak
Trace	Max Hold
Sweep Time	Auto

### 6.3 MEASUREMENT INSTRUMENTS LIST

Item	Kind of Equipment	Manufacturer	Type No.	Serial No.	Calibrated until
1	Spectrum analyzer	KEYSIGHT	N9010A	MY55150427	2022/05/28
2	Attenuator	Mini-Circuits	BW-S10W2	101109	N/A
3	RF Cable	Mi-cable	C10-01-01-1	100309	N/A

### 6.4 TEST SETUP

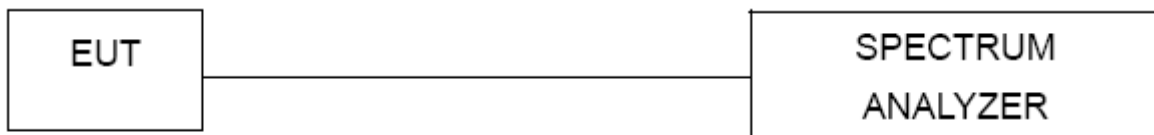

### 6.5 EUT OPERATION CONDITIONS

The EUT tested system was configured as the statements of 4.5 unless otherwise a special operating condition is specified in the follows during the testing.

## 6.6 TEST RESULTS

Hopping Mode_1Mbps		
Number of Hopping Frequency	Measurement result(CH)	Limit(CH)
	79	≥15

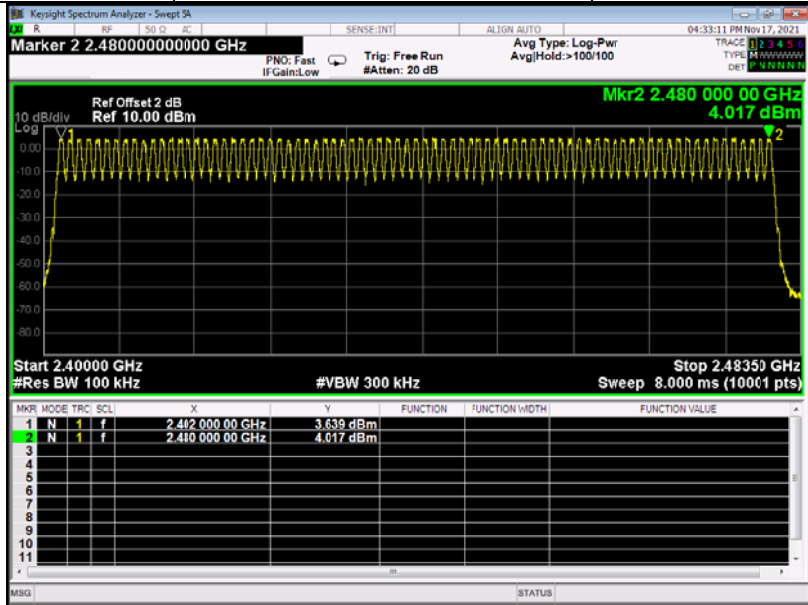

Hopping Mode_3Mbps		
Number of Hopping Frequency	Measurement result(CH)	Limit(CH)
	79	≥15

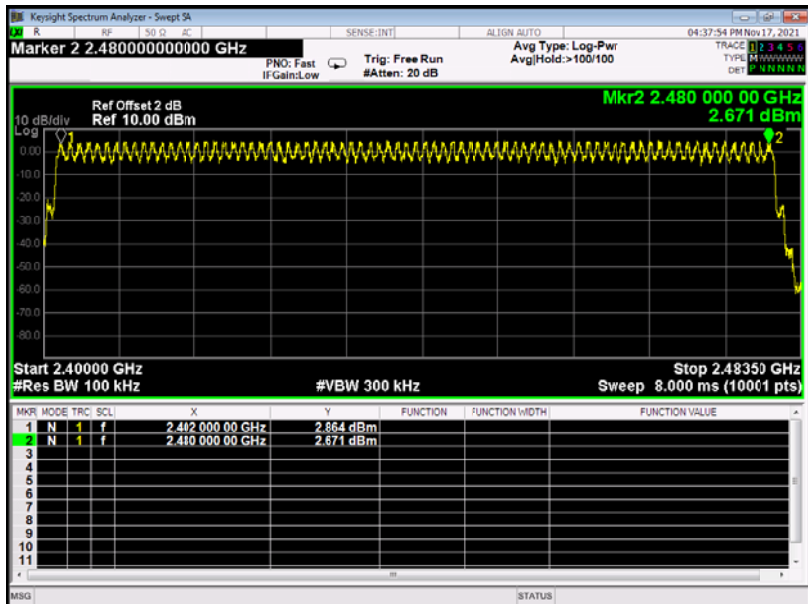

## 7 AVERAGE TIME OF OCCUPANCY

### 7.1 LIMIT

FCC Part15, Subpart C (15.247)&RSS-247		
Section	Test Item	Limit
15.247(a)(1)(iii)	Average Time of Occupancy	0.4sec

### 7.2 TEST PROCEDURE AND SETTING

- a. The transmitter output (antenna port) was connected to the spectrum analyzer
- b. Set RBW of spectrum analyzer to 1MHz and VBW to 1MHz
- c. Use a video trigger with the trigger level set to enable triggering only on full pulses
- d. Sweep Time is more than once pulse time
- e. Set the center frequency on any frequency would be measure and set the frequency span to zero span
- f. Measure the maximum time duration of one single pulse
- g. Set the EUT for DH1, DH3 and DH5 packet transmitting
- h. Measure the maximum time duration of one single pulse
- i. DH1 Packet permit maximum  $1600 / 79 / 2 = 10.12$  hops per second in each channel (1 time slot TX, 1 time slot RX). So, the dwell time is the time duration of the pulse times  $10.12 \times 31.6 = 320$  within 31.6 seconds
- j. DH3 Packet permit maximum  $1600 / 79 / 4 = 5.06$  hops per second in each channel (3 time slots TX, 1 time slot RX). So, the dwell time is the time duration of the pulse times  $5.06 \times 31.6 = 160$  within 31.6 seconds
- k. DH5 Packet permit maximum  $1600 / 79 / 6 = 3.37$  hops per second in each channel (5 time slots TX, 1 time slot RX). So, the dwell time is the time duration of the pulse times  $3.37 \times 31.6 = 106.6$  within 31.6 seconds

### 7.3 MEASUREMENT INSTRUMENTS LIST

Item	Kind of Equipment	Manufacturer	Type No.	Serial No.	Calibrated until
1	Spectrum analyzer	KEYSIGHT	N9010A	MY55150427	2022/05/28
2	Attenuator	Mini-Circuits	BW-S10W2	101109	N/A
3	RF Cable	Mi-cable	C10-01-01-1	100309	N/A

### 7.4 TEST SETUP

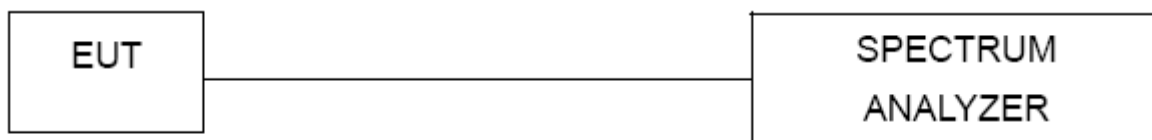

### 7.5 EUT OPERATION CONDITIONS

The EUT tested system was configured as the statements of 4.5 unless otherwise a special operating condition is specified in the follows during the testing.

## 7.6 TEST RESULTS

TX Mode_1Mbps				
Mode	Channel Frequency (MHz)	Pulse Time (ms)	Dwell Time (ms)	Limit (ms)
DH1	2441	0.398	125.8	400
DH3	2441	1.656	264.0	400
DH5	2441	2.904	309.5	400

DH1

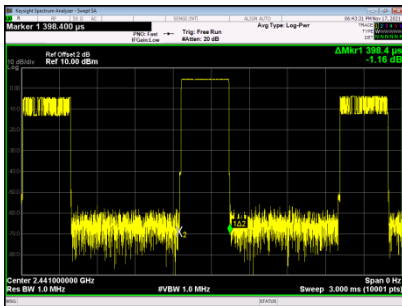

DH3

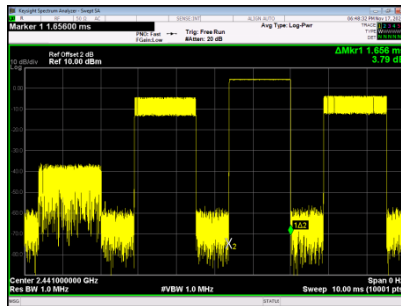

DH5

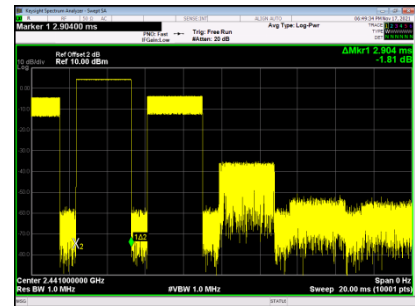

TX Mode_3Mbps				
Mode	Channel Frequency (MHz)	Pulse Time (ms)	Dwell Time (ms)	Limit (ms)
DH1	2441	0.411	128.3	400
DH3	2441	1.656	264.2	400
DH5	2441	2.920	310.2	400

2441MHzDH1

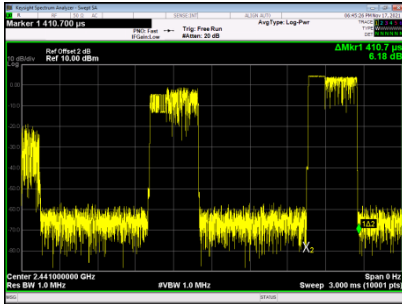

2441MHzDH3



2441MHzDH5

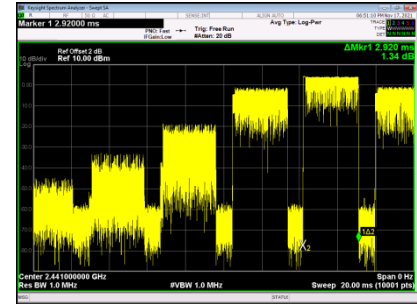

## 8 HOPPING CHANNEL SEPARATION MEASUREMENT

### 8.1 LIMIT

Frequency hopping systems operating in the 2400-2483.5 MHz band may have hopping channel carrier frequencies that are separated by 25 kHz or two-thirds of the 20 dB bandwidth of the hopping channel, whichever is greater, provided the systems operate with an output power no greater than 125 mW.

### 8.2 TEST PROCEDURE AND SETTING

- a. The EUT was directly connected to the spectrum analyzer and antenna output port as show in the block diagram below.
- b. Span = wide enough to capture the peaks of two adjacent channels  
 Resolution (or IF) Bandwidth (RBW)  $\geq$  1% of the span  
 Video (or Average) Bandwidth (VBW)  $\geq$  RBW  
 Sweep = Auto  
 Detector function = Peak  
 Trace = Max Hold

Spectrum Parameter	Setting
Attenuation	Auto
Span Frequency	> Measurement Bandwidth or Channel Separation
RBW	10 kHz
VBW	30 kHz
Detector	Peak
Trace	Max Hold
Sweep Time	Auto

### 8.3 MEASUREMENT INSTRUMENTS LIST

Item	Kind of Equipment	Manufacturer	Type No.	Serial No.	Calibrated until
1	Spectrum analyzer	KEYSIGHT	N9010A	MY55150427	2022/05/28
2	Attenuator	Mini-Circuits	BW-S10W2	101109	N/A
3	RF Cable	Mi-cable	C10-01-01-1	100309	N/A

### 8.4 TEST SETUP

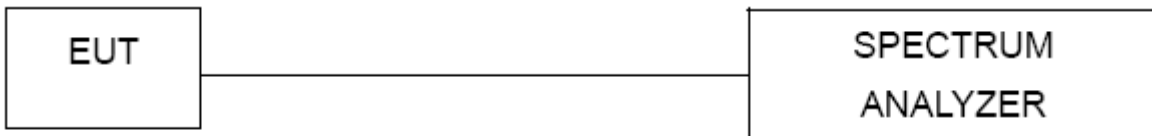

### 8.5 EUT OPERATION CONDITIONS

The EUT tested system was configured as the statements of 4.5 unless otherwise a special operating condition is specified in the follows during the testing.



## 8.6 TEST RESULTS

TX Mode_1Mbps				
Channel	Frequency (MHz)	Channel Separation(MHz)	Limit (MHz)	Result
CH00	2402	1.0020	>(25KHz or 2/3*20dB Bandwidth)	PASS
CH39	2441	1.0032	>(25KHz or 2/3*20dB Bandwidth)	PASS
CH78	2480	0.9954	>(25KHz or 2/3*20dB Bandwidth)	PASS



TX Mode_3Mbps				
Channel	Frequency (MHz)	Channel Separation(MHz)	Limit (MHz)	Result
CH00	2402	1.0038	>(25KHz or 2/3*20dB Bandwidth)	PASS
CH39	2441	1.0050	>(25KHz or 2/3*20dB Bandwidth)	PASS
CH78	2480	1.0047	>(25KHz or 2/3*20dB Bandwidth)	PASS

2402MHz



2441MHz



2480MHz



**9 BANDWIDTH TEST**

**9.1 LIMIT**

FCC Part15, Subpart C (15.247)&RSS-247	
Section	Test Item
15.247(a)(1)	Bandwidth

**9.2 TEST PROCEDURE AND SETTING**

- a. The EUT was directly connected to the spectrum analyzer and antenna output port as show in the block diagram below.
- b. Spectrum Setting: RBW= 30 kHz, VBW=100 kHz, Sweep Time = Auto.

Spectrum Parameter	Setting
Attenuation	Auto
Span Frequency	> Measurement Bandwidth
RBW	30kHz
VBW	100kHz
Detector	Peak
Trace	Max Hold
Sweep Time	Auto

**9.3 MEASUREMENT INSTRUMENTS LIST**

Item	Kind of Equipment	Manufacturer	Type No.	Serial No.	Calibrated until
1	Spectrum analyzer	KEYSIGHT	N9010A	MY55150427	2022/05/28
2	Attenuator	Mini-Circuits	BW-S10W2	101109	N/A
3	RF Cable	Mi-cable	C10-01-01-1	100309	N/A

**9.4 TEST SETUP**

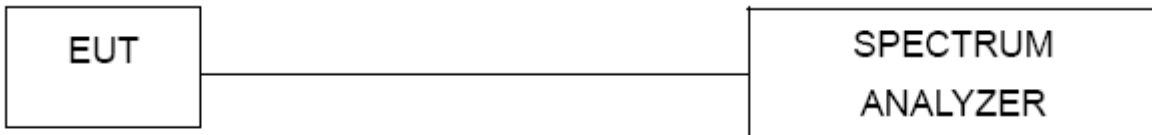

**9.5 EUT OPERATION CONDITIONS**

The EUT tested system was configured as the statements of 4.5 unless otherwise a special operating condition is specified in the follows during the testing.

## 9.6 TEST RESULTS

TX Mode_1Mbps				
Channel	Frequency (MHz)	20dB Bandwidth (MHz)	99 % Emission Bandwidth (MHz)	Result
CH00	2402	0.9263	0.8618	PASS
CH39	2441	0.9268	0.8608	PASS
CH78	2480	0.9254	0.8586	PASS

**2402MHz**

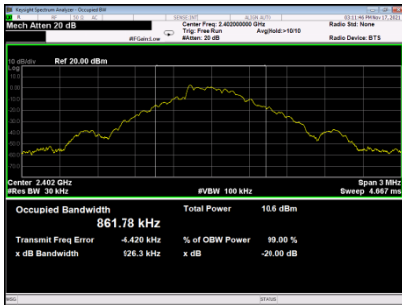

**2441MHz**

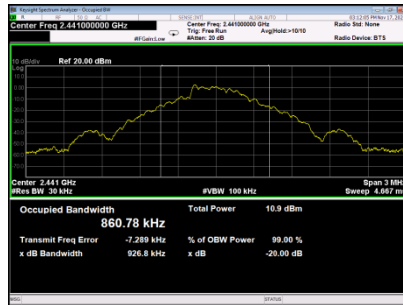

**2480MHz**



TX Mode_3Mbps				
Channel	Frequency (MHz)	20dB Bandwidth (MHz)	99 % Emission Bandwidth (MHz)	Result
CH00	2402	1.234	1.2237	PASS
CH39	2441	1.234	1.2007	PASS
CH78	2480	1.232	1.1862	PASS

2402MHz

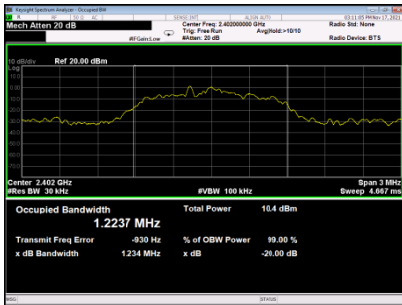

2441MHz

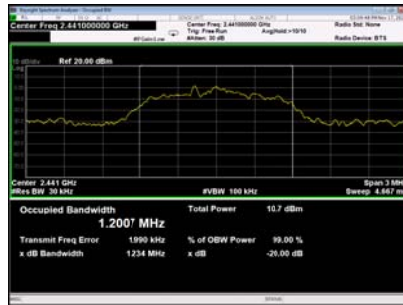

2480MHz

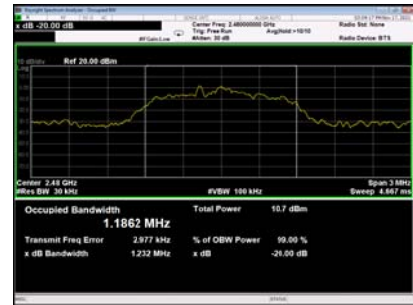

## 10 MAXIMUM OUTPUT POWER

### 10.1 LIMIT

FCC Part15 , Subpart C (15.247)&RSS-247		
Section	Test Item	Limit
15.247(a)(1)	Maximum Output Power	0.125Watt or 21dBm

**Note:**

Frequency hopping systems shall have hopping channel carrier frequencies separated by a minimum of 25 kHz or the 20 dB bandwidth of the hopping channel, whichever is greater. Alternatively, frequency hopping systems operating in the 2400-2483.5 MHz band may have hopping channel carrier frequencies that are separated by 25 kHz or two-thirds of the 20 dB bandwidth of the hopping channel, whichever is greater, provided the systems operate with an output power no greater than 125 mW.

### 10.2 TEST PROCEDURE AND SETTING

- a. The EUT was directly connected to the spectrum analyzer and antenna output port as show in the block diagram below.
- b. Spectrum Setting: RBW= 1MHz/3MHz, VBW= 1MHz/3MHz, Sweep time = Auto.

### 10.3 MEASUREMENT INSTRUMENTS LIST

Item	Kind of Equipment	Manufacturer	Type No.	Serial No.	Calibrated until
1	Spectrum analyzer	KEYSIGHT	N9010A	MY55150427	2022/05/28
2	Attenuator	Mini-Circuits	BW-S10W2	101109	N/A
3	RF Cable	Mi-cable	C10-01-01-1	100309	N/A

### 10.4 TEST SETUP



### 10.5 EUT OPERATION CONDITIONS

The EUT tested system was configured as the statements of 4.5 unless otherwise a special operating condition is specified in the follows during the testing.

### 10.6 TEST RESULTS

TX Mode_1Mbps				
Channel	Frequency (MHz)	Output Power (dBm)	Output Power (W)	Result
CH00	2402	4.274	0.002675	PASS
CH39	2441	4.584	0.002873	PASS
CH78	2480	4.569	0.002864	PASS
Limit	21dBm /0.125W			

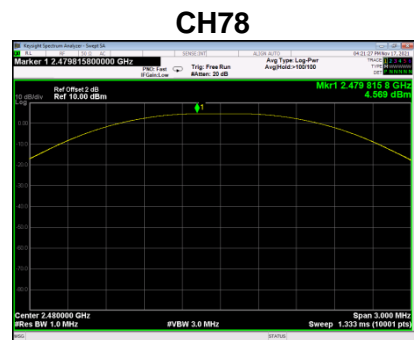
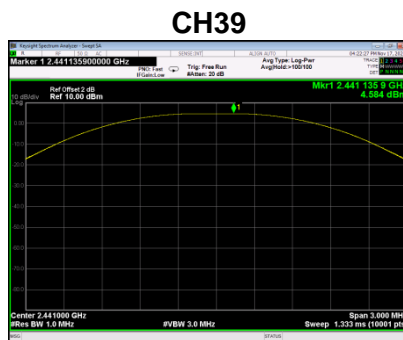
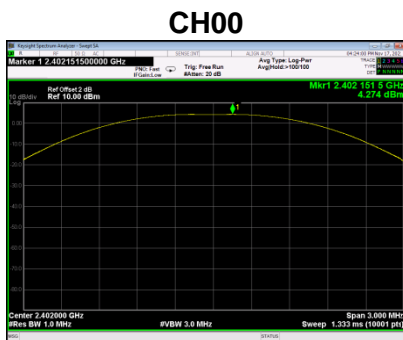

TX Mode_2Mbps				
Channel	Frequency (MHz)	Output Power (dBm)	Output Power (W)	Result
CH00	2402	4.324	0.002706	PASS
CH39	2441	4.598	0.002883	PASS
CH78	2480	4.599	0.002883	PASS
Limit	21dBm /0.125W			

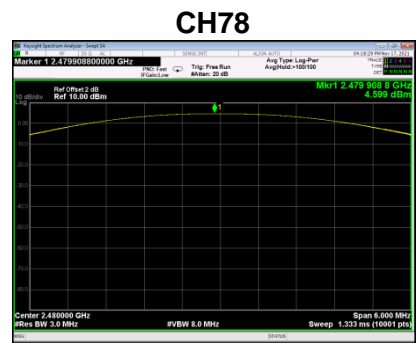
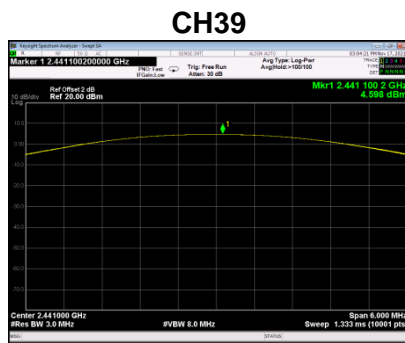
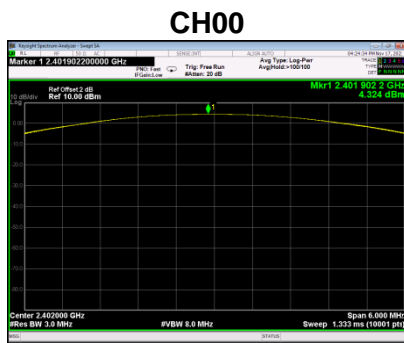



TX Mode_3Mbps				
Channel	Frequency (MHz)	Output Power (dBm)	Output Power (W)	Result
CH00	2402	4.317	0.002702	PASS
CH39	2441	4.635	0.002907	PASS
CH78	2480	4.612	0.002892	PASS
Limit	21dBm /0.125W			

**CH00**

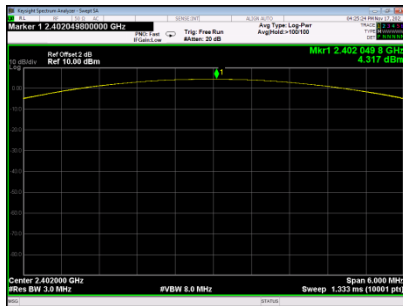

**CH39**

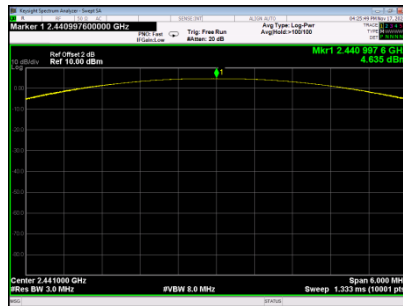

**CH78**

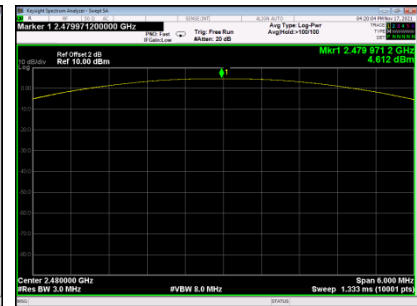

## 11 CONDUCTED SPURIOUS EMISSION

### 11.1 LIMIT

For FCC

In any 100 kHz bandwidth outside the frequency band in which the spread spectrum or digitally modulated intentional radiator is operating, the radio frequency power that is produced by the intentional radiator shall be at least 20 dB below that in the 100 kHz bandwidth within the band that contains the highest level of the desired power, based on either an RF conducted or a radiated measurement, provided the transmitter demonstrates compliance with the peak Output Power limits. If the transmitter complies with the Output Power limits based on the use of RMS averaging over a time interval, as permitted under paragraph (b)(3) of this section, the attenuation required under this paragraph shall be 30 dB instead of 20 dB. Attenuation below the general limits specified in Section 15.209(a) is not required.

### 11.2 TEST PROCEDURE AND SETTING

- a. The EUT was directly connected to the spectrum analyzer and antenna output port as show in the block diagram below.
- b. Spectrum Setting: RBW= 100 kHz, VBW=300 kHz, Sweep time = Auto.

### 11.3 MEASUREMENT INSTRUMENTS LIST

Item	Kind of Equipment	Manufacturer	Type No.	Serial No.	Calibrated until
1	Spectrum analyzer	KEYSIGHT	N9010A	MY55150427	2022/05/28
2	Attenuator	Mini-Circuits	BW-S10W2	101109	N/A
3	RF Cable	Mi-cable	C10-01-01-1	100309	N/A

### 11.4 TEST SETUP



### 11.5 EUT OPERATION CONDITIONS

The EUT tested system was configured as the statements of 4.5 unless otherwise a special operating condition is specified in the follows during the testing.

## 11.6 TEST RESULTS

### TX Mode\_1Mbps

**Bandedge- CH00 (Lower)**

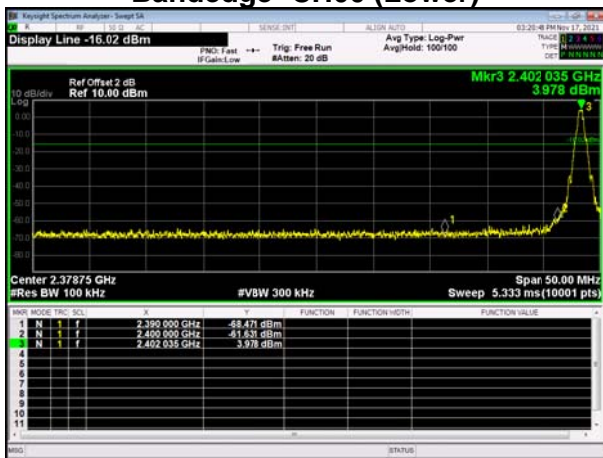

**Bandedge CH78 (Upper)**

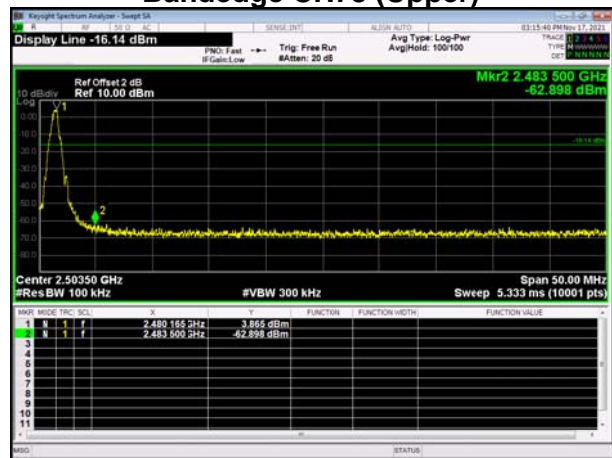

**Bandedge- Hopping on (Lower)**

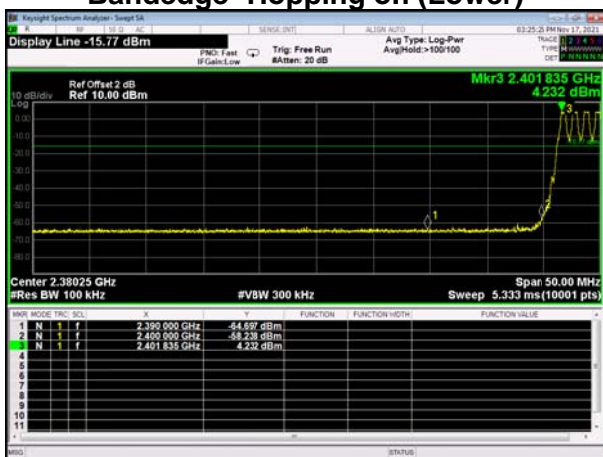

**Bandedge Hopping on (Upper)**

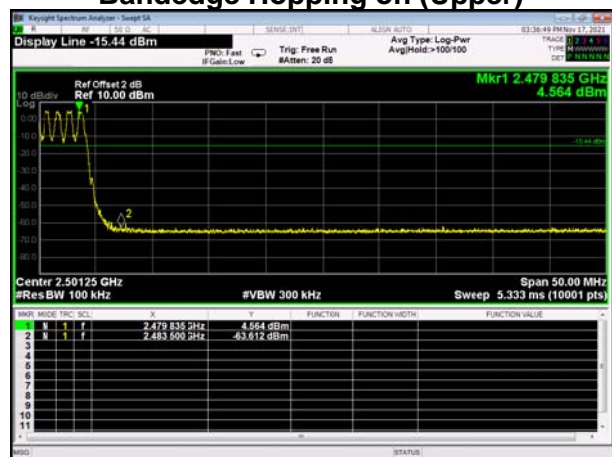

### 10th Harmonic of the fundamental frequency

**CH00**

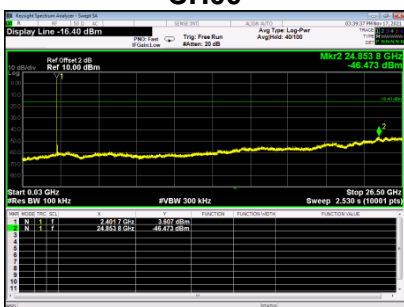

**CH39**

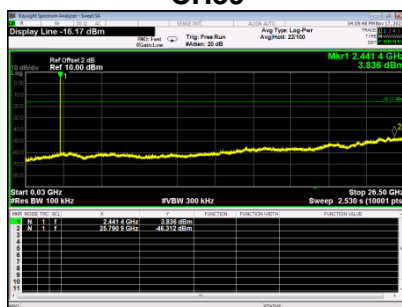

**CH78**

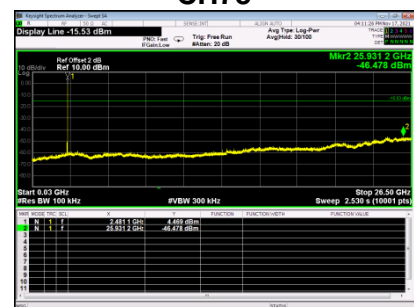

**TX Mode\_3Mbps**

**Bandedge- CH00 (Lower)**

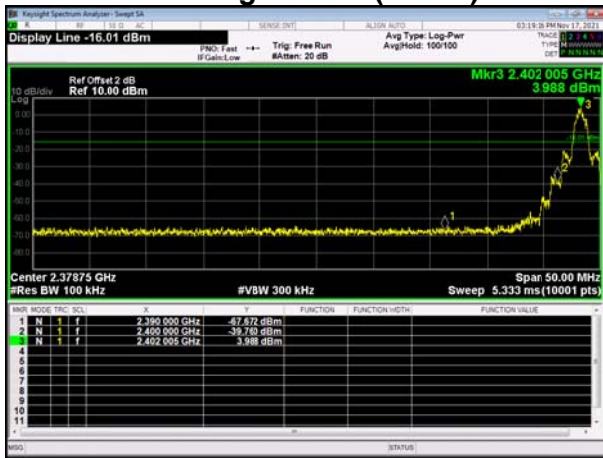

**Bandedge CH78 (Upper)**

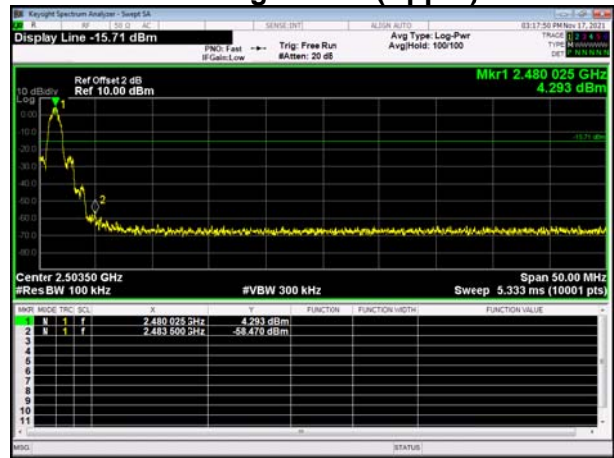

**Bandedge- Hopping on (Lower)**

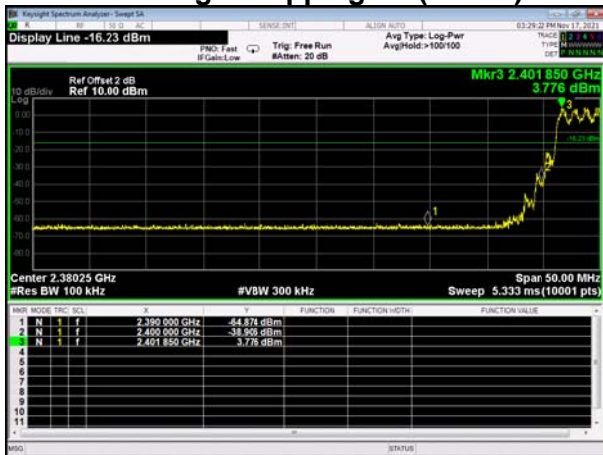

**Bandedge- Hopping on (Upper)**

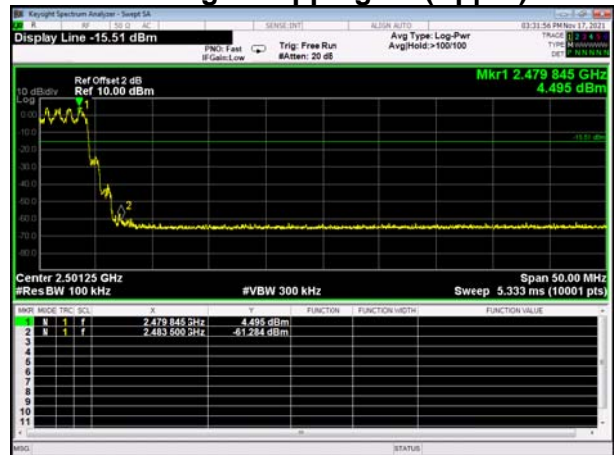

**10th Harmonic of the fundamental frequency**

**CH00**

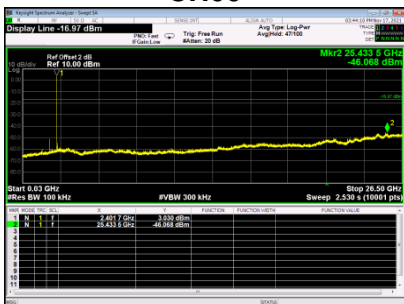

**CH39**

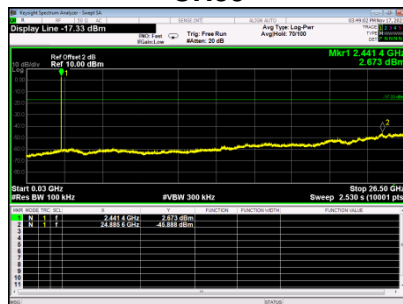

**CH78**

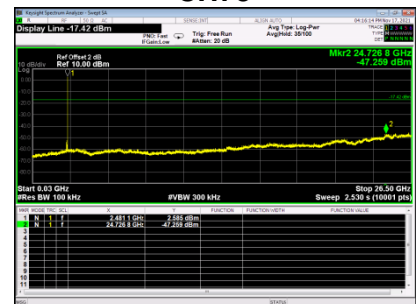

**END OF TEST REPORT**