

FCC Radio Test Report FCC ID:2AFAX-BDSX

The report concerns: Original Grant

Report Reference No.....: 19EAFS12022 4591

Date Sample(s) Received.....: 2019-12-04

Date of Tested.....: 2019-12-04~2019-12-19

Date of issue.....: 2019-12-20

Testing Laboratory: DongGuan ShuoXin Electronic Technology Co., Ltd.
Zone A, 1F, No. 6, XinGang Road YuanGang Street,
Address: XinAn District, ChangAn Town, DongGuan City,
GuangDong, China

Applicant's name: BOOMPODS (HK) LTD.

Address: RM 303-304 Hankow Centre 5-15,Hankow Road
T.S.T. Kowloon,HONG KONG.

Manufacturer.....: Dongguan Linyar Technology Co.,Ltd.

Equipment.....: true wireless earphone

Trade Mark: N/A

Model: boombuds x

Ratings: I/P: DC 3.7V by Li-ion Battery
Charging by micro-usb DC 5V

Responsible Engineer :

Smile Wang

Authorized Signatory:



King Wang

Table of Contents

Page

1 . TEST REPORT DECLARE	5
2 . SUMMARY OF TEST RESULTS	6
2.1 MEASUREMENT UNCERTAINTY	7
3 . GENERAL INFORMATION	8
3.1 GENERAL DESCRIPTION OF EUT	8
3.2 DESCRIPTION OF TEST MODES	10
3.3 PARAMETERS OF TEST SOFTWARE	11
3.4 BLOCKDIAGRAMSHOWINGTHECONFIGURATIONOFSYSTEMTESTED	11
3.5 SUPPORT UNITS	11
3.6 TEST ENVIRONMENT CONDITIONS	12
4 .AC POWER LINE CONDUCTED EMISSIONS TEST	13
4.1 LIMIT	13
4.2 TEST PROCEDURE	13
4.3 MEASUREMENT INSTRUMENTS LIST	13
4.4 TESTSETUP	14
4.5 EUT OPERATING CONDITIONS	14
4.6 TEST RESULTS	15
5 . RADIATED EMISSION TEST	17
5.1 LIMIT	17
5.2 TEST PROCEDURE AND SETTING	18
5.3 MEASUREMENT INSTRUMENTS LIST	19
5.4 TESTSETUP	19
5.5 EUT OPERATING CONDITIONS	20
5.6 TEST RESULTS - 9 KHZ TO 30MHZ	21
5.7 TEST RESULTS- 30 MHZ TO 1000MHZ	22
5.8 TEST RESULTS - ABOVE 1000MHZ(BAND EDGE)	24
5.9 TEST RESULTS - ABOVE 1000MHZ(HARMONIC)	32
6 .NUMBER OF HOPPING FREQUENCY	44
6.1 LIMIT	44
6.2 TEST PROCEDURE AND SETTING	44
6.3 MEASUREMENT INSTRUMENTS LIST	44
6.4 TEST SETUP	44

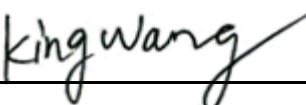
Table of Contents	Page
6.5 EUT OPERATION CONDITIONS	44
6.6 TEST RESULTS	45
7 .AVERAGE TIME OF OCCUPANCY	46
7.1 LIMIT	46
7.2 TEST PROCEDURE AND SETTING	46
7.3 MEASUREMENT INSTRUMENTS LIST	46
7.4 TEST SETUP	46
7.5 EUT OPERATION CONDITIONS	46
7.6 TEST RESULTS	47
8 .HOPPING CHANNEL SEPARATION MEASUREMENT	49
8.1 LIMIT	49
8.2 TEST PROCEDURE AND SETTING	49
8.3 MEASUREMENT INSTRUMENTS LIST	49
8.4 TEST SETUP	49
8.5 EUT OPERATION CONDITIONS	49
8.6 TEST RESULTS	50
9 .BANDWIDTH TEST	52
9.1 LIMIT	52
9.2 TEST PROCEDURE AND SETTING	52
9.3 MEASUREMENT INSTRUMENTS LIST	52
9.4 TEST SETUP	52
9.5 EUT OPERATION CONDITIONS	52
9.6 TEST RESULTS	53
10 .MAXIMUM OUTPUT POWER	55
10.1 LIMIT	55
10.2 TEST PROCEDURE AND SETTING	55
10.3 MEASUREMENT INSTRUMENTS LIST	55
10.4 TEST SETUP	55
10.5 EUT OPERATION CONDITIONS	55
10.6 TEST RESULTS	56
11 .CONDUCTED SPURIOUS EMISSION	59
11.1 LIMIT	59
11.2 TEST PROCEDURE AND SETTING	59
11.3 MEASUREMENT INSTRUMENTS LIST	59

Table of Contents

Page

11.4 TEST SETUP	59
11.5 EUT OPERATION CONDITIONS	59
11.6 TEST RESULTS	60

1. TEST REPORT DECLARE

Applicant	BOOMPODS (HK) LTD.
Address	RM 303-304 Hankow Centre 5-15,Hankow Road T.S.T. Kowloon,HONG KONG.
Manufacturer	Dongguan Linyar Technology Co.,Ltd.
Address	No.2,PujiangRoad,DaningCommunity,Humen,Dongguan,Guangdong,China.
Factory	Dongguan Linyar Technology Co.,Ltd.
Address	No.2,PujiangRoad,DaningCommunity,Humen,Dongguan,Guangdong,China.
Equipment Name	true wireless earphone
Model No.	boombuds x
Trade Mark	N/A
Standard	FCC Part15, Subpart C (15.247) ANSI C63.10-2013

We Declare:

The equipment described above is tested by DongGuan ShuoXin Electronic Technology Co., Ltd. and in the configuration tested the equipment complied with the standards specified above. The test results are contained in this test report and DongGuan ShuoXin Electronic Technology Co., Ltd. is assumed of full responsibility for the accuracy and completeness of these tests.

2. SUMMARY OF TEST RESULTS

The EUT have been tested according to the applicable standards as referenced below:

Standard(s) Section		Test Item	Judgment	Remark
FCC	ISED			
15.207	-----	AC Power Line Conducted Emissions	PASS	-----
15.247(d) 15.205(a) 15.209(a)	-----	Radiated Emission	PASS	-----
15.247(a)(1)(iii)	-----	Number of Hopping Frequency	PASS	-----
15.247(a)(1)(iii)	-----	Average Time Of Occupancy	PASS	-----
15.247(a)(1)	-----	Hopping Channel Separation	PASS	-----
15.247(a)(1)	-----	Bandwidth	PASS	-----
15.247(a)(1)	-----	Maximum Output Power	PASS	-----
15.247(d)	-----	Conducted Spurious Emission	PASS	-----
	-----	Frequency Stability	N/A	-----
15.203	-	Antenna Requirement	PASS	Note(2)

Note:

- (1) "N/A" denotes test is not applicable in this test report
- (2) The device what use a permanently attached antenna were considered sufficient to comply with the provisions of 15.203.

2.1 MEASUREMENT UNCERTAINTY

Test Item	Uncertainty
Uncertainty for Conduction emission test (9kHz-150kHz)	3.7 dB
Uncertainty for Conduction emission test (150kHz-30MHz)	3.3 dB
Uncertainty for Radiation Emission test (30MHz-200MHz)	4.60 dB (Polarize: V)
	4.60 dB (Polarize: H)
Uncertainty for Radiation Emission test (200MHz-1GHz)	6.10 dB (Polarize: V)
	5.08 dB (Polarize: H)
Uncertainty for Radiation Emission test (1GHz-6GHz)	5.01 dB (Polarize: V)
	5.01 dB (Polarize: H)
Uncertainty for Radiation Emission test (6GHz-18GHz)	5.26 dB (Polarize: V)
	5.26 dB (Polarize: H)
Uncertainty for Radiation Emission test (18GHz-40GHz)	5.06 dB (Polarize: V)
	5.06 dB (Polarize: H)
Uncertainty for radio frequency	±0.048kHz
Uncertainty for conducted RF Power	±0.32dB

Note:

This uncertainty represents an expanded uncertainty expressed at approximately the 95% confidence level using a coverage factor of k=2.

3. GENERAL INFORMATION

3.1 GENERAL DESCRIPTION OF EUT

Equipment	true wireless earphone	
Brand Name	N/A	
Test Model	boombuds x	
Series Model	/	
Model Difference(s)	/	
Hardware Version	V2.1	
Software Version	V1.1	
Power Rating	Charging by micro-usb DC 5V DC 3.7V by Li-ion Battery	
Operation Frequency	2402 MHz ~ 2480 MHz	
Modulation Technology	GFSK, $\pi/4$ -DQPSK, 8-DPSK	
Bit Rate of Transmitter	1Mbps /2Mbps /3Mbps	
Antenna Information	Antenna Type: Chip	Maximum Peak Gain:3.19dBi
Max. Output Power	1Mbps: 1.895 dBm (0.001547 W) 2Mbps: 3.031 dBm (0.002010 W) 3Mbps: 3.048 dBm (0.002017 W)	

Note:

1. For a more detailed features description, please refer to the manufacturer's specifications or the user's manual.

2. Channel List:

Channel	Frequency (MHz)	Channel	Frequency (MHz)	Channel	Frequency (MHz)
00	2402	27	2429	54	2456
01	2403	28	2430	55	2457
02	2404	29	2431	56	2458
03	2405	30	2432	57	2459
04	2406	31	2433	58	2460
05	2407	32	2434	59	2461
06	2408	33	2435	60	2462
07	2409	34	2436	61	2463
08	2410	35	2437	62	2464
09	2411	36	2438	63	2465
10	2412	37	2439	64	2466
11	2413	38	2440	65	2467
12	2414	39	2441	66	2468
13	2415	40	2442	67	2469
14	2416	41	2443	68	2470
15	2417	42	2444	69	2471
16	2418	43	2445	70	2472
17	2419	44	2446	71	2473
18	2420	45	2447	72	2474
19	2421	46	2448	73	2475
20	2422	47	2449	74	2476
21	2423	48	2450	75	2477
22	2424	49	2451	76	2478
23	2425	50	2452	77	2479
24	2426	51	2453	78	2480
25	2427	52	2454		
26	2428	53	2455		

3.2 DESCRIPTION OF TEST MODES

The test system was pre-tested based on the consideration of all possible combinations of EUT operation mode.

Prefest Mode	Description
Mode 1	TX Mode NOTE (1)
Mode 2	TX Mode Channel 00 _3Mbps

Following mode(s) was (were) found to be the worst case(s) and selected for the final test.

AC power line conducted emissions test	
Final Test Mode	Description
Mode 2	TX Mode Channel 00 _3Mbps

Radiated emissions test - Below 1GHz	
Final Test Mode	Description
Mode 2	TX Mode Channel 00 _3Mbps

Radiated emissions test - Above 1GHz	
Final Test Mode	Description
Mode 1	TX Mode NOTE (1)

Conducted test	
Final Test Mode	Description
Mode 1	TX Mode NOTE (1)

Note:

- (1) The measurements are performed at the high, middle, low available channels.
- (2) The measurements for Hopping Channel Separation, Bandwidth and Maximum Output Power were tested during 1Mbps, 2Mbps and 3Mbps, the worst case are 1Mbps and 3Mbps, only worst case was documented.

3.3PARAMETERS OF TEST SOFTWARE

During testing, channel & power controlling software provided by the customer was used to control the operating channel as well as the output power level. The RF output power selection is for the setting of RF output power expected by the customer and is going to be fixed on the firmware of the final end product power parameters of FHSS

Test Software	BT-Tool		
Frequency (MHz)	2402	2441	2480
Parameters(1Mbps)	7	7	7
Parameters(2Mbps)	7	7	7
Parameters(3Mbps)	7	7	7

3.4BLOCKDIAGRAMSHOWINGTHECONFIGURATIONOFSYSTEMTESTED

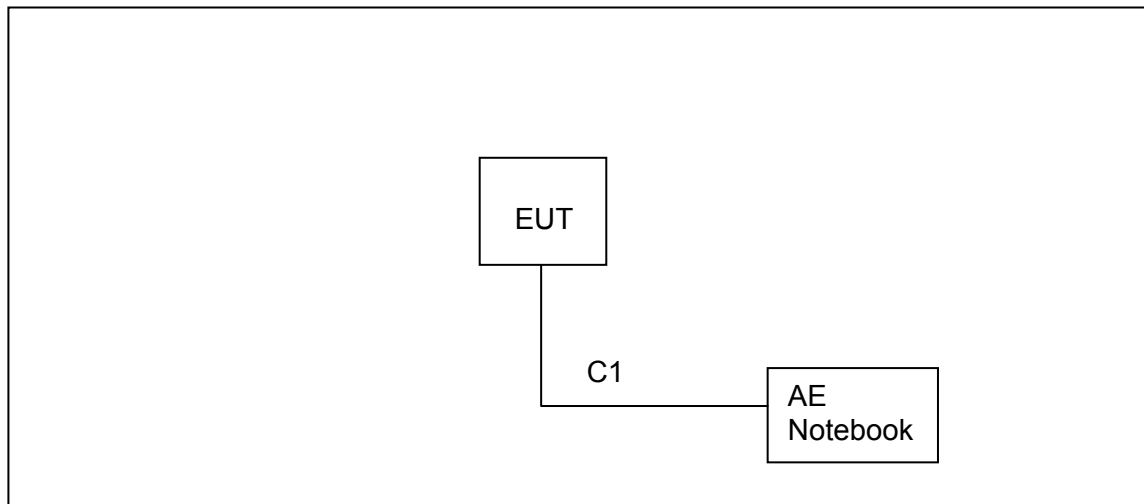

3.5SUPPORT UNITS

Item	Equipment	Brand	Model No.	Series No.
AE	Notebook	ACER	MS2367	32807810766

Item	Cable Type	Shielded Type	Ferrite Core	Length
C1	DC Cable	NO	NO	0.8m

3.6 TEST ENVIRONMENT CONDITIONS

Test Item	Temperature	Humidity	Test Voltage
AC Power Line Conducted Emissions	25°C	53%	DC 5V
Radiated Emissions-9K-30MHz	25°C	60%	DC 3.7V
Radiated Emissions-30 MHz to 1GHz	24°C	68%	DC 3.7V
Radiated Emissions-Above 1000 MHz	24°C	68%	DC 3.7V
Number of Hopping Frequency	24.8°C	40.9%	DC 3.7V
Average Time Of Occupancy	24.8°C	40.9%	DC 3.7V
Hopping Channel Separation	24.8°C	40.9%	DC 3.7V
Bandwidth	24.8°C	40.9%	DC 3.7V
Maximum Output Power	24.8°C	40.9%	DC 3.7V
Conducted Spurious Emission	24.8°C	40.9%	DC 3.7V

4.AC POWER LINE CONDUCTED EMISSIONS TEST

4.1LIMIT

Frequency of Emission (MHz)	Limit (dBµV)	
	Quasi-peak	Average
0.15 - 0.50	66 to 56*	56 to 46*
0.50 - 5.0	56	46
5.0 - 30.0	60	50

Note:

- (1) The tighter limit applies at the band edges.
- (2) The limit of " * " marked band means the limitation decreases linearly with the logarithm of the frequency in the range.

The following table is the setting of the receiver

Receiver Parameters	Setting
Attenuation	10 dB
Start Frequency	0.15 MHz
Stop Frequency	30 MHz
IF Bandwidth	9 kHz

4.2TEST PROCEDURE

- a. The EUT was placed 0.8 meters from the horizontal ground plane with EUT being connected to the power mains through a line impedance stabilization network (LISN). All other support equipment powered from additional LISN(s). The LISN provide 50 Ohm/ 50uH of coupling impedance for the measuring instrument.
- b. Interconnecting cables that hang closer than 40 cm to the groundplane shall be folded back and forth in the center forming a bundle 30 to 40 cm long.
- c. I/O cables that are not connected to a peripheral shall be bundled in the center. The end of the cable may be terminated, if required, using the correct terminating impedance. The overall length shall not exceed 1 m.
- d. LISN at least 80 cm from nearest part of EUT chassis.

4.3MEASUREMENT INSTRUMENTS LIST

Item	Kind of Equipment	Manufacturer	Type No.	Serial No.	Calibrated until
1	Pulse Limiter	MTS-systemtechnik	MTS-IMP-136	261115-010-0024	12/11/2020
2	EMI Test Receiver	R&S	ESCI	101308	12/13/2020
3	LISN	AFJ	LS16	16011103219	06/09/2020
4	LISN	Schwarzbeck	NSLK 8127	8127-432	12/11/2020
5	Measurement Software	Farad	EZ-EMC (Ver.ATT-03A)	N/A	N/A

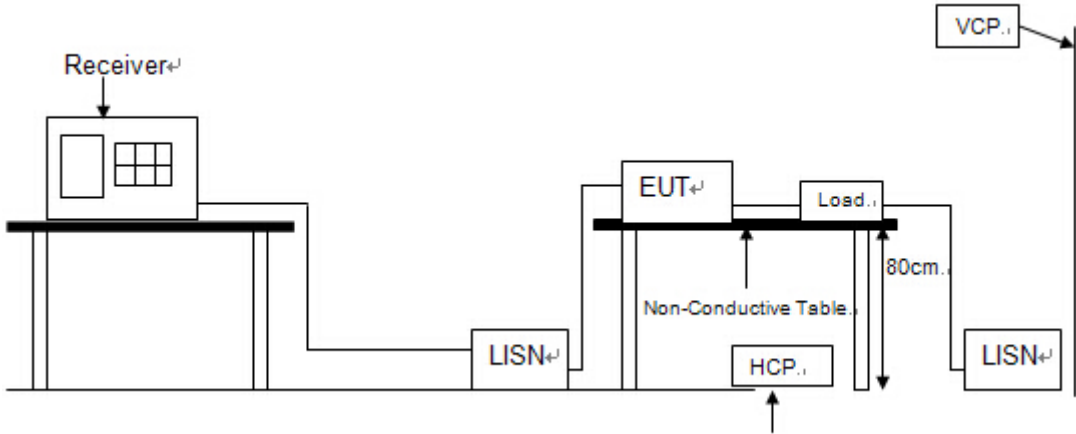
4.4 TEST SETUP**4.5 EUT OPERATING CONDITIONS**

The EUT was configured for testing in a typical function (as a customer would normally use it), EUT was programmed to be in continuously transmitting data or hopping on mode.

4.6 TEST RESULTS

Test Mode: TX Mode Channel 00 _3Mbps

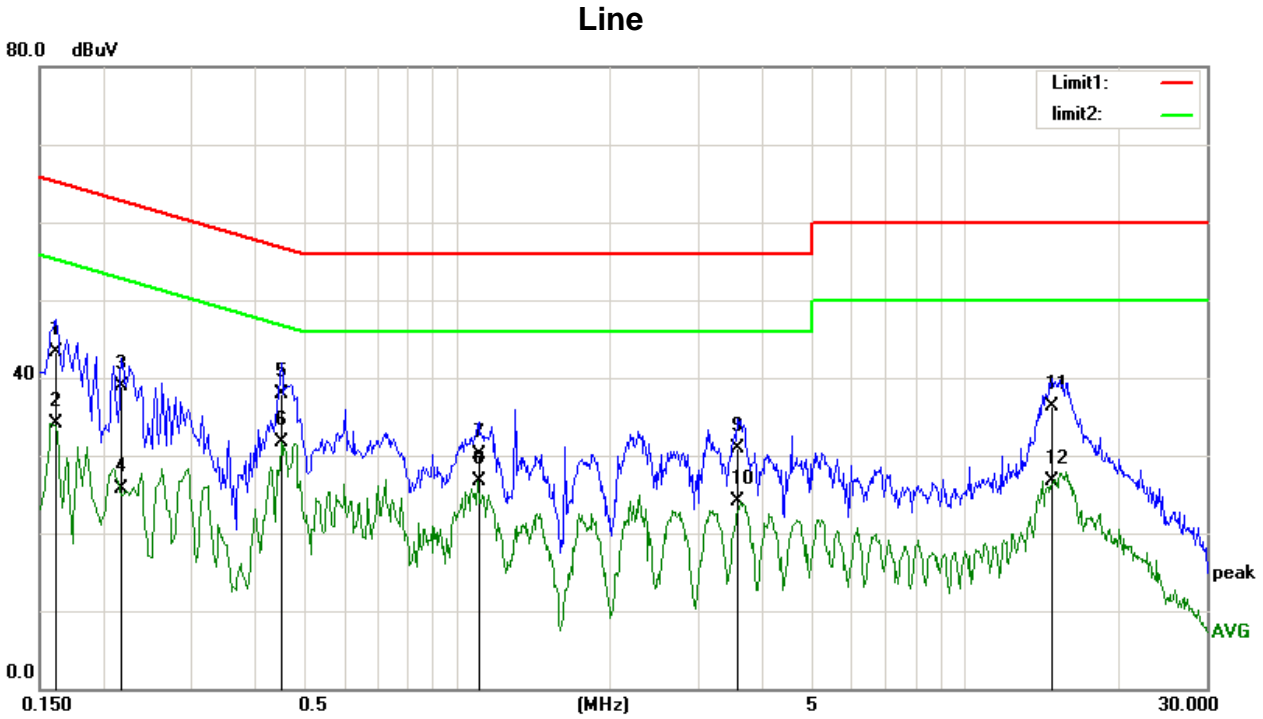

No.	Frequency (MHz)	Reading (dBuV)	Correct Factor(dB)	Result (dBuV)	Limit (dBuV)	Margin (dB)	Remark
1	0.1620	31.87	11.39	43.26	65.36	-22.10	QP
2	0.1620	22.67	11.39	34.06	55.36	-21.30	AVG
3	0.2180	27.98	11.00	38.98	62.89	-23.91	QP
4	0.2180	14.69	11.00	25.69	52.89	-27.20	AVG
5	0.4500	27.75	10.24	37.99	56.87	-18.88	QP
6	0.4500	21.52	10.24	31.76	46.87	-15.11	AVG
7	1.1019	19.92	10.10	30.02	56.00	-25.98	QP
8	1.1019	16.54	10.10	26.64	46.00	-19.36	AVG
9	3.5780	20.70	10.15	30.85	56.00	-25.15	QP
10	3.5780	13.94	10.15	24.09	46.00	-21.91	AVG
11	14.9059	26.08	10.17	36.25	60.00	-23.75	QP
12	14.9059	16.63	10.17	26.80	50.00	-23.20	AVG

Remarks:

- (1) Measurement Value = Reading Level + Correct Factor.
- (2) Margin Level = Measurement Value - Limit Value.

Test Mode: TX Mode Channel 00 _3Mbps

Neutral

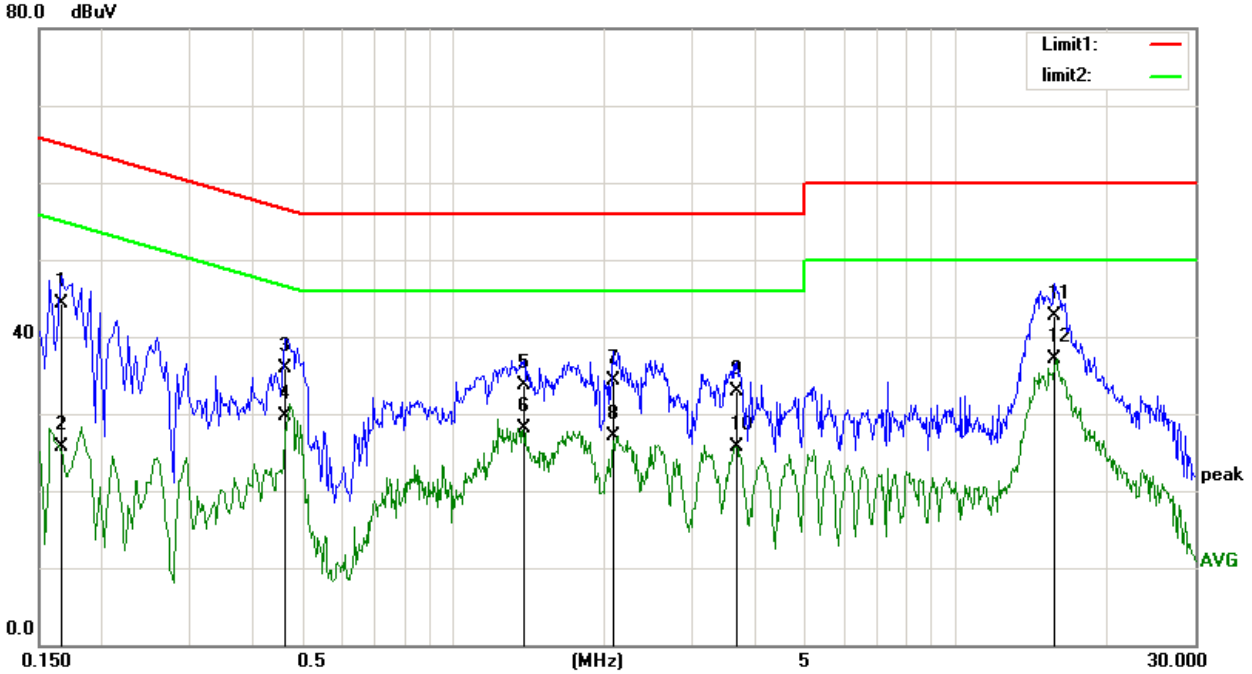

No.	Frequency (MHz)	Reading (dBuV)	Correct Factor(dB)	Result (dBuV)	Limit (dBuV)	Margin (dB)	Remark
1	0.1660	32.89	11.36	44.25	65.15	-20.90	QP
2	0.1660	14.29	11.36	25.65	55.15	-29.50	AVG
3	0.4660	25.74	10.22	35.96	56.58	-20.62	QP
4	0.4660	19.47	10.22	29.69	46.58	-16.89	AVG
5	1.3819	23.59	10.10	33.69	56.00	-22.31	QP
6	1.3819	17.99	10.10	28.09	46.00	-17.91	AVG
7	2.0819	24.14	10.11	34.25	56.00	-21.75	QP
8	2.0819	16.95	10.11	27.06	46.00	-18.94	AVG
9	3.6779	22.70	10.15	32.85	56.00	-23.15	QP
10	3.6779	15.63	10.15	25.78	46.00	-20.22	AVG
11	15.7460	32.53	10.16	42.69	60.00	-17.31	QP
12	15.7460	27.00	10.16	37.16	50.00	-12.84	AVG

Remarks:

- (1) Measurement Value = Reading Level + Correct Factor.
- (2) Margin Level = Measurement Value - Limit Value.

5. RADIATED EMISSION TEST

5.1 LIMIT

In case the emission fall within the restricted band specified on 15.205(a), then the 15.209(a) limit in the table below has to be followed.

LIMITS OF RADIATED EMISSION MEASUREMENT (9 kHz-1000MHz)

Frequency (MHz)	Field Strength (microvolts/meter)	Measurement Distance (meters)
0.009-0.490	2400/F(kHz)	300
0.490-1.705	24000/F(kHz)	30
1.705-30.0	30	30
30-88	100	3
88-216	150	3
216-960	200	3
Above 960	500	3

LIMITS OF RADIATED EMISSION MEASUREMENT (9 kHz-30 MHz)

Frequency (MHz)	Magnetic field strength (H-Field) (μA/m)	Measurement Distance (meters)
0.009-0.490	6.37/F(kHz)	300
0.490-1.705	6.37/F(kHz)	30
1.705-30.0	0.08	30

LIMITS OF RADIATED EMISSION MEASUREMENT (30 MHz-1000MHz)

Frequency (MHz)	Field Strength (μV/m at 3m)
30-88	100
88-216	150
216-960	200
Above 960	500

LIMITS OF RADIATED EMISSION MEASUREMENT (Above 1000MHz)

Frequency (MHz)	(dBuV/m at 3 m)	
	Peak	Average
Above 1000	74	54

Note:

- (1) The limit for radiated test was performed according to FCC PART 15C
- (2) The tighter limit applies at the band edges.
- (3) Emission level (dBuV/m)=20log Emission level (uV/m).

5.2 TEST PROCEDURE AND SETTING

- a. The measuring distance of 3 m shall be used for measurements. The EUT was placed on the top of a rotating table 0.8 meter above the ground at a 3 meter semi-anechoic chamber. The table was rotated 360 degrees to determine the position of the highest radiation.(below 1GHz)
- b. The measuring distance of 3 m shall be used for measurements. The EUT was placed on the top of a rotating table 1.5 meter above the ground at a 3 meter semi-anechoic chamber. The table was rotated 360 degrees to determine the position of the highest radiation.(above 1GHz)
- c. The height of the equipment or of the substitution antenna shall be 0.8m or 1.5m; the height of the test antenna shall vary between 1 m to 4 m. Both horizontal and vertical polarizations of the antenna are set to make the measurement.
- d. For each suspected emission, the EUT was arranged to its worst case and then the antenna was tuned to heights find the maximum reading (used Bore sight function).
- e. The receiver system was set to peak and average detect function and specified bandwidth with maximum hold mode when the test frequency is above 1GHz.
- f. The initial step in collecting radiated emission data is a receiver peak detector mode pre-scanning the measurement frequency range. Significant peaks are then marked and then Quasi Peak detector mode re-measured.
- g. All readings are Peak unless otherwise stated QP in column of Note. Peak denotes that the Peak reading compliance with the QP Limits and then QP Mode measurement didn't perform. (below 1GHz)
- h. All readings are Peak Mode value unless otherwise stated AVG in column of Note. If the Peak Mode Measured value compliance with the Peak Limits and lower than AVG Limits, the EUT shall be deemed to meet both Peak & AVG Limits and then only Peak Mode was measured, but AVG Mode didn't perform. (above 1GHz)
- i. Measurement Value = Reading Level + Correct Factor.
 Correct Factor = Antenna Factor + Cable Loss – Amplifier Gain + Attenuator
 Margin Level = Measurement Value - Limit Value.

Spectrum Parameter	Setting
Attenuation	Auto
Start Frequency	1000 MHz
Stop Frequency	10th carrier harmonic
RBW / VBW (Emission in restricted band)	RBW 1MHz VBW 3MHz peak detector for Pk value RMS detector for AV value

Receiver Parameter	Setting
Attenuation	Auto
Start ~ Stop Frequency	9 kHz~90 kHz for PK/AVG detector
Start ~ Stop Frequency	90 kHz~110 kHz for QP detector
Start ~ Stop Frequency	110 kHz~490 kHz for PK/AVG detector
Start ~ Stop Frequency	490 kHz~30 MHz for QP detector
Start ~ Stop Frequency	30MHz~1000MHz for QP detector

5.3 MEASUREMENT INSTRUMENTS LIST

Item	Kind of Equipment	Type No.	Manufacturer	Serial No.	Calibrated until
1	EMI Test Receiver	ESCI	R&S	101307	12/12/2020
2	Spectrum Analyzer	E4407B	Agilent	US40240708	11/17/2020
3	Loop antenna	FMZB1519	SCHWARZBECK K	1519-062	12/14/2020
4	Broadband antenna	VULB9168	SCHWARZBECK	VULB9168-192	03/22/2020
5	HORN ANTENNA	BBHA9120D	SCHWARZBECK	BBHA 9120D 1065	04/22/2020
6	Preamplifier Amplifier	8447F	HP	3113A05680	12/11/2020
7	PRE-AMPLIFIER	EMC011830	CY	980136	12/11/2020
8	RF Cable	Test Cable 4	R&S	4	12/11/2020
9	RF Cable	Test Cable 5	R&S	5	12/11/2020
10	RF Cable	Test Cable 9	R&S	9	04/22/2020
11	RF Cable	Test Cable 10	R&S	10	12/11/2020

5.4 TEST SETUP

9 kHz-30 MHz

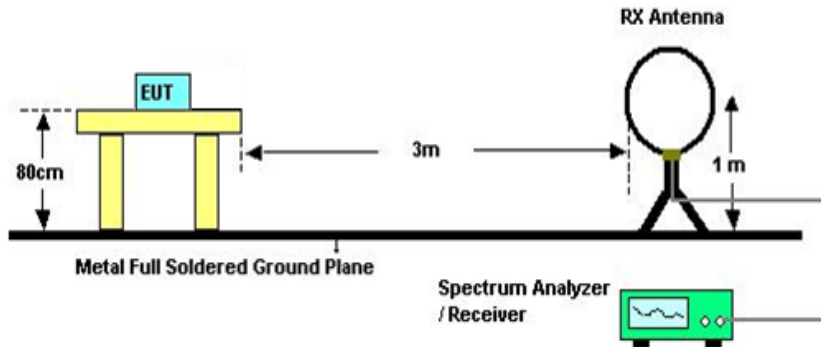

30 MHz to 1 GHz

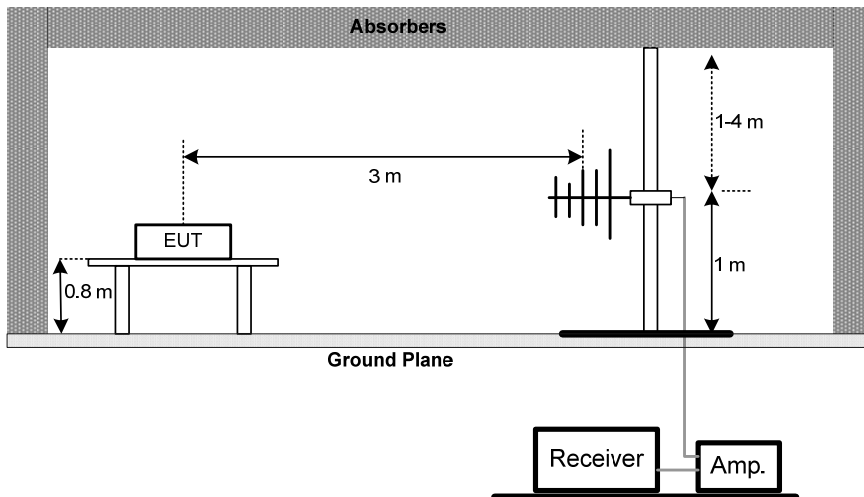

Above 1 GHz

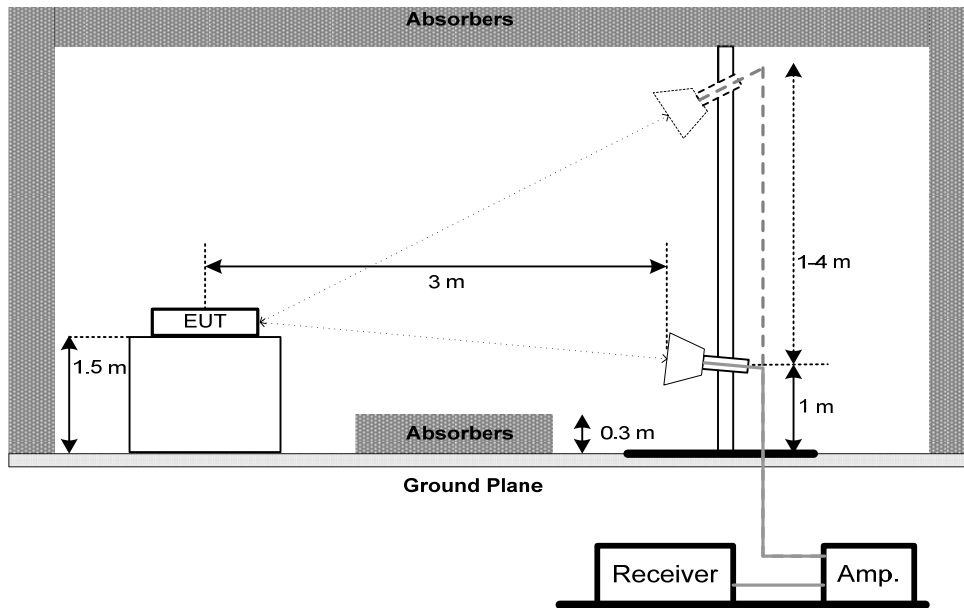

5.5 EUT OPERATING CONDITIONS

The EUT was programmed to be in continuously transmitting mode.

5.6 TEST RESULTS - 9 kHz TO 30MHz

EUT:	true wireless earphone	Model No.:	boombuds x
Temperature:	24°C	Relative Humidity:	55%
Distance:	3m	Test Power:	DC 5V
Polarization:	--	Test Result:	Pass
Test Mode:	TX Mode Channel 00_3Mbps	Test By:	Sky Peng

Freq.	Reading	Limit	Margin	State
(MHz)	(dBuV/m)	(dBuV/m)	(dB)	P/F
--	--	--	--	P
--	--	--	--	P

Note:

The amplitude of spurious emissions which are attenuated by more than 20dB below the permissible value has no need to be reported.

Distance extrapolation factor = $20 \log (\text{specific distance}/\text{test distance})$ (dB);

Limit line = specific limits(dBuv) + distance extrapolation factor

5.7 TEST RESULTS- 30 MHz TO 1000MHz

Test Mode: TX Mode Channel 00 _3Mbps

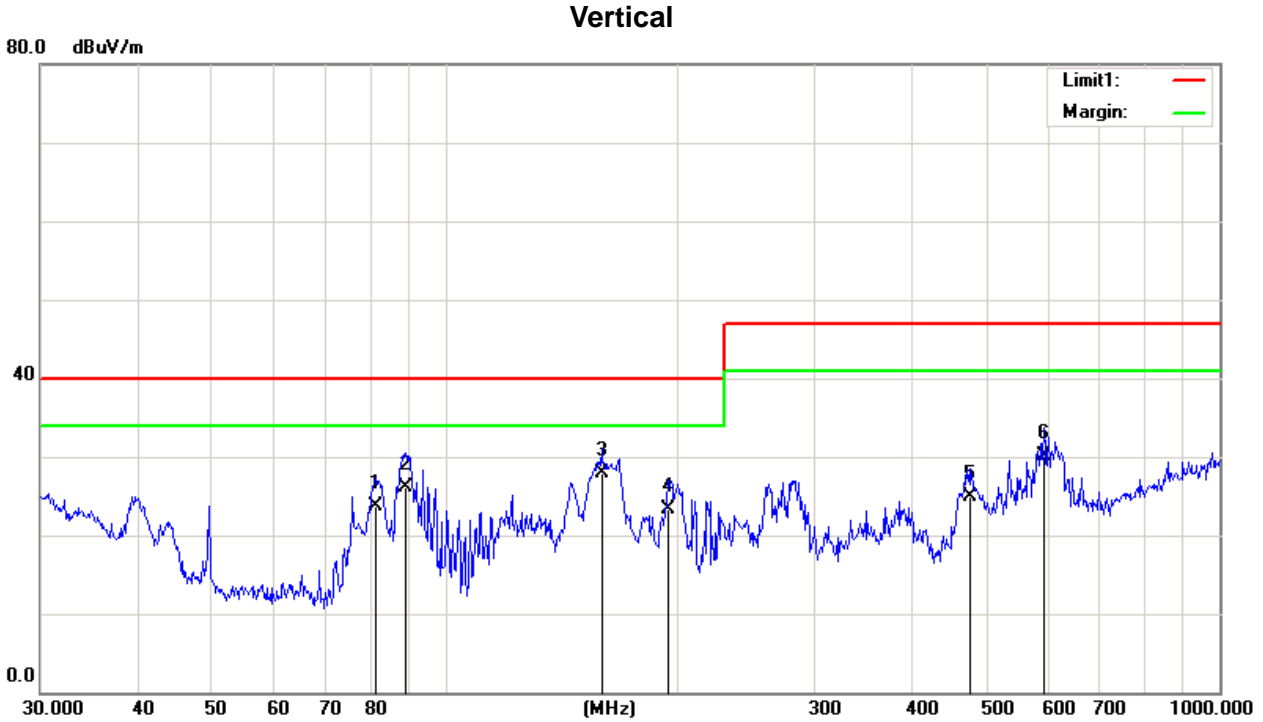

No.	Frequency (MHz)	Reading (dBuV/m)	Correct Factor(dB/m)	Result (dBuV/m)	Limit (dBuV/m)	Margin (dB)	Remark
1	81.4969	39.18	-15.49	23.69	40.00	-16.31	QP
2	88.9637	41.24	-15.19	26.05	40.00	-13.95	QP
3	159.2250	39.61	-11.76	27.85	40.00	-12.15	QP
4	193.7727	34.95	-11.62	23.33	40.00	-16.67	QP
5	477.1693	30.89	-6.00	24.89	47.00	-22.11	QP
6	593.0497	33.57	-3.55	30.02	47.00	-16.98	QP

Test Mode: TX Mode Channel 00 _3Mbps

Horizontal

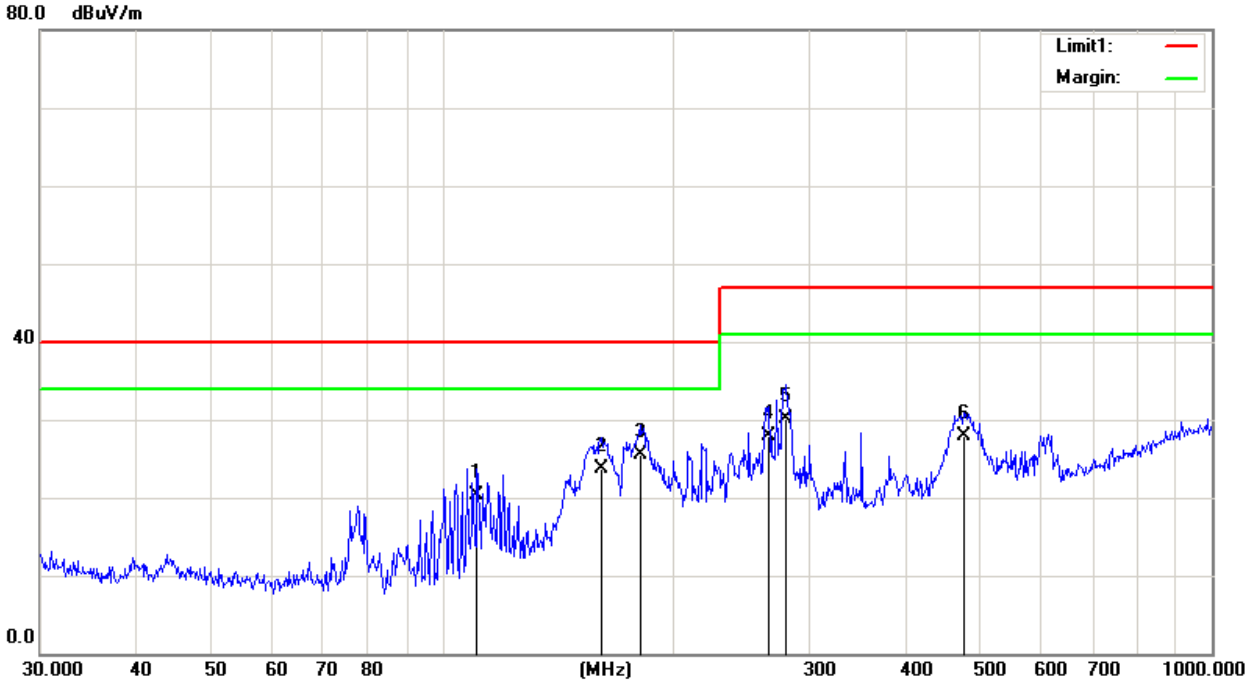

No.	Frequency (MHz)	Reading (dBuV/m)	Correct Factor (dB/m)	Result (dBuV/m)	Limit (dBuV/m)	Margin (dB)	Remark
1	110.9571	34.46	-14.23	20.23	40.00	-19.77	QP
2	160.9089	36.16	-12.47	23.69	40.00	-16.31	QP
3	180.6488	35.21	-9.76	25.45	40.00	-14.55	QP
4	265.6757	32.93	-4.95	27.98	47.00	-19.02	QP
5	280.0237	35.08	-5.06	30.02	47.00	-16.98	QP
6	475.4991	34.37	-6.38	27.99	47.00	-19.01	QP

5.8TEST RESULTS - ABOVE 1000MHz(BAND EDGE)

Test Mode: TX 2402 MHz_CH00_1Mbps

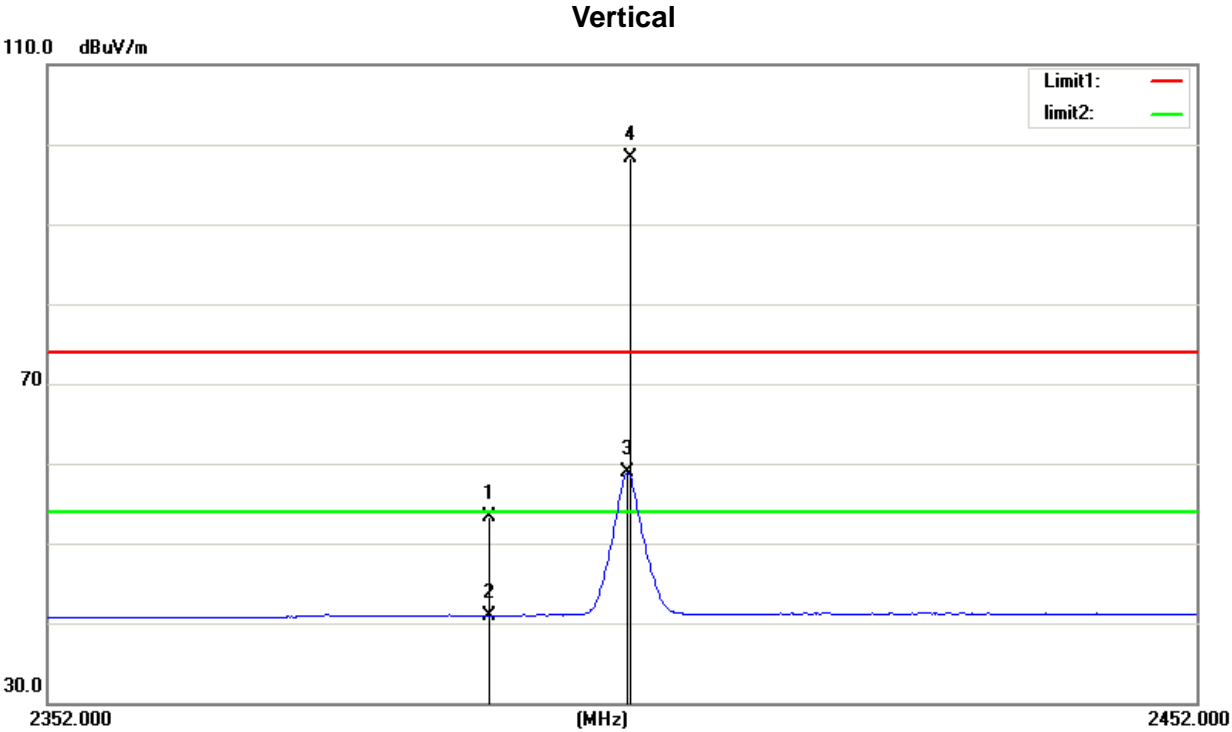

No.	Frequency (MHz)	Reading (dBuV/m)	Correct Factor(dB/m)	Result (dBuV/m)	Limit (dBuV/m)	Margin (dB)	Remark
1	2390.000	21.65	31.62	53.27	74.00	-20.73	peak
2	2390.000	9.31	31.62	40.93	54.00	-13.07	AVG
3	2402.000	27.21	31.64	58.85	/	/	AVG
4	2402.200	66.65	31.65	98.30	/	/	peak

Test Mode: TX 2402 MHz_CH00_1Mbps

Horizontal

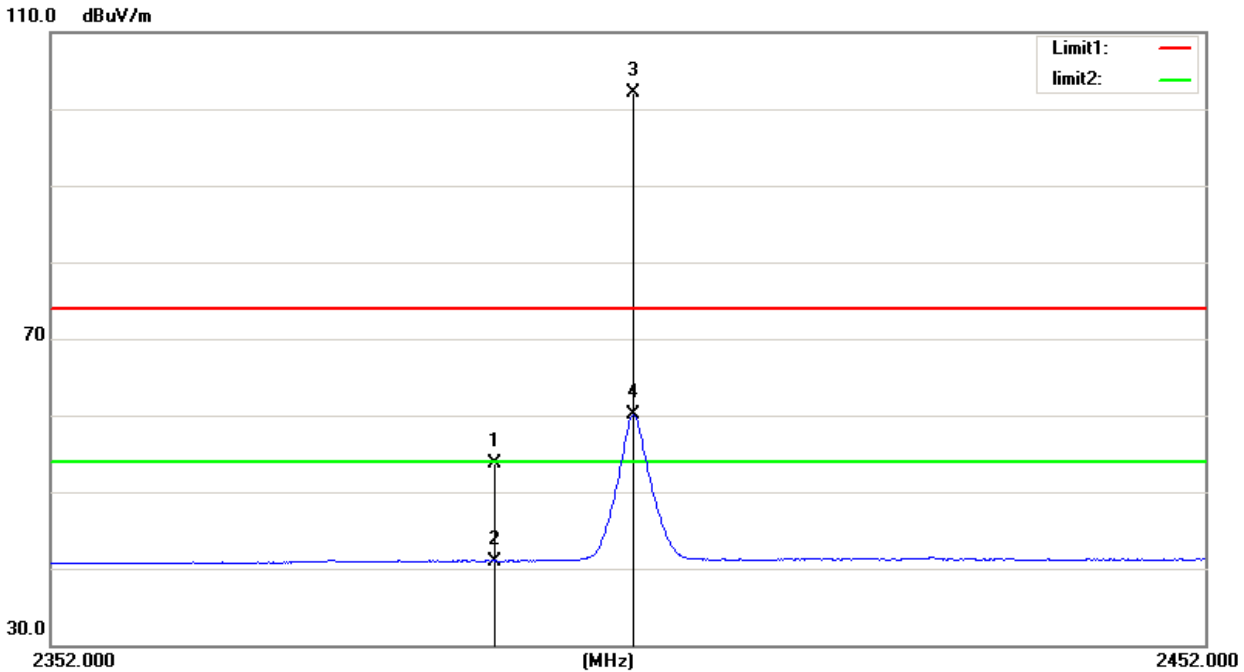

No.	Frequency (MHz)	Reading (dBuV/m)	Correct Factor(dB/m)	Result (dBuV/m)	Limit (dBuV/m)	Margin (dB)	Remark
1	2390.000	22.00	31.62	53.62	74.00	-20.38	peak
2	2390.000	9.37	31.62	40.99	54.00	-13.01	AVG
3	2401.900	70.43	31.64	102.07	/	/	peak
4	2402.000	28.47	31.64	60.11	/	/	AVG

Test Mode: TX 2480 MHz_CH78_1Mbps

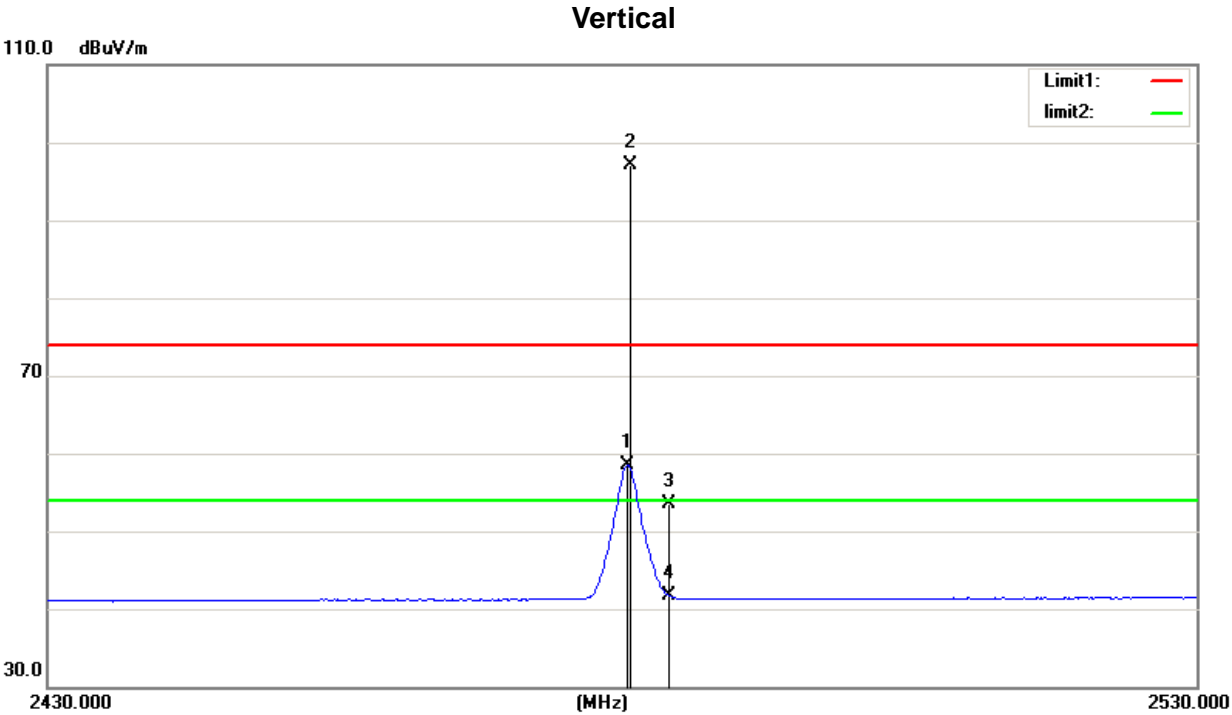

No.	Frequency (MHz)	Reading (dBuV/m)	Correct Factor(dB/m)	Result (dBuV/m)	Limit (dBuV/m)	Margin (dB)	Remark
1	2479.900	26.65	31.88	58.53	/	/	AVG
2	2480.200	65.14	31.88	97.02	/	/	peak
3	2483.500	21.70	31.89	53.59	74.00	-20.41	peak
4	2483.500	9.82	31.89	41.71	54.00	-12.29	AVG

Test Mode: TX 2480 MHz_CH78_1Mbps

Horizontal

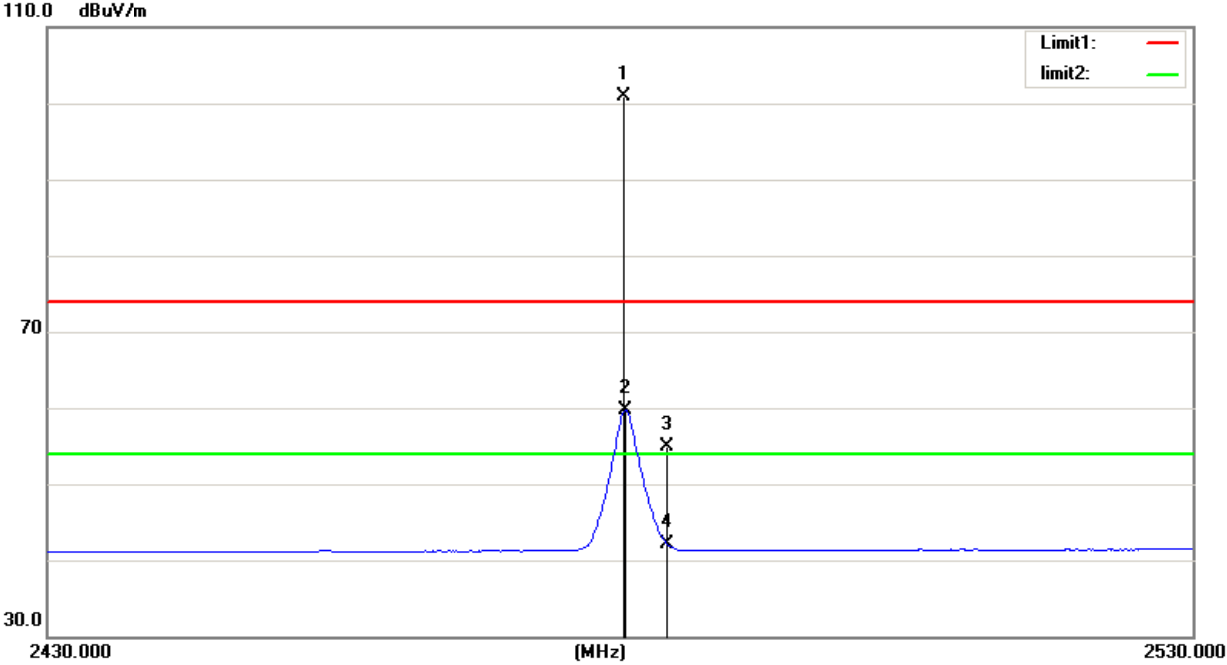

No.	Frequency (MHz)	Reading (dBuV/m)	Correct Factor(dB/m)	Result (dBuV/m)	Limit (dBuV/m)	Margin (dB)	Remark
1	2479.800	68.93	31.88	100.81	/	/	peak
2	2480.000	27.85	31.88	59.73	/	/	AVG
3	2483.500	22.97	31.89	54.86	74.00	-19.14	peak
4	2483.500	10.29	31.89	42.18	54.00	-11.82	AVG

Test Mode:	TX 2402 MHz_CH00_3Mbps
-------------------	------------------------

Vertical

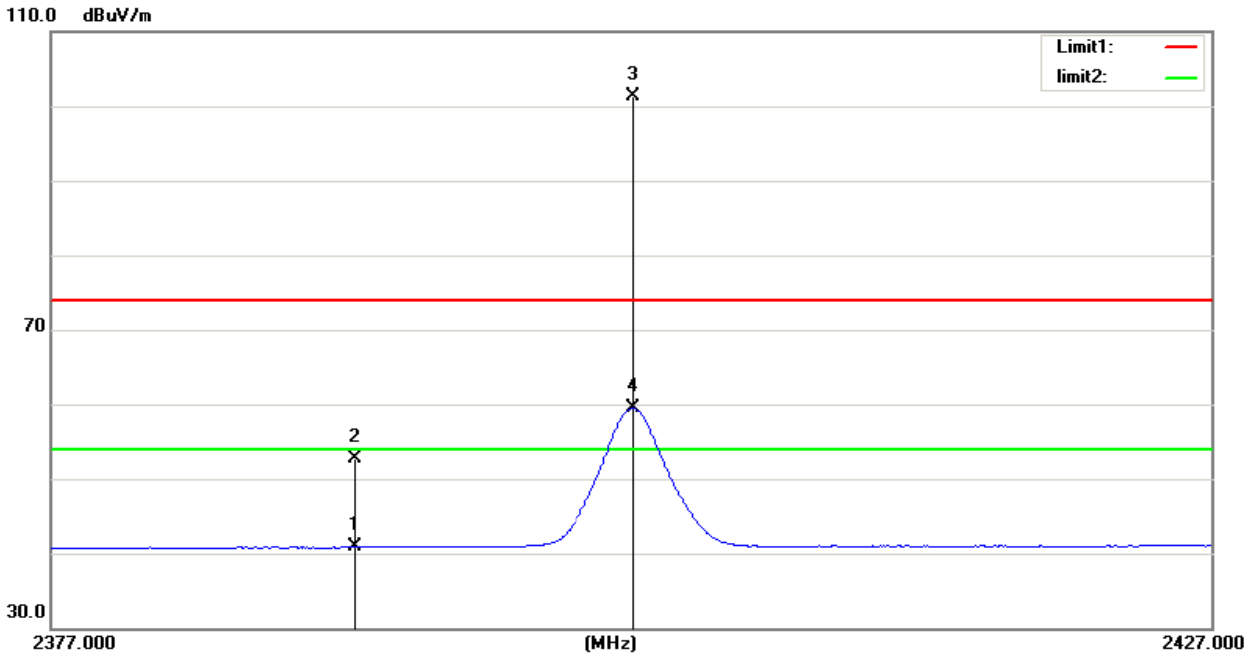

No.	Frequency (MHz)	Reading (dBuV/m)	Correct Factor(dB/m)	Result (dBuV/m)	Limit (dBuV/m)	Margin (dB)	Remark
1	2390.000	9.19	31.62	40.81	54.00	-13.19	AVG
2	2390.000	21.13	31.62	52.75	74.00	-21.25	peak
3	2401.950	69.76	31.64	101.40	/	/	peak
4	2402.000	27.83	31.64	59.47	/	/	AVG

Test Mode: TX 2402 MHz_CH00_3Mbps

Horizontal

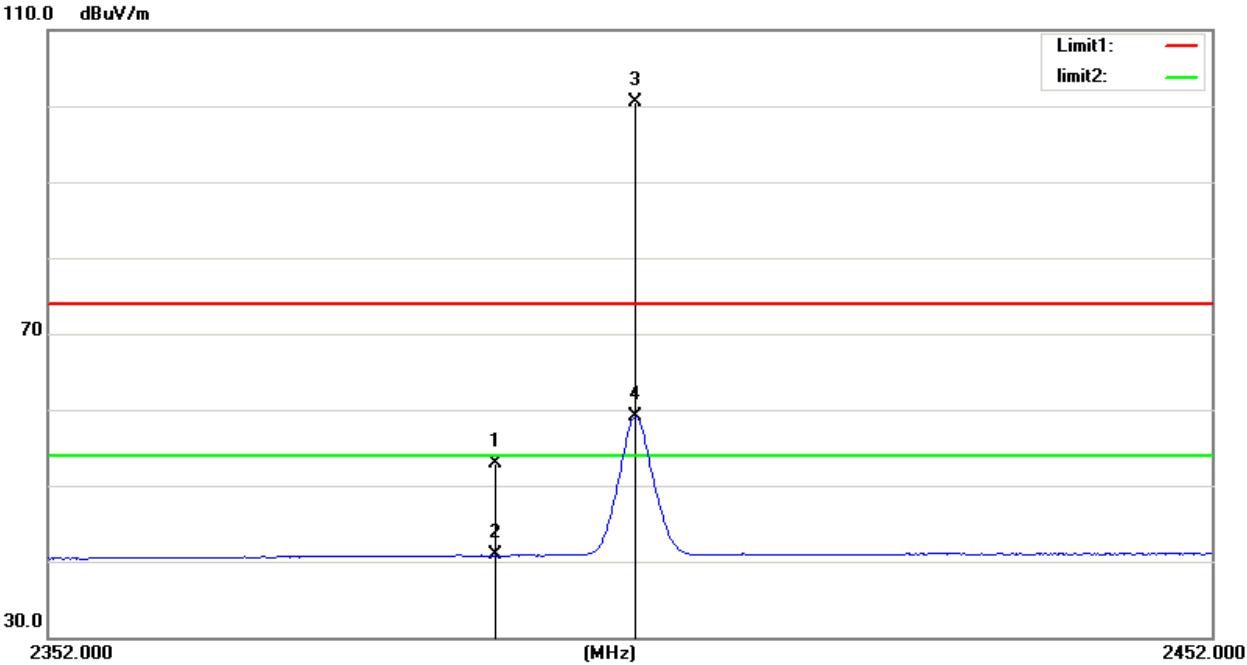

No.	Frequency (MHz)	Reading (dBuV/m)	Correct Factor(dB/m)	Result (dBuV/m)	Limit (dBuV/m)	Margin (dB)	Remark
1	2390.000	21.29	31.62	52.91	74.00	-21.09	peak
2	2390.000	9.19	31.62	40.81	54.00	-13.19	AVG
3	2401.900	68.94	31.64	100.58	/	/	peak
4	2402.000	27.51	31.64	59.15	/	/	AVG

Test Mode: TX 2480 MHz_CH78_3Mbps

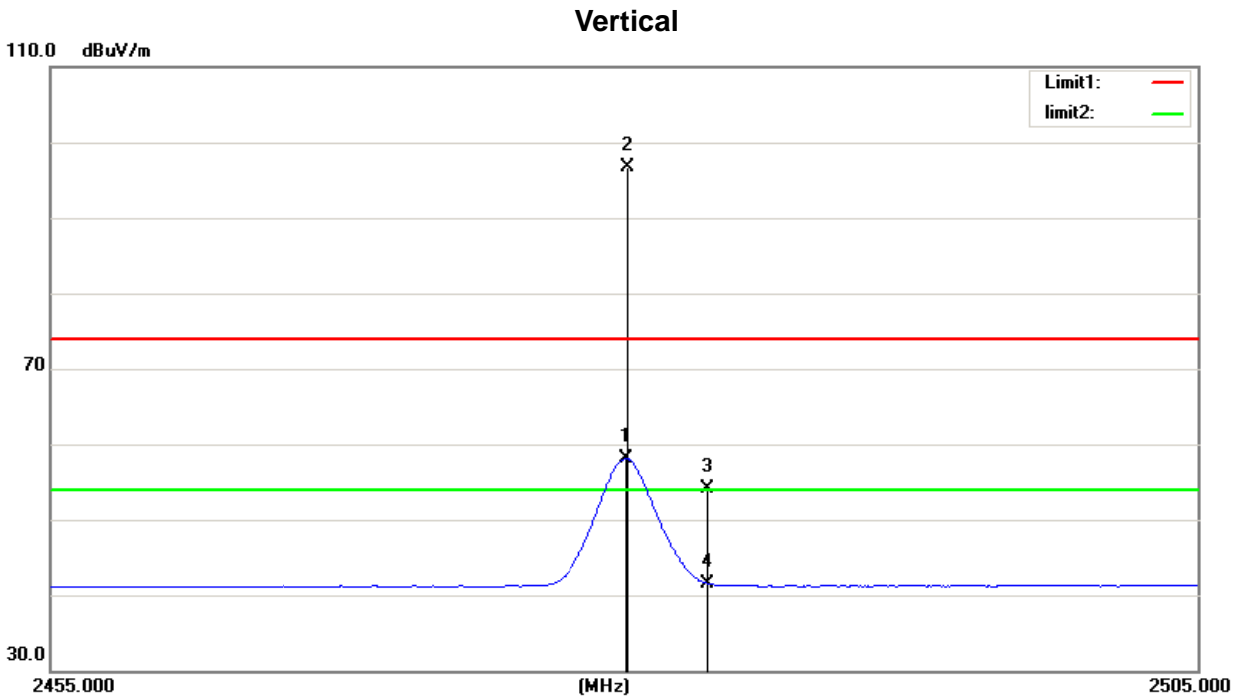

No.	Frequency (MHz)	Reading (dBuV/m)	Correct Factor(dB/m)	Result (dBuV/m)	Limit (dBuV/m)	Margin (dB)	Remark
1	2480.000	26.20	31.88	58.08	/	/	AVG
2	2480.050	64.84	31.88	96.72	/	/	peak
3	2483.500	22.30	31.89	54.19	74.00	-19.81	peak
4	2483.500	9.66	31.89	41.55	54.00	-12.45	AVG

Test Mode: TX 2480 MHz_CH78_3Mbps

Horizontal

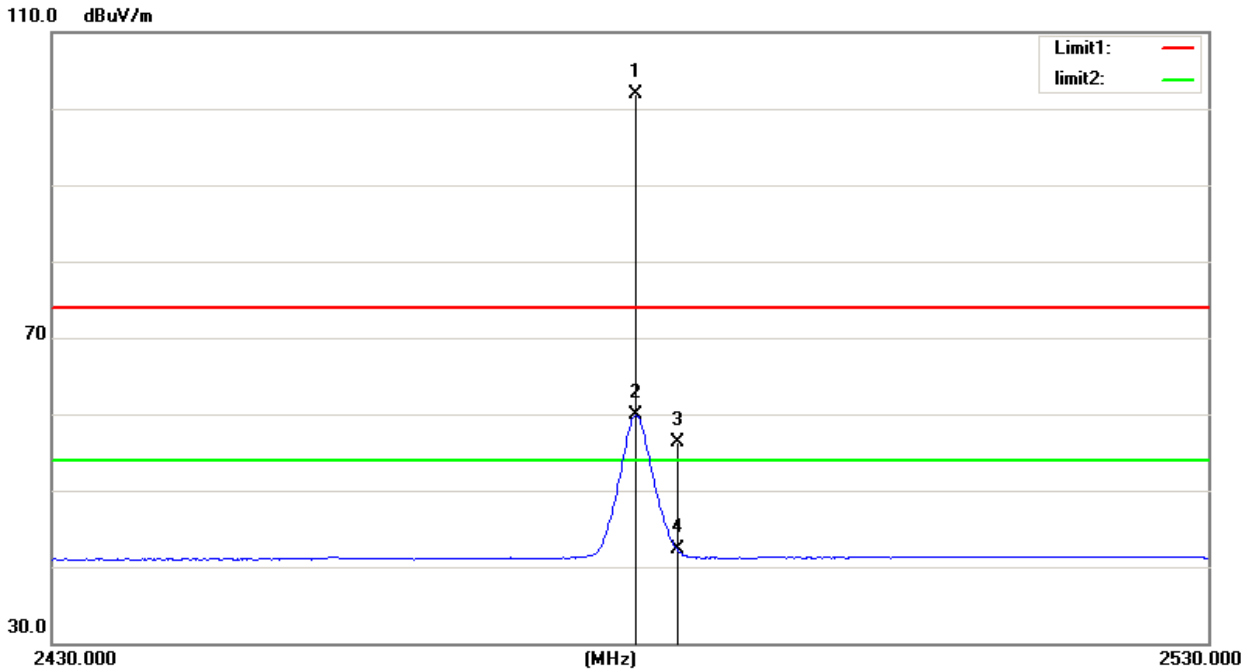

No.	Frequency (MHz)	Reading (dBuV/m)	Correct Factor(dB/m)	Result (dBuV/m)	Limit (dBuV/m)	Margin (dB)	Remark
1	2480.000	70.02	31.88	101.90	/	/	peak
2	2480.000	27.96	31.88	59.84	/	/	AVG
3	2483.500	24.37	31.89	56.26	74.00	-17.74	peak
4	2483.500	10.33	31.89	42.22	54.00	-11.78	AVG

5.9TEST RESULTS - ABOVE 1000MHz(HARMONIC)

Test Mode: TX 2402 MHz_CH00_1Mbps

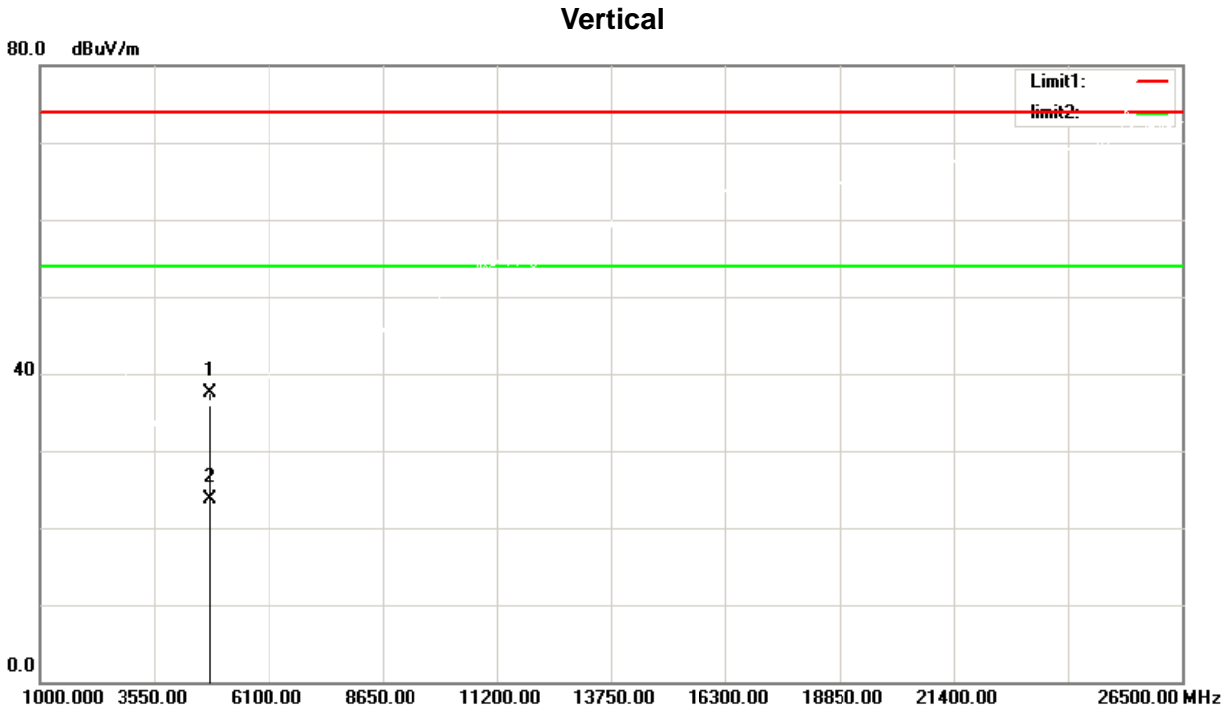

No.	Frequency (MHz)	Reading (dBuV/m)	Correct Factor(dB/m)	Result (dBuV/m)	Limit (dBuV/m)	Margin (dB)	Remark
1	4804.000	40.77	-3.33	37.44	74.00	-36.56	peak
2	4804.000	27.02	-3.33	23.69	54.00	-30.31	AVG

Test Mode: TX 2402 MHz_CH00_1Mbps

Horizontal

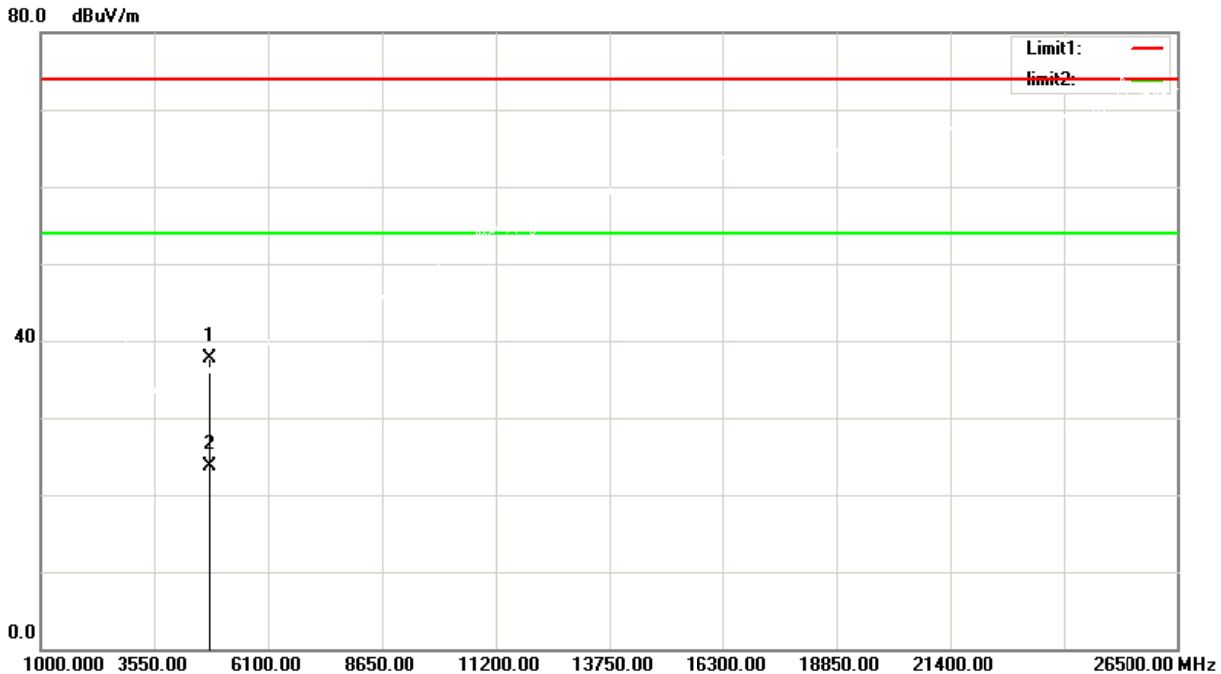

No.	Frequency (MHz)	Reading (dBuV/m)	Correct Factor(dB/m)	Result (dBuV/m)	Limit (dBuV/m)	Margin (dB)	Remark
1	4804.000	41.02	-3.33	37.69	74.00	-36.31	peak
2	4804.000	27.02	-3.33	23.69	54.00	-30.31	AVG

Test Mode: TX 2441 MHz_CH39_1Mbps

Vertical

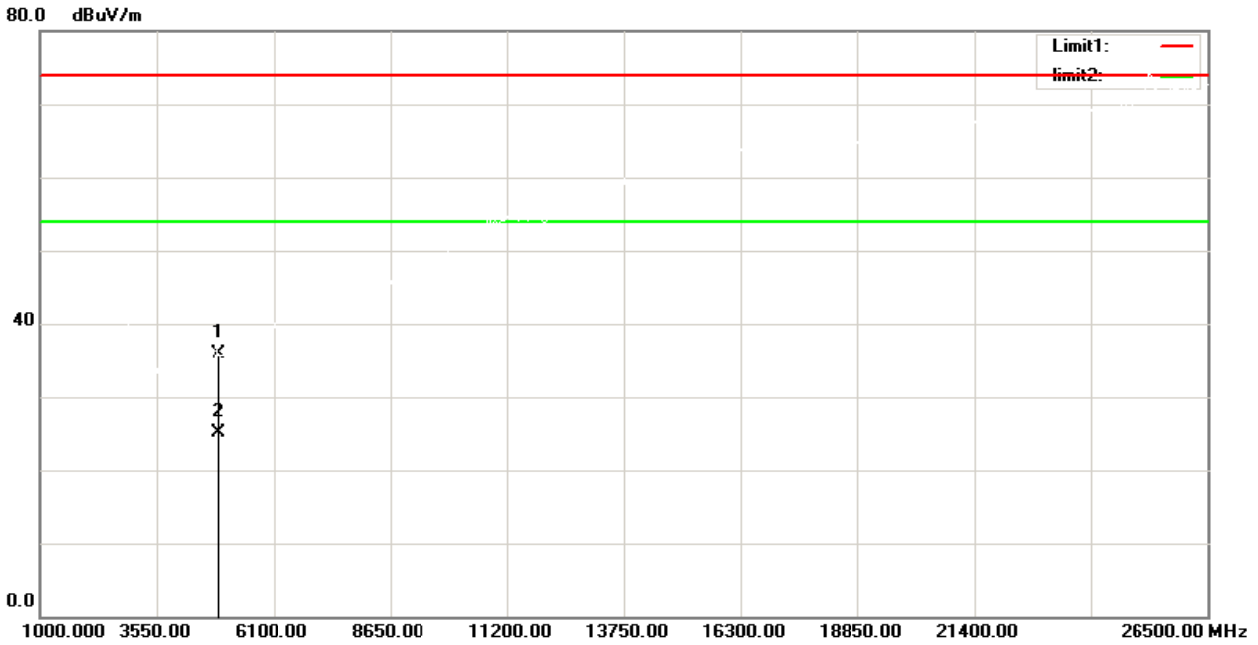

No.	Frequency (MHz)	Reading (dBuV/m)	Correct Factor(dB/m)	Result (dBuV/m)	Limit (dBuV/m)	Margin (dB)	Remark
1	4882.000	38.90	-3.03	35.87	74.00	-38.13	peak
2	4882.000	28.15	-3.03	25.12	54.00	-28.88	AVG

Test Mode: TX 2441 MHz_CH39_1Mbps

Horizontal

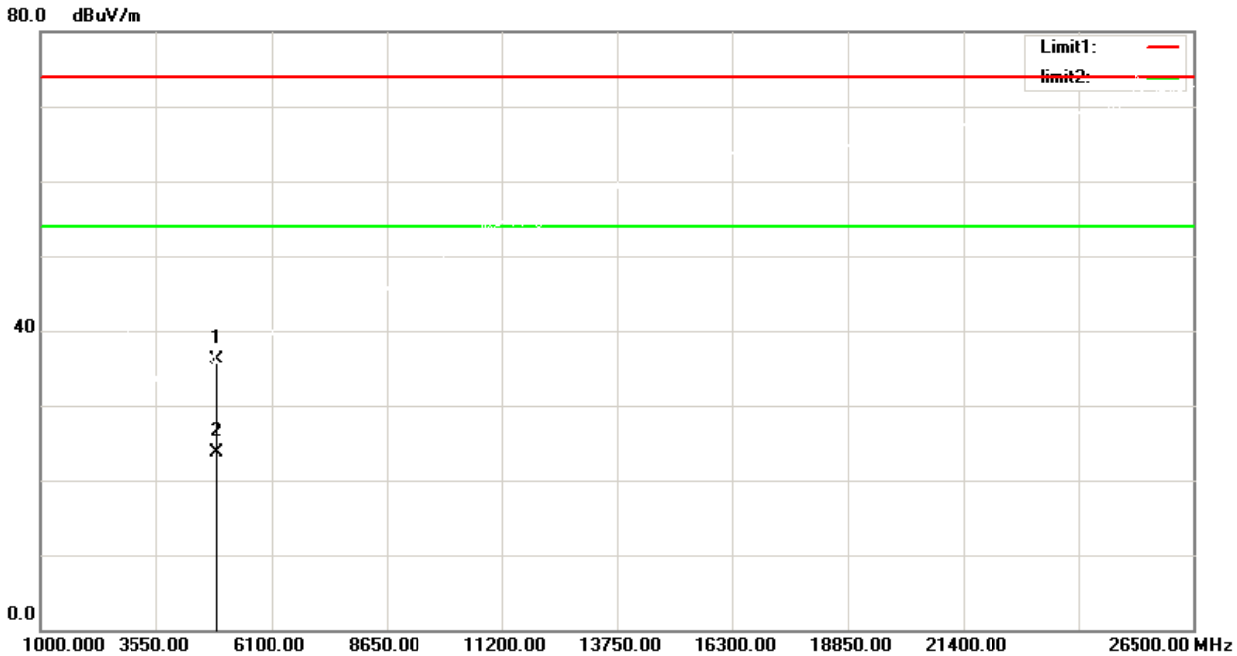

No.	Frequency (MHz)	Reading (dBuV/m)	Correct Factor(dB/m)	Result (dBuV/m)	Limit (dBuV/m)	Margin (dB)	Remark
1	4882.000	39.13	-3.03	36.10	74.00	-37.90	peak
2	4882.000	26.69	-3.03	23.66	54.00	-30.34	AVG

Test Mode: TX 2480 MHz_CH78_1Mbps

Vertical

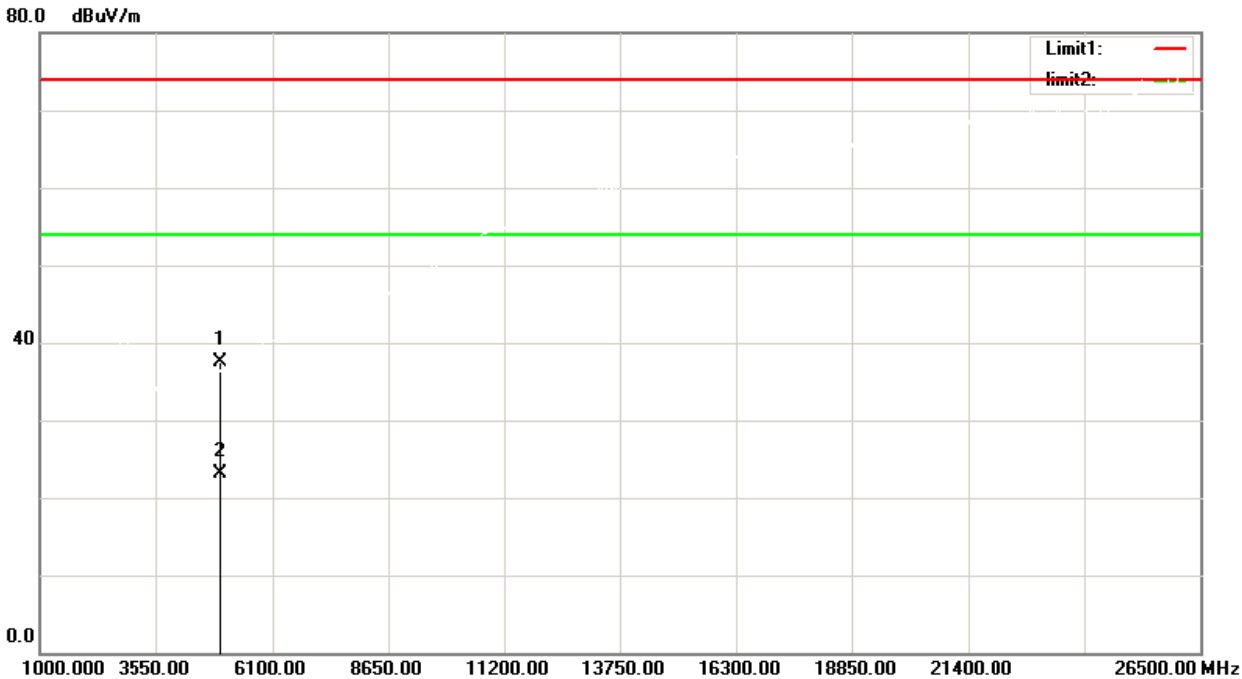

No.	Frequency (MHz)	Reading (dBuV/m)	Correct Factor(dB/m)	Result (dBuV/m)	Limit (dBuV/m)	Margin (dB)	Remark
1	4960.000	40.28	-2.74	37.54	74.00	-36.46	peak
2	4960.000	25.84	-2.74	23.10	54.00	-30.90	AVG

Test Mode: TX 2480 MHz_CH78_1Mbps

Horizontal

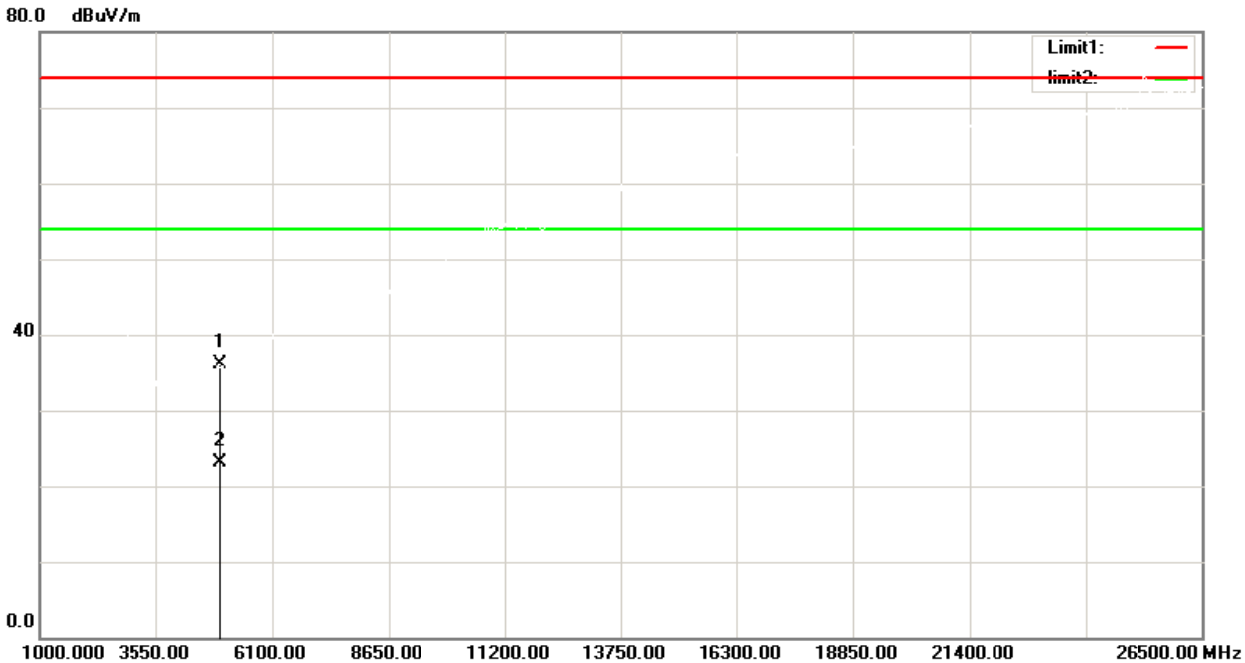

No.	Frequency (MHz)	Reading (dBuV/m)	Correct Factor(dB/m)	Result (dBuV/m)	Limit (dBuV/m)	Margin (dB)	Remark
1	4960.000	38.88	-2.74	36.14	74.00	-37.86	peak
2	4960.000	25.85	-2.74	23.11	54.00	-30.89	AVG

Test Mode: TX 2402 MHz_CH00_3Mbps

Vertical

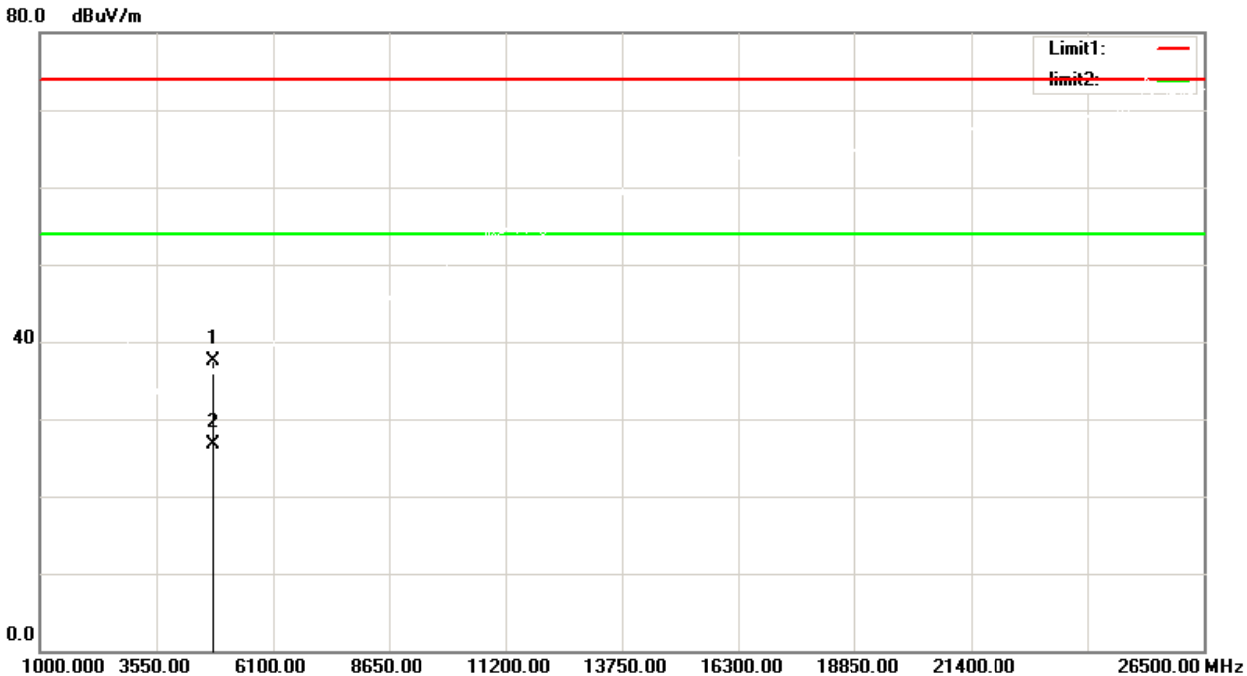

No.	Frequency (MHz)	Reading (dBuV/m)	Correct Factor(dB/m)	Result (dBuV/m)	Limit (dBuV/m)	Margin (dB)	Remark
1	4804.000	40.89	-3.33	37.56	74.00	-36.44	peak
2	4804.000	29.99	-3.33	26.66	54.00	-27.34	AVG

Test Mode: TX 2402 MHz_CH00_3Mbps

Horizontal

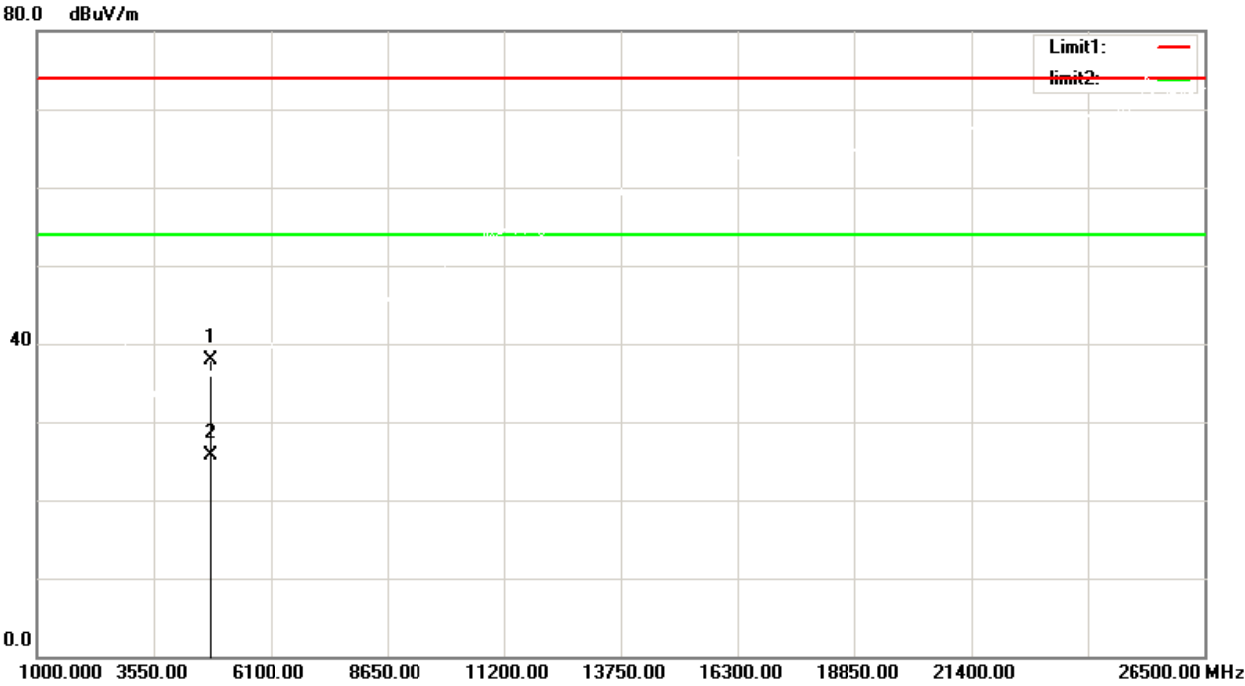

No.	Frequency (MHz)	Reading (dBuV/m)	Correct Factor(dB/m)	Result (dBuV/m)	Limit (dBuV/m)	Margin (dB)	Remark
1	4804.000	41.18	-3.33	37.85	74.00	-36.15	peak
2	4804.000	29.02	-3.33	25.69	54.00	-28.31	AVG

Test Mode: TX 2441 MHz_CH39_3Mbps

Vertical

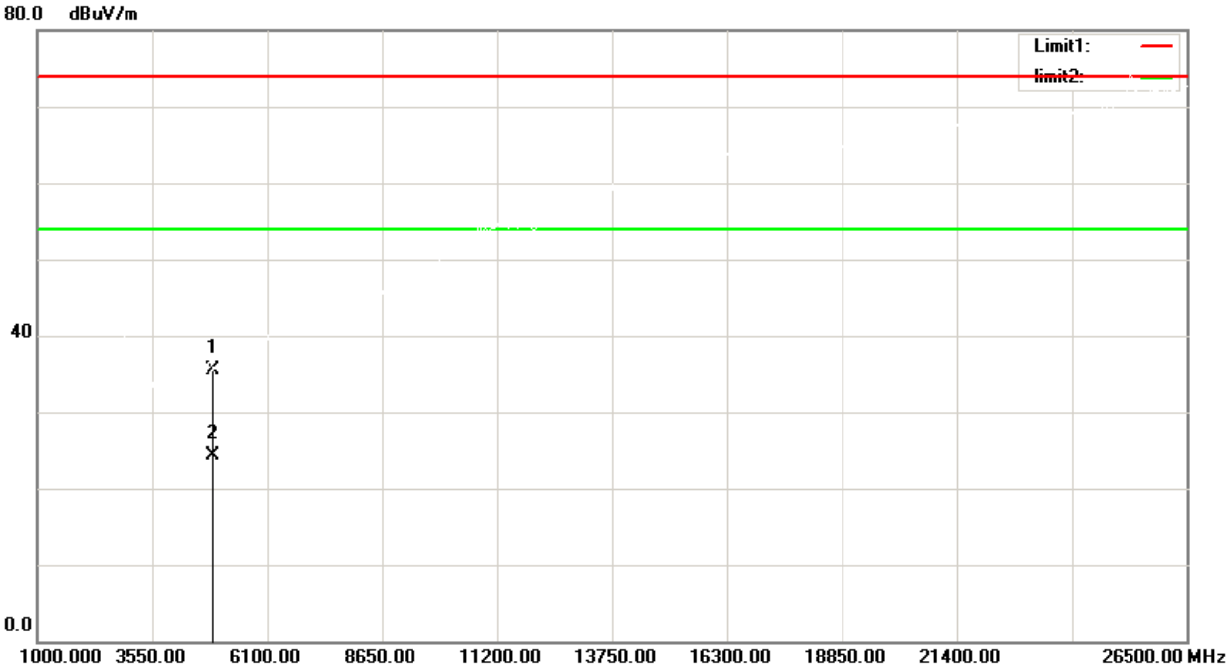

No.	Frequency (MHz)	Reading (dBuV/m)	Correct Factor(dB/m)	Result (dBuV/m)	Limit (dBuV/m)	Margin (dB)	Remark
1	4882.000	38.48	-3.03	35.45	74.00	-38.55	peak
2	4882.000	27.29	-3.03	24.26	54.00	-29.74	AVG

Test Mode: TX 2441 MHz_CH39_3Mbps

Horizontal

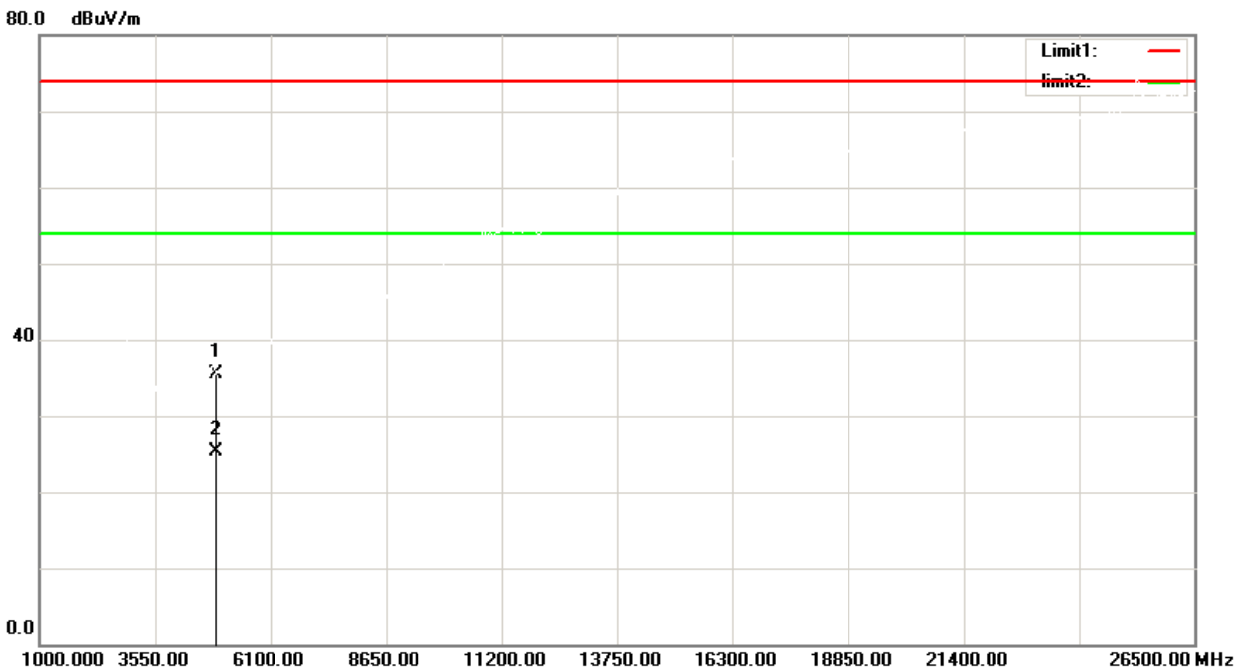

No.	Frequency (MHz)	Reading (dBuV/m)	Correct Factor(dB/m)	Result (dBuV/m)	Limit (dBuV/m)	Margin (dB)	Remark
1	4882.000	38.50	-3.03	35.47	74.00	-38.53	peak
2	4882.000	28.39	-3.03	25.36	54.00	-28.64	AVG

Test Mode: TX 2480 MHz_CH78_3Mbps

Vertical

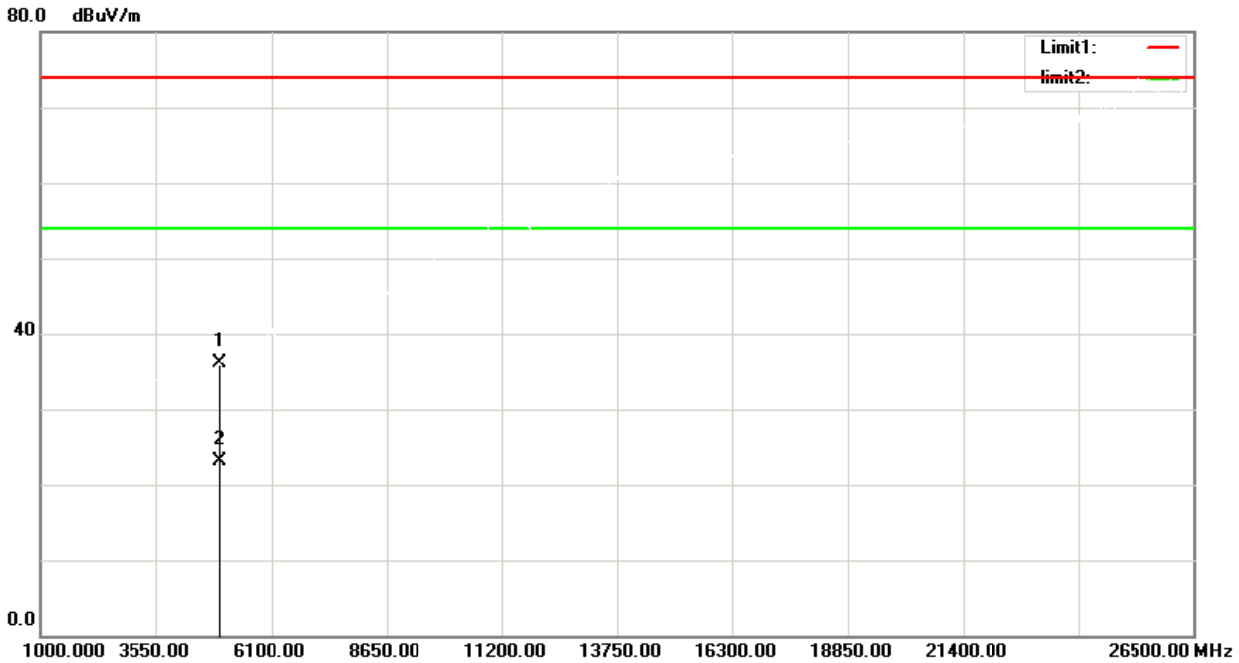

No.	Frequency (MHz)	Reading (dBuV/m)	Correct Factor(dB/m)	Result (dBuV/m)	Limit (dBuV/m)	Margin (dB)	Remark
1	4960.000	38.85	-2.74	36.11	74.00	-37.89	peak
2	4960.000	25.84	-2.74	23.10	54.00	-30.90	AVG

Test Mode: TX 2480 MHz_CH78_3Mbps

Horizontal

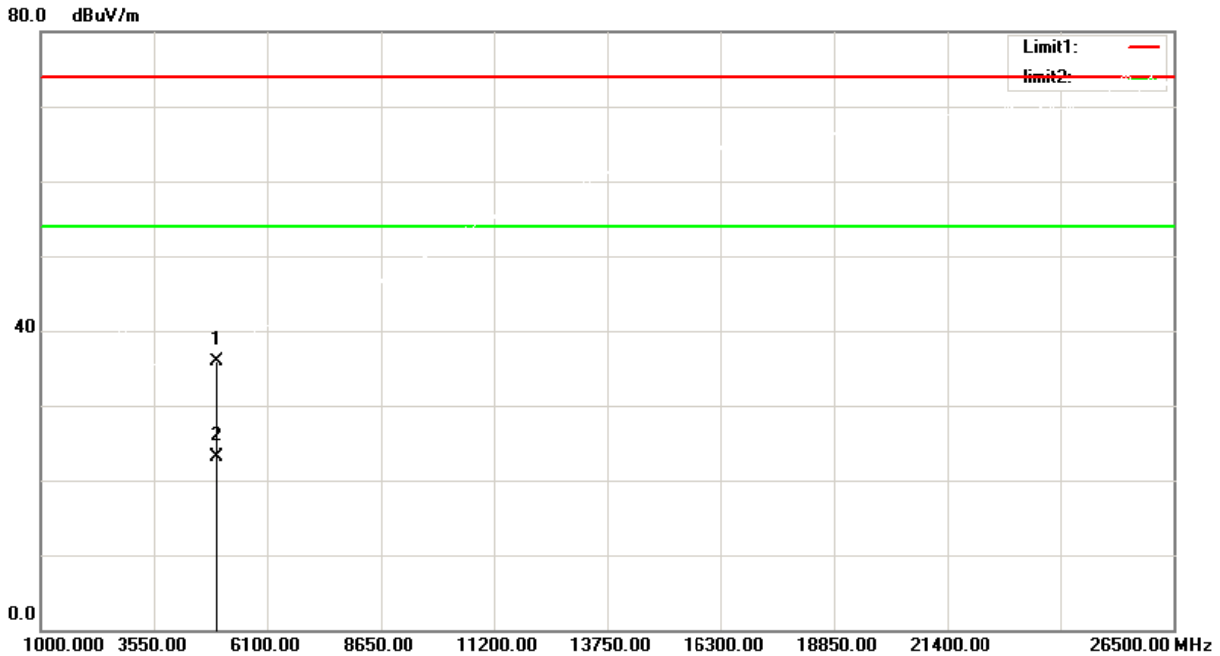

No.	Frequency (MHz)	Reading (dBuV/m)	Correct Factor(dB/m)	Result (dBuV/m)	Limit (dBuV/m)	Margin (dB)	Remark
1	4960.000	38.57	-2.74	35.83	74.00	-38.17	peak
2	4960.000	25.87	-2.74	23.13	54.00	-30.87	AVG

6.NUMBER OF HOPPING FREQUENCY

6.1LIMIT

FCC Part15, Subpart C (15.247)	
Section	Test Item
15.247(a)(1)(iii)	Number of Hopping Frequency

6.2TEST PROCEDURE AND SETTING

- a. The EUT was directly connected to the spectrum analyzer and antenna output port as show in the block diagram below.
- b. Spectrum Setting: RBW=100 kHz, VBW=100 kHz, Sweep time = Auto.

Spectrum Parameters	Setting
Attenuation	Auto
Span Frequency	> Operating Frequency Range
RBW	100kHz
VBW	300kHz
Detector	Peak
Trace	Max Hold
Sweep Time	Auto

6.3MEASUREMENT INSTRUMENTS LIST

Item	Kind of Equipment	Manufacturer	Type No.	Serial No.	Calibrated until
1	Spectrum analyzer	KEYSIGHT	N9010A	MY55150427	2020/05/27
2	Attenuator	Mini-Circuits	BW-S10W2	101109	2020/12/12
3	RF Cable	Mi-cable	C10-01-01-1	100309	2020/12/12

6.4TEST SETUP

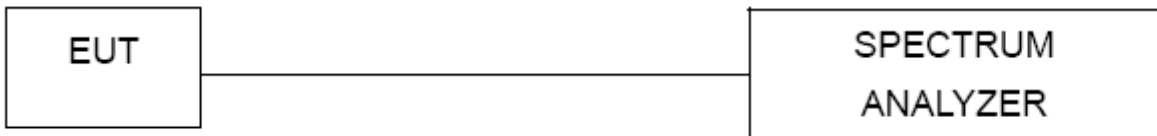

6.5EUT OPERATION CONDITIONS

The EUT tested system was configured as the statements of 4.5 unless otherwise a special operating condition is specified in the follows during the testing.

6.6 TEST RESULTS

Hopping Mode_1Mbps		
Number of Hopping Frequency	Measurement result(CH)	Limit(CH)
		79

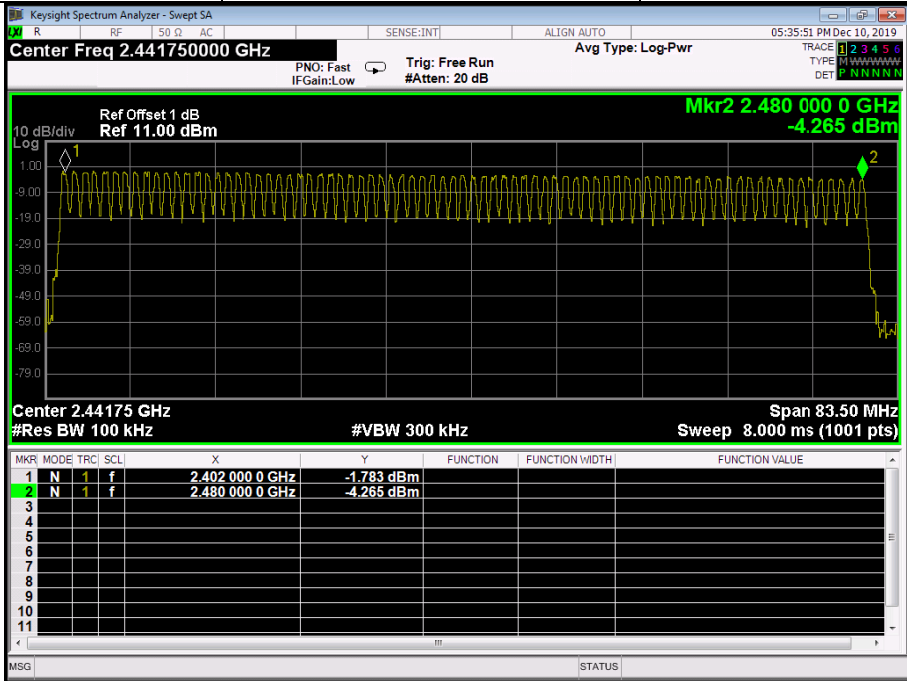

Hopping Mode_3Mbps		
Number of Hopping Frequency	Measurement result(CH)	Limit(CH)
		79

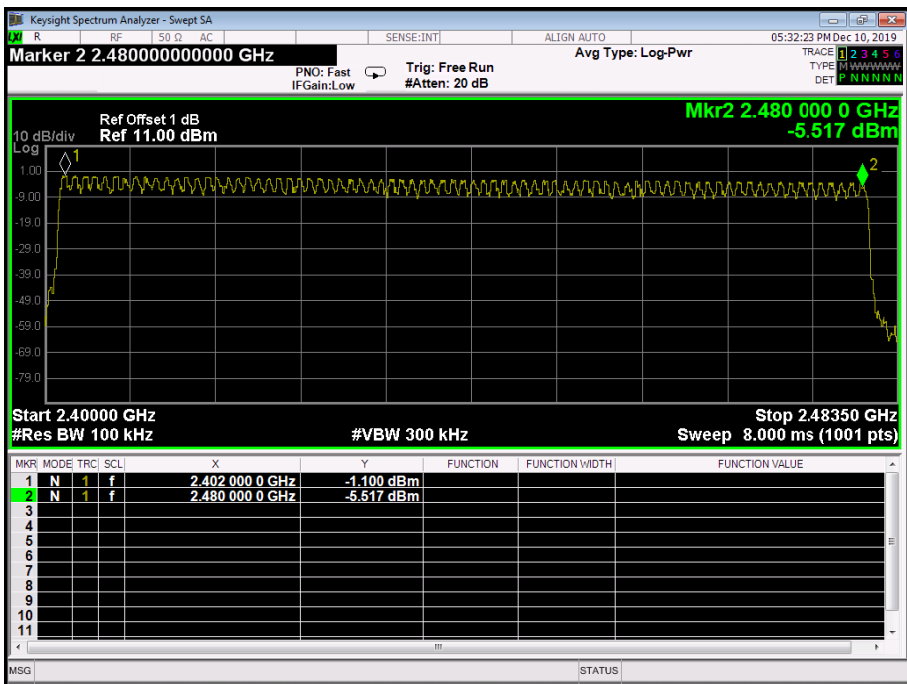

7.AVERAGE TIME OF OCCUPANCY

7.1LIMIT

FCC Part15, Subpart C (15.247)		
Section	Test Item	Limit
15.247(a)(1)(iii)	Average Time of Occupancy	0.4sec

7.2TEST PROCEDURE AND SETTING

- a. The transmitter output (antenna port) was connected to the spectrum analyzer
- b. Set RBW of spectrum analyzer to 1MHz and VBW to 1MHz
- c. Use a video trigger with the trigger level set to enable triggering only on full pulses
- d. Sweep Time is more than once pulse time
- e. Set the center frequency on any frequency would be measure and set the frequency span to zero span
- f. Measure the maximum time duration of one single pulse
- g. Set the EUT for DH1, DH3 and DH5 packet transmitting
- h. Measure the maximum time duration of one single pulse
- i. DH1 Packet permit maximum $1600 / 79 / 2 = 10.12$ hops per second in each channel (1 time slot TX, 1 time slot RX). So, the dwell time is the time duration of the pulse times $10.12 \times 31.6 = 320$ within 31.6 seconds
- j. DH3 Packet permit maximum $1600 / 79 / 4 = 5.06$ hops per second in each channel (3 time slots TX, 1 time slot RX). So, the dwell time is the time duration of the pulse times $5.06 \times 31.6 = 160$ within 31.6 seconds
- k. DH5 Packet permit maximum $1600 / 79 / 6 = 3.37$ hops per second in each channel (5 time slots TX, 1 time slot RX). So, the dwell time is the time duration of the pulse times $3.37 \times 31.6 = 106.6$ within 31.6 seconds

7.3MEASUREMENT INSTRUMENTS LIST

Item	Kind of Equipment	Manufacturer	Type No.	Serial No.	Calibrated until
1	Spectrum analyzer	KEYSIGHT	N9010A	MY55150427	2020/05/27
2	Attenuator	Mini-Circuits	BW-S10W2	101109	2020/12/12
3	RF Cable	Mi-cable	C10-01-01-1	100309	2020/12/12

7.4TEST SETUP



7.5EUT OPERATION CONDITIONS

The EUT tested system was configured as the statements of 4.5 unless otherwise a special operating condition is specified in the follows during the testing.

7.6 TEST RESULTS

TX Mode_1Mbps				
Mode	Channel Frequency (MHz)	Pulse Time (ms)	Dwell Time (ms)	Limit (ms)
DH1	2441	0.420	134.4	400
DH3	2441	1.740	278.4	400
DH5	2441	3.040	324.3	400

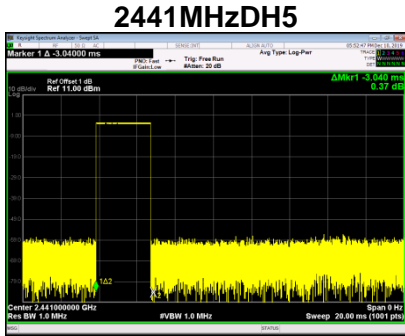
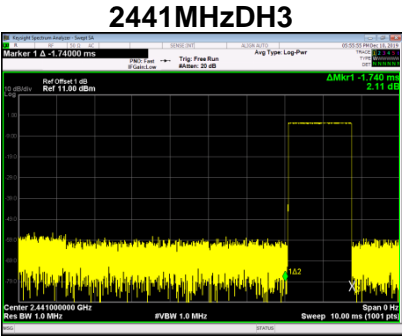
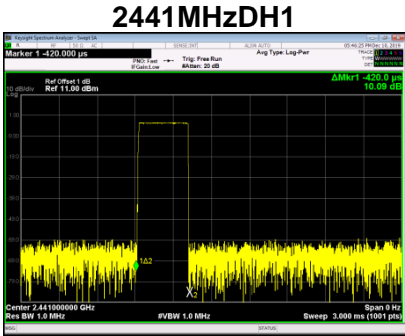

TX Mode_3Mbps				
Mode	Channel Frequency (MHz)	Pulse Time (ms)	Dwell Time (ms)	Limit (ms)
DH1	2441	0.42	134.4	400
DH3	2441	1.72	375.2	400
DH5	2441	3.12	332.8	400

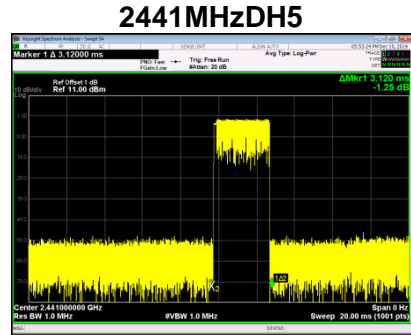
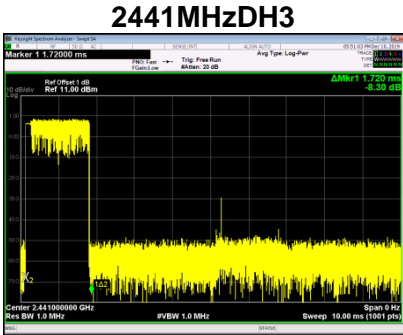
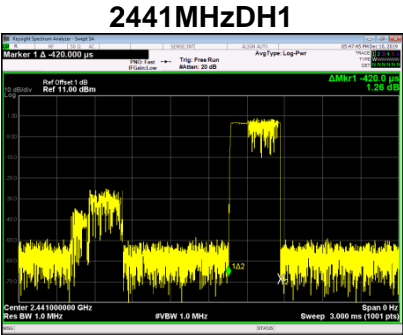

8.HOPPING CHANNEL SEPARATION MEASUREMENT

8.1LIMIT

Frequency hopping systems operating in the 2400-2483.5 MHz band may have hopping channel carrier frequencies that are separated by 25 kHz or two-thirds of the 20 dB bandwidth of the hopping channel, whichever is greater, provided the systems operate with an output power no greater than 125 mW.

8.2TEST PROCEDURE AND SETTING

- a. The EUT was directly connected to the spectrum analyzer and antenna output port as show in the block diagram below.
- b. Span = wide enough to capture the peaks of two adjacent channels
 Resolution (or IF) Bandwidth (RBW) \geq 1% of the span
 Video (or Average) Bandwidth (VBW) \geq RBW
 Sweep = Auto
 Detector function = Peak
 Trace = Max Hold

Spectrum Parameter	Setting
Attenuation	Auto
Span Frequency	> Measurement Bandwidth or Channel Separation
RBW	30 kHz
VBW	100 kHz
Detector	Peak
Trace	Max Hold
Sweep Time	Auto

8.3MEASUREMENT INSTRUMENTS LIST

Item	Kind of Equipment	Manufacturer	Type No.	Serial No.	Calibrated until
1	Spectrum analyzer	KEYSIGHT	N9010A	MY55150427	2020/05/27
2	Attenuator	Mini-Circuits	BW-S10W2	101109	2020/12/12
3	RF Cable	Mi-cable	C10-01-01-1	100309	2020/12/12

8.4TEST SETUP

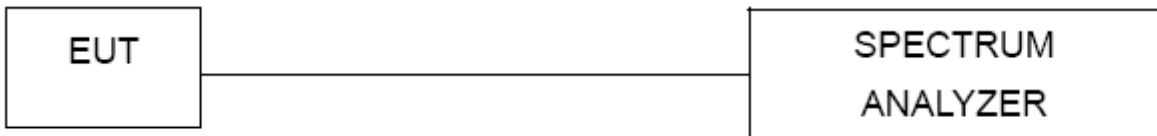

8.5EUT OPERATION CONDITIONS

The EUT tested system was configured as the statements of 4.5 unless otherwise a special operating condition is specified in the follows during the testing.

8.6 TEST RESULTS

TX Mode_1Mbps				
Channel	Frequency (MHz)	Channel Separation(MHz)	Limit (MHz)	Result
CH00	2402	0.996	>(25KHz or 2/3*20dB Bandwidth)	PASS
CH39	2441	0.996	>(25KHz or 2/3*20dB Bandwidth)	PASS
CH78	2480	1.002	>(25KHz or 2/3*20dB Bandwidth)	PASS

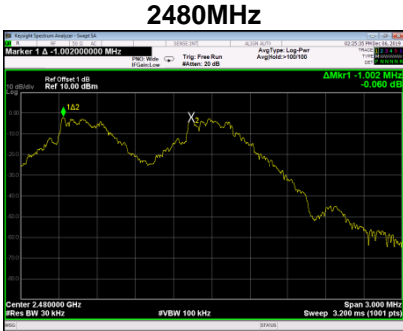
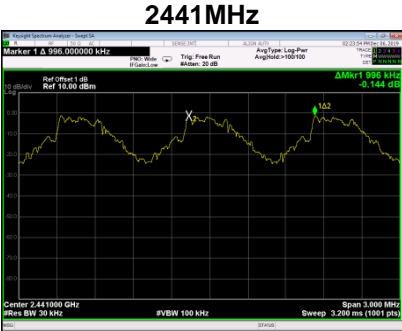
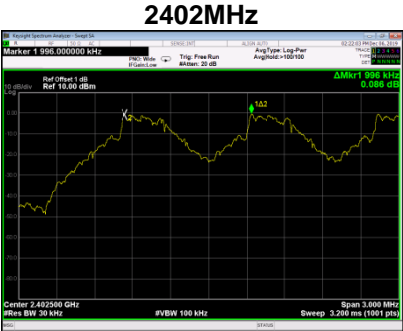

TX Mode_3Mbps				
Channel	Frequency (MHz)	Channel Separation(MHz)	Limit (MHz)	Result
CH00	2402	0.999	>(25KHz or 2/3*20dB Bandwidth)	PASS
CH39	2441	0.999	>(25KHz or 2/3*20dB Bandwidth)	PASS
CH78	2480	0.843	>(25KHz or 2/3*20dB Bandwidth)	PASS

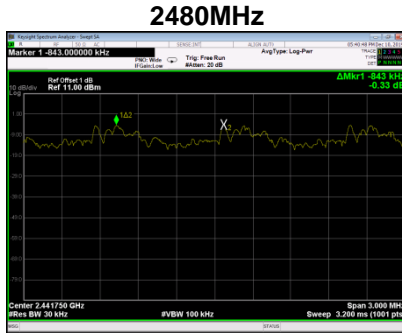
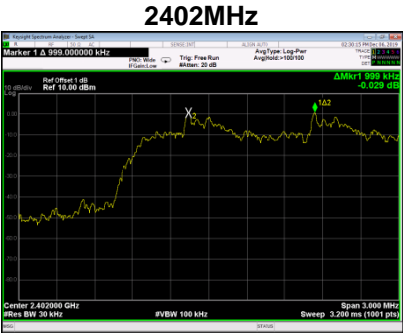

9.BANDWIDTH TEST

9.1LIMIT

FCC Part15, Subpart C (15.247)	
Section	Test Item
15.247(a)(1)	Bandwidth

9.2TEST PROCEDURE AND SETTING

- a. The EUT was directly connected to the spectrum analyzer and antenna output port as show in the block diagram below.
- b. Spectrum Setting: RBW= 30 kHz, VBW=100 kHz, Sweep Time = Auto.

Spectrum Parameter	Setting
Attenuation	Auto
Span Frequency	> Measurement Bandwidth
RBW	30kHz
VBW	100kHz
Detector	Peak
Trace	Max Hold
Sweep Time	Auto

9.3MEASUREMENT INSTRUMENTS LIST

Item	Kind of Equipment	Manufacturer	Type No.	Serial No.	Calibrated until
1	Spectrum analyzer	KEYSIGHT	N9010A	MY55150427	2020/05/27
2	Attenuator	Mini-Circuits	BW-S10W2	101109	2020/12/12
3	RF Cable	Mi-cable	C10-01-01-1	100309	2020/12/12

9.4TEST SETUP



9.5EUT OPERATION CONDITIONS

The EUT tested system was configured as the statements of 4.5 unless otherwise a special operating condition is specified in the follows during the testing.

9.6 TEST RESULTS

TX Mode_1Mbps				
Channel	Frequency (MHz)	20dB Bandwidth (MHz)	99 % Emission Bandwidth (MHz)	Result
CH00	2402	0.8772	0.8132	PASS
CH39	2441	0.8768	0.8122	PASS
CH78	2480	0.8825	0.8174	PASS

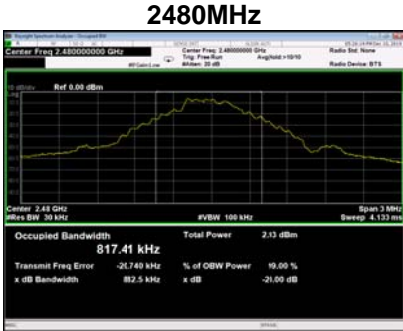
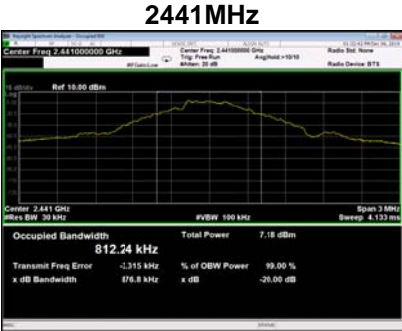
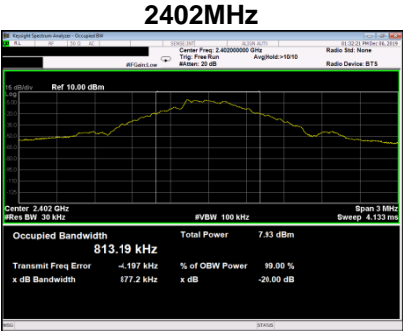

TX Mode_3Mbps				
Channel	Frequency (MHz)	20dB Bandwidth (MHz)	99 % Emission Bandwidth (MHz)	Result
CH00	2402	1.206	1.1386	PASS
CH39	2441	1.249	1.1448	PASS
CH78	2480	1.204	1.1344	PASS

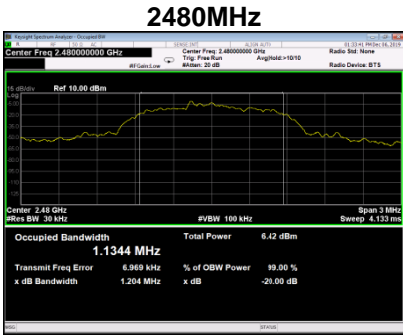
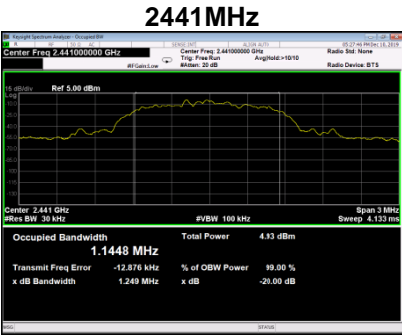
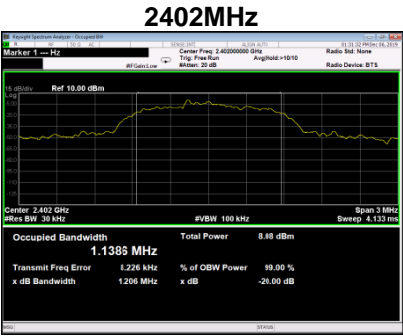

10. MAXIMUM OUTPUT POWER

10.1 LIMIT

FCC Part15 , Subpart C (15.247)		
Section	Test Item	Limit
15.247(a)(1)	Maximum Output Power	0.125Watt or 21dBm

Note:

Frequency hopping systems shall have hopping channel carrier frequencies separated by a minimum of 25 kHz or the 20 dB bandwidth of the hopping channel, whichever is greater. Alternatively, frequency hopping systems operating in the 2400-2483.5 MHz band may have hopping channel carrier frequencies that are separated by 25 kHz or two-thirds of the 20 dB bandwidth of the hopping channel, whichever is greater, provided the systems operate with an output power no greater than 125 mW.

10.2 TEST PROCEDURE AND SETTING

- a. The EUT was directly connected to the spectrum analyzer and antenna output port as show in the block diagram below.
- b. Spectrum Setting: RBW= 1MHz/3MHz, VBW= 3MHz/8MHz, Sweep time = Auto.

10.3 MEASUREMENT INSTRUMENTS LIST

Item	Kind of Equipment	Manufacturer	Type No.	Serial No.	Calibrated until
1	Spectrum analyzer	KEYSIGHT	N9010A	MY55150427	2020/05/27
2	Attenuator	Mini-Circuits	BW-S10W2	101109	2020/12/12
3	RF Cable	Mi-cable	C10-01-01-1	100309	2020/12/12

10.4 TEST SETUP

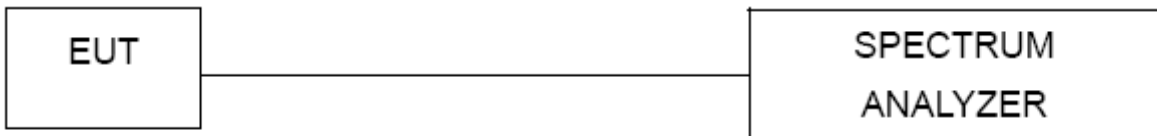

10.5 EUT OPERATION CONDITIONS

The EUT tested system was configured as the statements of 4.5 unless otherwise a special operating condition is specified in the follows during the testing.

10.6 TEST RESULTS

TX Mode_1Mbps				
Channel	Frequency (MHz)	Output Power (dBm)	Output Power (W)	Result
CH00	2402	1.895	0.001547	PASS
CH39	2441	1.162	0.001307	PASS
CH78	2480	0.297	0.001071	PASS
Limit	21dBm /0.125W			

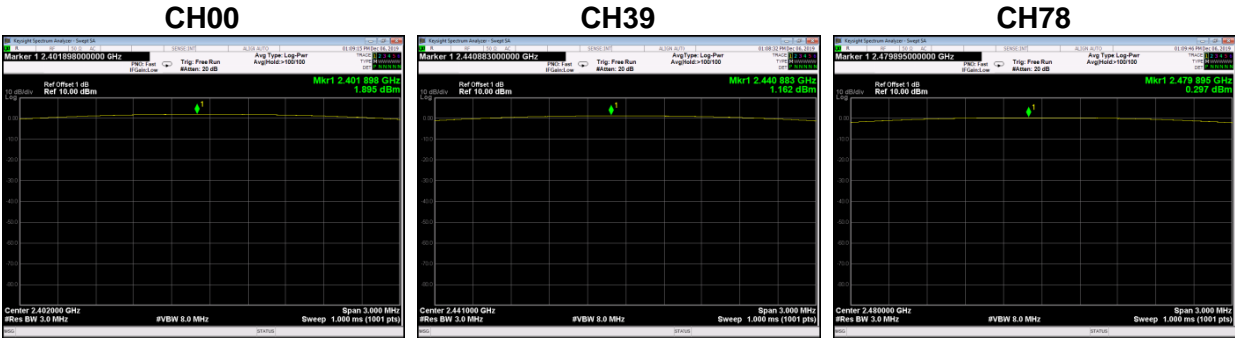

TX Mode_2Mbps				
Channel	Frequency (MHz)	Output Power (dBm)	Output Power (W)	Result
CH00	2402	3.031	0.002010	PASS
CH39	2441	2.409	0.001741	PASS
CH78	2480	0.973	0.001251	PASS
Limit	21dBm /0.125W			

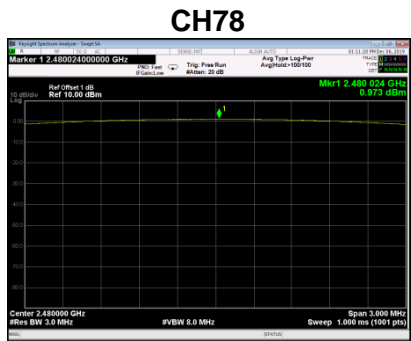
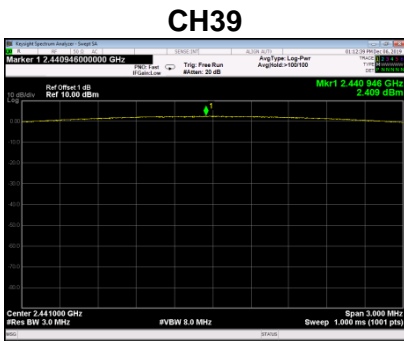
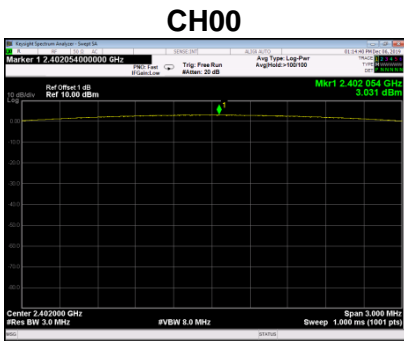

TX Mode_3Mbps				
Channel	Frequency (MHz)	Output Power (dBm)	Output Power (W)	Result
CH00	2402	3.048	0.002017	PASS
CH39	2441	2.406	0.001740	PASS
CH78	2480	1.617	0.001451	PASS
Limit	21dBm /0.125W			

CH00

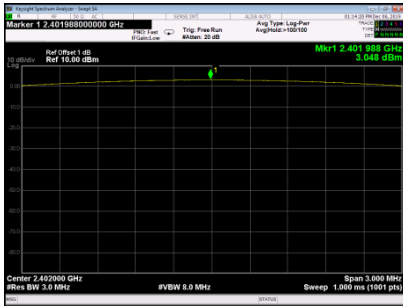

CH39

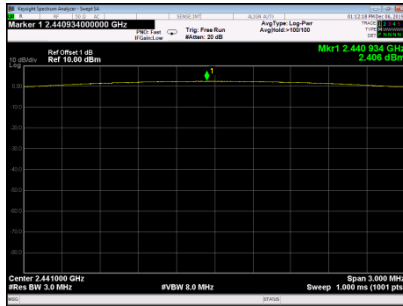

CH78

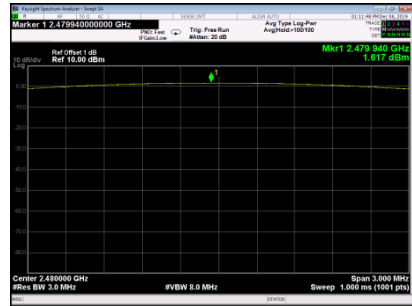

11.CONDUCTED SPURIOUS EMISSION**11.1LIMIT**

For FCC

In any 100 kHz bandwidth outside the frequency band in which the spread spectrum or digitally modulated intentional radiator is operating, the radio frequency power that is produced by the intentional radiator shall be at least 20 dB below that in the 100 kHz bandwidth within the band that contains the highest level of the desired power, based on either an RF conducted or a radiated measurement, provided the transmitter demonstrates compliance with the peak Output Power limits. If the transmitter complies with the Output Power limits based on the use of RMS averaging over a time interval, as permitted under paragraph (b)(3) of this section, the attenuation required under this paragraph shall be 30 dB instead of 20 dB. Attenuation below the general limits specified in Section 15.209(a) is not required.

For ISFD

In any 100 kHz bandwidth outside the frequency band in which the spread spectrum or digitally modulated device is operating, the RF power that is produced shall be at least 20 dB below that in the 100 kHz bandwidth within the band that contains the highest level of the desired power, based on either an RF conducted or a radiated measurement, provided that the transmitter demonstrates compliance with the peak Output Power limits. If the transmitter complies with the Output Power limits based on the use of root-mean-square averaging over a time interval, as permitted under section 5.4(d), the attenuation required shall be 30 dB instead of 20 dB. Attenuation below the general field strength limits specified in RSS-Gen is not required.

11.2TEST PROCEDURE AND SETTING

- a. The EUT was directly connected to the spectrum analyzer and antenna output port as show in the block diagram below.
- b. Spectrum Setting: RBW= 100 kHz, VBW=300 kHz, Sweep time = Auto.

11.3MEASUREMENT INSTRUMENTS LIST

Item	Kind of Equipment	Manufacturer	Type No.	Serial No.	Calibrated until
1	Spectrum analyzer	KEYSIGHT	N9010A	MY55150427	2020/05/27
2	Attenuator	Mini-Circuits	BW-S10W2	101109	2020/12/12
3	RF Cable	Mi-cable	C10-01-01-1	100309	2020/12/12

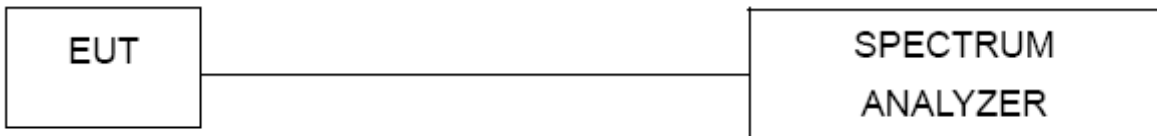
11.4TEST SETUP**11.5EUT OPERATION CONDITIONS**

The EUT tested system was configured as the statements of 4.5 unless otherwise a special operating condition is specified in the follows during the testing.

11.6 TEST RESULTS

TX Mode_1Mbps

Bandedge- CH00 (Lower)

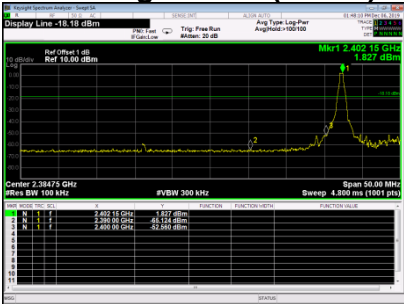

Bandedge CH78 (Upper)

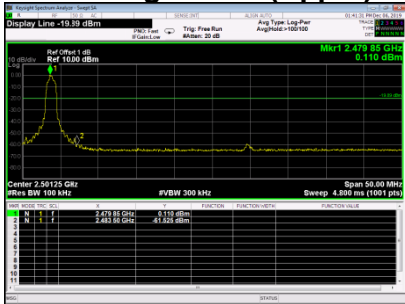

Hopping on mode (Lower)

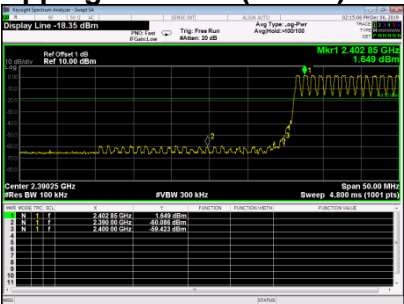

Hopping on mode (Upper)



CH00 – 10th Harmonic of the fundamental frequency

CH00

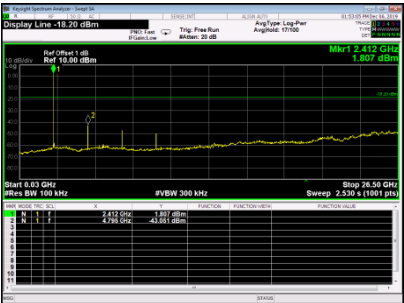

CH39

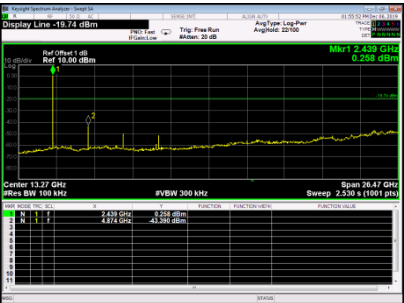

CH78

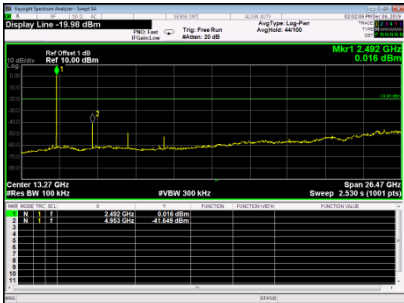

TX Mode_3Mbps

Bandedge- CH00 (Lower)

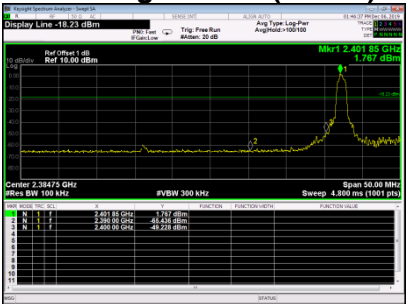

Bandedge CH78 (Upper)

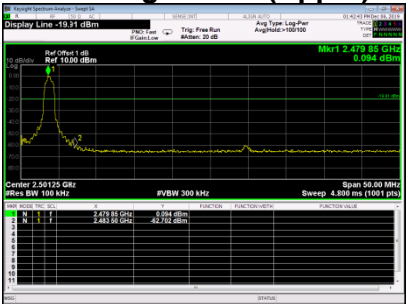

Hopping on mode (Lower)



Hopping on mode (Upper)

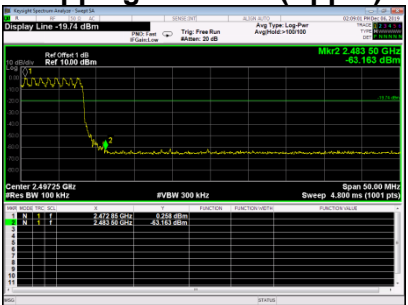

CH00 – 10th Harmonic of the fundamental frequency

CH00

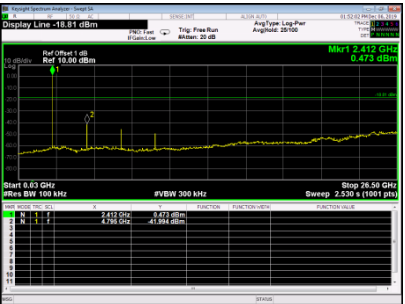

CH39

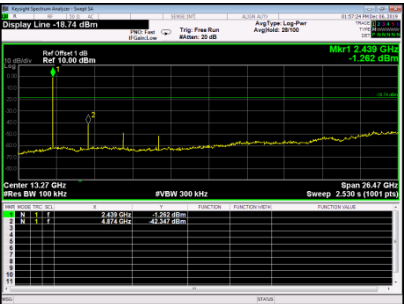

CH78

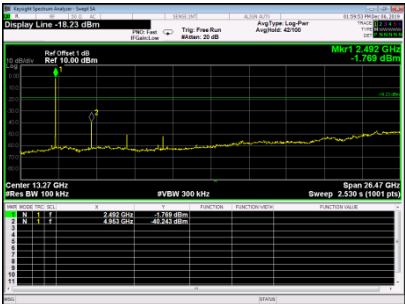

END OF TEST REPORT