



GAMESIR • GAMING IS WINNING.™

© 2018 GameSir Inc. All rights reserved.
Product may vary slightly from those pictures.

GameSir VX AimSwitch

E-sports Combo

User Manual ►

POWER UP YOUR GAMESIR DEVICE



<https://gamesir.hk/pages/g-crux>
(GameSir G-Crux)

PRODUCT DESCRIPTION

GameSir VX AimSwitch E-sports Combo contains GameSir VX E-sports one-handed gaming keypad, GameSir GM190 E-sports gaming mouse and 2.4GHz wireless dongle of GameSir exclusive Agility X technology. It is compatible with mainstream console platforms including Xbox One/PlayStation 4/PlayStation 3/Switch through stable original controller connection, providing accurate and instant keypad and mouse control.

GameSir VX gaming keypad has a 1000mAh built-in lithium battery with 38 E-sports level mechanical switches. It is perfectly compatible with console platforms/PC through 2.4GHz/Bluetooth4.0 connection. Keypad+mouse combo: GameSir GM190 gaming mouse greatly optimizes aiming accuracy and stability, avoiding external mouse's poor compatibility and high consumption.

GameSir G-Crux mobile app allows you to configure every key of the keypad based on your habits when it is connected with mobile phone.

We hope this manual could answer any questions you may have. If you have any further questions, please contact us:

GameSir Facebook: <https://www.facebook.com/myGamesir> Twitter: <https://twitter.com/mygamesir> Customer Service: cs@gamesir.hk

PACKAGE CONTENTS

GameSir VX E-sports gaming keypad
GameSir GM190 E-sports gaming mouse
Detachable and slidable palmrest
Agility X 2.4GHz wireless dongle
Mirco USB cable (3.28 ft.)
User manual

SYSTEM REQUIREMENTS

Windows 7/8/10
PS4/PS4 Slim/PS4 Pro
PS3
Xbox One/Xbox One S/Xbox One X
Nintendo Switch

REGISTRATION

Register your GameSir ID at <https://gamesir.hk/> to get the latest updates about GameSir products and updated warranty information.

YOUR BENEFITS

- * 12-month replacement with the same model from the date you received it.
- * Get free online technical support at <https://gamesir.hk/>

DEVICE LAYOUT

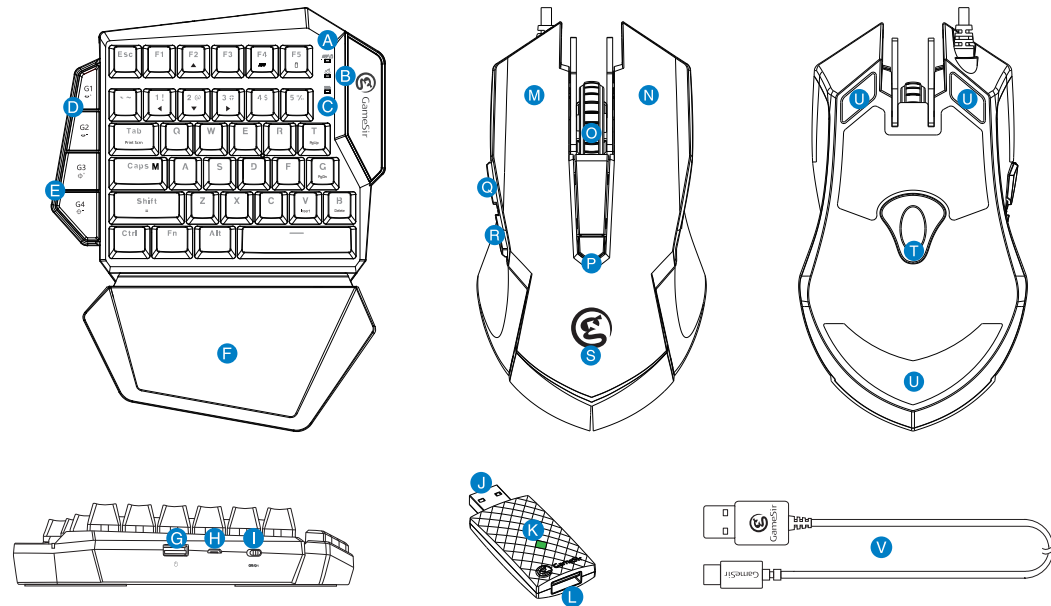

- A** Connection status indicator light
- B** Connection mode indicator light
- C** Power indicator light
- D** HIP sensitivity adjustment (G1-G2)
- E** ADS sensitivity adjustment (G3-G4)
- F** Detachable and slidable palmrest
- G** USB port (for mouse)
- H** Micro-USB port
- I** Power Switch
- J** Agility X 2.4GHz wireless dongle
- K** 2.4GHz dongle indicator light
- L** 2.4GHz dongle USB port
- M** Left button
- N** Right button
- O** Middle bond & roller
- P** DPI button
- Q** Button 5
- R** Button 4
- S** LED logo indicator light
- T** Optical sensor
- U** Mouse skate
- V** Micro-USB charging cable

CONNECTION

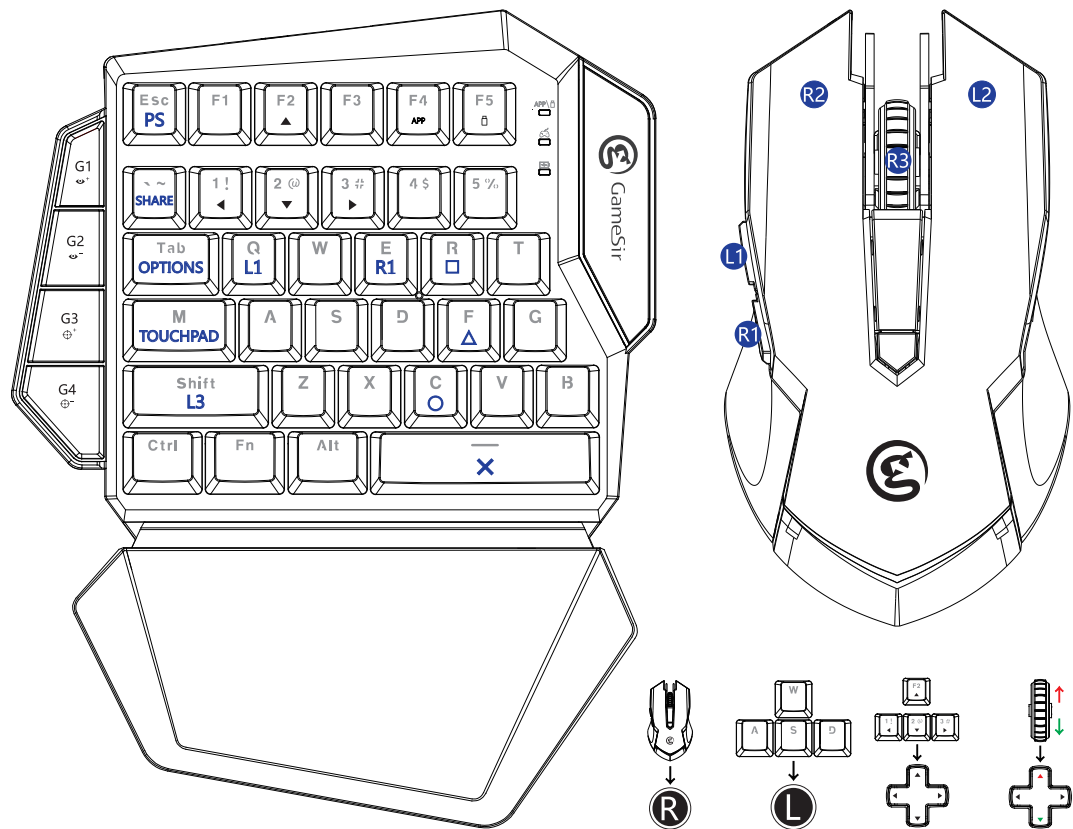

Connect to PS4/PS4 Slim/PS4 Pro

- Power on GameSir VX gaming keypad. The LED indicator light flashes in green, GameSir VX gaming keypad is ready to be connected.
- Plug in GameSir GM190 gaming mouse into the USB port of GameSir VX gaming keypad.
- Plug in Agility X 2.4GHz wireless dongle into the USB port of PS4/PS4 Slim/PS4 Pro. The indicator lights of gaming keypad and Agility X 2.4GHz wireless dongle stay green.
- Power off the PS4 Dualshock4 controller.
- Use USB cable to connect PS4 Dualshock4 controller with Agility X 2.4GHz wireless dongle. The indicator light of GameSir VX gaming keypad stays blue.
- PS4 Dualshock4 controller will turn off. Press ESC/HOME key of GameSir VX gaming keypad to start using on PS4/PS4 Slim/PS4 Pro.

Connect to PS3

- Power on GameSir VX gaming keypad. The LED indicator light flashes in green, GameSir VX gaming keypad can be connected.
- Plug in GameSir GM190 gaming mouse into the USB port of GameSir VX gaming keypad.
- Plug in Agility X 2.4GHz wireless dongle into the USB port of PS3. The indicator lights of gaming keypad and Agility X 2.4GHz wireless dongle stay green.
- Press FN and number 4 key of GameSir VX gaming keypad simultaneously to connect to PS3. The indicator light stays light blue.

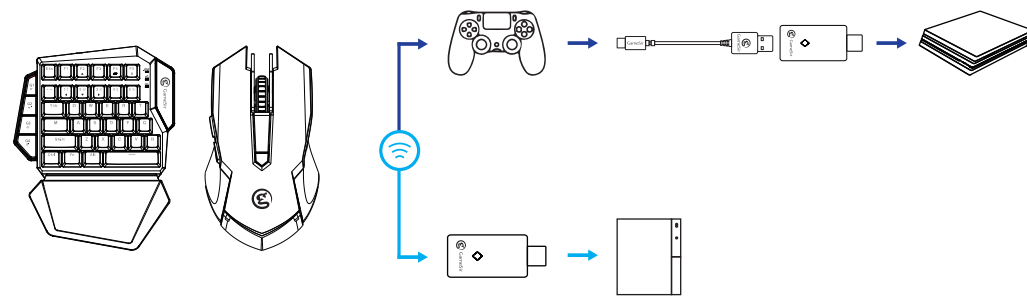

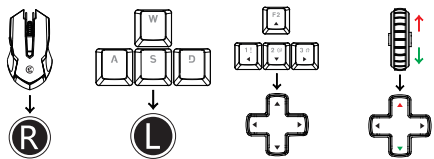
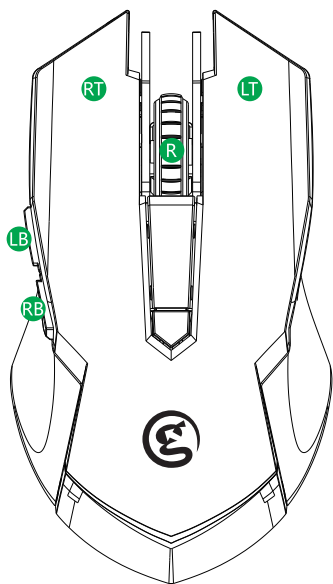
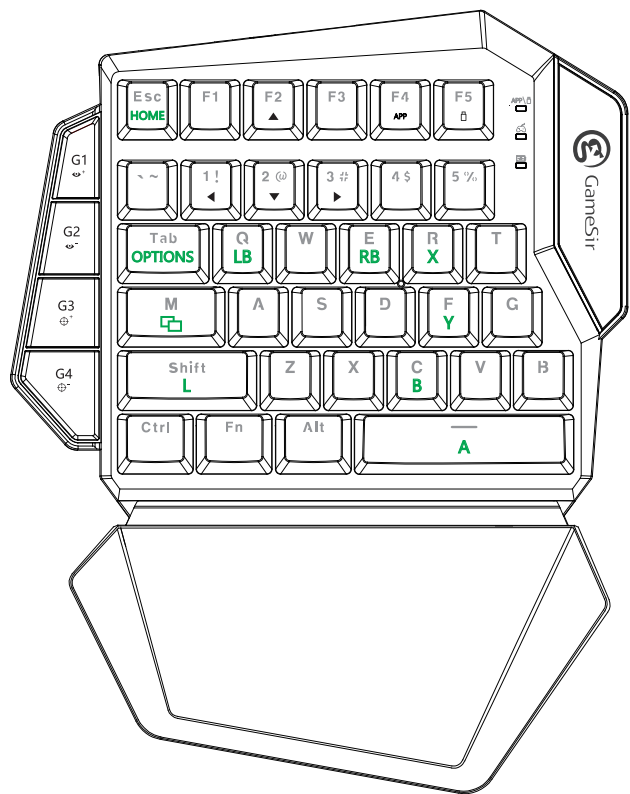

Connect to Xbox One/Xbox One S/Xbox One X

- Power on GameSir VX gaming keypad. The LED indicator light flashes in green, GameSir VX gaming keypad is ready to be connected.
- Plug in GameSir GM190 gaming mouse into the USB port of GameSir VX gaming keypad.
- Plug in Agility X 2.4GHz wireless dongle into the USB port of Xbox One/Xbox One S/Xbox One X. The indicator lights of gaming keypad and Agility X 2.4GHz wireless dongle stay green.
- Use USB cable to connect Xbox One/Xbox One S/Xbox One X controller with Agility X 2.4GHz wireless dongle. The indicator light of GameSir VX gaming keypad stays green.

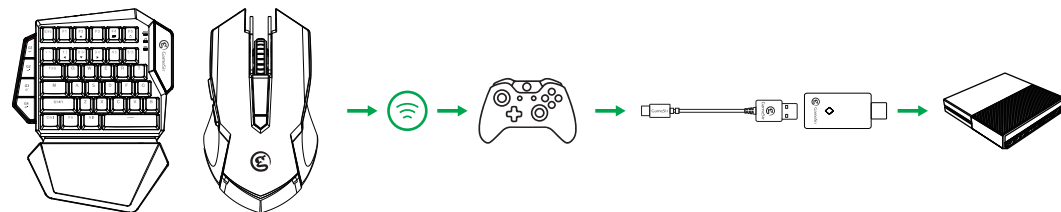

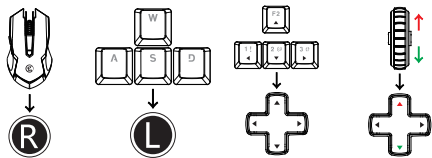
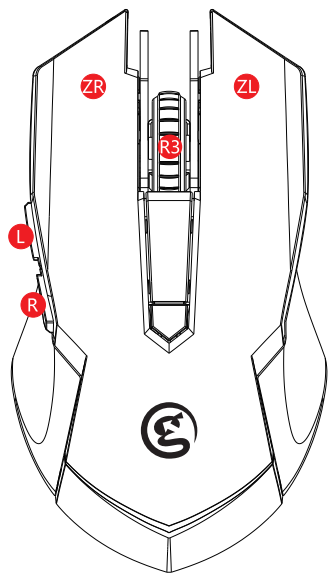
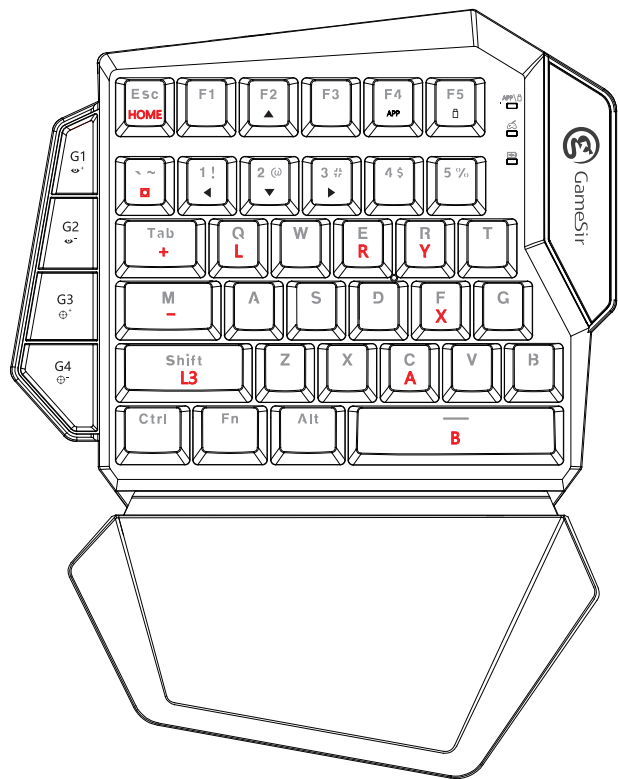

Connect to Nintendo Switch

- Power on GameSir VX gaming keypad. The LED indicator light flashes in green, GameSir VX gaming keypad is ready to be connected.
- Plug in GameSir GM190 gaming mouse into the USB port of GameSir VX gaming keypad.
- Open System Settings turn on pro controller wired communication.
- Plug in Agility X 2.4GHz wireless dongle into the USB port of Nintendo Switch. The indicator lights of gaming keypad and Agility X 2.4GHz wireless dongle stay green.
- Press FN and number 5 key of GameSir VX gaming keypad simultaneously to connect to Nintendo Switch. The indicator light stays red.

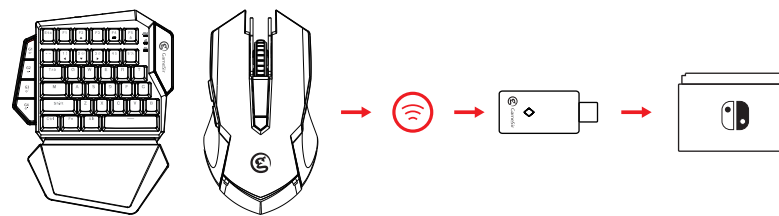

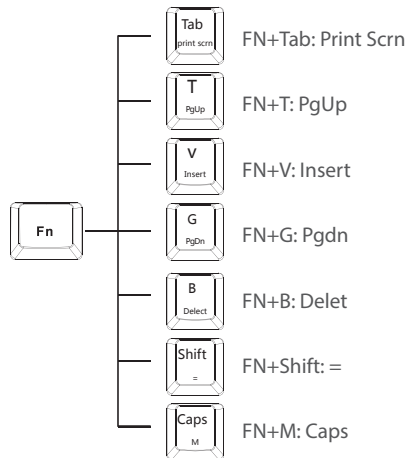
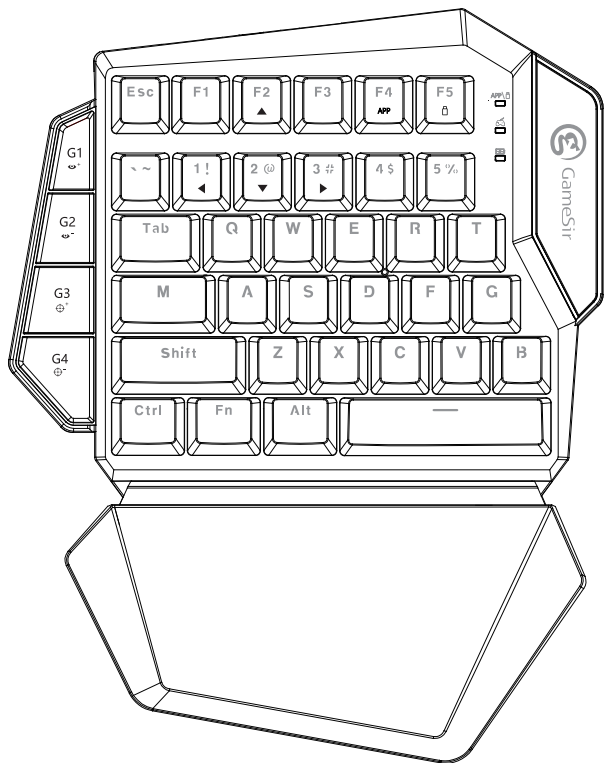

Connect to Windows PC via Agility X 2.4GHz wireless dongle

- Power on GameSir VX gaming keypad. The LED indicator light flashes in green, GameSir VX gaming keypad is ready to be connected.
- Plug in GameSir GM190 gaming mouse into the USB port of Windows PC.
- Plug in Agility X 2.4GHz wireless dongle into the USB port of Windows PC. The indicator lights of GameSir VX gaming keypad and Agility X 2.4GHz wireless dongle stay green.
- The driver will be automatically installed on PC. GameSir VX gaming keypad can work normally.

Connect to Windows PC via cable

- Plug in GameSir VX gaming keypad into the USB port of Windows PC.
- The driver will be automatically installed on PC.
- GameSir VX gaming keypad can work normally.

MixShift function (PC Only)

GameSir VX gaming keypad can meet varied gaming demands as it perfectly deals with different types of games and scenes through its various combination keys. The innovative GameSir MixShift technology provides a brand-new strengthened control of most keys, which can be easily achieved by pressing Fn+certain keys. Besides that, GameSir VX gaming keypad has two sets of unique default key layout profiles, which allow you to switch between W/A/S/D mode and D-pad mode by pressing Fn+F2/1/2/3.

W/A/S/D mode: indicator light is on. D-pad mode: power light and D-pad mode switch light are both on.

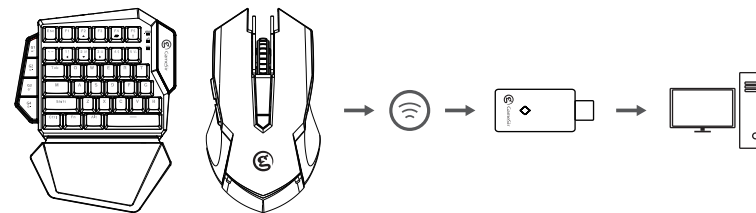

HIP & ADS SENSITIVITY ADJUSTMENT (FOR CONSOLES ONLY)

G1,G2 keys can be used to adjust HIP sensitivity. G1 is to increase the value, G2 is to decrease the value.

There are 10 levels of adjustment. The default level is level 8.

G3,G4 keys can be used to adjust ADS sensitivity. G3 is to increase the value, G4 is to decrease the value.

There are 10 levels of adjustment. The default level is level 5.

GAMESIR GM190 GAMING MOUSE DPI ADJUSTMENT

The default DPI level of GameSir GM190 gaming mouse is 2000. Press the DPI button to adjust 4 levels of DPI (500/1000/1500/2000). The indicator light of GameSir GM190 gaming mouse will flash in different colors:

- Green: 500DPI
- Blue: 1000DPI
- Yellow: 1500DPI
- Red: 2000DPI

GM190 GAMING MOUSE POLLING RATE ADJUSTMENT

The default polling rate of GameSir GM190 gaming mouse is 500Hz. Press the right button+DPI button to adjust 4 levels of polling rate (125Hz/250Hz/500Hz/1000Hz). The indicator light of GameSir GM190 gaming mouse will flash in white in different frequency:

- Flash once: 125Hz
- Flash twice: 250Hz
- Flash three times: 500Hz
- Flash four times: 1000Hz

AUTOMATIC SLEEPING MODE

When GameSir VX gaming keypad is connected, it will automatically switch to sleeping mode within 600 seconds under no operation.

When GameSir VX gaming keypad is disconnected, it will automatically switch to sleeping mode within 120 seconds under no operation.

* When GameSir VX gaming keypad is in sleeping mode, please press G1 button to reconnect again with your devices.

POWER INSTRUCTIONS

Charging time: 2-3 hours.

Charger adapter: 5V-1A.

When GameSir VX gaming keypad is connected, power indicator stays blue.

When GameSir VX gaming keypad is charged, power indicator flashes in green.

When GameSir VX gaming keypad is in low power condition (15% and below), power indicator stays red.

When GameSir VX gaming keypad is in low power condition (5% and below), it will automatically power off.

RESET

Press Fn+Esc to reset GameSir VX gaming keypad.

CONNECT TO GAMESIR VX G-CRUX MOBILE APP

GameSir VX G-Crux APP allows you to configure keys, adjust sensitivity and achieve abundant configurations on GameSir VX gaming keypad.

- a. Power on GameSir VX gaming keypad. The LED indicator light flashes in green, GameSir VX gaming keypad is ready to be connected.
- b. Press Fn and F4 key of GameSir VX gaming keypad simultaneously. The LED indicator light flashes in blue, GameSir VX gaming keypad can be connected to mobile phone.
- c. Turn on Bluetooth on your mobile phone, search GameSir VX gaming keypad to pair and connect. The LED indicator light stays blue when it's connected successfully.
- d. Open GameSir VX G-Crux APP to configure the keys.

FCC Caution.

§ 15.19 Labelling requirements.

This device complies with part 15 of the FCC Rules. Operation is subject to the following two conditions: (1) This device may not cause harmful interference, and (2) this device must accept any interference received, including interference that may cause undesired operation.

§ 15.21 Changes or modification warning.

Any Changes or modifications not expressly approved by the party responsible for compliance could void the user's authority to operate the equipment.

§ 15.105 Information to the user.

Note: This equipment has been tested and found to comply with the limits for a Class B digital device, pursuant to part 15 of the FCC Rules. These limits are designed to provide reasonable protection against harmful interference in a residential installation. This equipment generates uses and can radiate radio frequency energy and, if not installed and used in accordance with the instructions, may cause harmful interference to radio communications.

However, there is no guarantee that interference will not occur in a particular installation. If this equipment does cause harmful interference to radio or television reception, which can be determined by turning the equipment off and on, the user is encouraged to try to correct the interference by one or more of the following measures:

- Reorient or relocate the receiving antenna.
- Increase the separation between the equipment and receiver.
- Connect the equipment into an outlet on a circuit different from that to which the receiver is connected.
- Consult the dealer or an experienced radio/TV technician for help.

