

# FCC Test Report

**Applicant** : **Sudio AB**

---

**Address** : **Artillerigatan 42, 114 45, Stockholm, Sweden**

---

**Product Name** : **Bluetooth earphone**

---

**Report Date** : **May 21, 2024**

---



**Shenzhen Anbotek Compliance Laboratory Limited**

**Shenzhen Anbotek Compliance Laboratory Limited**

Address: 1/F., Building D, Sogood Science and Technology Park, Sanwei Community, Hangcheng Street, Bao'an District, Shenzhen, Guangdong, China.  
Tel: (86)0755-26066440 Fax: (86)0755-26014772 Email: service@anbotek.com



Hotline  
400-003-0500  
www.anbotek.com.cn



# Contents

|  |    |
|--|----|
| 1. General Information .....                         | 6  |
| 1.1. Client Information .....                        | 6  |
| 1.2. Description of Device (EUT) .....               | 6  |
| 1.3. Auxiliary Equipment Used During Test .....      | 7  |
| 1.4. Operation channel list .....                    | 7  |
| 1.5. Description of Test Modes .....                 | 8  |
| 1.6. Measurement Uncertainty .....                   | 8  |
| 1.7. Test Summary .....                              | 9  |
| 1.8. Description of Test Facility .....              | 10 |
| 1.9. Disclaimer .....                                | 10 |
| 1.10. Test Equipment List .....                      | 11 |
| 2. Antenna requirement .....                         | 13 |
| 2.1. Conclusion .....                                | 13 |
| 3. Conducted Emission at AC power line .....         | 14 |
| 3.1. EUT Operation .....                             | 14 |
| 3.2. Test Setup .....                                | 14 |
| 3.3. Test Data .....                                 | 15 |
| 4. Occupied Bandwidth .....                          | 17 |
| 4.1. EUT Operation .....                             | 18 |
| 4.2. Test Setup .....                                | 18 |
| 4.3. Test Data .....                                 | 18 |
| 5. Maximum Conducted Output Power .....              | 19 |
| 5.1. EUT Operation .....                             | 19 |
| 5.2. Test Setup .....                                | 20 |
| 5.3. Test Data .....                                 | 20 |
| 6. Channel Separation .....                          | 21 |
| 6.1. EUT Operation .....                             | 21 |
| 6.2. Test Setup .....                                | 22 |
| 6.3. Test Data .....                                 | 22 |
| 7. Number of Hopping Frequencies .....               | 23 |
| 7.1. EUT Operation .....                             | 23 |
| 7.2. Test Setup .....                                | 24 |
| 7.3. Test Data .....                                 | 24 |
| 8. Dwell Time .....                                  | 25 |
| 8.1. EUT Operation .....                             | 26 |
| 8.2. Test Setup .....                                | 26 |
| 8.3. Test Data .....                                 | 26 |
| 9. Emissions in non-restricted frequency bands ..... | 27 |
| 9.1. EUT Operation .....                             | 28 |
| 9.2. Test Setup .....                                | 28 |
| 9.3. Test Data .....                                 | 28 |

**Shenzhen Anbotek Compliance Laboratory Limited**

Address: 1/F., Building D, Sogood Science and Technology Park, Sanwei Community, Hangcheng Street, Bao'an District, Shenzhen, Guangdong, China.  
Tel: (86)0755-26066440 Fax: (86)0755-26014772 Email: service@anbotek.com



Hotline  
400-003-0500  
www.anbotek.com.cn



|  |    |
|--|----|
| 10. Band edge emissions (Radiated).....            | 29 |
| 10.1. EUT Operation.....                           | 29 |
| 10.2. Test Setup.....                              | 30 |
| 10.3. Test Data.....                               | 31 |
| 11. Emissions in frequency bands (below 1GHz)..... | 32 |
| 11.1. EUT Operation.....                           | 32 |
| 11.2. Test Setup.....                              | 33 |
| 11.3. Test Data.....                               | 34 |
| 12. Emissions in frequency bands (above 1GHz)..... | 36 |
| 12.1. EUT Operation.....                           | 36 |
| 12.2. Test Setup.....                              | 37 |
| 12.3. Test Data.....                               | 38 |
| APPENDIX I -- TEST SETUP PHOTOGRAPH.....           | 41 |
| APPENDIX II -- EXTERNAL PHOTOGRAPH.....            | 41 |
| APPENDIX III -- INTERNAL PHOTOGRAPH.....           | 41 |



Report No.: 18220WC40051801

FCC ID: 2AF9P-T3

Page 4 of 41

# TEST REPORT

Applicant : Sudio AB  
Manufacturer : Dongguan iGlory Co.,Ltd  
Product Name : Bluetooth earphone  
Test Model No. : Sudio T3  
Reference Model No. : N/A  
Trade Mark : **sudio**  
Rating(s) : Input: DC 5V, 300mA  
Case battery capacity: DC 3.7V, 400mAh  
Earphone battery capacity: DC 3.7V, 40 mAh

Test Standard(s) : **47 CFR Part 15.247**  
**ANSI C63.10-2020**  
**KDB 558074 D01 15.247 Meas Guidance v05r02**

The device described above is tested by Shenzhen Anbotek Compliance Laboratory Limited to determine the maximum emission levels emanating from the device and the severe levels of the device can endure and its performance criterion. The measurement results are contained in this test report and Shenzhen Anbotek Compliance Laboratory Limited is assumed full of responsibility for the accuracy and completeness of these measurements. Also, this report shows that the EUT (Equipment Under Test) is technically compliant with above listed standard(s) requirements. This report applies to above tested sample only and shall not be reproduced in part without written approval of Shenzhen Anbotek Compliance Laboratory Limited.

Date of Receipt: Mar. 22 2024

Date of Test: Mar. 22, 2024 to Apr. 30, 2024

Prepared By:

*Nian xiu Chen*

(Nianxiu Chen)

Approved & Authorized Signer:

*Edward Pan*

(Edward Pan)

## Shenzhen Anbotek Compliance Laboratory Limited

Address: 1/F., Building D, Sogood Science and Technology Park, Sanwei Community, Hangcheng Street, Bao'an District, Shenzhen, Guangdong, China.  
Tel: (86)0755-26066440 Fax: (86)0755-26014772 Email: service@anbotek.com



Hotline  
400-003-0500  
www.anbotek.com.cn



**Revision History**

| Report Version | Description     | Issued Date  |
|----------------|-----------------|--------------|
| R00            | Original Issue. | May 21, 2024 |
|                |                 |              |
|                |                 |              |

**Shenzhen Anbotek Compliance Laboratory Limited**

Address: 1/F., Building D, Sogood Science and Technology Park, Sanwei Community, Hangcheng Street, Bao'an District, Shenzhen, Guangdong, China.  
Tel: (86)0755-26066440 Fax: (86)0755-26014772 Email: service@anbotek.com



Hotline  
400-003-0500  
www.anbotek.com.cn



## 1. General Information

### 1.1. Client Information

|              |   |  |
|--------------|---|--|
| Applicant    | : | Sudio AB   |
| Address      | : | Artillerigatan 42, 114 45, Stockholm, Sweden                                   |
| Manufacturer | : | Dongguan iGlory Co.,Ltd  |
| Address      | : | No. 65 ZhengWei 4th Road,DongKeng Town,DongGuan City,GuangDong Province, China |
| Factory      | : | Dongguan iGlory Co.,Ltd  |
| Address      | : | No. 65 ZhengWei 4th Road,DongKeng Town,DongGuan City,GuangDong Province, China |

### 1.2. Description of Device (EUT)

|                     |   |   |
|---------------------|---|---|
| Product Name        | : | Bluetooth earphone  |
| Test Model No.      | : | Sudio T3  |
| Reference Model No. | : | N/A   |
| Trade Mark          | : | <b>sudio</b>  |
| Test Power Supply   | : | DC 5V from Adapter input AC 120V/60Hz; DC 3.7V Battery inside |
| Test Sample No.     | : | 1-2-1(Normal Sample), 1-2-2(Engineering Sample)               |
| Adapter             | : | N/A   |

#### RF Specification

|                     |   |                            |
|---------------------|---|----------------------------|
| Operation Frequency | : | 2402MHz to 2480MHz         |
| Number of Channel   | : | 79                         |
| Modulation Type     | : | GFSK, $\pi/4$ DQPSK, 8DPSK |
| Antenna Type        | : | FPC Antenna                |
| Antenna Gain(Peak)  | : | -2.52 dBi                  |

#### Remark:

- (1) All of the RF specification are provided by customer.
- (2) For a more detailed features description, please refer to the manufacturer's specifications or the User's Manual.
- (3) The EUT consists of two parts, the left and right earphone, both have been tested and only the test data of right earphone recorded in this report.



### 1.3. Auxiliary Equipment Used During Test

| Title              | Manufacturer | Model No. | Serial No.      |
|--------------------|--------------|-----------|-----------------|
| Xiaomi 33W adapter | Xiaomi       | MDY-11-EX | SA62212LA04358J |

### 1.4. Operation channel list

Operation Band:

| Channel | Frequency (MHz) | Channel | Frequency (MHz) | Channel | Frequency (MHz) | Channel | Frequency (MHz) |
|---------|-----------------|---------|-----------------|---------|-----------------|---------|-----------------|
| 0       | 2402            | 20      | 2422            | 40      | 2442            | 60      | 2462            |
| 1       | 2403            | 21      | 2423            | 41      | 2443            | 61      | 2463            |
| 2       | 2404            | 22      | 2424            | 42      | 2444            | 62      | 2464            |
| 3       | 2405            | 23      | 2425            | 43      | 2445            | 63      | 2465            |
| 4       | 2406            | 24      | 2426            | 44      | 2446            | 64      | 2466            |
| 5       | 2407            | 25      | 2427            | 45      | 2447            | 65      | 2467            |
| 6       | 2408            | 26      | 2428            | 46      | 2448            | 66      | 2468            |
| 7       | 2409            | 27      | 2429            | 47      | 2449            | 67      | 2469            |
| 8       | 2410            | 28      | 2430            | 48      | 2450            | 68      | 2470            |
| 9       | 2411            | 29      | 2431            | 49      | 2451            | 69      | 2471            |
| 10      | 2412            | 30      | 2432            | 50      | 2452            | 70      | 2472            |
| 11      | 2413            | 31      | 2433            | 51      | 2453            | 71      | 2473            |
| 12      | 2414            | 32      | 2434            | 52      | 2454            | 72      | 2474            |
| 13      | 2415            | 33      | 2435            | 53      | 2455            | 73      | 2475            |
| 14      | 2416            | 34      | 2436            | 54      | 2456            | 74      | 2476            |
| 15      | 2417            | 35      | 2437            | 55      | 2457            | 75      | 2477            |
| 16      | 2418            | 36      | 2438            | 56      | 2458            | 76      | 2478            |
| 17      | 2419            | 37      | 2439            | 57      | 2459            | 77      | 2479            |
| 18      | 2420            | 38      | 2440            | 58      | 2460            | 78      | 2480            |
| 19      | 2421            | 39      | 2441            | 59      | 2461            | -       | -               |

#### Shenzhen Anbotek Compliance Laboratory Limited

Address: 1/F., Building D, Sogood Science and Technology Park, Sanwei Community, Hangcheng Street, Bao'an District, Shenzhen, Guangdong, China.  
Tel: (86)0755-26066440 Fax: (86)0755-26014772 Email: service@anbotek.com



Hotline  
400-003-0500  
www.anbotek.com.cn



## 1.5. Description of Test Modes

| Pretest Modes | Descriptions  |
|---------------|---|
| TM1           | Keep the EUT in continuously transmitting mode (non-hopping) with GFSK modulation.          |
| TM2           | Keep the EUT in continuously transmitting mode (non-hopping) with $\pi/4$ DQPSK modulation. |
| TM3           | Keep the EUT in continuously transmitting mode (non-hopping) with 8DPSK modulation.         |
| TM4           | Keep the EUT in continuously transmitting mode (hopping) with GFSK modulation,.             |
| TM5           | Keep the EUT in continuously transmitting mode (hopping) with $\pi/4$ DQPSK modulation.     |
| TM6           | Keep the EUT in continuously transmitting mode (hopping) with 8DPSK modulation.             |

## 1.6. Measurement Uncertainty

| Parameter   | Uncertainty   |
|---|---|
| Conducted emissions (AMN 150kHz~30MHz)  | 3.4dB   |
| Occupied Bandwidth  | 925Hz   |
| Conducted Output Power  | 0.76dB  |
| Conducted Spurious Emission   | 1.24dB  |
| Radiated spurious emissions (above 1GHz)  | 1G-6GHz: 4.78dB;<br>6G-18GHz: 4.88dB<br>18G-40GHz: 5.68dB |
| Radiated emissions (Below 30MHz)  | 3.53dB  |
| Radiated spurious emissions (30MHz~1GHz)  | Horizontal: 3.92dB; Vertical: 4.52dB                      |
| The measurement uncertainty and decision risk evaluated according to AB/WI-RF-F-032.<br>This uncertainty represents an expanded uncertainty expressed at approximately the 95% confidence level using a coverage factor of k=2. |   |





**1.7. Test Summary**

| Test Items                                  | Test Modes      | Status |
|---|-----------------|--------|
| Antenna requirement                         | /               | P      |
| Conducted Emission at AC power line         | Mode1,2,3       | P      |
| Occupied Bandwidth                          | Mode1,2,3       | P      |
| Maximum Conducted Output Power              | Mode1,2,3       | P      |
| Channel Separation                          | Mode4,5,6       | P      |
| Number of Hopping Frequencies               | Mode4,5,6       | P      |
| Dwell Time                                  | Mode4,5,6       | P      |
| Emissions in non-restricted frequency bands | Mode1,2,3,4,5,6 | P      |
| Band edge emissions (Radiated)              | Mode1,2,3       | P      |
| Emissions in frequency bands (below 1GHz)   | Mode1,2,3       | P      |
| Emissions in frequency bands (above 1GHz)   | Mode1,2,3       | P      |
| Note:<br>P: Pass<br>N: N/A, not applicable  |                 |        |

**Shenzhen Anbotek Compliance Laboratory Limited**

Address: 1/F., Building D, Sogood Science and Technology Park, Sanwei Community,  
Hangcheng Street, Bao'an District, Shenzhen, Guangdong, China.  
Tel: (86)0755-26066440 Fax: (86)0755-26014772 Email: service@anbotek.com



Hotline  
400-003-0500  
www.anbotek.com.cn



## 1.8. Description of Test Facility

The test facility is recognized, certified, or accredited by the following organizations:

### FCC-Registration No.: 434132

Shenzhen Anbotek Compliance Laboratory Limited, EMC Laboratory has been registered and fully described in a report filed with the (FCC) Federal Communications Commission. The acceptance letter from the FCC is maintained in our files. Registration No. 434132.

### ISED-Registration No.: 8058A

Shenzhen Anbotek Compliance Laboratory Limited, EMC Laboratory has been registered and fully described in a report filed with the (ISED) Innovation, Science and Economic Development Canada. The acceptance letter from the ISED is maintained in our files. Registration 8058A.

### Test Location

Shenzhen Anbotek Compliance Laboratory Limited.

1/F, Building D, Sogood Science and Technology Park, Sanwei community, Hangcheng Street, Bao'an District, Shenzhen, Guangdong, China.

## 1.9. Disclaimer

1. The test report is invalid if not marked with the signatures of the persons responsible for preparing and approving the test report.
2. The test report is invalid if there is any evidence and/or falsification.
3. The results documented in this report apply only to the tested sample, under the conditions and modes of operation as described herein.
4. This document may not be altered or revised in any way unless done so by Anbotek and all revisions are duly noted in the revisions section.
5. Content of the test report, in part or in full, cannot be used for publicity and/or promotional purposes without prior written approval from the laboratory.
6. The authenticity of the information provided by the customer is the responsibility of the customer and the laboratory is not responsible for its authenticity.

The laboratory is only responsible for the data released by the laboratory, except for the part provided by the applicant.

### Shenzhen Anbotek Compliance Laboratory Limited

Address: 1/F., Building D, Sogood Science and Technology Park, Sanwei Community, Hangcheng Street, Bao'an District, Shenzhen, Guangdong, China.  
Tel: (86)0755-26066440 Fax: (86)0755-26014772 Email: service@anbotek.com



Hotline  
400-003-0500  
www.anbotek.com.cn



**1.10. Test Equipment List**

| Conducted Emission at AC power line |   |                  |           |               |            |              |
|-------------------------------------|---|------------------|-----------|---------------|------------|--------------|
| Item                                | Equipment                                   | Manufacturer     | Model No. | Serial No.    | Last Cal.  | Cal.Due Date |
| 1                                   | L.I.S.N. Artificial Mains Network           | Rohde & Schwarz  | ENV216    | 100055        | 2024-01-18 | 2025-01-17   |
| 2                                   | Three Phase V-type Artificial Power Network | CYBERTEK         | EM5040DT  | E215040D T001 | 2024-01-17 | 2025-01-16   |
| 3                                   | Software Name EZ-EMC                        | Farad Technology | ANB-03A   | N/A           | /          | /            |
| 4                                   | EMI Test Receiver                           | Rohde & Schwarz  | ESPI3     | 100926        | 2023-10-12 | 2024-10-11   |

| Occupied Bandwidth<br>Maximum Conducted Output Power<br>Channel Separation<br>Number of Hopping Frequencies<br>Dwell Time<br>Emissions in non-restricted frequency bands |                                       |                 |            |              |            |              |
|--|---------------------------------------|-----------------|------------|--------------|------------|--------------|
| Item   | Equipment                             | Manufacturer    | Model No.  | Serial No.   | Last Cal.  | Cal.Due Date |
| 1  | Constant Temperature Humidity Chamber | ZHONGJIAN       | ZJ-KHWS80B | N/A          | 2023-10-16 | 2024-10-15   |
| 2  | DC Power Supply                       | IVYTECH         | IV3605     | 1804D360 510 | 2023-10-20 | 2024-10-19   |
| 3  | Spectrum Analyzer                     | Rohde & Schwarz | FSV40-N    | 101792       | 2023-05-26 | 2024-05-25   |
| 4  | MXA Spectrum Analysis                 | KEYSIGHT        | N9020A     | MY505318 23  | 2024-02-22 | 2025-02-21   |
| 5  | Oscilloscope                          | Tektronix       | MDO3012    | C020298      | 2023-10-12 | 2024-10-11   |
| 6  | MXG RF Vector Signal Generator        | Agilent         | N5182A     | MY474206 47  | 2024-02-04 | 2025-02-03   |

**Shenzhen Anbotek Compliance Laboratory Limited**

Address: 1/F., Building D, Sogood Science and Technology Park, Sanwei Community, Hangcheng Street, Bao'an District, Shenzhen, Guangdong, China.  
Tel: (86)0755-26066440 Fax: (86)0755-26014772 Email: service@anbotek.com



Hotline  
400-003-0500  
www.anbotek.com.cn



| Band edge emissions (Radiated)<br>Emissions in frequency bands (above 1GHz) |                            |                  |                   |             |            |              |
|---|----------------------------|------------------|-------------------|-------------|------------|--------------|
| Item  | Equipment                  | Manufacturer     | Model No.         | Serial No.  | Last Cal.  | Cal.Due Date |
| 1   | EMI Test Receiver          | Rohde & Schwarz  | ESR26             | 101481      | 2024-01-23 | 2025-01-22   |
| 2   | EMI Preamplifier           | SKET Electronic  | LNPA-0118G-45     | SKET-PA-002 | 2024-01-17 | 2025-01-16   |
| 3   | Double Ridged Horn Antenna | SCHWARZBECK      | BBHA 9120D        | 02555       | 2022-10-16 | 2025-10-15   |
| 4   | EMI Test Software EZ-EMC   | SHURPLE          | N/A               | N/A         | /          | /            |
| 5   | Horn Antenna               | A-INFO           | LB-180400-KF      | J211060628  | 2023-10-12 | 2024-10-11   |
| 6   | Spectrum Analyzer          | Rohde & Schwarz  | FSV40-N           | 101792      | 2023-05-26 | 2024-05-25   |
| 7   | Amplifier                  | Talent Microwave | TLLA18G40 G-50-30 | 23022802    | 2023-05-25 | 2024-05-24   |

| Emissions in frequency bands (below 1GHz) |                          |                 |            |            |            |              |
|---|--------------------------|-----------------|------------|------------|------------|--------------|
| Item                                      | Equipment                | Manufacturer    | Model No.  | Serial No. | Last Cal.  | Cal.Due Date |
| 1   | EMI Test Receiver        | Rohde & Schwarz | ESR26      | 101481     | 2024-01-23 | 2025-01-22   |
| 2   | Pre-amplifier            | SONOMA          | 310N       | 186860     | 2024-01-17 | 2025-01-16   |
| 3   | Bilog Broadband Antenna  | Schwarzbeck     | VULB9163   | 345        | 2022-10-23 | 2025-10-22   |
| 4   | Loop Antenna (9K-30M)    | Schwarzbeck     | FMZB1519 B | 00053      | 2023-10-12 | 2024-10-11   |
| 5   | EMI Test Software EZ-EMC | SHURPLE         | N/A        | N/A        | /          | /            |

### Shenzhen Anbotek Compliance Laboratory Limited

Address: 1/F., Building D, Sogood Science and Technology Park, Sanwei Community, Hangcheng Street, Bao'an District, Shenzhen, Guangdong, China.  
Tel: (86)0755-26066440 Fax: (86)0755-26014772 Email: service@anbotek.com



Hotline  
400-003-0500  
www.anbotek.com.cn



## 2. Antenna requirement

Test Requirement:

Refer to 47 CFR Part 15.203, an intentional radiator shall be designed to ensure that no antenna other than that furnished by the responsible party shall be used with the device. The use of a permanently attached antenna or of an antenna that uses a unique coupling to the intentional radiator shall be considered sufficient to comply with the provisions of this section.

### 2.1. Conclusion

The antenna is a **FPC Antenna** which permanently attached, and the best case gain of the antenna is **-2.52 dBi**. It complies with the standard requirement.

#### Shenzhen Anbotek Compliance Laboratory Limited

Address: 1/F., Building D, Sogood Science and Technology Park, Sanwei Community, Hangcheng Street, Bao'an District, Shenzhen, Guangdong, China.  
Tel: (86)0755-26066440 Fax: (86)0755-26014772 Email: service@anbotek.com



Hotline  
400-003-0500  
www.anbotek.com.cn



### 3. Conducted Emission at AC power line

|                   |   |                              |           |
|-------------------|---|------------------------------|-----------|
| Test Requirement: | Refer to 47 CFR 15.207(a), Except as shown in paragraphs (b) and (c) of this section, for an intentional radiator that is designed to be connected to the public utility (AC) power line, the radio frequency voltage that is conducted back onto the AC power line on any frequency or frequencies, within the band 150 kHz to 30 MHz, shall not exceed the limits in the following table, as measured using a 50 $\mu$ H/50 ohms line impedance stabilization network (LISN). |                              |           |
| Test Limit:       | Frequency of emission (MHz)   | Conducted limit (dB $\mu$ V) |           |
|                   |   | Quasi-peak                   | Average   |
|                   | 0.15-0.5  | 66 to 56*                    | 56 to 46* |
|                   | 0.5-5   | 56                           | 46        |
|                   | 5-30  | 60                           | 50        |
|                   | *Decreases with the logarithm of the frequency.   |                              |           |
| Test Method:      | ANSI C63.10-2020 section 6.2  |                              |           |
| Procedure:        | Refer to ANSI C63.10-2020 section 6.2, standard test method for ac power-line conducted emissions from unlicensed wireless devices  |                              |           |

#### 3.1. EUT Operation

|                        |  |
|------------------------|--|
| Operating Environment: |  |
| Test mode:             | <ol style="list-style-type: none"> <li>1: TX-GFSK (Non-Hopping): Keep the EUT in continuously transmitting mode (non-hopping) with GFSK modulation.</li> <li>2: TX-<math>\pi/4</math>-DQPSK (Non-Hopping): Keep the EUT in continuously transmitting mode (non-hopping) with <math>\pi/4</math> DQPSK modulation.</li> <li>3: TX-8DPSK (Non-Hopping): Keep the EUT in continuously transmitting mode (non-hopping) with 8DPSK modulation.</li> </ol> |

#### 3.2. Test Setup

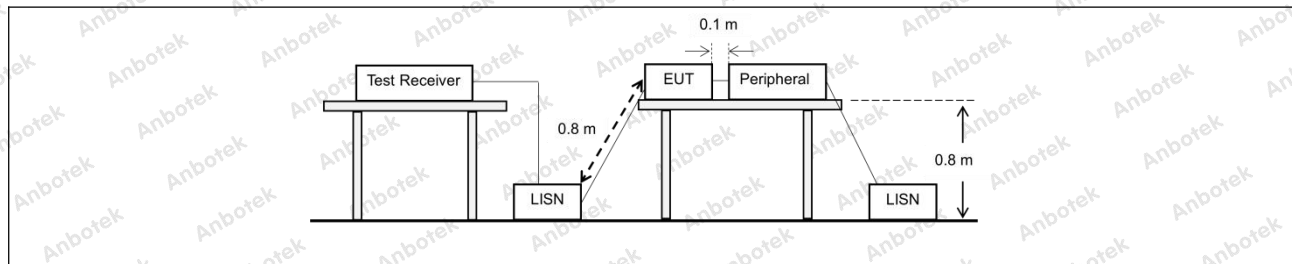

### 3.3. Test Data

|              |         |           |      |                       |         |
|--------------|---------|-----------|------|-----------------------|---------|
| Temperature: | 21.7 °C | Humidity: | 55 % | Atmospheric Pressure: | 101 kPa |
|--------------|---------|-----------|------|-----------------------|---------|

TM3 / Line: Line / Band: 2400-2483.5 MHz / BW: 1 / CH: M

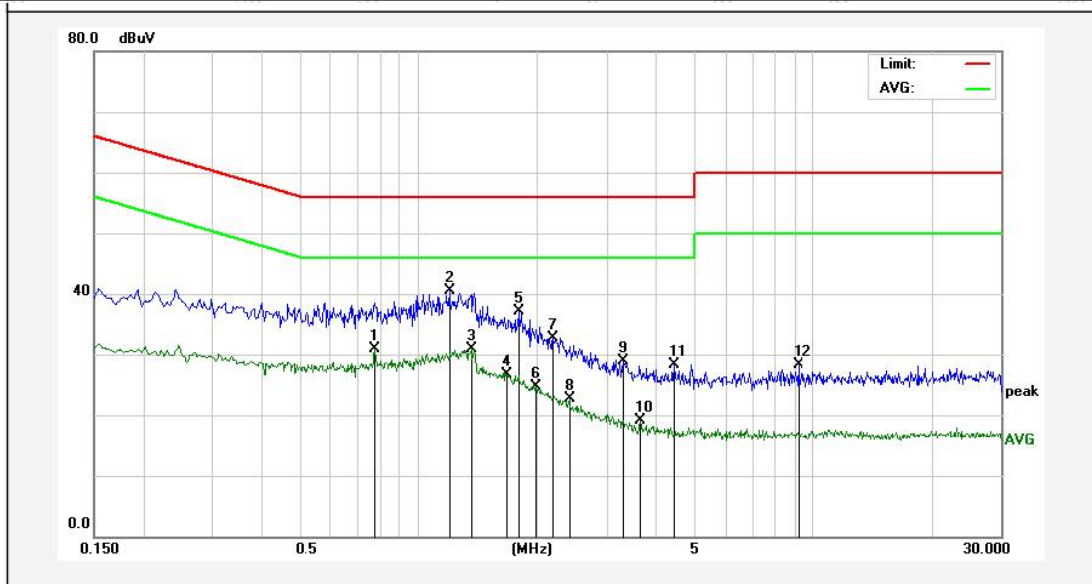

| No. | Freq. (MHz) | Reading (dBuV) | Factor (dB) | Result (dBuV) | Limit (dBuV) | Over Limit (dB) | Detector | Remark |
|-----|-------------|----------------|-------------|---------------|--------------|-----------------|----------|--------|
| 1   | 0.7780      | 12.95          | 17.87       | 30.82         | 46.00        | -15.18          | AVG      |        |
| 2   | 1.2020      | 22.58          | 17.85       | 40.43         | 56.00        | -15.57          | QP       |        |
| 3   | 1.3660      | 13.05          | 17.86       | 30.91         | 46.00        | -15.09          | AVG      |        |
| 4   | 1.6780      | 8.89           | 17.85       | 26.74         | 46.00        | -19.26          | AVG      |        |
| 5   | 1.7980      | 19.32          | 17.86       | 37.18         | 56.00        | -18.82          | QP       |        |
| 6   | 1.9820      | 6.80           | 17.85       | 24.65         | 46.00        | -21.35          | AVG      |        |
| 7   | 2.1980      | 14.90          | 17.85       | 32.75         | 56.00        | -23.25          | QP       |        |
| 8   | 2.4140      | 4.89           | 17.85       | 22.74         | 46.00        | -23.26          | AVG      |        |
| 9   | 3.2940      | 11.04          | 17.85       | 28.89         | 56.00        | -27.11          | QP       |        |
| 10  | 3.6500      | 1.32           | 17.86       | 19.18         | 46.00        | -26.82          | AVG      |        |
| 11  | 4.4420      | 10.40          | 17.85       | 28.25         | 56.00        | -27.75          | QP       |        |
| 12  | 9.1820      | 10.29          | 17.95       | 28.24         | 60.00        | -31.76          | QP       |        |



|              |         |           |      |                       |         |
|--------------|---------|-----------|------|-----------------------|---------|
| Temperature: | 21.7 °C | Humidity: | 55 % | Atmospheric Pressure: | 101 kPa |
|--------------|---------|-----------|------|-----------------------|---------|

TM3 / Line: Neutral / Band: 2400-2483.5 MHz / BW: 1 / CH: M

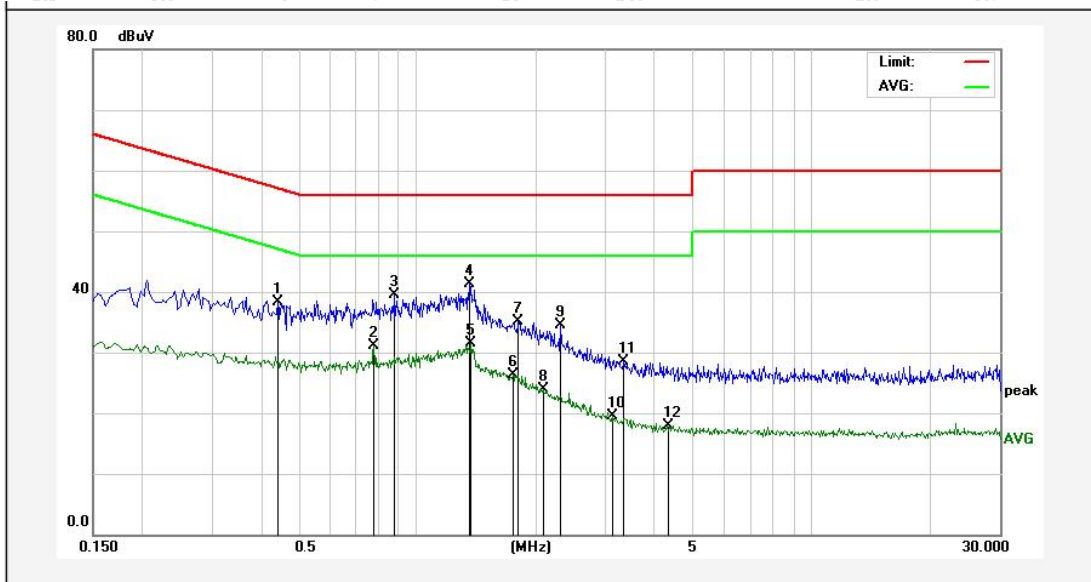

| No. | Freq. (MHz) | Reading (dBuV) | Factor (dB) | Result (dBuV) | Limit (dBuV) | Over Limit (dB) | Detector | Remark |
|-----|-------------|----------------|-------------|---------------|--------------|-----------------|----------|--------|
| 1   | 0.4420      | 20.55          | 17.83       | 38.38         | 57.02        | -18.64          | QP       |        |
| 2   | 0.7780      | 13.17          | 17.87       | 31.04         | 46.00        | -14.96          | AVG      |        |
| 3   | 0.8780      | 21.64          | 17.86       | 39.50         | 56.00        | -16.50          | QP       |        |
| 4   | 1.3580      | 23.41          | 17.86       | 41.27         | 56.00        | -14.73          | QP       |        |
| 5   | 1.3700      | 13.62          | 17.86       | 31.48         | 46.00        | -14.52          | AVG      |        |
| 6   | 1.7500      | 8.50           | 17.86       | 26.36         | 46.00        | -19.64          | AVG      |        |
| 7   | 1.8020      | 17.26          | 17.86       | 35.12         | 56.00        | -20.88          | QP       |        |
| 8   | 2.0780      | 6.03           | 17.85       | 23.88         | 46.00        | -22.12          | AVG      |        |
| 9   | 2.2980      | 16.71          | 17.85       | 34.56         | 56.00        | -21.44          | QP       |        |
| 10  | 3.1220      | 1.73           | 17.85       | 19.58         | 46.00        | -26.42          | AVG      |        |
| 11  | 3.3340      | 10.75          | 17.85       | 28.60         | 56.00        | -27.40          | QP       |        |
| 12  | 4.3140      | 0.06           | 17.85       | 17.91         | 46.00        | -28.09          | AVG      |        |

Note: Only record the worst data in the report.





## 4. Occupied Bandwidth

|                   |   |
|-------------------|---|
| Test Requirement: | 47 CFR 15.215(c)  |
| Test Limit:       | Refer to 47 CFR 15.215(c), intentional radiators operating under the alternative provisions to the general emission limits, as contained in §§ 15.217 through 15.257 and in subpart E of this part, must be designed to ensure that the 20 dB bandwidth of the emission, or whatever bandwidth may otherwise be specified in the specific rule section under which the equipment operates, is contained within the frequency band designated in the rule section under which the equipment is operated.   |
| Test Method:      | ANSI C63.10-2020, section 7.8.6, For occupied bandwidth measurements, use the procedure in 6.9.3. Frequency hopping shall be disabled for this test. KDB 558074 D01 15.247 Meas Guidance v05r02   |
| Procedure:        | <p>The occupied bandwidth is the frequency bandwidth such that, below its lower and above its upper frequency limits, the mean powers are each equal to 0.5% of the total mean power of the given emission. The following procedure shall be used for measuring 99% power bandwidth:</p> <ol style="list-style-type: none"> <li>The instrument center frequency is set to the nominal EUT channel center frequency. The frequency span for the spectrum analyzer shall be between 1.5 times and 5.0 times the OBW.</li> <li>The nominal IF filter bandwidth (3 dB RBW) shall be in the range of 1% to 5% of the OBW, and VBW shall be at least three times the RBW, unless otherwise specified by the applicable requirement.</li> <li>Set the reference level of the instrument as required, keeping the signal from exceeding the maximum input mixer level for linear operation. In general, the peak of the spectral envelope shall be more than <math>[10 \log (\text{OBW}/\text{RBW})]</math> below the reference level. Specific guidance is given in 4.1.6.2.</li> <li>Step a) through step c) might require iteration to adjust within the specified range.</li> <li>Video averaging is not permitted. Where practical, a sample detection and single sweep mode shall be used. Otherwise, peak detection and max-hold mode (until the trace stabilizes) shall be used.</li> <li>Use the 99% power bandwidth function of the instrument (if available) and report the measured bandwidth.</li> <li>If the instrument does not have a 99% power bandwidth function, then the trace data points are recovered and directly summed in linear power terms. The recovered amplitude data points, beginning at the lowest frequency, are placed in a running sum until 0.5% of the total is reached; that frequency is recorded as the lower frequency. The process is repeated until 99.5% of the total is reached; that frequency is recorded as the upper frequency. The 99% power bandwidth is the difference between these two frequencies.</li> <li>The occupied bandwidth shall be reported by providing spectral plot(s) of the measuring instrument display; the plot axes and the scale units per division shall be clearly labeled. Tabular data may be reported in addition to the plot(s).</li> </ol> |



#### 4.1. EUT Operation

**Operating Environment:**

|            |  |
|------------|--|
| Test mode: | 1: TX-GFSK (Non-Hopping): Keep the EUT in continuously transmitting mode (non-hopping) with GFSK modulation.<br>2: TX- $\pi/4$ -DQPSK (Non-Hopping): Keep the EUT in continuously transmitting mode (non-hopping) with $\pi/4$ DQPSK modulation.<br>3: TX-8DPSK (Non-Hopping): Keep the EUT in continuously transmitting mode (non-hopping) with 8DPSK modulation. |
|------------|--|

#### 4.2. Test Setup

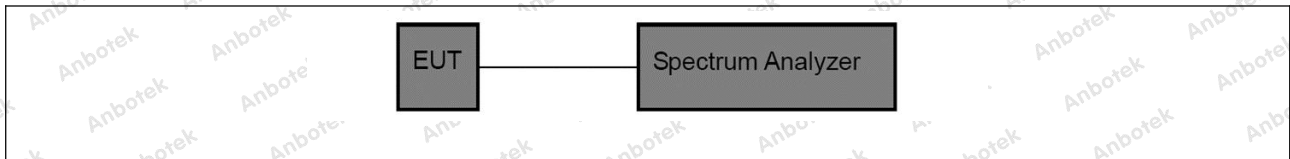

#### 4.3. Test Data

|              |         |           |      |                       |         |
|--------------|---------|-----------|------|-----------------------|---------|
| Temperature: | 25.5 °C | Humidity: | 49 % | Atmospheric Pressure: | 101 kPa |
|--------------|---------|-----------|------|-----------------------|---------|

Please Refer to Appendix for Details.



## 5. Maximum Conducted Output Power

|                   |  |
|-------------------|--|
| Test Requirement: | 47 CFR 15.247(b)(1)  |
| Test Limit:       | Refer to 47 CFR 15.247(b)(1), For frequency hopping systems operating in the 2400-2483.5 MHz band employing at least 75 non-overlapping hopping channels, and all frequency hopping systems in the 5725-5850 MHz band: 1 watt. For all other frequency hopping systems in the 2400-2483.5 MHz band: 0.125 watts.   |
| Test Method:      | ANSI C63.10-2020, section 7.8.5<br>KDB 558074 D01 15.247 Meas Guidance v05r02  |
| Procedure:        | <p>This is an RF-conducted test to evaluate maximum peak output power. Use a direct connection between the antenna port of the unlicensed wireless device and the spectrum analyzer, through suitable attenuation. Frequency hopping shall be disabled for this test. Use the following spectrum analyzer settings:</p> <ul style="list-style-type: none"> <li>a) Span: Approximately five times the 20 dB bandwidth, centered on a hopping channel.</li> <li>b) RBW &gt; 20 dB bandwidth of the emission being measured.</li> <li>c) VBW ≥ RBW.</li> <li>d) Sweep: No faster than coupled (auto) time.</li> <li>e) Detector function: Peak.</li> <li>f) Trace: Max-hold.</li> <li>g) Allow trace to stabilize.</li> <li>h) Use the marker-to-peak function to set the marker to the peak of the emission.</li> <li>i) The indicated level is the peak output power, after any corrections for external attenuators and cables.</li> <li>j) A spectral plot of the test results and setup description shall be included in the test report.</li> </ul> <p>NOTE—A peak responding power meter may be used, where the power meter and sensor system video bandwidth is greater than the occupied bandwidth of the unlicensed wireless device, rather than a spectrum analyzer.</p> |

### 5.1. EUT Operation

|                        |  |
|------------------------|--|
| Operating Environment: |  |
| Test mode:             | <ul style="list-style-type: none"> <li>1: TX-GFSK (Non-Hopping): Keep the EUT in continuously transmitting mode (non-hopping) with GFSK modulation.</li> <li>2: TX-<math>\pi/4</math>-DQPSK (Non-Hopping): Keep the EUT in continuously transmitting mode (non-hopping) with <math>\pi/4</math> DQPSK modulation.</li> <li>3: TX-8DPSK (Non-Hopping): Keep the EUT in continuously transmitting mode (non-hopping) with 8DPSK modulation.</li> </ul> |



## 5.2. Test Setup

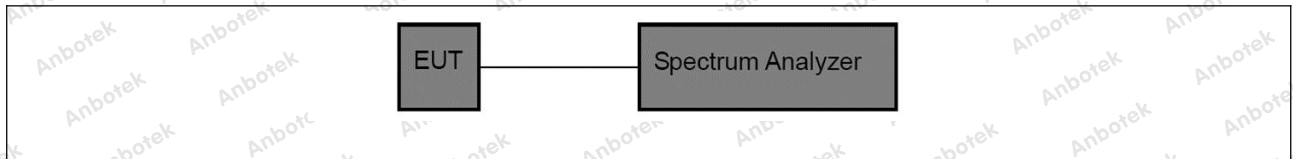

## 5.3. Test Data

|              |         |           |      |                       |         |
|--------------|---------|-----------|------|-----------------------|---------|
| Temperature: | 25.5 °C | Humidity: | 49 % | Atmospheric Pressure: | 101 kPa |
|--------------|---------|-----------|------|-----------------------|---------|

Please Refer to Appendix for Details.



## 6. Channel Separation

|                   |   |
|-------------------|---|
| Test Requirement: | 47 CFR 15.247(a)(1)   |
| Test Limit:       | Refer to 47 CFR 15.247(a)(1), Frequency hopping systems shall have hopping channel carrier frequencies separated by a minimum of 25 kHz or the 20 dB bandwidth of the hopping channel, whichever is greater.<br>Alternatively, frequency hopping systems operating in the 2400-2483.5 MHz band may have hopping channel carrier frequencies that are separated by 25 kHz or two-thirds of the 20 dB bandwidth of the hopping channel, whichever is greater, provided the systems operate with an output power no greater than 125 mW.   |
| Test Method:      | ANSI C63.10-2020, section 7.8.2<br>KDB 558074 D01 15.247 Meas Guidance v05r02   |
| Procedure:        | The EUT shall have its hopping function enabled. Use the following spectrum analyzer settings:<br>a) Span: Wide enough to capture the peaks of two adjacent channels.<br>b) RBW: Start with the RBW set to approximately 30% of the channel spacing; adjust as necessary to best identify the center of each individual channel.<br>c) Video (or average) bandwidth (VBW) $\geq$ RBW.<br>d) Sweep: No faster than coupled (auto) time.<br>e) Detector function: Peak.<br>f) Trace: Max-hold.<br>g) Allow the trace to stabilize.<br><br>Use the marker-delta function to determine the separation between the peaks of the adjacent channels. Compliance of an EUT with the appropriate regulatory limit shall be determined. A spectral plot of the data shall be included in the test report. |

### 6.1. EUT Operation

|                        |   |
|------------------------|---|
| Operating Environment: |   |
| Test mode:             | 4: TX-GFSK (Hopping): Keep the EUT in continuously transmitting mode (hopping) with GFSK modulation.,<br>5: TX- $\pi/4$ -DQPSK (Hopping): Keep the EUT in continuously transmitting mode (hopping) with $\pi/4$ DQPSK modulation.<br>6: TX-8DPSK (Hopping): Keep the EUT in continuously transmitting mode (hopping) with 8DPSK modulation. |



## 6.2. Test Setup

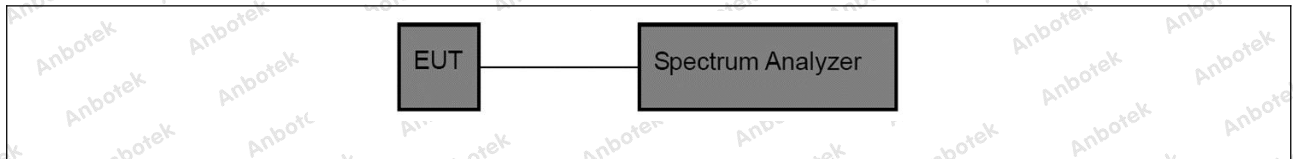

## 6.3. Test Data

|              |         |           |      |                       |         |
|--------------|---------|-----------|------|-----------------------|---------|
| Temperature: | 25.5 °C | Humidity: | 49 % | Atmospheric Pressure: | 101 kPa |
|--------------|---------|-----------|------|-----------------------|---------|

Please Refer to Appendix for Details.



## 7. Number of Hopping Frequencies

|                   |  |
|-------------------|--|
| Test Requirement: | 47 CFR 15.247(a)(1)(iii)   |
| Test Limit:       | Refer to 47 CFR 15.247(a)(1)(iii), Frequency hopping systems in the 2400-2483.5 MHz band shall use at least 15 channels. The average time of occupancy on any channel shall not be greater than 0.4 seconds within a period of 0.4 seconds multiplied by the number of hopping channels employed. Frequency hopping systems may avoid or suppress transmissions on a particular hopping frequency provided that a minimum of 15 channels are used.   |
| Test Method:      | ANSI C63.10-2020, section 7.8.3<br>KDB 558074 D01 15.247 Meas Guidance v05r02  |
| Procedure:        | <p>The EUT shall have its hopping function enabled. Use the following spectrum analyzer settings:</p> <ul style="list-style-type: none"> <li>a) Span: The frequency band of operation. Depending on the number of channels the device supports, it could be necessary to divide the frequency range of operation across multiple spans, to allow the individual channels to be clearly seen.</li> <li>b) RBW: To identify clearly the individual channels, set the RBW to less than 30% of the channel spacing or the 20 dB bandwidth, whichever is smaller.</li> <li>c) VBW <math>\geq</math> RBW.</li> <li>d) Sweep: No faster than coupled (auto) time.</li> <li>e) Detector function: Peak.</li> <li>f) Trace: Max-hold.</li> <li>g) Allow the trace to stabilize.</li> </ul> <p>It might prove necessary to break the span up into subranges to show clearly all of the hopping frequencies. Compliance of an EUT with the appropriate regulatory limit shall be determined for the number of hopping channels. A spectral plot of the data shall be included in the test report.</p> |

### 7.1. EUT Operation

|                        |  |
|------------------------|--|
| Operating Environment: |  |
| Test mode:             | <p>4: TX-GFSK (Hopping): Keep the EUT in continuously transmitting mode (hopping) with GFSK modulation,.</p> <p>5: TX-<math>\pi/4</math>-DQPSK (Hopping): Keep the EUT in continuously transmitting mode (hopping) with <math>\pi/4</math> DQPSK modulation.</p> <p>6: TX-8DPSK (Hopping): Keep the EUT in continuously transmitting mode (hopping) with 8DPSK modulation.</p> |



## 7.2. Test Setup

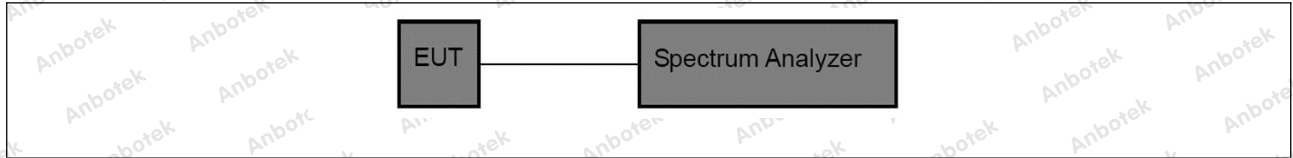

## 7.3. Test Data

|              |         |           |      |                       |         |
|--------------|---------|-----------|------|-----------------------|---------|
| Temperature: | 25.5 °C | Humidity: | 49 % | Atmospheric Pressure: | 101 kPa |
|--------------|---------|-----------|------|-----------------------|---------|

Please Refer to Appendix for Details.





## 8. Dwell Time

|                   |   |
|-------------------|---|
| Test Requirement: | 47 CFR 15.247(a)(1)(iii)  |
| Test Limit:       | Refer to 47 CFR 15.247(a)(1)(iii), Frequency hopping systems in the 2400-2483.5 MHz band shall use at least 15 channels. The average time of occupancy on any channel shall not be greater than 0.4 seconds within a period of 0.4 seconds multiplied by the number of hopping channels employed. Frequency hopping systems may avoid or suppress transmissions on a particular hopping frequency provided that a minimum of 15 channels are used.  |
| Test Method:      | ANSI C63.10-2020, section 7.8.4<br>KDB 558074 D01 15.247 Meas Guidance v05r02   |
| Procedure:        | <p>The dwell time per hop on a channel is the time from the start of the first transmission to the end of the last transmission for that hop. If the device has a single transmission per hop then the dwell time is the duration of that transmission. If the device has a multiple transmissions per hop then the dwell time is measured from the start of the first transmission to the end of the last transmission.</p> <p>The time of occupancy is the total time that the device dwells on a channel over an observation period specified in the regulatory requirement. To determine the time of occupancy the spectrum analyzer will be configured to measure both the dwell time per hop and the number of times the device transmits on a specific channel in a given period.</p> <p>The EUT shall have its hopping function enabled. Compliance with the requirements shall be made with the minimum and with the maximum number of channels enabled. If the dwell time per channel does not vary with the number of channels then compliance with the requirements may be based on the minimum number of channels. If the device supports different dwell times per channel (example Bluetooth devices can dwell on a channel for 1, 3 or 5 time slots) then measurements can be limited to the longest dwell time with the minimum number of channels.</p> <p>Use the following spectrum analyzer settings to determine the dwell time per hop:</p> <ul style="list-style-type: none"> <li>a) Span: Zero span, centered on a hopping channel.</li> <li>b) RBW shall be <math>\leq</math> channel spacing and where possible RBW should be set <math>\gg 1/T</math>, where T is the expected transmission time per hop.</li> <li>c) Sweep time: Set so that the start of the first transmission and end of the last transmission for the hop are clearly captured. Setting the sweep time to be slightly longer than the hopping period per channel (hopping period = <math>1/\text{hopping rate}</math>) should achieve this.</li> <li>d) Use a video trigger, where possible with a trigger delay, so that the start of the transmission is clearly observed. The trigger level might need adjustment to reduce the chance of triggering when the system hops on an adjacent channel.</li> <li>e) Detector function: Peak.</li> <li>f) Trace: Clear-write, single sweep.</li> <li>g) Place markers at the start of the first transmission on the channel and at</li> </ul> |



|  |  |
|--|--|
|  | <p>the end of the last transmission. The dwell time per hop is the time between these two markers.</p> <p>To determine the number of hops on a channel in the regulatory observation period repeat the measurement using a longer sweep time. When the device uses a single hopping sequence the period of measurement should be sufficient to capture at least 2 hops. When the device uses a dynamic hopping sequence, or the sequence varies, the period of measurement may need to capture multiple hops to better determine the average time of occupancy. Count the number of hops on the channel across the sweep time.</p> <p>The average number of hops on the same channel within the regulatory observation period is calculated from the number of hops on the channel divided by the spectrum analyzer sweep time multiplied by the regulatory observation period. For example, if three hops are counted with an analyzer sweep time of 500 ms and the regulatory observation period is 10 s, then the number of hops in that ten seconds is <math>3 / 0.5 \times 10</math>, or 60 hops.</p> <p>The average time of occupancy is calculated by multiplying the dwell time per hop by the number of hops in the observation period.</p> |
|--|--|

## 8.1. EUT Operation

|                        |   |
|------------------------|---|
| Operating Environment: |   |
| Test mode:             | <p>4: TX-GFSK (Hopping): Keep the EUT in continuously transmitting mode (hopping) with GFSK modulation.</p> <p>5: TX-<math>\pi/4</math>-DQPSK (Hopping): Keep the EUT in continuously transmitting mode (hopping) with <math>\pi/4</math> DQPSK modulation.</p> <p>6: TX-8DPSK (Hopping): Keep the EUT in continuously transmitting mode (hopping) with 8DPSK modulation.</p> |

## 8.2. Test Setup

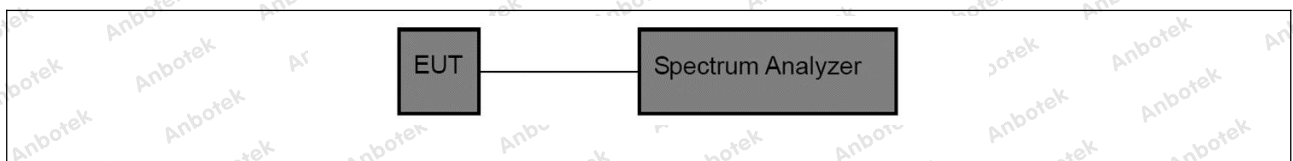

## 8.3. Test Data

|              |         |           |      |                       |         |
|--------------|---------|-----------|------|-----------------------|---------|
| Temperature: | 25.5 °C | Humidity: | 49 % | Atmospheric Pressure: | 101 kPa |
|--------------|---------|-----------|------|-----------------------|---------|

Please Refer to Appendix for Details.



## 9. Emissions in non-restricted frequency bands

|                   |   |
|-------------------|---|
| Test Requirement: | 47 CFR 15.247(d), 15.209, 15.205  |
| Test Limit:       | <p>Refer to 47 CFR 15.247(d), In any 100 kHz bandwidth outside the frequency band in which the spread spectrum or digitally modulated intentional radiator is operating, the radio frequency power that is produced by the intentional radiator shall be at least 20 dB below that in the 100 kHz bandwidth within the band that contains the highest level of the desired power, based on either an RF conducted or a radiated measurement, provided the transmitter demonstrates compliance with the peak conducted power limits. If the transmitter complies with the conducted power limits based on the use of RMS averaging over a time interval, as permitted under paragraph (b)(3) of this section, the attenuation required under this paragraph shall be 30 dB instead of 20 dB. Attenuation below the general limits specified in § 15.209(a) is not required.</p>  |
| Test Method:      | ANSI C63.10-2020 section 7.8.7<br>KDB 558074 D01 15.247 Meas Guidance v05r02  |
| Procedure:        | <p><b>7.8.7.1 General considerations</b><br/>To demonstrate compliance with the relative out-of-band emissions requirements conducted spurious emissions shall be measured for the transmit frequencies, per 5.5 and 5.6, and at the maximum transmit powers. Frequency hopping shall be disabled for this test with the exception of measurements at the allocated band-edges which shall be repeated with hopping enabled.</p> <p>Connect the primary antenna port through an attenuator to the spectrum analyzer input; in the results, account for all losses between the unlicensed wireless device output and the spectrum analyzer. The frequency range of testing shall span 30 MHz to 10 times the operating frequency and this may be done in a single sweep or, to aid resolution, across a number of sweeps. The resolution bandwidth shall be 100 kHz, video bandwidth 300 kHz, and a coupled sweep time with a peak detector.</p> <p>The limit is based on the highest in-band level across all channels measured using the same instrument settings (resolution bandwidth of 100 kHz, video bandwidth of 300 kHz, and a coupled sweep time with a peak detector). To help clearly demonstrate compliance a display line may be set at the required offset (typically 20 dB) below the highest in-band level. Where the highest in-band level is not clearly identified in the out-of-band measurements a separate spectral plot showing the in-band level shall be provided.</p> <p>When conducted measurements cannot be made (for example a device with integrated, non-removable antenna) radiated measurements shall be used. The reference level for determining the limit shall be established by maximizing the field strength from the highest power channel and measuring using the resolution and video bandwidth settings and peak detector as described above. The field strength limit for spurious emissions outside of restricted-bands shall then be set at the required offset (typically 20 dB) below the highest in-band level. Radiated measurements will follow the standards measurement procedures described in Clause 6 with the</p> |



|  |  |
|--|--|
|  | <p>exception that the resolution bandwidth shall be 100 kHz, video bandwidth 300 kHz, and a coupled sweep time with a peak detector. Note that use of wider measurement bandwidths are acceptable for measuring the spurious emissions provided that the peak detector is used and that the measured value of spurious emissions are compared to the highest in-band level measured with the 100 kHz / 300 kHz bandwidth settings to determine compliance.</p> <p><b>7.8.7.2 Band-edges</b><br/>Compliance with a relative limit at the band-edges (e.g., -20 dBc) shall be made on the lowest and on the highest channels with frequency hopping disabled and repeated with frequency hopping enabled. For the latter test the hopping sequence shall include the lowest and highest channels.</p> <p>For measurements with the hopping disabled the analyzer screen shall clearly show compliance with the requirement within 10 MHz of the allocated band-edge.</p> <p>For measurements with the hopping enabled the analyzer screen shall clearly show compliance with the requirement within 10 MHz of both of the allocated band-edges. This could require separate spectral plots for each band-edge.</p> |
|--|--|

## 9.1. EUT Operation

|                        |   |
|------------------------|---|
| Operating Environment: |   |
| Test mode:             | <ol style="list-style-type: none"> <li>1: TX-GFSK (Non-Hopping): Keep the EUT in continuously transmitting mode (non-hopping) with GFSK modulation.</li> <li>2: TX-<math>\pi/4</math>-DQPSK (Non-Hopping): Keep the EUT in continuously transmitting mode (non-hopping) with <math>\pi/4</math> DQPSK modulation.</li> <li>3: TX-8DPSK (Non-Hopping): Keep the EUT in continuously transmitting mode (non-hopping) with 8DPSK modulation.</li> <li>4: TX-GFSK (Hopping): Keep the EUT in continuously transmitting mode (hopping) with GFSK modulation,.</li> <li>5: TX-<math>\pi/4</math>-DQPSK (Hopping): Keep the EUT in continuously transmitting mode (hopping) with <math>\pi/4</math> DQPSK modulation.</li> <li>6: TX-8DPSK (Hopping): Keep the EUT in continuously transmitting mode (hopping) with 8DPSK modulation.</li> </ol> |

## 9.2. Test Setup

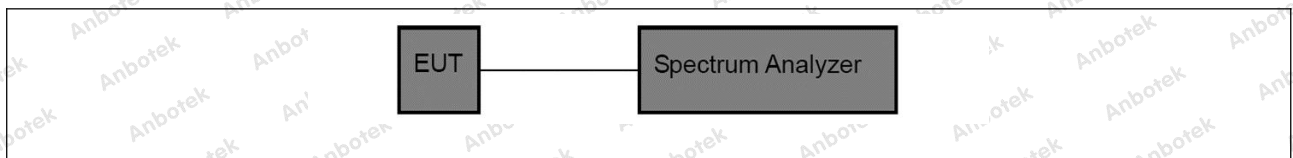

## 9.3. Test Data

|              |         |           |      |                       |         |
|--------------|---------|-----------|------|-----------------------|---------|
| Temperature: | 25.5 °C | Humidity: | 49 % | Atmospheric Pressure: | 101 kPa |
|--------------|---------|-----------|------|-----------------------|---------|

Please Refer to Appendix for Details.

### Shenzhen Anbotek Compliance Laboratory Limited

Address: 1/F., Building D, Sogood Science and Technology Park, Sanwei Community, Hangcheng Street, Bao'an District, Shenzhen, Guangdong, China.  
Tel: (86)0755-26066440 Fax: (86)0755-26014772 Email: service@anbotek.com



Hotline  
400-003-0500  
www.anbotek.com.cn



## 10. Band edge emissions (Radiated)

|                   |  |                                   |                               |
|-------------------|--|-----------------------------------|-------------------------------|
| Test Requirement: | Refer to 47 CFR 15.247(d), In addition, radiated emissions which fall in the restricted bands, as defined in § 15.205(a), must also comply with the radiated emission limits specified in § 15.209(a)(see § 15.205(c)).`   |                                   |                               |
| Test Limit:       | Frequency (MHz)  | Field strength (microvolts/meter) | Measurement distance (meters) |
|                   | 0.009-0.490  | 2400/F(kHz)                       | 300                           |
|                   | 0.490-1.705  | 24000/F(kHz)                      | 30                            |
|                   | 1.705-30.0   | 30                                | 30                            |
|                   | 30-88  | 100 **                            | 3                             |
|                   | 88-216   | 150 **                            | 3                             |
|                   | 216-960  | 200 **                            | 3                             |
|                   | Above 960  | 500                               | 3                             |
|                   | ** Except as provided in paragraph (g), fundamental emissions from intentional radiators operating under this section shall not be located in the frequency bands 54-72 MHz, 76-88 MHz, 174-216 MHz or 470-806 MHz. However, operation within these frequency bands is permitted under other sections of this part, e.g., §§ 15.231 and 15.241. In the emission table above, the tighter limit applies at the band edges. The emission limits shown in the above table are based on measurements employing a CISPR quasi-peak detector except for the frequency bands 9–90 kHz, 110–490 kHz and above 1000 MHz. Radiated emission limits in these three bands are based on measurements employing an average detector. |                                   |                               |
| Test Method:      | ANSI C63.10-2020 section 6.10<br>KDB 558074 D01 15.247 Meas Guidance v05r02  |                                   |                               |
| Procedure:        | ANSI C63.10-2020 section 6.10.5.2  |                                   |                               |

### 10.1. EUT Operation

|                        |   |
|------------------------|---|
| Operating Environment: |   |
| Test mode:             | <p>1: TX-GFSK (Non-Hopping): Keep the EUT in continuously transmitting mode (non-hopping) with GFSK modulation.</p> <p>2: TX-<math>\pi/4</math>-DQPSK (Non-Hopping): Keep the EUT in continuously transmitting mode (non-hopping) with <math>\pi/4</math> DQPSK modulation.</p> <p>3: TX-8DPSK (Non-Hopping): Keep the EUT in continuously transmitting mode (non-hopping) with 8DPSK modulation.</p> |



## 10.2. Test Setup

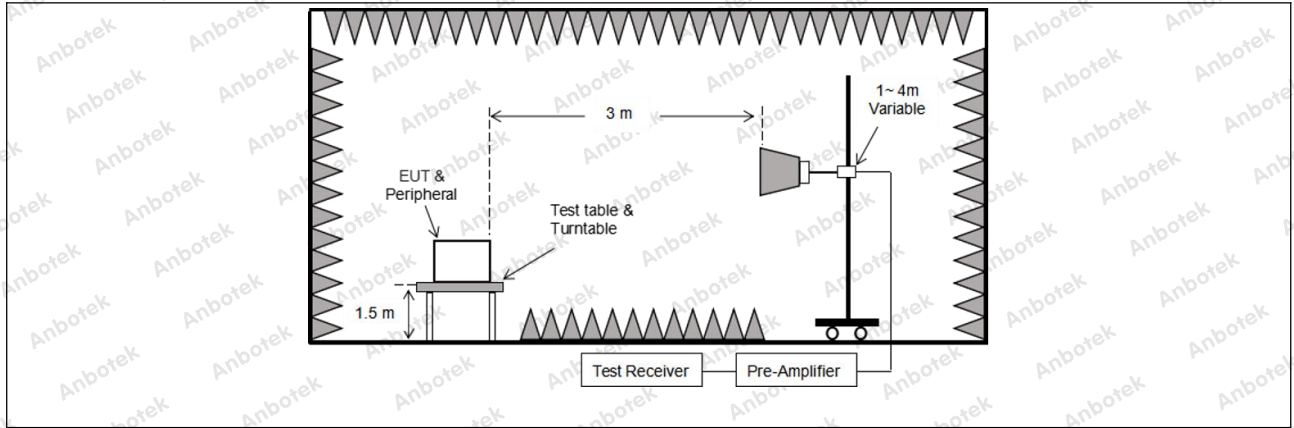

### Shenzhen Anbotek Compliance Laboratory Limited

Address: 1/F., Building D, Sogood Science and Technology Park, Sanwei Community, Hangcheng Street, Bao'an District, Shenzhen, Guangdong, China.  
Tel: (86)0755-26066440 Fax: (86)0755-26014772 Email: service@anbotek.com

Hotline  
400-003-0500  
www.anbotek.com.cn



### 10.3. Test Data

|              |         |           |      |                       |         |
|--------------|---------|-----------|------|-----------------------|---------|
| Temperature: | 25.5 °C | Humidity: | 49 % | Atmospheric Pressure: | 101 kPa |
|--------------|---------|-----------|------|-----------------------|---------|

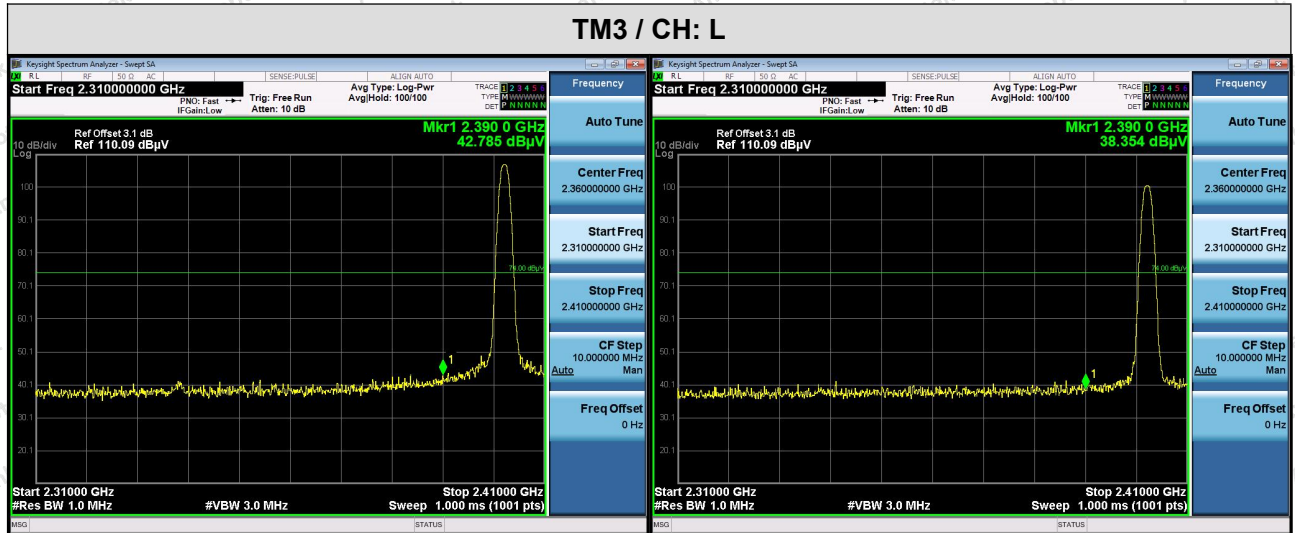

Peak Value(Vertical)

Peak Value(Horizontal)

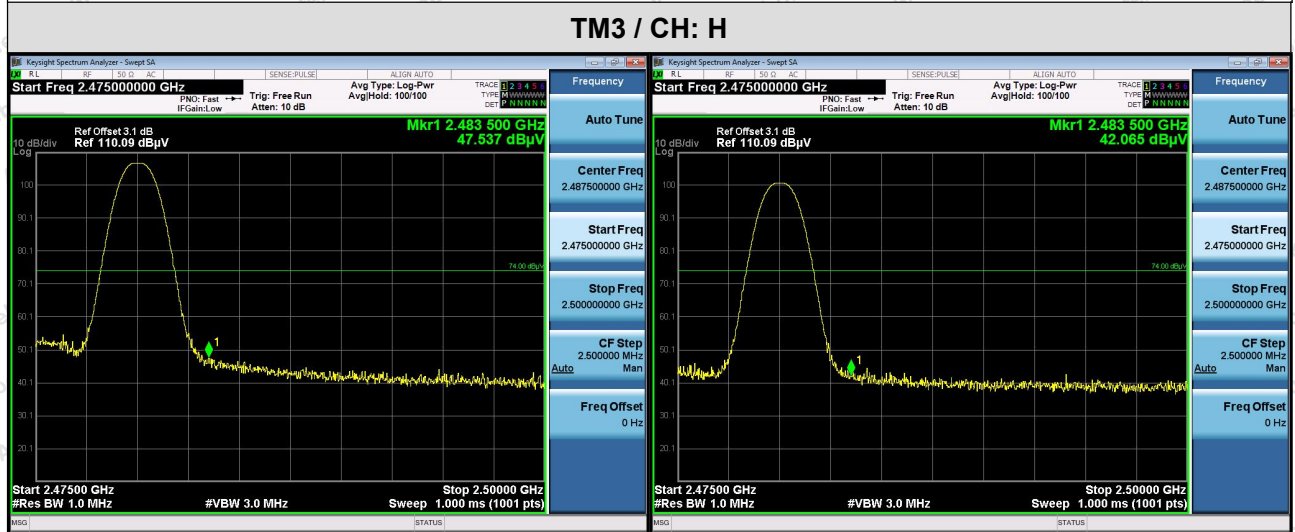

Peak Value(Vertical)

Peak Value(Horizontal)

Note:

1. When the PK measure result value is less than the AVG limit value, the AV measure result values test not applicable.
2. Only the worst case is recorded in the report.

#### Test for Duty Cycle.

Please refer to Appendix I of the Appendix Test Data.

#### Shenzhen Anbotek Compliance Laboratory Limited

Address: 1/F., Building D, Sogood Science and Technology Park, Sanwei Community, Hangcheng Street, Bao'an District, Shenzhen, Guangdong, China.  
Tel: (86)0755-26066440 Fax: (86)0755-26014772 Email: service@anbotek.com

Hotline  
400-003-0500  
www.anbotek.com.cn



## 11. Emissions in frequency bands (below 1GHz)

|                   |  |                                   |                               |
|-------------------|--|-----------------------------------|-------------------------------|
| Test Requirement: | Refer to 47 CFR 15.247(d), In addition, radiated emissions which fall in the restricted bands, as defined in § 15.205(a), must also comply with the radiated emission limits specified in § 15.209(a)(see § 15.205(c)).`   |                                   |                               |
| Test Limit:       | Frequency (MHz)  | Field strength (microvolts/meter) | Measurement distance (meters) |
|                   | 0.009-0.490  | 2400/F(kHz)                       | 300                           |
|                   | 0.490-1.705  | 24000/F(kHz)                      | 30                            |
|                   | 1.705-30.0   | 30                                | 30                            |
|                   | 30-88  | 100 **                            | 3                             |
|                   | 88-216   | 150 **                            | 3                             |
|                   | 216-960  | 200 **                            | 3                             |
|                   | Above 960  | 500                               | 3                             |
|                   | ** Except as provided in paragraph (g), fundamental emissions from intentional radiators operating under this section shall not be located in the frequency bands 54-72 MHz, 76-88 MHz, 174-216 MHz or 470-806 MHz. However, operation within these frequency bands is permitted under other sections of this part, e.g., §§ 15.231 and 15.241. In the emission table above, the tighter limit applies at the band edges. The emission limits shown in the above table are based on measurements employing a CISPR quasi-peak detector except for the frequency bands 9–90 kHz, 110–490 kHz and above 1000 MHz. Radiated emission limits in these three bands are based on measurements employing an average detector. |                                   |                               |
| Test Method:      | ANSI C63.10-2020 section 6.6.4<br>KDB 558074 D01 15.247 Meas Guidance v05r02   |                                   |                               |
| Procedure:        | ANSI C63.10-2020 section 6.6.4   |                                   |                               |

### 11.1. EUT Operation

|                        |   |
|------------------------|---|
| Operating Environment: |   |
| Test mode:             | <p>1: TX-GFSK (Non-Hopping): Keep the EUT in continuously transmitting mode (non-hopping) with GFSK modulation.</p> <p>2: TX-<math>\pi/4</math>-DQPSK (Non-Hopping): Keep the EUT in continuously transmitting mode (non-hopping) with <math>\pi/4</math> DQPSK modulation.</p> <p>3: TX-8DPSK (Non-Hopping): Keep the EUT in continuously transmitting mode (non-hopping) with 8DPSK modulation.</p> |





## 11.2. Test Setup

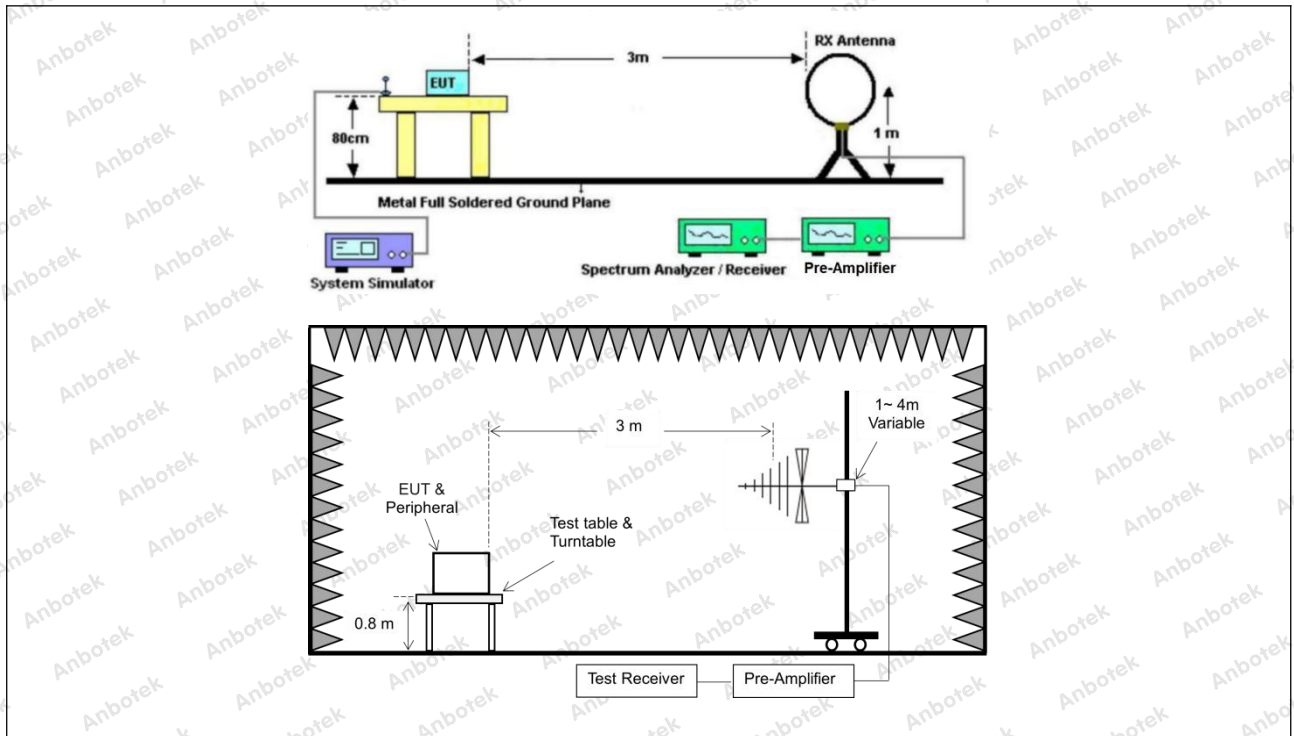

### 11.3. Test Data

The test results of 9kHz-30MHz was attenuated more than 20dB below the permissible limits, so the results don't record in the report.

|              |         |           |      |                       |         |
|--------------|---------|-----------|------|-----------------------|---------|
| Temperature: | 23.5 °C | Humidity: | 55 % | Atmospheric Pressure: | 101 kPa |
|--------------|---------|-----------|------|-----------------------|---------|

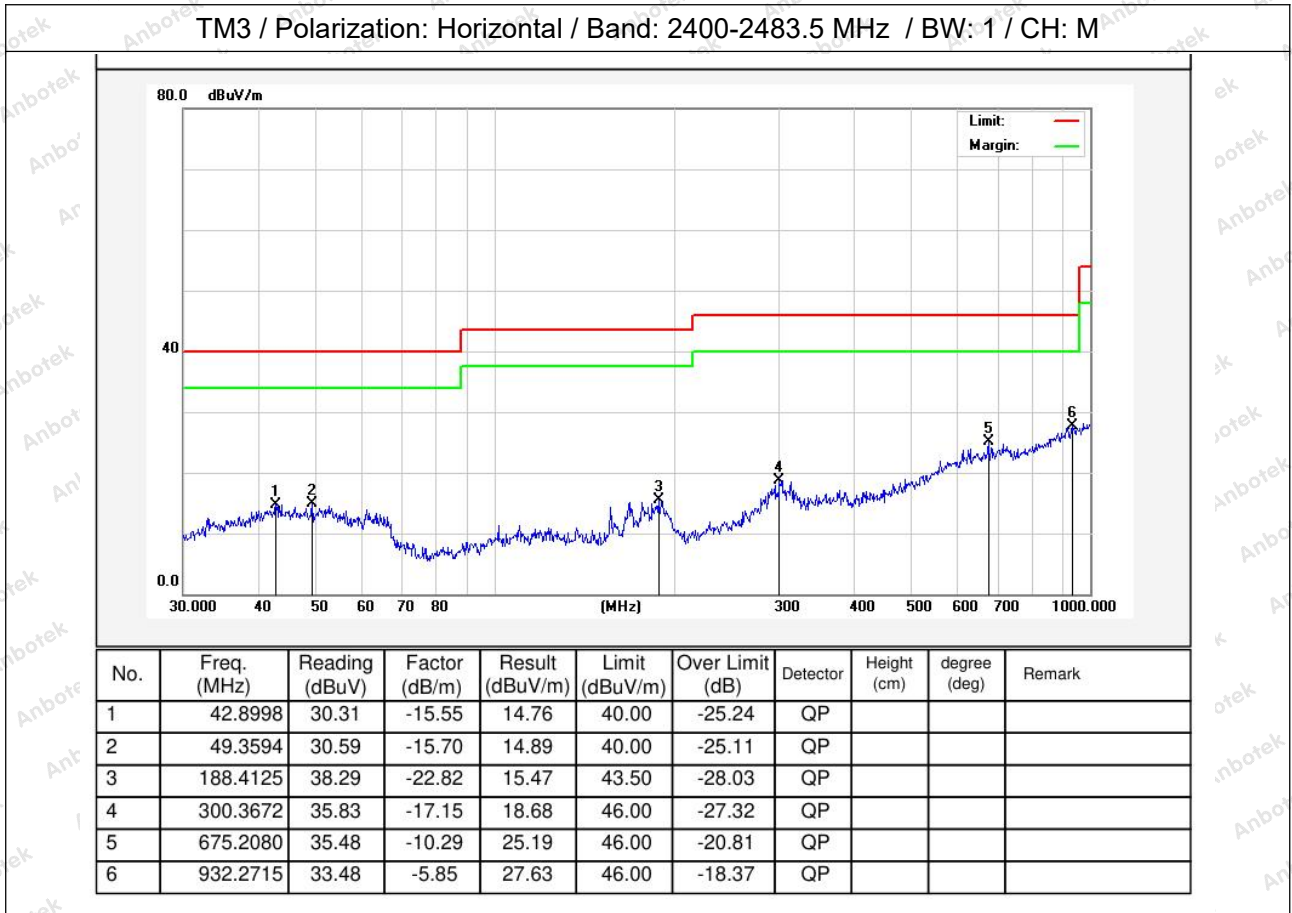

|              |         |           |      |                       |         |
|--------------|---------|-----------|------|-----------------------|---------|
| Temperature: | 23.5 °C | Humidity: | 55 % | Atmospheric Pressure: | 101 kPa |
|--------------|---------|-----------|------|-----------------------|---------|

TM3 / Polarization: Vertical / Band: 2400-2483.5 MHz / BW: 1 / CH: M

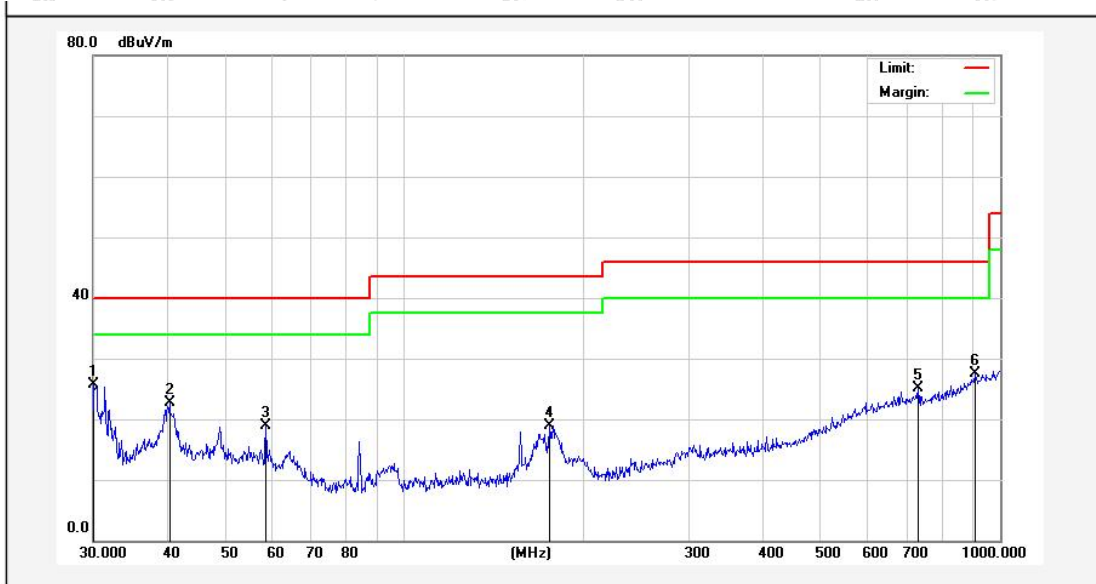

| No. | Freq. (MHz) | Reading (dBUV) | Factor (dB/m) | Result (dBUV/m) | Limit (dBUV/m) | Over Limit (dB) | Detector | Height (cm) | degree (deg) | Remark |
|-----|-------------|----------------|---------------|-----------------|----------------|-----------------|----------|-------------|--------------|--------|
| 1   | 30.1054     | 43.58          | -17.94        | 25.64           | 40.00          | -14.36          | QP       |             |              |        |
| 2   | 40.2757     | 37.32          | -14.59        | 22.73           | 40.00          | -17.27          | QP       |             |              |        |
| 3   | 58.4074     | 36.49          | -17.54        | 18.95           | 40.00          | -21.05          | QP       |             |              |        |
| 4   | 175.0368    | 39.83          | -20.86        | 18.97           | 43.50          | -24.53          | QP       |             |              |        |
| 5   | 729.3583    | 34.57          | -9.52         | 25.05           | 46.00          | -20.95          | QP       |             |              |        |
| 6   | 906.4824    | 33.56          | -6.14         | 27.42           | 46.00          | -18.58          | QP       |             |              |        |

Note: Only record the worst data in the report.



## 12. Emissions in frequency bands (above 1GHz)

|                   |  |                                   |                               |
|-------------------|--|-----------------------------------|-------------------------------|
| Test Requirement: | In addition, radiated emissions which fall in the restricted bands, as defined in § 15.205(a), must also comply with the radiated emission limits specified in § 15.209(a)(see § 15.205(c)).   |                                   |                               |
| Test Limit:       | Frequency (MHz)  | Field strength (microvolts/meter) | Measurement distance (meters) |
|                   | 0.009-0.490  | 2400/F(kHz)                       | 300                           |
|                   | 0.490-1.705  | 24000/F(kHz)                      | 30                            |
|                   | 1.705-30.0   | 30                                | 30                            |
|                   | 30-88  | 100 **                            | 3                             |
|                   | 88-216   | 150 **                            | 3                             |
|                   | 216-960  | 200 **                            | 3                             |
|                   | Above 960  | 500                               | 3                             |
|                   | <p>** Except as provided in paragraph (g), fundamental emissions from intentional radiators operating under this section shall not be located in the frequency bands 54-72 MHz, 76-88 MHz, 174-216 MHz or 470-806 MHz. However, operation within these frequency bands is permitted under other sections of this part, e.g., §§ 15.231 and 15.241.</p> <p>In the emission table above, the tighter limit applies at the band edges. The emission limits shown in the above table are based on measurements employing a CISPR quasi-peak detector except for the frequency bands 9–90 kHz, 110–490 kHz and above 1000 MHz. Radiated emission limits in these three bands are based on measurements employing an average detector.</p> |                                   |                               |
| Test Method:      | ANSI C63.10-2020 section 6.6.4<br>KDB 558074 D01 15.247 Meas Guidance v05r02   |                                   |                               |
| Procedure:        | ANSI C63.10-2020 section 6.6.4   |                                   |                               |

### 12.1. EUT Operation

|                        |   |
|------------------------|---|
| Operating Environment: |   |
| Test mode:             | <p>1: TX-GFSK (Non-Hopping): Keep the EUT in continuously transmitting mode (non-hopping) with GFSK modulation.</p> <p>2: TX-<math>\pi/4</math>-DQPSK (Non-Hopping): Keep the EUT in continuously transmitting mode (non-hopping) with <math>\pi/4</math> DQPSK modulation.</p> <p>3: TX-8DPSK (Non-Hopping): Keep the EUT in continuously transmitting mode (non-hopping) with 8DPSK modulation.</p> |



## 12.2. Test Setup

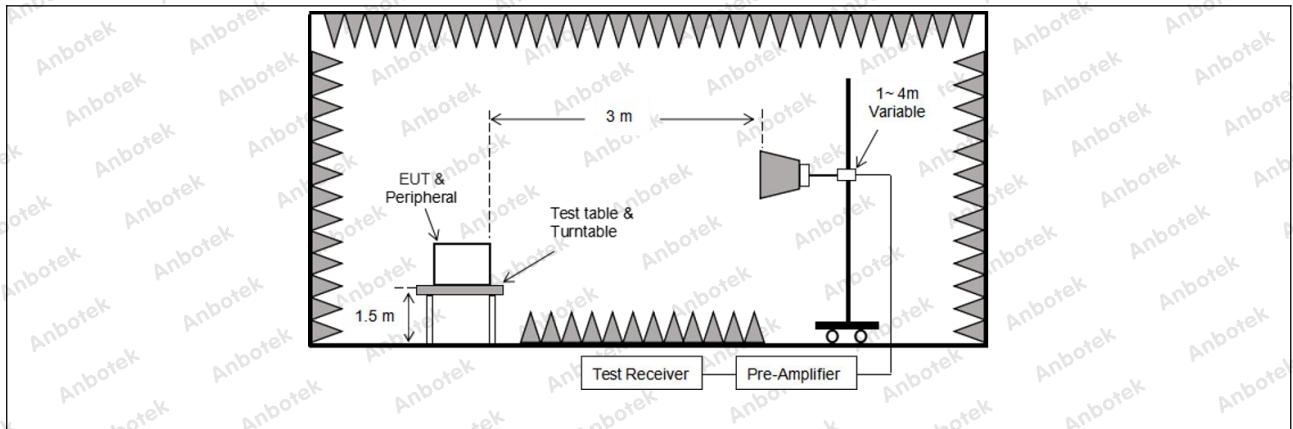

### Shenzhen Anbotek Compliance Laboratory Limited

Address: 1/F., Building D, Sogood Science and Technology Park, Sanwei Community, Hangcheng Street, Bao'an District, Shenzhen, Guangdong, China.  
Tel: (86)0755-26066440 Fax: (86)0755-26014772 Email: service@anbotek.com



Hotline  
400-003-0500  
www.anbotek.com.cn



### 12.3. Test Data

|              |         |           |      |                       |         |
|--------------|---------|-----------|------|-----------------------|---------|
| Temperature: | 23.5 °C | Humidity: | 55 % | Atmospheric Pressure: | 101 kPa |
|--------------|---------|-----------|------|-----------------------|---------|

| TM3 / CH: L     |                |               |                 |                |                 |              |
|-----------------|----------------|---------------|-----------------|----------------|-----------------|--------------|
| Peak value:     |                |               |                 |                |                 |              |
| Frequency (MHz) | Reading (dBuV) | Factor (dB/m) | Result (dBuV/m) | Limit (dBuV/m) | Over Limit (dB) | polarization |
| 4804.00         | 27.11          | 15.27         | 42.38           | 74.00          | -31.62          | Vertical     |
| 7206.00         | 28.29          | 18.09         | 46.38           | 74.00          | -27.62          | Vertical     |
| 9608.00         | 29.09          | 23.76         | 52.85           | 74.00          | -21.15          | Vertical     |
| 12010.00        | *              |               |                 | 74.00          |                 | Vertical     |
| 14412.00        | *              |               |                 | 74.00          |                 | Vertical     |
| 4804.00         | 27.50          | 15.27         | 42.77           | 74.00          | -31.23          | Horizontal   |
| 7206.00         | 28.44          | 18.09         | 46.53           | 74.00          | -27.47          | Horizontal   |
| 9608.00         | 28.21          | 23.76         | 51.97           | 74.00          | -22.03          | Horizontal   |
| 12010.00        | *              |               |                 | 74.00          |                 | Horizontal   |
| 14412.00        | *              |               |                 | 74.00          |                 | Horizontal   |
| Average value:  |                |               |                 |                |                 |              |
| Frequency (MHz) | Reading (dBuV) | Factor (dB/m) | Result (dBuV/m) | Limit (dBuV/m) | Over Limit (dB) | polarization |
| 4804.00         | 16.49          | 15.27         | 31.76           | 54.00          | -22.24          | Vertical     |
| 7206.00         | 17.32          | 18.09         | 35.41           | 54.00          | -18.59          | Vertical     |
| 9608.00         | 18.11          | 23.76         | 41.87           | 54.00          | -12.13          | Vertical     |
| 12010.00        | *              |               |                 | 54.00          |                 | Vertical     |
| 14412.00        | *              |               |                 | 54.00          |                 | Vertical     |
| 4804.00         | 15.85          | 15.27         | 31.12           | 54.00          | -22.88          | Horizontal   |
| 7206.00         | 17.50          | 18.09         | 35.59           | 54.00          | -18.41          | Horizontal   |
| 9608.00         | 17.52          | 23.76         | 41.28           | 54.00          | -12.72          | Horizontal   |
| 12010.00        | *              |               |                 | 54.00          |                 | Horizontal   |
| 14412.00        | *              |               |                 | 54.00          |                 | Horizontal   |

#### Shenzhen Anbotek Compliance Laboratory Limited

Address: 1/F., Building D, Sogood Science and Technology Park, Sanwei Community, Hangcheng Street, Bao'an District, Shenzhen, Guangdong, China.  
 Tel: (86)0755-26066440 Fax: (86)0755-26014772 Email: service@anbotek.com

Hotline  
 400-003-0500  
[www.anbotek.com.cn](http://www.anbotek.com.cn)



| TM3 / CH: M     |                |               |                 |                |                 |              |
|-----------------|----------------|---------------|-----------------|----------------|-----------------|--------------|
| Peak value:     |                |               |                 |                |                 |              |
| Frequency (MHz) | Reading (dBuV) | Factor (dB/m) | Result (dBuV/m) | Limit (dBuV/m) | Over Limit (dB) | polarization |
| 4882.00         | 27.13          | 15.42         | 42.55           | 74.00          | -31.45          | Vertical     |
| 7323.00         | 28.14          | 18.02         | 46.16           | 74.00          | -27.84          | Vertical     |
| 9764.00         | 28.10          | 23.80         | 51.90           | 74.00          | -22.10          | Vertical     |
| 12205.00        | *              |               |                 | 74.00          |                 | Vertical     |
| 14646.00        | *              |               |                 | 74.00          |                 | Vertical     |
| 4882.00         | 27.20          | 15.42         | 42.62           | 74.00          | -31.38          | Horizontal   |
| 7323.00         | 28.43          | 18.02         | 46.45           | 74.00          | -27.55          | Horizontal   |
| 9764.00         | 27.91          | 23.80         | 51.71           | 74.00          | -22.29          | Horizontal   |
| 12205.00        | *              |               |                 | 74.00          |                 | Horizontal   |
| 14646.00        | *              |               |                 | 74.00          |                 | Horizontal   |
| Average value:  |                |               |                 |                |                 |              |
| Frequency (MHz) | Reading (dBuV) | Factor (dB/m) | Result (dBuV/m) | Limit (dBuV/m) | Over Limit (dB) | polarization |
| 4882.00         | 16.22          | 15.42         | 31.64           | 54.00          | -22.36          | Vertical     |
| 7323.00         | 17.42          | 18.02         | 35.44           | 54.00          | -18.56          | Vertical     |
| 9764.00         | 17.97          | 23.80         | 41.77           | 54.00          | -12.23          | Vertical     |
| 12205.00        | *              |               |                 | 54.00          |                 | Vertical     |
| 14646.00        | *              |               |                 | 54.00          |                 | Vertical     |
| 4882.00         | 15.76          | 15.42         | 31.18           | 54.00          | -22.82          | Horizontal   |
| 7323.00         | 17.06          | 18.02         | 35.08           | 54.00          | -18.92          | Horizontal   |
| 9764.00         | 18.03          | 23.80         | 41.83           | 54.00          | -12.17          | Horizontal   |
| 12205.00        | *              |               |                 | 54.00          |                 | Horizontal   |
| 14646.00        | *              |               |                 | 54.00          |                 | Horizontal   |

**Shenzhen Anbotek Compliance Laboratory Limited**

Address: 1/F., Building D, Sogood Science and Technology Park, Sanwei Community, Hangcheng Street, Bao'an District, Shenzhen, Guangdong, China.  
 Tel: (86)0755-26066440 Fax: (86)0755-26014772 Email: service@anbotek.com

Hotline 400-003-0500  
 www.anbotek.com.cn



| TM3 / CH: H     |                |               |                 |                |                 |              |
|-----------------|----------------|---------------|-----------------|----------------|-----------------|--------------|
| Peak value:     |                |               |                 |                |                 |              |
| Frequency (MHz) | Reading (dBuV) | Factor (dB/m) | Result (dBuV/m) | Limit (dBuV/m) | Over Limit (dB) | polarization |
| 4960.00         | 27.40          | 15.58         | 42.98           | 74.00          | -31.02          | Vertical     |
| 7440.00         | 28.15          | 17.93         | 46.08           | 74.00          | -27.92          | Vertical     |
| 9920.00         | 28.65          | 23.83         | 52.48           | 74.00          | -21.52          | Vertical     |
| 12400.00        | *              |               |                 | 74.00          |                 | Vertical     |
| 14880.00        | *              |               |                 | 74.00          |                 | Vertical     |
| 4960.00         | 27.27          | 15.58         | 42.85           | 74.00          | -31.15          | Horizontal   |
| 7440.00         | 28.46          | 17.93         | 46.39           | 74.00          | -27.61          | Horizontal   |
| 9920.00         | 28.59          | 23.83         | 52.42           | 74.00          | -21.58          | Horizontal   |
| 12400.00        | *              |               |                 | 74.00          |                 | Horizontal   |
| 14880.00        | *              |               |                 | 74.00          |                 | Horizontal   |
| Average value:  |                |               |                 |                |                 |              |
| Frequency (MHz) | Reading (dBuV) | Factor (dB/m) | Result (dBuV/m) | Limit (dBuV/m) | Over Limit (dB) | polarization |
| 4960.00         | 17.34          | 15.58         | 32.92           | 54.00          | -21.08          | Vertical     |
| 7440.00         | 18.43          | 17.93         | 36.36           | 54.00          | -17.64          | Vertical     |
| 9920.00         | 18.52          | 23.83         | 42.35           | 54.00          | -11.65          | Vertical     |
| 12400.00        | *              |               |                 | 54.00          |                 | Vertical     |
| 14880.00        | *              |               |                 | 54.00          |                 | Vertical     |
| 4960.00         | 17.20          | 15.58         | 32.78           | 54.00          | -21.22          | Horizontal   |
| 7440.00         | 18.43          | 17.93         | 36.36           | 54.00          | -17.64          | Horizontal   |
| 9920.00         | 17.93          | 23.83         | 41.76           | 54.00          | -12.24          | Horizontal   |
| 12400.00        | *              |               |                 | 54.00          |                 | Horizontal   |
| 14880.00        | *              |               |                 | 54.00          |                 | Horizontal   |

Remark:

1. Result = Reading + Factor
2. “\*” means the test results were attenuated more than 20dB below the permissible limits, so the results don't record in the report.
3. Only the worst case is recorded in the report.

**Shenzhen Anbotek Compliance Laboratory Limited**

Address: 1/F., Building D, Sogood Science and Technology Park, Sanwei Community, Hangcheng Street, Bao'an District, Shenzhen, Guangdong, China.  
 Tel: (86)0755-26066440 Fax: (86)0755-26014772 Email: service@anbotek.com

Hotline 400-003-0500  
 www.anbotek.com.cn





**APPENDIX I -- TEST SETUP PHOTOGRAPH**

Please refer to separated files Appendix I -- Test Setup Photograph\_RF

**APPENDIX II -- EXTERNAL PHOTOGRAPH**

Please refer to separated files Appendix II -- External Photograph

**APPENDIX III -- INTERNAL PHOTOGRAPH**

Please refer to separated files Appendix III -- Internal Photograph

----- End of Report -----

**Shenzhen Anbotek Compliance Laboratory Limited**

Address: 1/F., Building D, Sogood Science and Technology Park, Sanwei Community,  
Hangcheng Street, Bao'an District, Shenzhen, Guangdong, China.  
Tel: (86)0755-26066440 Fax: (86)0755-26014772 Email: service@anbotek.com



Hotline  
400-003-0500  
www.anbotek.com.cn

