



C.H.I.P. Pro Datasheet

Version 1.0
2017-04-17

Revision History

Revision	Author	Date	Description
v0.1	JAT	Oct. 09, 2016	Initial Internal Release
v1.0	JAT	Oct. 11, 2016	Initial Public Release
V1.01	JAT	Dec. 20, 2016	Updated PCB Footprint and Pinout Map
V1.02	GRH	Mar. 06, 2017	Updated Pinout Map, Mech. Drawing, Photos, Removed erroneous application diagram
V1.03	GRH	Apr. 17, 2017	Add FCC/CE Compliance information and list of certified antennas, Add packaging information



Declaration

This page left intentionally blank. \(\bullet\bullet\bullet\)/

Table of Contents

1. OVERVIEW	6
1.1. APPLICATIONS.....	6
2. FEATURES.....	7
2.1. CPU.....	7
2.2. GPU	7
2.3. MEMORY	7
2.4. SYSTEM PERIPHERALS	7
2.5. VIDEO ENGINE	9
2.6. DISPLAY SUBSYSTEM.....	9
2.7. CAMERA INPUT	9
2.8. AUDIO SUBSYSTEM	9
2.9. EXTERNAL PERIPHERALS	10
2.10. POWER SYSTEM	11
2.11. WiFi & BLUETOOTH	11
3. ELECTRICAL CHARACTERISTICS.....	12
3.1. ABSOLUTE MAXIMUM RATINGS	12
3.2. RECOMMENDED OPERATING CONDITIONS	12
3.3. DC ELECTRICAL CHARACTERISTICS	13
3.4. POWER CONSUMPTION.....	13
3.5. OSCILLATOR ELECTRICAL CHARACTERISTICS	14
3.6. POWER UP/DOWN AND RESET SPECIFICATIONS	14
4. BLOCK DIAGRAM.....	15
5. PIN DEFINITIONS.....	16
5.1. PIN CHARACTERISTICS.....	16
5.2. PIN MULTIPLEXING FUNCTIONS.....	19
5.3. DETAILED PIN/SIGNAL DESCRIPTION	20
5.4. PINOUT DIAGRAM	16
6. MECHANICAL AND PACKAGING INFORMATION	22
6.1. MECHANICAL DRAWING.....	22
6.2. RECOMMENDED PCB FOOTPRINT	23
6.3. SMT REFLOW PROFILE	24
6.4. PACKAGING DIMENSIONS AND INFORMATION.....	25
7. SCHEMATIC.....	26



About This Documentation

From the desk of Gustavo Huber

When Dave, Thomas, and I started Next Thing Co. in 2013, it was with a simple goal: we wanted to create things that would inspire creativity, and help people chase their own ideas of what needed to exist.

We considered this goal both in terms of how economically accessible we could make our products (they had to be \$99 or less), as well as how much “pain” we could remove from the design process for others (they had to be open source and well-documented).

Our first attempt was a software-defined camera named OTTO, built around an off-the-shelf embedded module. But early in development, we knew that our end-goals were at risk. The \$39 module made it impossible to ship product priced under \$99. It lacked Mainline Linux support, a reliable tool-chain, documentation and functional drivers making software development a cat-and-mouse game of bug tracking. But thanks to lots of long days, and some good friends both in Shenzhen and back home in Oakland, we built and shipped out 500 OTTOs -- a serious feat.

Almost exactly a year later, we shipped out the first of what is now over 100,000 C.H.I.P.s delivered worldwide. At \$9, C.H.I.P. was the fruition of our vision from a year prior: accessible, powerful technology, available to everyone for hobby, education, or products. In so many words, we were building the tools that we wished we’d had before.

The reaction was (and continues to be) astounding! Tweets and emails come from far and wide to tell us about impossible projects banged together in an afternoon, classrooms full of proud 10-year-old game developers who had never before written a line of code, and seasoned engineers brought back to memories of discovering their passion on a Commodore 64, 40 years prior. Yet, just as building OTTO showed us the tools we were missing, building C.H.I.P has taught us what it takes to scale production to keep up with [even unprecedented] demand.

So it is with great pleasure that I invite you to explore, without non-disclosure agreements or any other obstructive formalities, this datasheet for C.H.I.P. Pro: the newest addition to the Next Thing Co. family.

Thanks to the experience and support from our friends at Allwinner and Nanya, C.H.I.P. Pro is built from the ground up for clean and reliable design. From in-package DDR3 DRAM in the GR8 SiP (which allows us to buy known-good-die DRAM rather than market components), to keeping the onboard NAND, Bluetooth, WiFi, and power management that made C.H.I.P. so useful, C.H.I.P. Pro takes care of all the nuts and bolts, letting you get to the fun parts faster.

With Next Thing Co. and the thriving Chipster community from bbs.nextthing.co at your side, we can’t wait to see what you’ll do with C.H.I.P. Pro!

/Gustavo
Co-founder, Hardware Guy



1. Overview

At Next Thing Co., we work to make it easy to integrate computer hardware in products. C.H.I.P. Pro is powered by GR8, a system-in-package (SiP) that was designed by Next Thing Co. GR8 features a 1GHz Allwinner R8 ARM Cortex-A8 processor, Mali400 GPU, and 256MB of Nanya DDR3 DRAM in a 256-ball 14mm x 14mm FBGA package.

C.H.I.P. Pro is a system-on-module (SoM) that has 512MB of high-speed NAND storage flashed with our GadgetOS. It can be simultaneously and seamlessly powered by any combination of USB, DC Input, or Li-ion battery, all intelligently managed by the AXP209 PMU.

The module offers all the popular interfaces you'd expect. With two High-Speed UARTs, a Two-Wire Serial Interface, a parallel camera sensor interface, SPI, two PWM channels, and a USB 2.0 port, C.H.I.P. Pro is packed full of I/O expandability. Comprehensive audio handling includes a built-in 24-bit ADC/DAC for analog audio, S/PDIF and AES3-compatible One-Wire Digital Audio, as well as I2S digital audio for interfacing with professional audio codecs.

C.H.I.P. Pro is CE, IC, and FCC 47 CFR 15.212 certified as a modular transmitter, making integration into end products easy. The on-board Realtek 8723DS 2.4GHz combination module provides compliant Wi-Fi B/G/N and Bluetooth 4.2 Low-Energy connectivity. A software controlled antenna path selects between the on-board chip antenna or a U.FL / IPEX antenna connector where several pre-certified antennas can be added to optimize wireless range.

The module is rated to operate from 2.9V-6V input in environments ranging between 0 and 70 degrees Celsius, and measures 45 mm x 30 mm.

C.H.I.P. Pro is \$16 in any quantity and includes custom factory flashing via Next Thing Co.'s Gadget software tools for orders of 1000 or more. Because we want everyone to have access to building great things at awesome prices, the minimum order quantity for C.H.I.P. Pro is one.

We can't wait to see how you'll integrate C.H.I.P Pro in to your next product, project, or prototype.

1.1. Applications

- Physical Computing
- Voice Recognition
- Smart "Clapper"
- Animated GIF Camera
- Smart Consumer Devices
- Portable Audio Devices
- Cyber Dog Robot Toys

2.1. CPU

- ARM Cortex™-A8
- ARMv7 Instruction set plus Thumb-2 Instruction Set
- 32KB Instruction Cache and 32KB Data Cache
- 256KB L2 Cache
- NEON™ SIMD Extensions
- Jazelle RCT Acceleration

2.2. GPU

- Mali400
- Supports Open GL ES 1.1/ 2.0 and Open VG 1.1

2.3. Memory

Boot ROM

- On-chip Boot ROM
- Supports NAND Flash, SPI NOR Flash, SD Card and USB OTG

NANYA DDR3 SDRAM

- In-package 256MB 16-bit DDR3 memory

NAND Flash

- 512MB SLC NAND

SD/MMC

- One SD/MMC Host Controllers (SMHC)
- Compatible with eMMC v4.4, SD Physical Layer Specification v2.0, SDIO Card Specification v2.0
- 1-/4-/8-bit bus width
- Supports block size of 1 to 65535 bytes
- Dedicated DMA for fast and uninterrupted data transfer

2.4. System Peripherals

CCM – Clock Control Module

- Seven PLLs driven by a main external Oscillator and an on-chip RC Oscillator
- Supports clock configuration and clock generated for corresponding modules
- Supports software-controlled clock gating and software-controlled reset for corresponding modules

DMA – Direct Memory Access

- Eight channels Normal DMA (NDMA) and eight channels Dedicated DMA (DDMA)
- Supports memory-to-memory, memory-to-peripheral, peripheral-to-memory data transfer types
- Transfer data width of 8/16/32-bits
- Programmable DMA burst size

PWM – Pulse Width Modulation

- Two output channels
- Supports continuous and pulse waveforms
- 0% to 100% adjustable duty cycle
- Up to 24 MHz output frequency

Asynchronous Timer

- Six Asynchronous Timers with interrupt-based operation
- A watchdog timer to generate reset signal or interrupt
- Two 33-bit Audio/Video Sync (AVS) counter to synchronize video and audio
- One 64-bit counter

Synchronous Timer

- Two Synchronous Timers with interrupt-based operation

Interrupt Controller

- Normal interrupt requests (nIRQ) and fast interrupt requests (FIQ)
- Supports 96 interrupt sources
- Four level priority controller
- External interrupt can be triggered according to edge or level-sensitivity

LRADC – Low Resolution Analog-to-Digital Converter

- Analog-to-Digital Converter with 6-bit resolution suitable for multi-button input
- Supports multiple button press detection
- Supports single, normal and continuous work mode
- Sampling frequency up to 250 Hz

Crypto Engine

- Supports AES, DES, 3DES, SHA-1, MD5
- Supports ECB, CBC modes for AES/DES/3DES
- 128-bit, 192-bit and 256-bit key size for AES
- 160-bit hardware Pseudo Random Number Generator (PRNG) with a 175-bit seed

2.5. Video Engine

Video Decoding

- Supports multi-format video decoding of VP6/8, AVS, H.264, H.263, and MPEG-1/2/4
- Up to 1080p@30fps resolution

Video Encoding

- Supports encoding in H.264 MP format
- Up to 720p@30fps resolution

2.6. Display Subsystem

Display Processing

- Four moveable and size-adjustable layers
- Multi-format image input
- Image enhancement processor
- Alpha blending /anti-flicker
- Hardware cursor
- Output color correction (luminance/hue/saturation)

2.7. Camera Input

- Supports 8-bit CMOS sensor parallel interface
- Supports BT656 interface
- Maximum still capture resolution on parallel interface up to 5M
- Maximum video capture resolution on parallel interface up to 1080p@30fps
- Pixel clock up to 150MHz

2.8. Audio Subsystem

Audio Codec – Audio Compression / Decompression Module

- On-chip 24-bit DAC for playback and ADC for recording
- Supports analog/digital volume control
- Supports 44.1 kHz, 48 kHz, 96 kHz, and 192 kHz sample rates
- Stereo microphone input
- Stereo headphone amplifier

I2S/PCM – Inter-IC Sound / Pulse Code Modulation

- Selectable I2S or PCM on shared pins
- Full-duplex synchronous serial interface
- Configurable as a master or a slave
- Audio data resolutions of 16, 20, 24
- I2S Audio data sample rate from 8 kHz to 192 kHz
- Left Justified or Right Justified I2S
- PCM supports 8-bit or 16-bit linear, 8-bit u-law, or 8-bit A-law companding sample format
- One 128x24-bits FIFO for data transmit and one 64x24-bits FIFO for data receive
- Programmable FIFO thresholds

OWA - One Wire Audio

- IEC-60958 (AES3 & S/PDIF-compatible) transmitter functionality
- Channel status insertion
- Hardware parity generation
- One 32×24bits FIFO (TX) for audio data transfer
- Programmable FIFO thresholds

2.9. External Peripherals

TWI - Two Wire Interface (I²C-Compatible)

- One TWI (Two-Wire Interface) controller
- Supports Standard mode (up to 100 kbit/s) and Fast mode (up to 400 kbit/s)
- Configurable as a master or a slave
- Capable of 10-bit addressing

UART - Universal Asynchronous Receiver/Transmitter

- Two UART controllers
 - UART0 with 2 wires
 - UART1 with 4 wires
- Compatible with industry-standard 16550 UARTs
- Support for word length from 5 to 8 bits, an optional parity bit, and 1, 1.5 or 2 stop bits
- Programmable parity (even, odd and no parity)
- All ports compatible with IrDA

SPI – Serial Peripheral Interface

- One SPI controller with one Chip Select signal
- Full-duplex synchronous serial interface
- Configurable as a master or a slave
- Configurable Polarity, phase and clock frequency

2.10. Power System

AXP209 Power Management Unit

- Intelligent Power Select (IPS) allows for three separate inputs: Vbus-USB (VBUS), Charge-In (CHG-IN), and Battery (BAT)
- Li-Po Battery Charging up to 1.8A with configurable current limiting, and Fuel Gauge Functionality
- Integrated ON/OFF button configurable logic, interrupt and startup/shutdown sequencing
- Integrated battery temperature sensor circuit, alternately usable as 12-bit ADC

2x LY8088 Switching Regulators

- 1.3A 2.3V-6V Input, 1.5MHz Synchronous Step-Down Converter

2.11. WiFi & Bluetooth

Realtek 8723DS Integrated WiFi + Bluetooth Module

- Operates at ISM frequency bands (2.4GHz)
- SDIO 2.0 for WiFi and H5 Specification-compliant HS-UART for Bluetooth data paths
- Enterprise-level security supports WPA/WPA2 for WiFi.
- Hardware supports:
 - IEEE 802.11b/g/n
 - IEEE 802.11e QoS Enhancement (WMM)
 - IEEE 802.11h Transmit Power Control and Dynamic Frequency Selection (TPC, DFS)
 - IEEE 802.11i Open, shared key, and pair-wise key authentication services (WPA, WPA2)
 - WiFi 1x1 TX/RX PHY data rates up to 150 Mbps downstream and 150 Mbps upstream
 - Enhanced BT/WiFi Coexistence Control to improve transmission quality in different profiles
 - Fast Automatic Gain Control (AGC) to improve receiving dynamic range
 - AFH to dynamically detect channel quality
 - Power Control/Enhanced Power Control
 - Frame Aggregation for increased MAC efficiency (A-MSDU, A-MPDU)
 - Low latency High-Throughput Block Acknowledgement (HT-BA)
 - Transmit Opportunity and Short Inter-Frame Space bursting for higher multimedia bandwidth (TXOP, SIFS)
- Fully Qualified for Bluetooth 2.1+EDR specification including both 2Mbps and 3Mbps modulation mode
- Fully Qualified for Bluetooth 3.0/4.0/4.2 Dual mode including simultaneous Low Energy and BR/EDR
- Full-speed Bluetooth operation with Piconet and Scatternet support
- Modularly pre-certified for use with several external antennas in addition to the included on-board SMT ceramic antenna

Table 2.11.1: FCC Part 15 Pre-Certified Antennas

Antenna Model	Manufacturer	Gain	Antenna Type	Connection Type	Frequency Range (GHz to GHz)	Cable Length (mm)
AA107	Unictron	3.3dBi	PCB	IPEX	2.4-2.5	100
HCX-P321	Wacosun	2dBi	PCB	IPEX	2.4-2.5	150
FXP73.07.0100A	Taoglas	2.5dBi	PCB	IPEX	2.4-2.483	100
AA055	Unictron	2.5dBi	Ceramic	SMT	2.4-2.5	n/a

Note: This radio transmitter (20863-1337R) has been approved by Industry Canada to operate with the antenna types listed below with the maximum permissible gain indicated. Antenna types not included in this list, having a gain greater than the maximum gain indicated for that type, are strictly prohibited for use with this device.

Cet émetteur radio (20863-1337R) a été approuvé par

Industrie Canada pour fonctionner avec les types d'antenne ci-dessous avec le gain maximal

admissible indiqué. Antenne Types non inclus dans cette liste, ayant un gain supérieur au gain maximal Indiqué pour ce type, sont strictement interdits pour être utilisés avec cet appareil.

3. Electrical Characteristics

3.1. Absolute Maximum Ratings

The absolute maximum ratings are those values beyond which damage to the device may occur. The table below specifies the absolute maximum ratings over the operating junction temperature range of commercial temperature devices. Functional operation of the device at these or any other conditions beyond those indicated in the operational sections of this standard may cause damage to the device.

Table 3.1.1: Absolute Maximum Ratings

Symbol	Parameter	Min	Max	Unit	
I _{I/O}	In/Out Current for Input and Output	-40	40	mA	
CHG-IN	Input Voltage for Charge-In	-0.3	11	V	
BAT	Input Voltage for Battery-in	-0.3	4.2	V	
V _{Bus}	Input Voltage for USB-V _{Bus}	-0.3	11	V	
T _{STG}	Storage Temperature	-30	125	°C	
T _A	Ambient Operating Temperature (1)	0	70	°C	
P _D	PMU Internal Power Dissipation	-	2100	mW	
V _{ESD}	Electrostatic Discharge	Human Body Model(HBM) (2)	-4000	4000	V
		Charged Device Model(CDM) (3)	-500	500	V
I _{Latch-up}	Latch-up I-test performance current-pulse injection on each IO pin (4)	Pass			
	Latch-up over-voltage performance voltage injection on each IO pin (5)	Pass			

(1) Limited by operating temperature minimum of WiFi+BT Module, other components tested to -20C.

(2) Test method: JEDEC JS-001-2014(Class-3A). JEDEC document JEP155 states that 500V HBM allows safe manufacturing with a standard ESD control process.

(3) Test method: JEDEC JS-002-2014(Class-C2A). JEDEC document JEP157 states that 250V CDM allows safe manufacturing with a standard ESD control process.

(4) Current test performance: Pins stressed per JEDEC JESD78D(Class I, Level A) and passed with I/O pin injection current as defined in JEDEC.

(5) Over voltage performance: Supplies stressed per JEDEC JESD78D(Class I, Level A) and passed voltage injection as defined in JEDEC.

3.2. Recommended Operating Conditions

All C.H.I.P Pro modules are intended for use under the operating conditions contained in the table below.

Table 3.2.1: Recommended Operating Conditions

Symbol	Parameter	Min	Typ	Max	Unit
CHG-IN	Input Voltage for Charge-In	3.8	5~5.5	6.3	V
BAT	Input Voltage for Battery-In	3.0	3.8	4.2±0.5%	V
V _{Bus}	Input Voltage for V _{Bus}	3.8	5~5.5	6.3	V
I _{OUT}	PMU V _{OUT} Current available before loading BAT (1)	500	900	2500	mA

(1) Programmable limit set in AXP209 PMU allows for safe attachment to USB 2.0, USB 3.0, or high-current CHG-IN sources.

3.3. DC Electrical Characteristics

Table 3.3.1: DC Electrical Characteristics

Symbol	Parameter	Min	Typ	Max	Unit
V _{IH}	High-Level Input Voltage	0.7 * VCC-IO	-	VCC-IO + 0.3	V
V _{IL}	Low-Level Input Voltage	-0.3	-	0.3 * VCC-IO	V
R _{PU}	Input Pull-up Resistance	50	100	150	KΩ
R _{PD}	Input Pull-down Resistance	50	100	150	KΩ
I _{IH}	High-Level Input Current	-	-	10	uA
I _{IL}	Low-Level Input Current	-	-	10	uA
V _{OH}	High-Level Output Voltage	VCC-IO -0.2	-	VCC-IO	V
V _{OL}	Low-Level Output Voltage	0	-	0.2	V
I _{oz}	Tri-State Output Leakage Current	-10	-	10	uA
C _{IN}	Input Capacitance	-	-	5	pF
C _{OUT}	Output Capacitance	-	-	5	pF

3.4. Power Consumption

C.H.I.P. Pro is designed for both battery and wall-powered embedded applications. The following measurements are offered as a rough starting point with which to begin to understand the range of power budgets relevant to a C.H.I.P. Pro-based device operated from a battery. Exact system power consumption is significantly influenced by factors such as software power optimizations (or lack thereof), power source quality, external peripheral circuitry, and ambient operating temperature.

Table 3.4.1: Sample Power Consumption Measurements from Gadget Buildroot

System State	Measurement	Value
Idle @ Linux Shell	Supply (BAT)	4.17 V
	Current	125.90 mA
	Power	525.00 mW
Playing Local Audio	Supply (BAT)	4.17 V
	Current	209.50 mA
	Power	873.62 mW
WiFi Pinging	Supply (BAT)	4.17 V
	Current	184.70 mA
	Power	770.20 mW
Standby	Supply (BAT)	4.17 V
	Current	5.30 mA
	Power	22.10 mW
Shutdown	Supply (BAT)	4.17 V
	Current	1.60 mA
	Power	6.67 mW

3.5. Oscillator Electrical Characteristics

C.H.I.P. Pro contains a single 24.000MHz oscillator.

The 24.000MHz frequency is used to generate the main source clock for PLL and the main digital blocks, the clock is provided through X24MIN. The table below lists the 24.000MHz crystal specifications.

Table 3.5.1: 24MHz Crystal Characteristics

Symbol	Parameter	Min	Typ	Max	Unit
$1/(t_{CPMAIN})$	Crystal Oscillator Frequency Range	-	24.000	-	MHz
t_{ST}	Startup Time	-	-	-	ms
	Frequency Tolerance at 25 °C	-50	-	+50	ppm
	Oscillation Mode	Fundamental			-
	Maximum Change Over Temperature Range	-50	-	+50	ppm
P_{ON}	Drive Level	-	-	300	uW
C_L	Equivalent Load Capacitance	12	18	22	pF
R_S	Series Resistance(ESR)	-	25	-	Ω
	Duty Cycle	30	50	70	%
C_M	Motional Capacitance	-	-	-	pF
C_{SHUT}	Shunt Capacitance	5	6.5	7.5	pF
R_{BIAS}	Internal Bias Resistor	0.4	0.5	0.6	M Ω

3.6. Power Up/Down and Reset Specifications

C.H.I.P. Pro only requires that you apply voltage within the acceptable range to any or all of the AXP209's Intelligent Power Select inputs. Power up and power down sequence requirements for the GR8 SiP are handled by the on-board Power System provided by the AXP209 PMU and companion switching regulators.

NOTE: Designs which omit a battery source often require additional bulk capacitance on their DC Input to best handle high current transients during boot or initial peripheral operation, such as WLAN pairing. While similar budgets to those shown in the Power Consumption section are applicable to DC Source (wall-powered) designs, they can achieve greater PMIC efficiencies by using a higher input voltages when compared to battery-only designs.

For more details in specific system submodule power up/down timing, requirements, and design considerations please review the GR8 SiP documentation and AXP209 datasheet available at:

https://github.com/NextThingCo/CHIP_Pro-Hardware

4. Block Diagram

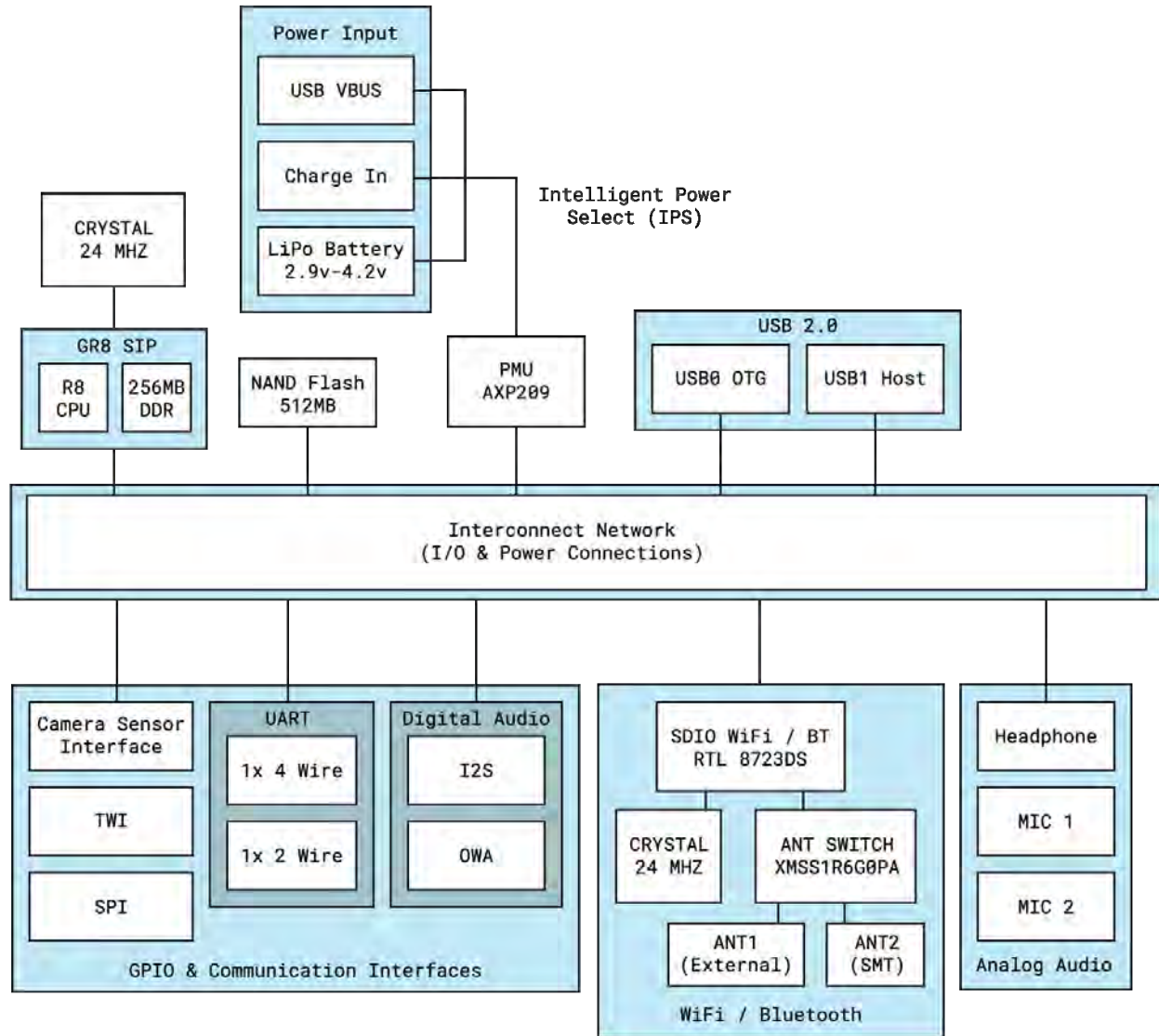

Figure 3.6-1: C.H.I.P. Pro System Block Diagram

5. Pin Definitions

5.1. Pinout Diagram

The following pin map demonstrates some of the common alternate pin mux configurations, overlaid on C.H.I.P. Pro.

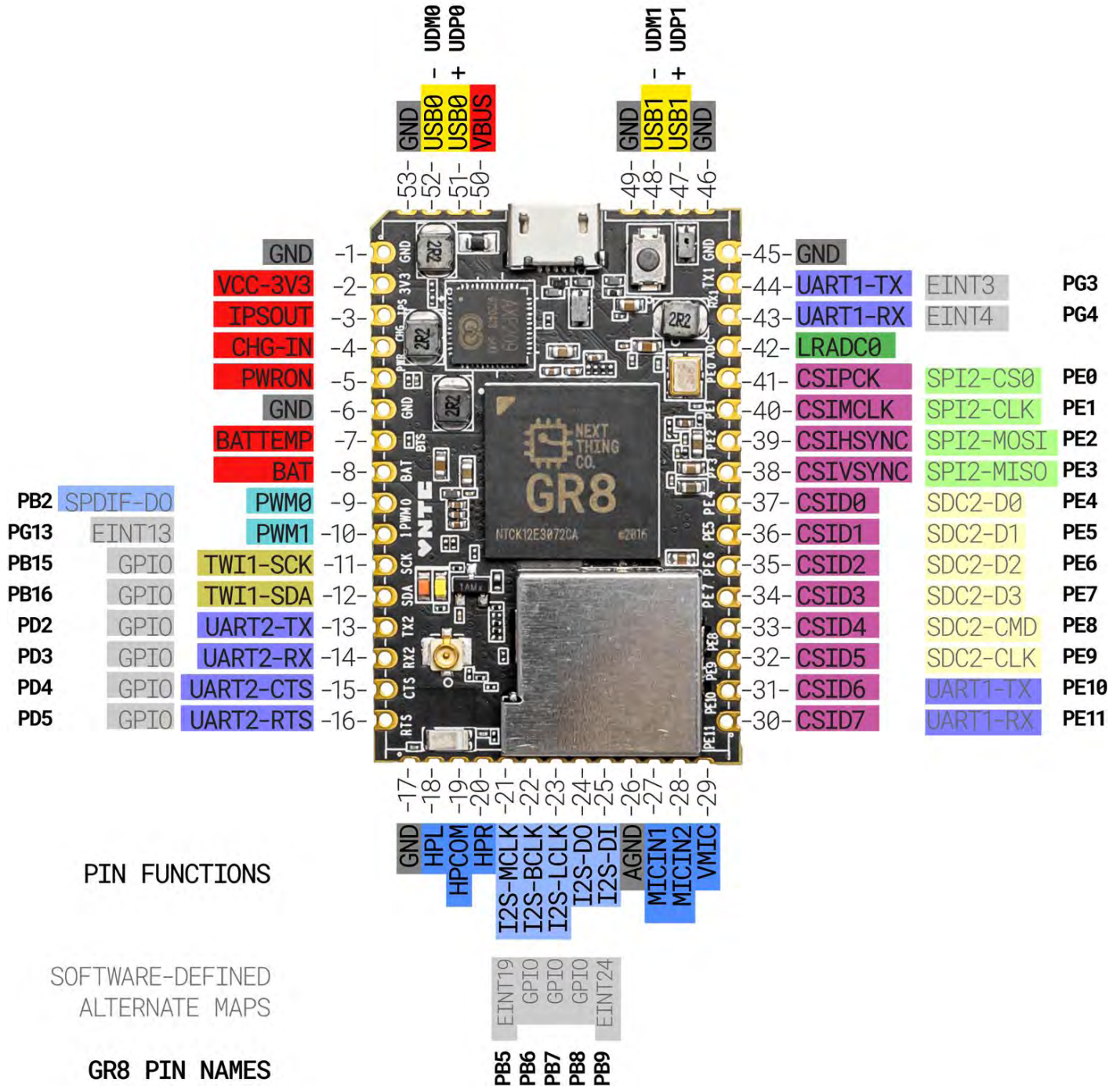

Figure 5.1-1: C.H.I.P. Pro Pinout

5.2. Pin Characteristics

The following table lists the characteristics of C.H.I.P Pro pins from the following aspects:

- 1) **Pin Number:** Through-holes + Castellated Edges, numbered in CCW order starting from clipped corner, with GR8 face up
- 2) **Pin Name:** Names of signals multiplexed on each pin No.
- 3) **Type:** Signal direction
 I : Input
 O: Output
 I/O: Input / Output
 A: Analog
 A I/O: Analog Input / Output
 OD: Open Drain
 P: Power
 G: Ground
- 4) **Pin Reset State:** The state of the terminal at reset (power up)
 Z: High-impedance
- 5) **Pull Up/Down:** Denotes the presence of an internal pull up or pull down resistor
 Pull up and pull down resistor can be enabled or disabled via software.
- 6) **Buffer Strength:** Drive strength of the associated output buffer.

Table 5.2.1. Pin Characteristics

Pin #	Pin Name	Default Function	Type	Reset State	Default Pull Up/Down	Buffer Strength (mA)
PORT B						
9	PB2	PWM	O	Z	NO PULL	20
21	PB5	GPIO	I/O	Z	NO PULL	20
22	PB6	GPIO	I/O	Z	NO PULL	20
23	PB7	GPIO	I/O	Z	NO PULL	20
24	PB8	GPIO	I/O	Z	NO PULL	20
25	PB9	GPIO	I/O	Z	NO PULL	20
12	PB15	GPIO	I/O	Z	NO PULL	20
11	PB16	GPIO	I/O	Z	NO PULL	20
PORT D						
13	PD2	GPIO	I/O	Z	NO PULL	20
14	PD3	GPIO	I/O	Z	NO PULL	20
15	PD4	GPIO	I/O	Z	NO PULL	20
16	PD5	GPIO	I/O	Z	NO PULL	20
PORT E						
41	PE0	GPIO	I/O	Z	NO PULL	20
40	PE1	GPIO	I/O	Z	NO PULL	20
39	PE2	GPIO	I/O	Z	NO PULL	20
38	PE3	GPIO	I/O	Z	NO PULL	20

Pin #	Pin Name	Default Function	Type	Reset State	Default Pull Up/Down	Buffer Strength (mA)
37	PE4	GPIO	I/O	Z	NO PULL	20
36	PE5	GPIO	I/O	Z	NO PULL	20
35	PE6	GPIO	I/O	Z	NO PULL	20
34	PE7	GPIO	I/O	Z	NO PULL	20
33	PE8	GPIO	I/O	Z	NO PULL	20
32	PE9	GPIO	I/O	Z	NO PULL	20
31	PE10	GPIO	I/O	Z	NO PULL	20
30	PE11	GPIO	I/O	Z	NO PULL	20
PORT G						
44	PG3	GPIO	I/O	Z	NO PULL	20
43	PG4	GPIO	I/O	Z	NO PULL	20
10	PG13	PWM	O	Z	NO PULL	20
USB						
52	USB0-DM	-	A I/O	-	-	-
51	USB0-DP	-	A I/O	-	-	-
48	USB1-DM	-	A I/O	-	-	-
47	USB1-DP	-	A I/O	-	-	-
50	VCC-USB	-	P	-	-	-
Audio Codec						
26	AGND	-	G	-	-	-
19	HPCOM	-	AO	-	-	-
18	HPL	-	AO	-	-	-
20	HPR	-	AO	-	-	-
27	MICIN1	-	AI	-	-	-
28	MICIN2	-	AI	-	-	-
29	VMIC	-	AO	-	-	-
LRADC						
42	LRADC0	-	AI	-	-	-
Power						
2	VDD-3V3	-	P	-	-	-
4	CHG-IN	-	P	-	-	-
8	BAT	-	P	-	-	-
GND						
1, 6, 17, 45, 46, 49, 53	GND	-	G	-	-	-

5.3. Pin Multiplexing Functions

The following table provides a description of the multiplexing functions available on each pin, organized by GR8 pin name.

Table 5.3.1: Multiplexing Functions

Port	Multi0	Multi1	Multi2	Multi3	Multi4	Multi5	Multi6
Port B							
PB2	Input	Output	PWM0	SPDIF-DO			EINT16
PB5	Input	Output	I2S-MCLK				EINT19
PB6	Input	Output	I2S-BCLK				EINT20
PB7	Input	Output	I2S-LRCK				EINT21
PB8	Input	Output	I2S-DO				EINT22
PB9	Input	Output	I2S-DI	SPDIF-DI			EINT23
PB15	Input	Output	TWI1-SCK				
PB16	Input	Output	TWI1-SDA				
Port D							
PD2	Input	Output	LCD-D2	UART2-TX			
PD3	Input	Output	LCD-D3	UART2-RX			
PD4	Input	Output	LCD-D4	UART2-CTS			
PD5	Input	Output	LCD-D5	UART2-RTS			
Port E							
PE0	Input			CSI-PCLK	SPI2-CS0		EINT14
PE1	Input			CSI-MCLK	SPI2-CLK		EINT15
PE2	Input			CSI-HSYNC	SPI2-MOSI		
PE3	Input	Output		CSI-VSYNC	SPI2-MISO		
PE4	Input	Output		CSI-D0	SDC2-D0		
PE5	Input	Output		CSI-D1	SDC2-D1		
PE6	Input	Output		CSI-D2	SDC2-D2		
PE7	Input	Output		CSI-D3	SDC2-D3		
PE8	Input	Output		CSI-D4	SDC2-CMD		
PE9	Input	Output		CSI-D5	SDC2-CLK		
PE10	Input	Output		CSI-D6	UART1-TX		
PE11	Input	Output		CSI-D7	UART1-RX		
Port G							
PG3	Input	Output	SDC1-CMD		UART1-TX		EINT3
PG4	Input	Output	SDC1-CLK		UART1-RX		EINT4
PG13	Input	Output		PWM1			EINT13

Note: PE0/PE1/PE2 are for input only in GPIO configuration.

5.4. Detailed Pin/Signal Description

The following table lists the detailed function of every C.H.I.P. Pro pin/signal based on interface, including their pin type:

Type: Signal direction

I : Input

O: Output

I/O: Input / Output

A: Analog

A I/O: Analog Input / Output

OD: Open Drain

P: Power

G: Ground

Table 5.4.1: Signal Descriptions

Pin/Signal Name	Description	Type
TWI – Two Wire Interface (I²C Compatible)		
TWI1-SCK	TWI1 Clock	I/O
TWI1-SDA	TWI1 Data/Address	I/O
PWM – Pulse Width Modulation		
PWM0	Pulse Width Module Channel0 Output	O
PWM1	Pulse Width Module Channel1 Output	O
I2S – Inter-IC Sound		
I2S-MCLK	I2S Master Clock	O
I2S-BCLK	I2S Bit Clock	I/O
I2S-LRCK	I2S Left/Right Channel Select Clock	I/O
I2S-DO	I2S Data Output	O
I2S-DI	I2S Data Input	I
OWA – One Wire Audio (S/PDIF / AES3 Compatible)		
SPDIF-DO	OWA Data Output	O
SPDIF-DI	OWA Data Input	I
SPI – Serial Peripheral Interface		
SPI2-CS0	SPI0 Chip Select Signal (active low)	I/O
SPI2-CLK	SPI0 Clock Signal	I/O
SPI2-MISO	SPI0 Master Data In, Slave Data Out	I/O
SPI2-MOSI	SPI0 Master Data Out, Slave Data In	I/O
UART – Universal Asynchronous Receiver/Transmitter		
UART1-TX	UART0 Data Transmit	O
UART1-RX	UART0 Data Receive	I
UART2-TX	UART1 Data Transmit	O
UART2-RX	UART1 Data Receive	I
UART2-CTS	UART1 Data Clear to Send	I
UART2-RTS	UART1 Data Request to Send	O

Pin/Signal Name	Description	Type
CSI – Camera Sensor Interface		
CSI-PCLK	CSI Pixel Clock	I
CSI-MCLK	CSI Master Clock	O
CSI-HSYNC	CSI Horizontal Sync	I
CSI-VSYNC	CSI Vertical Sync	I
CSI-Data[7:0]	CSI Data Bit [7:0]	I
SD/MMC		
SDC2-D[3:0]	SDC2 Data Bit [3:0]	I/O
SDC2-CLK	SDC2 Clock	O
SDC2-CMD	SDC2 Command Signal	I/O
External Interrupt		
EINT[3,4,13,19,24]	External Interrupt Input	I
USB		
USB0-DM	USB0 D- Signal	A I/O
USB0-DP	USB0 D+ Signal	A I/O
USB1-DM	USB1 D- Signal	A I/O
USB1-DP	USB1 D+ Signal	A I/O
VCC-USB	USB Power Supply	P
Audio Codec		
AGND	Audio Codec Analog Ground	G
HPCOM	Headphone Common Reference Output	AO
HPL	Headphone Left Channel Output	AO
HPR	Headphone Right Channel Output	AO
MICIN1	Microphone Input	AI
MICIN2	Microphone Input	AI
VMIC	Bias Voltage Output for Main Microphone	AO
LRADC – Low Resolution Analog-to-Digital Converter		
LRADC0	ADC Input for Channel 0 for Multi-Button Input	AI

6. Mechanical and Packaging Information

6.1. Mechanical Drawing

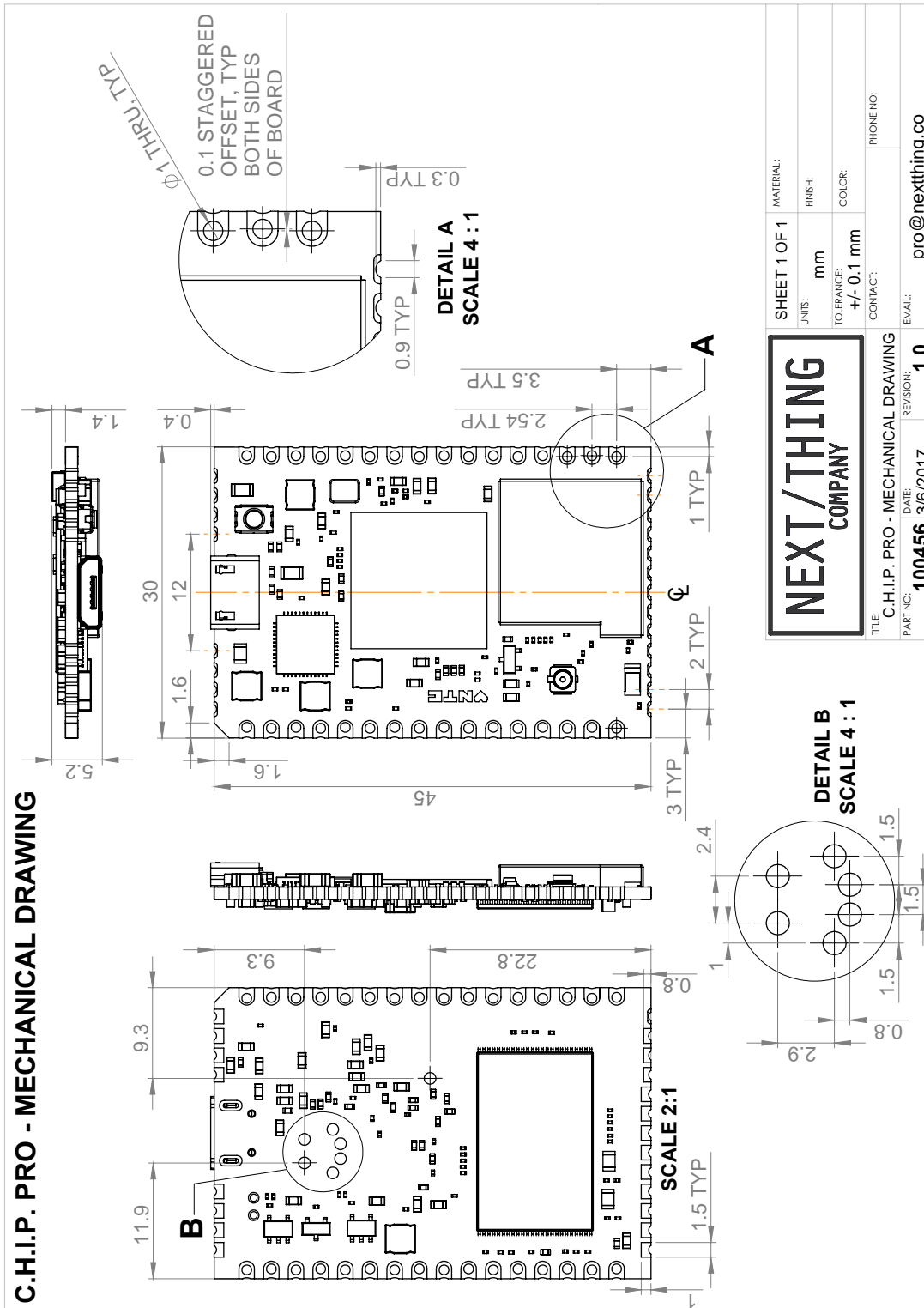

6.2. Recommended PCB Footprint

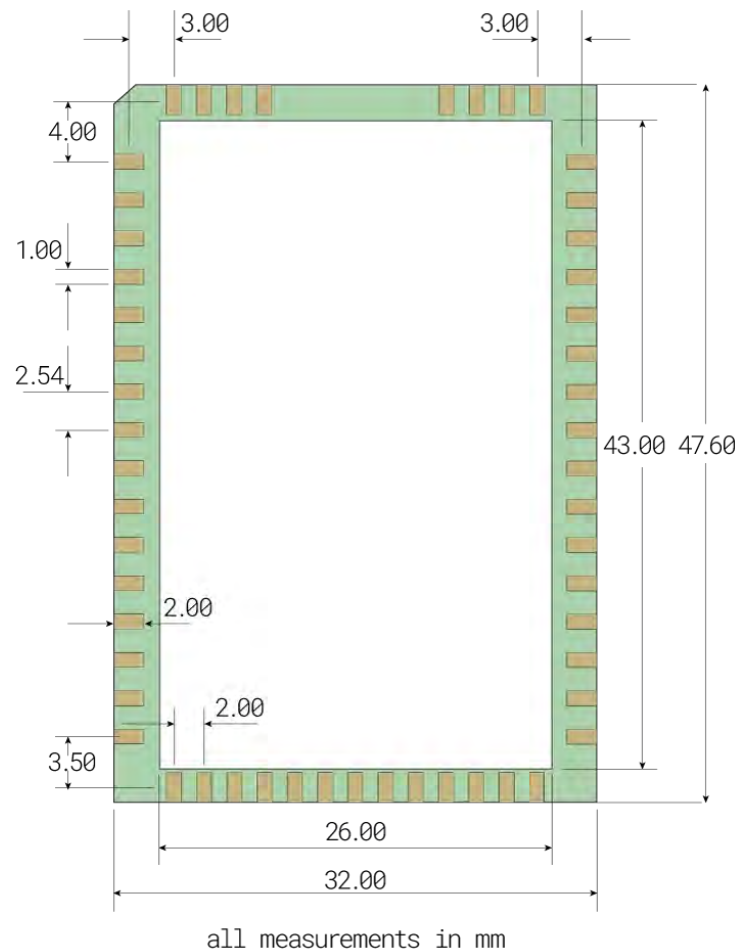

Figure 6.2-1: C.H.I.P. Pro Module Footprint

NOTE:

Part footprints for common EDA Software Packages are made available at:

https://github.com/NextThingCo/CHIP_Pro-Hardware

6.3. SMT Reflow Profile

NOTE:

C.H.I.P. Pro device designers should consult their manufacturer for an equipment-tailored reflow oven profile. The unique profile for each product is determined by the solder paste manufacturer’s recommendations as well as the maximum thermal load of the parts to be soldered on the printed circuit board.

Next Thing Co. recommends using ROHS and REACH compliant SAC305 solder paste, such as Alpha OM350 or Senju M705.

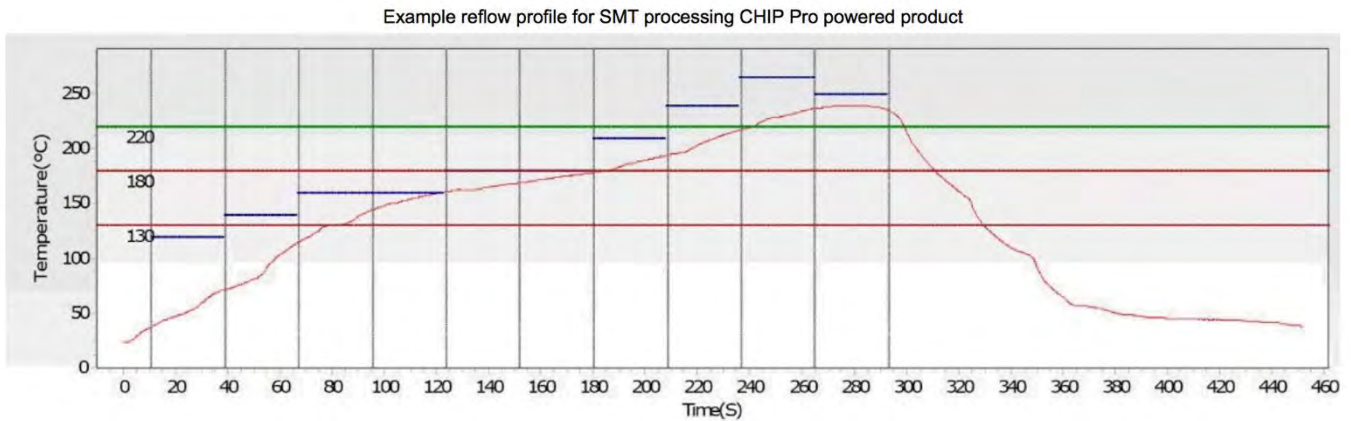

Oven Profile	Z1	Z2	Z3	Z4	Z5	Z6	Z7	Z8	Z9	Z10
Top Temp (C)	120	140	160	160	180	180	210	240	265	250
Bot. Temp (C)	120	140	160	160	180	180	210	240	265	250

Machine Type: ERSA
 Conveyor Speed: 85cm/min
 Solder Paste Type: Alpha OM350

Figure 6.3-1: Example Reflow Profile

6.4. Packaging Dimensions and Information

CHIP Pro Purchase Options v0.1 2017-04-17







<p>NTC-100523 CHIP Pro (1 pc)</p>  <p>Re-Sealable ESD Bag</p> <p>Dimensions: 86 x 56 x 6 mm Weight: 7g</p> <p>Package Contents:</p>  <p>CHIP Pro</p>	<p>NTC-100596 CHIP Pro "Tray" (20 pcs)</p>  <p>Cardboard Box</p> <p>Dimensions: 323 x 136 x 61 mm Weight: 110g</p> <p>Package Contents:</p>  <p>JEDEC Tray (empty lid) 20 x CHIP Pro JEDEC Tray</p> <p>Sealed in Heat-Shrink ESD Bag</p>	<p>NTC-100597 CHIP Pro "Carton" (100 pcs)</p>  <p>Cardboard Box</p> <p>Dimensions: 380 x 145 x 65 mm Weight: 1500g</p> <p>Package Contents:</p>  <p>JEDEC Tray (empty lid) 5x JEDEC Tray with 20x CHIP Pro/Tray</p> <p>Sealed in Heat-Shrink ESD Bag</p>	<p>NTC-100598 CHIP Pro "Case" (400 pcs)</p>  <p>Cardboard Box</p> <p>Dimensions: 400 x 300 x 160 mm Weight: 6600g</p> <p>Package Contents:</p>  <p>4x CHIP Pro Carton</p>
---	--	--	---

Figure 6.4-1: C.H.I.P. Pro Packaging Types & Dimensions

NOTE:

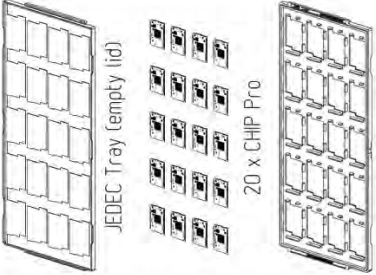
The most-current version of C.H.I.P. Pro' Schematics and other technical documents are made available at:
https://github.com/NextThingCo/CHIP_Pro-Hardware

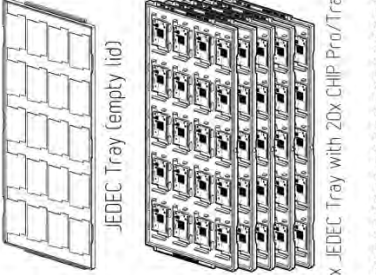
REVISION HISTORY

Schematics Index:

- P01: REVISION HISTORY
- P02: BLOCK
- P03: CPU
- P04: POWER
- P05: MISC
- P06: SDIO WIFI
- P07: USB
- P08: BESIDE CPU
- P09: NAND

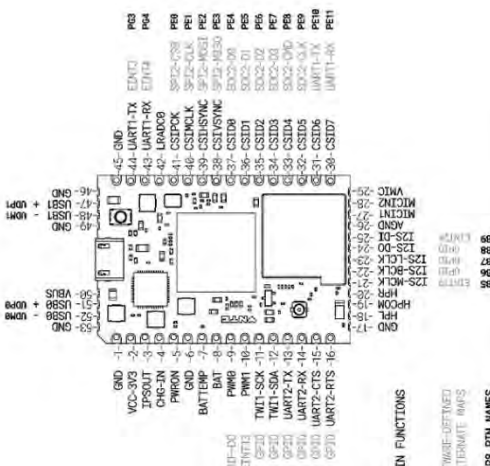

REVISION HISTORY

Rev	Page Number	REVISION HISTORY	Date
1	1	Rev v1.0	1 of 3
2	1	Rev v1.0	1 of 3
3	1	Rev v1.0	1 of 3

Changelist

Revision History	Description	Date	Drawn	Checked
CHIP Pro	version 0.1	2016-08-05		
CHIP Pro	version 0.9	2016-11-11		
CHIP Pro	version 0.9a	2017-03-01		fix sheet 1 pinout dwg
CHIP Pro	version 1.0	2017-03-31		FCC/CE/IC Certification

NEXT/THING COMPANY
 Oakland, California
docs.nextthing.co
 C.H.I.P. Pro
 REVISION HISTORY
 Date: March 31, 2017

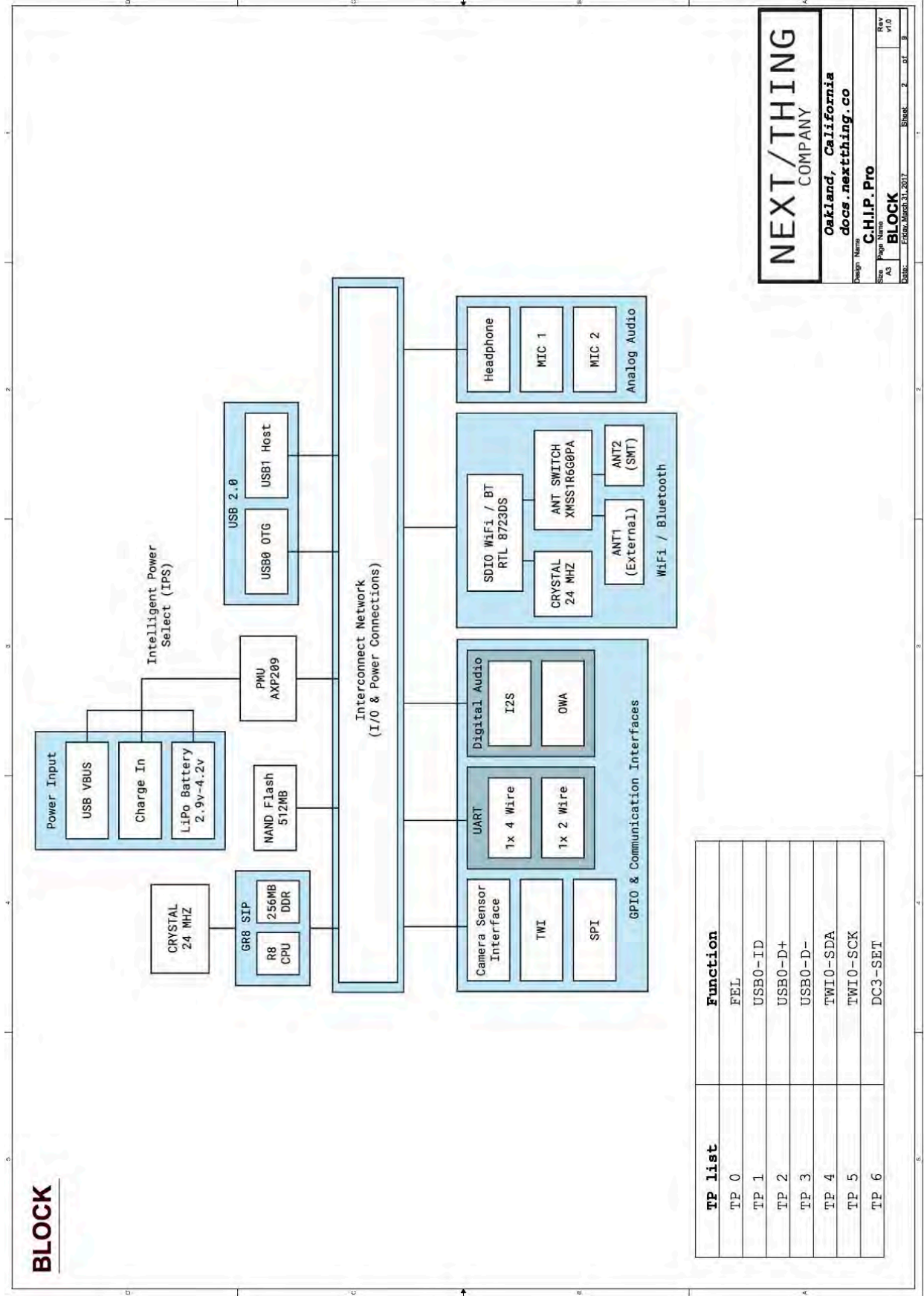

BLOCK

TP list	Function
TP 0	FEL
TP 1	USB0-ID
TP 2	USB0-D+
TP 3	USB0-D-
TP 4	TWI0-SDA
TP 5	TWI0-SCK
TP 6	DC3-SET

NEXT/THING
COMPANY

Oakland, California
docs.nextthing.co

Design Name: C.H.I.P. Pro
Page Name: BLOCK
Rev: v1.0
Date: Fri, Mar 31, 2017
Sheet: 2 of 8

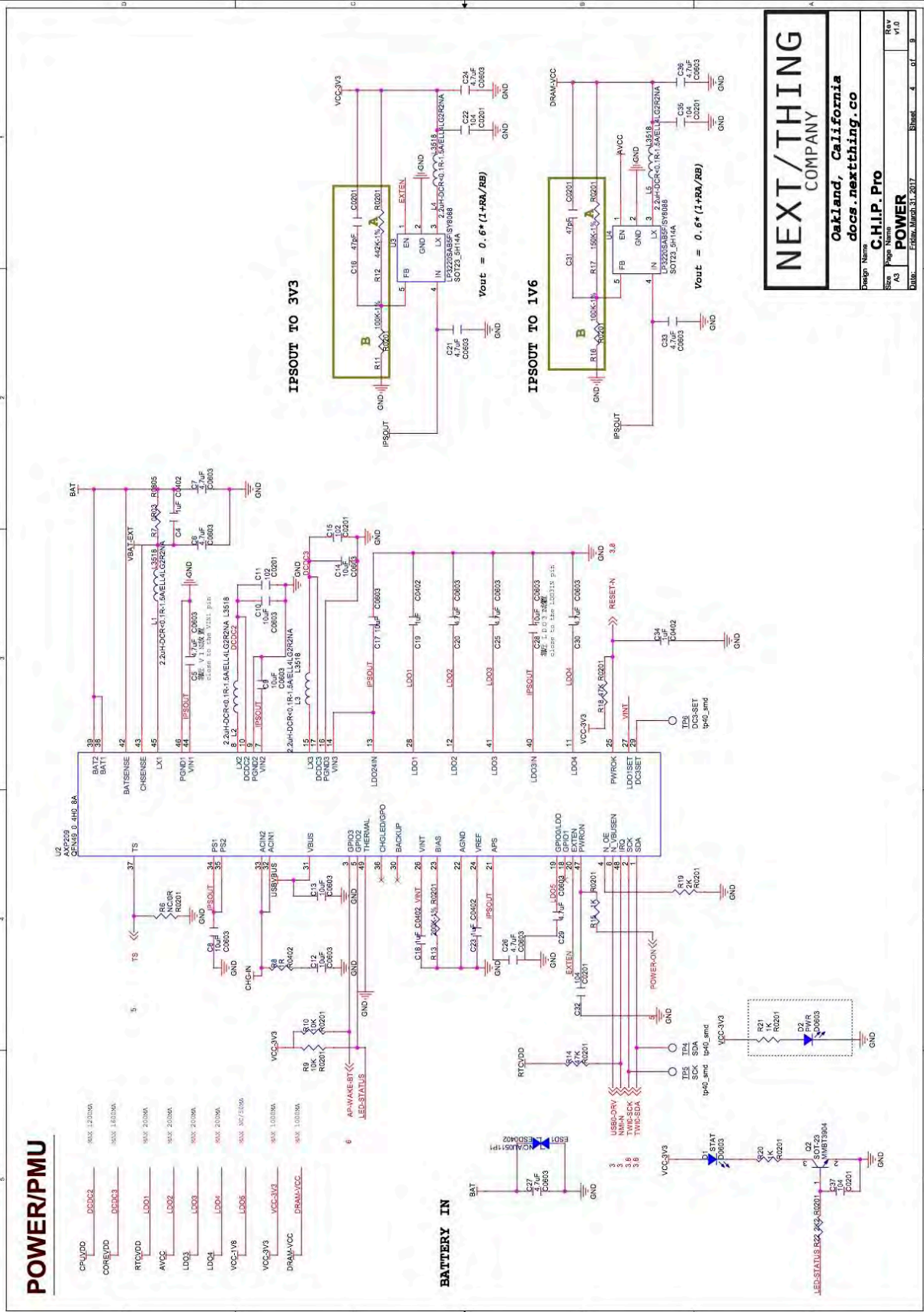

NEXT/THING COMPANY
 Oakland, California
 docs.nextthing.co

Design Name: **C.H.I.P. Pro**
 Power

Rev: 1.0
 Sheet: 4 of 8

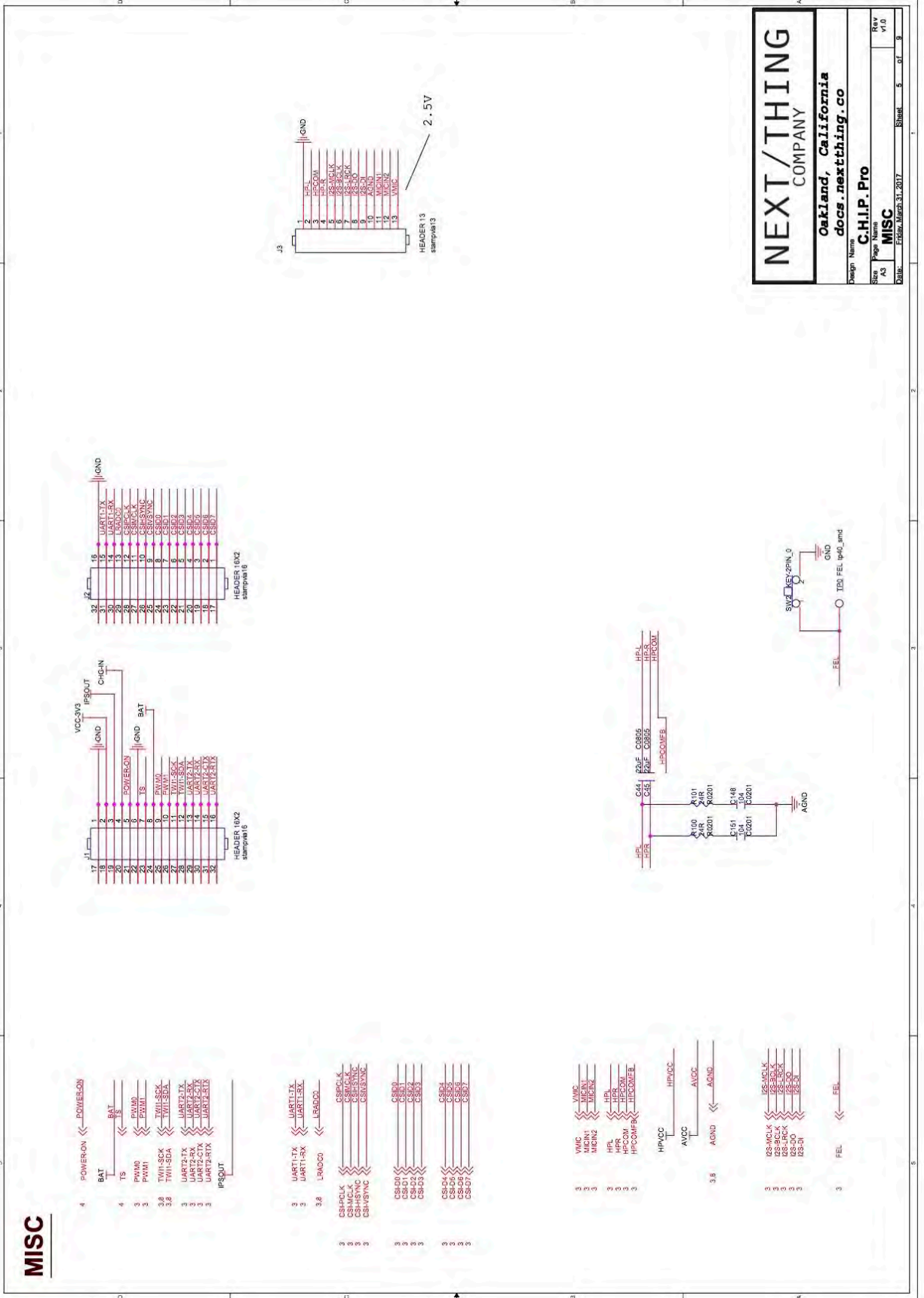

NEXT/THING COMPANY
Oakland, California
docs.nextthing.co

Design Name: **C.H.I.P. Pro**

Sheet: 5 of 9

Rev: v1.0

Page: 10

Date: Fri, Mar 31, 2017

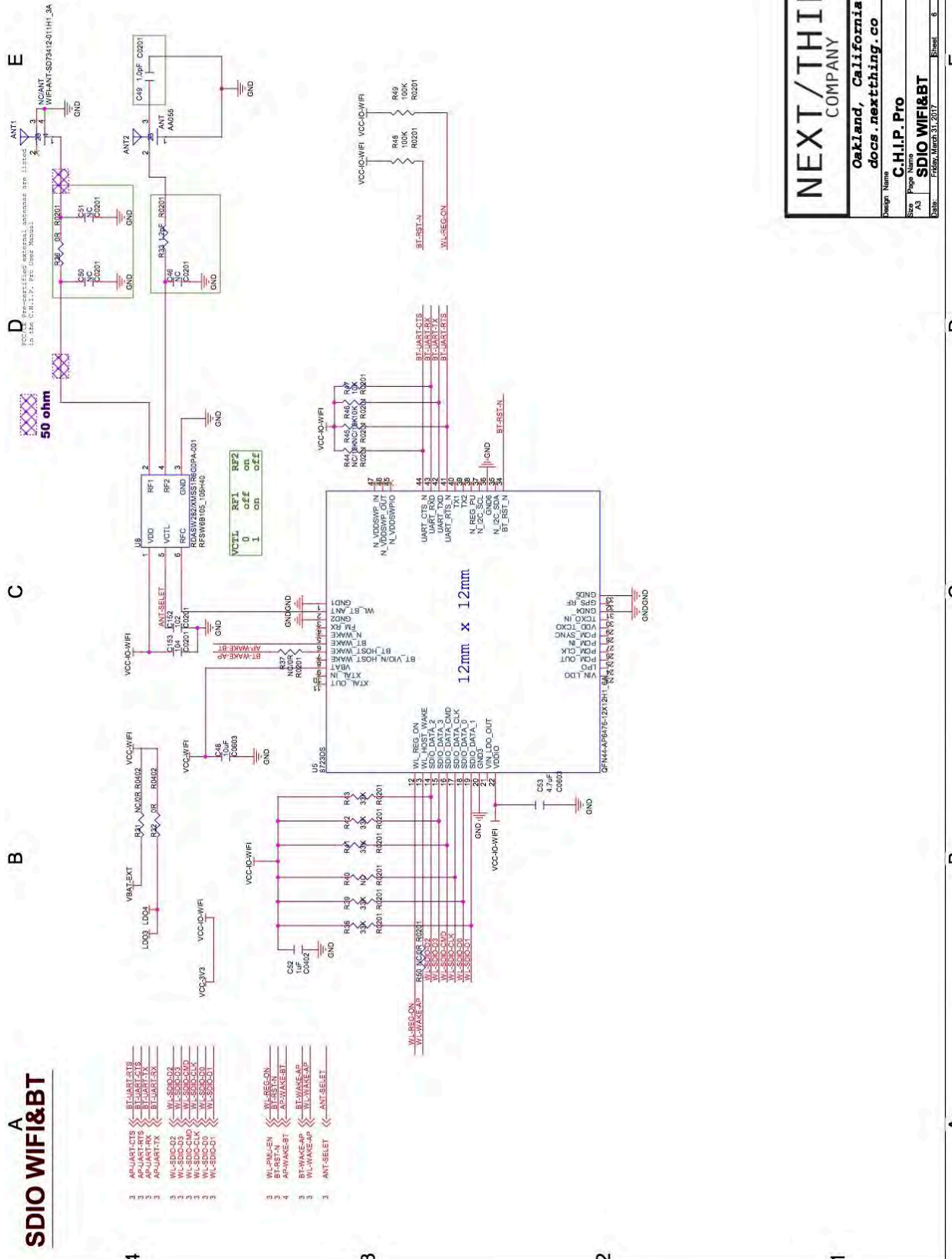

NEXT/THING COMPANY
Oakland, California
docs.nextthing.co

Design Name: C.H.I.P. Pro
Size: A3
Date: Feb/March 2017

Rev: V1.0
Page: 6 of 8
Sheet: 6 of 8

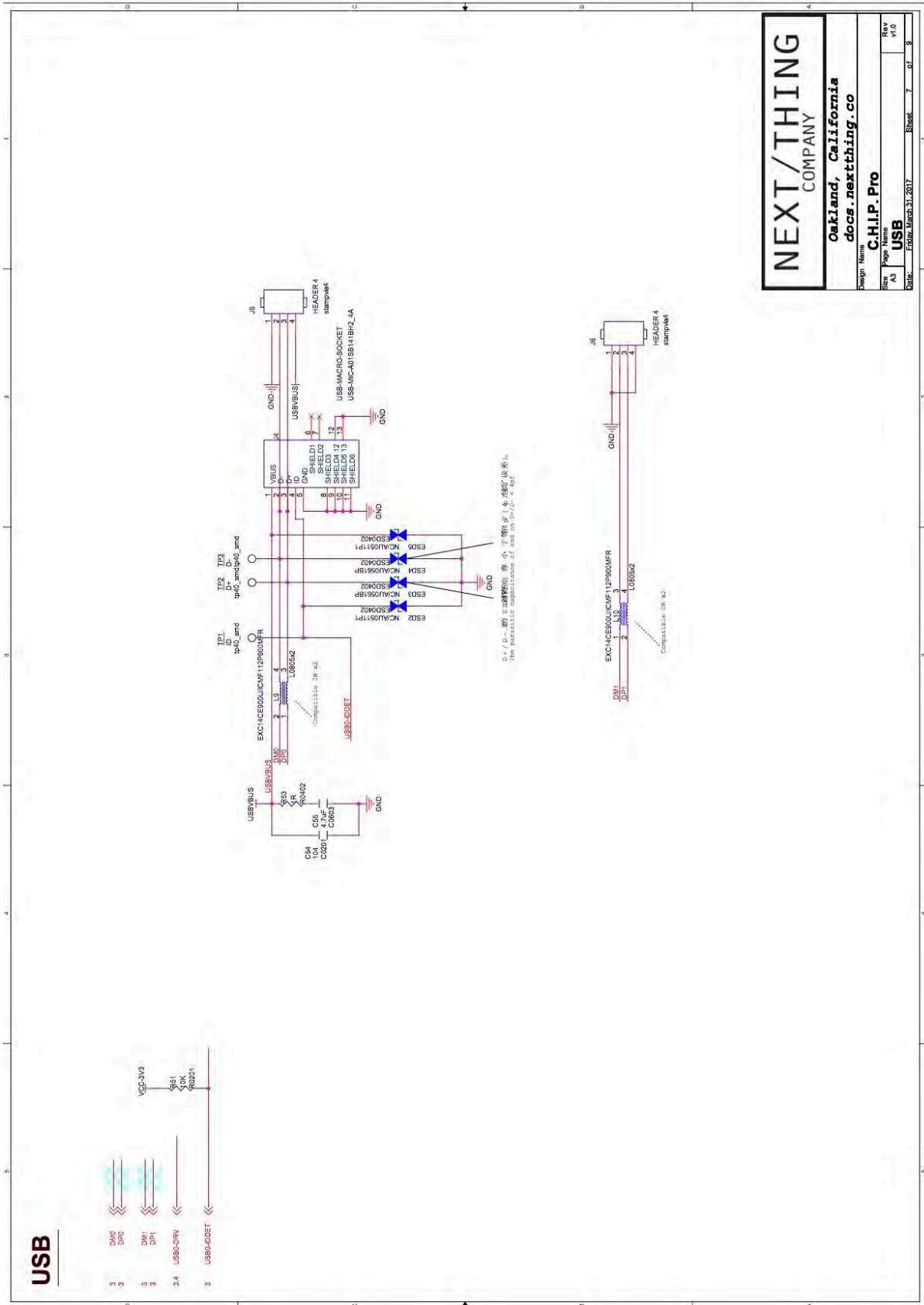

NEXT/THING
COMPANY

Oakland, California
docs.nextthing.co

Design Name: **C.H.I.P. Pro**
USB

Rev	Page	Date
v1.0	7	March 31, 2017

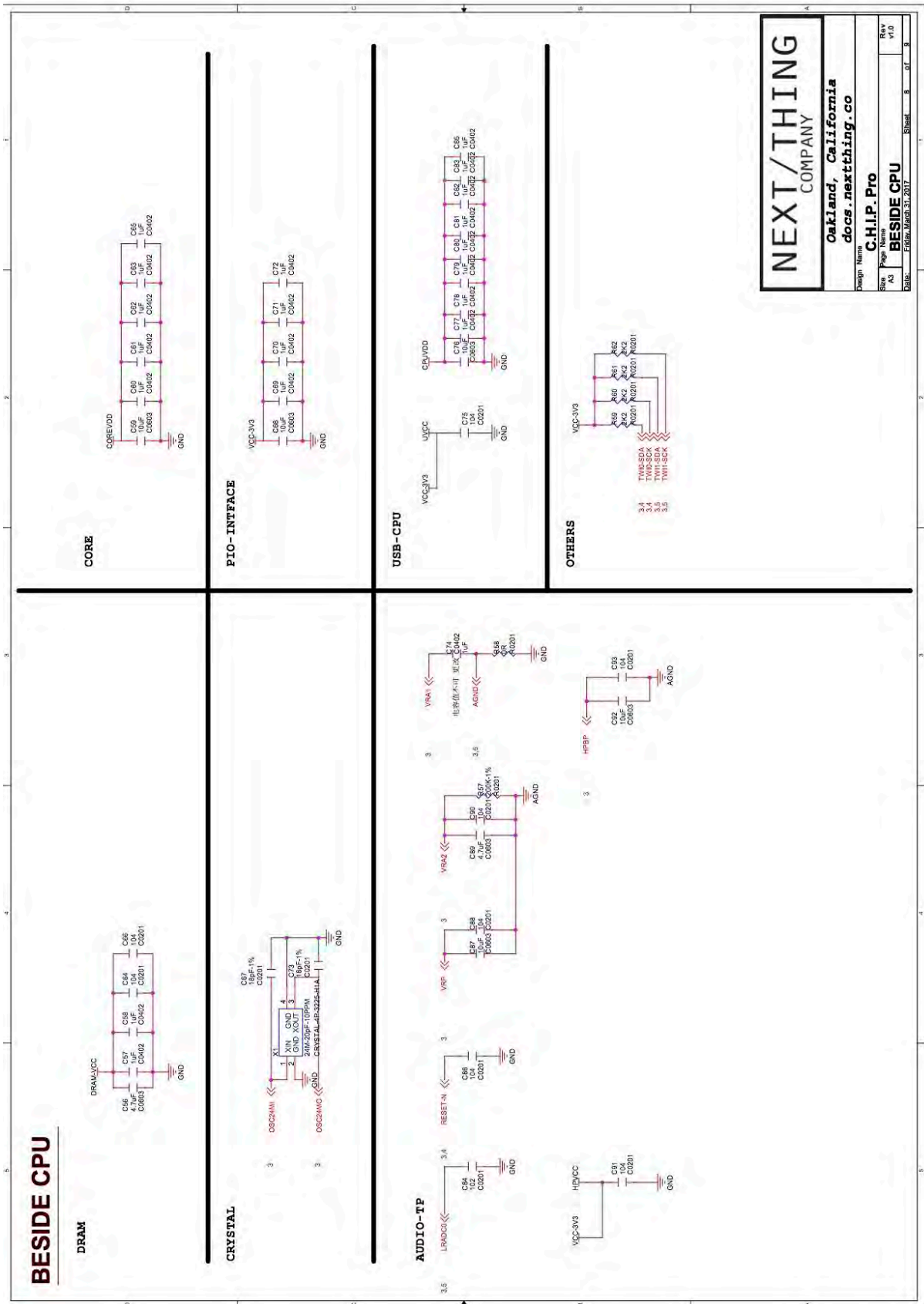

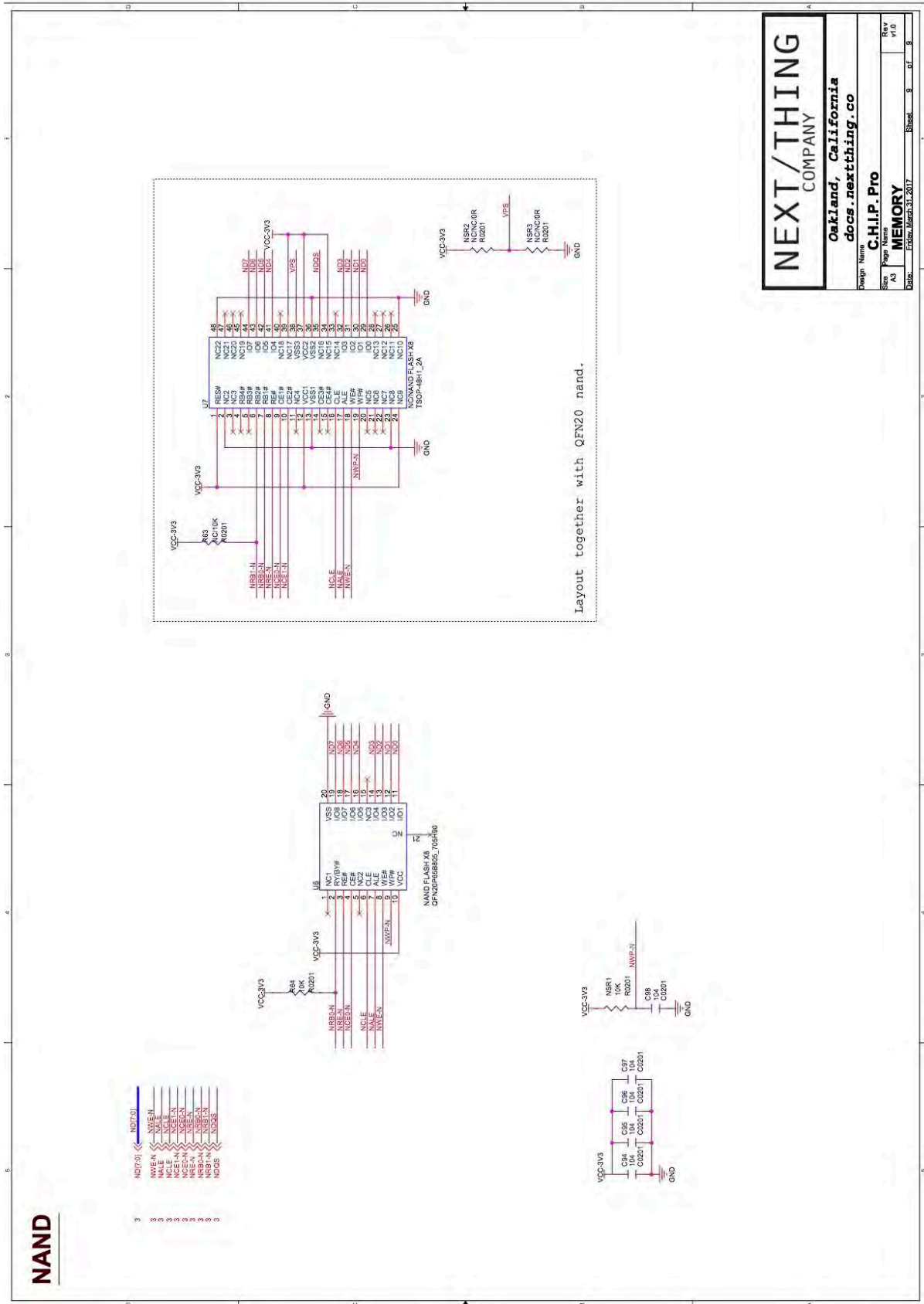

NEXT/THING
COMPANY

Oakland, California
docs.nextthing.co

Design Name: C.H.I.P. Pro
Rev: v1.0
Size: MEMORY
Date: Fri, 31 Mar 2017

Sheet: 3 of 9



Copyright © Next Thing Co. All Rights Reserved.

Join the discussion @ <http://bbs.nextthing.co/c/CHIP-Pro>

Contact Us

Sales:

Sales@NextThing.co

Technical Questions:

Hardware@NextThing.co

www.getchip.com

FCC/IC Statements

(OEM) Integrator has to assure compliance of the entire end-product incl. the integrated RF Module. For 15 B (§15.107 and if applicable §15.109) compliance, the host manufacturer is required to show compliance with 15 while the module is installed and operating.

Furthermore the module should be transmitting and the evaluation should confirm that the module's intentional emissions (15C) are compliant (fundamental / out-of-band). Finally the integrator has to apply the appropriate equipment authorization (e.g. Verification) for the new host device per definition in §15.101.

Integrator is reminded to assure that these installation instructions will not be made available to the end-user of the final host device.

The final host device, into which this RF Module is integrated" has to be labelled with an auxiliary label stating the FCC ID of the RF Module, such as
"Contains FCC ID: 2AF9F-1337R"

"This device complies with part 15 of the FCC rules. Operation is subject to the following two conditions:

- (1) this device may not cause harmful interference, and
- (2) this device must accept any interference received, including interference that may cause undesired operation."

"Changes or modifications to this unit not expressly approved by the party responsible for compliance could void the user's authority to operate the equipment."

the Integrator will be responsible to satisfy SAR/ RF Exposure requirements, when the module is integrated into the host device.

The final host device, into which this RF Module is integrated" has to be labelled with an auxiliary label stating the IC of the RF Module, such as
"Contains transmitter module IC 20863-1337R"

This device complies with Industry Canada licence-exempt RSS standard(s). Operation is subject to the following two conditions:

- (1) this device may not cause interference, and
- (2) this device must accept any interference, including interference that may cause undesired operation of the device.

Le présent appareil est conforme aux CNR d'Industrie Canada applicables aux appareils radio exempts de licence. L'exploitation est autorisée aux deux conditions suivantes :

- (1) l'appareil ne doit pas produire de brouillage, et
- (2) l'utilisateur de l'appareil doit accepter tout brouillage radioélectrique subi, même si le brouillage est susceptible d'en compromettre le fonctionnement.

Host 15B and 15C compliance statement

A host product itself is required to comply with all other applicable FCC equipment authorization regulations, requirements, and equipment functions that are not associated with the transmitter module portion. For example, compliance must be demonstrated: to regulations for other transmitter components within a host product; to requirements for unintentional radiators (Part 15 Subpart B), such as digital devices, computer peripherals, radio receivers, etc.; and to additional authorization requirements for the non-transmitter functions on the transmitter module (i.e., Verification or Declaration of Conformity) as appropriate (e.g., Bluetooth and Wi-Fi transmitter modules may also contain digital logic functions).

The OEM integrator or the host manufacturer is responsible for the overall compliance of the host products

FCC statement

This device complies with Part 15 of FCC rules. Operation is subject to the following two conditions: (1) this device may not cause harmful interference and (2) this device must accept any interference received, including interference that may cause undesired operation.

Module statement

The single-modular transmitter is a self-contained, physically delineated, component for which compliance can be demonstrated independent of the host operating conditions, and which complies with all eight requirements of § 15.212(a)(1) as summarized below.

- 1) The radio elements have the radio frequency circuitry shielded.
- 2) The module has buffered modulation/data inputs to ensure that the device will comply with Part 15 requirements with any type of input signal.
- 3) The module contains power supply regulation on the module.
- 4) The module contains a permanently attached antenna.
- 5) The module demonstrates compliance in a stand-alone configuration.
- 6) The module is labeled with its permanently affixed FCC ID label
- 7) The module complies with all specific rules applicable to the transmitter, including all the conditions provided in the integration instructions by the grantee.
- 8) The module complies with RF exposure requirements.
- 9) in addition to permanent attached antenna, the product could be connected with some detachable antennas.

Note:U.FL / IPEX antenna connector is not considered as a type of unique antenna coupling. However, as the installation of this module would be done by OEM integrator, it could be considered as a professional installation.

NOTE: This equipment has been tested and found to comply with the limits for a Class B digital device, pursuant to part 15 of the FCC Rules. These limits are designed to provide reasonable protection against harmful interference in a residential installation. This equipment generates uses and can radiate radio frequency energy and, if not installed and used in accordance with the instructions, may cause harmful interference to radio communications. However, there is no guarantee that interference will not occur in a particular installation. If this equipment does cause harmful interference to radio or television reception, which can be determined by turning the equipment off and on, the user is encouraged to try to correct the interference by one or more of the following measures:

- Reorient or relocate the receiving antenna.
- Increase the separation between the equipment and receiver.
- Connect the equipment into an outlet on a circuit different from that to which the receiver is connected.
- Consult the dealer or an experienced radio/TV technician for help

FCC Radio Frequency Exposure Statement

The device has been evaluated to meet general RF exposure requirements. The min separation distance is 20cm between the transmitter/antenna and nearby person.

This transmitter/module must not be collocated or operating in conjunction with any other antenna or transmitter.