

FCC 47 CFR PART 15 SUBPART C

RF Test Report

Applicant : Wuunet Technology Co ., Ltd
Product Type : Wara Home
Trade Name : wuunet
Model Number : WB101U
Applicable Standard : FCC 47 CFR PART 15 SUBPART C
ANSI C63.10:2013
Receive Date : Jul. 28, 2016
Test Period : Aug. 12 ~ Aug. 19, 2016
Issue Date : Nov. 22, 2016

Issue by

A Test Lab Techno Corp.
No. 140-1, Changan Street, Bade District,
Taoyuan City 33465, Taiwan (R.O.C)
Tel : +886-3-2710188 / Fax : +886-3-2710190



Taiwan Accreditation Foundation accreditation number: 1330

Note: This report shall not be reproduced except in full, without the written approval of A Test Lab Techno Corp. This document may be altered or revised by A Test Lab Techno Corp. personnel only, and shall be noted in the revision section of the document. The client should not use it to claim product endorsement by TAF, or any government agencies. The test results in the report only apply to the tested sample.



Revision History

Rev.	Issue Date	Revisions	Revised By
00	Sep. 29, 2016	Initial Issue	Tiffany Lee
01	Oct. 21, 2016	Revised report information.	Joyce Liao
02	Nov. 03, 2016	Revised report information.	Joyce Liao
03	Nov. 22, 2016	Revised report information.	Joyce Liao



Verification of Compliance

Issued Date: Nov. 22, 2016

Applicant : Wuunet Technology Co., Ltd
Product Type : Wara Home
Trade Name : wuunet
Model Number : WB101U
FCC ID : 2AF8P-WB101U
EUT Rated Voltage : 100-240Vac / 50-60Hz
Test Voltage : 120 Vac / 60 Hz
Applicable Standard : FCC 47 CFR PART 15 SUBPART C
ANSI C63.10:2013
Test Result : Complied
Performing Lab. : A Test Lab Techno Corp.
No. 140-1, Changan Street, Bade District,
Taoyuan City 33465, Taiwan (R.O.C)
Tel : +886-3-2710188 / Fax : +886-3-2710190
Taiwan Accreditation Foundation accreditation number: 1330
<http://www.atl-lab.com.tw/e-index.htm>

A Test Lab Techno Corp. tested the above equipment in accordance with the requirements set forth in the above standards. All indications of Pass/Fail in this report are opinions expressed by A Test Lab Techno Corp. based on interpretations and/or observations of test results. Measurement Uncertainties were not taken into account and are published for informational purposes only. The test results show that the equipment tested is capable of demonstrating compliance with the requirements as documented in this report.

Approved By : Fly Lu Reviewed By : Eric Ou Yang
(Manager) (Fly Lu) (Testing Engineer) (Eric Ou Yang)



TABLE OF CONTENTS

1	General Information	5
2	EUT Description	6
3	Test Methodology	7
3.1.	Mode of Operation	7
3.2.	EUT Exercise Software	10
3.3.	Configuration of Test System Details	10
3.4.	Test Site Environment	11
4	AC Power Line Conducted Emission Measurement	11
4.1.	Limit	11
4.2.	Test Instruments	12
4.3.	Test Setup.....	12
4.4.	Test Procedure	13
4.5.	Test Result.....	14
5	Radiated Emission Measurement	16
5.1.	Limit	16
5.2.	Test Instruments	16
5.3.	Setup	17
5.4.	Test Procedure	19
5.5.	Test Result.....	21
6	Maximum Conducted Output Power Measurement	44
6.1.	Limit	44
6.2.	Test Setup.....	44
6.3.	Test Instruments	44
6.4.	Test Procedure	44
6.5.	Test Result.....	45
7	6dB RF Bandwidth Measurement	46
7.1.	Limit	46
7.2.	Test Setup.....	46
7.3.	Test Instruments	46
7.4.	Test Procedure	46
7.5.	Test Result.....	47
7.6.	Test Graphs	48
8	Maximum Power Density Measurement	52
8.1.	Limit	52
8.2.	Test Setup.....	52
8.3.	Test Instruments	52
8.4.	Test Procedure	53
8.5.	Test Result.....	53
8.6.	Test Graphs	54
9	Out of Band Conducted Emissions Measurement	58
9.1.	Limit	58
9.2.	Test Setup.....	58
9.3.	Test Instruments	58
9.4.	Test Procedure	58
9.5.	Test Graphs	59
10	Antenna Measurement	71
10.1.	Limit	71
10.2.	Antenna Description	71



1 General Information

1.1 Summary of Test Result

Standard	Item	Result	Remark
15.247			
15.207	AC Power Conducted Emission	PASS	-----
Standard	Item	Result	Remark
15.247			
15.247(d)	Transmitter Radiated Emissions	PASS	-----
15.247(b)(3)	Max. Output Power	PASS	-----
15.247(a)(2)	6dB RF Bandwidth	PASS	-----
15.247(e)	Power Spectral Density	PASS	-----
15.247(d)	Out of Band Conducted Spurious Emission	PASS	-----
15.203	Antenna Requirement	PASS	-----

The test results of this report relate only to the tested sample(s) identified in this report. Manufacturer or whom it may concern should recognize the pass or fail of the test result.

1.2 Measurement Uncertainty

Test Item	Frequency Range	Uncertainty (dB)
Conducted Emission	9kHz ~ 150KHz	2.7
	150kHz ~ 30MHz	2.8
Radiated Emission	9kHz ~ 30MHz	1.457
	30MHz ~ 1000MHz	6.300
	1000MHz ~ 18000MHz	5.474
	18000MHz ~ 26500MHz	5.630
	26500MHz ~ 40000MHz	5.054
Conducted Output Power	+0.27 dB / -0.28 dB	
RF Bandwidth	4.96%	
Power Spectral Density	+0.71 dB / -0.77 dB	



2 EUT Description

Applicant	Wuunet Technology Co ., Ltd 7F, No. 209, Bldg. B, Sec. 1, Nangang Rd., Nangang Dist., Taipei City, Taiwan			
Manufacturer	Wuunet Technology Co ., Ltd 7F, No. 209, Bldg. B, Sec. 1, Nangang Rd., Nangang Dist., Taipei City, Taiwan			
Product Type	Wara Home			
Trade Name	wuunet			
Model Number	WB101U			
FCC ID	2AF8P-WB101U			
Operate Freq. Band	Frequency Range (MHz)	Modulation	Channel Bandwidth	Data Rate 400 GI (ns)
IEEE 802.11b	2412 ~ 2462	DSSS	20MHz	Up to 11Mbps
IEEE 802.11g	2412 ~ 2462	OFDM	20MHz	Up to 54Mbps
IEEE 802.11n 2.4GHz 20MHz	2412 ~ 2462	OFDM	20MHz	Up to 72.2Mbps
IEEE 802.11n 2.4GHz 40MHz	2422 ~ 2452	OFDM	40MHz	Up to 150Mbps
Antenna information	Type		Max. Gain (dBi)	
	monopole Antenna		2.546	
Antenna Delivery	See section 3.1			

Frequency Band	Max. RF Output Power (W)
IEEE 802.11b	0.021
IEEE 802.11g	0.017
IEEE 802.11n 2.4GHz 20MHz	0.016
IEEE 802.11n 2.4GHz 40MHz	0.014

3 Test Methodology

3.1. Mode of Operation

Decision of Test ATL has verified the construction and function in typical operation. All the test modes were carried out with the EUT in normal operation, which was shown in this test report and defined as:

Test Mode
Mode 1: Continuous TX mode
Mode 2: IEEE 802.11b link mode
Mode 3: IEEE 802.11g link mode
Mode 4: IEEE 802.11n 2.4GHz 20MHz link mode
Mode 5: IEEE 802.11n 2.4GHz 40MHz link mode

Software used to control the EUT for staying in continuous transmitting mode was programmed.

After verification, all tests were carried out with the worst case test modes as shown below except radiated spurious emission below 1GHz and power line conducted emissions below 30MHz, which worst case was in normal link mode only.

By preliminary testing and verifying three axis (X, Y and Z) position of EUT transmitted status, it was found that "X axis" position was the worst, then the final test was executed the worst condition and test data were recorded in this report.

Test Mode	ANT-0
Mode 2: IEEE 802.11b link mode	V
Mode 3: IEEE 802.11g link mode	V
Mode 4: IEEE 802.11n 2.4GHz 20MHz link mode	V
Mode 5: IEEE 802.11n 2.4GHz 40MHz link mode	V

Test Mode	Antenna Delivery	Test Channel	Data Rate 400GI (ns)
Mode 2: IEEE 802.11b link mode	1TX / 1RX	1, 6, 11	11
Mode 3: IEEE 802.11g link mode	1TX / 1RX	1, 6, 11	54
Mode 4: IEEE 802.11n 2.4GHz 20MHz link mode	1TX / 1RX	1, 6, 11	72.2
Mode 5: IEEE 802.11n 2.4GHz 40MHz link mode	1TX / 1RX	3, 6, 9	150

Duty cycle

Test Mode	Frequency (MHz)	on time (ms)	on+off time (ms)	Duty cycle	Duty Factor (dB)	1/T Minimum VBW (kHz)
Mode 2: IEEE 802.11b link mode	2412.0	8.413	8.445	0.996	0.02	0.12
Mode 3: IEEE 802.11g link mode	2412.0	1.391	1.444	0.963	0.16	0.72
Mode 4: IEEE 802.11n 2.4GHz 20MHz link mode	2412.0	1.302	1.401	0.929	0.32	0.77
Mode 5: IEEE 802.11n 2.4GHz 40MHz link mode	2422.0	0.644	0.679	0.948	0.23	1.55

Duty Cycle Graphs

Mode 2: IEEE 802.11b link mode

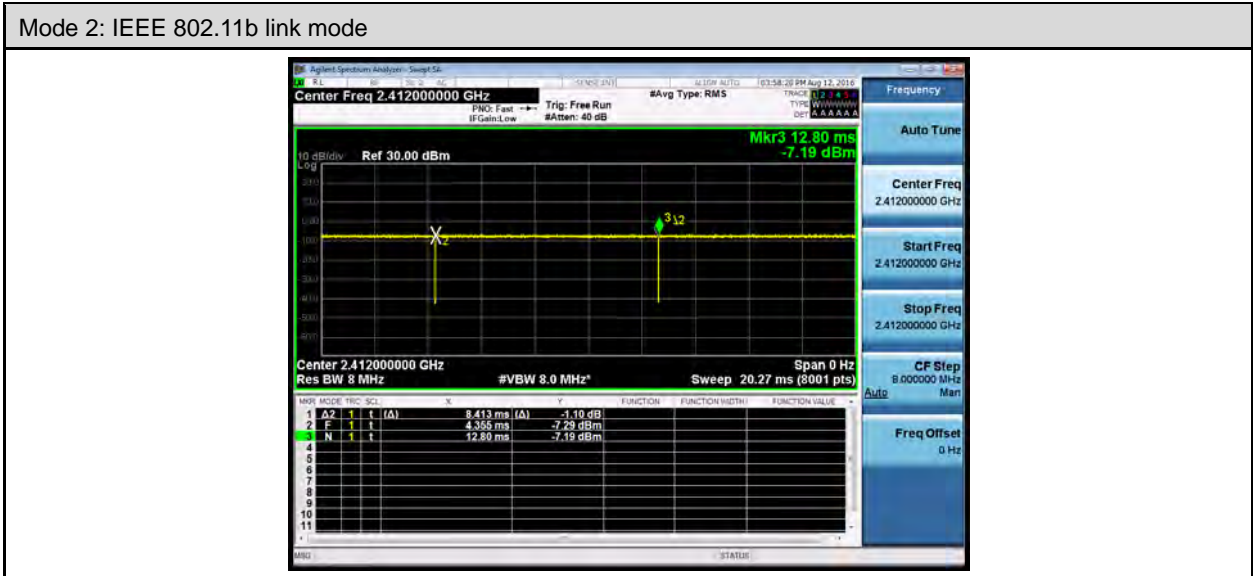

Mode 3: IEEE 802.11g Mode

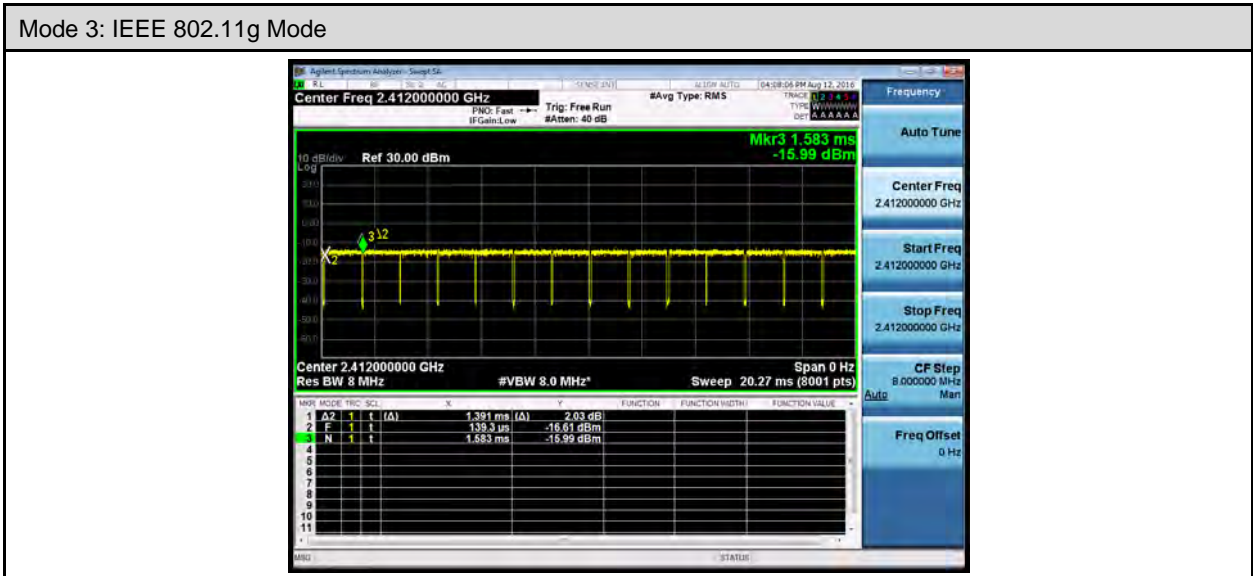

Mode 4: IEEE 802.11n 2.4GHz 20MHz Mode

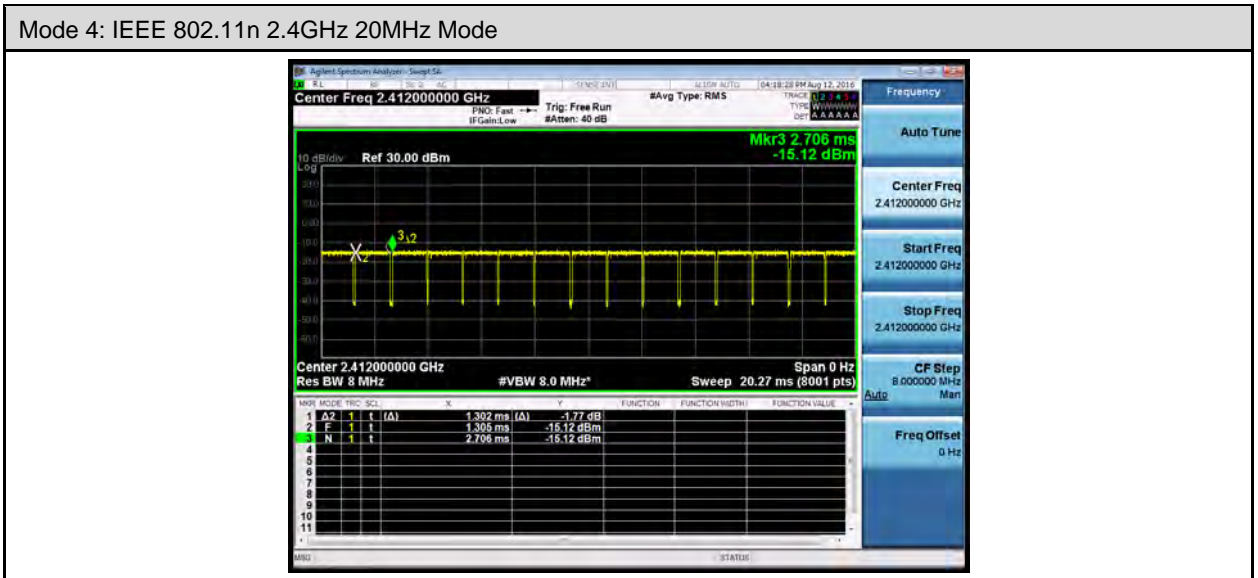

Mode 5: IEEE 802.11n 2.4GHz 40MHz Mode

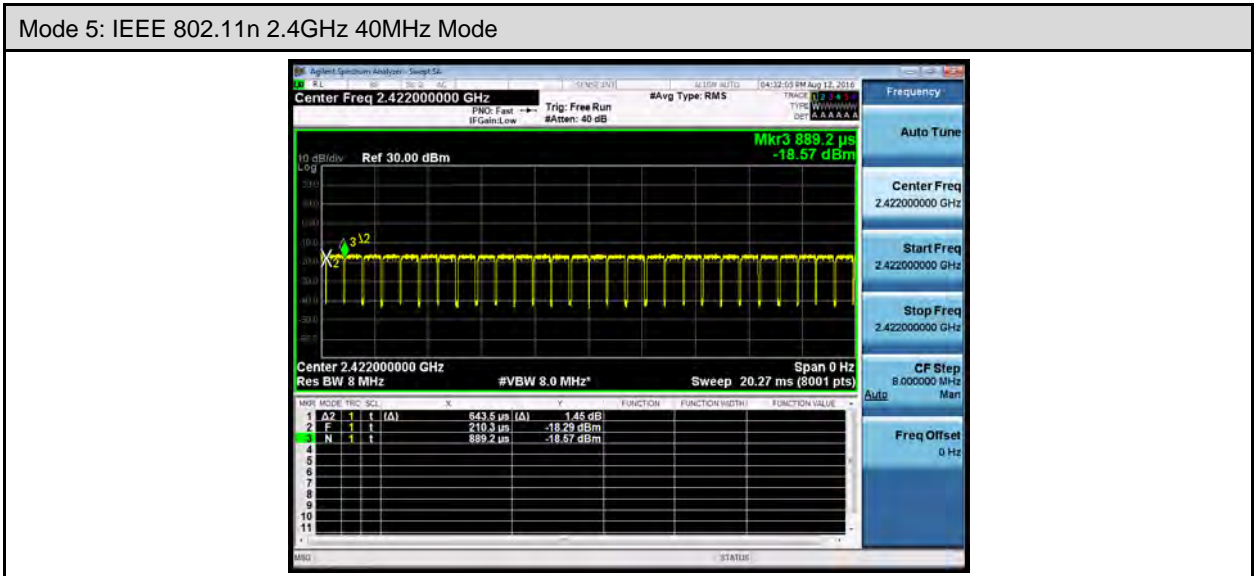

3.2. EUT Exercise Software

1.	Setup the EUT shown on 3.3.
2.	Turn on the power of all equipment.
3.	Turn Wi-Fi function link to AP
4.	EUT run test program.

Measurement Software	
1	EZ-EMC Ver. ATL-03A1-1
2	EZ-EMC Ver ATL-ITC-3A1-1

3.3. Configuration of Test System Details

Conducted Emissions

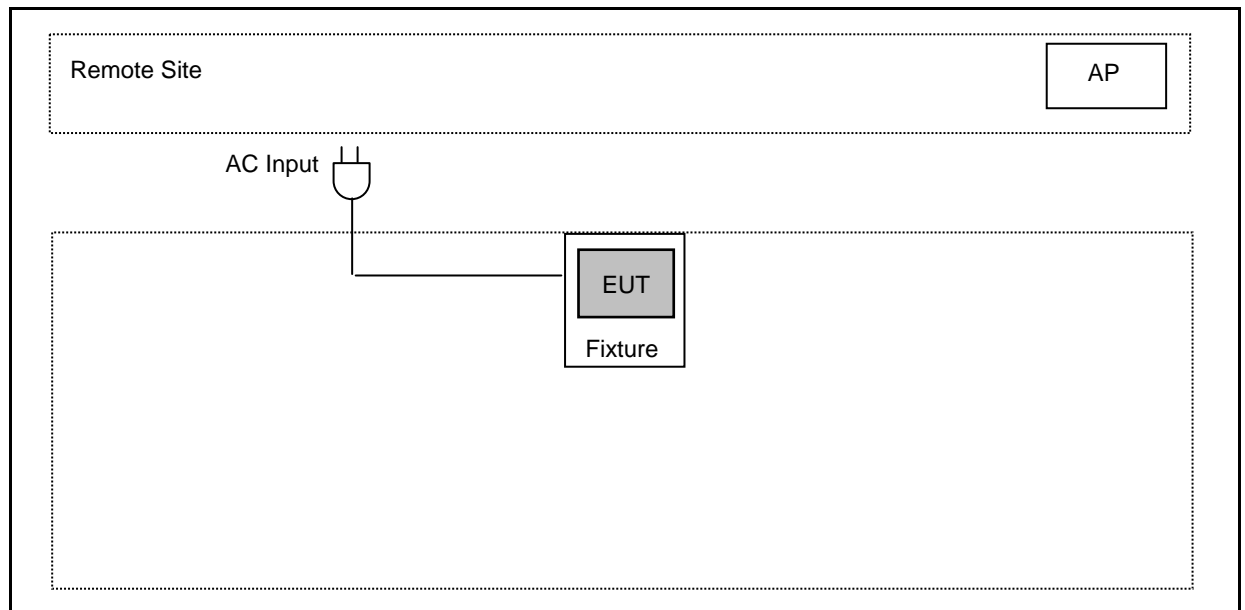

Radiated Emissions

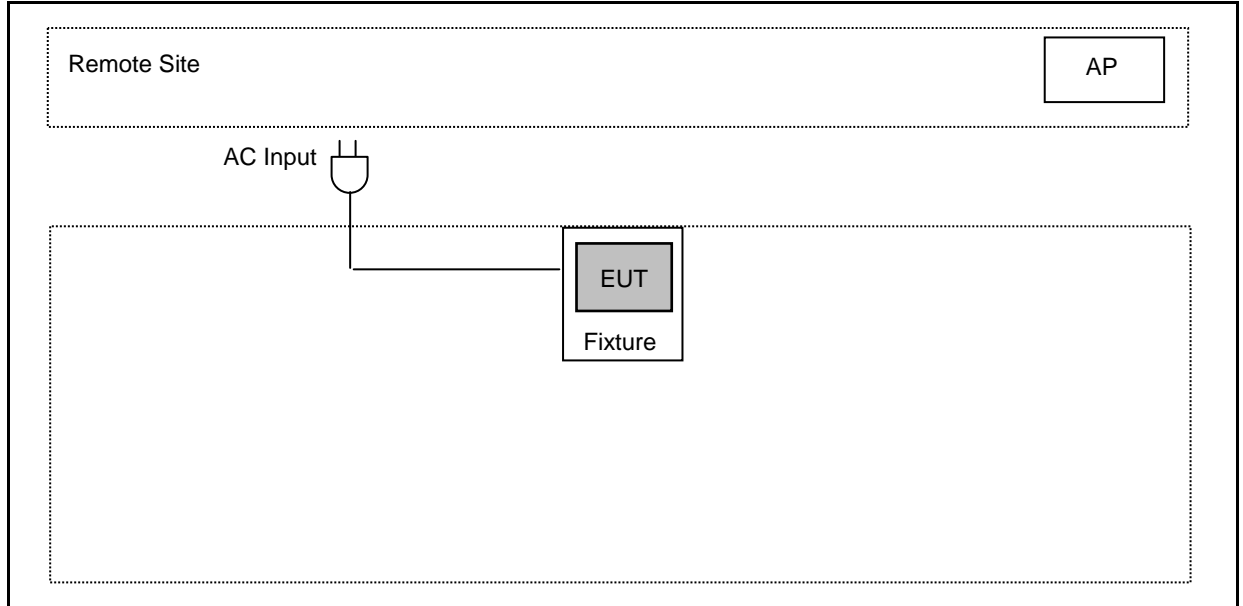

3.4. Test Site Environment

Items	Required (IEC 60068-1)	Actual
Temperature (°C)	15-35	26
Humidity (%RH)	25-75	60
Barometric pressure (mbar)	860-1060	950

4 AC Power Line Conducted Emission Measurement

4.1. Limit

Frequency (MHz)	Quasi-peak	Average
0.15 - 0.5	66 to 56	56 to 46
0.50 - 5.0	56	46
5.0 - 30.0	60	50

4.2. Test Instruments

Describe	Manufacturer	Model Number	Serial Number	Cal. Date	Cal. Period
Test Receiver	R&S	ESCI	100367	05/31/2016	1 year
LISN	R&S	ENV216	101040	03/15/2016	1 year
LISN	R&S	ENV216	101041	03/07/2016	1 year
RF Cable	Woken	00100D1380194M	TE-02-02	05/31/2016	1 year
Test Site	ATL	TE02	TE02	N.C.R.	-----

Note: N.C.R. = No Calibration Request.

4.3. Test Setup

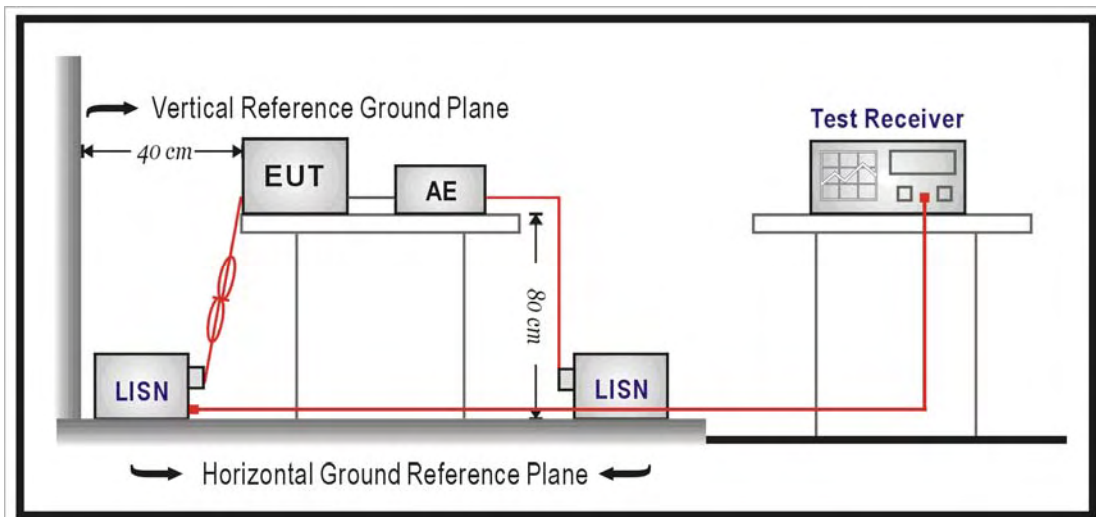

4.4. Test Procedure

The EUT and simulators are connected to the main power through a line impedance stabilization network (L.I.S.N.). This provides a $50\Omega//50\mu\text{H}$ coupling impedance for the measuring equipment. The peripheral devices are also connected to the main power through a LISN that provides a $50\Omega//50\mu\text{H}$ coupling impedance with 50ohm termination.

Tabletop device shall be placed on a non-conducting platform, of nominal size 1 m by 1.5 m, raised 80 cm above the reference ground plane. The wall of screened room shall be located 40cm to the rear of the EUT. Other surfaces of tabletop or floor standing EUT shall be at least 80cm from any other ground conducting surface including one or more LISNs. For floor-standing device shall be placed under the EUT with a 12mm insulating material.

Conducted emissions were investigated over the frequency range from 0.15 MHz to 30 MHz using a resolution bandwidth of 9 kHz. The equipment under test (EUT) shall be meet the limits in section 4.1, as applicable, including the average limit and the quasi-peak limit when using respectively, an average detector and quasi-peak detector measured in accordance with the methods described of related standard. When all of peak value were complied with quasi-peak and average limit from 150kHz to 30MHz then quasi-peak and average measurement was unnecessary.

The AMN shall be placed 0,8 m from the boundary of the unit under test and bonded to a ground reference plane for AMNs mounted on top of the ground reference plane. This distance is between the closest points of the AMN and the EUT. All other units of the EUT and associated equipment shall be at least 0,8 m from the AMN. If the mains power cable is longer than 1m then the cable shall be folded back and forth at the centre of the lead to form a bundle no longer than 0.4m. All of interconnecting cables that hang closer than 40cm to the ground plane shall be folded back and forth in the center forming a bundle 30 cm to 40 cm long. All of EUT and AE shall be separate place more than 0.1m. All 50 Ω ports of the LISN shall be resistively terminated into 50 Ω loads when not connected to the measuring instrument.

If the reading of the measuring receiver shows fluctuations close to the limit, the reading shall be observed for at least 15 s at each measurement frequency; the higher reading shall be recorded with the exception of any brief isolated high reading which shall be ignored.

4.5. Test Result

Standard:	FCC Part 15C	Line:	L1
Test item:	Conducted Emission	Power:	AC 120V/60Hz
Model Number:	WB101U	Temp.(°C)/Hum.(%RH):	26(°C)/60%RH
Mode:	Mode 1	Date:	08/19/2016
		Test By:	Eric Ou Yang
Description:			

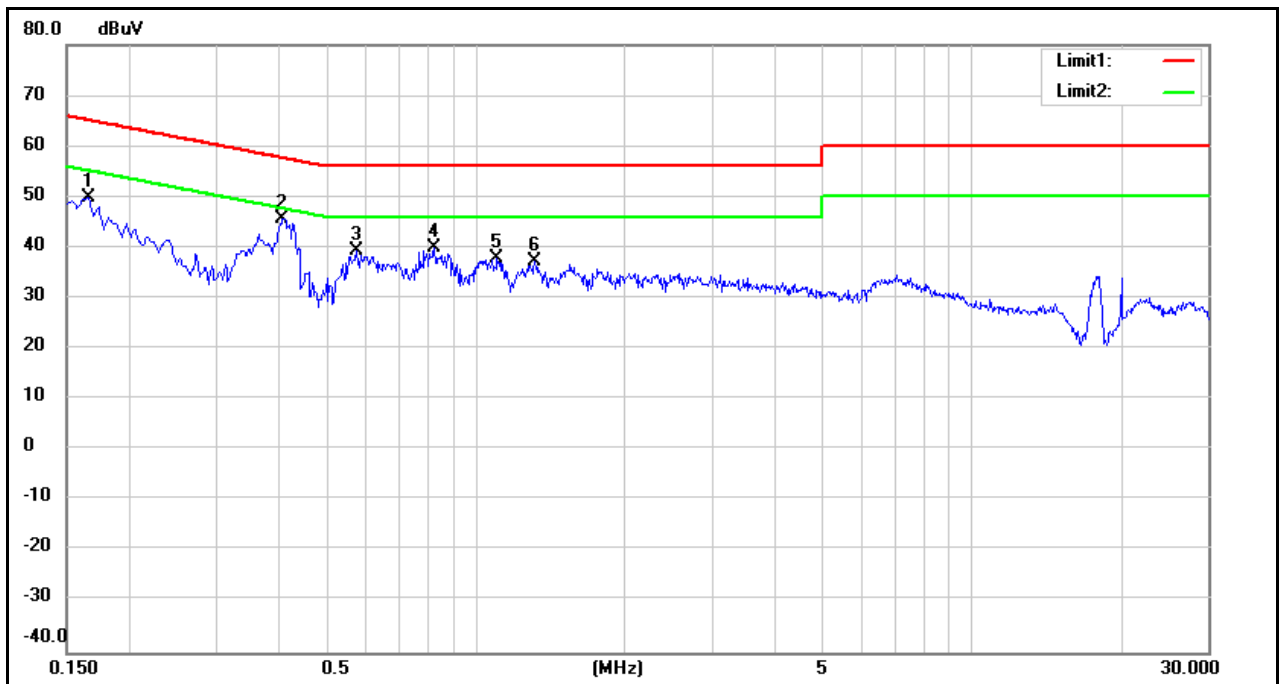

No.	Frequency (MHz)	QP reading (dBuV)	AVG reading (dBuV)	Correction factor (dB)	QP result (dBuV)	AVG result (dBuV)	QP limit (dBuV)	AVG limit (dBuV)	QP margin (dB)	AVG margin (dB)	Remark
1	0.1660	29.76	14.59	10.28	40.04	24.87	65.16	55.16	-25.12	-30.29	Pass
2	0.4100	29.93	21.33	10.35	40.28	31.68	57.65	47.65	-17.37	-15.97	Pass
3	0.5780	22.74	13.23	10.37	33.11	23.60	56.00	46.00	-22.89	-22.40	Pass
4	0.8300	22.50	13.29	10.41	32.91	23.70	56.00	46.00	-23.09	-22.30	Pass
5	1.1100	21.42	12.34	10.39	31.81	22.73	56.00	46.00	-24.19	-23.27	Pass
6	1.3220	20.21	10.18	10.41	30.62	20.59	56.00	46.00	-25.38	-25.41	Pass

Note: 1. Result (dBuV) = Correction factor (dB) + Reading(dBuV).

2. Correction factor (dB) = Cable loss (dB) + L.I.S.N. factor (dB).



Standard:	FCC Part 15C	Line:	N
Test item:	Conducted Emission	Power:	AC 120V/60Hz
Model Number:	WB101U	Temp.(°C)/Hum.(%RH):	26(°C)/60%RH
Mode:	Mode 1	Date:	08/19/2016
		Test By:	Eric Ou Yang
Description:			

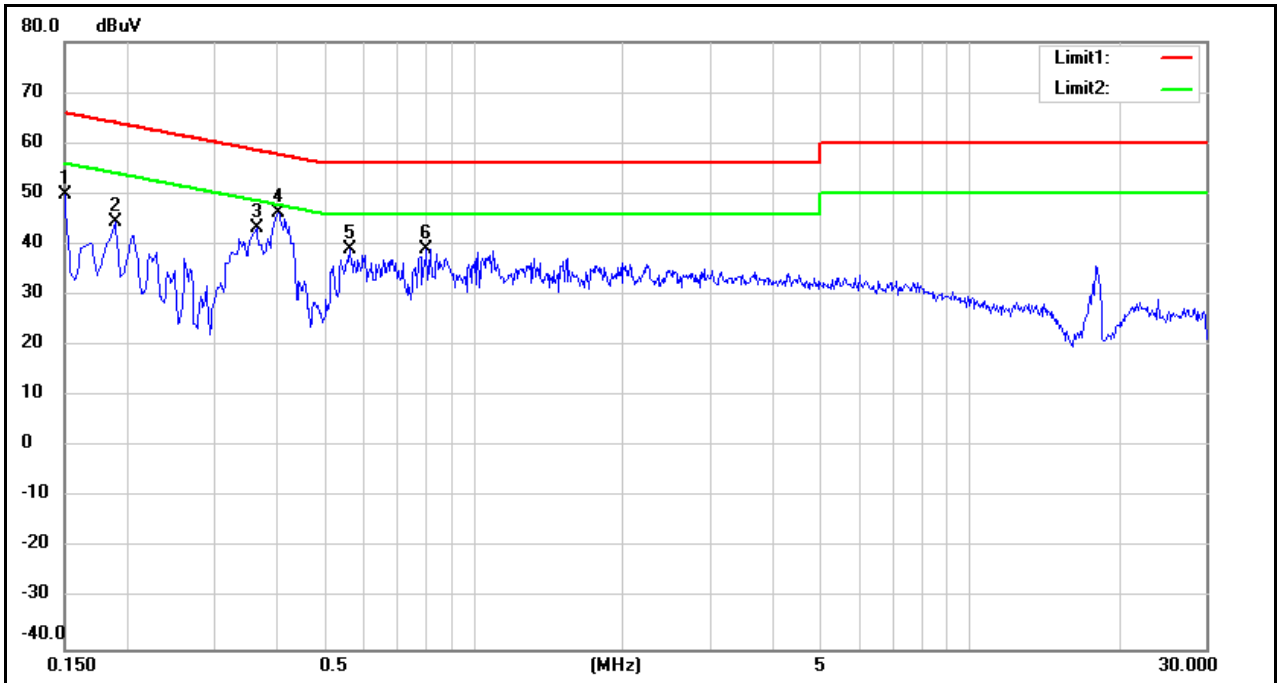

No.	Frequency (MHz)	QP reading (dBuV)	AVG reading (dBuV)	Correction factor (dB)	QP result (dBuV)	AVG result (dBuV)	QP limit (dBuV)	AVG limit (dBuV)	QP margin (dB)	AVG margin (dB)	Remark
1	0.1500	31.20	16.74	10.29	41.49	27.03	66.00	56.00	-24.51	-28.97	Pass
2	0.1900	26.92	16.55	10.27	37.19	26.82	64.04	54.04	-26.85	-27.22	Pass
3	0.3660	29.08	22.55	10.35	39.43	32.90	58.59	48.59	-19.16	-15.69	Pass
4	0.4060	33.02	26.55	10.35	43.37	36.90	57.73	47.73	-14.36	-10.83	Pass
5	0.5660	24.37	16.66	10.36	34.73	27.02	56.00	46.00	-21.27	-18.98	Pass
6	0.8060	24.65	15.31	10.41	35.06	25.72	56.00	46.00	-20.94	-20.28	Pass

Note: 1. Result (dBuV) = Correction factor (dB) + Reading(dBuV).

2. Correction factor (dB) = Cable loss (dB) + L.I.S.N. factor (dB).



5 Radiated Emission Measurement

5.1. Limit

According to §15.209(a), except as provided elsewhere in this subpart, the emissions from an intentional radiator shall not exceed the field strength levels specified in the following table:

Frequency (MHz)	Field Strength ($\mu\text{V}/\text{m}$ at meter)	Measurement Distance (meters)
0.009 – 0.490	2400 / F (kHz)	300
0.490 – 1.705	24000 / F (kHz)	30
1.705 – 30.0	30	30
30 - 88	100**	3
88-216	150**	3
216-960	200**	3
Above 960	500	3

** Except as provided in paragraph (g), fundamental emissions from intentional radiators operating under this Section shall not be located in the frequency bands 54-72 MHz, 76-88 MHz, 174-216 MHz or 470-806 MHz. However, operation within these frequency bands is permitted under other sections of this Part, e.g., Sections 15.231 and 15.241.

5.2. Test Instruments

3 Meter Chamber					
Equipment	Manufacturer	Model Number	Serial Number	Cal. Date	Cal. Period
RF Pre-selector	Agilent	N9039A	MY46520256	01/08/2016	1 year
Spectrum Analyzer	Agilent	E4446A	MY46180578	01/08/2016	1 year
Pre Amplifier	Agilent	8449B	3008A02237	10/07/2015	1 year
Pre Amplifier	Agilent	8447D	2944A11119	01/11/2016	1 year
Broadband Antenna	Schwarzbeck	VULB9168	416	09/25/2015	1 year
Horn Antenna (1~18GHz)	SCHWARZBECK MESS-ELEKTRONIK	BBHA9120D	9120D-550	06/06/2016	1 year
Horn Antenna (18~40GHz)	ETS	3116	86467	09/01/2015	1 year
Loop Antenna	COM-POWER CORPORATION	AL-130	121014	02/01/2016	1 year
Microwave Cable	EMCI	EMC102-KM-KM-14000	151001	10/15/2015	1 year
Microwave Cable	EMCI	EMC-104-SM-SM-14000	140202	10/15/2015	1 year
Microwave Cable	EMCI	EMC104-SM-SM-600	140301	10/15/2015	1 year
Test Site	ATL	TE01	888001	08/27/2015	1 year

Note: N.C.R. = No Calibration Request.

5.3. Setup

9kHz ~ 30MHz

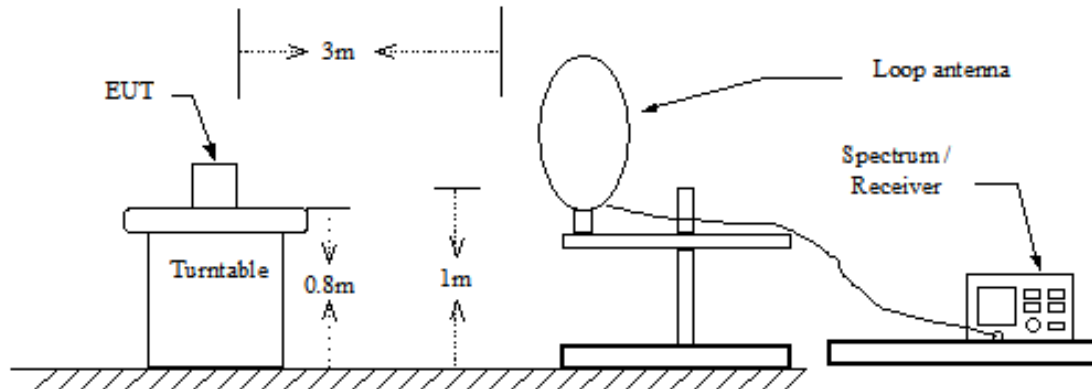

Below 1GHz

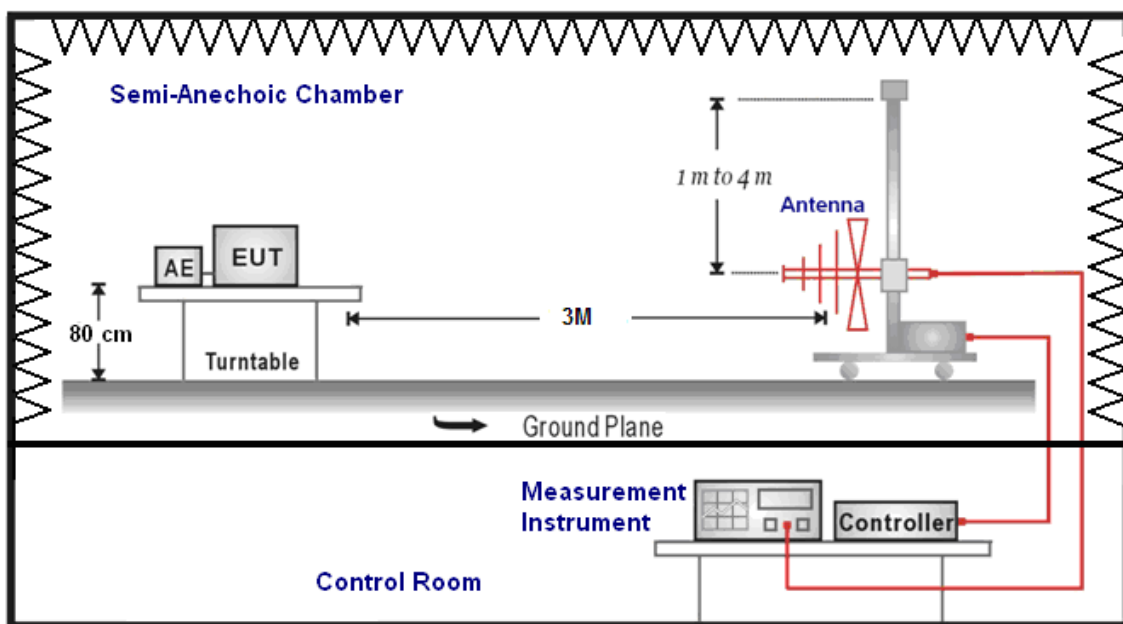

Above 1GHz

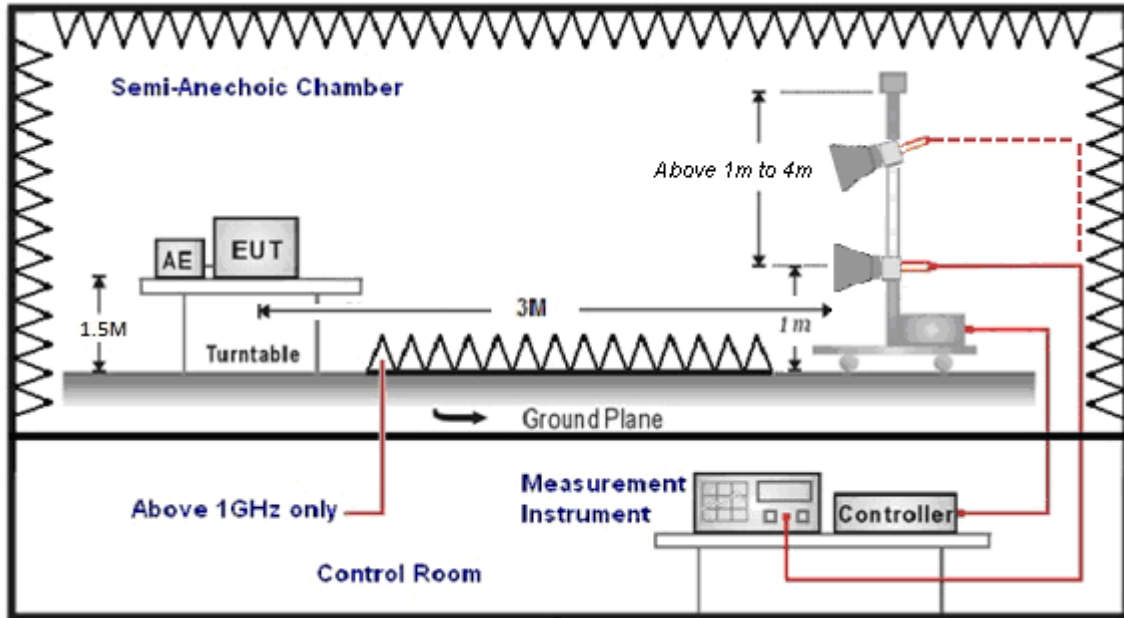



5.4. Test Procedure

Final radiation measurements were made on a three-meter, Semi Anechoic Chamber. The EUT system was placed on a nonconductive turntable which is 0.8 or 1.5 meters height (below 1GHz use 0.8m turntable / above 1GHz use 1.5m turntable), top surface 1.0 x 1.5 meter. The spectrum was examined from 250 MHz to 2.5 GHz in order to cover the whole spectrum below 10th harmonic which could generate from the EUT. During the test, EUT was set to transmit continuously & Measurements spectrum range from 9 kHz to 26.5 GHz is investigated.

For measurements below 1 GHz the resolution bandwidth is set to 100 kHz for peak detection measurements or 120 kHz for quasi-peak detection measurements. Peak detection is used unless otherwise noted as quasi-peak.

For measurements above 1 GHz the resolution bandwidth is set to 1 MHz, and then the video bandwidth is set to 1 MHz for peak measurements and 10 Hz for average measurements when Duty cycle >0.98 / $1/T$ for average measurements when Duty cycle <0.98 . A nonconductive material surrounded the EUT to supporting the EUT for standing on three orthogonal planes. At each condition, the EUT was rotated 360 degrees, and the antenna was raised and lowered from one to four meters to find the maximum emission levels. Measurements were taken using both horizontal and vertical antenna polarization.

SCHWARZBECK MESS-ELEKTRONIK Biconilog Antenna at 3 Meter and the SCHWARZBECK Double Ridged Guide Antenna was used in frequencies 1 – 26.5 GHz at a distance of 3 meter. The antenna at an angle toward the source of the emission. All test results were extrapolated to equivalent signal at 3 meters utilizing an inverse linear distance extrapolation Factor (20dB/decade).

For testing above 1GHz, the emission level of the EUT in peak mode was 20dB lower than average limit (that means the emission level in peak mode also complies with the limit in average mode), then testing will be stopped and peak values of EUT will be reported, otherwise, the emissions will be measured in average mode again and reported.

Appropriate preamplifiers were used for improving sensitivity and precautions were taken to avoid overloading or desensitizing the spectrum analyzer. No post – detector video filters were used in the test.

The spectrum analyzer's 6 dB bandwidth was set to 1 MHz, and the analyzer was operated in the peak detection mode, for frequencies both below and up 1 GHz. The average levels were obtained by subtracting the duty cycle correction factor from the peak readings.

The following procedures were used to convert the emission levels measured in decibels referenced to 1 microvolt (dBuV) into field intensity in micro volts pre meter ($\mu\text{V}/\text{m}$).

The actual field intensity in decibels referenced to 1 microvolt in to field intensity in micro volts per meter (dBuV/m).



The actual field intensity in referenced to 1 microvolt per meter (dBuV/m) is determined by algebraically adding the measured reading in dBuV, the antenna factor (dB), and cable loss (dB) and Subtracting the gain of preamplifier (dB) is auto calculate in spectrum analyzer.

(1) $\text{Amplitude (dBuV/m)} = \text{FI (dBuV)} + \text{AF (dBuV)} + \text{CL (dBuV)} - \text{Gain (dB)}$

FI= Reading of the field intensity.

AF= Antenna factor.

CL= Cable loss.

P.S Amplitude is auto calculate in spectrum analyzer.

(2) $\text{Actual Amplitude (dBuV/m)} = \text{Amplitude (dBuV)} - \text{Dis(dB)}$

The FCC specified emission limits were calculated according the EUT operating frequency and by following linear interpolation equations:

(a) For fundamental frequency : Transmitter Output < +30dBm

(b) For spurious frequency : Spurious emission limits = fundamental emission limit /10

Data of measurement within this frequency range without mark in the table above means the reading of emissions are attenuated more than 20dB below the permissible limits or the field strength is too small to be measured.



5.5. Test Result

Below 1GHz

Standard:	FCC Part 15C	Test Distance:	3m
Test item:	Radiated Emission	Power:	AC 120V/60Hz
Model Number:	WB101U	Temp.(°C)/Hum.(%RH):	26(°C)/60%RH
Mode:	Mode 1	Date:	08/17/2016
		Test By:	Eric Ou Yang

Frequency (MHz)	Reading (dBuV)	Correct Factor (dB/m)	Result (dBuV/m)	Limit (dBuV/m)	Margin (dB)	Remark	Ant.Polar. H / V
161.9200	46.16	-18.03	28.13	43.50	-15.37	QP	H
200.7200	46.52	-20.19	26.33	43.50	-17.17	QP	H
216.2400	44.29	-20.17	24.12	46.00	-21.88	QP	H
288.0200	43.95	-16.38	27.57	46.00	-18.43	QP	H
804.0600	37.23	-4.51	32.72	46.00	-13.28	QP	H
905.9100	33.95	-1.86	32.09	46.00	-13.91	QP	H
128.9400	44.59	-15.98	28.61	43.50	-14.89	QP	V
153.1900	38.78	-15.37	23.41	43.50	-20.09	QP	V
233.7000	35.95	-13.11	22.84	46.00	-23.16	QP	V
600.3600	30.15	-6.71	23.44	46.00	-22.56	QP	V
722.5800	30.42	-4.10	26.32	46.00	-19.68	QP	V
804.0600	32.77	-3.91	28.86	46.00	-17.14	QP	V

Note:1.Result (dBuV) = Correction factor (dB) + Reading(dBuV).

2.Correction factor (dB/m) = Antenna Factor (dB/m) + Cable loss (dB) – Pre-Amplifier gain (dB).

3.No emission found between lowest internal used/generated frequencies to 30MHz (9 kHz~30MHz).



Above 1GHz

Standard:	FCC Part 15C			Test Distance:	3m		
Test item:	Radiated Emission			Power:	AC 120V/60Hz		
Model Number:	WB101U			Temp.(°C)/Hum.(%RH):	26(°C)/60%RH		
Mode:	Mode 2			Date:	08/17/2016		
Frequency:	2412MHz			Test By:	Eric Ou Yang		
Frequency (MHz)	Reading (dBuV)	Correct Factor (dB/m)	Result (dBuV/m)	Limit (dBuV/m)	Margin (dB)	Remark	Ant.Polar. H / V
4824.000	54.82	-7.55	47.27	74.00	-26.73	peak	H
4824.000	48.14	-7.55	40.59	54.00	-13.41	peak	H
4824.000	56.31	-7.55	48.76	74.00	-25.24	peak	V
4824.000	51.03	-7.55	43.48	54.00	-10.52	AVG	V

Standard:	FCC Part 15C			Test Distance:	3m		
Test item:	Radiated Emission			Power:	AC 120V/60Hz		
Model Number:	WB101U			Temp.(°C)/Hum.(%RH):	26(°C)/60%RH		
Mode:	Mode 2			Date:	08/17/2016		
Frequency:	2437MHz			Test By:	Eric Ou Yang		
Frequency (MHz)	Reading (dBuV)	Correct Factor (dB/m)	Result (dBuV/m)	Limit (dBuV/m)	Margin (dB)	Remark	Ant.Polar. H / V
4874.000	50.76	-7.51	43.25	74.00	-30.75	peak	H
4874.000	53.05	-7.51	45.54	74.00	-28.46	peak	V

Note:1.Result (dBuV) = Correction factor (dB) + Reading(dBuV).

2. Correction factor (dB/m) = Antenna Factor (dB/m) + Cable loss (dB) – Pre-Amplifier gain (dB).



Standard:	FCC Part 15C	Test Distance:	3m				
Test item:	Radiated Emission	Power:	AC 120V/60Hz				
Model Number:	WB101U	Temp.(°C)/Hum.(%RH):	26(°C)/60%RH				
Mode:	Mode 2	Date:	08/19/2016				
Frequency:	2462MHz	Test By:	Eric Ou Yang				
Frequency (MHz)	Reading (dBuV)	Correct Factor (dB/m)	Result (dBuV/m)	Limit (dBuV/m)	Margin (dB)	Remark	Ant.Polar. H / V
4924.000	52.73	-7.50	45.23	74.00	-28.77	peak	H
4924.000	54.09	-7.50	46.59	74.00	-27.41	peak	V

Standard:	FCC Part 15C	Test Distance:	3m				
Test item:	Radiated Emission	Power:	AC 120V/60Hz				
Model Number:	WB101U	Temp.(°C)/Hum.(%RH):	26(°C)/60%RH				
Mode:	Mode 3	Date:	08/19/2016				
Frequency:	2412MHz	Test By:	Eric Ou Yang				
Frequency (MHz)	Reading (dBuV)	Correct Factor (dB/m)	Result (dBuV/m)	Limit (dBuV/m)	Margin (dB)	Remark	Ant.Polar. H / V
4824.000	50.57	-7.55	43.02	74.00	-30.98	peak	H
4824.000	53.11	-7.55	45.56	74.00	-28.44	peak	V

Note:1.Result (dBuV) = Correction factor (dB) + Reading(dBuV).

2.Correction factor (dB/m) = Antenna Factor (dB/m) + Cable loss (dB) – Pre-Amplifier gain (dB).



Standard:	FCC Part 15C	Test Distance:	3m				
Test item:	Radiated Emission	Power:	AC 120V/60Hz				
Model Number:	WB101U	Temp.(°C)/Hum.(%RH):	26(°C)/60%RH				
Mode:	Mode 3	Date:	08/19/2016				
Frequency:	2437MHz	Test By:	Eric Ou Yang				
Frequency (MHz)	Reading (dBuV)	Correct Factor (dB/m)	Result (dBuV/m)	Limit (dBuV/m)	Margin (dB)	Remark	Ant.Polar. H / V
4874.000	50.65	-7.51	43.14	74.00	-30.86	peak	H
4874.000	51.86	-7.51	44.35	74.00	-29.65	peak	V

Standard:	FCC Part 15C	Test Distance:	3m				
Test item:	Radiated Emission	Power:	AC 120V/60Hz				
Model Number:	WB101U	Temp.(°C)/Hum.(%RH):	26(°C)/60%RH				
Mode:	Mode 3	Date:	08/19/2016				
Frequency:	2462MHz	Test By:	Eric Ou Yang				
Frequency (MHz)	Reading (dBuV)	Correct Factor (dB/m)	Result (dBuV/m)	Limit (dBuV/m)	Margin (dB)	Remark	Ant.Polar. H / V
4924.000	50.52	-7.50	43.02	74.00	-30.98	peak	H
4924.000	51.08	-7.50	43.58	74.00	-30.42	peak	V

Note:1.Result (dBuV) = Correction factor (dB) + Reading(dBuV).

2.Correction factor (dB/m) = Antenna Factor (dB/m) + Cable loss (dB) – Pre-Amplifier gain (dB).



Standard: FCC Part 15C		Test Distance: 3m					
Test item: Radiated Emission		Power: AC 120V/60Hz					
Model Number: WB101U		Temp.(°C)/Hum.(%RH): 26(°C)/60%RH					
Mode: Mode 4		Date: 08/19/2016					
Frequency: 2412MHz		Test By: Eric Ou Yang					
Frequency (MHz)	Reading (dBuV)	Correct Factor (dB/m)	Result (dBuV/m)	Limit (dBuV/m)	Margin (dB)	Remark	Ant.Polar. H / V
4824.000	48.78	-7.55	41.23	74.00	-32.77	peak	H
4824.000	53.00	-7.55	45.45	74.00	-28.55	peak	V

Standard: FCC Part 15C		Test Distance: 3m					
Test item: Radiated Emission		Power: AC 120V/60Hz					
Model Number: WB101U		Temp.(°C)/Hum.(%RH): 26(°C)/60%RH					
Mode: Mode 4		Date: 08/19/2016					
Frequency: 2437MHz		Test By: Eric Ou Yang					
Frequency (MHz)	Reading (dBuV)	Correct Factor (dB/m)	Result (dBuV/m)	Limit (dBuV/m)	Margin (dB)	Remark	Ant.Polar. H / V
4874.000	49.01	-7.51	41.50	74.00	-32.50	peak	H
4874.000	50.83	-7.51	43.32	74.00	-30.68	peak	V

Note:1.Result (dBuV) = Correction factor (dB) + Reading(dBuV).

2.Correction factor (dB/m) = Antenna Factor (dB/m) + Cable loss (dB) – Pre-Amplifier gain (dB).



Standard:	FCC Part 15C	Test Distance:	3m				
Test item:	Radiated Emission	Power:	AC 120V/60Hz				
Model Number:	WB101U	Temp.(°C)/Hum.(%RH):	26(°C)/60%RH				
Mode:	Mode 4	Date:	08/19/2016				
Frequency:	2462MHz	Test By:	Eric Ou Yang				
Frequency (MHz)	Reading (dBuV)	Correct Factor (dB/m)	Result (dBuV/m)	Limit (dBuV/m)	Margin (dB)	Remark	Ant.Polar. H / V
4924.000	49.84	-7.50	42.34	74.00	-31.66	peak	H
4924.000	50.81	-7.50	43.31	74.00	-30.69	peak	V

Standard:	FCC Part 15C	Test Distance:	3m				
Test item:	Radiated Emission	Power:	AC 120V/60Hz				
Model Number:	WB101U	Temp.(°C)/Hum.(%RH):	26(°C)/60%RH				
Mode:	Mode 5	Date:	08/19/2016				
Frequency:	2422MHz	Test By:	Eric Ou Yang				
Frequency (MHz)	Reading (dBuV)	Correct Factor (dB/m)	Result (dBuV/m)	Limit (dBuV/m)	Margin (dB)	Remark	Ant.Polar. H / V
4844.000	48.98	-7.54	41.44	74.00	-32.56	peak	H
4844.000	50.97	-7.54	43.43	74.00	-30.57	peak	V

Note:1.Result (dBuV) = Correction factor (dB) + Reading(dBuV).

2.Correction factor (dB/m) = Antenna Factor (dB/m) + Cable loss (dB) – Pre-Amplifier gain (dB).



Standard:	FCC Part 15C			Test Distance:	3m		
Test item:	Radiated Emission			Power:	AC 120V/60Hz		
Model Number:	WB101U			Temp.(°C)/Hum.(%RH):	26(°C)/60%RH		
Mode:	Mode 5			Date:	08/19/2016		
Frequency:	2437MHz			Test By:	Eric Ou Yang		
Frequency (MHz)	Reading (dBuV)	Correct Factor (dB/m)	Result (dBuV/m)	Limit (dBuV/m)	Margin (dB)	Remark	Ant.Polar. H / V
4874.000	49.42	-7.51	41.91	74.00	-32.09	peak	H
4874.000	50.90	-7.51	43.39	74.00	-30.61	peak	V

Standard:	FCC Part 15C			Test Distance:	3m		
Test item:	Radiated Emission			Power:	AC 120V/60Hz		
Model Number:	WB101U			Temp.(°C)/Hum.(%RH):	26(°C)/60%RH		
Mode:	Mode 5			Date:	08/19/2016		
Frequency:	2452MHz			Test By:	Eric Ou Yang		
Frequency (MHz)	Reading (dBuV)	Correct Factor (dB/m)	Result (dBuV/m)	Limit (dBuV/m)	Margin (dB)	Remark	Ant.Polar. H / V
4904.000	49.42	-7.49	41.93	74.00	-32.07	peak	H
4904.000	49.63	-7.49	42.14	74.00	-31.86	peak	V

Note:1.Result (dBuV) = Correction factor (dB) + Reading(dBuV).

2.Correction factor (dB/m) = Antenna Factor (dB/m) + Cable loss (dB) – Pre-Amplifier gain (dB).



Band Edge

Standard:	FCC Part 15C	Test Distance:	3m
Test item:	Radiated Emission	Power:	AC 120V/60Hz
Model Number:	WB101U	Temp.(°C)/Hum.(%RH):	26(°C)/60%RH
Mode:	Mode 2	Date:	08/19/2016
Frequency:	2412 MHz	Test By:	Eric Ou Yang
Ant.Polar.:	Horizontal		

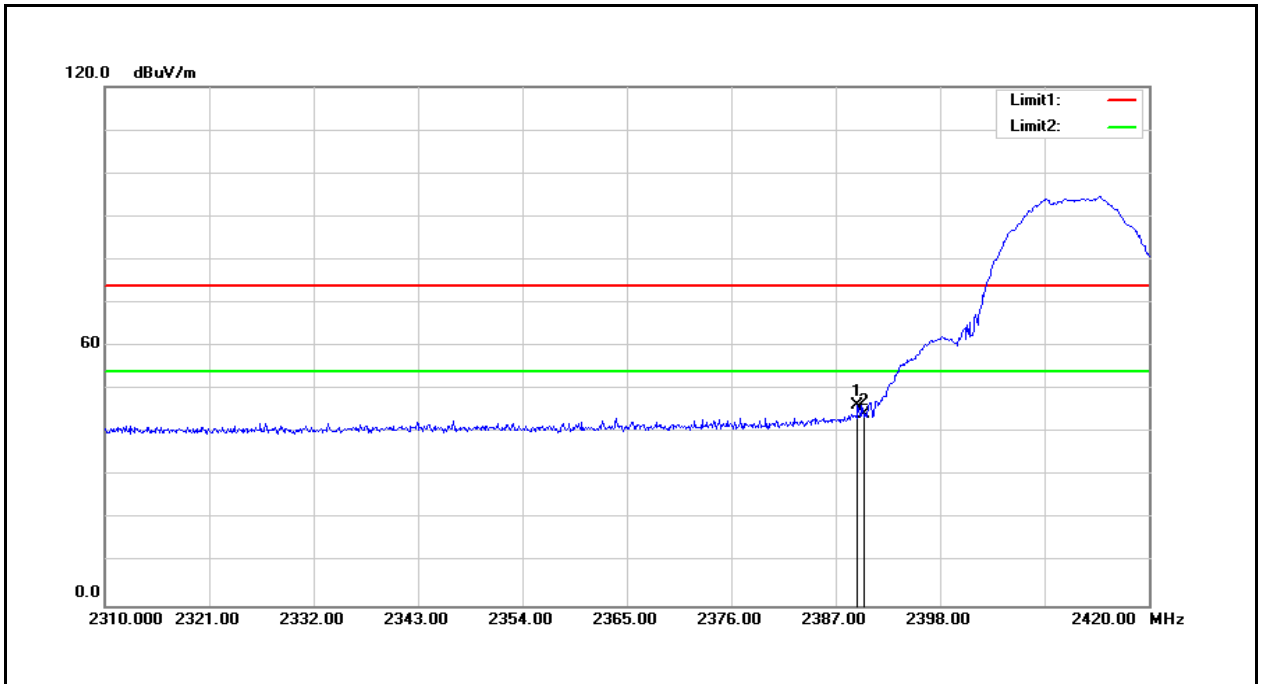

No.	Frequency (MHz)	Reading (dBuV)	Correct Factor (dB/m)	Result (dBuV/m)	Limit (dBuV/m)	Margin (dB)	Remark
1	2389.310	56.81	-10.32	46.49	74.00	-27.51	peak
2	2390.000	54.66	-10.32	44.34	74.00	-29.66	peak

Note:1.Result (dBuV) = Correction factor (dB) + Reading(dBuV).

2.Corrected factor (dB/m) = Antenna Factor (dB/m) + Cable loss (dB) – Pre-Amplifier gain (dB).



Standard:	FCC Part 15C	Test Distance:	3m
Test item:	Radiated Emission	Power:	AC 120V/60Hz
Model Number:	WB101U	Temp.(°C)/Hum.(%RH):	26(°C)/60%RH
Mode:	Mode 2	Date:	08/19/2016
Frequency:	2412 MHz	Test By:	Eric Ou Yang
Ant.Polar.:	Vertical		

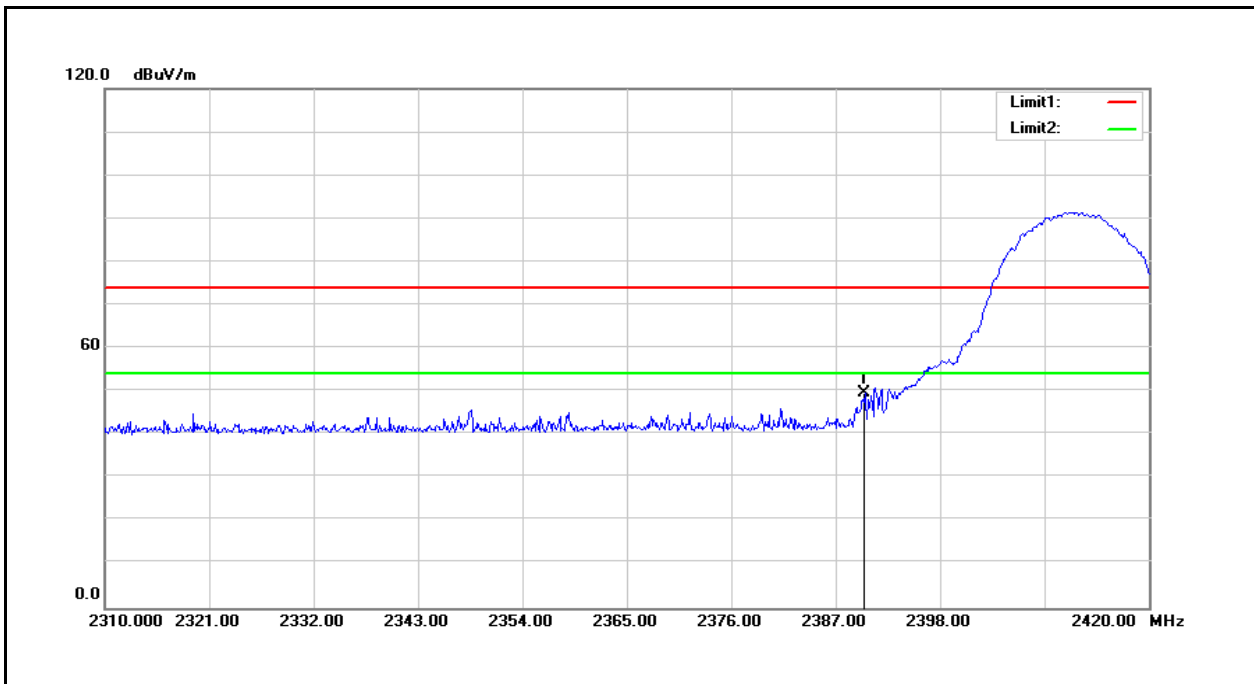

No.	Frequency (MHz)	Reading (dBuV)	Correct Factor (dB/m)	Result (dBuV/m)	Limit (dBuV/m)	Margin (dB)	Remark
1	2390.000	59.83	-10.32	49.51	74.00	-24.49	peak

Note:1.Result (dBuV) = Correction factor (dB) + Reading(dBuV).

2.Correction factor (dB/m) = Antenna Factor (dB/m) + Cable loss (dB) – Pre-Amplifier gain (dB).



Standard:	FCC Part 15C	Test Distance:	3m
Test item:	Radiated Emission	Power:	AC 120V/60Hz
Model Number:	WB101U	Temp.(°C)/Hum.(%RH):	26(°C)/60%RH
Mode:	Mode 2	Date:	08/19/2016
Frequency:	2462 MHz	Test By:	Eric Ou Yang
Ant.Polar.:	Horizontal		

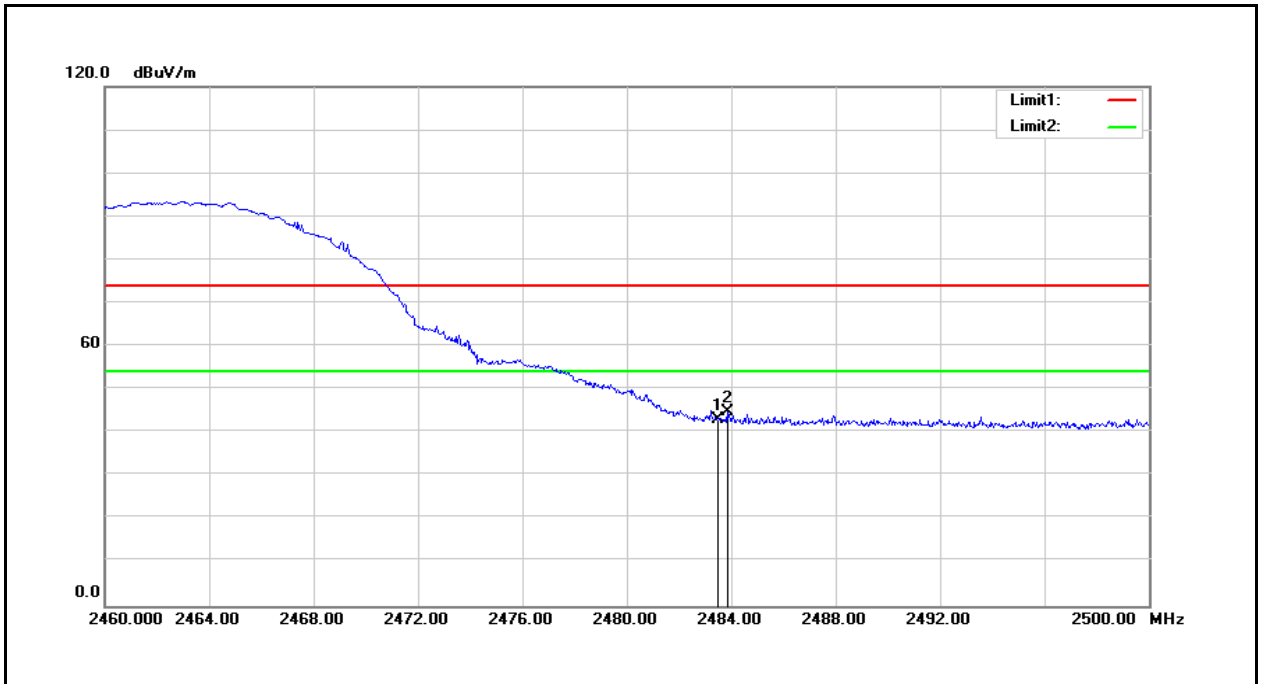

No.	Frequency (MHz)	Reading (dBuV)	Correct Factor (dB/m)	Result (dBuV/m)	Limit (dBuV/m)	Margin (dB)	Remark
1	2483.500	53.07	-10.02	43.05	74.00	-30.95	peak
2	2483.840	54.84	-10.02	44.82	74.00	-29.18	peak

Note:1.Result (dBuV) = Correction factor (dB) + Reading(dBuV).

2.Corrected factor (dB/m) = Antenna Factor (dB/m) + Cable loss (dB) – Pre-Amplifier gain (dB).



Standard:	FCC Part 15C	Test Distance:	3m
Test item:	Radiated Emission	Power:	AC 120V/60Hz
Model Number:	WB101U	Temp.(°C)/Hum.(%RH):	26(°C)/60%RH
Mode:	Mode 2	Date:	08/19/2016
Frequency:	2462 MHz	Test By:	Eric Ou Yang
Ant.Polar.:	Vertical		

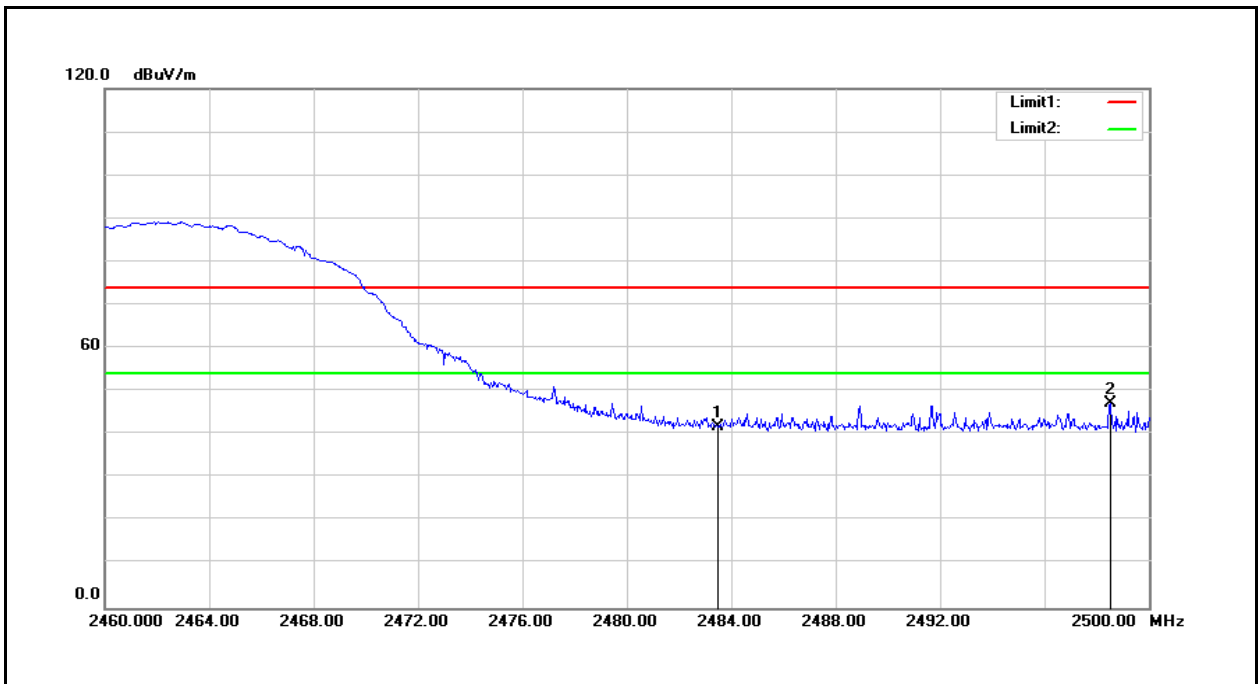

No.	Frequency (MHz)	Reading (dBuV)	Correct Factor (dB/m)	Result (dBuV/m)	Limit (dBuV/m)	Margin (dB)	Remark
1	2483.500	51.97	-10.02	41.95	74.00	-32.05	peak
2	2498.520	57.13	-9.96	47.17	74.00	-26.83	peak

Note:1.Result (dBuV) = Correction factor (dB) + Reading(dBuV).

2.Corrected factor (dB/m) = Antenna Factor (dB/m) + Cable loss (dB) – Pre-Amplifier gain (dB).



Standard:	FCC Part 15C	Test Distance:	3m
Test item:	Radiated Emission	Power:	AC 120V/60Hz
Model Number:	WB101U	Temp.(°C)/Hum.(%RH):	26(°C)/60%RH
Mode:	Mode 3	Date:	08/19/2016
Frequency:	2412 MHz	Test By:	Eric Ou Yang
Ant.Polar.:	Horizontal		

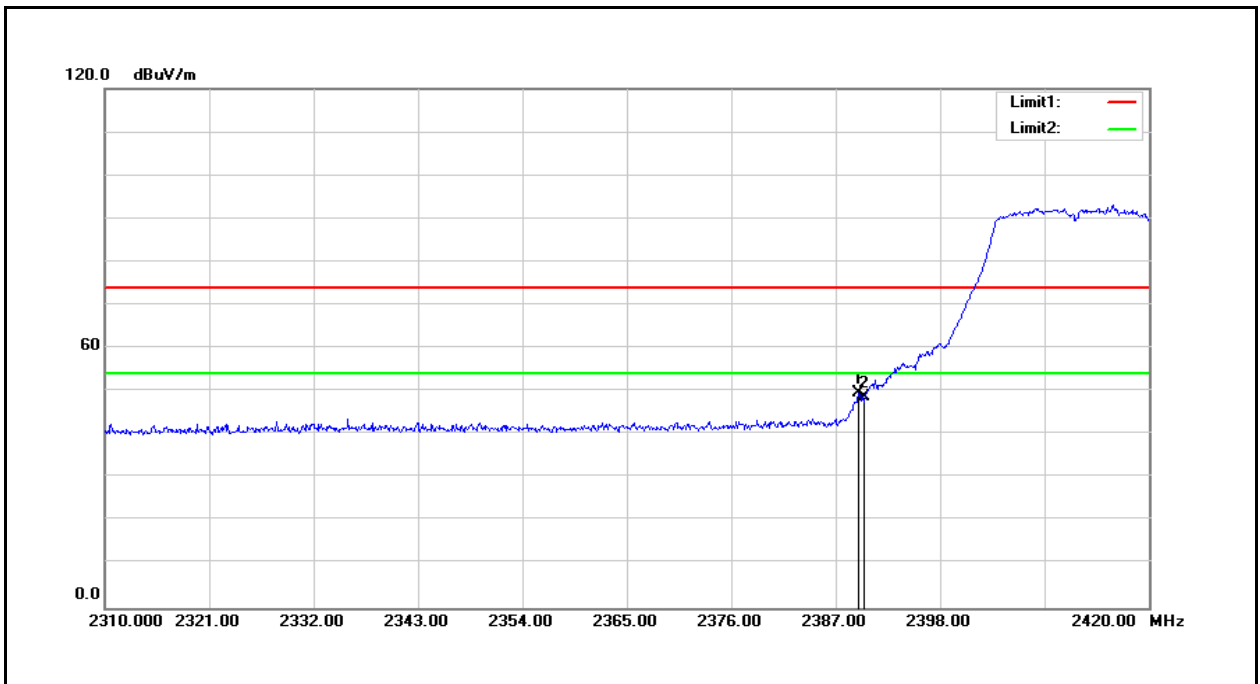

No.	Frequency (MHz)	Reading (dBuV)	Correct Factor (dB/m)	Result (dBuV/m)	Limit (dBuV/m)	Margin (dB)	Remark
1	2389.420	60.01	-10.32	49.69	74.00	-24.31	peak
2	2390.000	59.08	-10.32	48.76	74.00	-25.24	peak

Note:1.Result (dBuV) = Correction factor (dB) + Reading(dBuV).

2.Correction factor (dB/m) = Antenna Factor (dB/m) + Cable loss (dB) – Pre-Amplifier gain (dB).



Standard:	FCC Part 15C	Test Distance:	3m
Test item:	Radiated Emission	Power:	AC 120V/60Hz
Model Number:	WB101U	Temp.(°C)/Hum.(%RH):	26(°C)/60%RH
Mode:	Mode 3	Date:	08/19/2016
Frequency:	2412 MHz	Test By:	Eric Ou Yang
Ant.Polar.:	Vertical		

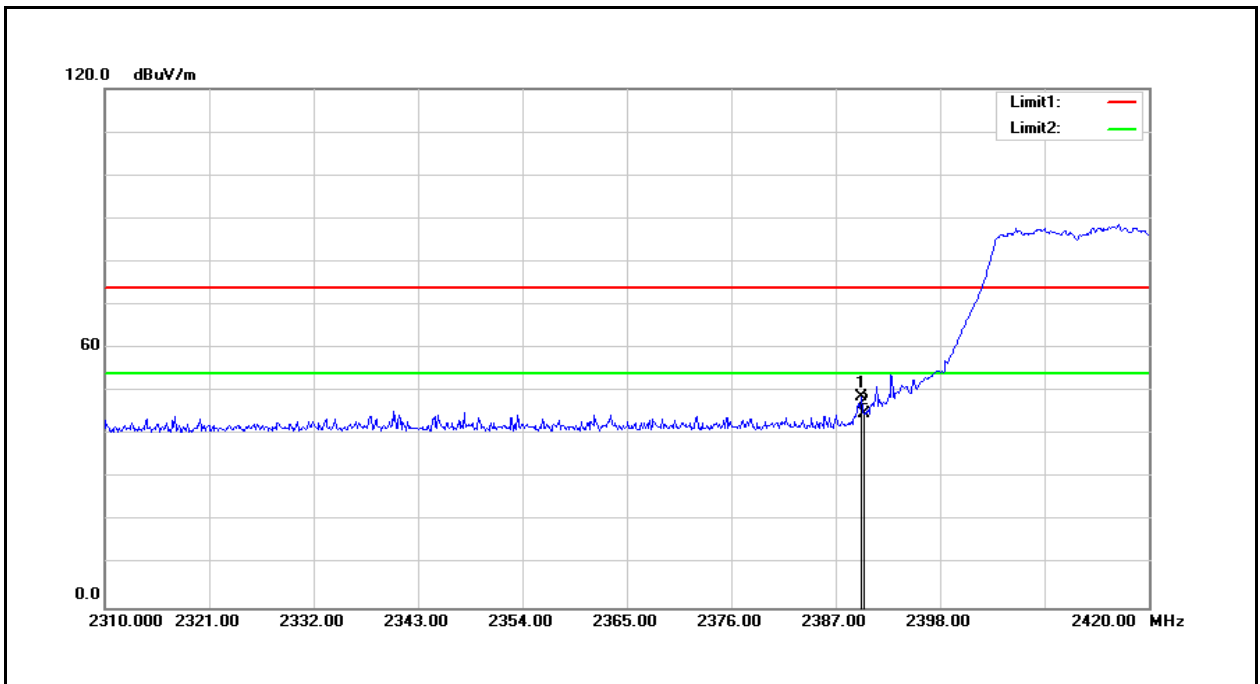

No.	Frequency (MHz)	Reading (dBuV)	Correct Factor (dB/m)	Result (dBuV/m)	Limit (dBuV/m)	Margin (dB)	Remark
1	2389.750	59.16	-10.32	48.84	74.00	-25.16	peak
2	2390.000	55.05	-10.32	44.73	74.00	-29.27	peak

Note:1.Result (dBuV) = Correction factor (dB) + Reading(dBuV).

2.Corrected factor (dB/m) = Antenna Factor (dB/m) + Cable loss (dB) – Pre-Amplifier gain (dB).



Standard:	FCC Part 15C	Test Distance:	3m
Test item:	Radiated Emission	Power:	AC 120V/60Hz
Model Number:	WB101U	Temp.(°C)/Hum.(%RH):	26(°C)/60%RH
Mode:	Mode 3	Date:	08/19/2016
Frequency:	2462 MHz	Test By:	Eric Ou Yang
Ant.Polar.:	Horizontal		

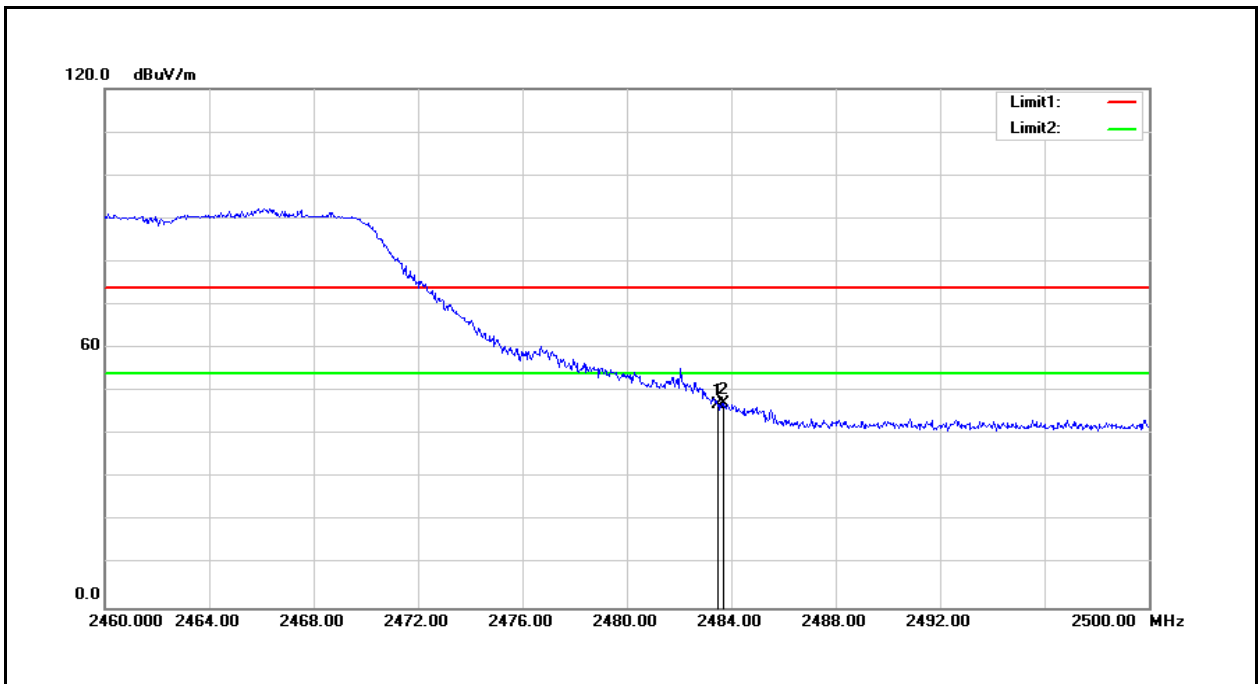

No.	Frequency (MHz)	Reading (dBuV)	Correct Factor (dB/m)	Result (dBuV/m)	Limit (dBuV/m)	Margin (dB)	Remark
1	2483.500	57.03	-10.02	47.01	74.00	-26.99	peak
2	2483.680	57.20	-10.02	47.18	74.00	-26.82	peak

Note:1.Result (dBuV) = Correction factor (dB) + Reading(dBuV).

2.Corrected factor (dB/m) = Antenna Factor (dB/m) + Cable loss (dB) – Pre-Amplifier gain (dB).



Standard:	FCC Part 15C	Test Distance:	3m
Test item:	Radiated Emission	Power:	AC 120V/60Hz
Model Number:	WB101U	Temp.(°C)/Hum.(%RH):	26(°C)/60%RH
Mode:	Mode 3	Date:	08/19/2016
Frequency:	2462 MHz	Test By:	Eric Ou Yang
Ant.Polar.:	Vertical		

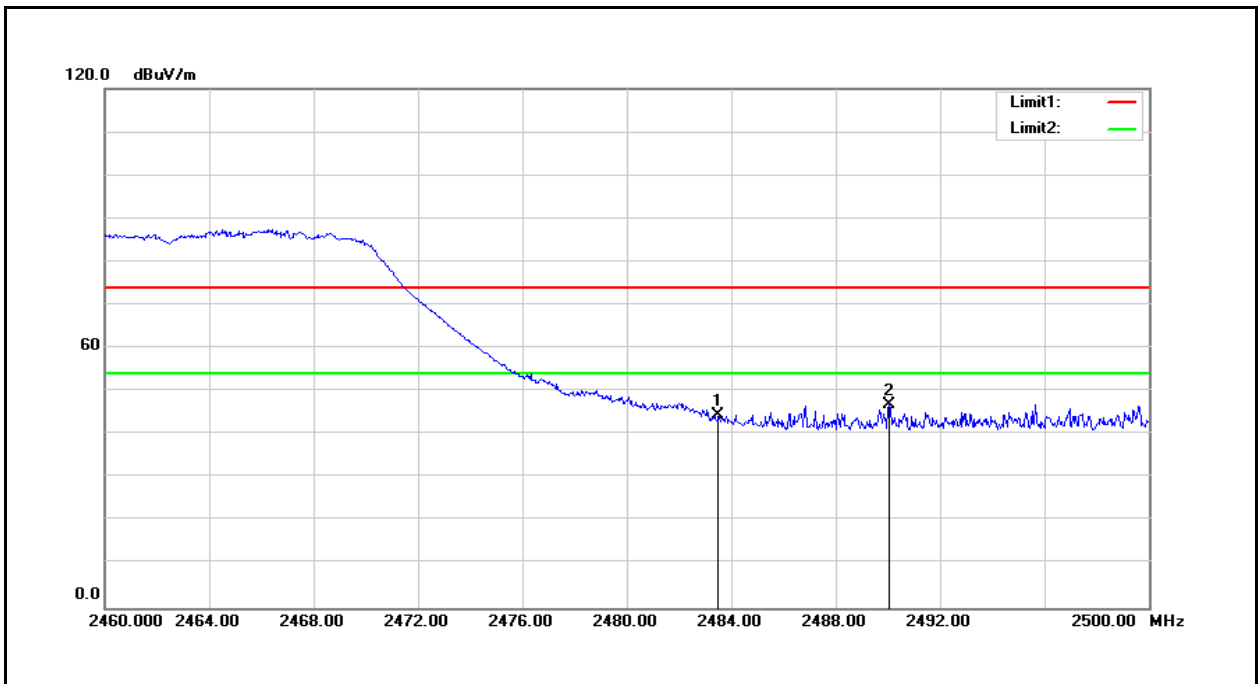

No.	Frequency (MHz)	Reading (dBuV)	Correct Factor (dB/m)	Result (dBuV/m)	Limit (dBuV/m)	Margin (dB)	Remark
1	2483.500	54.58	-10.02	44.56	74.00	-29.44	peak
2	2490.040	57.10	-10.00	47.10	74.00	-26.90	peak

Note:1.Result (dBuV) = Correction factor (dB) + Reading(dBuV).

2.Correction factor (dB/m) = Antenna Factor (dB/m) + Cable loss (dB) – Pre-Amplifier gain (dB).



Standard:	FCC Part 15C	Test Distance:	3m
Test item:	Radiated Emission	Power:	AC 120V/60Hz
Model Number:	WB101U	Temp.(°C)/Hum.(%RH):	26(°C)/60%RH
Mode:	Mode 4	Date:	08/19/2016
Frequency:	2412 MHz	Test By:	Eric Ou Yang
Ant.Polar.:	Horizontal		

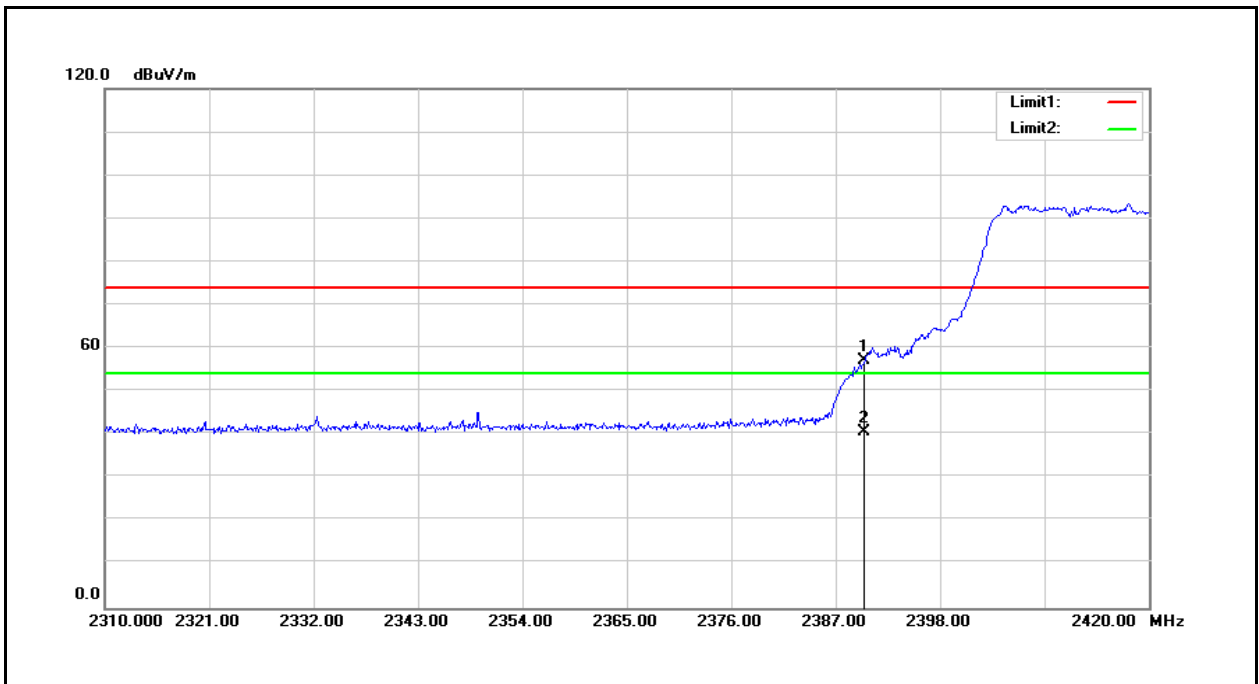

No.	Frequency (MHz)	Reading (dBuV)	Correct Factor (dB/m)	Result (dBuV/m)	Limit (dBuV/m)	Margin (dB)	Remark
1	2390.000	67.53	-10.32	57.21	74.00	-16.79	peak
2	2390.000	50.96	-10.32	40.64	54.00	-13.36	AVG

Note:1.Result (dBuV) = Correction factor (dB) + Reading(dBuV).

2.Corrected factor (dB/m) = Antenna Factor (dB/m) + Cable loss (dB) – Pre-Amplifier gain (dB).



Standard:	FCC Part 15C	Test Distance:	3m
Test item:	Radiated Emission	Power:	AC 120V/60Hz
Model Number:	WB101U	Temp.(°C)/Hum.(%RH):	26(°C)/60%RH
Mode:	Mode 4	Date:	08/19/2016
Frequency:	2412 MHz	Test By:	Eric Ou Yang
Ant.Polar.:	Vertical		

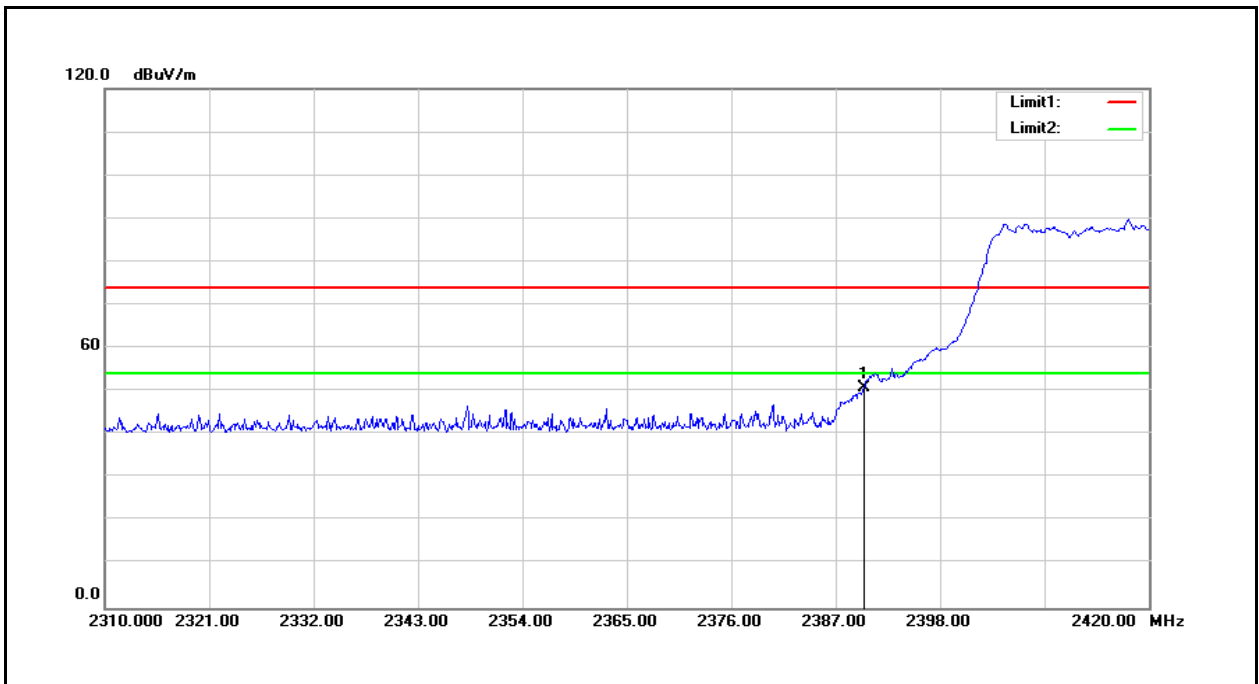

No.	Frequency (MHz)	Reading (dBuV)	Correct Factor (dB/m)	Result (dBuV/m)	Limit (dBuV/m)	Margin (dB)	Remark
1	2390.000	61.32	-10.32	51.00	74.00	-23.00	peak

Note:1.Result (dBuV) = Correction factor (dB) + Reading(dBuV).

2.Correction factor (dB/m) = Antenna Factor (dB/m) + Cable loss (dB) – Pre-Amplifier gain (dB).



Standard:	FCC Part 15C	Test Distance:	3m
Test item:	Radiated Emission	Power:	AC 120V/60Hz
Model Number:	WB101U	Temp.(°C)/Hum.(%RH):	26(°C)/60%RH
Mode:	Mode 4	Date:	08/19/2016
Frequency:	2462 MHz	Test By:	Eric Ou Yang
Ant.Polar.:	Horizontal		

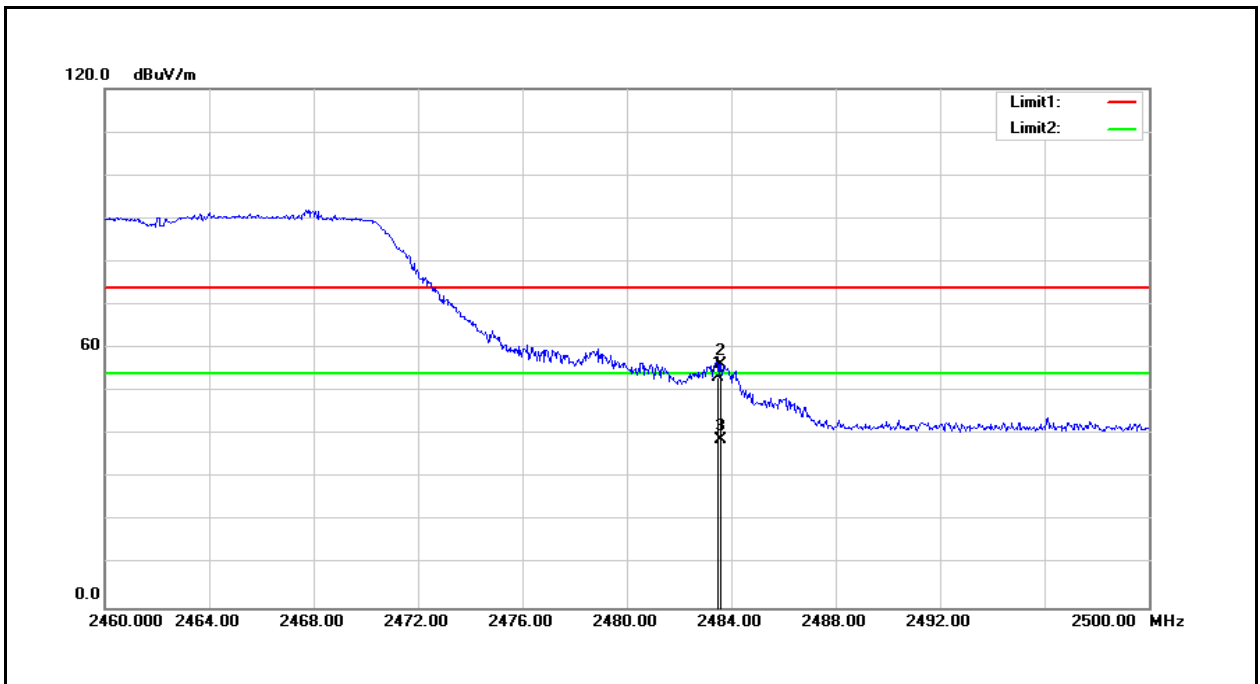

No.	Frequency (MHz)	Reading (dBuV)	Correct Factor (dB/m)	Result (dBuV/m)	Limit (dBuV/m)	Margin (dB)	Remark
1	2483.500	63.32	-10.02	53.30	74.00	-20.70	peak
2	2483.600	66.27	-10.02	56.25	74.00	-17.75	peak
3	2483.600	48.78	-10.02	38.76	54.00	-15.24	AVG

Note:1.Result (dBuV) = Correction factor (dB) + Reading(dBuV).

2.Correction factor (dB/m) = Antenna Factor (dB/m) + Cable loss (dB) – Pre-Amplifier gain (dB).



Standard:	FCC Part 15C	Test Distance:	3m
Test item:	Radiated Emission	Power:	AC 120V/60Hz
Model Number:	WB101U	Temp.(°C)/Hum.(%RH):	26(°C)/60%RH
Mode:	Mode 4	Date:	08/19/2016
Frequency:	2462 MHz	Test By:	Eric Ou Yang
Ant.Polar.:	Vertical		

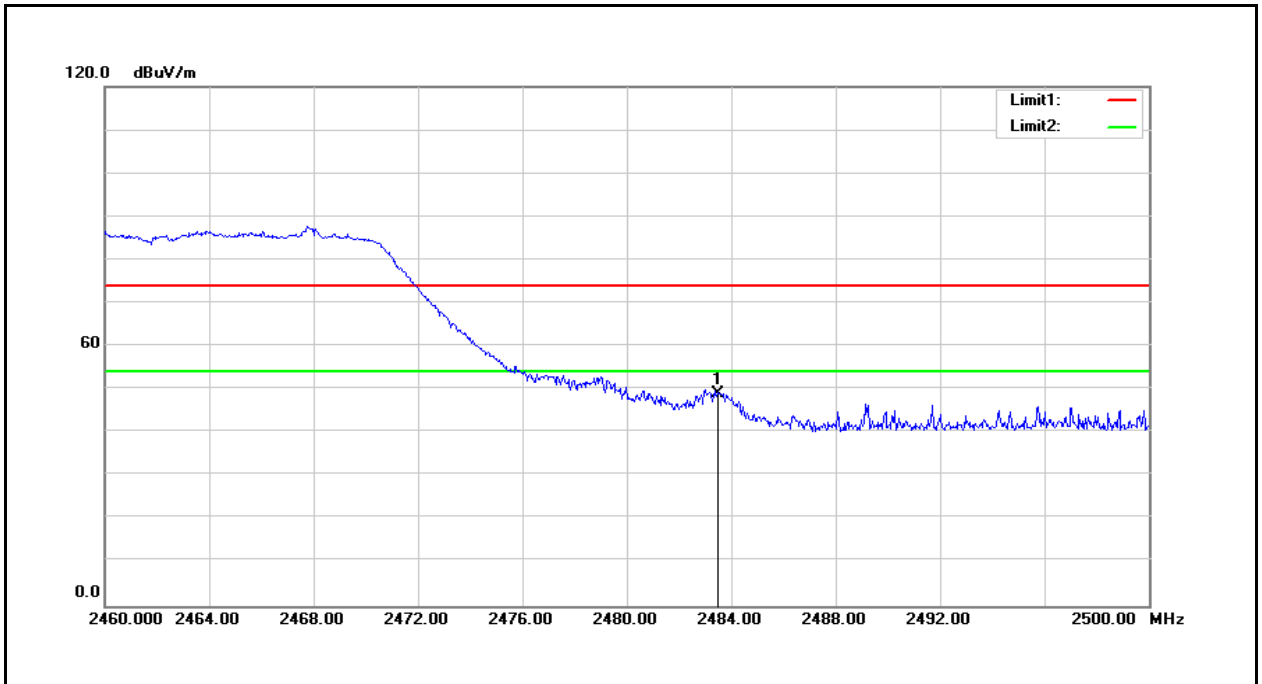

No.	Frequency (MHz)	Reading (dBuV)	Correct Factor (dB/m)	Result (dBuV/m)	Limit (dBuV/m)	Margin (dB)	Remark
1	2483.500	59.08	-10.02	49.06	74.00	-24.94	peak

Note:1.Result (dBuV) = Correction factor (dB) + Reading(dBuV).

2.Corrected factor (dB/m) = Antenna Factor (dB/m) + Cable loss (dB) – Pre-Amplifier gain (dB).



Standard:	FCC Part 15C	Test Distance:	3m
Test item:	Radiated Emission	Power:	AC 120V/60Hz
Model Number:	WB101U	Temp.(°C)/Hum.(%RH):	26(°C)/60%RH
Mode:	Mode 5	Date:	08/19/2016
Frequency:	2422 MHz	Test By:	Eric Ou Yang
Ant.Polar.:	Horizontal		

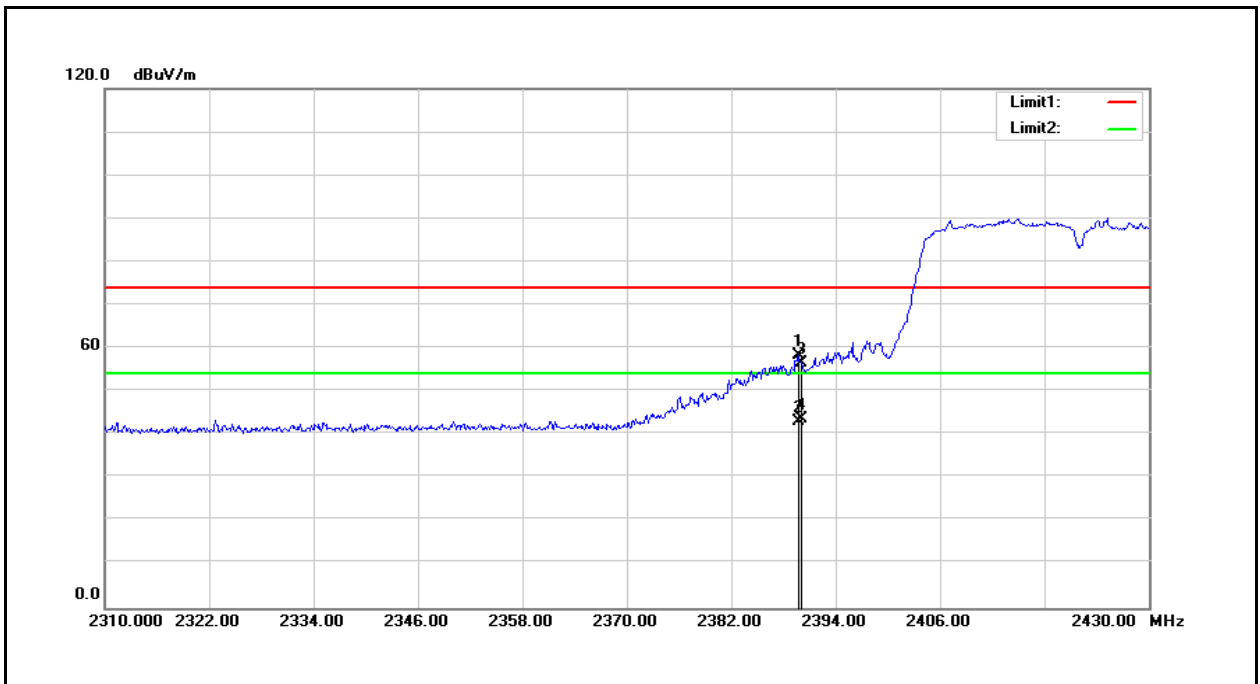

No.	Frequency (MHz)	Reading (dBuV)	Correct Factor (dB/m)	Result (dBuV/m)	Limit (dBuV/m)	Margin (dB)	Remark
1	2389.680	68.55	-10.32	58.23	74.00	-15.77	peak
2	2389.680	53.24	-10.32	42.92	54.00	-11.08	AVG
3	2390.000	66.82	-10.32	56.50	74.00	-17.50	peak
4	2390.000	54.11	-10.32	43.79	54.00	-10.21	AVG

Note:1.Result (dBuV) = Correction factor (dB) + Reading(dBuV).

2.Correction factor (dB/m) = Antenna Factor (dB/m) + Cable loss (dB) – Pre-Amplifier gain (dB).



Standard:	FCC Part 15C	Test Distance:	3m
Test item:	Radiated Emission	Power:	AC 120V/60Hz
Model Number:	WB101U	Temp.(°C)/Hum.(%RH):	26(°C)/60%RH
Mode:	Mode 5	Date:	08/19/2016
Frequency:	2422 MHz	Test By:	Eric Ou Yang
Ant.Polar.:	Vertical		

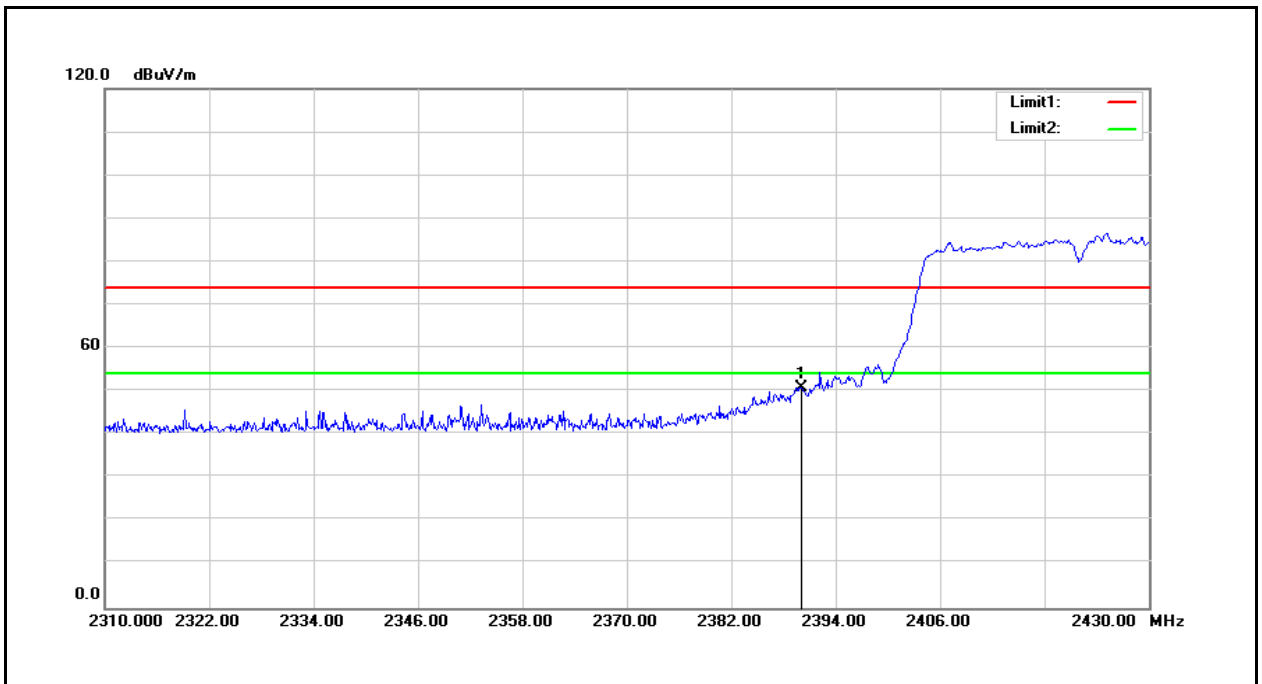

No.	Frequency (MHz)	Reading (dBuV)	Correct Factor (dB/m)	Result (dBuV/m)	Limit (dBuV/m)	Margin (dB)	Remark
1	2390.000	61.16	-10.32	50.84	74.00	-23.16	peak

Note:1.Result (dBuV) = Correction factor (dB) + Reading(dBuV).

2.Correction factor (dB/m) = Antenna Factor (dB/m) + Cable loss (dB) – Pre-Amplifier gain (dB).



Standard:	FCC Part 15C	Test Distance:	3m
Test item:	Radiated Emission	Power:	AC 120V/60Hz
Model Number:	WB101U	Temp.(°C)/Hum.(%RH):	26(°C)/60%RH
Mode:	Mode 5	Date:	08/19/2016
Frequency:	2452 MHz	Test By:	Eric Ou Yang
Ant.Polar.:	Horizontal		

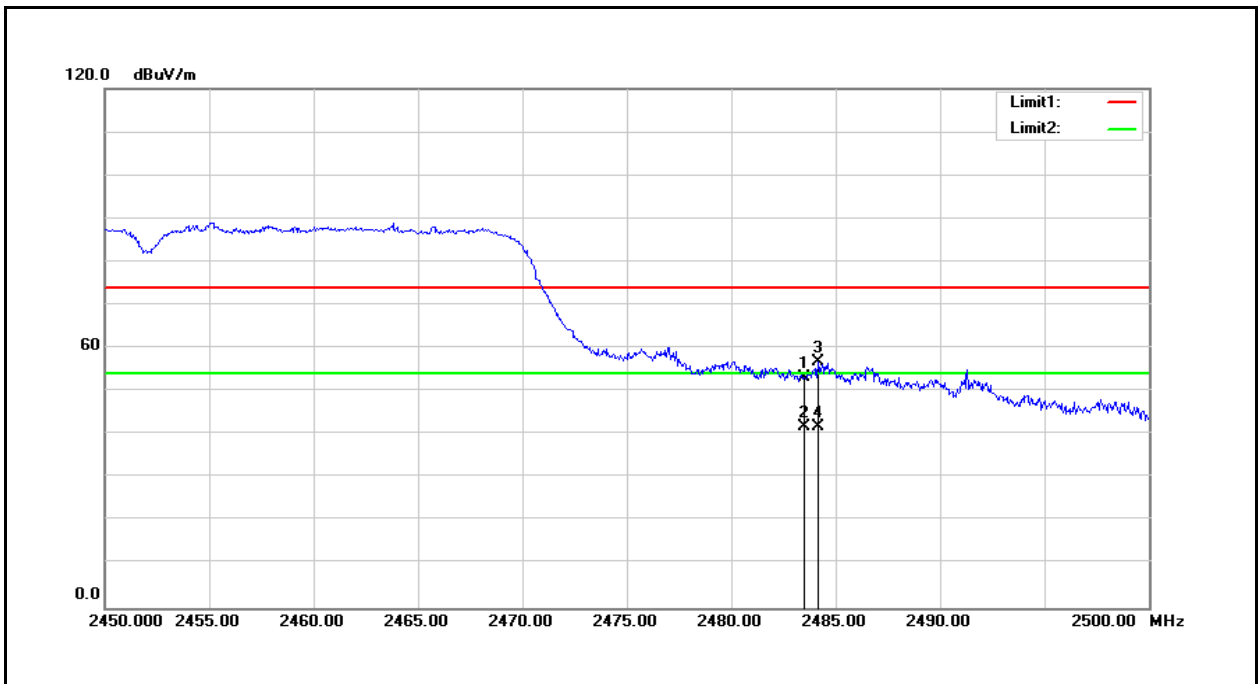

No.	Frequency (MHz)	Reading (dBuV)	Correct Factor (dB/m)	Result (dBuV/m)	Limit (dBuV/m)	Margin (dB)	Remark
1	2483.500	63.29	-10.02	53.27	74.00	-20.73	peak
2	2483.500	51.98	-10.02	41.96	54.00	-12.04	AVG
3	2484.150	66.85	-10.02	56.83	74.00	-17.17	peak
4	2484.150	51.87	-10.02	41.85	54.00	-12.15	AVG

Note:1.Result (dBuV) = Correction factor (dB) + Reading(dBuV).

2.Correction factor (dB/m) = Antenna Factor (dB/m) + Cable loss (dB) – Pre-Amplifier gain (dB).



Standard:	FCC Part 15C	Test Distance:	3m
Test item:	Radiated Emission	Power:	AC 120V/60Hz
Model Number:	WB101U	Temp.(°C)/Hum.(%RH):	26(°C)/60%RH
Mode:	Mode 5	Date:	08/19/2016
Frequency:	2452 MHz	Test By:	Eric Ou Yang
Ant.Polar.:	Vertical		

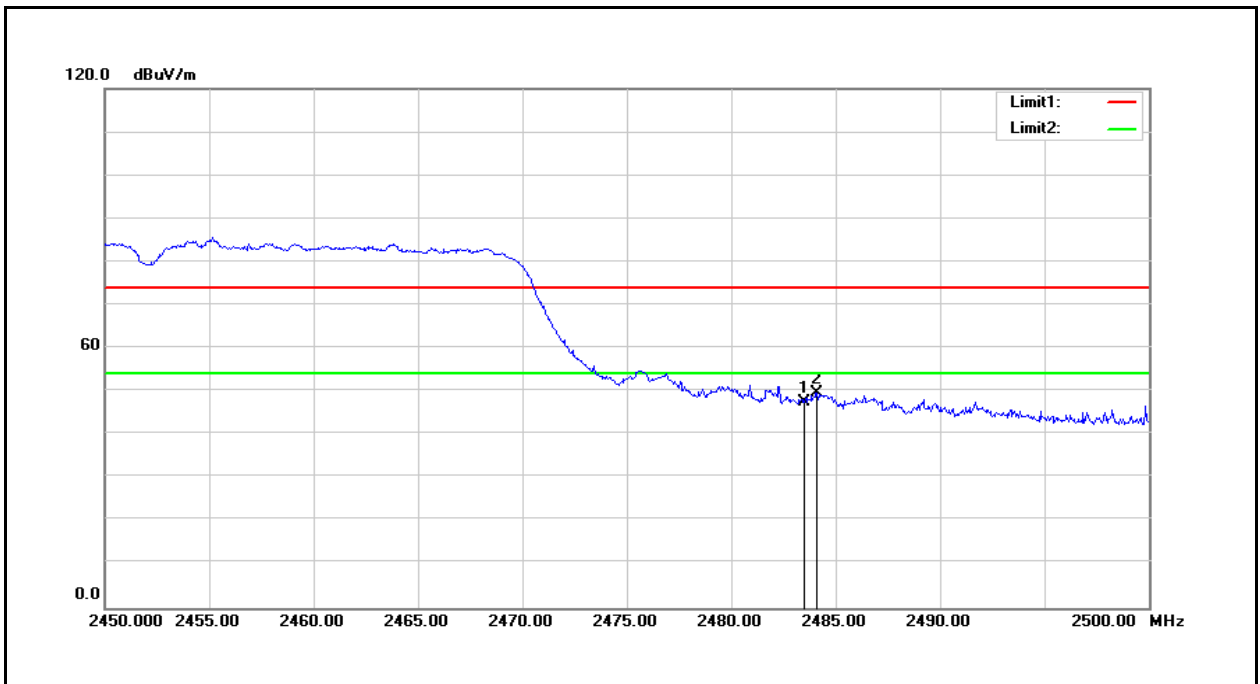

No.	Frequency (MHz)	Reading (dBuV)	Correct Factor (dB/m)	Result (dBuV/m)	Limit (dBuV/m)	Margin (dB)	Remark
1	2483.500	57.47	-10.02	47.45	74.00	-26.55	peak
2	2484.100	59.75	-10.02	49.73	74.00	-24.27	peak

Note:1.Result (dBuV) = Correction factor (dB) + Reading(dBuV).

2.Corrected factor (dB/m) = Antenna Factor (dB/m) + Cable loss (dB) – Pre-Amplifier gain (dB).

6 Maximum Conducted Output Power Measurement

6.1. Limit

For systems using digital modulation in the 2400-2483.5MHz, the limit for maximum output power is 30dBm.

6.2. Test Setup

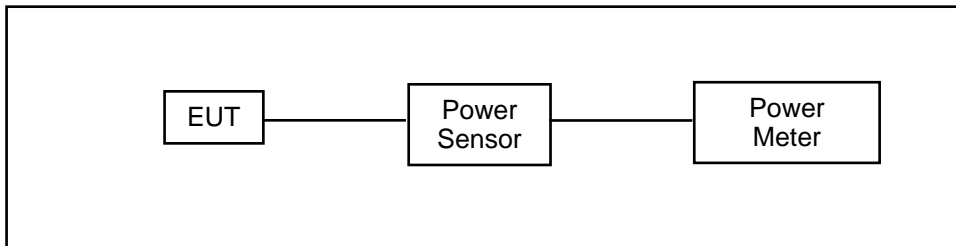

6.3. Test Instruments

Equipment	Manufacturer	Model Number	Serial Number	Cal. Date	Cal. Period
Power Sensor	Anritsu	MA2411B	1126022	08/24/2016	1 year
Power Meter	Anritsu	ML2495A	1135009	08/24/2016	1 year
Microwave Cable	EMCI	EMC104-SM-SM-1500	140303	02/23/2016	1 year
Test Site	ATL	TE05	TE05	N.C.R.	-----

Note: N.C.R. = No Calibration Request.

6.4. Test Procedure

The tests below are run with the EUT's transmitter set at high power in TX mode. The EUT is needed to force selection of output power level and channel number. While testing, EUT was set to transmit continuously. Remove the Subjective device's antenna and connect the RF output port to power sensor.



6.5. Test Result

Model Number	WB101U						
Test Item	Maximum Conducted Output Power						
Date of Test	08/12/2016						
Test Mode	Frequency (MHz)	Data Rate	Average Output Power		Peak Output Power		
			Measurement Results		Measurement Results		Limit
			dBm	W	dBm	W	dBm
Mode 2	2412	1M	10.18	0.010	13.19	0.021	< 30
	2437		9.13	0.008	12.24	0.017	< 30
	2462		9.02	0.008	12.09	0.016	< 30
Mode 3	2412	6M	5.05	0.003	12.31	0.017	< 30
	2437		4.52	0.003	11.76	0.015	< 30
	2462		4.47	0.003	11.67	0.015	< 30
Mode 4	2412	6.5M	4.38	0.003	11.77	0.015	< 30
	2437		4.69	0.003	11.98	0.016	< 30
	2462		4.55	0.003	11.92	0.016	< 30
Mode 5	2422	13.5M	4.13	0.003	11.51	0.014	< 30
	2437		3.78	0.002	11.11	0.013	< 30
	2452		3.85	0.002	11.21	0.013	< 30

Note: The relevant measured result has the offset with cable loss already.

7 6dB RF Bandwidth Measurement

7.1. Limit

6dB RF Bandwidth: Systems using digital modulation techniques may operate in the 2400–2483.5 MHz bands. The minimum 6 dB band-width shall be at least 500 kHz.

7.2. Test Setup

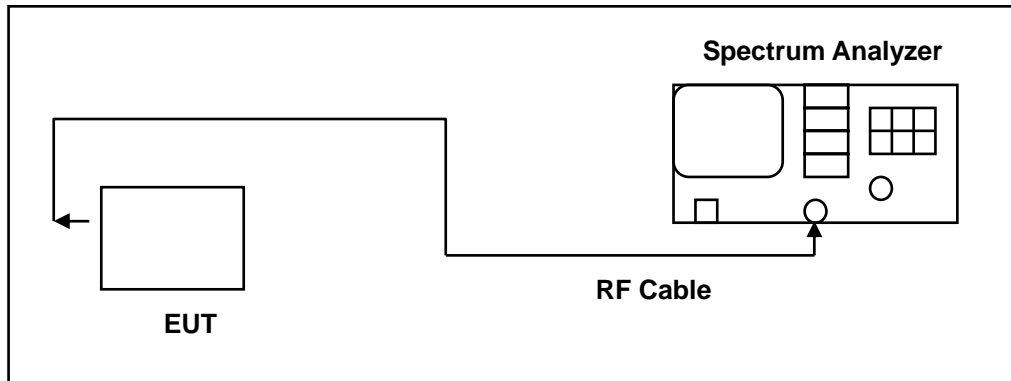

7.3. Test Instruments

Equipment	Manufacturer	Model Number	Serial Number	Cal. Date	Cal. Period
Spectrum Analyzer	Agilent	E4445A	MY45300744	12/15/2015	1 year
Microwave Cable	EMCI	EMC104-SM-SM-1500	140303	02/23/2016	1 year
Test Site	ATL	TE05	TE05	N.C.R.	-----

Note: N.C.R. = No Calibration Request.

7.4. Test Procedure

The EUT tested to DTS test procedure of KDB558074D01 for compliance to FCC 47CFR 15.247 requirements.

6dB RF Bandwidth: The antenna port of the EUT was connected to the input of a spectrum analyzer. Analyzer RBW was set to 100 kHz. For each RF output channel investigated, the spectrum analyzer center frequency was set to the channel carrier. A peak output reading was taken, a DISPLAY line was drawn 6 dB lower than peak level. The 6 dB bandwidth was determined from where the channel output spectrum intersected the display line.

The test was performed at 3 channels (Channel low, middle, high)

**7.5. Test Result**

Model Number	WB101U		
Test Item	6dB RF Bandwidth		
Date of Test	08/12/2016		
Test Mode	Frequency (MHz)	Measurement (kHz)	Limit (kHz)
Mode 2	2412	10020	> 500
	2437	10030	> 500
	2462	9545	> 500
Mode 3	2412	16330	> 500
	2437	16330	> 500
	2462	16340	> 500
Mode 4	2412	17560	> 500
	2437	17570	> 500
	2462	17570	> 500
Mode 5	2422	35310	> 500
	2437	35140	> 500
	2452	35130	> 500



7.6. Test Graphs

Mode 2: IEEE 802.11b link mode	
2412 MHz	<p>Center Freq 2.41200000 GHz</p> <p>Center Freq: 2.412000000 GHz</p> <p>Ref Offset 16.68 dB</p> <p>Ref 30.00 dBm</p> <p>Center: 2.412 GHz</p> <p>#Res BW 100 kHz</p> <p>#VBW 300 kHz</p> <p>Span 40 MHz</p> <p>Sweep 4.267 ms</p> <p>Occupied Bandwidth 15.157 MHz</p> <p>Total Power 17.1 dBm</p> <p>Transmit Freq Error 59.391 kHz</p> <p>OBW Power 99.00 %</p> <p>x dB Bandwidth 10.02 MHz</p> <p>x dB -6.00 dB</p>
2437 MHz	<p>Center Freq 2.43700000 GHz</p> <p>Center Freq: 2.437000000 GHz</p> <p>Ref Offset 16.68 dB</p> <p>Ref 30.00 dBm</p> <p>Center: 2.437 GHz</p> <p>#Res BW 100 kHz</p> <p>#VBW 300 kHz</p> <p>Span 40 MHz</p> <p>Sweep 4.267 ms</p> <p>Occupied Bandwidth 15.258 MHz</p> <p>Total Power 16.0 dBm</p> <p>Transmit Freq Error 139.57 kHz</p> <p>OBW Power 99.00 %</p> <p>x dB Bandwidth 10.03 MHz</p> <p>x dB -6.00 dB</p>
2462 MHz	<p>Center Freq 2.46200000 GHz</p> <p>Center Freq: 2.462000000 GHz</p> <p>Ref Offset 16.68 dB</p> <p>Ref 30.00 dBm</p> <p>Center: 2.462 GHz</p> <p>#Res BW 100 kHz</p> <p>#VBW 300 kHz</p> <p>Span 40 MHz</p> <p>Sweep 4.267 ms</p> <p>Occupied Bandwidth 15.230 MHz</p> <p>Total Power 16.1 dBm</p> <p>Transmit Freq Error 118.43 kHz</p> <p>OBW Power 99.00 %</p> <p>x dB Bandwidth 9.545 MHz</p> <p>x dB -6.00 dB</p>



Mode 3: IEEE 802.11g link mode

2412 MHz

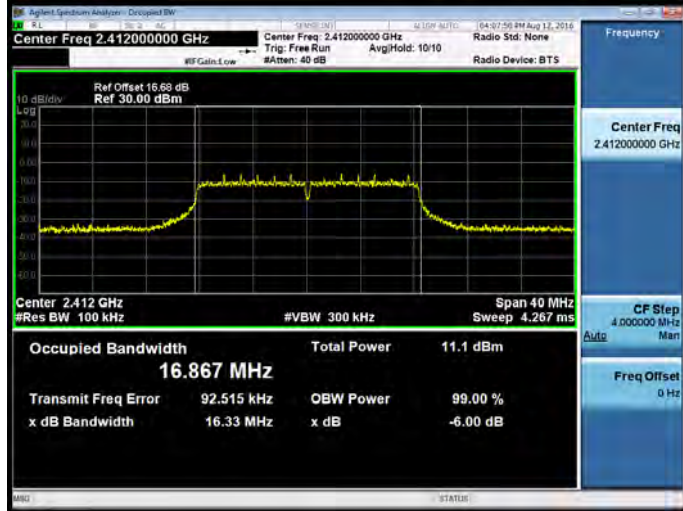

2437 MHz

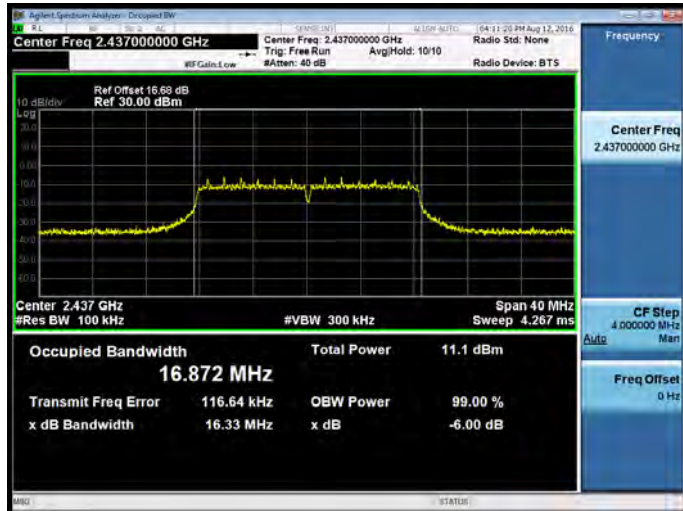

2462 MHz

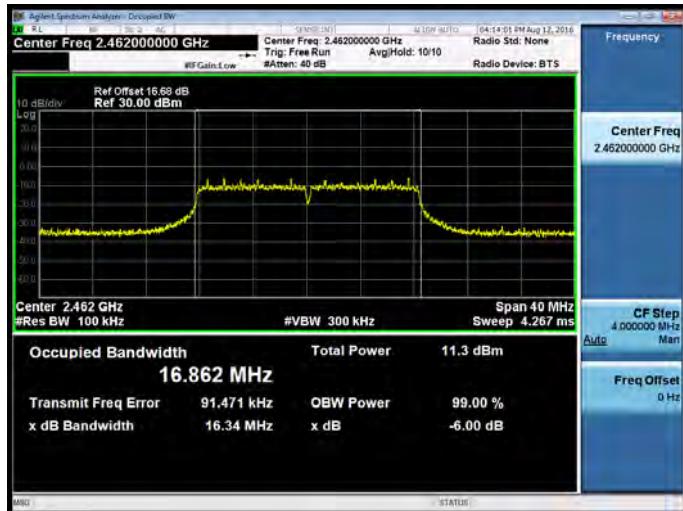



Mode 4: IEEE 802.11n 2.4GHz 20MHz link mode

2412 MHz

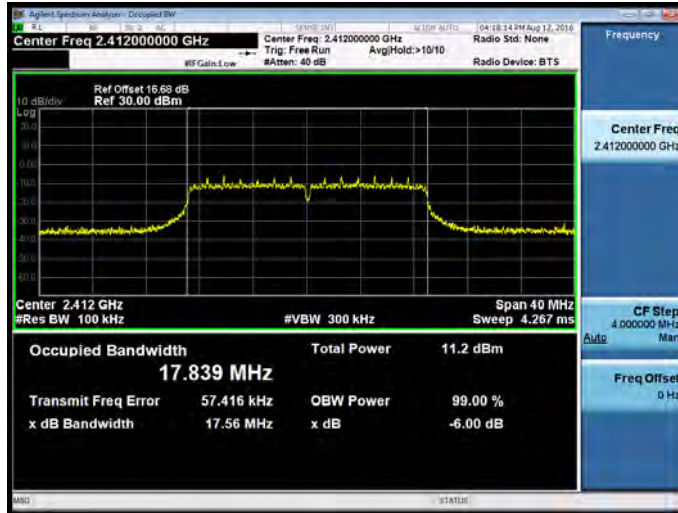

2437 MHz

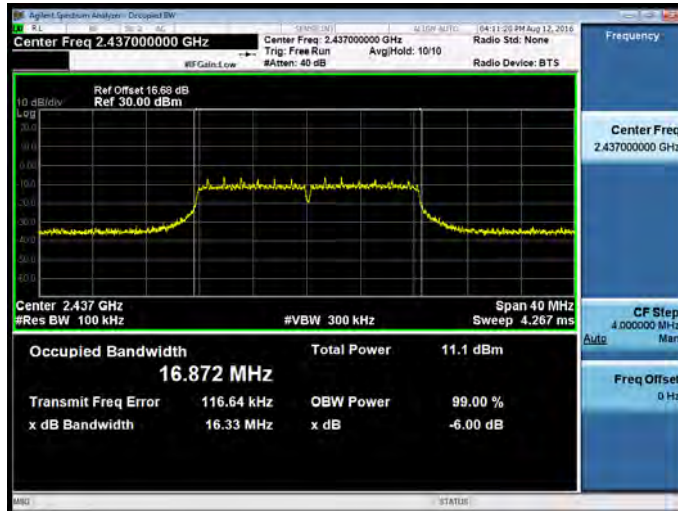

2462 MHz

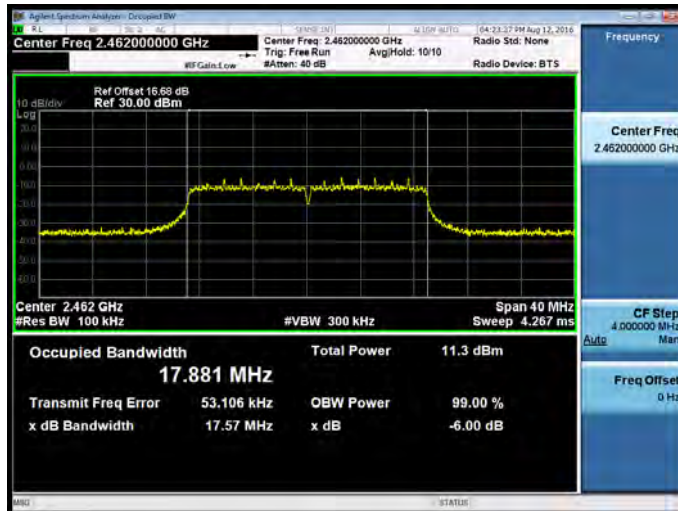



Mode 5: IEEE 802.11n 2.4GHz 40MHz link mode

2422 MHz

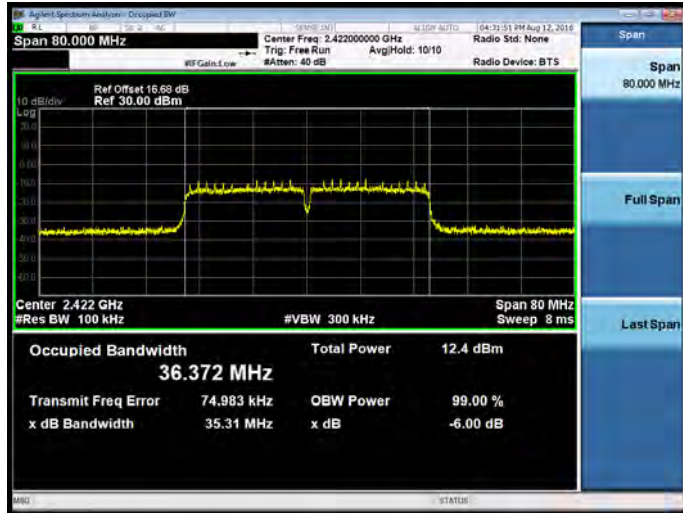

2437 MHz

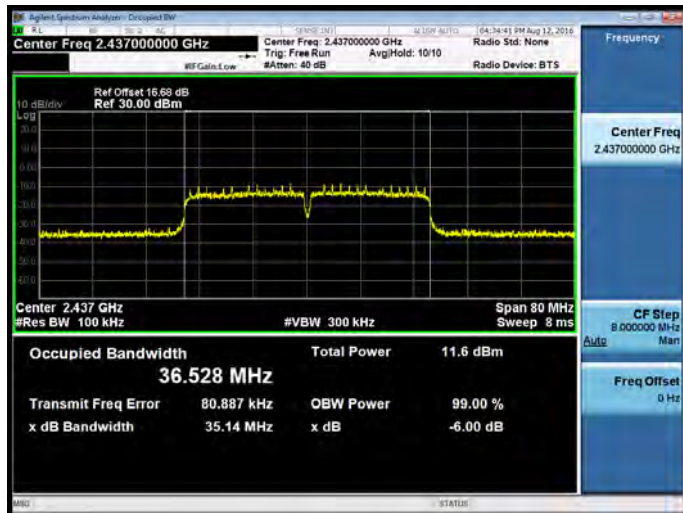

2452 MHz

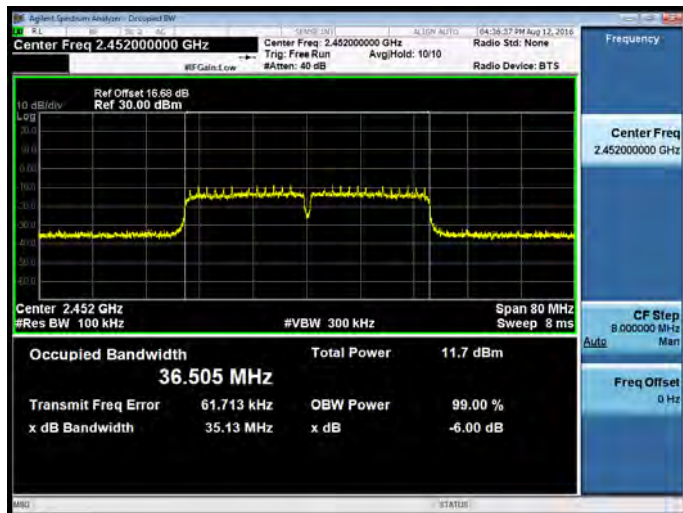

8 Maximum Power Density Measurement

8.1. Limit

For digitally modulated systems, the power spectral density conducted from the intentional radiator to the antenna shall not be greater than 8 dBm in any 3 kHz band during any time interval of continuous transmission.

8.2. Test Setup

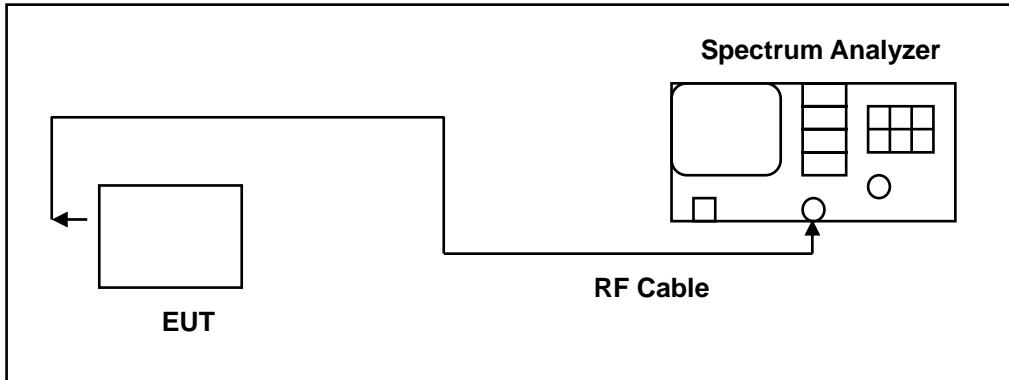

8.3. Test Instruments

Equipment	Manufacturer	Model Number	Serial Number	Cal. Date	Cal. Period
Spectrum Analyzer	Agilent	E4445A	MY45300744	12/15/2015	1 year
Microwave Cable	EMCI	EMC104-SM-SM-1500	140303	02/23/2016	1 year
Test Site	ATL	TE05	TE05	N.C.R.	-----

Note: N.C.R. = No Calibration Request.



8.4. Test Procedure

The EUT tested to DTS test procedure of KDB558074D01 for compliance to FCC 47CFR 15.247 requirements.

1. Set analyzer center frequency to DTS channel center frequency.
2. Set the span to 1.5 times the DTS bandwidth.
3. Set the RBW to: $3 \text{ kHz} \leq \text{RBW} \leq 100 \text{ kHz}$.
4. Set the VBW $\geq 3 \times \text{RBW}$.
5. Detector = peak.
6. Sweep time = auto couple.
7. Trace mode = max hold.
8. Allow trace to fully stabilize.
9. Use the peak marker function to determine the maximum amplitude level within the RBW.
10. If measured value exceeds limit, reduce RBW (no less than 3 kHz) and repeat.

8.5. Test Result



Model Number	WB101U				
Test Item	Maximum Power Density				
Date of Test	08/12/2016				
Test Mode	Frequency (MHz)	Measurement Results (dBm/30KHz)	Duty Factor (dB)	Max. Power Density (dBm/30KHz)	Limit (dBm/3KHz)
Mode 2	2412	-3.182	0.02	-3.162	< 8
	2437	-4.165	0.02	-4.145	< 8
	2462	-4.158	0.02	-4.138	< 8
Mode 3	2412	-11.654	0.16	-11.494	< 8
	2437	-11.243	0.16	-11.083	< 8
	2462	-11.268	0.16	-11.108	< 8
Mode 4	2412	-11.282	0.32	-10.962	< 8
	2437	-10.747	0.32	-10.427	< 8
	2462	-10.958	0.32	-10.638	< 8
Mode 5	2422	-13.213	0.23	-12.983	< 8
	2437	-13.492	0.23	-13.262	< 8
	2452	-13.679	0.23	-13.449	< 8

Note: The Max. Power Density = measurement results + duty factor.



8.6. Test Graphs

Mode 2: IEEE 802.11b link mode

2412 MHz	
2437 MHz	
2462 MHz	



Mode 3: IEEE 802.11g link mode

2412 MHz



2437 MHz

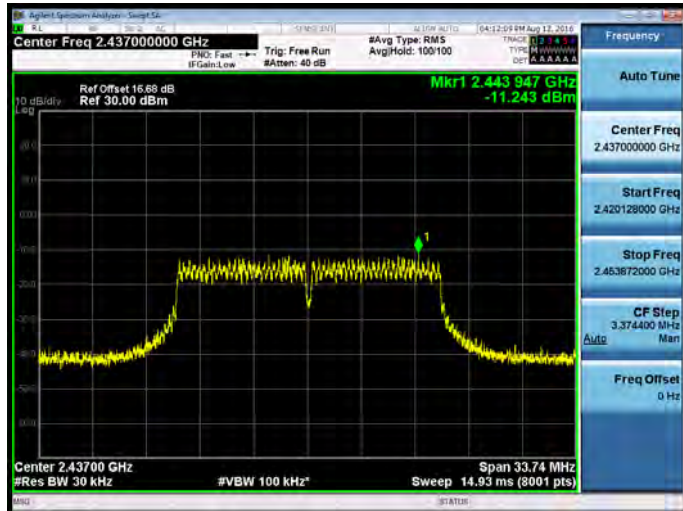

2462 MHz

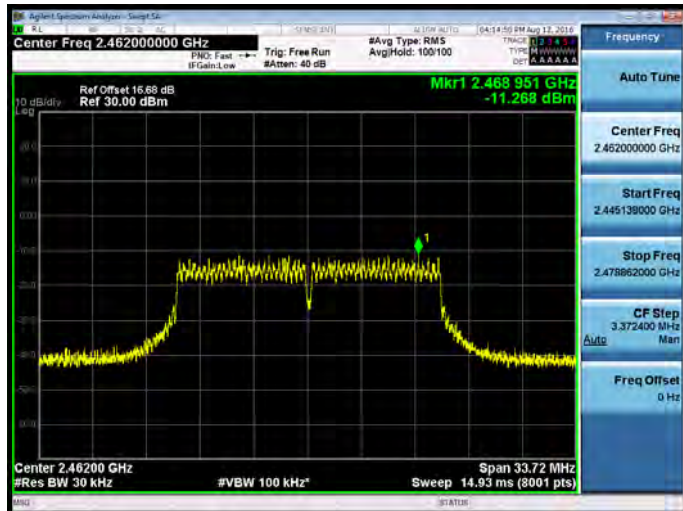



Mode 4: IEEE 802.11n 2.4GHz 20MHz link mode

2412 MHz



2437 MHz

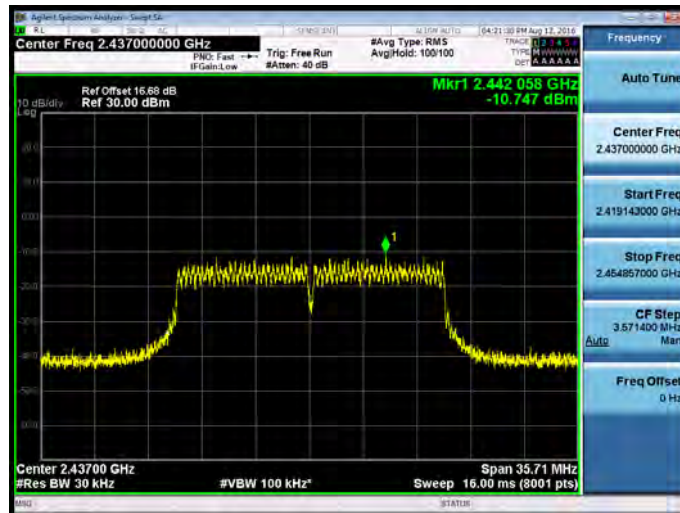

2462 MHz

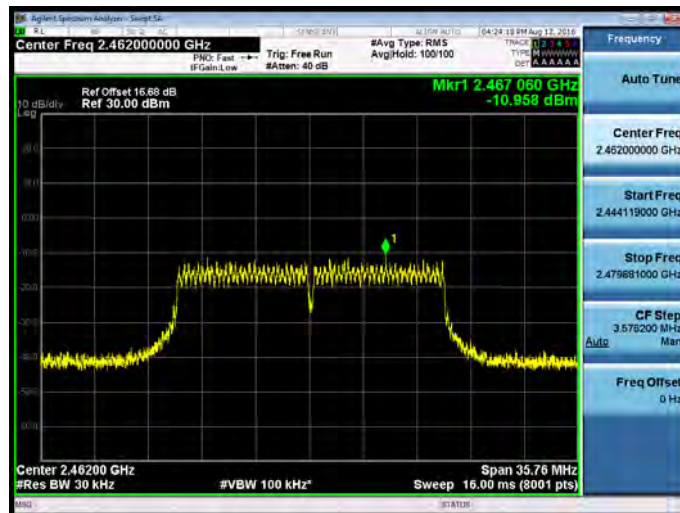



Mode 5: IEEE 802.11n 2.4GHz 40MHz link mode

2422 MHz

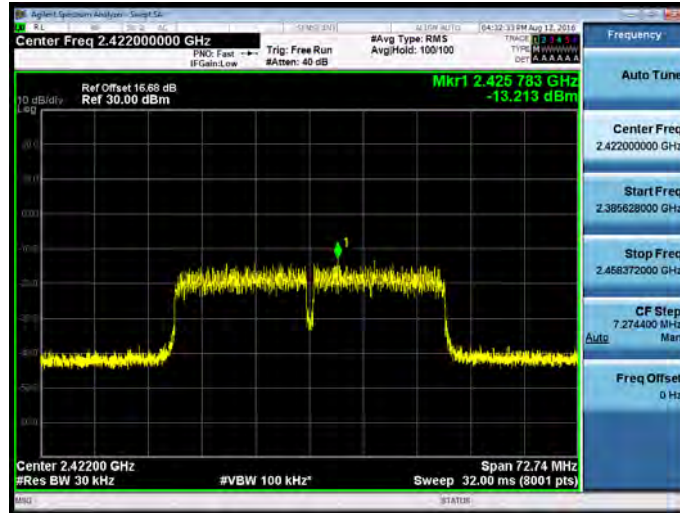

2437 MHz

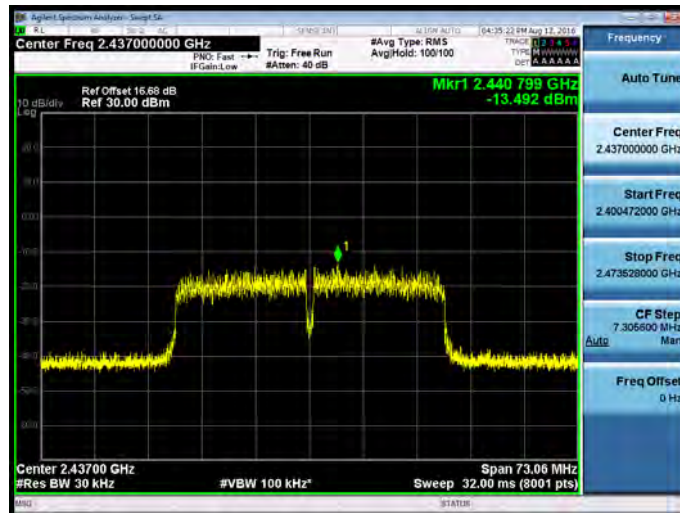

2452 MHz

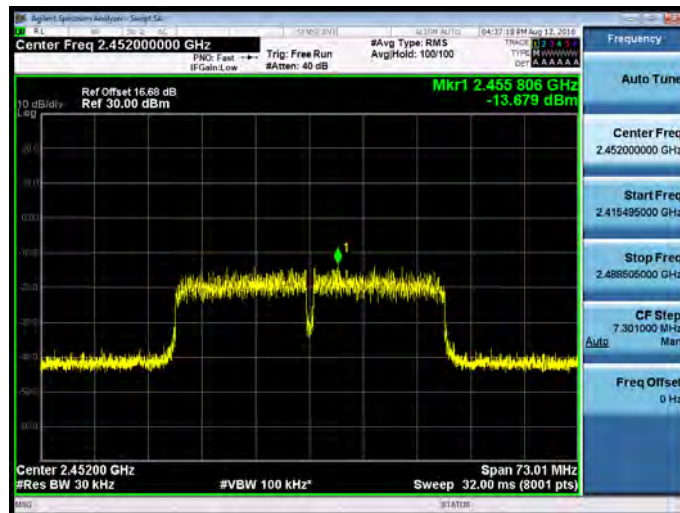

9 Out of Band Conducted Emissions Measurement

9.1. Limit

In any 100 kHz bandwidth outside the frequency band in which the spread spectrum or digitally modulated intentional radiator is operating, the radio frequency power that is produced by the intentional radiator shall be at least 20 dB below that in the 100 kHz bandwidth within the band that contains the highest level of the desired power

9.2. Test Setup

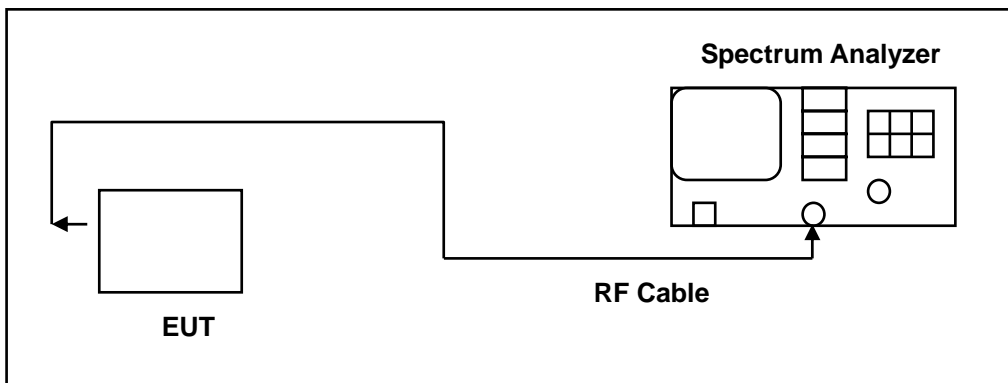

9.3. Test Instruments

Equipment	Manufacturer	Model Number	Serial Number	Cal. Date	Cal. Period
Spectrum Analyzer	Agilent	E4445A	MY45300744	12/15/2015	1 year
Spectrum Analyzer	Agilent	E4408B	MY45107753	08/08/2016	1 year
Microwave Cable	EMCI	EMC104-SM-SM-1500	140303	02/23/2016	1 year
Test Site	ATL	TE05	TE05	N.C.R.	-----

Note: N.C.R. = No Calibration Request.

9.4. Test Procedure

In any 100 kHz bandwidth outside the EUT pass band, the RF power produced by the modulation products of the spreading sequence, the information sequence, and the carrier frequency shall be at least 20 dB below that of the maximum in-band 100 kHz emission, antenna output of the EUT was coupled directly to spectrum analyzer; if an external attenuator and/or cable was used, these losses are compensated for with the analyzer OFFSET function.

All other types of emissions from the EUT shall meet the general limits for radiated frequencies outside the pass band.



The test was performed at 3 channels.



9.5. Test Graphs

Reference level

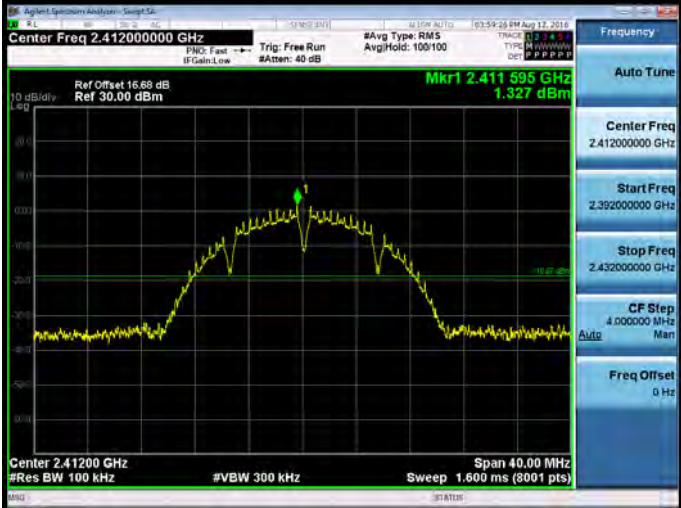
Mode 2: IEEE 802.11b link mode

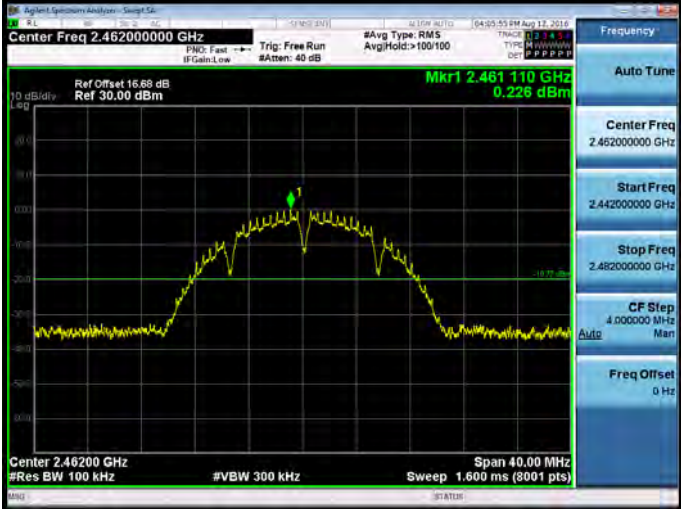
<p>2412 MHz</p>	
<p>2437 MHz</p>	
<p>2462 MHz</p>	



Mode 3: IEEE 802.11g link mode

2412 MHz



2437 MHz



2462 MHz

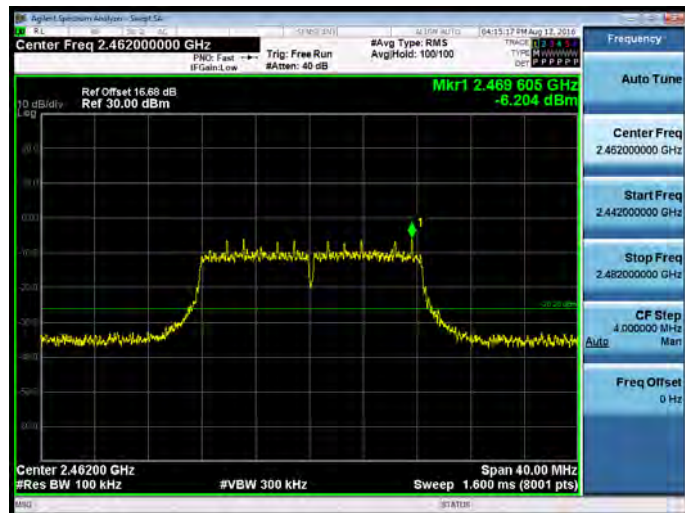



Mode 4: IEEE 802.11n 2.4GHz 20MHz link mode

2412 MHz



2437 MHz

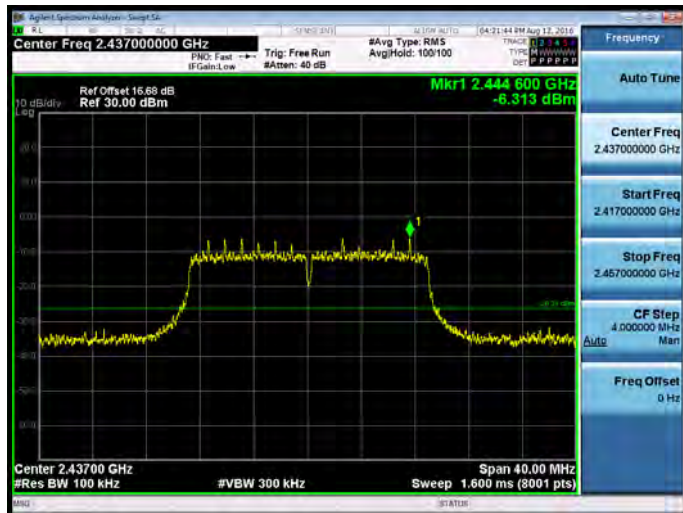

2462 MHz





Mode 5: IEEE 802.11n 2.4GHz 40MHz link mode

2422 MHz

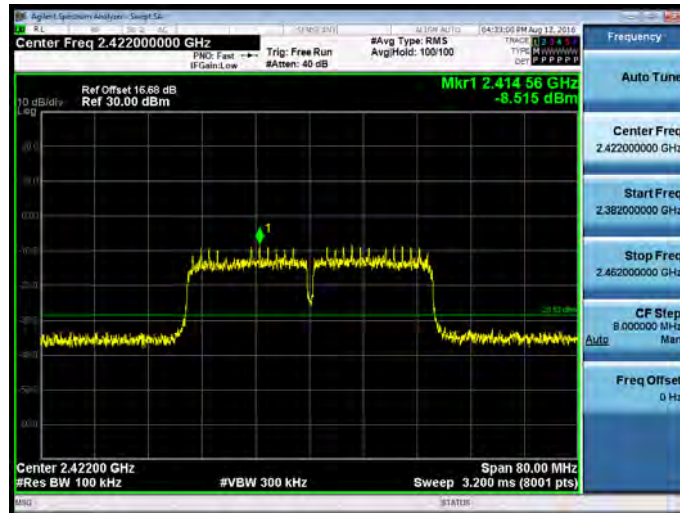

2437 MHz

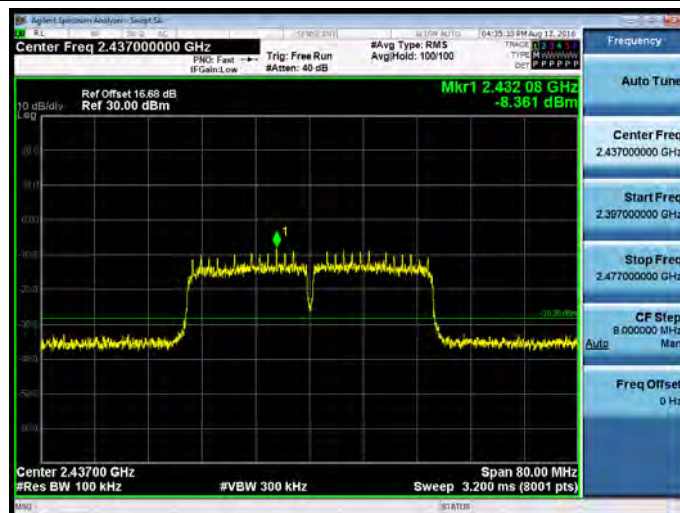



2452 MHz





Out of Band Conducted Emissions

Mode 2: IEEE 802.11b link mode

2412 MHz	
2437 MHz	
2462 MHz	



Mode 3: IEEE 802.11g link mode

2412 MHz



2437 MHz

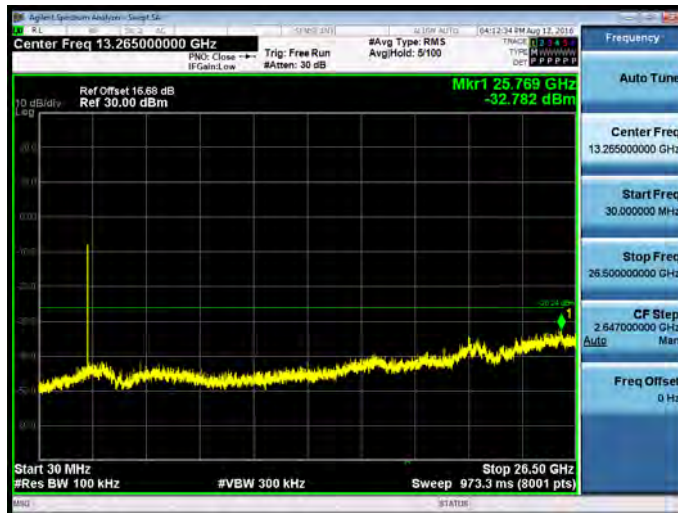

2462 MHz





Mode 4: IEEE 802.11n 2.4GHz 20MHz link mode

2412 MHz



2437 MHz



2462 MHz





Mode 5: IEEE 802.11n 2.4GHz 40MHz link mode

2422 MHz



2437 MHz



2452 MHz





Conducted Band Edge

Mode 2: IEEE 802.11b link mode

2412 MHz

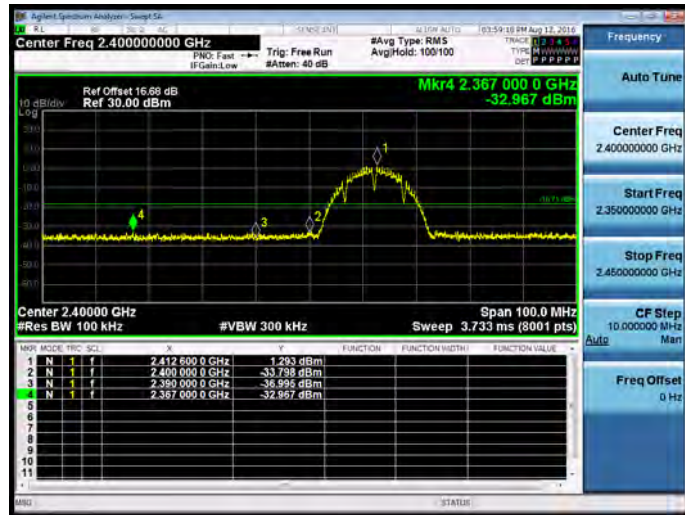

2462 MHz

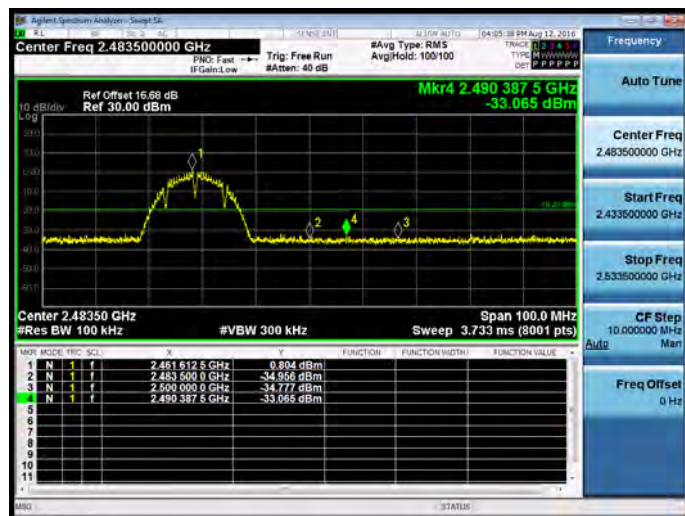

Mode 3: IEEE 802.11g link mode

2412 MHz

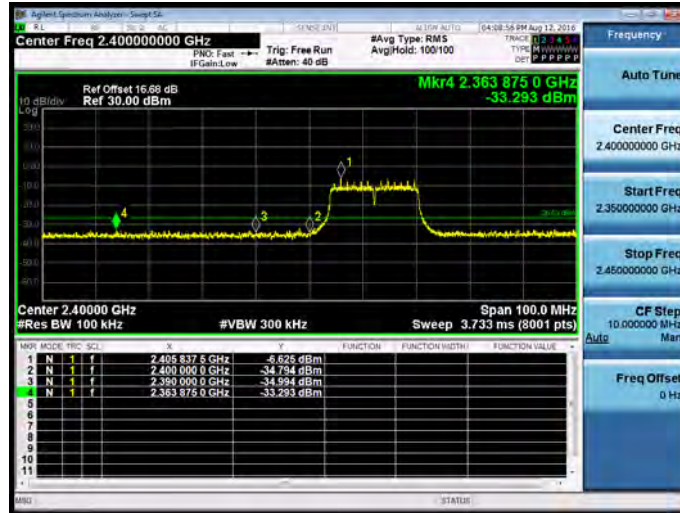

2462 MHz

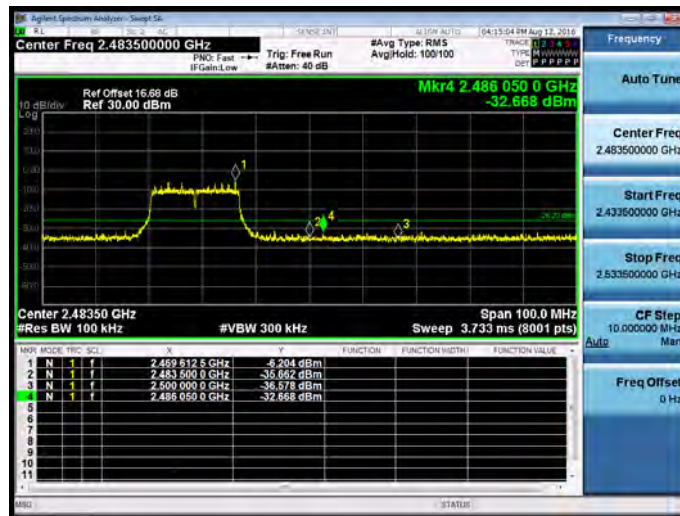



Mode 4: IEEE 802.11n 2.4GHz 20MHz link mode

2412 MHz

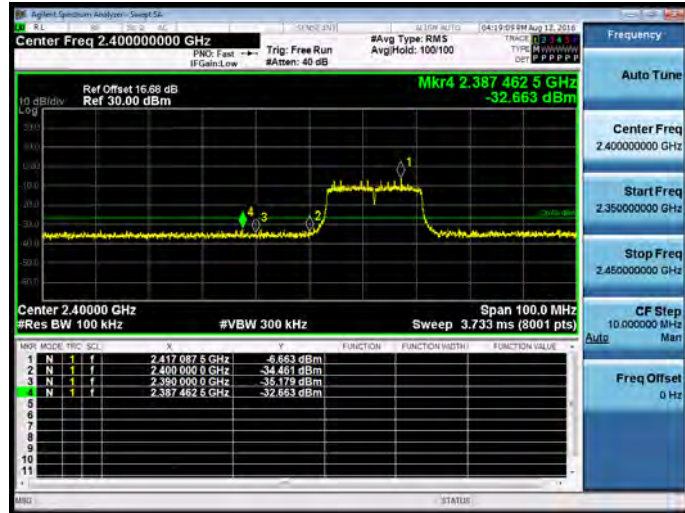

2462 MHz

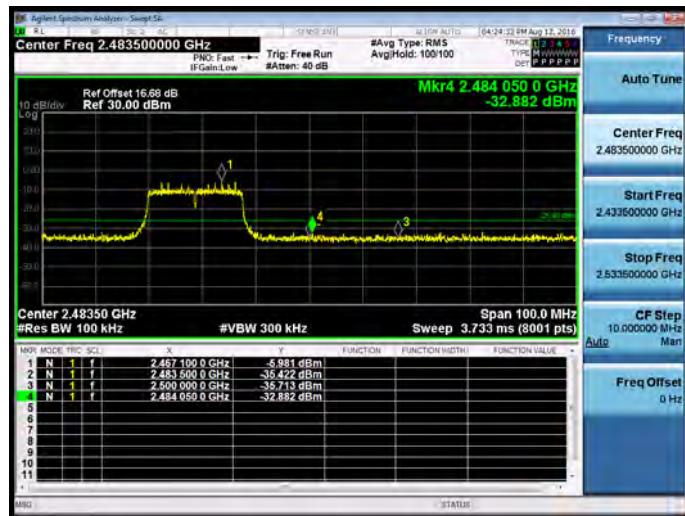



Mode 5: IEEE 802.11n 2.4GHz 40MHz link mode

2422 MHz

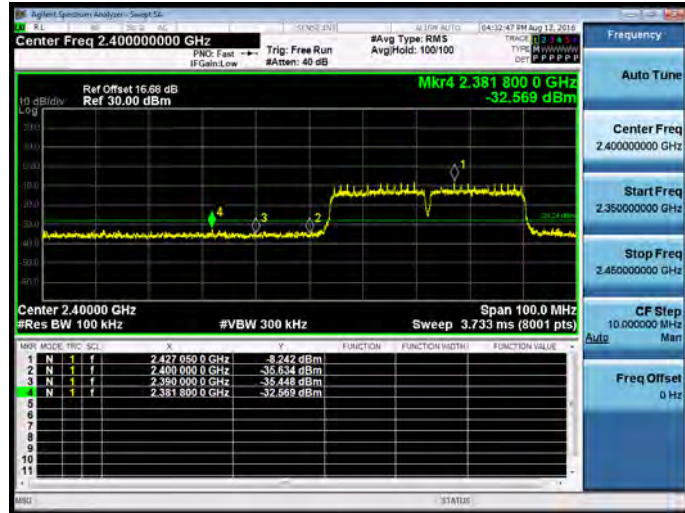

2452 MHz

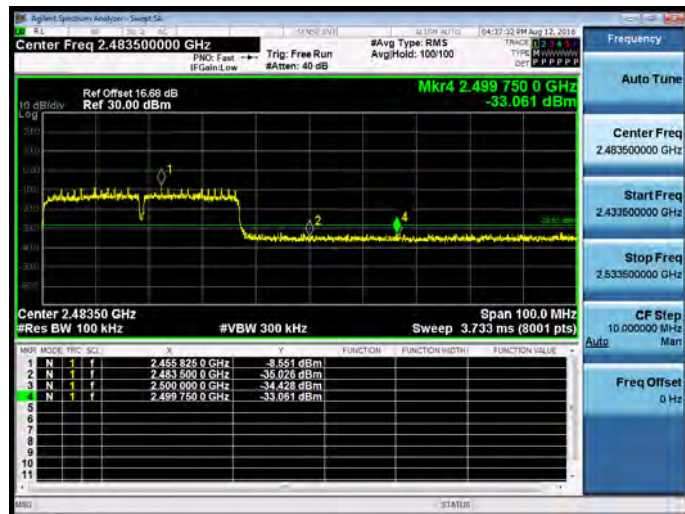



10 Antenna Measurement

10.1.Limit

For intentional device, according to 15.203, an intentional radiator shall be designed to ensure that no antenna other than that furnished by the responsible party shall be used with the device.

And According to 15.247 (b), if transmitting antennas of directional gain greater than 6 dBi are used, the power shall be reduced by the amount in dB that the directional gain of the antenna exceeds 6dBi.

10.2.Antenna Description

See section 2 – antenna information.