

Appendix - EUT Photos

Model: VXT67

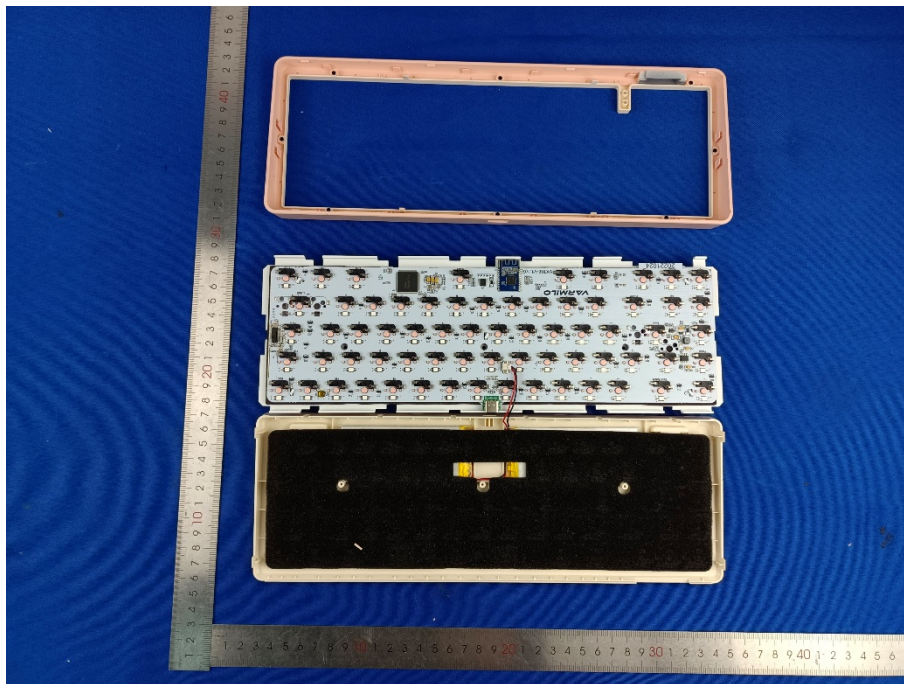

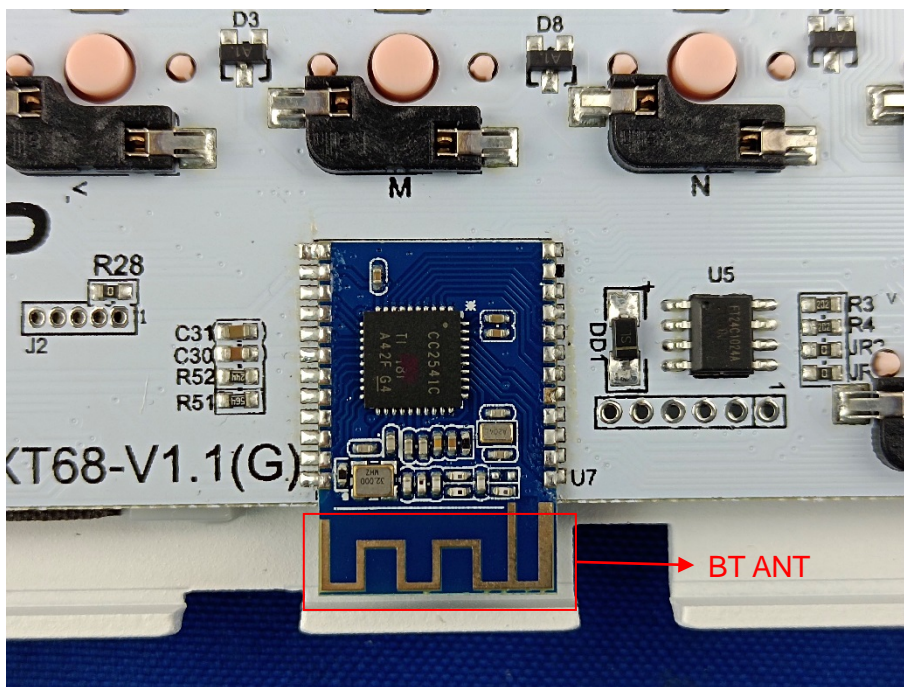

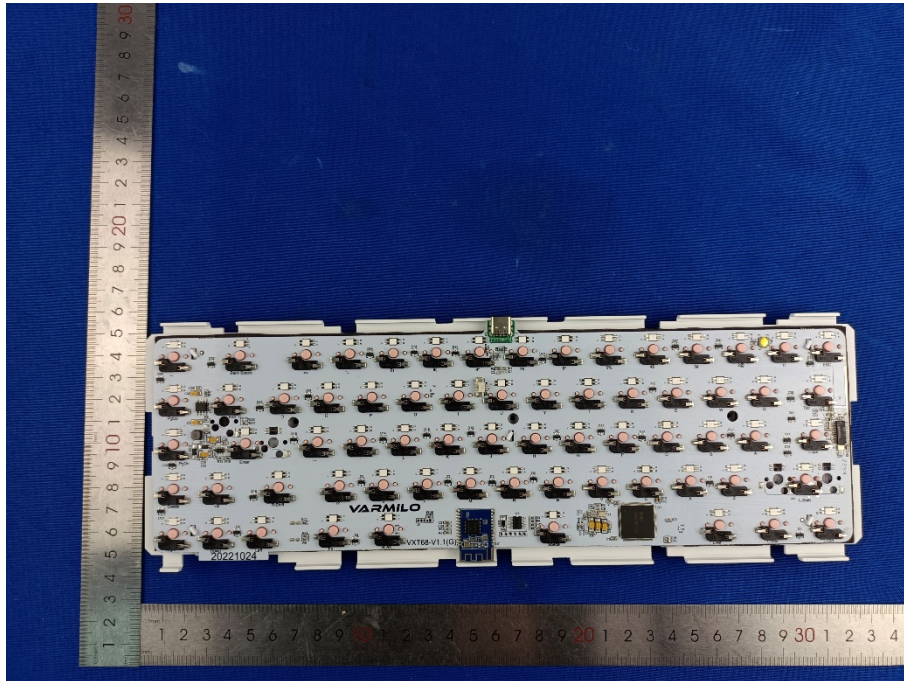
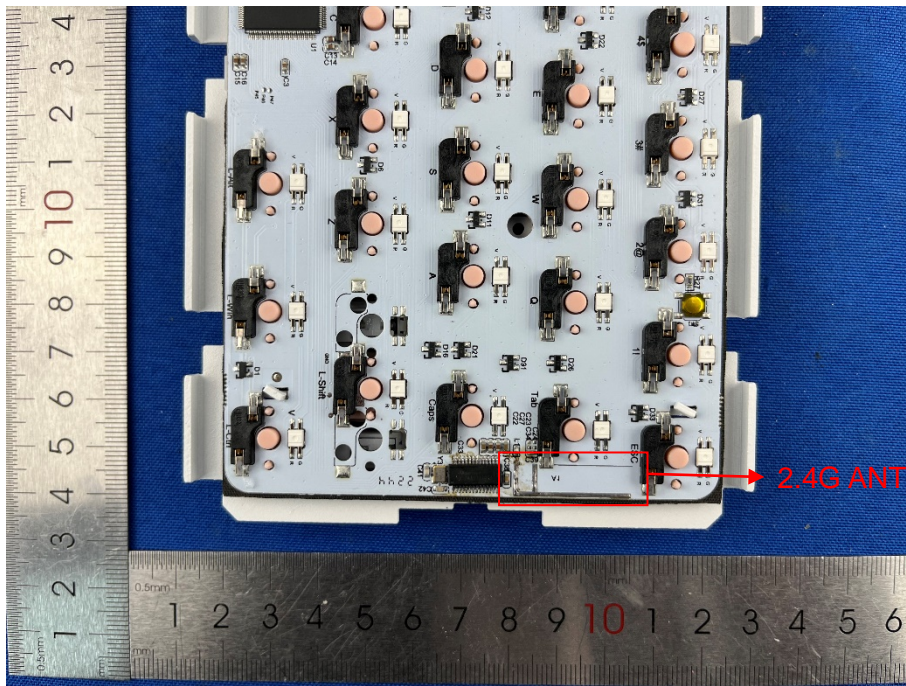
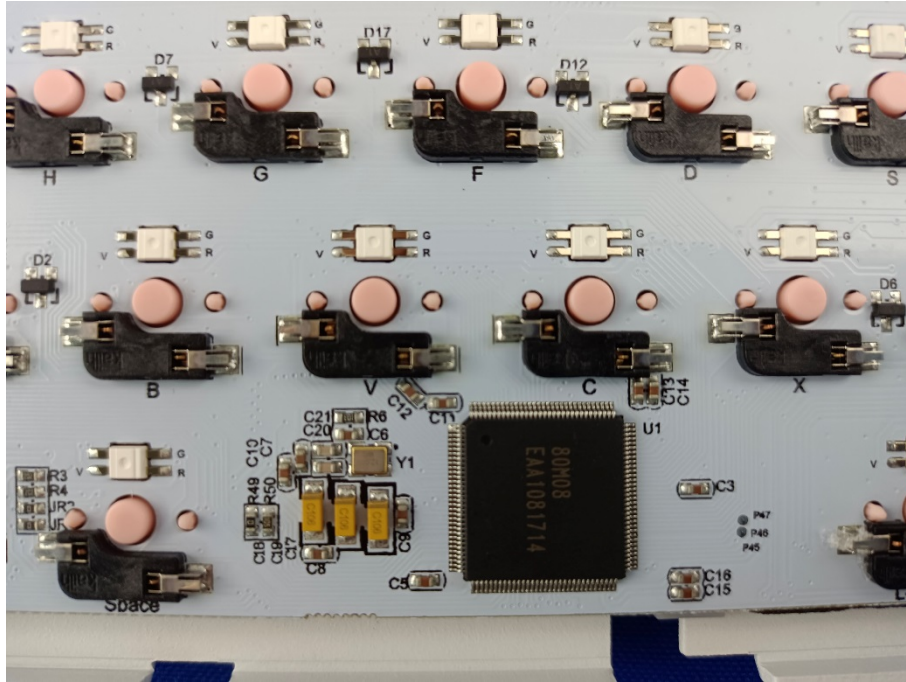

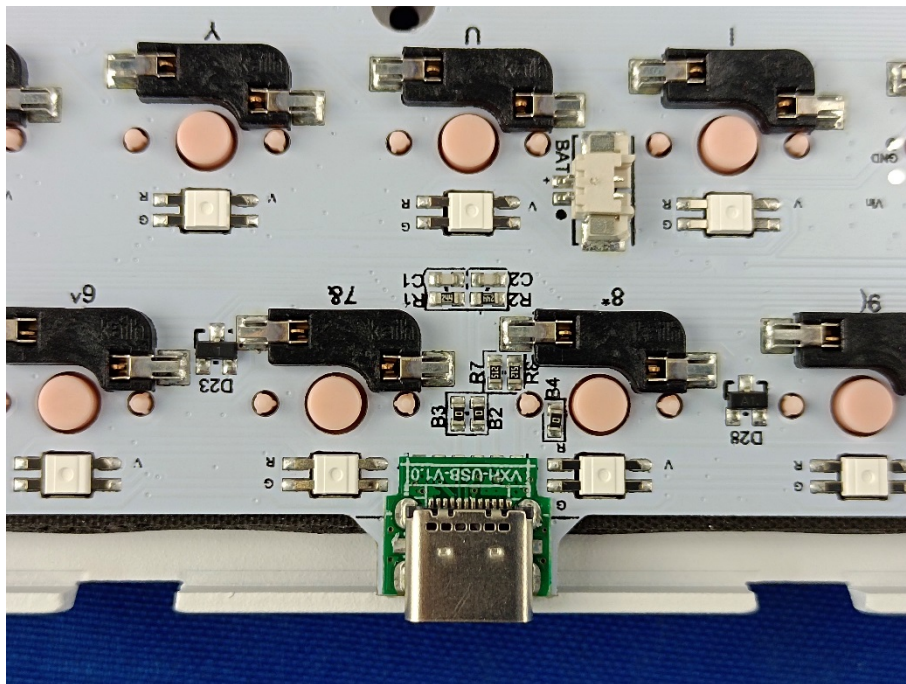
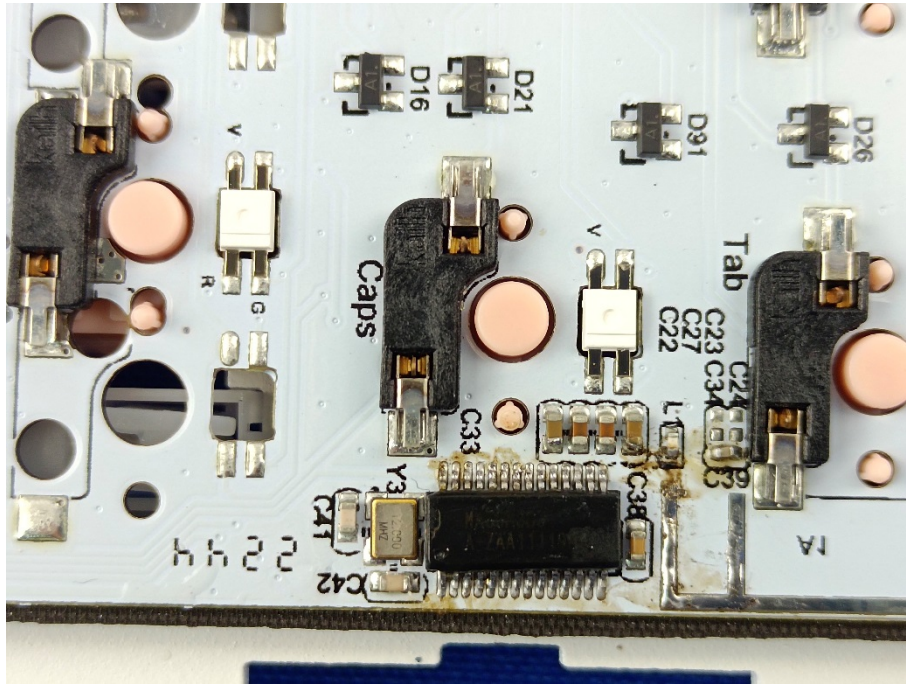

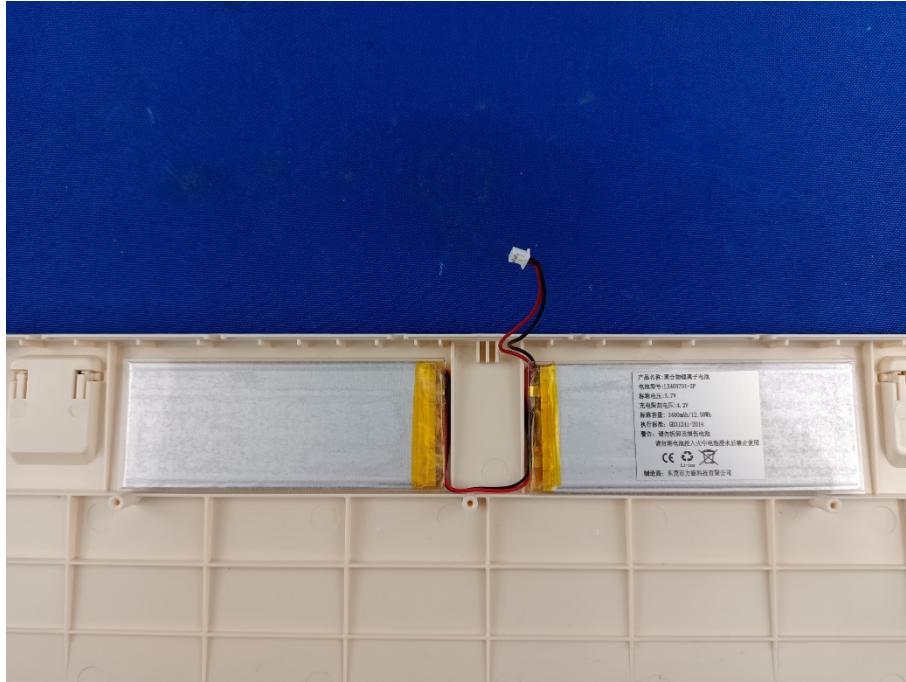

----End of Report----