

## D CARE AND WARNING

**WARNING:** Changes or modifications to this unit not expressly approved by the party responsible for compliance could void the user's authority to operate the equipment.

**NOTE:** This equipment has been tested and found to comply with the limits for a Class B digital device, pursuant to Part 15 of the FCC Rules. These limits are designed to provide reasonable protection against harmful interference in a residential installation. This equipment generates, uses and can radiate radio frequency energy and, if not installed and used in accordance with the instructions, may cause harmful interference to radio communications.

However, there is no guarantee that interference will not occur in a particular installation. If this equipment does cause harmful interference to radio or television reception, which can be determined by turning the equipment off and on, the user is encouraged to try to correct the interference by one or more of the following measures:

- Reorient or relocate the receiving antenna.
- Increase the separation between the equipment and receiver.
- Connect the equipment into an outlet on a circuit different from that to which the receiver is connected.
- Consult the dealer or an experienced radio/panel PC technician for help.

This device complies with Part 15 of the FCC Rules. Operation is subject to the following two conditions:

- (1) this device may not cause harmful interference, and
- (2) this device must accept any interference received, including interference that may cause undesired operation.

 Correct Disposal of this product. This marking indicates that this product should not be disposed with other household wastes throughout the EU. To prevent possible harm to the environment or human health from uncontrolled waste disposal, recycle it responsibly to promote the sustainable reuse of material resources. To return your used device, please use the return and collection systems or contact the retailer where the product was purchased. They can take this product for environmental safe recycling.

"FCC & CE RF Radiation Exposure Statement Caution: To maintain compliance with the FCC & CE's RF exposure guidelines, place the product at least 20cm from near by persons."

### Declaration of Conformity

This device complies with the requirements set out in the Council Directive on the Approximation of the Laws of the Member States relating to Electromagnetic Compatibility (2014/30/EU), Low-voltage Directive (2014/35/EU), ErP Directive (2009/125/EC), RoHS directive (2011/65/EU) and Radio Equipment Directive (2014/53/EU).

This product has been tested and found to comply with the harmonized standards for Information Technology Equipment, these harmonized standards published under Directives of Official Journal of the European Union.

Adaptor with ferrite must be used with this equipment to ensure compliance with the Class B FCC limits.

Specifications of the DC power adapter  
Model: SOY-0500200-090/PSAF10R-050Q  
Input: 100-240V~50/60Hz 0.5A Max  
Output: 5V  $\equiv$  2A

**NOTE:** Operating Temperature: 0~40°C

Qbic Technology Co.,Ltd.  
26F-12, No.99,Sec.1, Xintai 5th Rd., Xizhi Dist., New Taipei City 221, Taiwan(R.O.C)  
Tel: 886-2-2697-2000 FAX: 886-2-2697-2868

# Quick Start Guide

This quick guide will help you go through installation quickly

## Panel PC TD-0350

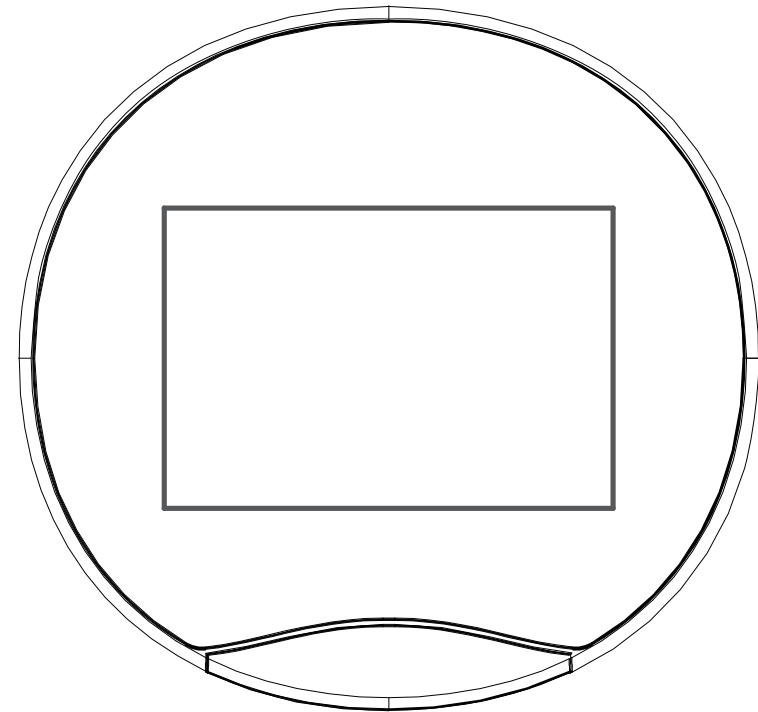

The color depends on the actual product.  
The specifications are subject to change without prior notification to improve the performance.

## A Contents

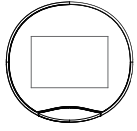

Panel PC

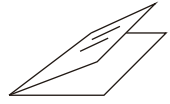

Quick Start Guide

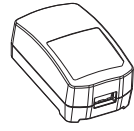

DC Power Adapter

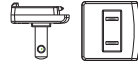

Power Plug

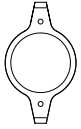

Bracket



USB cable



Screw pack  
(Screws\*7, Rubber caps\*4)

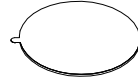

Adhesive tape

## B Indication

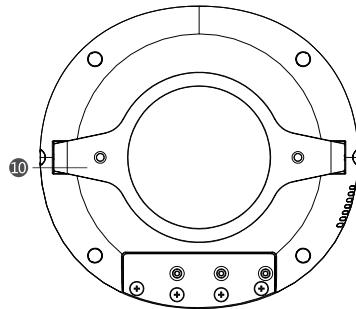
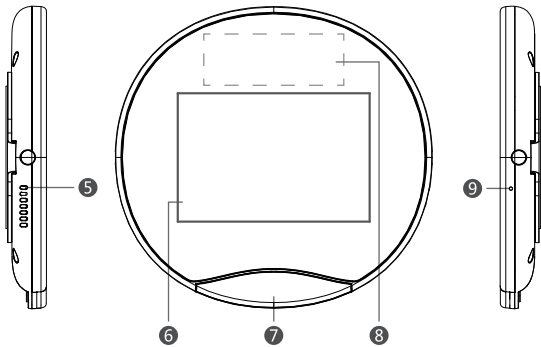
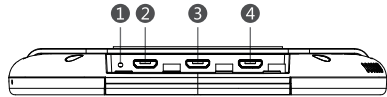

- ① Reset Button
- ② ADB
- ③ DC 5V IN
- ④ USB

- ⑤ Speaker
- ⑥ Touch screen
- ⑦ LED indicator light
- ⑧ NFC

- ⑨ Microphone
- ⑩ Bracket

## C Installation

### 1. Cable connection

Step 1

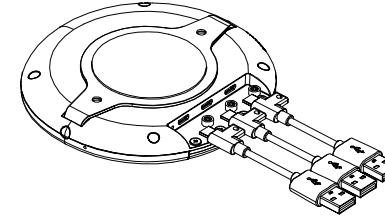

Plug USB cable into USB port

Step 2

Provided in screw pack

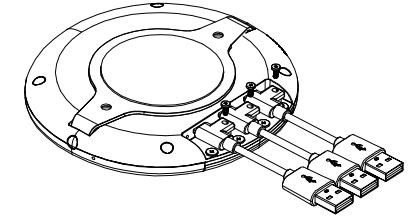

Fix the screws to secure the USB cables.

### 2. Surface Bracket Mount Installation

Step 1

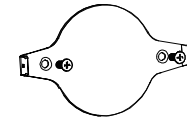

Install the bracket on surface  
Screw specifications: KA4\*14,  
diameter: 7 mm  
(Screws are not provided)

Step 2

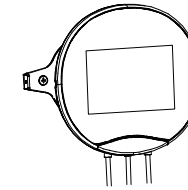

Assemble the panel PC  
to the bracket

Step 3

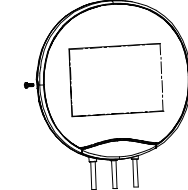

Tighten the screws. Locations  
are shown in above illustration.  
Screw specifications: M2\*5 (T6)  
(screw pack)

Step 4

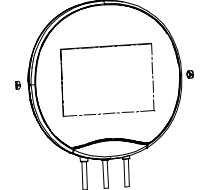

Cover the screws with  
rubber caps.

### 3. Adhesive Bracket Mount Installation

Step 1

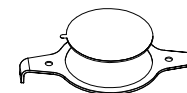

Laminate adhesive to  
the back of bracket

Step 2

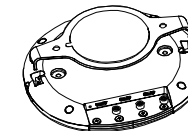

Install the bracket onto  
the panel PC bracket  
slot (at the back)

Step 3

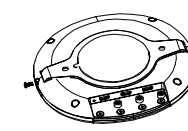

Tighten the screws and cover  
them with rubber caps  
Screw specifications: M2\*5 (T6)  
(screw pack)

Step 4

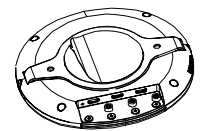

Peel off the adhesive and  
attach the panel PC on a  
smooth and clean surface

\* Please install and use this product in strict accordance with the instructions.