

FCC Test Report

Report No.: AGC03175180601FE08

FCC ID : 2AF6M3396993M531P
APPLICATION PURPOSE : Original Equipment
PRODUCT DESIGNATION : MOBILE PHONE
BRAND NAME : Cellacom
MODEL NAME : M531
CLIENT : Mobile Commodity Corporation
DATE OF ISSUE : Jul 23, 2018
STANDARD(S) : FCC Part 15.247
TEST PROCEDURE(S) : KDB 558074 D01 DTS Meas Guidance v04
REPORT VERSION : V1.1

Attestation of Global Compliance (Shenzhen) Co., Ltd

CAUTION:

This report shall not be reproduced except in full without the written permission of the test laboratory and shall not be quoted out of context.



The results shown in this test report refer only to the sample(s) tested unless otherwise stated and the sample(s) are retained for 30 days only. The document is issued by AGC, this document cannot be reproduced except in full with our prior written permission. The more details and the authenticity of the report will be confirmed at <http://www.agc-cert.com>.

Report Revise Record

Report Version	Revise Time	Issued Date	Valid Version	Notes
V1.0	/	Jul. 13, 2018	Invalid	Initial Release
V1.1	1 st	Jul. 23, 2018	Valid	Revise Page 28~31 and 36

The results shown in this test report refer only to the sample(s) tested unless otherwise stated and the sample(s) are retained for 30 days only. The document is issued by AGC, this document cannot be reproduced except in full with our prior written permission. The more details and the authenticity of the report will be confirmed at <http://www.agc-cert.com>.

TABLE OF CONTENTS

1. VERIFICATION OF COMPLIANCE..... 5

2.GENERAL INFORMATION..... 6

 2.1PRODUCT DESCRIPTION 6

 2.2 RELATED SUBMITTAL(S)/GRANT(S) 6

 2.3TEST METHODOLOGY 6

 2.4 TEST FACILITY..... 7

 2.5 SPECIAL ACCESSORIES 7

 2.6 EQUIPMENT MODIFICATIONS 7

3. MEASUREMENT UNCERTAINTY 8

4. SYSTEM TEST CONFIGURATION 9

 4.1 CONFIGURATION OF TESTED SYSTEM 9

 4.2 EQUIPMENT USED IN TESTED SYSTEM..... 9

5. SUMMARY OF TEST RESULTS 11

6. DESCRIPTION OF TEST MODES 12

7. RADIATED EMISSION 13

 7.1 MEASUREMENT PROCEDURE 13

 7.2 TEST SETUP..... 14

 7.3 LIMITS AND MEASUREMENT RESULT 15

 7.4 TEST RESULT 16

8. BAND EDGE EMISSION 19

 8.1. MEASUREMENT PROCEDURE 19

 8.2. TEST SET-UP 19

 8.3. RADIATED TEST RESULT 20

 8.4. CONDUCTED TEST RESULT 21

9.6DB BANDWIDTH 22

 9.1. TEST PROCEDURE 22

 9.2. SUMMARY OF TEST RESULTS/PLOTS..... 22

10. CONDUCTED OUTPUT POWER..... 23

 10.1. MEASUREMENT PROCEDURE 23

 10.2. TEST SET-UP (BLOCK DIAGRAM OF CONFIGURATION)..... 23

 10.3. LIMITS AND MEASUREMENT RESULT 24

11. MAXIMUM CONDUCTED OUTPUT POWER SPECTRAL DENSITY..... 25

 11.1 MEASUREMENT PROCEDURE 25

 11.2 TEST SET-UP (BLOCK DIAGRAM OF CONFIGURATION)..... 25

The results shown in this test report refer only to the sample(s) tested unless otherwise stated and the sample(s) are retained for 30 days only. The document is issued by AGC, this document cannot be reproduced except in full with our prior written permission. The more details and the authenticity of the report will be confirmed at <http://www.agc-cert.com>.

11.3 LIMITS AND MEASUREMENT RESULT	26
12. FCC LINE CONDUCTED EMISSION TEST	28
12.1 LIMITS	28
12.2 TEST SETUP	28
12.3 PRELIMINARY PROCEDURE	29
12.4 FINAL TEST PROCEDURE	29
12.5 TEST RESULT OF POWER LINE	30
13. CONDUCTED SPURIOUS EMISSION	32
13.1. MEASUREMENT PROCEDURE	32
13.2. TEST SET-UP (BLOCK DIAGRAM OF CONFIGURATION)	33
13.3. MEASUREMENT EQUIPMENT USED	33
13.4. LIMITS AND MEASUREMENT RESULT	33
APPENDIX A: PHOTOGRAPHS OF TEST SETUP	36

The results shown in this test report refer only to the sample(s) tested unless otherwise stated and the sample(s) are retained for 30 days only. The document is issued by AGC, this document cannot be reproduced except in full with our prior written permission. The more details and the authenticity of the report will be confirmed at <http://www.agc-cert.com>.

1. VERIFICATION OF COMPLIANCE

Applicant	Mobile Commodity Corporation
Address	20955 Pathfinder Road, Suite 200, Diamond Bar, CA 91765, USA
Manufacturer	Cellacom Technologies Company Limited
Address	Rooms 05-15, 13A/F, South Tower, World Finance Centre, Harbour City, 17 Canton Road, Tsim Sha Tsui, Kowloon, Hong Kong
Product Designation	MOBILE PHONE
Brand Name	Cellacom
Test Model	M531
Date of test	Jun. 19, 2018 to Jul. 12, 2018
Deviation	None
Condition of Test Sample	Normal
Report Template	AGCRT-US-BLE/RF

We hereby certify that:

The above equipment was tested by Attestation of Global Compliance(Shenzhen) Co., Ltd. The test data, data evaluation, test procedures, and equipment configurations shown in this report were made in accordance with the procedures given in ANSI C63.10 (2013) and the energy emitted by the sample EUT tested as described in this report is in compliance with requirement of FCC Part 15 Rules requirement.

The test results of this report relate only to the tested sample identified in this report.

Tested By

Nice.xie

Nice Xie(Xie Xiaosong)

Jul. 12, 2018

Reviewed By

Bart Xie

Bart Xie(Xie Xiaobin)

Jul. 23, 2018

Approved By

Forrest Lei

Forrest Lei(Lei Yonggang)
 Authorized Officer

Jul. 23, 2018

The results shown in this test report refer only to the sample(s) tested unless otherwise stated and the sample(s) are retained for 30 days only. The document is issued by AGC, this document cannot be reproduced except in full with our prior written permission. The more details and the authenticity of the report will be confirmed at <http://www.agc-cert.com>.

2.GENERAL INFORMATION

2.1PRODUCT DESCRIPTION

The EUT is designed as “MOBILE PHONE ”. It is designed by way of utilizing the FHSS technology to achieve the system operation.

A major technical description of EUT is described as following:

Operation Frequency	2.402 GHz to 2.480GHz
Bluetooth Version	V4.0
Modulation	GFSK
Number of channels	40 Channel(37 Hopping Channel,3 advertising Channel)
Antenna Designation	PIFA Antenna
Antenna Gain	0.85dBi
Hardware Version	H01_M_V2.0
Software Version	Cellacom_M531_V05_20180612
Power Supply	DC3.7V by Built-in Li-ion Battery

2.2 RELATED SUBMITTAL(S)/GRANT(S)

This submittal(s) (test report) is intended for **FCC ID: 2AF6M3396993M531P** filing to comply with Section 15.247of the FCC Part 15, Subpart C Rules.

2.3TEST METHODOLOGY

All measurements contained in this report were conducted with ANSI C63.10 (2013), American National Standard for Methods of Measurement of Radio-Noise Emissions from Low-Voltage Electrical and Electronic Equipment in the range of 9 kHz to 40 GHz.

The equipment under test (EUT) was configured to measure its highest possible emission level. The test modes were adapted accordingly in reference to the Operating Instructions. The EUT was tested in all three orthogonal planes and the worse case was showed.

The results shown in this test report refer only to the sample(s) tested unless otherwise stated and the sample(s) are retained for 30 days only. The document is issued by AGC, this document cannot be reproduced except in full with our prior written permission. The more details and the authenticity of the report will be confirmed at <http://www.agc-cert.com>.

2.4 TEST FACILITY

Site	Attestation of Global Compliance (Shenzhen) Co., Ltd
Location	1-2F., Bldg.2, No.1-4, Chaxi Sanwei Technical Industrial Park, Gushu, Xixiang, Bao'an District B112-B113, Bldg.12, Baoan Bldg Materials Center, No.1 of Xixiang Inner Ring Road, Baoan District, Shenzhen 518012
NVLAP LAB CODE	600153-0
Designation Number	CN5028
Description	Attestation of Global Compliance(Shenzhen) Co., Ltd is accredited by National Voluntary Laboratory Accreditation program, NVLAP Code 600153-0

2.5 SPECIAL ACCESSORIES

Refer to section 2.2.

2.6 EQUIPMENT MODIFICATIONS

Not available for this EUT intended for grant.

The results shown in this test report refer only to the sample(s) tested unless otherwise stated and the sample(s) are retained for 30 days only. The document is issued by AGC, this document cannot be reproduced except in full with our prior written permission. The more details and the authenticity of the report will be confirmed at <http://www.agc-cert.com>.

3. MEASUREMENT UNCERTAINTY

- Uncertainty of Conducted Emission, $U_c = \pm 3.2\text{dB}$
- Uncertainty of Radiated Emission below 1GHz, $U_c \pm 3.9\text{dB}$
- Uncertainty of Radiated Emission above 1GHz, $U_c \pm 4.8\text{dB}$

The results shown in this test report refer only to the sample(s) tested unless otherwise stated and the sample(s) are retained for 30 days only. The document is issued by AGC, this document cannot be reproduced except in full with our prior written permission. The more details and the authenticity of the report will be confirmed at <http://www.agc-cert.com>.

4. SYSTEM TEST CONFIGURATION

4.1 CONFIGURATION OF TESTED SYSTEM

Configuration:

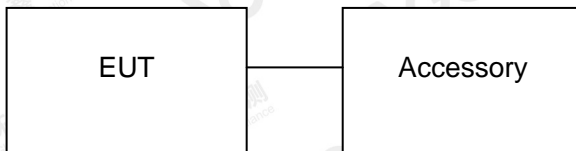

4.2 EQUIPMENT USED IN TESTED SYSTEM

Item	Equipment	Model No.	ID or Specification	Remark
1	MOBILE PHONE	M531	2AF6M3396993M531P	EUT
2	Battery	M531	DC3.7V/ 2200mAh	Accessory
3	Earphone	N/A	N/A	Accessory

The results shown in this test report refer only to the sample(s) tested unless otherwise stated and the sample(s) are retained for 30 days only. The document is issued by AGC, this document cannot be reproduced except in full with our prior written permission. The more details and the authenticity of the report will be confirmed at <http://www.agc-cert.com>.

ALL TEST EQUIPMENT LIST

Equipment	Manufacturer	Model	S/N	Cal. Date	Cal. Due
TEST RECEIVER	R&S	ESPI	101206	Jun.12, 2018	Jun.11, 2019
LISN	R&S	ESH2-Z5	100086	Aug.21, 2017	Aug.20, 2018
TEST RECEIVER	R&S	ESCI	10096	Jun.12, 2018	Jun.11, 2019
EXA Signal Analyzer	Agilent	N9010A	MY53470504	Dec.08, 2017	Dec.07, 2018
Horn antenna	SCHWARZBECK	BBHA 9170	#768	Sep.20, 2017	Sep.19, 2018
preamplifier	ChengYi	EMC184045SE	980508	Sep.15, 2017	Sep.14, 2018
Double-Ridged Waveguide Horn	ETS LINDGREN	3117	00034609	May.18, 2017	May.17, 2019
Broadband Preamplifier	SCHWARZBECK	BBV 9718	9718-205	Jun.12, 2018	Jun.11, 2019
ANTENNA	SCHWARZBECK	VULB9168	D69250	Sep.28, 2017	Sep.27, 2018
SIGNAL ANALYZER	Agilent	N9020A	MY52090123	Sep. 21, 2017	Sep. 20, 2018
LOOP ANTENNA	A.H	SAS-562B	/	Mar.01,2018	Feb.28, 2019

The results shown in this test report refer only to the sample(s) tested unless otherwise stated and the sample(s) are retained for 30 days only. The document is issued by AGC, this document cannot be reproduced except in full with our prior written permission. The more details and the authenticity of the report will be confirmed at <http://www.agc-cert.com>.

5. SUMMARY OF TEST RESULTS

FCC RULES	DESCRIPTION OF TEST	RESULT
§15.203	Antenna Requirement	Compliant
§15.209 §15.247(d)	Radiated Emission	Compliant
§15.247(d)	Band Edges	Compliant
§15.247	6 dB Bandwidth	Compliant
§15.247(b)	Conducted Power	Compliant
§15.247(e)	Maximum Conducted Output Power SPECTRAL Density	Compliant
§15.207	Line Conduction Emission	Compliant
§15.207	Conduction Emission	Compliant

The results shown in this test report refer only to the sample(s) tested unless otherwise stated and the sample(s) are retained for 30 days only. The document is issued by AGC, this document cannot be reproduced except in full with our prior written permission. The more details and the authenticity of the report will be confirmed at <http://www.agc-cert.com>.

6. DESCRIPTION OF TEST MODES

The EUT has been operated in three modulations: GFSK independently.

NO.	TEST MODE DESCRIPTION
1	Low channel TX
2	Middle channel TX
3	High channel TX
4	Normal Operating (BT)

Note:

1. All the test modes can be supply by Built-in Li-ion battery, only the result of the worst case was recorded in the report if no any records.
2. For Radiated Emission, 3axis were chosen for testing for each applicable mode.
3. EUT is operating at its maximum duty cycle>or equal 98%

The results shown in this test report refer only to the sample(s) tested unless otherwise stated and the sample(s) are retained for 30 days only. The document is issued by AGC, this document cannot be reproduced except in full with our prior written permission. The more details and the authenticity of the report will be confirmed at <http://www.agc-cert.com>.

7. RADIATED EMISSION

7.1 MEASUREMENT PROCEDURE

1. The EUT was placed on the top of the turntable 0.8 or 1.5 meter above ground. The phase center of the receiving antenna mounted on the top of a height-variable antenna tower was placed 3 meters far away from the turntable.
2. Power on the EUT and all the supporting units. The turntable was rotated by 360 degrees to determine the position of the highest radiation.
3. The height of the broadband receiving antenna was varied between one meter and four meters above ground to find the maximum emissions field strength of both horizontal and vertical polarization.
4. For each suspected emissions, the antenna tower was scan (from 1 M to 4 M) and then the turntable was rotated (from 0 degree to 360 degrees) to find the maximum reading.
5. Set the test-receiver system to Peak or CISPR quasi-peak Detect Function with specified bandwidth under Maximum Hold Mode.
6. For emissions above 1GHz, use 1MHz VBW and RBW for peak reading. Then 1MHz RBW and 10Hz VBW for average reading in spectrum analyzer. Place the measurement antenna away from each area of the EUT determined to be a source of emissions at the specified measurement distance, while keeping the measurement antenna aimed at the source of emissions at each frequency of significant emissions, with polarization oriented for maximum response. The measurement antenna may have to be higher or lower than the EUT, depending on the radiation pattern of the emission and staying aimed at the emission source for receiving the maximum signal. The final measurement antenna elevation shall be that which maximizes the emissions. The measurement antenna elevation for maximum emissions shall be restricted to a range of heights of from 1 m to 4 m above the ground or reference ground plane.
7. When the radiated emissions limits are expressed in terms of the average value of the emissions, and pulsed operation is employed, the measurement field strength shall be determined by averaging over one complete pulse train, including blanking intervals, as long as the pulse train does not exceed 0.1 seconds. As an alternative (provided the transmitter operates for longer than 0.1 seconds) or in cases where the pulse train exceeds 0.1 seconds, the measured field strength shall be determined from the average absolute voltage during a 0.1 second interval during which the field strength is at its maximum values.
8. If the emissions level of the EUT in peak mode was 3 dB lower than the average limit specified, then testing will be stopped and peak values of EUT will be reported, otherwise, the emissions which do not have 3 dB margin will be repeated one by one using the quasi-peak method for below 1GHz.
9. For testing above 1GHz, the emissions level of the EUT in peak mode was lower than average limit (that means the emissions level in peak mode also complies with the limit in average mode), then testing will be stopped and peak values of EUT will be reported, otherwise, the emissions will be measured in average mode again and reported.
10. In case the emission is lower than 30MHz, loop antenna has to be used for measurement and the recorded data should be QP measured by receiver. High - Low scan is not required in this case.

The results shown in this test report refer only to the sample(s) tested unless otherwise stated and the sample(s) are retained for 30 days only. The document is issued by AGC, this document cannot be reproduced except in full with our prior written permission. The more details and the authenticity of the report will be confirmed at <http://www.agc-cert.com>.

7.2 TEST SETUP

Radiated Emission Test-Setup Frequency Below 30MHz

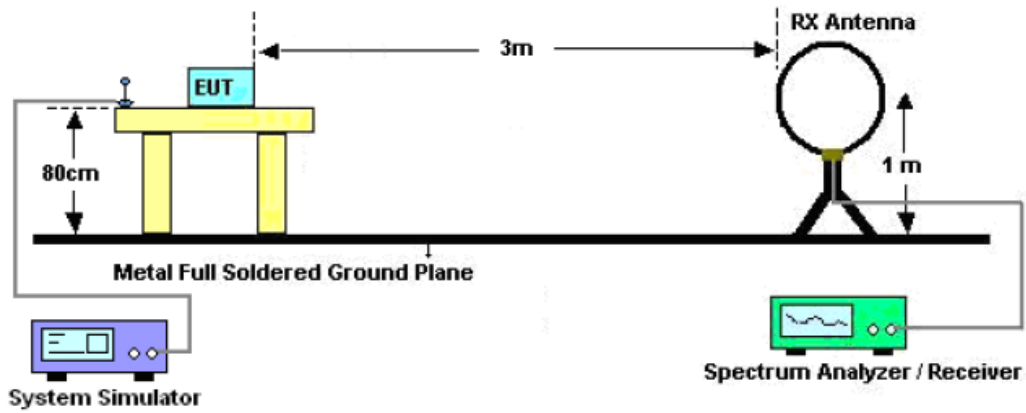

RADIATED EMISSION TEST SETUP 30MHz-1000MHz

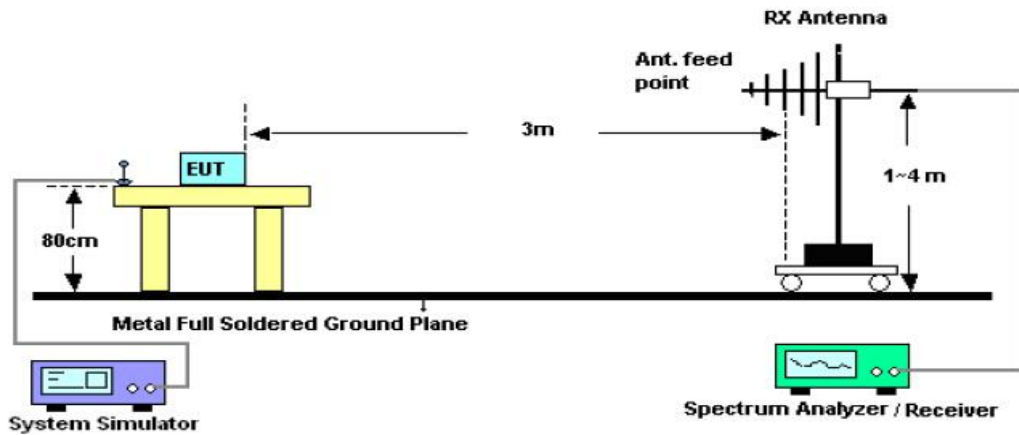

RADIATED EMISSION TEST SETUP ABOVE 1000MHz

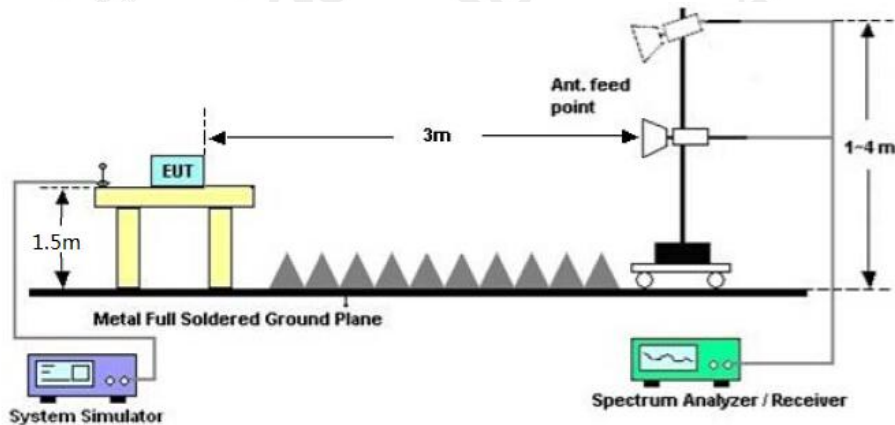

The results shown in this test report refer only to the sample(s) tested unless otherwise stated and the sample(s) are retained for 30 days only. The document is issued by AGC, this document cannot be reproduced except in full with our prior written permission. The more details and the authenticity of the report will be confirmed at <http://www.agc-cert.com>.

7.3 LIMITS AND MEASUREMENT RESULT

15.209 Limit in the below table has to be followed

Frequencies (MHz)	Field Strength (micorvolts/meter)	Measurement Distance (meters)
0.009~0.490	2400/F(KHz)	300
0.490~1.705	24000/F(KHz)	30
1.705~30.0	30	30
30~88	100	3
88~216	150	3
216~960	200	3
Above 960	500	3

Note: All modes were tested For restricted band radiated emission, the test records reported below are the worst result compared to other modes.

The results shown in this test report refer only to the sample(s) tested unless otherwise stated and the sample(s) are retained for 30 days only. The document is issued by AGC, this document cannot be reproduced except in full with our prior written permission. The more details and the authenticity of the report will be confirmed at <http://www.agc-cert.com>.

7.4 TEST RESULT

RADIATED EMISSION BELOW 30MHZ

No emission found between lowest internal used/generated frequencies to 30MHz.

RADIATED EMISSION BELOW 1GHZ

RADIATED EMISSION TEST- (30MHZ-1GHZ) -HORIZONTAL

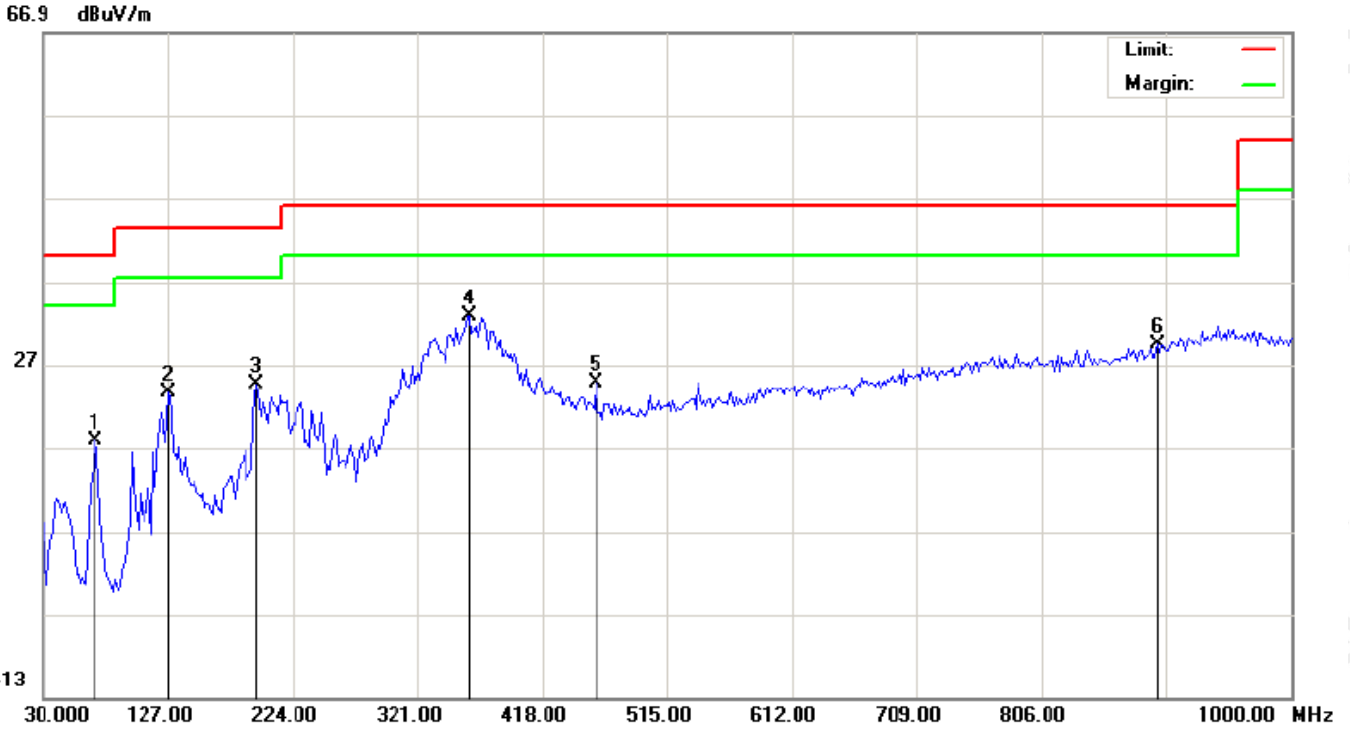

No.	Mk	Freq.	Reading	Factor	Measurement	Limit	Over	Detector	Antenna Height	Table Degree	Comment
		MHz	dBuV	dB/m	dBuV/m	dBuV/m	dB		cm	degree	
1		70.4167	7.89	9.85	17.74	40.00	-22.26	peak			
2		127.0000	14.51	9.13	23.64	43.50	-19.86	peak			
3		196.5167	12.86	11.84	24.70	43.50	-18.80	peak			
4	*	361.4167	13.95	18.82	32.77	46.00	-13.23	peak			
5		460.0333	4.18	20.70	24.88	46.00	-21.12	peak			
6		896.5333	0.86	28.52	29.38	46.00	-16.62	peak			

RESULT: PASS

The results shown in this test report refer only to the sample(s) tested unless otherwise stated and the sample(s) are retained for 30 days only. The document is issued by AGC, this document cannot be reproduced except in full with our prior written permission. The more details and the authenticity of the report will be confirmed at <http://www.agc-cert.com>.

RADIATED EMISSION TEST- (30MHZ-1GHZ) -VERTICAL

66.9 dBuV/m

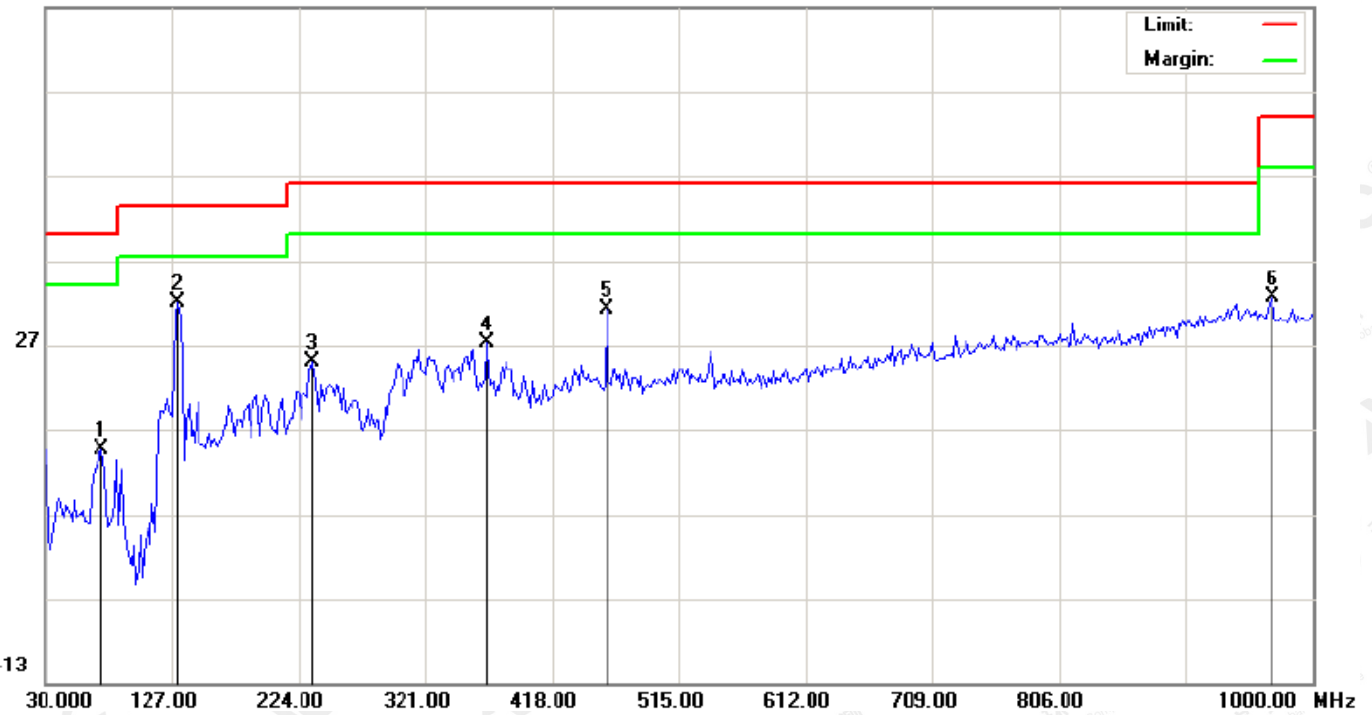

No.	Mk	Freq.	Reading	Factor	Measurement	Limit	Over	Detector	Antenna Height	Table Degree	Comment
		MHz	dBuV	dB/m	dBuV/m	dBuV/m	dB		cm	degree	
1		73.6500	11.17	3.36	14.53	40.00	-25.47	peak			
2	*	131.8500	20.23	11.80	32.03	43.50	-11.47	peak			
3		235.3167	12.47	12.46	24.93	46.00	-21.07	peak			
4		367.8833	8.26	18.86	27.12	46.00	-18.88	peak			
5		460.0333	10.56	20.70	31.26	46.00	-14.74	peak			
6		969.2833	2.76	29.81	32.57	54.00	-21.43	peak			

RESULT: PASS

Note: 1. Factor=Antenna Factor + Cable loss, Margin=Measurement-Limit.

2. The "Factor" value can be calculated automatically by software of measurement system.

3. All test modes for different EUT are pre-tested. The low channel for GFSK mode is the worst case and recorded in the report.

The results shown in this test report refer only to the sample(s) tested unless otherwise stated and the sample(s) are retained for 30 days only. The document is issued by AGC, this document cannot be reproduced except in full with our prior written permission. The more details and the authenticity of the report will be confirmed at <http://www.agc-cert.com>.

RADIATED EMISSION ABOVE 1GHZ

Frequency (MHz)	Emission Level (dB μ V/m)	Limits (dB μ V/m)	Margin (dB)	Detector Type	Comment
Low Channel (2402 MHz)					
4804	51.57	74	-22.43	Pk	Vertical
4804	38.99	54	-15.01	AV	Vertical
4804	51.5	74	-22.5	Pk	Horizontal
4804	51.57	74	-22.43	AV	Horizontal
Mid Channel (2440 MHz)					
4880	51.72	74	-22.28	Pk	Vertical
4880	39.14	54	-14.86	AV	Vertical
4880	51.65	74	-22.35	Pk	Horizontal
4880	38.63	54	-15.37	AV	Horizontal
High Channel (2480 MHz)					
4960	51.9	74	-22.1	pk	Vertical
4960	39.32	54	-14.68	AV	Vertical
4960	51.83	74	-22.17	pk	Horizontal
4960	38.81	54	-15.19	AV	Horizontal

RESULT: PASS

Note: 1~25GHz scan with GFSK. No recording in the test report at least have 20dB margin.

Factor = Antenna Factor + Cable Loss – Pre-amplifier.

Emission Level = Meter Reading + Factor

Margin = Emission - Leve Limit

The results shown in this test report refer only to the sample(s) tested unless otherwise stated and the sample(s) are retained for 30 days only. The document is issued by AGC, this document cannot be reproduced except in full with our prior written permission. The more details and the authenticity of the report will be confirmed at <http://www.agc-cert.com>.

8. BAND EDGE EMISSION

8.1. MEASUREMENT PROCEDURE

1) Radiated restricted band edge measurements

The radiated restricted band edge measurements are measured with an EMI test receiver connected to the receive antenna while the EUT is transmitting

2) Conducted Emissions at the bang edge

- a) The transmitter output was connected to the spectrum analyzer
- b) Set RBW=100kHz, VBW=300kHz
- c) Suitable frequency span including 100kHz bandwidth from band edge

8.2. TEST SET-UP

Radiated same as 6.2

Conducted set up

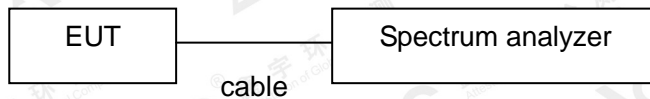

The results shown in this test report refer only to the sample(s) tested unless otherwise stated and the sample(s) are retained for 30 days only. The document is issued by AGC, this document cannot be reproduced except in full with our prior written permission. The more details and the authenticity of the report will be confirmed at <http://www.agc-cert.com>.

8.3. RADIATED TEST RESULT

Frequency (MHz)	Emission Level (dB μ V/m)	Limits (dB μ V/m)	Margin (dB)	Detector Type	Comment
GFSK					
2399.9	52.46	74	-21.54	peak	Vertical
2399.9	39.42	54	-14.58	AVG	Vertical
2399.9	52.82	74	-21.18	peak	Horizontal
2399.9	39.27	54	-14.73	AVG	Horizontal
2483.6	52.39	74	-21.61	peak	Vertical
2483.6	39.4	54	-14.6	AVG	Vertical
2483.6	53.47	74	-20.53	peak	Horizontal
2483.6	39.79	54	-14.21	AVG	Horizontal

RESULT: PASS

Note: Factor=Antenna Factor + Cable loss - Amplifier gain,

Emission Level = Meter Reading + Factor

Margin= Emission Level -Limit.

The "Factor" value can be calculated automatically by software of measurement system.

The results shown in this test report refer only to the sample(s) tested unless otherwise stated and the sample(s) are retained for 30 days only. The document is issued by AGC, this document cannot be reproduced except in full with our prior written permission. The more details and the authenticity of the report will be confirmed at <http://www.agc-cert.com>.

8.4. CONDUCTED TEST RESULT
Test Graph

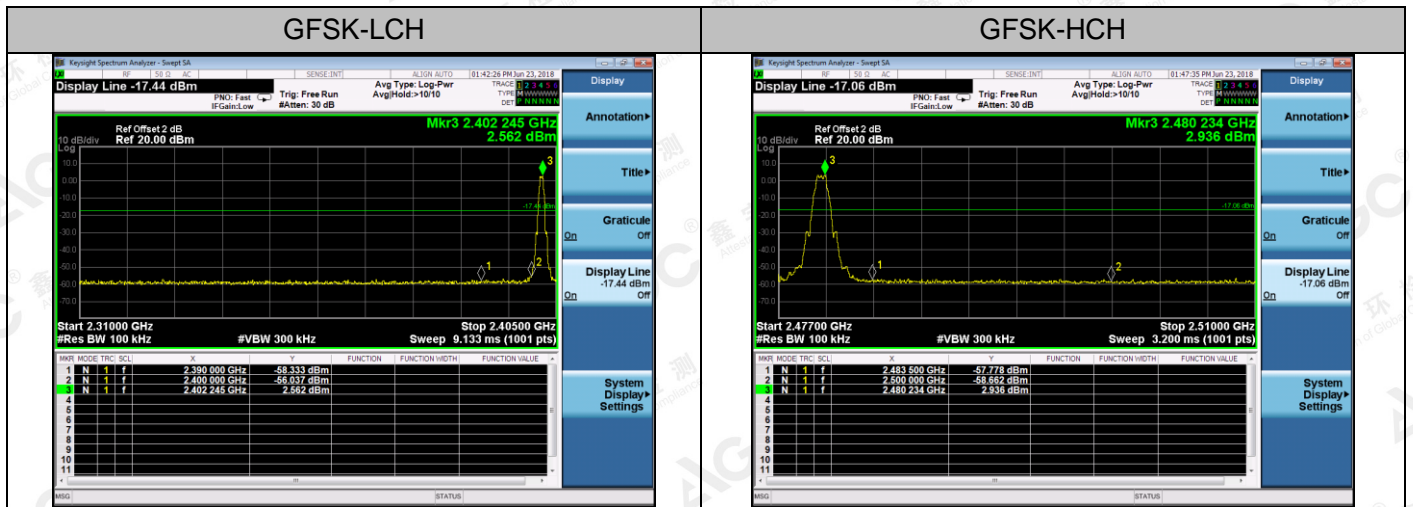

The results shown in this test report refer only to the sample(s) tested unless otherwise stated and the sample(s) are retained for 30 days only. The document is issued by AGC, this document cannot be reproduced except in full with our prior written permission. The more details and the authenticity of the report will be confirmed at <http://www.agc-cert.com>.

9.6DB BANDWIDTH

9.1. TEST PROCEDURE

1. Connect EUT RF output port to the Spectrum Analyzer through an RF attenuator
2. Set the EUT Work on the top, the middle and the bottom operation frequency individually.
3. Set SPA Centre Frequency = Operation Frequency, RBW= 100 KHz, VBW \geq RBW.
4. Set SPA Trace 1 Max hold, then View.

9.2. SUMMARY OF TEST RESULTS/PLOTS

Mode	Channel	6dB Bandwidth [KHz]	Verdict
BLE	LCH	715.8	PASS
BLE	MCH	714.3	PASS
BLE	HCH	717.0	PASS

Test Graph



The results shown in this test report refer only to the sample(s) tested unless otherwise stated and the sample(s) are retained for 30 days only. The document is issued by AGC, this document cannot be reproduced except in full with our prior written permission. The more details and the authenticity of the report will be confirmed at <http://www.agc-cert.com>.

10. CONDUCTED OUTPUT POWER

10.1. MEASUREMENT PROCEDURE

1. Connect EUT RF output port to the Spectrum Analyzer through an RF attenuator
2. Set the EUT Work on the top, middle and the bottom operation frequency individually.
3. Use the following spectrum analyzer settings:

Set the RBW \geq DTS bandwidth

Set the VBW \geq 3 x RBW

Set the span \geq 3 x RBW

Detector = peak

Sweep time = auto couple

Trace mode = max hold

4. Allow the trace to stabilize. Use peak marker function to determine the peak amplitude level
5. Record the result form the Spectrum Analyzer.

Note: The EUT was tested according to KDB 558074 for compliance to FCC 47CFR 15.247 requirements.

10.2. TEST SET-UP (BLOCK DIAGRAM OF CONFIGURATION)

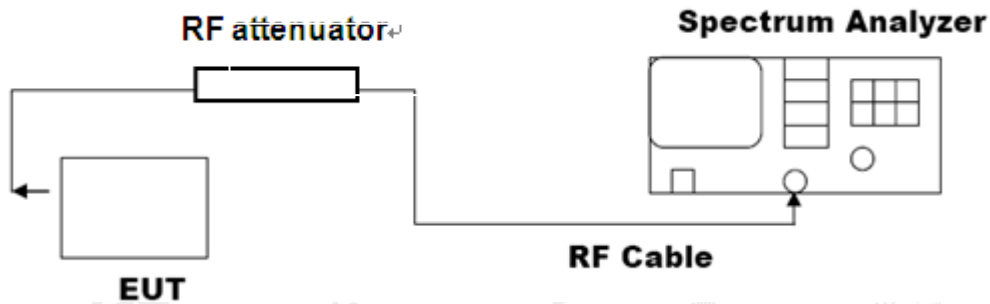

The results shown in this test report refer only to the sample(s) tested unless otherwise stated and the sample(s) are retained for 30 days only. The document is issued by AGC, this document cannot be reproduced except in full with our prior written permission. The more details and the authenticity of the report will be confirmed at <http://www.agc-cert.com>.

10.3. LIMITS AND MEASUREMENT RESULT

Channel	Peak Power (dBm)	Applicable Limits (dBm)	Pass/Fail
Low Channel	3.612	30	Pass
Middle Channel	3.179	30	Pass
High Channel	3.474	30	Pass

Test Graph



The results shown in this test report refer only to the sample(s) tested unless otherwise stated and the sample(s) are retained for 30 days only. The document is issued by AGC, this document cannot be reproduced except in full with our prior written permission. The more details and the authenticity of the report will be confirmed at <http://www.agc-cert.com>.

11. MAXIMUM CONDUCTED OUTPUT POWER SPECTRAL DENSITY

11.1 MEASUREMENT PROCEDURE

- (1). Connect EUT RF output port to the Spectrum Analyzer through an RF attenuator
- (2). Set the EUT Work on the top, the middle and the bottom operation frequency individually.
- (3). Set SPA Trace 1 Max hold, then View.

Note: The EUT was tested according to KDB 558074 for compliance to FCC 47CFR 15.247 requirements.

11.2 TEST SET-UP (BLOCK DIAGRAM OF CONFIGURATION)

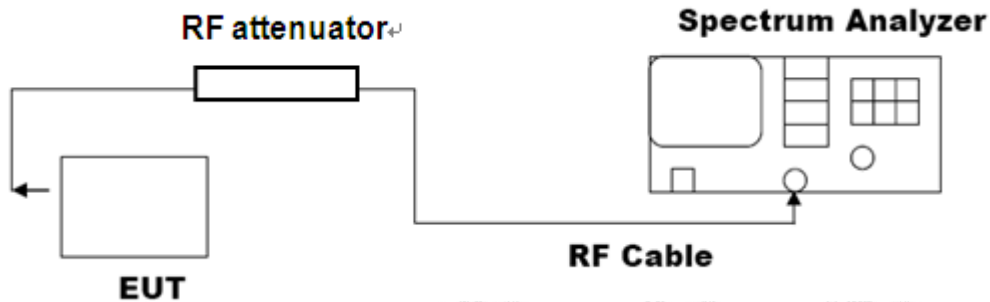

The results shown in this test report refer only to the sample(s) tested unless otherwise stated and the sample(s) are retained for 30 days only. The document is issued by AGC, this document cannot be reproduced except in full with our prior written permission. The more details and the authenticity of the report will be confirmed at <http://www.agc-cert.com>.

11.3 LIMITS AND MEASUREMENT RESULT

Mode	Channel	PSD [dBm/3kHz]	Limit[dBm/3kHz]	Verdict
BLE	LCH	-11.931	8	PASS
BLE	MCH	-11.839	8	PASS
BLE	HCH	-11.575	8	PASS

Test Graph

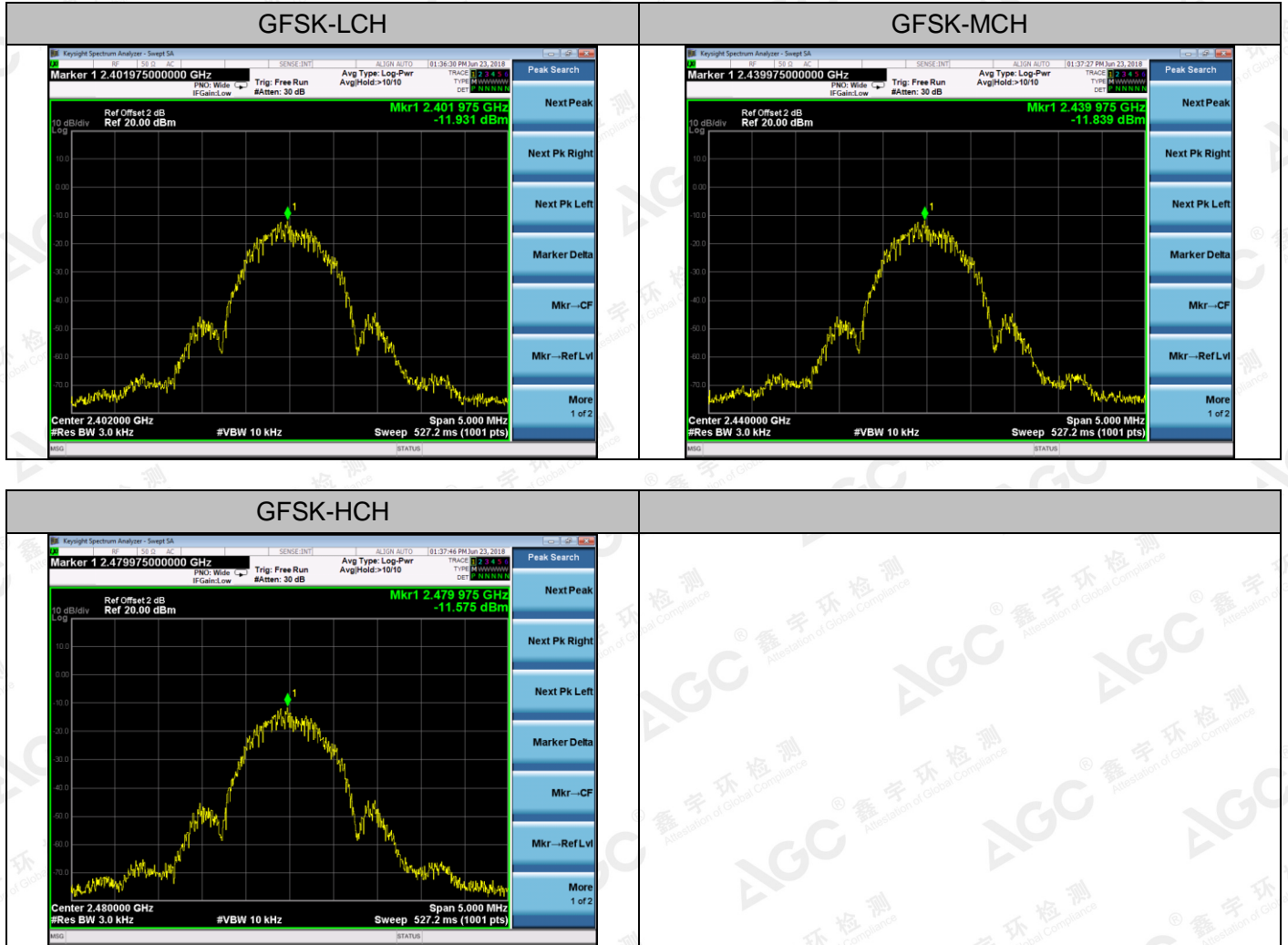

The results shown in this test report refer only to the sample(s) tested unless otherwise stated and the sample(s) are retained for 30 days only. The document is issued by AGC, this document cannot be reproduced except in full with our prior written permission. The more details and the authenticity of the report will be confirmed at <http://www.agc-cert.com>.

The results shown in this test report refer only to the sample(s) tested unless otherwise stated and the sample(s) are retained for 30 days only. The document is issued by AGC, this document cannot be reproduced except in full with our prior written permission. The more details and the authenticity of the report will be confirmed at <http://www.agc-cert.com>.

12. FCC LINE CONDUCTED EMISSION TEST

12.1 LIMITS

Frequency	Maximum RF Line Voltage	
	Q.P.(dBuV)	Average(dBuV)
150kHz~500kHz	66-56	56-46
500kHz~5MHz	56	46
5MHz~30MHz	60	50

****Note:** 1. The lower limit shall apply at the transition frequency.

2. The limit decreases linearly with the logarithm of the frequency in the range 0.15 MHz to 0.50 MHz

12.2 TEST SETUP

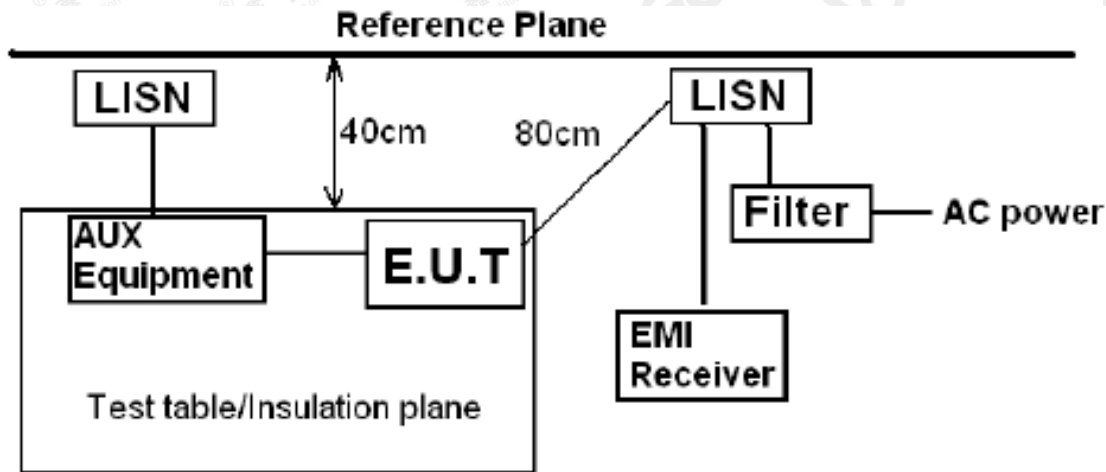

Remark

E.U.T: Equipment Under Test

LISN: Line Impedance Stabilization Network

Test table height=0.8m

The results shown in this test report refer only to the sample(s) tested unless otherwise stated and the sample(s) are retained for 30 days only. The document is issued by AGC, this document cannot be reproduced except in full with our prior written permission. The more details and the authenticity of the report will be confirmed at <http://www.agc-cert.com>.

12.3 PRELIMINARY PROCEDURE

- 1) The equipment was set up as per the test configuration to simulate typical actual usage per the user's manual. When the EUT is a tabletop system, a wooden table with a height of 0.8 meters is used and is placed on the ground plane as per ANSI C63.10 (see Test Facility for the dimensions of the ground plane used). When the EUT is a floor-standing equipment, it is placed on the ground plane which has a 3-12 mm non-conductive covering to insulate the EUT from the ground plane.
- 2) Support equipment, if needed, was placed as per ANSI C63.10.
- 3) All I/O cables were positioned to simulate typical actual usage as per ANSI C63.10.
- 4) All support equipments received AC120V/60Hz power from a LISN, if any.
- 5) The EUT received power by adapter which received power by a LISN.
- 6) The test program was started. Emissions were measured on each current carrying line of the EUT using a spectrum Analyzer / Receiver connected to the LISN powering the EUT. The LISN has two monitoring points: Line 1 (Hot Side) and Line 2 (Neutral Side). Two scans were taken: one with Line 1 connected to Analyzer / Receiver and Line 2 connected to a 50 ohm load; the second scan had Line 1 connected to a 50 ohm load and Line 2 connected to the Analyzer / Receiver.
- 7) Analyzer / Receiver scanned from 150 kHz to 30MHz for emissions in each of the test modes.
- 8) During the above scans, the emissions were maximized by cable manipulation.
- 9) The following test mode(s) were scanned during the preliminary test.
Then, the EUT configuration and cable configuration of the above highest emission level were recorded for reference of final testing.

12.4 FINAL TEST PROCEDURE

- 1) EUT and support equipment was set up on the test bench as per step 2 of the preliminary test.
- 2) A scan was taken on both power lines, Line 1 and Line 2, recording at least the six highest emissions. Emission frequency and amplitude were recorded into a computer in which correction factors were used to calculate the emission level and compare reading to the applicable limit. If EUT emission level was less -2dB to the A.V. limit in Peak mode, then the emission signal was re-checked using Q.P and Average detector.
- 3) The test data of the worst case condition(s) was reported on the Summary Data page.

The results shown in this test report refer only to the sample(s) tested unless otherwise stated and the sample(s) are retained for 30 days only. The document is issued by AGC, this document cannot be reproduced except in full with our prior written permission. The more details and the authenticity of the report will be confirmed at <http://www.agc-cert.com>.

12.5 TEST RESULT OF POWER LINE

Line Conducted Emission Test Line 1-L

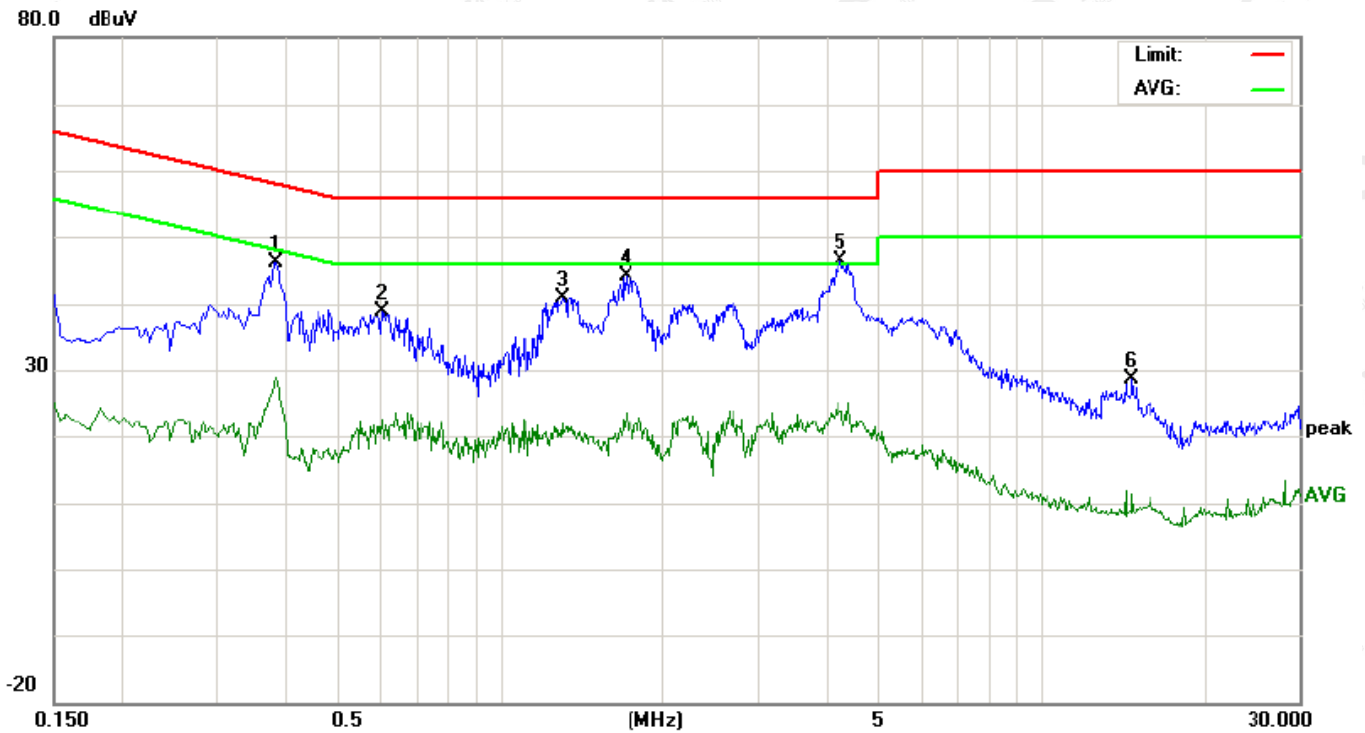

No.	Freq. (MHz)	Reading_Level (dBuV)			Correct Factor (dB)	Measurement (dBuV)			Limit (dBuV)		Margin (dB)		P/F	Comment
		Peak	QP	AVG		Peak	QP	AVG	QP	AVG	QP	AVG		
1	0.3860	35.77		18.66	10.32	46.09		28.98	58.15	48.15	-12.06	-19.17	P	
2	0.6060	28.57		12.21	10.31	38.88		22.52	56.00	46.00	-17.12	-23.48	P	
3	1.3140	30.53		10.04	10.38	40.91		20.42	56.00	46.00	-15.09	-25.58	P	
4	1.7140	33.88		13.22	10.31	44.19		23.53	56.00	46.00	-11.81	-22.47	P	
5	4.2538	35.99		13.44	10.32	46.31		23.76	56.00	46.00	-9.69	-22.24	P	
6	14.7259	18.42		1.38	10.12	28.54		11.50	60.00	50.00	-31.46	-38.50	P	

The results shown in this test report refer only to the sample(s) tested unless otherwise stated and the sample(s) are retained for 30 days only. The document is issued by AGC, this document cannot be reproduced except in full with our prior written permission. The more details and the authenticity of the report will be confirmed at <http://www.agc-cert.com>.

Line Conducted Emission Test Line 1-N

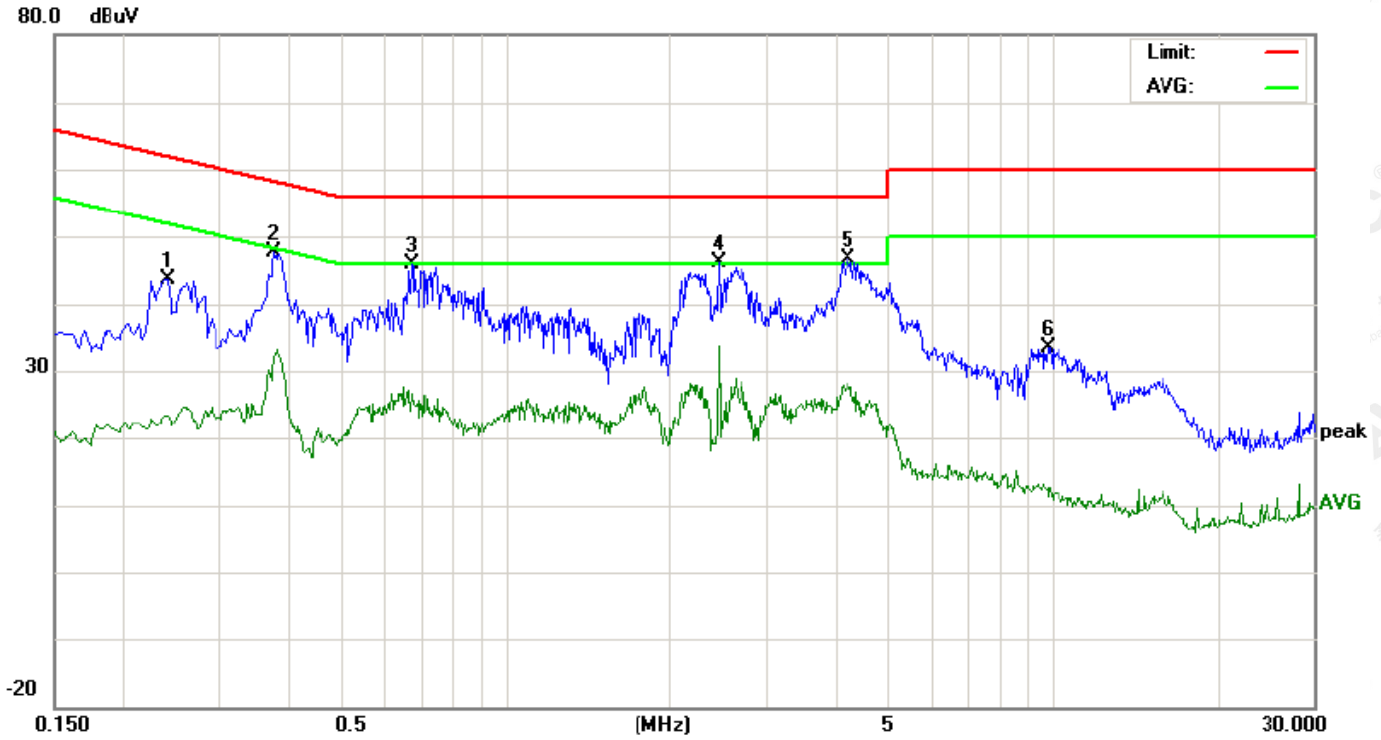

No.	Freq. (MHz)	Reading_Level (dBuV)			Correct Factor (dB)	Measurement (dBuV)			Limit (dBuV)		Margin (dB)		P/F	Comment
		Peak	QP	AVG		Peak	QP	AVG	QP	AVG	QP	AVG		
1	0.2420	33.37		13.11	10.26	43.63		23.37	62.02	52.02	-18.39	-28.65	P	
2	0.3780	37.20		21.71	10.32	47.52		32.03	58.32	48.32	-10.80	-16.29	P	
3	0.6740	35.50		16.19	10.34	45.84		26.53	56.00	46.00	-10.16	-19.47	P	
4	2.4539	35.74		23.21	10.41	46.15		33.62	56.00	46.00	-9.85	-12.38	P	
5	4.2419	36.37		17.82	10.32	46.69		28.14	56.00	46.00	-9.31	-17.86	P	
6	9.7899	23.22		2.50	10.21	33.43		12.71	60.00	50.00	-26.57	-37.29	P	

The results shown in this test report refer only to the sample(s) tested unless otherwise stated and the sample(s) are retained for 30 days only. The document is issued by AGC, this document cannot be reproduced except in full with our prior written permission. The more details and the authenticity of the report will be confirmed at <http://www.agc-cert.com>.

13. CONDUCTED SPURIOUS EMISSION

13.1. MEASUREMENT PROCEDURE

1. Connect EUT RF output port to the Spectrum Analyzer through an RF attenuator
2. Set the EUT Work on the top, the Middle and the bottom operation frequency individually.
3. Set the Span = wide enough to capture the peak level of the in-band emission and all spurious emissions from the lowest frequency generated in the EUT up through the 10th harmonic.
RBW = 100 kHz; VBW \geq RBW; Sweep = auto; Detector function = peak.
4. Set SPA Trace 1 Max hold, then View.

Note: The EUT was tested according to KDB 558074 for compliance to FCC 47CFR 15.247 requirements. Owing to satisfy the requirements of the number of measurement points, we set the RBW=1MHz, VBW>RBW, scan up through 10th harmonic, and consider the tested results as the worst case, if the tested results conform to the requirement, we can deem that the real tested results(set the RBW=100KHz, VBW>RBW) are conform to the requirement.

The results shown in this test report refer only to the sample(s) tested unless otherwise stated and the sample(s) are retained for 30 days only. The document is issued by AGC, this document cannot be reproduced except in full with our prior written permission. The more details and the authenticity of the report will be confirmed at <http://www.agc-cert.com>.

13.2. TEST SET-UP (BLOCK DIAGRAM OF CONFIGURATION)

The same as described in section 8.2

13.3. MEASUREMENT EQUIPMENT USED

The same as described in section 6

13.4. LIMITS AND MEASUREMENT RESULT

LIMITS AND MEASUREMENT RESULT		
Applicable Limits	Measurement Result	
	Test Data	Criteria
In any 100 KHZ Bandwidth Outside the frequency band in which the spread spectrum intentional radiator is operating, the radio frequency power that is produce by the intentional radiator shall be at least 20 dB below that in 100KHZ bandwidth within the band that contains the highest level of the desired power. In addition, radiation emissions which fall in the restricted bands, as defined in §15.205(a), must also comply with the radiated emission limits specified in§15.209(a)	At least -20dBc than the limit Specified on the BOTTOM Channel	PASS
	At least -20dBc than the limit Specified on the TOP Channel	PASS

The results shown in this test report refer only to the sample(s) tested unless otherwise stated and the sample(s) are retained for 30 days only. The document is issued by AGC, this document cannot be reproduced except in full with our prior written permission. The more details and the authenticity of the report will be confirmed at <http://www.agc-cert.com>.

Test Graph

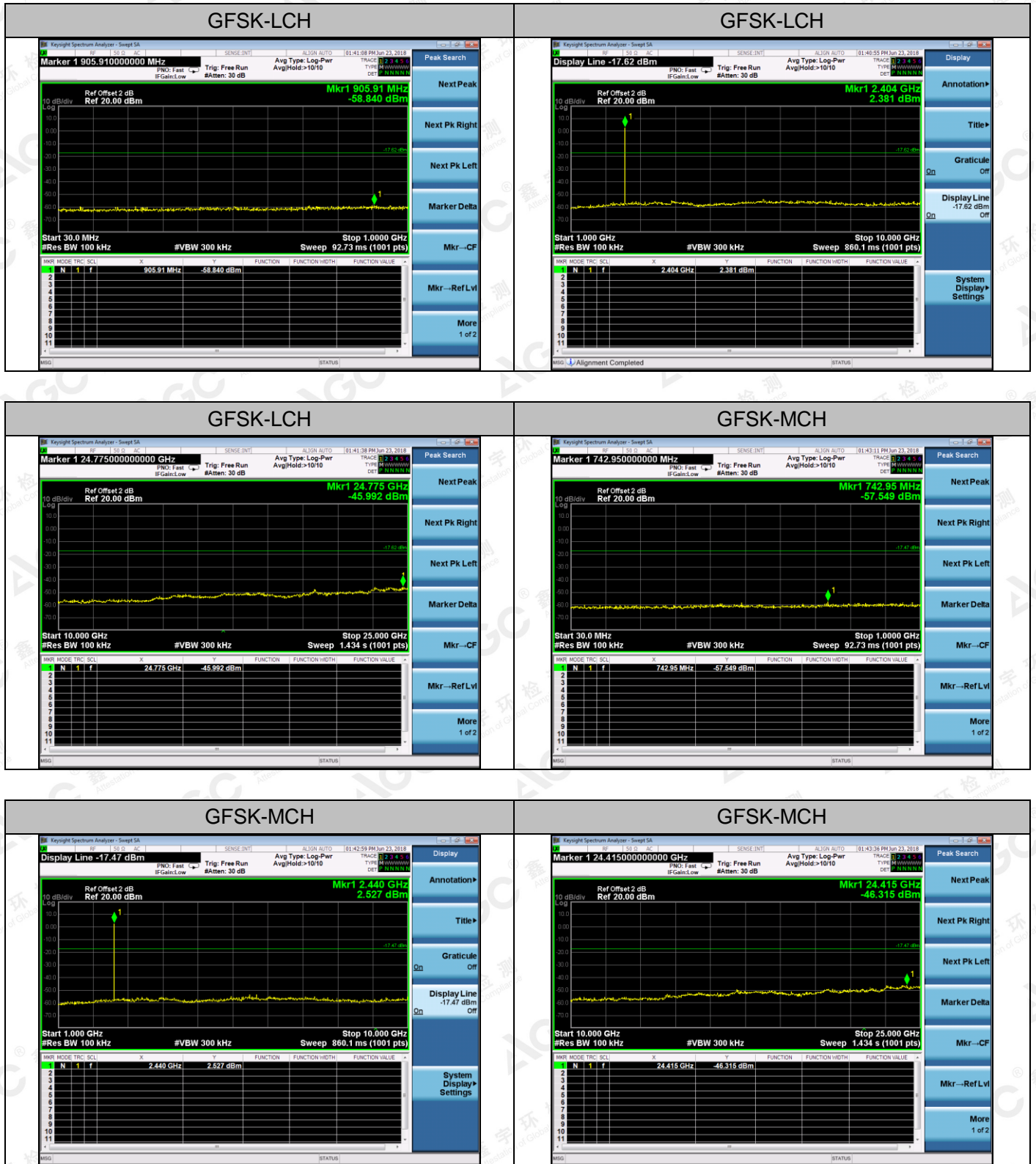

The results shown in this test report refer only to the sample(s) tested unless otherwise stated and the sample(s) are retained for 30 days only. The document is issued by AGC, this document cannot be reproduced except in full with our prior written permission. The more details and the authenticity of the report will be confirmed at <http://www.agc-cert.com>.

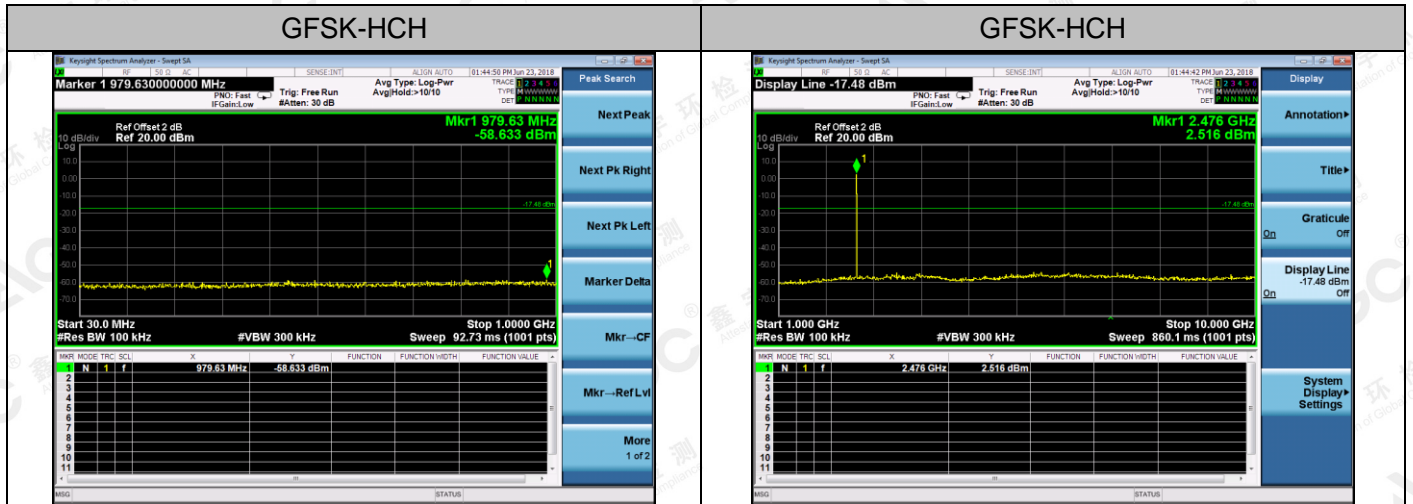

The results shown in this test report refer only to the sample(s) tested unless otherwise stated and the sample(s) are retained for 30 days only. The document is issued by AGC, this document cannot be reproduced except in full with our prior written permission. The more details and the authenticity of the report will be confirmed at <http://www.agc-cert.com>.

APPENDIX A: PHOTOGRAPHS OF TEST SETUP
LINE CONDUCTED EMISSION TEST SETUP



RADIATED EMISSION TEST SETUP

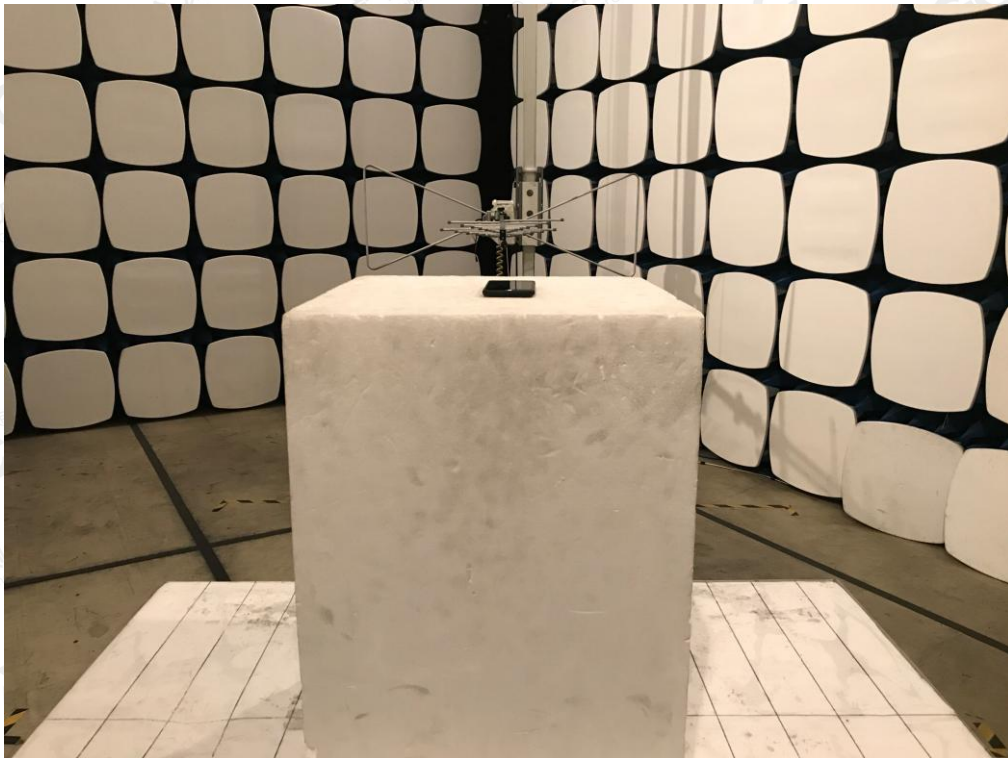

The results shown in this test report refer only to the sample(s) tested unless otherwise stated and the sample(s) are retained for 30 days only. The document is issued by AGC, this document cannot be reproduced except in full with our prior written permission. The more details and the authenticity of the report will be confirmed at <http://www.agc-cert.com>.

RADIATED EMISSION ABOVE 1G TEST SETUP

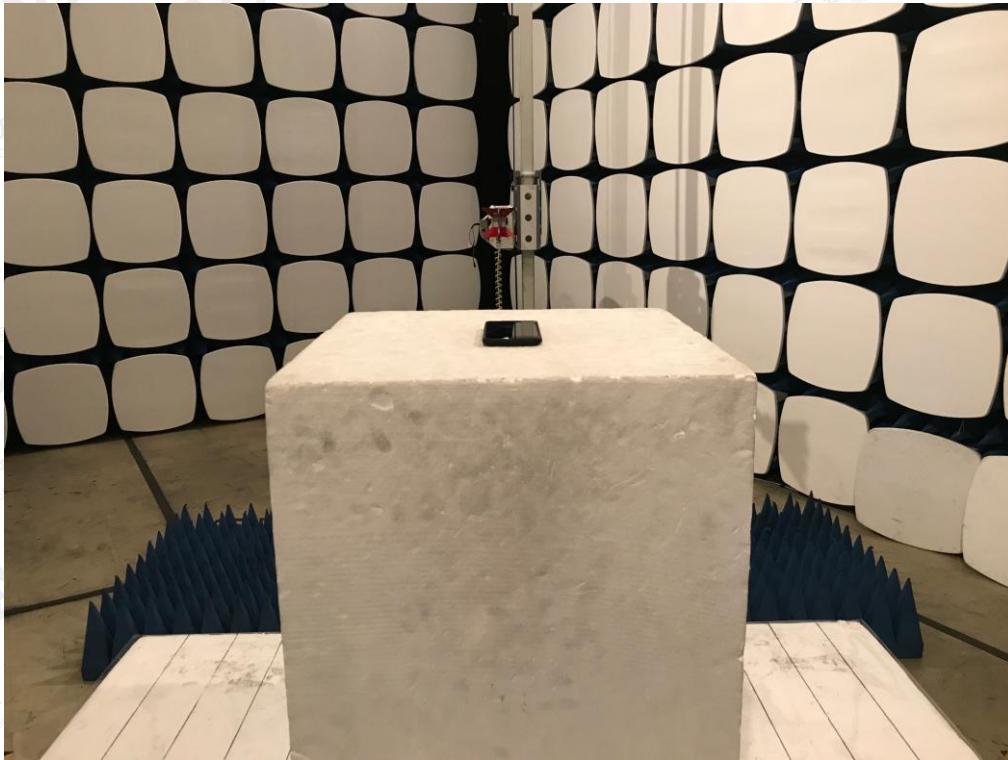

---END OF REPORT---

The results shown in this test report refer only to the sample(s) tested unless otherwise stated and the sample(s) are retained for 30 days only. The document is issued by AGC, this document cannot be reproduced except in full with our prior written permission. The more details and the authenticity of the report will be confirmed at <http://www.agc-cert.com>.