



FCC PART 22H, PART 24E  
TEST REPORT

For

**Mobile commodity corporation**

20955 Pathfinder Road, Suite 200 Diamond bar, California 91765, United States

**FCC ID: 2AF6M3396993M136**

<b>Report Type:</b> Original Report	<b>Product Type:</b> GSM Mobile Phone
<b>Test Engineer:</b> <u>William Li</u>	<i>William Li</i>
<b>Report Number:</b> <u>RSZ150925002-00C</u>	
<b>Report Date:</b> <u>2015-10-16</u>	
<b>Reviewed By:</b> <u>Jimmy Xiao</u> RF Engineer	<i>Jimmy Xiao</i>
<b>Prepared By:</b> Bay Area Compliance Laboratories Corp. (Shenzhen) 6/F, the 3rd Phase of WanLi Industrial Building ShiHua Road, FuTian Free Trade Zone Shenzhen, Guangdong, China Tel: +86-755-33320018 Fax: +86-755-33320008 <a href="http://www.baclcorp.com.cn">www.baclcorp.com.cn</a>	

**Note:** This test report is prepared for the customer shown above and for the device described herein. It may not be duplicated or used in part without prior written consent from Bay Area Compliance Laboratories Corp.

## TABLE OF CONTENTS

<b>GENERAL INFORMATION</b> .....	<b>4</b>
PRODUCT DESCRIPTION FOR EQUIPMENT UNDER TEST (EUT) .....	4
OBJECTIVE .....	4
RELATED SUBMITTAL(S)/GRANT(S).....	4
TEST METHODOLOGY .....	4
TEST FACILITY .....	5
<b>SYSTEM TEST CONFIGURATION</b> .....	<b>6</b>
DESCRIPTION OF TEST CONFIGURATION .....	6
EQUIPMENT MODIFICATIONS .....	6
SUPPORT EQUIPMENT LIST AND DETAILS .....	6
BLOCK DIAGRAM OF TEST SETUP .....	6
<b>SUMMARY OF TEST RESULTS</b> .....	<b>7</b>
<b>FCC §1.1307 &amp; §2.1093 - RF EXPOSURE</b> .....	<b>8</b>
APPLICABLE STANDARD .....	8
TEST RESULT .....	8
<b>FCC §2.1047 - MODULATION CHARACTERISTIC</b> .....	<b>9</b>
<b>FCC § 2.1046, § 22.913 (A) &amp; § 24.232 (C) - RF OUTPUT POWER</b> .....	<b>10</b>
APPLICABLE STANDARD .....	10
TEST PROCEDURE .....	10
TEST EQUIPMENT LIST AND DETAILS.....	10
TEST DATA .....	11
<b>FCC §2.1049, §22.917, §22.905 &amp; §24.238 - BANDWIDTH</b> .....	<b>13</b>
APPLICABLE STANDARD .....	13
TEST PROCEDURE .....	13
TEST EQUIPMENT LIST AND DETAILS.....	13
TEST DATA .....	13
<b>FCC §2.1051, §22.917(A) &amp; §24.238(A) - SPURIOUS EMISSIONS AT ANTENNA TERMINALS</b> .....	<b>17</b>
APPLICABLE STANDARD .....	17
TEST PROCEDURE .....	17
TEST EQUIPMENT LIST AND DETAILS.....	17
TEST DATA .....	17
<b>FCC §2.1053, §22.917 &amp; §24.238 - SPURIOUS RADIATED EMISSIONS</b> .....	<b>21</b>
APPLICABLE STANDARD .....	21
TEST PROCEDURE .....	21
TEST EQUIPMENT LIST AND DETAILS.....	21
TEST DATA .....	22
<b>FCC §22.917(A) &amp; §24.238(A) - BAND EDGES</b> .....	<b>23</b>
APPLICABLE STANDARD .....	23
TEST PROCEDURE .....	23
TEST EQUIPMENT LIST AND DETAILS.....	23
TEST DATA .....	23
<b>FCC §2.1055, §22.355 &amp; §24.235 - FREQUENCY STABILITY</b> .....	<b>26</b>

APPLICABLE STANDARD .....26  
TEST PROCEDURE .....26  
TEST EQUIPMENT LIST AND DETAILS.....27  
TEST DATA .....27

## GENERAL INFORMATION

---

### Product Description for Equipment under Test (EUT)

The *Mobile commodity corporation*'s product, model number: *M136 (FCC ID: 2AF6M3396993M136)* or the "EUT" in this report was a *GSM Mobile Phone*, which was measured approximately: 114 mm (L) × 47 mm (W) × 13 mm (H), rated with input voltage: DC 3.7 V rechargeable Li-ion battery or DC 5 V from adapter.

Adapter Information:

Input: AC100~240V

Output: DC 5.0V, 500mA

*\*All measurement and test data in this report was gathered from production sample serial number: 1506610 (Assigned by Shenzhen BAACL). The EUT supplied by the applicant was received on 2015-09-25.*

### Objective

This test report is prepared on behalf of *Mobile commodity corporation* in accordance with Part 2-Subpart J, Part 22-Subpart H and Part 24-Subpart E of the Federal Communication Commissions rules.

The objective is to determine the compliance of the EUT with FCC rules for output power, modulation characteristic, occupied bandwidth, and spurious emission at antenna terminal, spurious radiated emission, frequency stability and band edge.

### Related Submittal(s)/Grant(s)

FCC Part 15.247 DSS and Part 15B JBP submissions with FCC ID: 2AF6M3396993M136.

### Test Methodology

All tests and measurements indicated in this document were performed in accordance with the Code of Federal Regulations Title 47 Part 2-Subpart J as well as the following parts:

Part 22 Subpart H - Public Mobile Services

Part 24 Subpart E - Personal Communication Services

Applicable Standards: TIA/EIA 603-D, ANSI C63.4-2014.

All radiated and conducted emissions measurements were performed at Bay Area Compliance Laboratories Corp. The radiated testing was performed at an antenna-to-EUT distance of 3 meters.

Measurement uncertainty with radiated emission is 5.91 dB for 30MHz-1GHz and 4.92 dB for above 1GHz, 1.95dB for conducted measurement.

### **Test Facility**

The test site used by Bay Area Compliance Laboratories Corp.(Shenzhen) to collect test data is located on the 6/F, the 3rd Phase of WanLi Industrial Building, ShiHua Road, FuTian Free Trade Zone Shenzhen, Guangdong, China.

Test site at Bay Area Compliance Laboratories Corp. (Shenzhen) has been fully described in reports submitted to the Federal Communication Commission (FCC). The details of these reports have been found to be in compliance with the requirements of Section 2.948 of the FCC Rules on October 31, 2013. The facility also complies with the radiated and AC line conducted test site criteria set forth in ANSI C63.4-2014.

The Federal Communications Commission has the reports on file and is listed under FCC Registration No.: 382179. The test site has been approved by the FCC for public use and is listed in the FCC Public Access Link (PAL) database.

## SYSTEM TEST CONFIGURATION

### Description of Test Configuration

The EUT was configured for testing according to TIA/EIA-603-D.

The final qualification test was performed with the EUT operating at normal mode.

### Equipment Modifications

No modification was made to the EUT.

### Support Equipment List and Details

Manufacturer	Description	Model	Serial Number
Rohde & Schwarz	Universal Radio Communication Tester	CMU200	106891

### Block Diagram of Test Setup

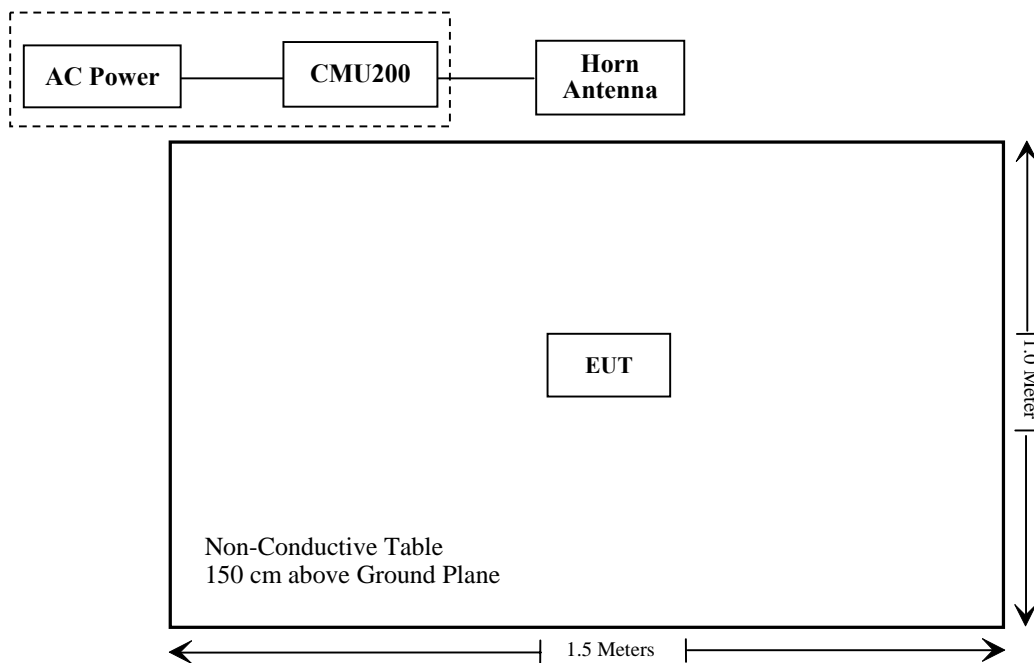

**SUMMARY OF TEST RESULTS**

<b>FCC Rules</b>	<b>Description of Test</b>	<b>Result</b>
§1.1307, §2.1093	RF Exposure (SAR)	Compliance*
§2.1046; § 22.913 (a); § 24.232 (c)	RF Output Power	Compliance
§ 2.1047	Modulation Characteristics	Not Applicable
§ 2.1049; § 22.905 § 22.917; § 24.238	Bandwidth	Compliance
§ 2.1051, § 22.917 (a); § 24.238 (a)	Spurious Emissions at Antenna Terminal	Compliance
§ 2.1053 § 22.917 (a); § 24.238 (a)	Field Strength of Spurious Radiation	Compliance
§ 22.917 (a); § 24.238 (a)	Out of band emission, Band Edge	Compliance
§ 2.1055 § 22.355; § 24.235	Frequency stability vs. temperature Frequency stability vs. voltage	Compliance

Note: \* Please refer to SAR report released by BACL, report number: RSZ150925002-20.

---

## **FCC §1.1307 & §2.1093 - RF EXPOSURE**

---

### **Applicable Standard**

FCC§1.1307 and §2.1093.

### **Test Result**

Compliance, please refer to the SAR report: RSZ150925002-20.



---

## **FCC §2.1047 - MODULATION CHARACTERISTIC**

---

According to FCC § 2.1047(d), Part 22H & 24E there is no specific requirement for digital modulation, therefore modulation characteristic is not presented.

## **FCC § 2.1046, § 22.913 (a) & § 24.232 (c) - RF OUTPUT POWER**

### **Applicable Standard**

According to FCC §2.1046 and §22.913 (a), the ERP of mobile transmitters and auxiliary test transmitters must not exceed 7 watts.

According to FCC §2.1046 and §24.232 (C), mobile and portable stations are limited to 2 watts EIRP and the equipment must employ a means for limiting power to the minimum necessary for successful communications.

### **Test Procedure**

*Conducted method:*

The RF output of the transmitter was connected to the wireless test set and the spectrum analyzer through sufficient attenuation.

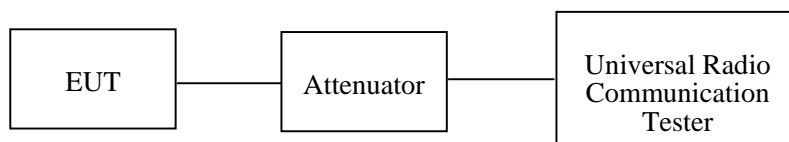

*Radiated method:*

TIA 603-D section 2.2.17

### **Test Equipment List and Details**

<b>Manufacturer</b>	<b>Description</b>	<b>Model</b>	<b>Serial Number</b>	<b>Calibration Date</b>	<b>Calibration Due Date</b>
Sunol Sciences	Horn Antenna	DRH-118	A052604	2014-12-29	2017-12-28
Rohde & Schwarz	Signal Analyzer	FSIQ26	8386001028	2014-12-11	2015-12-11
Rohde & Schwarz	EMI Test Receiver	ESCI	101120	2014-11-03	2015-11-03
Sunol Sciences	Bi-log Antenna	JB1	A040904-2	2014-12-07	2017-12-06
HP	Signal Generator	HP 8341B	2624A00116	2015-06-03	2016-06-03
COM POWER	Dipole Antenna	AD-100	041000	2015-08-18	2016-08-18
A.H. System	Horn Antenna	SAS-200/571	135	2013-02-10	2016-02-10
Rohde & Schwarz	Universal Radio Communication Tester	CMU200	106891	2014-11-23	2015-11-23

\* **Statement of Traceability:** Bay Area Compliance Laboratories Corp. (Shenzhen) attests that all calibrations have been performed in accordance to requirements that traceable to National Primary Standards and International System of Units (SI).

**Test Data**

**Environmental Conditions**

<b>Temperature:</b>	25 °C
<b>Relative Humidity:</b>	51 %
<b>ATM Pressure:</b>	101.0 kPa

*The testing was performed by William Li on 2015-10-12.*

**Conducted Power**

**Cellular Band (Part 22H)**

Mode	Channel	Frequency (MHz)	Average Output Power (dBm)	Limit (dBm)
GSM	128	824.2	32.02	38.45
	190	836.6	32.74	38.45
	251	848.8	32.61	38.45

Mode	Channel	Frequency (MHz)	Average Output Power (dBm)				Limit (dBm)
			1 slot	2 slots	3 slots	4 slots	
GPRS	128	824.2	32.24	31.14	29.31	28.27	38.45
	190	836.6	32.71	32.08	30.18	29.14	38.45
	251	848.8	32.58	32.05	30.28	29.26	38.45

**PCS Band (Part 24E)**

Mode	Channel	Frequency (MHz)	Average Output Power (dBm)	Limit (dBm)
GSM	512	1850.2	29.48	33
	661	1880.0	29.54	33
	810	1909.8	29.53	33

Mode	Channel	Frequency (MHz)	Average Output Power (dBm)				Limit (dBm)
			1 slot	2 slots	3 slots	4 slots	
GPRS	512	1850.2	29.47	29.04	27.73	26.62	33
	661	1880.0	29.55	29.08	28.49	27.68	33
	810	1909.8	29.44	29.06	28.62	27.92	33

**Peak-to-average ratio (PAR)**

**Cellular Band**

Mode	Channel	PAR (dB)	Limit (dB)
GSM	Low	0.26	13
	Middle	0.29	13
	High	0.28	13

**PCS Band**

Mode	Channel	PAR (dB)	Limit (dB)
GSM	Low	0.24	13
	Middle	0.27	13
	High	0.25	13

**Radiated Power (Measured at Max. conducted power channel):**

**GSM Mode:**

Frequency (MHz)	Receiver Reading (dBµV)	Turntable Angle Degree	Rx Antenna		Substituted			Absolute Level (dBm)	FCC Part 22H/24E	
			Height (m)	Polar (H/V)	S.G. Level (dBm)	Cable loss (dB)	Antenna Gain (dB)		Limit (dBm)	Margin (dB)
ERP for Cellular Band (Part 22H), Middle Channel										
836.60	97.72	153	2.1	H	28.7	0.67	0	28.03	38.45	10.42
836.60	96.54	221	1.8	V	27.5	0.67	0	26.83	38.45	11.62
EIRP for PCS Band (Part 24E), Middle Channel										
1880.00	87.46	68	1.3	H	18.8	1.40	7.30	24.70	33	8.3
1880.00	86.80	245	2.4	V	17.6	1.40	7.30	23.50	33	9.5

**Note:**

All above data were tested with no amplifier.  
 Absolute Level = SG Level - Cable loss + Antenna Gain  
 Margin = Limit- Absolute Level

## FCC §2.1049, §22.917, §22.905 & §24.238 - BANDWIDTH

### Applicable Standard

FCC §2.1049, §22.917, §22.905 and §24.238.

### Test Procedure

The RF output of the transmitter was connected to the simulator and the spectrum analyzer through sufficient attenuation.

The resolution bandwidth of the spectrum analyzer was set at 5 kHz (Cellular /PCS) & 100 kHz (WCDMA) and the 26 dB & 99% bandwidth was recorded.

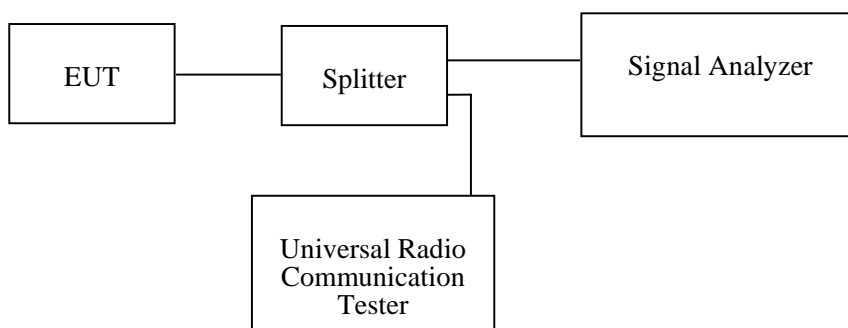

### Test Equipment List and Details

Manufacturer	Description	Model	Serial Number	Calibration Date	Calibration Due Date
Rohde & Schwarz	Signal Analyzer	FSIQ26	8386001028	2014-12-11	2015-12-11
Rohde & Schwarz	Universal Radio Communication Tester	CMU200	106891	2014-11-23	2015-11-23

\* **Statement of Traceability:** Bay Area Compliance Laboratories Corp. (Shenzhen) attests that all calibrations have been performed in accordance to requirements that traceable to National Primary Standards and International System of Units (SI).

### Test Data

#### Environmental Conditions

Temperature:	25 °C
Relative Humidity:	51 %
ATM Pressure:	101.0 kPa

*The testing was performed by William Li on 2015-10-12.*

*EUT operation mode: Transmitting*

*Test Result: Compliance. Please refer to the following tables and plots.*

Cellular Band (Part 22H)

<b>Mode</b>	<b>Frequency (MHz)</b>	<b>99% Occupied Bandwidth (kHz)</b>	<b>26 dB Emission Bandwidth (kHz)</b>
GSM(GMSK)	836.6	243.13	321.30

PCS Band (Part 24E)

<b>Mode</b>	<b>Frequency (MHz)</b>	<b>99% Occupied Bandwidth (kHz)</b>	<b>26 dB Emission Bandwidth (kHz)</b>
GSM(GMSK)	1880.0	244.57	315.50

**Cellular Band (Part 22H)**

**99% Occupied Bandwidth for GSM (GMSK) Mode**

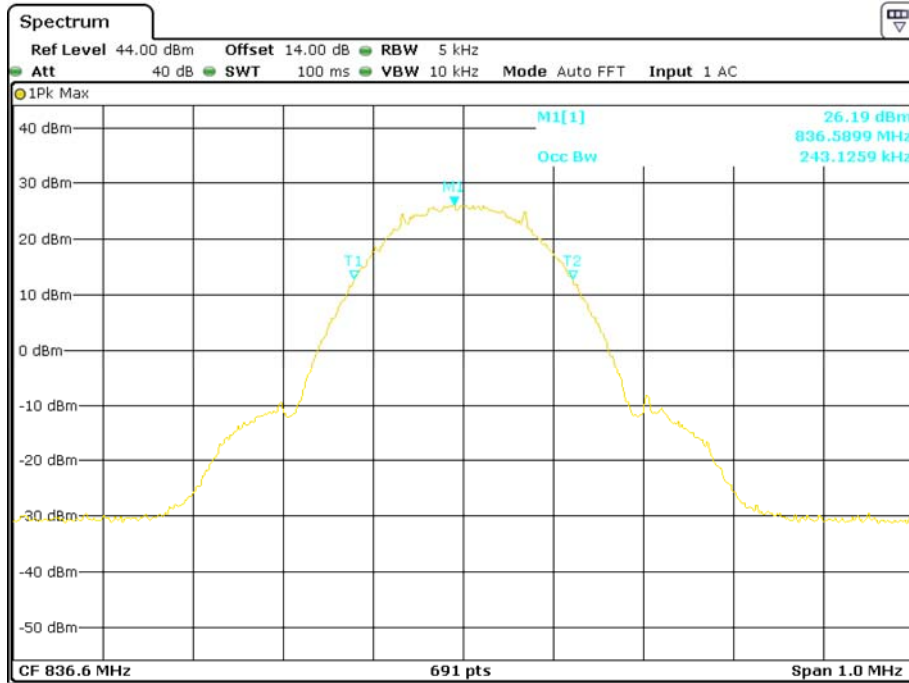

Date: 12.OCT.2015 14:35:06

**26 dB Emissions Bandwidth for GSM (GMSK) Mode**



Date: 12.OCT.2015 14:23:09

PCS Band (Part 24E)

99% Occupied Bandwidth for GSM (GMSK) Mode

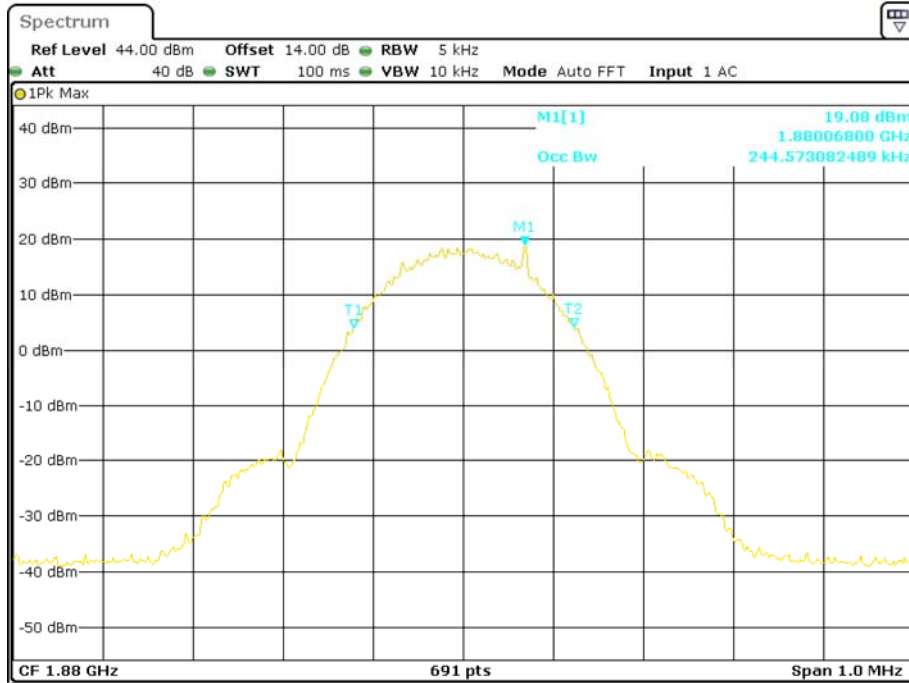

Date: 12.OCT.2015 14:15:09

26 dB Emissions Bandwidth for GSM (GMSK) Mode

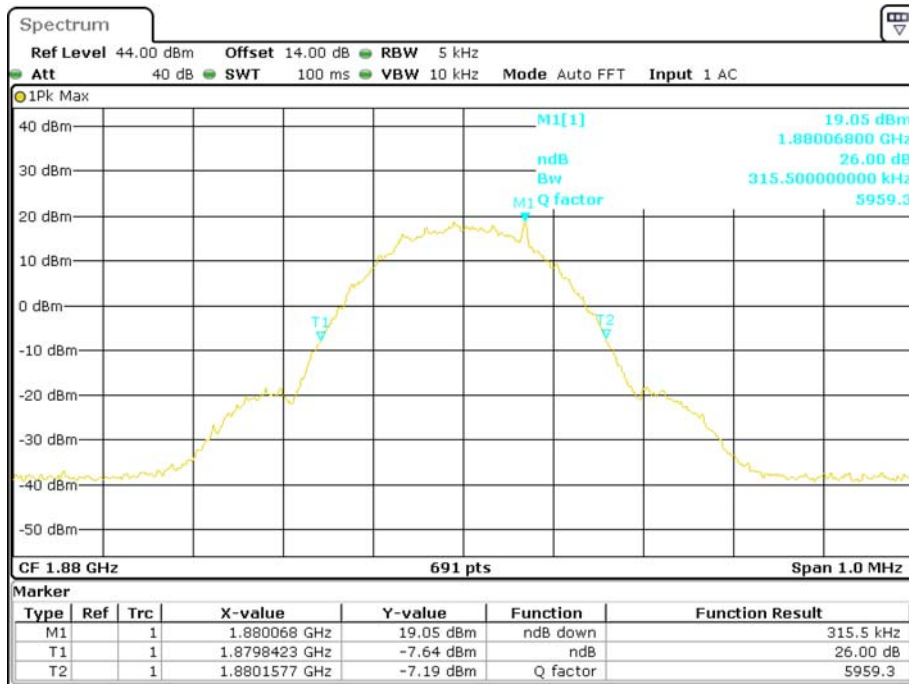

Date: 12.OCT.2015 14:14:31



## FCC §2.1051, §22.917(a) & §24.238(a) - SPURIOUS EMISSIONS AT ANTENNA TERMINALS

### Applicable Standard

FCC §2.1051, §22.917(a) and §24.238(a).

The spectrum was to be investigated to the tenth harmonics of the highest fundamental frequency as specified in § 2.1051.

### Test Procedure

The RF output of the transceiver was connected to a spectrum analyzer and simulator through appropriate attenuation. The resolution bandwidth of the spectrum analyzer was set at 1MHz. Sufficient scans were taken to show any out of band emissions up to 10<sup>th</sup> harmonic.

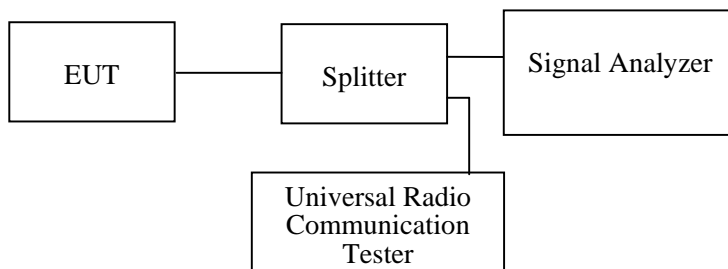

### Test Equipment List and Details

Manufacturer	Description	Model	Serial Number	Calibration Date	Calibration Due Date
Rohde & Schwarz	Signal Analyzer	FSIQ26	8386001028	2014-12-11	2015-12-11
Rohde & Schwarz	Universal Radio Communication Tester	CMU200	106891	2014-11-23	2015-11-23

\* **Statement of Traceability:** Bay Area Compliance Laboratories Corp. (Shenzhen) attests that all calibrations have been performed in accordance to requirements that traceable to National Primary Standards and International System of Units (SI).

### Test Data

#### Environmental Conditions

<b>Temperature:</b>	25 °C
<b>Relative Humidity:</b>	51 %
<b>ATM Pressure:</b>	101.0 kPa

*The testing was performed by William Li on 2015-10-12.*

*Test result: Compliance, please refer to the following plots.*

**Cellular Band (Part 22H)**

**30 MHz – 1 GHz (GSM Mode)**

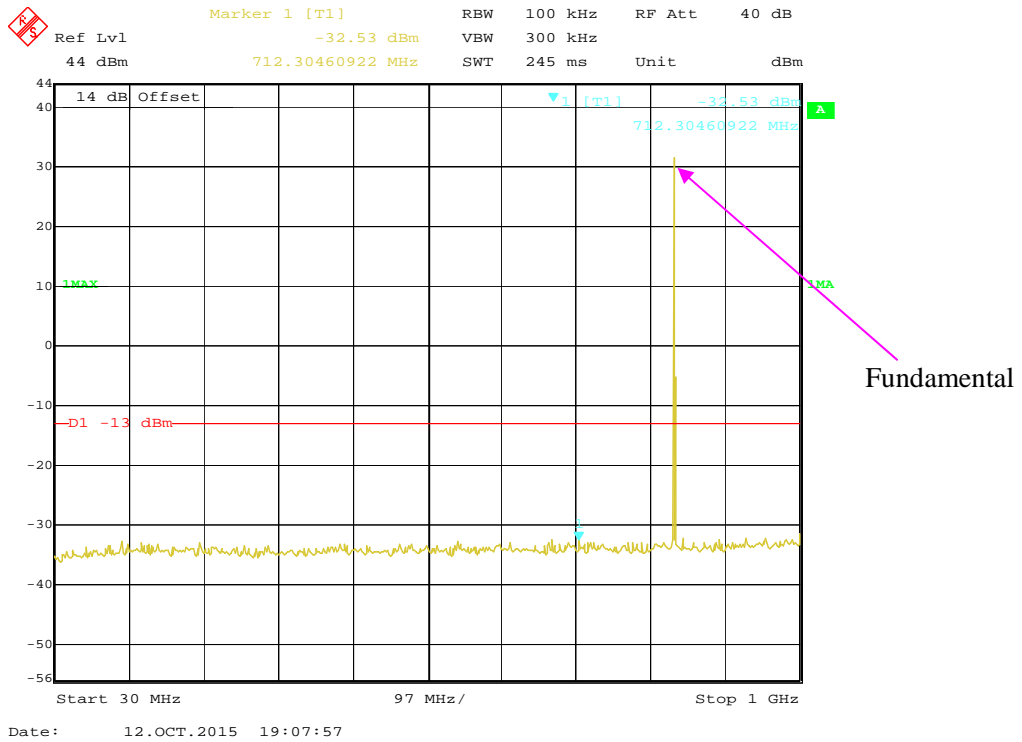

**1 GHz – 10 GHz (GSM Mode)**

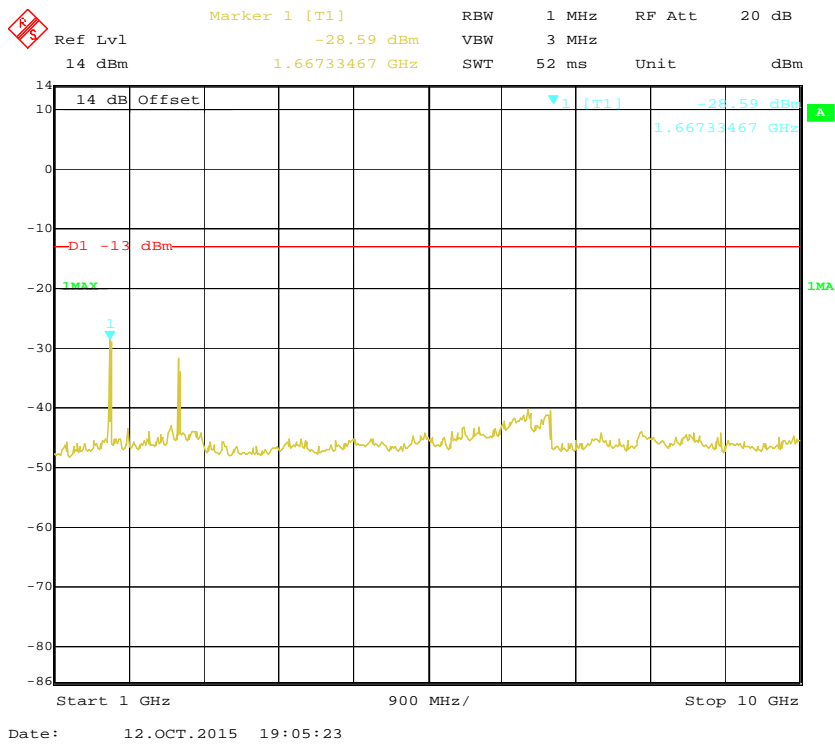

PCS Band (Part 24E)

30 MHz – 1 GHz (GSM Mode)

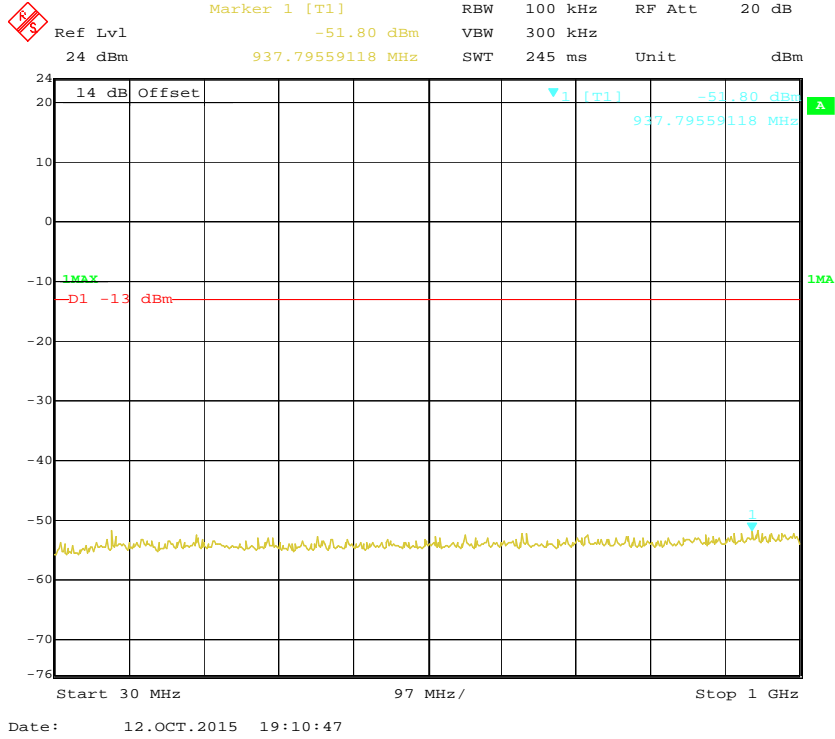

1 GHz – 2 GHz (GSM Mode)

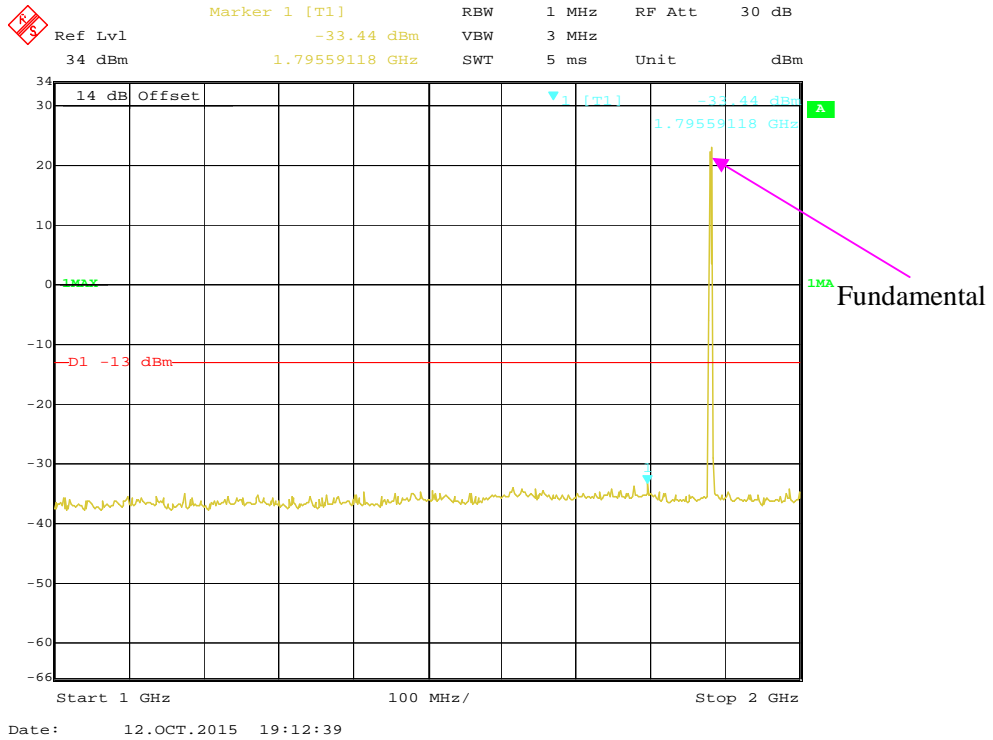

### 2 GHz – 20 GHz (GSM Mode)

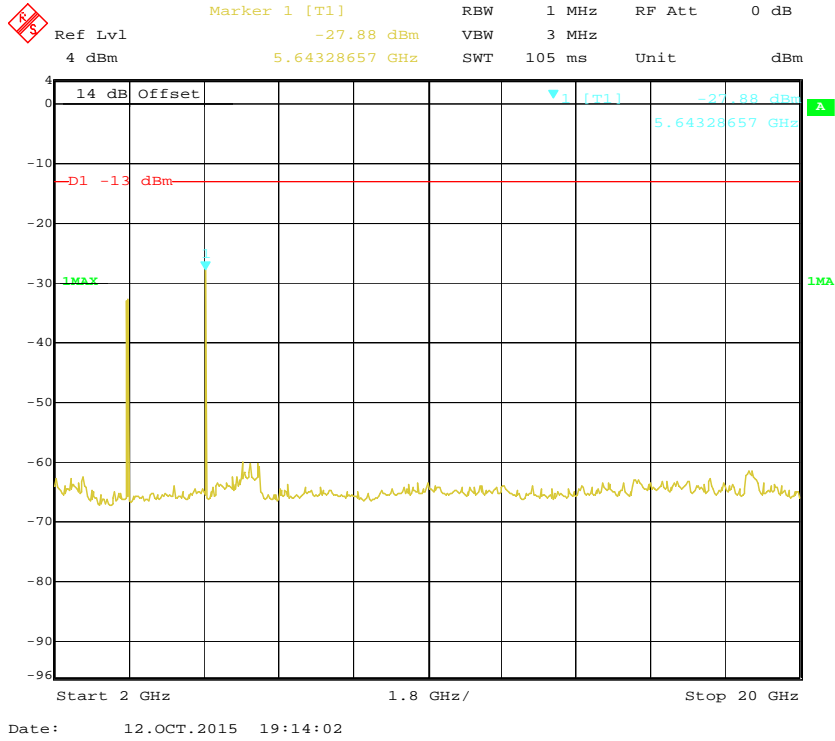

## FCC §2.1053, §22.917 & §24.238 - SPURIOUS RADIATED EMISSIONS

### Applicable Standard

FCC § 2.1053, §22.917 and § 24.238.

### Test Procedure

The transmitter was placed on a wooden turntable, and it was transmitting into a non-radiating load which was also placed on the turntable.

The measurement antenna was placed at a distance of 3 meters from the EUT. During the tests, the receiving antenna height and polarization as well as EUT azimuth were varied in order to identify the maximum level of emissions from the EUT. The test was performed by placing the EUT on 3-orthogonal axis.

The frequency range up to tenth harmonic of the fundamental frequency was investigated.

Remove the EUT and replace it with substitution antenna. A signal generator was connected to the substitution antenna by a non-radiating cable. The absolute levels of the spurious emissions were measured by the substitution.

Spurious emissions in dB = 10 lg (TXpwr in Watts/0.001) – the absolute level

Spurious attenuation limit in dB = 43 + 10 Log<sub>10</sub> (power out in Watts)

### Test Equipment List and Details

Manufacturer	Description	Model	Serial Number	Calibration Date	Calibration Due Date
Sunol Sciences	Horn Antenna	DRH-118	A052604	2014-12-29	2017-12-28
Sunol Sciences	Bi-log Antenna	JB1	A040904-2	2014-12-07	2017-12-06
Rohde & Schwarz	Signal Analyzer	FSIQ26	8386001028	2014-12-11	2015-12-11
Rohde & Schwarz	EMI Test Receiver	ESCI	101120	2014-11-03	2015-11-03
Mini	Pre-amplifier	ZVA-183-S+	5969001149	2015-04-23	2016-04-23
HP	Amplifier	HP8447E	1937A01046	2015-05-06	2016-05-06
HP	Signal Generator	HP 8341B	2624A00116	2015-06-03	2016-06-03
COM POWER	Dipole Antenna	AD-100	041000	2015-08-18	2016-08-18
A.H. System	Horn Antenna	SAS-200/571	135	2013-02-11	2016-02-10
Electro-Mechanics	Horn Antenna	3116	9510-2270	2013-10-14	2016-10-13
Rohde & Schwarz	Universal Radio Communication Tester	CMU200	106891	2014-11-23	2015-11-23

\* **Statement of Traceability:** Bay Area Compliance Laboratories Corp. (Shenzhen) attests that all calibrations have been performed in accordance to requirements that traceable to National Primary Standards and International System of Units (SI).

**Test Data**

**Environmental Conditions**

<b>Temperature:</b>	25 °C
<b>Relative Humidity:</b>	51 %
<b>ATM Pressure:</b>	101.0 kPa

The testing was performed by William Li on 2015-10-12.

EUT operation mode: Transmitting (worst case)

**GSM Mode**

Frequency (MHz)	Receiver Reading (dBµV)	Turntable Angle Degree	Rx Antenna		Substituted			Absolute Level (dBm)	FCC Part 22H/24E	
			Height (m)	Polar (H/V)	SG Level (dBm)	Cable Loss (dB)	Antenna Gain (dB)		Limit (dBm)	Margin (dB)
GSM 850, Middle channel										
208.43	36.24	239	1.8	H	-60.8	0.30	0	-61.10	-13	48.10
208.43	35.27	41	1.4	V	-61.7	0.30	0	-62.00	-13	49.00
1673.20	56.95	211	1.6	H	-38.8	1.60	6.90	-33.50	-13	20.50
1673.20	55.95	354	1.4	V	-40.2	1.60	6.90	-34.90	-13	21.90
2509.80	46.17	254	2.0	H	-47.4	1.70	8.60	-40.50	-13	27.50
2509.80	45.91	290	1.6	V	-48.0	1.70	8.60	-41.10	-13	28.10
3346.40	53.44	112	1.7	H	-36.9	1.90	9.80	-29.00	-13	16.00
3346.40	48.7	27	1.5	V	-42.3	1.90	9.80	-34.40	-13	21.40
PCS 1900, Middle channel										
208.43	36.88	281	1.8	H	-60.1	0.30	0	-60.40	-13	47.40
208.43	35.06	98	1.6	V	-61.9	0.30	0	-62.20	-13	49.20
3760.00	56.95	136	1.2	H	-30.1	1.90	9.90	-22.10	-13	9.10
3760.00	58.73	6	1.4	V	-27.9	1.90	9.90	-19.90	-13	6.90
5640.00	51.15	12	1.7	H	-31.4	2.10	10.30	-23.20	-13	10.20
5640.00	43.42	104	1.8	V	-38.5	2.10	10.30	-30.30	-13	17.30
7520.00	37.09	8	1.9	H	-42.6	2.60	10.70	-34.50	-13	21.50
7520.00	32.65	313	2.3	V	-48.1	2.60	10.70	-40.00	-13	27.00
9400.00	41.29	270	1.7	H	-35.2	2.70	11.50	-26.40	-13	13.40
9400.00	37.31	133	1.7	V	-41.1	2.70	11.50	-32.30	-13	19.30

Note:

- 1) Absolute Level = SG Level - Cable loss + Antenna Gain
- 2) Margin = Limit- Absolute Level

## FCC §22.917(a) & §24.238(a) - BAND EDGES

### Applicable Standard

According to § 22.917(a), the power of any emissions outside of the authorized operating frequency ranges must be attenuated below the transmitting power (P) by a factor of at least  $43 + 10 \log(P)$  dB.

According to §24.238(a), the power of any emissions outside of the authorized operating frequency ranges must be attenuated below the transmitting power (P) by a factor of at least  $43 + 10 \log(P)$  dB.

### Test Procedure

The RF output of the transmitter was connected to the input of the spectrum analyzer through sufficient attenuation.

The center of the spectrum analyzer was set to block edge frequency

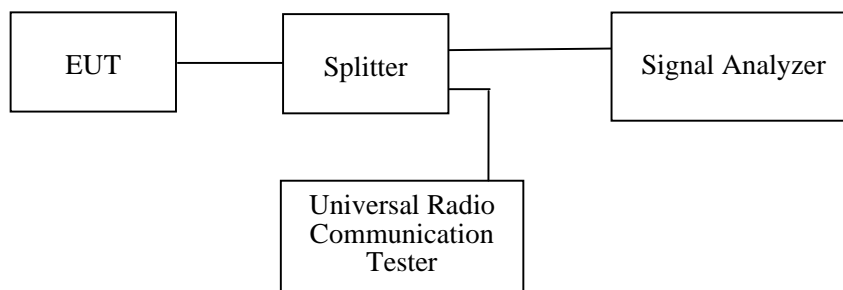

### Test Equipment List and Details

Manufacturer	Description	Model	Serial Number	Calibration Date	Calibration Due Date
Rohde & Schwarz	EMI Test Receiver	ESR	1316.3003K03 -101746-zn	2015-06-13	2016-06-13
Rohde & Schwarz	Universal Radio Communication Tester	CMU200	106891	2014-11-23	2015-11-23

\* **Statement of Traceability:** Bay Area Compliance Laboratories Corp. (Shenzhen) attests that all calibrations have been performed in accordance to requirements that traceable to National Primary Standards and International System of Units (SI).

### Test Data

#### Environmental Conditions

<b>Temperature:</b>	25 °C
<b>Relative Humidity:</b>	51 %
<b>ATM Pressure:</b>	101.0 kPa

*The testing was performed by William Li on 2015-10-12.*

*EUT operation mode: Transmitting*

*Test Result: Compliance. Please refer to the following plots.*

### Cellular Band, Left Band Edge for GSM (GMSK) Mode

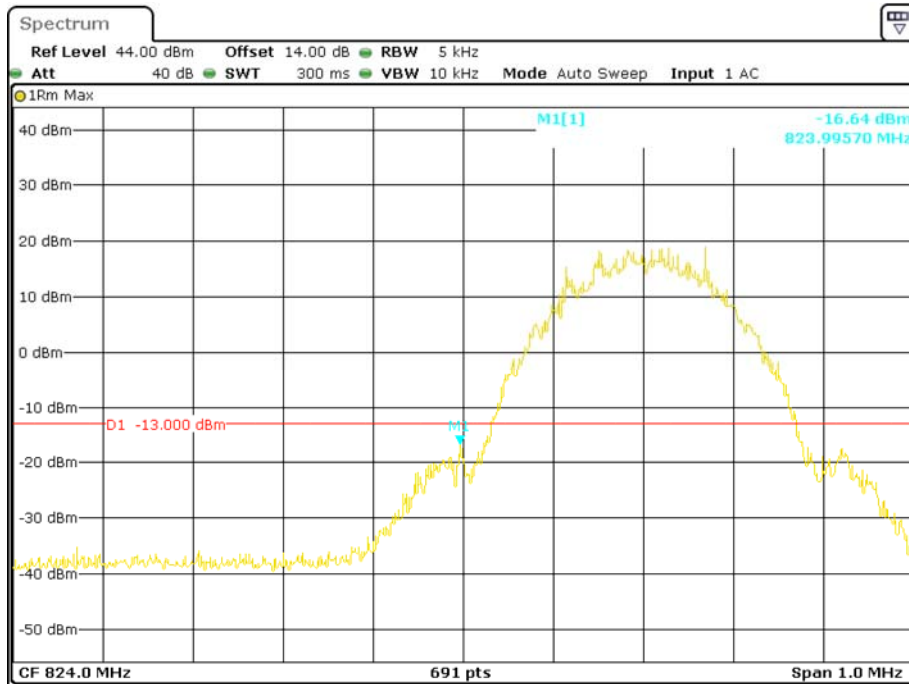

Date: 12.OCT.2015 14:21:04

### Cellular Band, Right Band Edge for GSM (GMSK) Mode

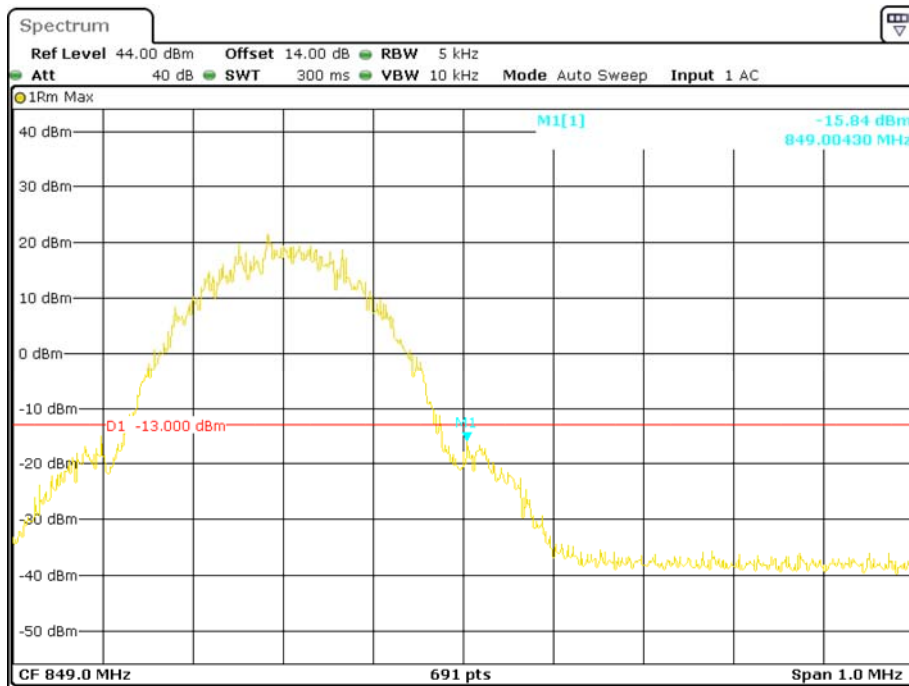

Date: 12.OCT.2015 14:19:58



### PCS Band, Left Band Edge for GSM (GMSK) Mode

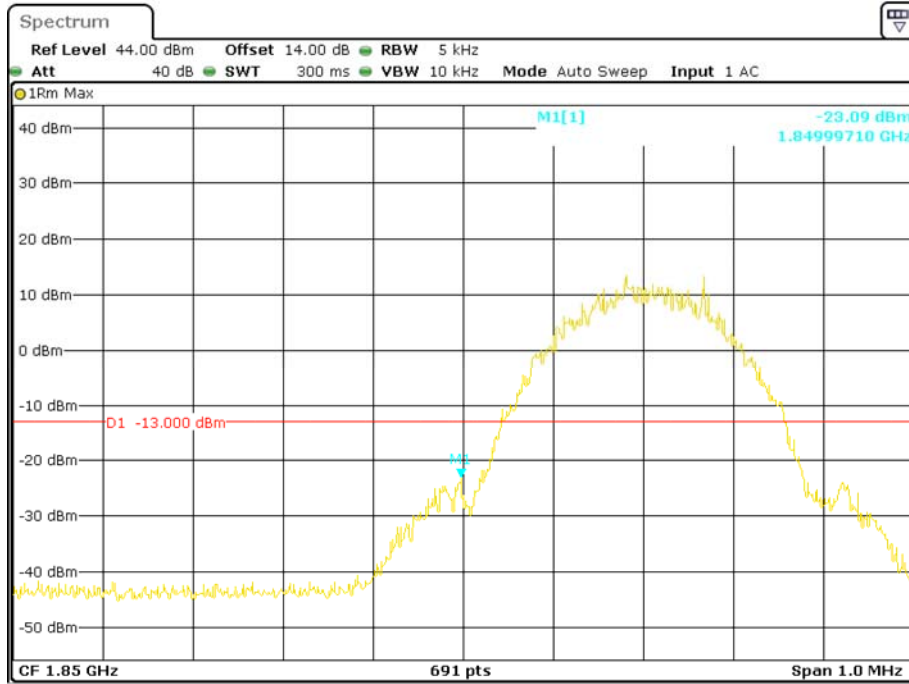

Date: 12.OCT.2015 14:16:26

### PCS Band, Right Band Edge for GSM (GMSK) Mode

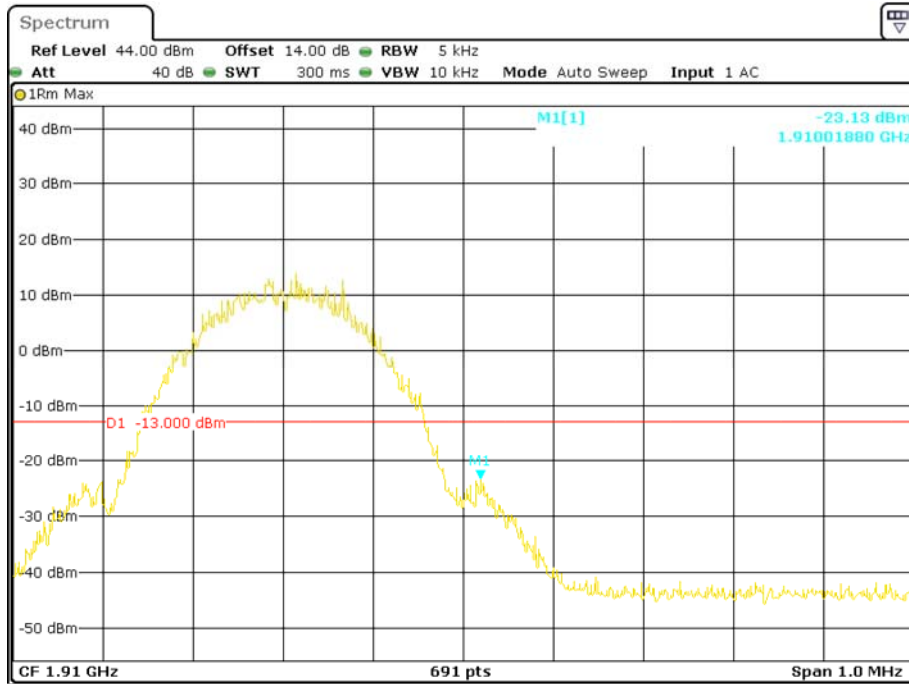

Date: 12.OCT.2015 14:18:02

**FCC §2.1055, §22.355 & §24.235 - FREQUENCY STABILITY**

**Applicable Standard**

FCC § 2.1055, §22.355, §24.235

According to §22.355, the carrier frequency of each transmitter in the Public Mobile Services must be maintained within the tolerances given in Table below:

Frequency Tolerance for Transmitters in the Public Mobile Services

Frequency Range (MHz)	Base, fixed (ppm)	Mobile ≤ 3 watts (ppm)	Mobile ≤ 3 watts (ppm)
25 to 50	20.0	20.0	50.0
50 to 450	5.0	5.0	50.0
450 to 512	2.5	5.0	5.0
821 to 896	1.5	2.5	2.5
928 to 929.	5.0	N/A	N/A
929 to 960.	1.5	N/A	N/A
2110 to 2220	10.0	N/A	N/A

According to §24.235, the frequency stability shall be sufficient to ensure that the fundamental emissions stays within the authorized frequency block.

**Test Procedure**

Frequency Stability vs. Temperature: The equipment under test was connected to an external DC power supply and the RF output was connected to communication test set via feed-through attenuators. The EUT was placed inside the temperature chamber. The DC leads and RF output cable exited the chamber through an opening made for the purpose.

After the temperature stabilized for approximately 20 minutes, the frequency output was recorded from the communication test set.

Frequency Stability vs. Voltage: For hand carried, battery powered equipment; reduce primary supply voltage to the battery operating end point which shall be specified by the manufacturer.

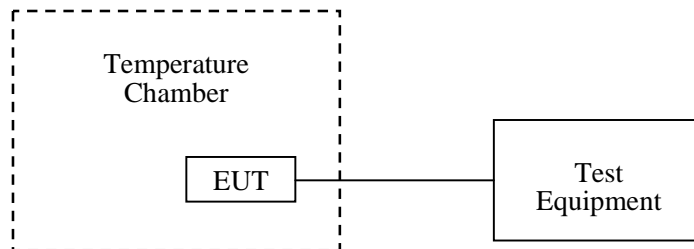

**Test Equipment List and Details**

Manufacturer	Description	Model	Serial Number	Calibration Date	Calibration Due Date
ESPEC	Temperature & Humidity Chamber	EL-10KA	09107726	2014-11-01	2015-11-01
Rohde & Schwarz	Universal Radio Communication Tester	CMU200	106891	2014-11-23	2015-11-23

\* **Statement of Traceability:** Bay Area Compliance Laboratories Corp. (Shenzhen) attests that all calibrations have been performed in accordance to requirements that traceable to National Primary Standards and International System of Units (SI).

**Test Data****Environmental Conditions**

<b>Temperature:</b>	25 °C
<b>Relative Humidity:</b>	51 %
<b>ATM Pressure:</b>	101.0 kPa

The testing was performed by William Li on 2015-10-12.

EUT operation mode: Transmitting

Test Result: Compliance. Please refer to the following tables.

**Cellular Band (Part 22H)****GSM Mode**

Middle Channel, $f_0=836.6\text{MHz}$				
Temperature (°C)	Power Supplied ( $V_{DC}$ )	Frequency Error (Hz)	Frequency Error (ppm)	Limit (ppm)
-30	3.7	10	0.0120	2.5
-20		9	0.0108	2.5
-10		12	0.0143	2.5
0		11	0.0131	2.5
10		10	0.0120	2.5
20		9	0.0108	2.5
30		8	0.0096	2.5
40		9	0.0108	2.5
50		11	0.0131	2.5
25		V min.= 3.5	12	0.0143
25	V max.= 4.2	13	0.0155	2.5

**PCS Band (Part 24E)****GSM Mode**

<b>Middle Channel, <math>f_0 = 1880.0</math> MHz</b>				
<b>Temperature (°C)</b>	<b>Power Supplied (V<sub>DC</sub>)</b>	<b>Frequency Error (Hz)</b>	<b>Frequency Error (ppm)</b>	<b>Result</b>
-30	3.7	28	0.0149	pass
-20		26	0.0138	pass
-10		24	0.0128	pass
0		26	0.0138	pass
10		22	0.0117	pass
20		23	0.0122	pass
30		22	0.0117	pass
40		20	0.0106	pass
50		21	0.0112	pass
25		V min.= 3.5	24	0.0128
25	V max.= 4.2	26	0.0138	pass

**\*\*\*\*\* END OF REPORT \*\*\*\*\***