

FCC TEST REPORT

For

Azlan Logistics Limited

HDMI Wireless Extender

Model No.: TC-HDMIW30

Prepared For : Azlan Logistics Limited
Address : Redwood 2, Chineham Business Park, Crockford Lane, Basingstoke,
Hampshire, RG24 8WQ United Kingdom

Prepared By : Shenzhen Anbotek Compliance Laboratory Limited
Address : 1/F, Building D, Sogood Science and Technology Park, Sanwei
community, Hangcheng Street, Bao'an District, Shenzhen, Guangdong,
China.518102
Tel: (86) 755-26066365 Fax: (86) 755-26014772

Report Number : R0217110130W1
Date of Test : Dec. 07, 2017~Mar. 30, 2018
Date of Report : Mar. 30, 2018

Contents

1. General Information.....	4
1.1. Client Information.....	4
1.2. Description of Device (EUT).....	4
1.3. Auxiliary Equipment Used During Test.....	5
1.4. Description of Test Modes.....	5
1.5. List of channels.....	6
1.6. Description Of Test Setup.....	7
1.7. Test Equipment List.....	8
1.8. Measurement Uncertainty.....	9
1.9. Description of Test Facility.....	9
2. Summary of Test Results.....	10
3. Conducted Emission Test.....	11
3.1. Test Standard and Limit.....	11
3.2. Test Setup.....	11
3.3. Test Procedure.....	11
3.4. Test Data.....	11
4. Radiation Spurious Emission and Band Edge.....	16
4.1. Test Standard and Limit.....	16
4.2. Test Setup.....	16
4.3. Test Procedure.....	17
4.4. Test Data.....	18
5. Maximum Peak Output Power Test.....	35
5.1. Test Standard and Limit.....	35
5.2. Test Setup.....	35
5.3. Test Procedure.....	35
5.4. Test Data.....	35
6. Occupy Bandwidth Test.....	37
6.1. Test Standard.....	37
6.2. Test Setup.....	37
6.3. Test Procedure.....	37
6.4. Test Data.....	37
7. Power Spectral Density Test.....	51
7.1. Test Standard and Limit.....	51
7.2. Test Setup.....	51
7.3. Test Procedure.....	51
7.4. Test Data.....	51
8. Antenna Requirement.....	59
8.1. Test Standard and Requirement.....	59
8.2. Antenna Connected Construction.....	60
APPENDIX I -- TEST SETUP PHOTOGRAPH.....	61
APPENDIX II -- EXTERNAL PHOTOGRAPH.....	63
APPENDIX III -- INTERNAL PHOTOGRAPH.....	66

TEST REPORT

Applicant : Azlan Logistics Limited
Manufacturer : Azlan Logistics Limited
Product Name : HDMI Wireless Extender
Model No. : TC-HDMIW30
Trade Mark : VISION
Rating(s) : Input: DC 5V

Test Standard(s) : FCC Part15 Subpart E 2017, Paragraph 15.407
ANSI C63.10: 2013,
Test Method(s) : KDB 789033 D02 General UNII Test Procedures New Rules v02r01

The device described above is tested by Shenzhen Anbotek Compliance Laboratory Limited to determine the maximum emission levels emanating from the device and the severe levels of the device can endure and its performance criterion. The measurement results are contained in this test report and Shenzhen Anbotek Compliance Laboratory Limited is assumed full of responsibility for the accuracy and completeness of these measurements. Also, this report shows that the EUT (Equipment Under Test) is technically compliant with the FCC Part 15 Subpart E requirements.

This report applies to above tested sample only and shall not be reproduced in part without written approval of Shenzhen Anbotek Compliance Laboratory Limited.

Date of Test : Dec. 07, 2017~Mar. 30, 2018

Prepared by :



Winkey Wang

(Tested Engineer / Winkey Wang)

Reviewer :

Tangcy. T.

(Project Manager / Tangcy. T)

Approved & Authorized Signer :

Tom Chen

(Manager / Tom Chen)

1. General Information

1.1. Client Information

Applicant	:	Azlan Logistics Limited
Address	:	Redwood 2, Chineham Business Park, Crockford Lane, Basingstoke, Hampshire, RG24 8WQ United Kingdom
Manufacturer	:	Azlan Logistics Limited
Address	:	Redwood 2, Chineham Business Park, Crockford Lane, Basingstoke, Hampshire, RG24 8WQ United Kingdom

1.2. Description of Device (EUT)

Product Name	:	HDMI Wireless Extender	
Model No.	:	TC-HDMIW30	
Trade Mark	:	VISION	
Test Power Supply	:	AC 120V, 60Hz for adapter/AC 240V, 60Hz for adapter	
Product Description	:	Operation Frequency:	5180MHz~5240MHz
		Number of Channel:	4 Channels for 802.11n(HT20) 4 Channels for 802.11ac(HT20) 2 Channels for 802.11n(HT40) 2 Channels for 802.11ac(HT40) 1 Channels for 802.11ac(HT80)
		Modulation Type:	OFDM with BPSK/QPSK/16QAM/64QAM for 802.11n; OFDM with BPSK/QPSK/16QAM/64QAM/256QAM for 802.11ac
		Antenna Type:	PIFA Antenna
		Antenna Gain(Peak):	3 dBi
<p>Remark: 1) For a more detailed features description, please refer to the manufacturer's specifications or the User's Manual. 2)This report is for WIFI 5.1G.</p>			

1.3. Auxiliary Equipment Used During Test

TV	:	Manufacturer: SONY
		M/N: KDL-26EX550 S/N: 1012240 CE , FCC: DOC
Notebook	:	Manufacturer: LIFE BOOK Model: LH531 CE, FCC DOC
Adapter	:	M/N: MX15Z-0502000YU Input: 100-240V~50/60Hz 0.4A Output: DC 5V USB Port, 2A
HDMI Wireless Extender		Manufacturer: Azlan Logistics Limited M/N: TC-HDMIW30

1.4. Description of Test Modes

To investigate the maximum EMI emission characteristics generates from EUT, the test system was pre-scanning tested base on the consideration of following EUT operation mode or test configuration mode which possible have effect on EMI emission level. Each of these EUT operation mode(s) or test configuration mode(s) mentioned above was evaluated respectively.

Mode	Test channel	Frequency (MHz)
OFDM(802.11n20/ac20)	CH 36	5180MHz
	CH 40	5200MHz
	CH 48	5240MHz
OFDM(802.11n40/ac40)	CH 38	5190MHz
	CH 46	5230MHz
OFDM(802.11ac80)	CH 42	5210MHz

Note:

1. The measurements are performed at the highest, middle, lowest available channels.
2. The EUT has been tested as an independent unit. And Continual Transmitting in maximum power.
3. For the relevant Conducted Measurement, the temporary antenna connector is used during the measurement. Antenna Connector Impedance: 50 Ω , Cable Loss: 1.0 dB
4. The EUT was programmed to be in continuously transmitting mode and the transmit duty cycle is more than 98%

1.5. List of channels

802.11n20/ac20

Channel	Freq. (MHz)	Channel	Freq. (MHz)
36	5180	44	5220
40	5200	48	5240

802.11n40/ac40

Channel	Freq. (MHz)	Channel	Freq. (MHz)
38	5190	46	5230

802.11ac80

Channel	Freq. (MHz)
42	5210

1.6. Description Of Test Setup

CE

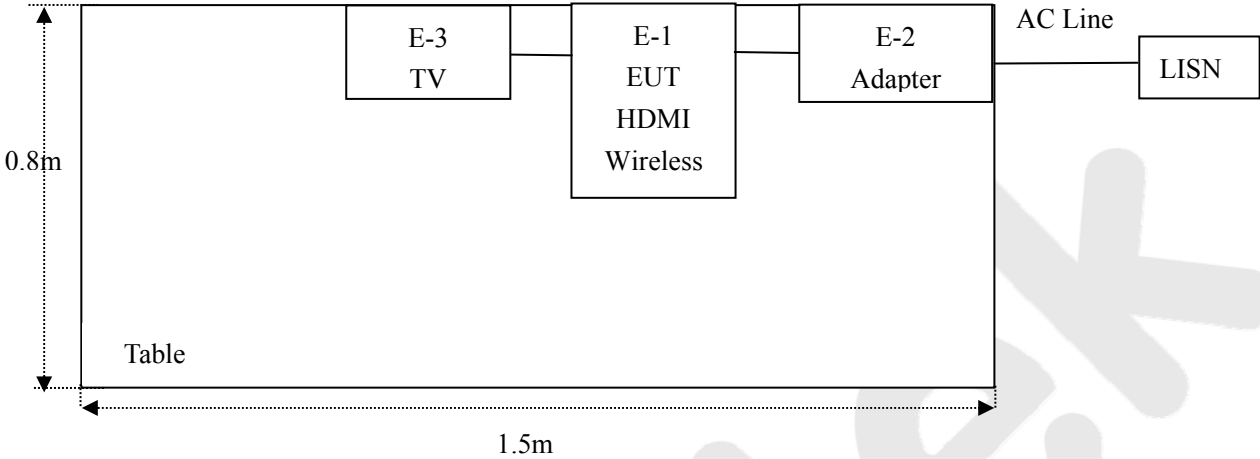

RE

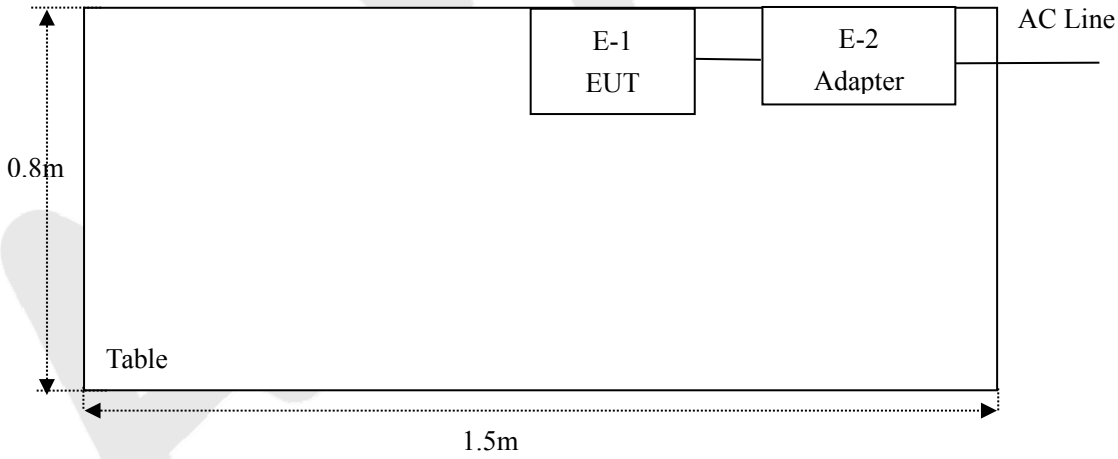

1.7. Test Equipment List

Item	Equipment	Manufacturer	Model No.	Serial No.	Last Cal.	Cal. Interval
1.	L.I.S.N. Artificial Mains Network	Rohde & Schwarz	ENV216	100055	Nov. 17, 2017	1 Year
2.	EMI Test Receiver	Rohde & Schwarz	ESCI	100627	Nov. 17, 2017	1 Year
3.	RF Switching Unit	Compliance Direction	RSU-M2	38303	Nov. 17, 2017	1 Year
4.	Spectrum Analysis	Agilent	E4407B	US39390582	Nov. 17, 2017	1 Year
5.	Spectrum Analysis	Agilent	N9038A	MY53227295	Nov. 17, 2017	1 Year
6.	Preamplifier	SKET Electronic	BK1G18G30 D	KD17503	Nov. 17, 2017	1 Year
7.	EMI Test Receiver	Rohde & Schwarz	ESPI	101604	Nov. 17, 2017	1 Year
8.	Double Ridged Horn Antenna	Instruments corporation	GTH-0118	351600	Nov. 20, 2017	1 Year
9.	Bilog Broadband Antenna	Schwarzbeck	VULB9163	VULB 9163-289	Nov. 20, 2017	1 Year
10.	Loop Antenna	Schwarzbeck	HFH2-Z2	100047	Nov. 17, 2017	1 Year
11.	Horn Antenna	Schwarzbeck	BBHA9170	9170-375	Nov. 17, 2017	1 Year
12.	Pre-amplifier	SONOMA	310N	186860	Nov. 17, 2017	1 Year
13.	EMI Test Software EZ-EMC	SHURPLE	N/A	N/A	N/A	N/A
14.	RF Test Control System	YIHENG	YH3000	2017430	Nov. 18, 2017	1 Year
15.	Power Sensor	DAER	RPR3006W	15I00041SN045	Nov. 17, 2017	1 Year
16.	Power Sensor	DAER	RPR3006W	15I00041SN046	Nov. 17, 2017	1 Year
17.	MXA Spectrum Analysis	Agilent	N9020A	MY51170037	Nov. 18, 2017	1 Year
18.	MXG RF Vector Signal Generator	Agilent	N5182A	MY48180656	Nov. 18, 2017	1 Year
19.	Signal Generator	Agilent	E4421B	MY41000743	Nov. 18, 2017	1 Year
20.	DC Power Supply	LW	TPR-6410D	349315	Nov. 01, 2017	1 Year
21.	Constant Temperature Humidity Chamber	Sertep	ZJ-HWHS80 B	ZJ-17042804	Nov. 01, 2017	1 Year

1.8. Measurement Uncertainty

Radiation Uncertainty	:	Ur = 4.1 dB (Horizontal)
		Ur = 4.3 dB (Vertical)
Conduction Uncertainty	:	Uc = 3.4dB

1.9. Description of Test Facility

The test facility is recognized, certified, or accredited by the following organizations:

FCC-Registration No.: 184111

Shenzhen Anbotek Compliance Laboratory Limited, EMC Laboratory has been registered and fully described in a report filed with the (FCC) Federal Communications Commission. The acceptance letter from the FCC is maintained in our files. Registration No. 184111, July 31, 2017.

ISED-Registration No.: 8058A-1

Shenzhen Anbotek Compliance Laboratory Limited, EMC Laboratory has been registered and fully described in a report filed with the (ISED) Innovation, Science and Economic Development Canada. The acceptance letter from the ISED is maintained in our files. Registration 8058A-1, June 13, 2016.

Test Location

All Emissions tests were performed at Shenzhen Anbotek Compliance Laboratory Limited. at 1/F, Building D, Sogood Science and Technology Park, Sanwei community, Hangcheng Street, Bao'an District, Shenzhen, Guangdong, China. 518102

2. Summary of Test Results

Standard	Test Type	Result
15.207 & 15.407	Conducted Emission	PASS
15.205/15.209	Spurious Emission	PASS
15.407(b)	Band Edge	PASS
15.407(a)(5)	Occupy Bandwidth	PASS
15.407(a)(1)(3)	Maximum Conducted Output Power	PASS
15.407(a)(1)(3)	Peak Power Spectral Density	PASS
15.203/15.407g	Antenna Requirement	PASS

3. Conducted Emission Test

3.1. Test Standard and Limit

Test Standard	FCC Part15 Section 15.207&15.407		
Test Limit	Frequency	Maximum RF Line Voltage (dBuV)	
		Quasi-peak Level	Average Level
	150kHz~500kHz	66 ~ 56 *	56 ~ 46 *
	500kHz~5MHz	56	46
5MHz~30MHz	60	50	

Remark: (1) *Decreasing linearly with logarithm of the frequency.
(2) The lower limit shall apply at the transition frequency.

3.2. Test Setup

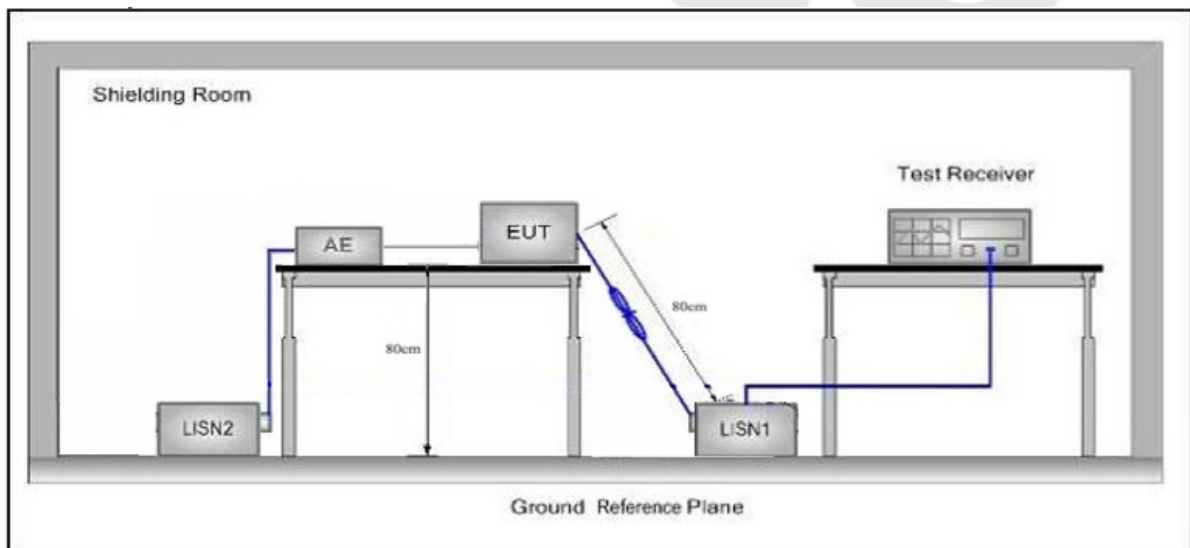

3.3. Test Procedure

The EUT system is connected to the power mains through a line impedance stabilization network (L.I.S.N.). This provides a 50ohm coupling impedance for the EUT system. Please refer the block diagram of the test setup and photographs. Both sides of AC line are checked to find out the maximum conducted emission. In order to find the maximum emission levels, the relative positions of equipment and all of the interface cables shall be changed according to FCC ANSI C63.10-2013 on Conducted Emission Measurement.

The bandwidth of test receiver (ESCI) set at 9kHz.

The frequency range from 150kHz to 30MHz is checked.

3.4. Test Data

Please to see the following pages

Conducted Emission Test Data

Test Site: 1# Shielded Room
 Operating Condition: TX+Charging mode
 Test Specification: AC 120V, 60Hz for adapter
 Comment: Live Line
 Tem.:22.3°C Hum.:57%

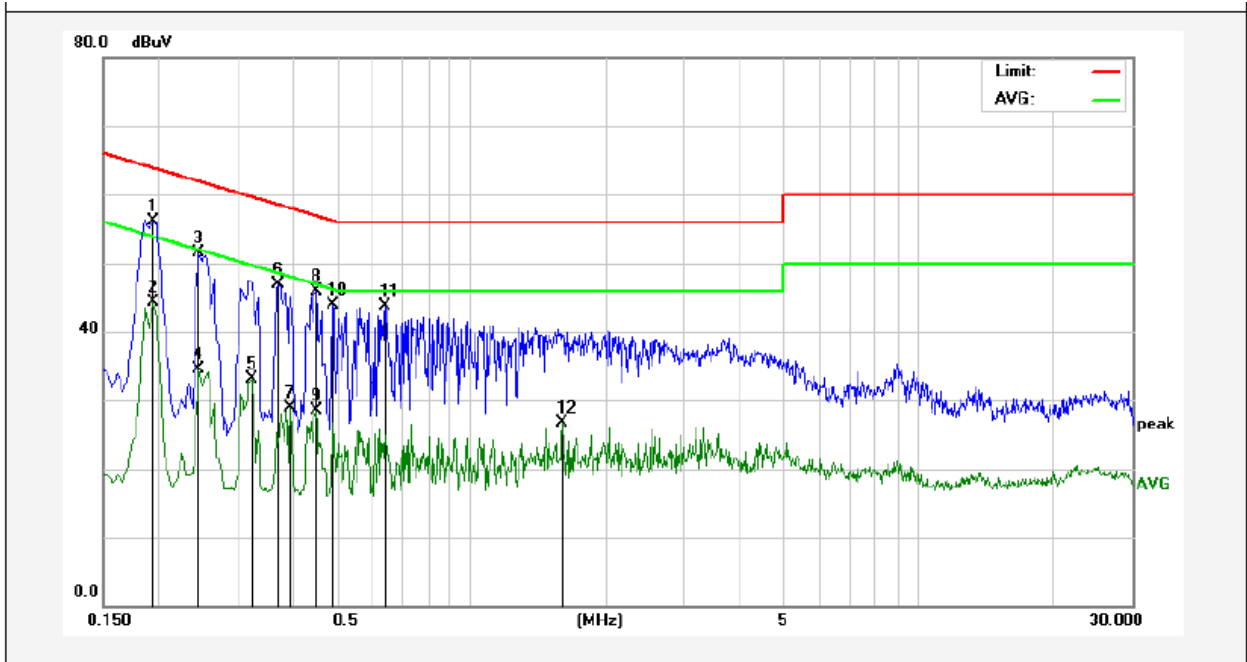

No.	Freq. (MHz)	Reading (dBuV)	Factor (dB)	Result (dBuV)	Limit dBuV	Over Limit (dB)	Detector	Remark
1	0.1940	36.14	19.90	56.04	63.86	-7.82	QP	
2	0.1940	24.45	19.90	44.35	53.86	-9.51	AVG	
3	0.2460	31.54	19.89	51.43	61.89	-10.46	QP	
4	0.2460	14.52	19.89	34.41	51.89	-17.48	AVG	
5	0.3220	13.17	19.90	33.07	49.65	-16.58	AVG	
6	0.3700	26.97	19.92	46.89	58.50	-11.61	QP	
7	0.3940	9.07	19.93	29.00	47.98	-18.98	AVG	
8	0.4500	26.04	19.96	46.00	56.87	-10.87	QP	
9	0.4500	8.62	19.96	28.58	46.87	-18.29	AVG	
10	0.4900	23.99	19.98	43.97	56.17	-12.20	QP	
11	0.6419	23.76	20.02	43.78	56.00	-12.22	QP	
12	1.5940	6.50	20.13	26.63	46.00	-19.37	AVG	

Conducted Emission Test Data

Test Site: 1# Shielded Room
 Operating Condition: TX+Charging mode
 Test Specification: AC 120V, 60Hz for adapter
 Comment: Neutral Line
 Tem.:22.3°C Hum.:57%

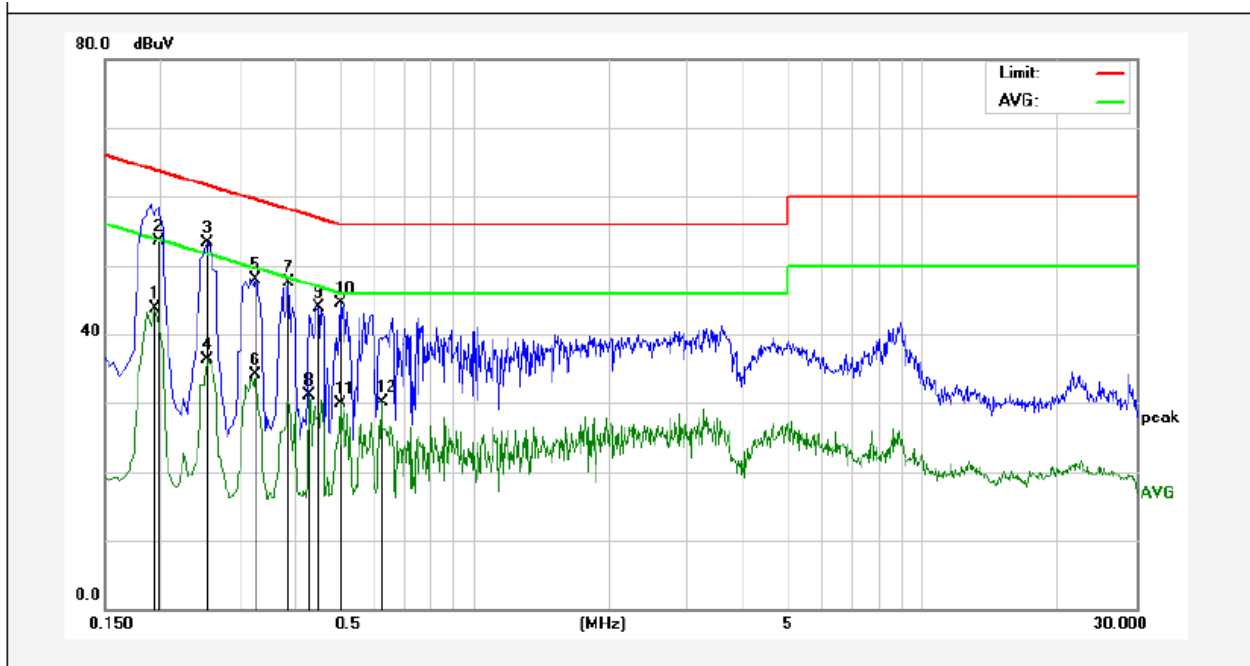

No.	Freq. (MHz)	Reading (dBuV)	Factor (dB)	Result (dBuV)	Limit dBuV	Over Limit (dB)	Detector	Remark
1	0.1940	23.89	19.90	43.79	53.86	-10.07	AVG	
2	0.1980	33.70	19.90	53.60	63.69	-10.09	QP	
3	0.2540	33.44	19.89	53.33	61.62	-8.29	QP	
4	0.2540	16.38	19.89	36.27	51.62	-15.35	AVG	
5	0.3260	28.07	19.90	47.97	59.55	-11.58	QP	
6	0.3260	14.13	19.90	34.03	49.55	-15.52	AVG	
7	0.3860	27.62	19.93	47.55	58.15	-10.60	QP	
8	0.4300	11.22	19.95	31.17	47.25	-16.08	AVG	
9	0.4500	23.85	19.96	43.81	56.87	-13.06	QP	
10	0.5020	24.48	19.98	44.46	56.00	-11.54	QP	
11	0.5020	10.01	19.98	29.99	46.00	-16.01	AVG	
12	0.6220	9.99	20.02	30.01	46.00	-15.99	AVG	

Conducted Emission Test Data

Test Site: 1# Shielded Room
 Operating Condition: TX+Charging mode
 Test Specification: AC 240V, 60Hz for adapter
 Comment: Live Line
 Tem.:22.3°C Hum.:57%

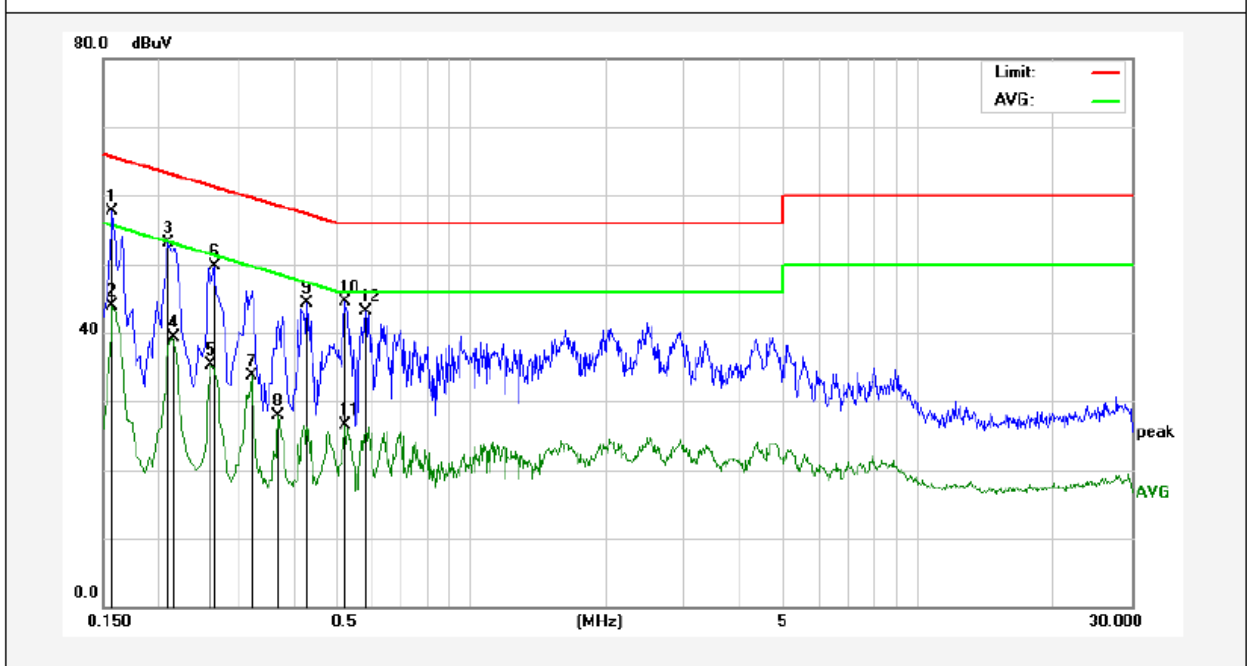

No.	Freq. (MHz)	Reading (dBuV)	Factor (dB)	Result (dBuV)	Limit dBuV	Over Limit (dB)	Detector	Remark
1	0.1580	37.81	19.90	57.71	65.56	-7.85	QP	
2	0.1580	24.00	19.90	43.90	55.56	-11.66	AVG	
3	0.2100	33.17	19.90	53.07	63.20	-10.13	QP	
4	0.2140	19.43	19.90	39.33	53.04	-13.71	AVG	
5	0.2620	15.40	19.89	35.29	51.36	-16.07	AVG	
6	0.2660	29.90	19.89	49.79	61.24	-11.45	QP	
7	0.3220	13.74	19.90	33.64	49.65	-16.01	AVG	
8	0.3700	8.07	19.92	27.99	48.50	-20.51	AVG	
9	0.4300	24.26	19.95	44.21	57.25	-13.04	QP	
10	0.5220	24.50	19.99	44.49	56.00	-11.51	QP	
11	0.5220	6.53	19.99	26.52	46.00	-19.48	AVG	
12	0.5820	23.01	20.00	43.01	56.00	-12.99	QP	

Conducted Emission Test Data

Test Site: 1# Shielded Room
 Operating Condition: TX+Charging mode
 Test Specification: AC 240V, 60Hz for adapter
 Comment: Neutral Line
 Tem.:22.3°C Hum.:57%

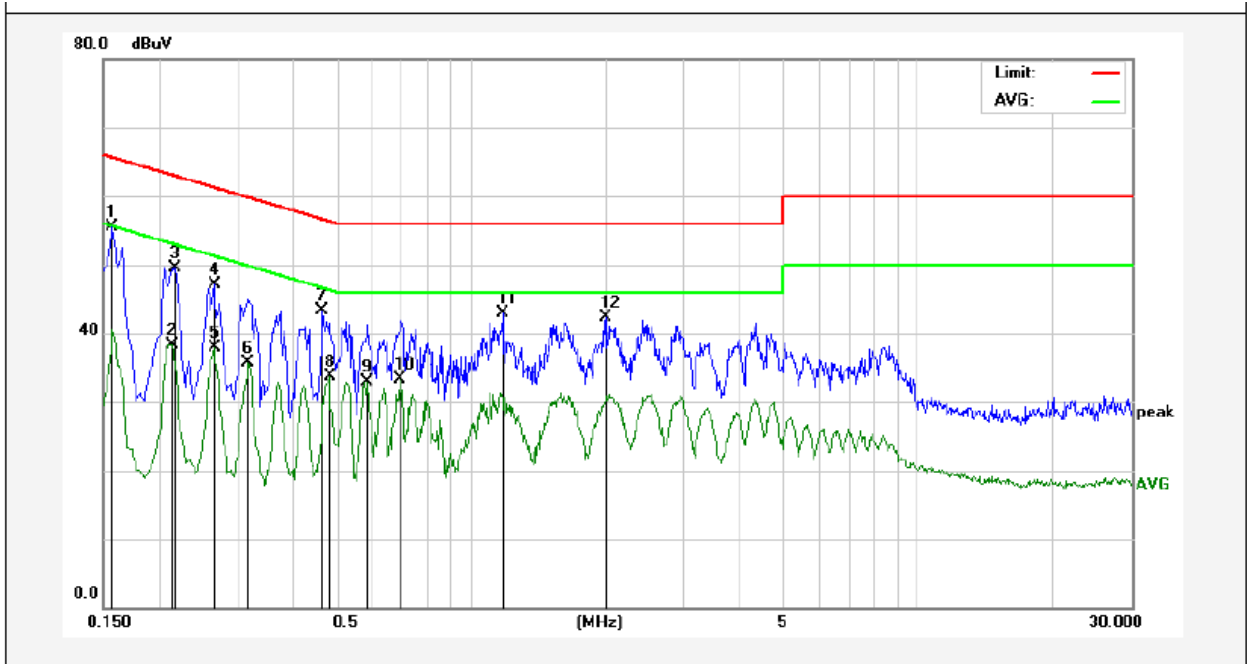

No.	Freq. (MHz)	Reading (dBuV)	Factor (dB)	Result (dBuV)	Limit dBuV	Over Limit (dB)	Detector	Remark
1	0.1580	35.66	19.90	55.56	65.56	-10.00	QP	
2	0.2140	18.48	19.90	38.38	53.04	-14.66	AVG	
3	0.2180	29.63	19.90	49.53	62.89	-13.36	QP	
4	0.2660	27.27	19.89	47.16	61.24	-14.08	QP	
5	0.2660	18.00	19.89	37.89	51.24	-13.35	AVG	
6	0.3180	15.89	19.90	35.79	49.76	-13.97	AVG	
7	0.4660	23.35	19.96	43.31	56.58	-13.27	QP	
8	0.4820	13.81	19.97	33.78	46.30	-12.52	AVG	
9	0.5860	12.86	20.01	32.87	46.00	-13.13	AVG	
10	0.6900	13.21	20.04	33.25	46.00	-12.75	AVG	
11	1.1780	22.75	20.12	42.87	56.00	-13.13	QP	
12	2.0100	22.16	20.14	42.30	56.00	-13.70	QP	

4. Radiation Spurious Emission and Band Edge

4.1. Test Standard and Limit

Test Standard	FCC Part15 C Section 15.209, 15.205 and 15.407				
Test Limit	Frequency (MHz)	Field strength (microvolt/meter)	Limit (dBuV/m)	Remark	Measurement distance (m)
	0.009MHz~0.490MHz	2400/F(kHz)	-	-	300
	0.490MHz-1.705MHz	24000/F(kHz)	-	-	30
	1.705MHz-30MHz	30	-	-	30
	30MHz~88MHz	100	40.0	Quasi-peak	3
	88MHz~216MHz	150	43.5	Quasi-peak	3
	216MHz~960MHz	200	46.0	Quasi-peak	3
	960MHz~1000MHz	500	54.0	Quasi-peak	3
	Above 1000MHz	500	54.0	Average	3
-		68.2	Peak	3	

Remark:

(1)The lower limit shall apply at the transition frequency.

(2) 15.35(b), Unless otherwise specified, the limit on peak radio frequency emissions is 20dB above the maximum permitted average emission limit applicable to the equipment under test. This peak limit applies to the total peak emission level radiated by the device.

(3)Above 1GHz limit: $E[dB\mu V/m] = EIRP[dBm] + 95.2 = 68.2 dB\mu V/m$, for $EIRP[dBm] = -27dBm$.

4.2. Test Setup

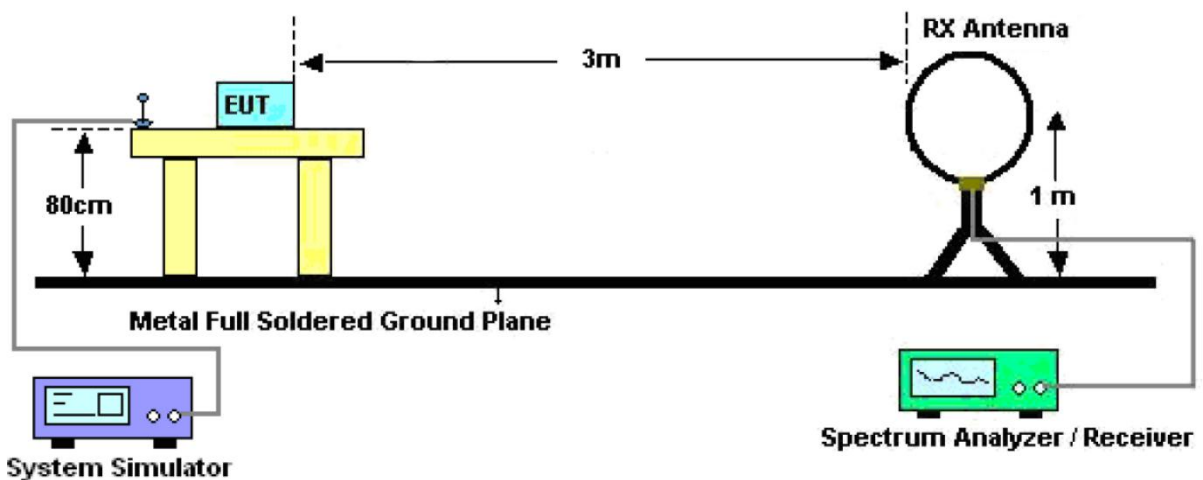

Figure 1. Below 30MHz

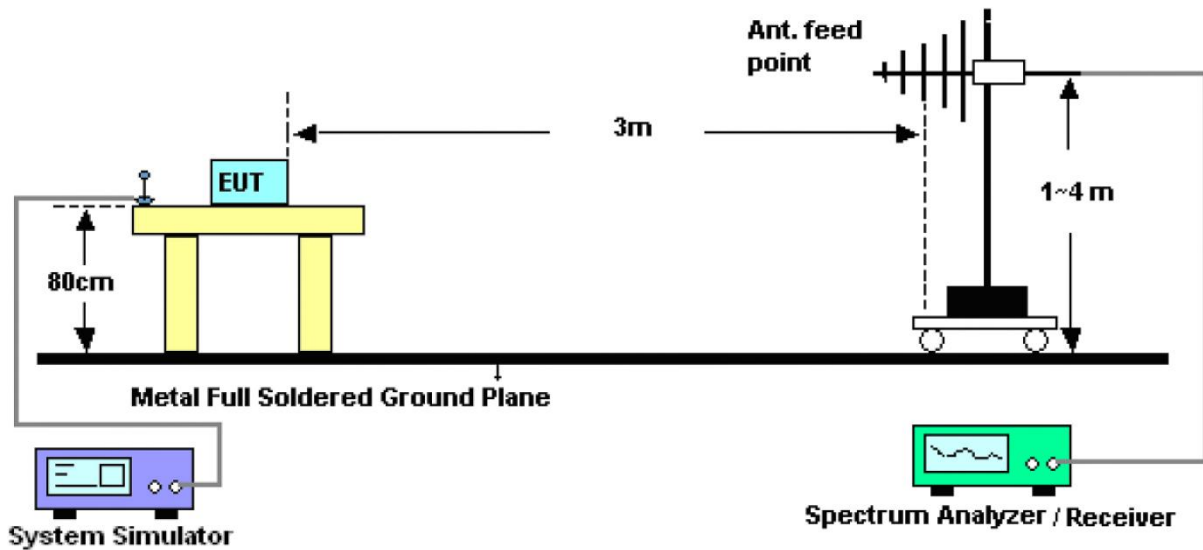

Figure 2. 30MHz to 1GHz

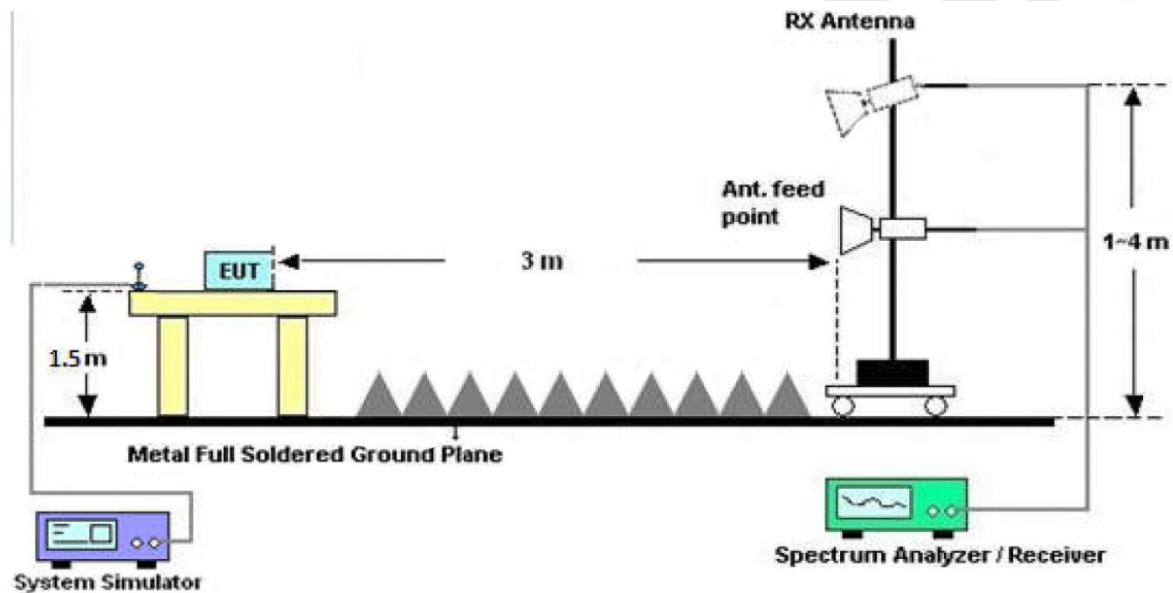

Figure 3. Above 1 GHz

4.3. Test Procedure

For below 1GHz: The EUT is placed on a turntable, which is 0.8m above the ground plane.

For above 1GHz: The EUT is placed on a turntable, which is 1.5m above the ground plane.

The turn table can rotate 360 degrees to determine the position of the maximum emission level. The EUT is set 3 meters away from the receiving antenna which is mounted on a antenna tower. The antenna can be moved up and down from 1 to 4 meters to find out the maximum emission level. Rotated the EUT through three orthogonal axes to determine the maximum emissions, both horizontal and vertical polarization of the antenna are set on test. The EUT is tested in 9*6*6 Chamber. The device is evaluated in xyz orientation.

For the radiated emission test above 1GHz:

Place the measurement antenna away from each area of the EUT determined to be a source of emissions at the specified measurement distance, while keeping the measurement antenna aimed at the source of emissions at each frequency of significant emissions, with polarization oriented for maximum response. The measurement antenna may have to be higher or lower than the EUT, depending on the radiation pattern of the emission and staying

aimed at the emission source for receiving the maximum signal. The final measurement antenna elevation shall be that which maximizes the emissions. The measurement antenna elevation for maximum emissions shall be restricted to a range of heights of from 1 m to 4 m above the ground or reference ground plane.

For 9kHz to 150kHz, Set the spectrum analyzer as:

RBW = 200Hz, VBW =1kHz, Detector= Quasi-Peak, Trace mode= Max hold, Sweep- auto couple.

For 150kHz to 30MHz, Set the spectrum analyzer as:

RBW = 9KHz, VBW =30kHz, Detector= Quasi-Peak, Trace mode= Max hold, Sweep- auto couple.

For 30MHz to 1000MHz, Set the spectrum analyzer as:

RBW = 100kHz, VBW =300kHz, Detector= Quasi-Peak, Trace mode= Max hold, Sweep- auto couple.

For above 1GHz, Set the spectrum analyzer as:

RBW =1MHz, VBW =1MHz, Detector= Peak, Trace mode= Max hold, Sweep- auto couple.

RBW =1MHz, VBW =10Hz, Detector= Average, Trace mode= Max hold, Sweep- auto couple.

4.4. Test Data

PASS

The test results of 9kHz-30MHz was attenuated more than 20dB below the permissible limits, so the results don't record in the report.

Test Results (30~1000MHz)

Job No.: 0217110130W Temp.(°C)/Hum.(%RH): 23.2°C/53.4%RH
 Standard: FCC PART 15C Power Source: DC 5V USB Port
 Test Mode: TX+Charging mode Polarization: Horizontal

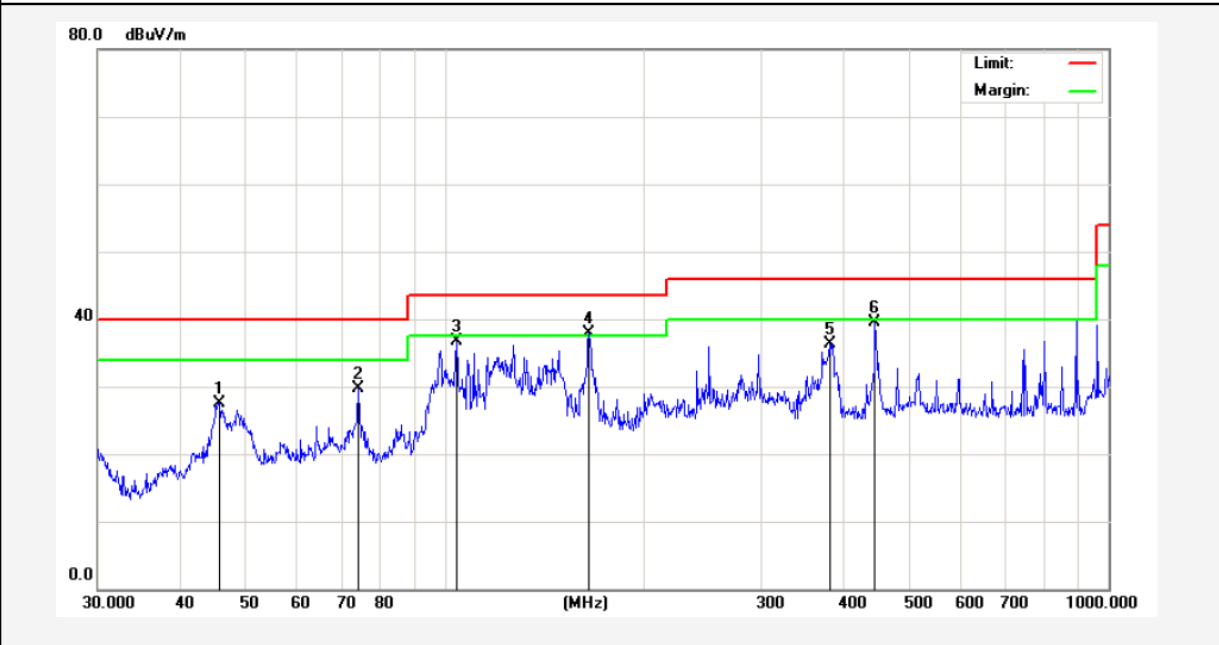

No.	Freq. (MHz)	Reading (dBuV/m)	Factor (dB/m)	Result (dBuV/m)	Limit (dBuV/)	Over Limit (dB)	Detector	Height (cm)	degree (deg)	Remark
1	45.6948	43.04	-15.50	27.54	40.00	-12.46	QP	300	0	
2	74.1350	51.12	-21.46	29.66	40.00	-10.34	QP	300	124	
3	104.1701	57.31	-20.70	36.61	43.50	-6.89	QP	300	223	
4	164.9071	58.03	-20.22	37.81	43.50	-5.69	QP	300	256	
5	379.9141	49.66	-13.27	36.39	46.00	-9.61	QP	300	331	
6	444.8514	51.62	-12.18	39.44	46.00	-6.56	QP	300	360	



Test Results (30~1000MHz)

Job No.: 0217110130W Temp.(°C)/Hum.(%RH): 23.2°C/53.4%RH
 Standard: FCC PART 15C Power Source: DC 5V USB Port
 Test Mode: TX+Charging mode Polarization: Vertical

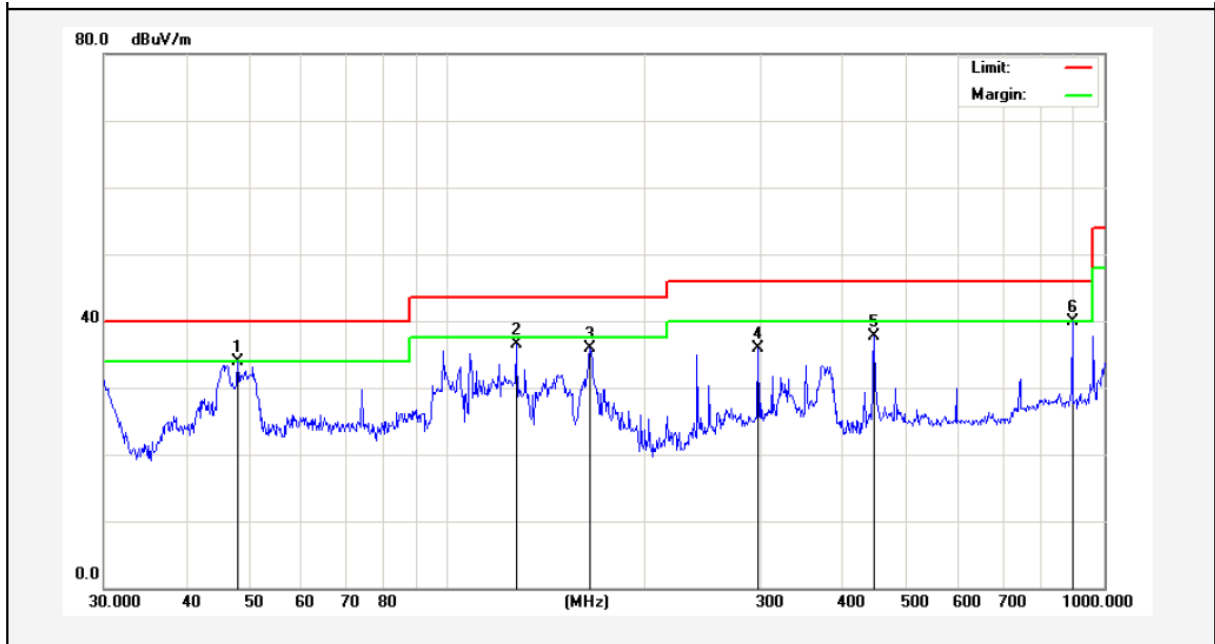

No.	Freq. (MHz)	Reading (dBuV/m)	Factor (dB/m)	Result (dBuV/m)	Limit (dBuV/)	Over Limit (dB)	Detector	Height (cm)	degree (deg)	Remark
1	47.9938	48.91	-15.07	33.84	40.00	-6.16	QP	300	0	
2	127.2176	52.95	-16.40	36.55	43.50	-6.95	QP	300	124	
3	164.9071	52.57	-16.71	35.86	43.50	-7.64	QP	300	156	
4	297.2241	50.67	-14.74	35.93	46.00	-10.07	QP	300	235	
5	446.4141	49.22	-11.49	37.73	46.00	-8.27	QP	300	312	
6	893.8567	43.72	-3.86	39.86	46.00	-6.14	QP	300	360	



Test mode:	IEEE 802.11n(HT20)	Test channel:	Low CH
------------	--------------------	---------------	--------

Peak value:

Frequency (MHz)	Read Level (dBuV)	Antenna Factor (dB/m)	Cable Loss (dB)	Preamp Factor (dB)	Level (dBuV/m)	Limit Line (dBuV/m)	Over Limit (dB)	Pol.
10360.00	39.81	31.98	17.08	33.91	54.96	68.20	-13.24	V
15540.00	36.21	32.65	20.03	34.85	54.04	68.20	-14.16	V
10360.00	37.15	31.98	17.08	33.91	52.30	68.20	-15.90	H
15540.00	36.25	32.65	20.03	34.85	54.08	68.20	-14.12	H

Average value:

Frequency (MHz)	Read Level (dBuV)	Antenna Factor (dB/m)	Cable Loss (dB)	Preamp Factor (dB)	Level (dBuV/m)	Limit Line (dBuV/m)	Over Limit (dB)	Pol.
10360.00	31.12	31.98	17.08	33.91	46.27	54.00	-7.73	V
15540.00	28.32	32.65	20.03	34.85	46.15	54.00	-7.85	V
10360.00	30.57	31.98	17.08	33.91	45.72	54.00	-8.28	H
15540.00	28.35	32.65	20.03	34.85	46.18	54.00	-7.82	H

Test mode:	IEEE 802.11n(HT20)	Test channel:	Mid CH
------------	--------------------	---------------	--------

Peak value:

Frequency (MHz)	Read Level (dBuV)	Antenna Factor (dB/m)	Cable Loss (dB)	Preamp Factor (dB)	Level (dBuV/m)	Limit Line (dBuV/m)	Over Limit (dB)	Pol.
10400.00	40.35	32.44	17.18	33.91	56.06	68.20	-12.14	V
15600.00	39.12	32.78	20.12	34.86	57.16	68.20	-11.04	V
10400.00	38.35	32.44	17.18	33.91	54.06	68.20	-14.14	H
15600.00	36.12	32.78	20.12	34.86	54.16	68.20	-14.04	H

Average value:

Frequency (MHz)	Read Level (dBuV)	Antenna Factor (dB/m)	Cable Loss (dB)	Preamp Factor (dB)	Level (dBuV/m)	Limit Line (dBuV/m)	Over Limit (dB)	Pol.
10400.00	29.13	32.44	17.18	33.91	44.84	54.00	-9.16	V
15600.00	27.32	32.78	20.12	34.86	45.36	54.00	-8.64	V
10400.00	29.03	32.44	17.18	33.91	44.74	54.00	-9.26	H
15600.00	28.36	32.78	20.12	34.86	46.40	54.00	-7.60	H

Test mode:	IEEE 802.11n(HT20)	Test channel:	High CH
------------	--------------------	---------------	---------

Peak value:

Frequency (MHz)	Read Level (dBuV)	Antenna Factor (dB/m)	Cable Loss (dB)	Preamp Factor (dB)	Level (dBuV/m)	Limit Line (dBuV/m)	Over Limit (dB)	Pol.
10480.00	41.21	32.59	18.02	33.92	57.90	68.20	-10.30	V
15720.00	38.35	32.87	20.15	34.88	56.49	68.20	-11.71	V
10480.00	36.23	32.59	18.02	33.92	52.92	68.20	-15.28	H
15720.00	38.13	32.87	20.15	34.88	56.27	68.20	-11.93	H

Average value:

Frequency (MHz)	Read Level (dBuV)	Antenna Factor (dB/m)	Cable Loss (dB)	Preamp Factor (dB)	Level (dBuV/m)	Limit Line (dBuV/m)	Over Limit (dB)	Pol.
10480.00	31.25	32.59	18.02	33.92	47.94	54.00	-6.06	V
15720.00	32.41	32.87	20.15	34.88	50.55	54.00	-3.45	V
10480.00	29.32	32.59	18.02	33.92	46.01	54.00	-7.99	H
15720.00	28.74	32.87	20.15	34.88	46.88	54.00	-7.12	H

Test mode:	IEEE 802.11n(ac20)	Test channel:	Low CH
------------	--------------------	---------------	--------

Peak value:

Frequency (MHz)	Read Level (dBuV)	Antenna Factor (dB/m)	Cable Loss (dB)	Preamp Factor (dB)	Level (dBuV/m)	Limit Line (dBuV/m)	Over Limit (dB)	Pol.
10360.00	41.87	31.98	17.08	33.91	57.02	68.20	-11.18	V
15540.00	35.23	32.65	20.03	34.85	53.06	68.20	-15.14	V
10360.00	38.46	31.98	17.08	33.91	53.61	68.20	-14.59	H
15540.00	35.05	32.65	20.03	34.85	52.88	68.20	-15.32	H

Average value:

Frequency (MHz)	Read Level (dBuV)	Antenna Factor (dB/m)	Cable Loss (dB)	Preamp Factor (dB)	Level (dBuV/m)	Limit Line (dBuV/m)	Over Limit (dB)	Pol.
10360.00	32.16	31.98	17.08	33.91	47.31	54.00	-6.69	V
15540.00	29.34	32.65	20.03	34.85	47.17	54.00	-6.83	V
10360.00	30.25	31.98	17.08	33.91	45.40	54.00	-8.60	H
15540.00	27.22	32.65	20.03	34.85	45.05	54.00	-8.95	H

Test mode:	IEEE 802.11n(ac20)	Test channel:	Mid CH
------------	--------------------	---------------	--------

Peak value:

Frequency (MHz)	Read Level (dBuV)	Antenna Factor (dB/m)	Cable Loss (dB)	Preamp Factor (dB)	Level (dBuV/m)	Limit Line (dBuV/m)	Over Limit (dB)	Pol.
10400.00	40.73	32.44	17.18	33.91	56.44	68.20	-11.76	V
15600.00	37.41	32.78	20.12	34.86	55.45	68.20	-12.75	V
10400.00	39.22	32.44	17.18	33.91	54.93	68.20	-13.27	H
15600.00	36.10	32.78	20.12	34.86	54.14	68.20	-14.06	H

Average value:

Frequency (MHz)	Read Level (dBuV)	Antenna Factor (dB/m)	Cable Loss (dB)	Preamp Factor (dB)	Level (dBuV/m)	Limit Line (dBuV/m)	Over Limit (dB)	Pol.
10400.00	30.35	32.44	17.18	33.91	46.06	54.00	-7.94	V
15600.00	27.49	32.78	20.12	34.86	45.53	54.00	-8.47	V
10400.00	29.42	32.44	17.18	33.91	45.13	54.00	-8.87	H
15600.00	27.15	32.78	20.12	34.86	45.19	54.00	-8.81	H

Test mode:	IEEE 802.11n(ac20)	Test channel:	High CH
------------	--------------------	---------------	---------

Peak value:

Frequency (MHz)	Read Level (dBuV)	Antenna Factor (dB/m)	Cable Loss (dB)	Preamp Factor (dB)	Level (dBuV/m)	Limit Line (dBuV/m)	Over Limit (dB)	Pol.
10480.00	40.34	32.59	18.02	33.92	57.03	68.20	-11.17	V
15720.00	38.56	32.87	20.15	34.88	56.70	68.20	-11.50	V
10480.00	39.22	32.59	18.02	33.92	55.91	68.20	-12.29	H
15720.00	37.25	32.87	20.15	34.88	55.39	68.20	-12.81	H

Average value:

Frequency (MHz)	Read Level (dBuV)	Antenna Factor (dB/m)	Cable Loss (dB)	Preamp Factor (dB)	Level (dBuV/m)	Limit Line (dBuV/m)	Over Limit (dB)	Pol.
10480.00	30.17	32.59	18.02	33.92	46.86	54.00	-7.14	V
15720.00	28.14	32.87	20.15	34.88	46.28	54.00	-7.72	V
10480.00	28.85	32.59	18.02	33.92	45.54	54.00	-8.46	H
15720.00	27.42	32.87	20.15	34.88	45.56	54.00	-8.44	H

Test mode:	IEEE 802.11n(HT40)	Test channel:	Low CH
------------	--------------------	---------------	--------

Peak value:

Frequency (MHz)	Read Level (dBuV)	Antenna Factor (dB/m)	Cable Loss (dB)	Preamp Factor (dB)	Level (dBuV/m)	Limit Line (dBuV/m)	Over Limit (dB)	Pol.
10380.00	37.76	31.98	17.08	33.91	52.91	68.20	-15.29	V
15570.00	35.87	32.65	20.03	34.85	53.70	68.20	-14.50	V
10380.00	37.63	31.98	17.08	33.91	52.78	68.20	-15.42	H
15570.00	35.74	32.65	20.03	34.85	53.57	68.20	-14.63	H

Average value:

Frequency (MHz)	Read Level (dBuV)	Antenna Factor (dB/m)	Cable Loss (dB)	Preamp Factor (dB)	Level (dBuV/m)	Limit Line (dBuV/m)	Over Limit (dB)	Pol.
10380.00	30.11	31.98	17.08	33.91	45.26	54.00	-8.74	V
15570.00	28.83	32.65	20.03	34.85	46.66	54.00	-7.34	V
10380.00	30.11	31.98	17.08	33.91	45.26	54.00	-8.74	H
15570.00	27.34	32.65	20.03	34.85	45.17	54.00	-8.83	H

Test mode:	IEEE 802.11n(HT40)	Test channel:	High CH
------------	--------------------	---------------	---------

Peak value:

Frequency (MHz)	Read Level (dBuV)	Antenna Factor (dB/m)	Cable Loss (dB)	Preamp Factor (dB)	Level (dBuV/m)	Limit Line (dBuV/m)	Over Limit (dB)	Pol.
10460.00	42.25	32.59	18.02	33.92	58.94	68.20	-9.26	V
15690.00	39.12	32.87	20.15	34.88	57.26	68.20	-10.94	V
10460.00	37.41	32.59	18.02	33.92	54.10	68.20	-14.10	H
15690.00	38.53	32.87	20.15	34.88	56.67	68.20	-11.53	H

Average value:

Frequency (MHz)	Read Level (dBuV)	Antenna Factor (dB/m)	Cable Loss (dB)	Preamp Factor (dB)	Level (dBuV/m)	Limit Line (dBuV/m)	Over Limit (dB)	Pol.
10460.00	32.13	32.59	18.02	33.92	48.82	54.00	-5.18	V
15690.00	29.49	32.87	20.15	34.88	47.63	54.00	-6.37	V
10460.00	31.47	32.59	18.02	33.92	48.16	54.00	-5.84	H
15690.00	28.41	32.78	20.12	34.86	46.45	54.00	-7.55	H

Test mode:	IEEE 802.11ac(HT40)	Test channel:	Low CH
------------	---------------------	---------------	--------

Peak value:

Frequency (MHz)	Read Level (dBuV)	Antenna Factor (dB/m)	Cable Loss (dB)	Preamp Factor (dB)	Level (dBuV/m)	Limit Line (dBuV/m)	Over Limit (dB)	Pol.
10380.00	37.48	31.98	17.08	33.91	52.63	68.20	-15.57	V
15570.00	35.27	32.65	20.03	34.85	53.10	68.20	-15.10	V
10380.00	37.21	31.98	17.08	33.91	52.36	68.20	-15.84	H
15570.00	35.53	32.65	20.03	34.85	53.36	68.20	-14.84	H

Average value:

Frequency (MHz)	Read Level (dBuV)	Antenna Factor (dB/m)	Cable Loss (dB)	Preamp Factor (dB)	Level (dBuV/m)	Limit Line (dBuV/m)	Over Limit (dB)	Pol.
10380.00	31.24	31.98	17.08	33.91	46.39	54.00	-7.61	V
15570.00	28.35	32.65	20.03	34.85	46.18	54.00	-7.82	V
10380.00	30.34	31.98	17.08	33.91	45.49	54.00	-8.51	H
15570.00	27.69	32.65	20.03	34.85	45.52	54.00	-8.48	H

Test mode:	IEEE 802.11ac(HT40)	Test channel:	High CH
------------	---------------------	---------------	---------

Peak value:

Frequency (MHz)	Read Level (dBuV)	Antenna Factor (dB/m)	Cable Loss (dB)	Preamp Factor (dB)	Level (dBuV/m)	Limit Line (dBuV/m)	Over Limit (dB)	Pol.
10460.00	41.78	32.59	18.02	33.92	58.47	68.20	-9.73	V
15690.00	38.47	32.87	20.15	34.88	56.61	68.20	-11.59	V
10460.00	39.27	32.59	18.02	33.92	55.96	68.20	-12.24	H
15690.00	37.42	32.87	20.15	34.88	55.56	68.20	-12.64	H

Average value:

Frequency (MHz)	Read Level (dBuV)	Antenna Factor (dB/m)	Cable Loss (dB)	Preamp Factor (dB)	Level (dBuV/m)	Limit Line (dBuV/m)	Over Limit (dB)	Pol.
10460.00	31.78	32.59	18.02	33.92	48.47	54.00	-5.53	V
15690.00	28.89	32.87	20.15	34.88	47.03	54.00	-6.97	V
10460.00	30.27	32.59	18.02	33.92	46.96	54.00	-7.04	H
15690.00	28.35	32.78	20.12	34.86	46.39	54.00	-7.61	H

Test mode:	IEEE 802.11ac(HT80)	Test channel:	
------------	---------------------	---------------	--

Peak value:

Frequency (MHz)	Read Level (dBuV)	Antenna Factor (dB/m)	Cable Loss (dB)	Preamp Factor (dB)	Level (dBuV/m)	Limit Line (dBuV/m)	Over Limit (dB)	Pol.
10420.00	41.29	32.44	17.18	33.91	57.00	68.20	-11.20	V
15630.00	36.49	32.78	20.12	34.86	54.53	68.20	-13.67	V
10420.00	38.73	32.44	17.18	33.91	54.44	68.20	-13.76	H
15630.00	35.47	32.78	20.12	34.86	53.51	68.20	-14.69	H

Average value:

Frequency (MHz)	Read Level (dBuV)	Antenna Factor (dB/m)	Cable Loss (dB)	Preamp Factor (dB)	Level (dBuV/m)	Limit Line (dBuV/m)	Over Limit (dB)	Pol.
10420.00	30.19	32.44	17.18	33.91	45.90	54.00	-8.10	V
15630.00	28.25	32.78	20.12	34.86	46.29	54.00	-7.71	V
10420.00	30.04	32.44	17.18	33.91	45.75	54.00	-8.25	H
15630.00	27.93	32.78	20.12	34.86	45.97	54.00	-8.03	H

Note:

- Final Level = Receiver Read level + Antenna Factor + Cable Loss - Preamplifier Factor

Radiated Band Edge:

Test Mode: 802.11n20								
Peak Value								
Frequency (MHz)	Read Level (dBuV)	Antenna Factor (dB/m)	Cable Loss (dB)	Preamp Factor (dB)	Level (dBuV/m)	Limit (dBuV/m)	Over Limit (dB)	Pol.
5150.00	41.67	28.65	13.58	31.04	52.86	68.20	-15.34	H
5350.00	42.15	29.16	14.68	31.96	54.03	68.20	-14.17	H
5150.00	42.35	28.65	13.58	31.04	53.54	68.20	-14.66	V
5350.00	43.07	29.16	14.68	31.96	54.95	68.20	-13.25	V
Average Value								
Frequency (MHz)	Read Level (dBuV)	Antenna Factor (dB/m)	Cable Loss (dB)	Preamp Factor (dB)	Level (dBuV/m)	Limit (dBuV/m)	Over Limit (dB)	Pol.
5150.00	34.25	28.65	13.58	31.04	45.44	54.00	-8.56	H
5350.00	35.78	29.16	14.68	31.96	47.66	54.00	-6.34	H
5150.00	34.74	28.65	13.58	31.04	45.93	54.00	-8.07	V
5350.00	36.05	29.16	14.68	31.96	47.93	54.00	-6.07	V

Test Mode: 802.11n40								
Peak Value								
Frequency (MHz)	Read Level (dBuV)	Antenna Factor (dB/m)	Cable Loss (dB)	Preamp Factor (dB)	Level (dBuV/m)	Limit (dBuV/m)	Over Limit (dB)	Pol.
5150.00	41.29	28.65	13.58	31.04	52.48	68.20	-15.72	H
5350.00	42.64	29.16	14.68	31.96	54.52	68.20	-13.68	H
5150.00	43.31	28.65	13.58	31.04	54.50	68.20	-13.70	V
5350.00	42.77	29.16	14.68	31.96	54.65	68.20	-13.55	V
Average Value								
Frequency (MHz)	Read Level (dBuV)	Antenna Factor (dB/m)	Cable Loss (dB)	Preamp Factor (dB)	Level (dBuV/m)	Limit (dBuV/m)	Over Limit (dB)	Pol.
5150.00	33.78	28.65	13.58	31.04	44.97	54.00	-9.03	H
5350.00	34.64	29.16	14.68	31.96	46.52	54.00	-7.48	H
5150.00	34.12	28.65	13.58	31.04	45.31	54.00	-8.69	V
5350.00	35.44	29.16	14.68	31.96	47.32	54.00	-6.68	V

Test Mode: 802.11ac20								
Peak Value								
Frequency (MHz)	Read Level (dBuV)	Antenna Factor (dB/m)	Cable Loss (dB)	Preamplifier Factor (dB)	Level (dBuV/m)	Limit (dBuV/m)	Over Limit (dB)	Pol.
5150.00	41.47	28.65	13.58	31.04	52.66	68.20	-15.54	H
5350.00	42.61	29.16	14.68	31.96	54.49	68.20	-13.71	H
5150.00	41.77	28.65	13.58	31.04	52.96	68.20	-15.24	V
5350.00	43.81	29.16	14.68	31.96	55.69	68.20	-12.51	V
Average Value								
Frequency (MHz)	Read Level (dBuV)	Antenna Factor (dB/m)	Cable Loss (dB)	Preamplifier Factor (dB)	Level (dBuV/m)	Limit (dBuV/m)	Over Limit (dB)	Pol.
5150.00	33.53	28.65	13.58	31.04	44.72	54.00	-9.28	H
5350.00	34.25	29.16	14.68	31.96	46.13	54.00	-7.87	H
5150.00	33.78	28.65	13.58	31.04	44.97	54.00	-9.03	V
5350.00	35.13	29.16	14.68	31.96	47.01	54.00	-6.99	V

Test Mode: 802.11ac40								
Peak Value								
Frequency (MHz)	Read Level (dBuV)	Antenna Factor (dB/m)	Cable Loss (dB)	Preamplifier Factor (dB)	Level (dBuV/m)	Limit (dBuV/m)	Over Limit (dB)	Pol.
5150.00	41.25	28.65	13.58	31.04	52.44	68.20	-15.76	H
5350.00	42.37	29.16	14.68	31.96	54.25	68.20	-13.95	H
5150.00	41.54	28.65	13.58	31.04	52.73	68.20	-15.47	V
5350.00	43.41	29.16	14.68	31.96	55.29	68.20	-12.91	V
Average Value								
Frequency (MHz)	Read Level (dBuV)	Antenna Factor (dB/m)	Cable Loss (dB)	Preamplifier Factor (dB)	Level (dBuV/m)	Limit (dBuV/m)	Over Limit (dB)	Pol.
5150.00	33.47	28.65	13.58	31.04	44.66	54.00	-9.34	H
5350.00	34.61	29.16	14.68	31.96	46.49	54.00	-7.51	H
5150.00	33.62	28.65	13.58	31.04	44.81	54.00	-9.19	V
5350.00	35.01	29.16	14.68	31.96	46.89	54.00	-7.11	V

Test Mode: 802.11ac80								
Peak Value								
Frequency (MHz)	Read Level (dBuV)	Antenna Factor (dB/m)	Cable Loss (dB)	Preamp Factor (dB)	Level (dBuV/m)	Limit (dBuV/m)	Over Limit (dB)	Pol.
5150.00	41.63	28.65	13.58	31.04	52.82	68.20	-15.38	H
5350.00	42.49	29.16	14.68	31.96	54.37	68.20	-13.83	H
5150.00	41.21	28.65	13.58	31.04	52.40	68.20	-15.80	V
5350.00	43.82	29.16	14.68	31.96	55.70	68.20	-12.50	V
Average Value								
Frequency (MHz)	Read Level (dBuV)	Antenna Factor (dB/m)	Cable Loss (dB)	Preamp Factor (dB)	Level (dBuV/m)	Limit (dBuV/m)	Over Limit (dB)	Pol.
5150.00	33.65	28.65	13.58	31.04	44.84	54.00	-9.16	H
5350.00	34.45	29.16	14.68	31.96	46.33	54.00	-7.67	H
5150.00	33.72	28.65	13.58	31.04	44.91	54.00	-9.09	V
5350.00	35.31	29.16	14.68	31.96	47.19	54.00	-6.81	V

For conducted test:

802.11n(20): Band Edge, Left Side

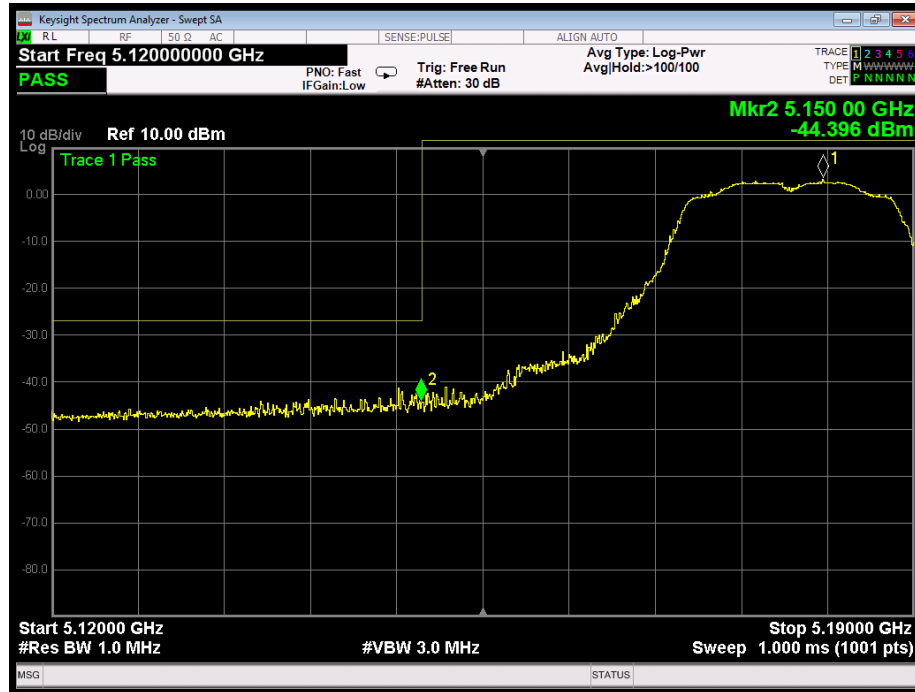

802.11n(20): Band Edge, Right Side

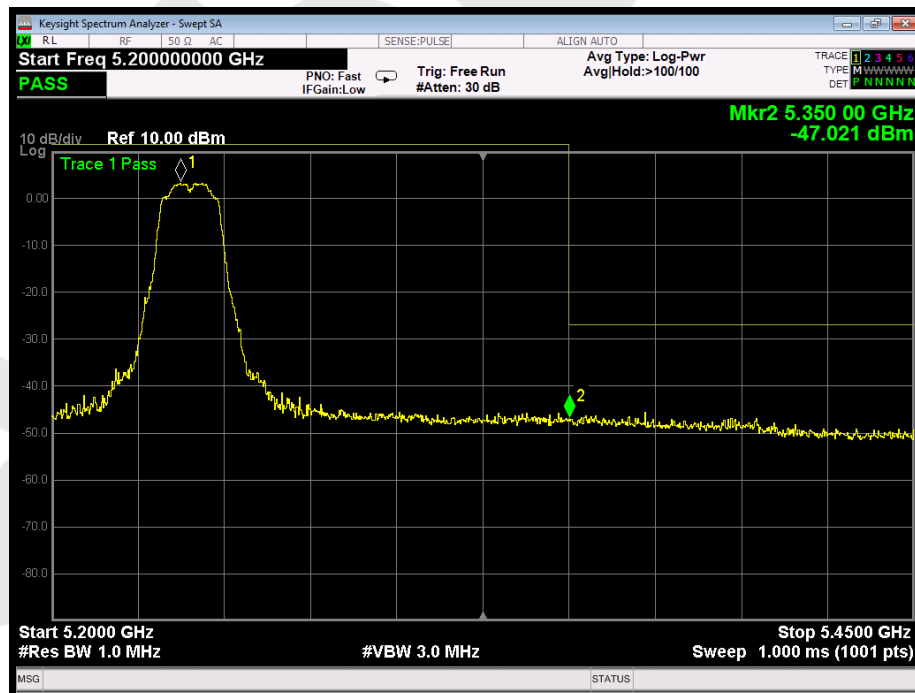

802.11ac(20): Band Edge, Left Side

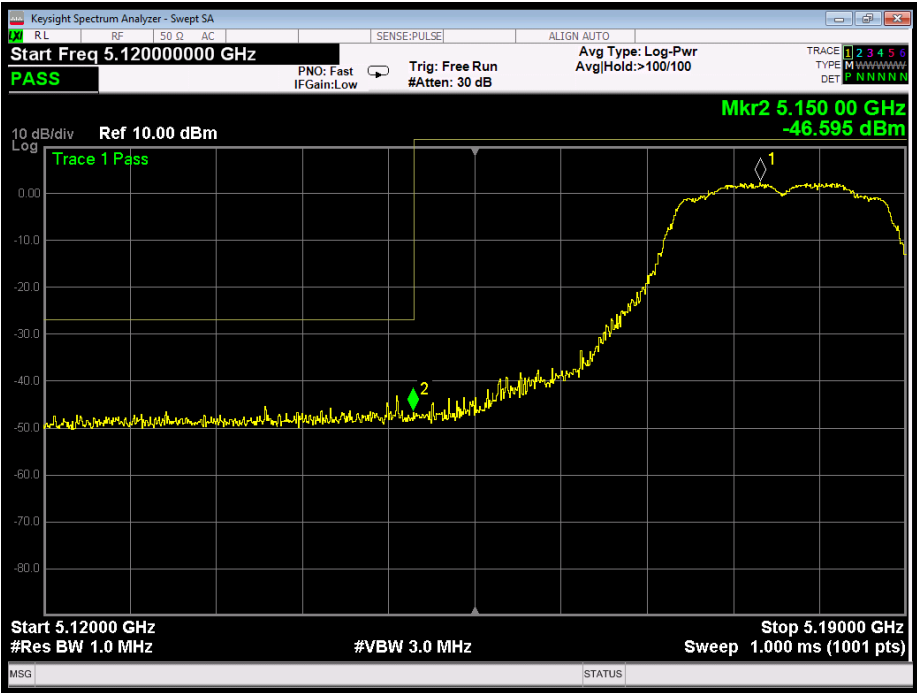

802.11ac(20): Band Edge, Right Side

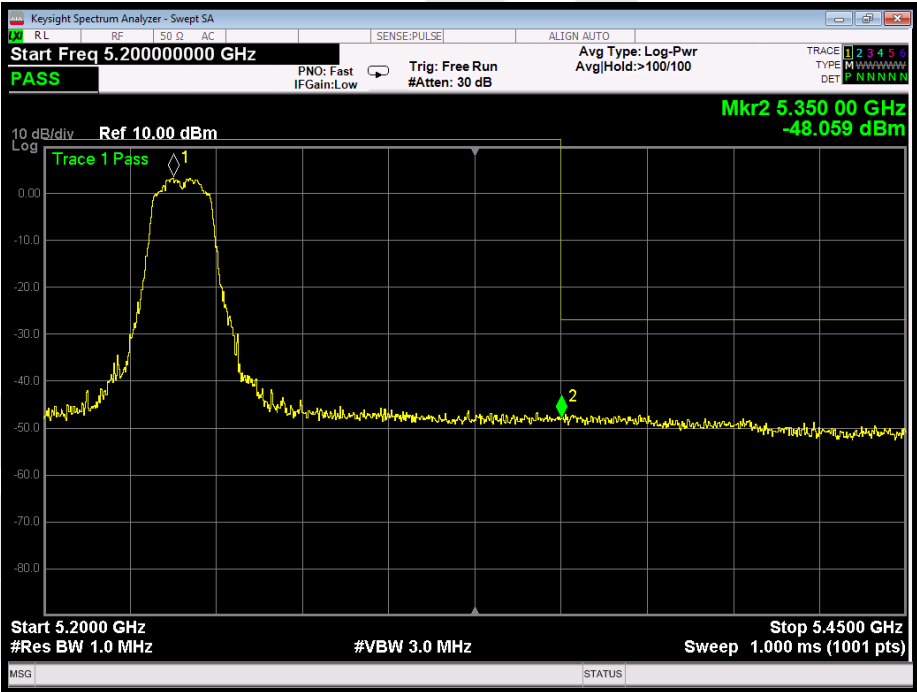

802.11n(40): Band Edge, Left Side

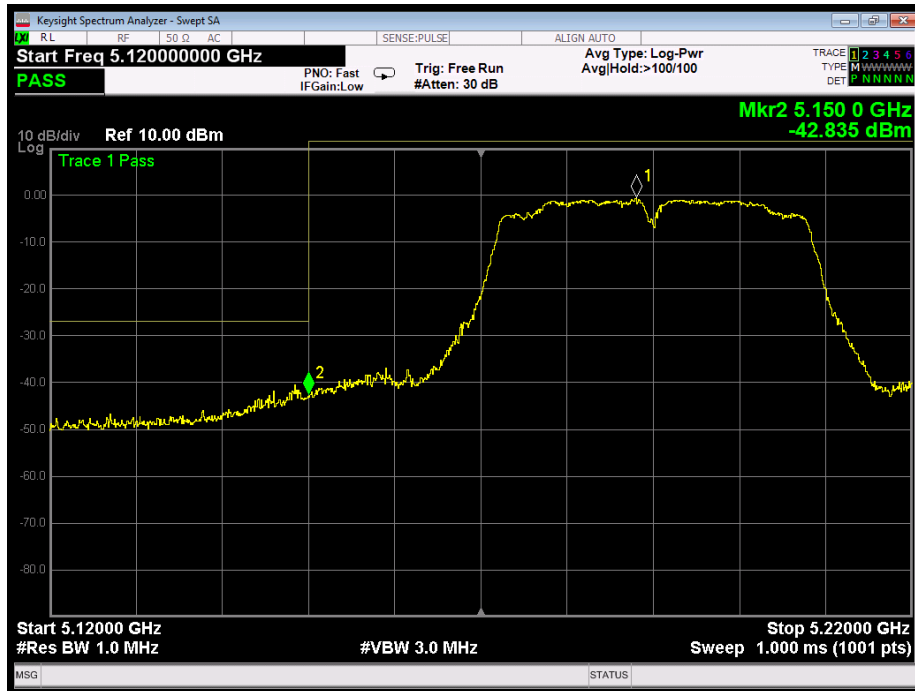

802.11n(40): Band Edge, Right Side

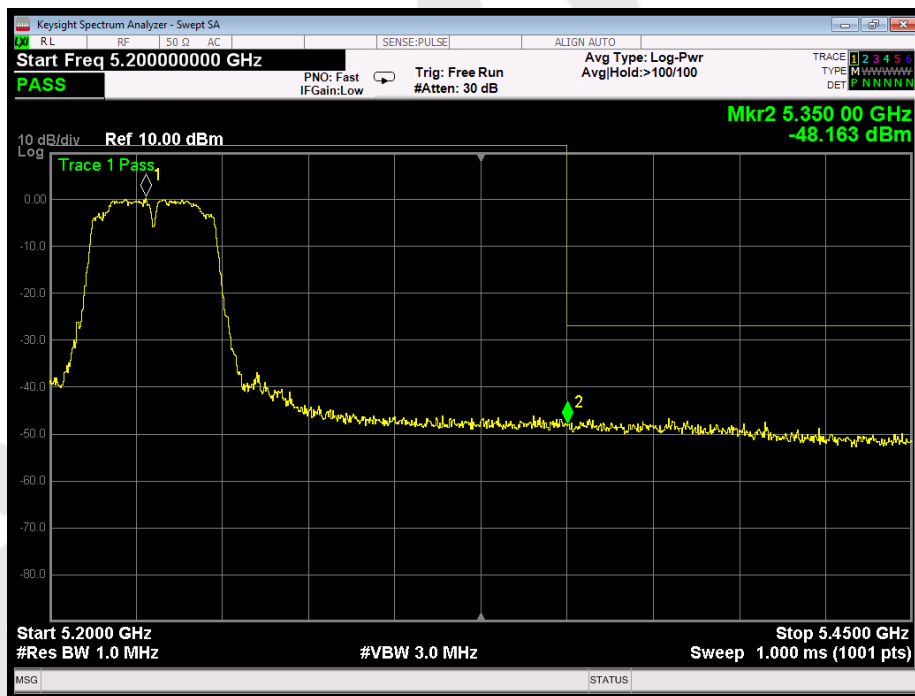

802.11ac(40): Band Edge, Left Side

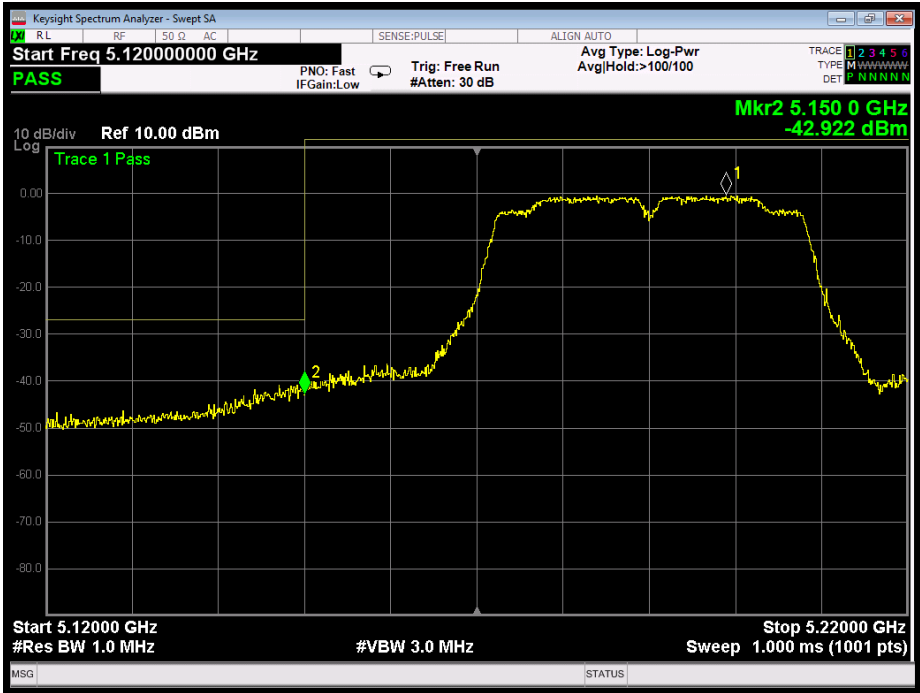

802.11ac(40): Band Edge, Right Side

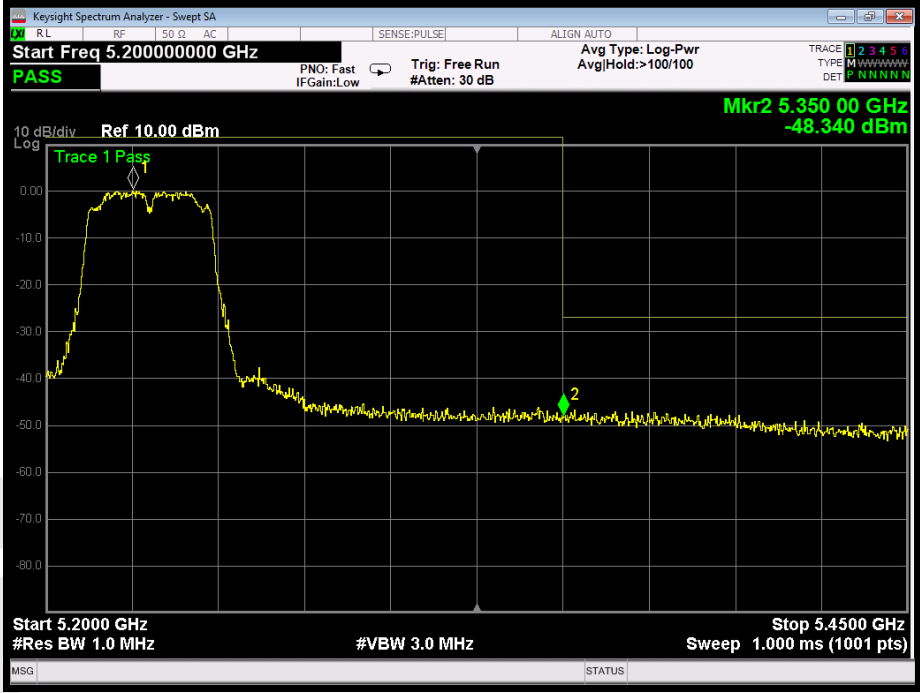

802.11ac(80): Band Edge, Left Side&Right Side

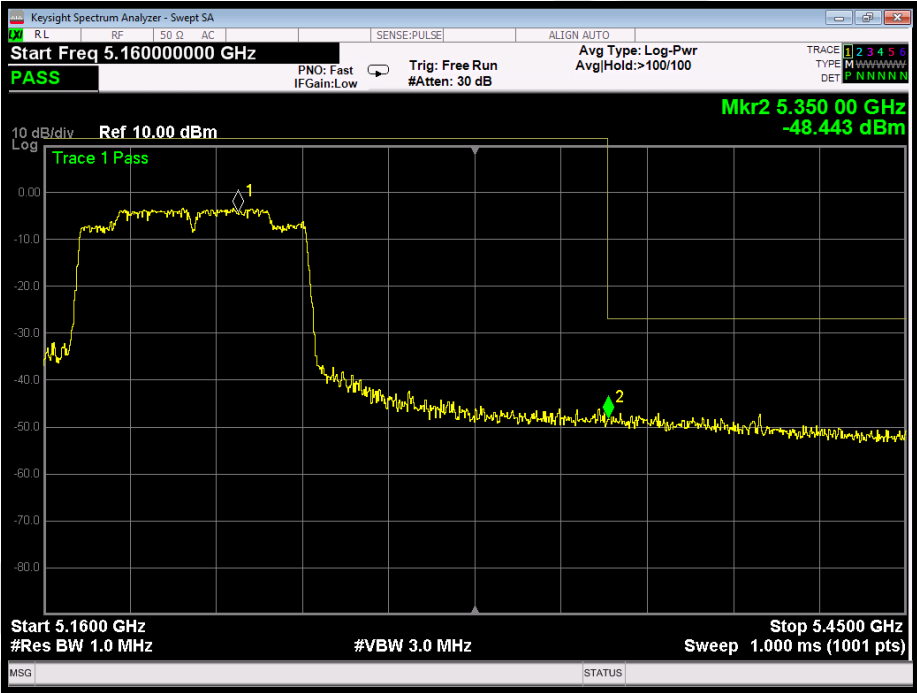
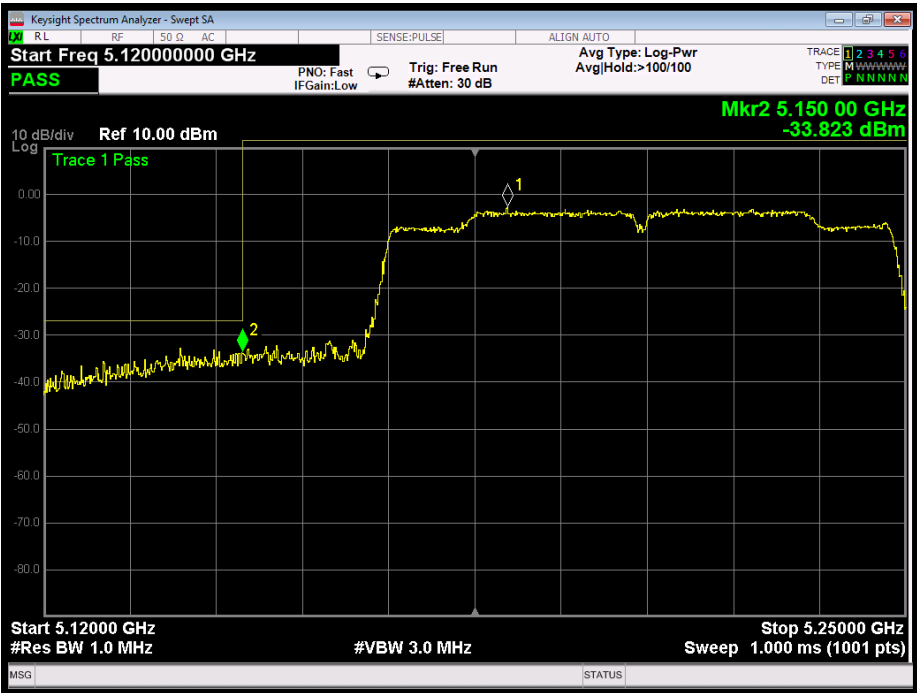

5. Maximum Peak Output Power Test

5.1. Test Standard and Limit

Test Standard	FCC Part15 C Section 15.407 (a)(1) (3)
Test Limit	24dBm

5.2. Test Setup

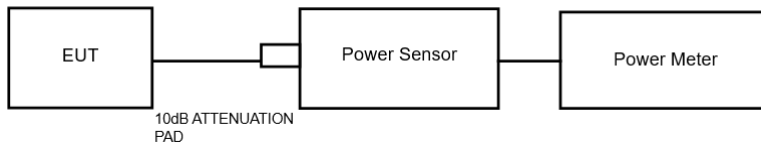

5.3. Test Procedure

1. The Transmitter output (antenna port) was connected to the power meter.
2. Turn on the EUT and power meter and then record the power value.
3. Repeat above procedures on all channels needed to be tested.

Note: The cable loss and attenuator loss were offset into measure device as an amplitude offset.

5.4. Test Data

Test Item	: Max. peak output power	Test Mode	: CH Low ~ CH High
Test Voltage	: DC 5V USB Port	Temperature	: 24°C
Test Result	: PASS	Humidity	: 55%RH

Mode	Channel Frequency (MHz)	Peak Power output (dBm)	Limit (dBm)	Results
802.11n20	5180	12.98	24.00	PASS
	5200	12.69	24.00	PASS
	5240	12.93	24.00	PASS
802.11n40	5190	12.40	24.00	PASS
	5230	12.58	24.00	PASS
802.11ac20	5180	12.85	24.00	PASS
	5200	12.64	24.00	PASS
	5240	12.91	24.00	PASS
802.11ac40	5190	12.49	24.00	PASS
	5230	12.94	24.00	PASS
802.11ac80	5210	12.26	24.00	PASS

6. Occupy Bandwidth Test

6.1. Test Standard

Test Standard	FCC Part15 C Section 15.407 (a)(5)
---------------	------------------------------------

6.2. Test Setup

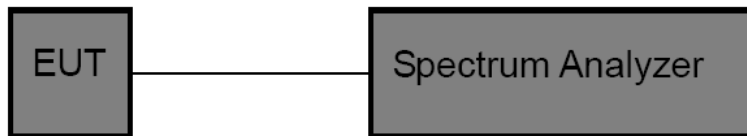

6.3. Test Procedure

1. Place the EUT on the table and set it in the transmitting mode.
2. Remove the antenna from the EUT and then connect a low loss RF cable from the antenna port to the spectrum analyzer.

3. Set the spectrum analyzer as:

26 dB & 99% bandwidth

- RBW = approximately 1% of the emission bandwidth;
- Set the VBW > RBW;
- Detector = Peak
- Trace mode = Max hold.
- Sweep - auto couple.

6 dB bandwidth

- RBW = 100kHz;
- Set the video bandwidth (VBW) ≥ 3 RBW;
- Detector = Peak
- Trace mode = Max hold.
- Sweep - auto couple.

4. Measure the maximum width of the emission that is 26dB /6dB down from the maximum of the emission. Compare this with the RBW setting of the analyzer.
5. Repeat until all the rest channels are investigated.

6.4. Test Data

Test Item	: 6dB & 26dB BW	Test Mode	: CH Low ~ CH High
Test Voltage	: DC 5V USB Port	Temperature	: 24°C
Test Result	: PASS	Humidity	: 55%RH

Mode	Channel Frequency (MHz)	6dB BW(MHz)	Limit	Results
802.11n20	5180	15.18	>0.5MHz	PASS
	5200	15.16		PASS
	5240	15.16		PASS
802.11ac20	5180	15.15		PASS
	5200	15.17		PASS
	5240	15.16		PASS
802.11ac40	5190	35.21		PASS
	5230	35.17		PASS
802.11n40	5190	35.21		PASS
	5230	33.93		PASS
802.11ac80	5210	75.42		PASS

Mode	Channel Frequency (MHz)	26dB BW(MHz)	99%Bandwidth (MHz)
802.11n20	5180	22.52	17.676
	5200	22.32	17.661
	5240	23.50	17.688
802.11ac20	5180	22.82	17.671
	5200	22.55	17.689
	5240	23.10	17.700
802.11ac40	5190	41.89	36.046
	5230	42.40	36.096
802.11n40	5190	41.67	36.110
	5230	41.32	36.134
802.11ac80	5210	81.48	75.400

6dB Bandwidth

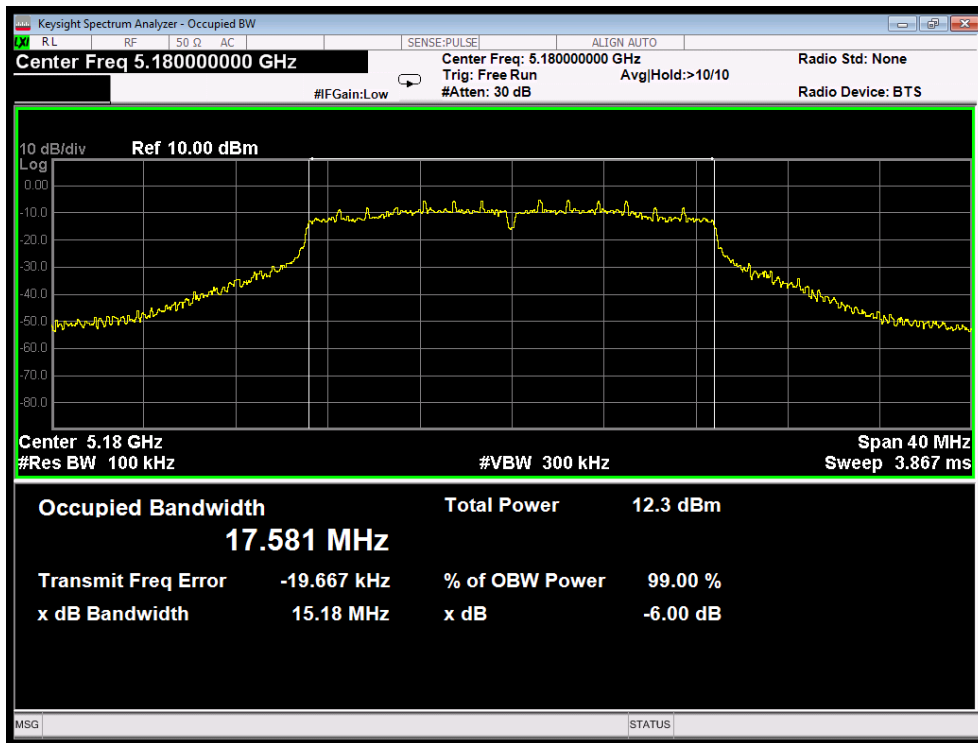

Test Mode: 802.11n20---Low

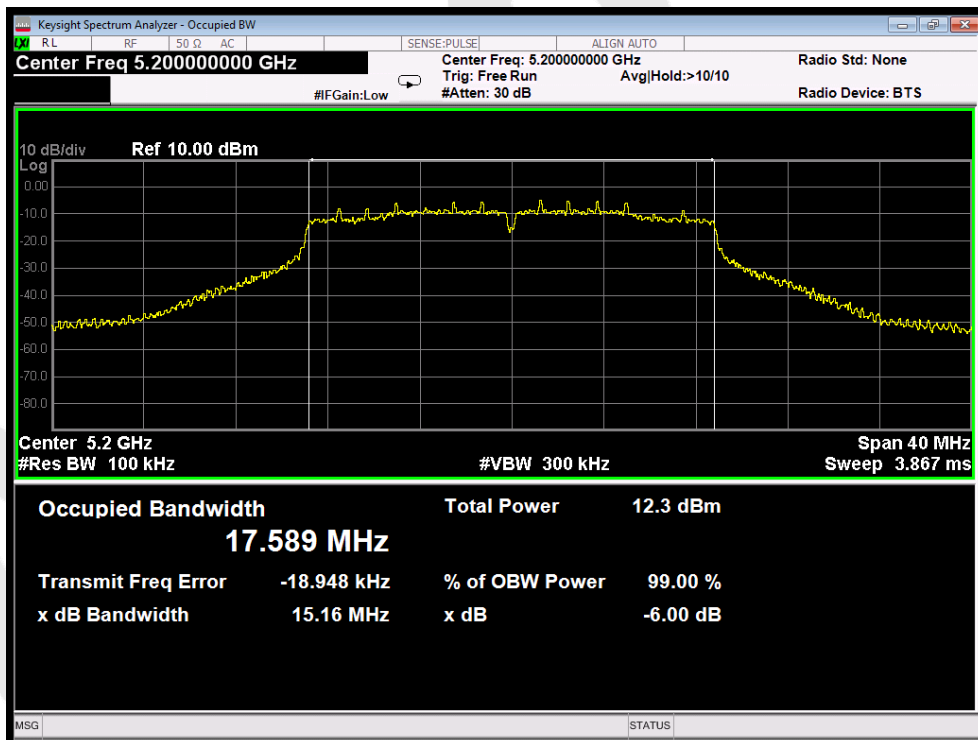

Test Mode: 802.11n20---Middle

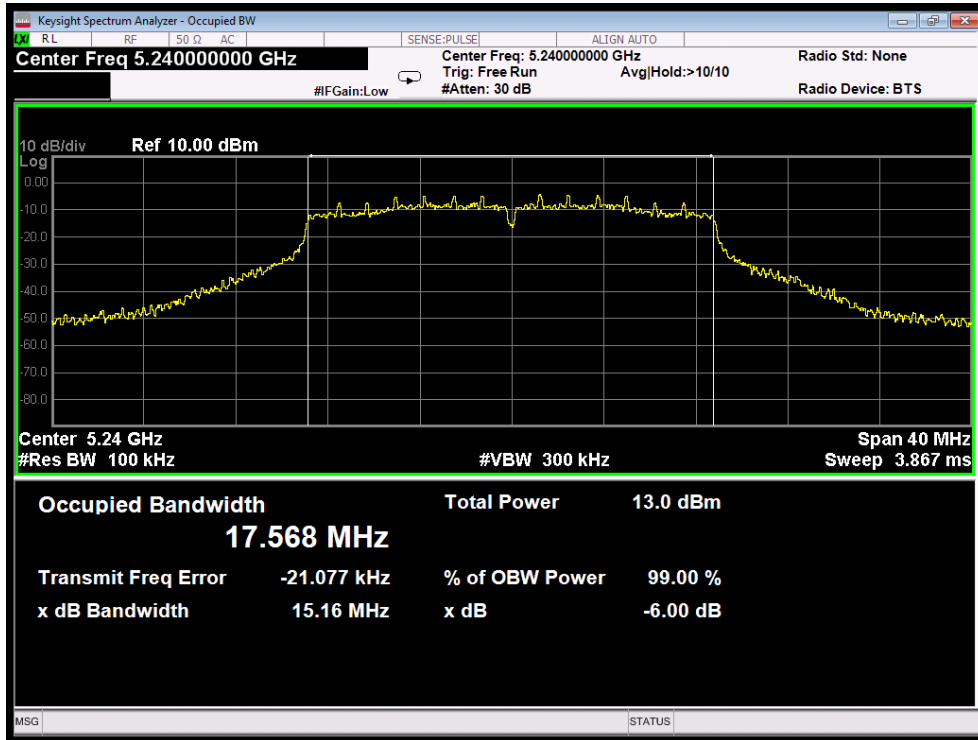

Test Mode: 802.11n20---High

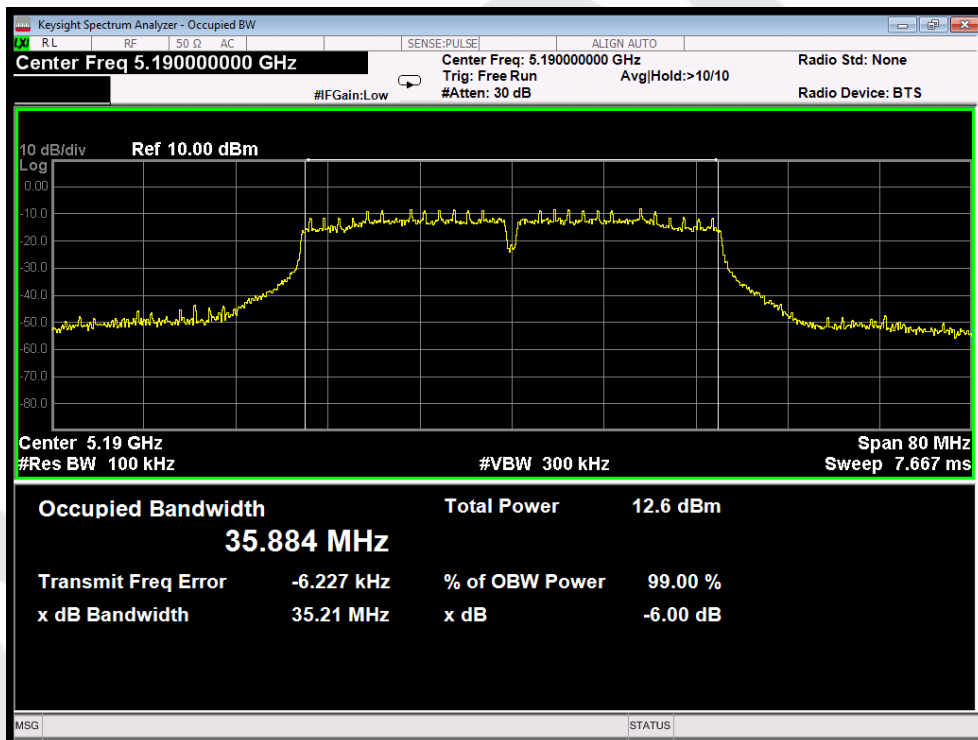

Test Mode: 802.11n40--Low

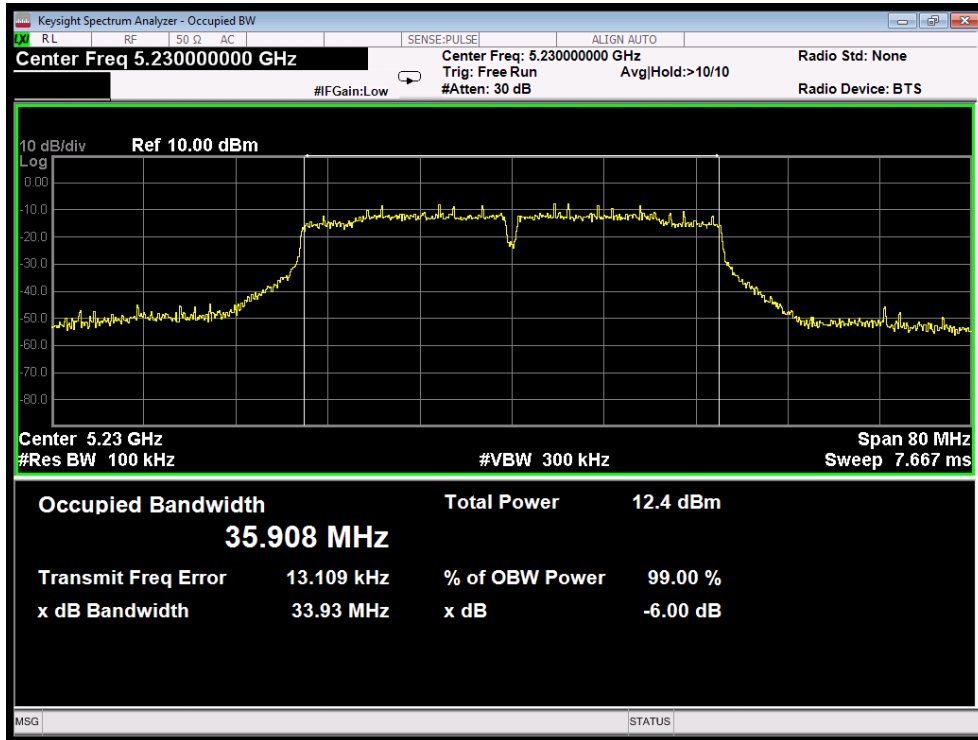

Test Mode: 802.11n40---High

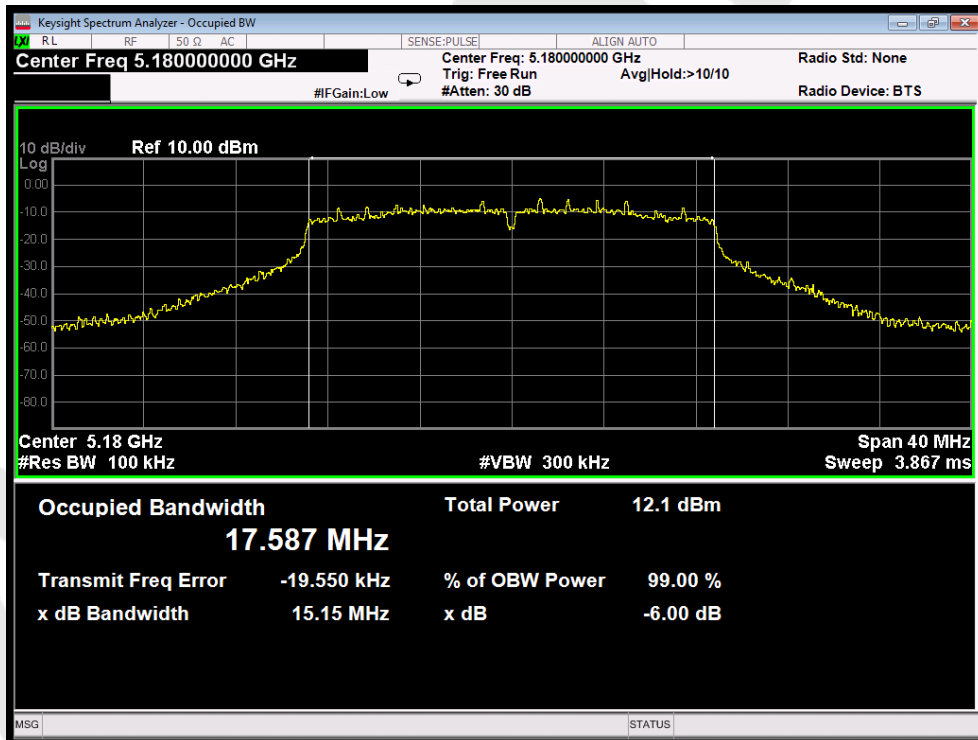

Test Mode: 802.11ac20--Low

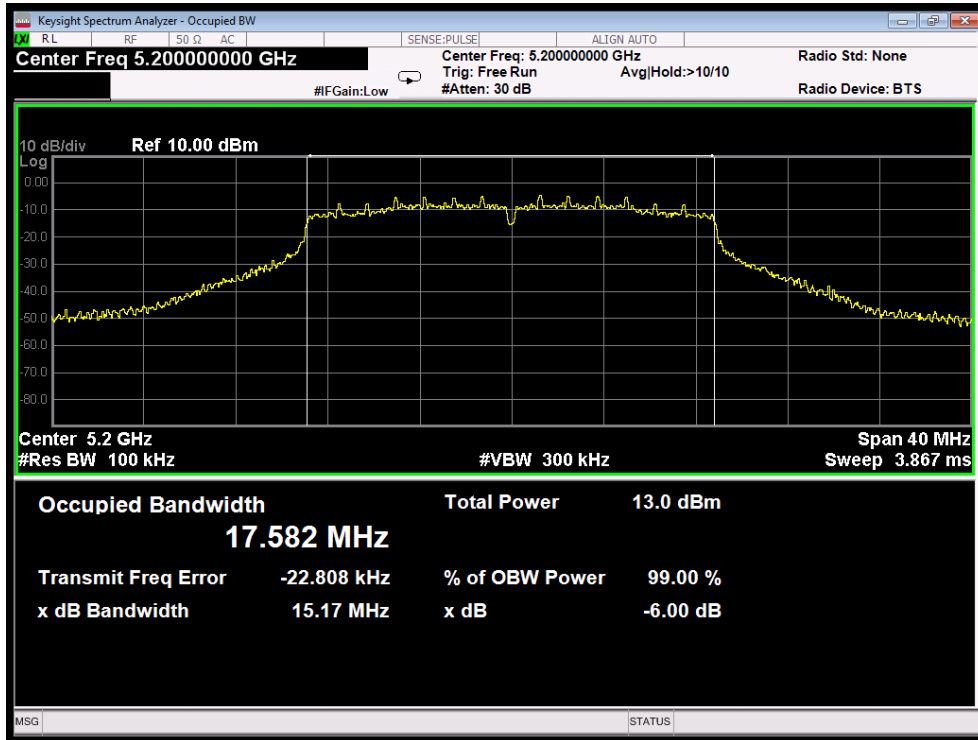

Test Mode: 802.11ac20---Middle

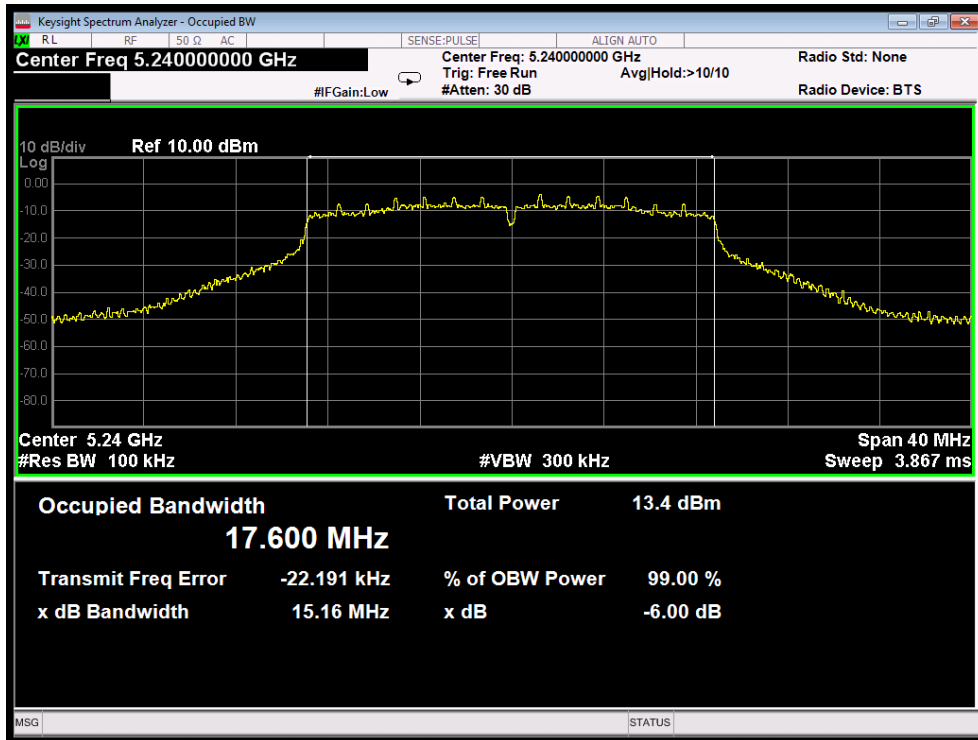

Test Mode: 802.11ac20---High

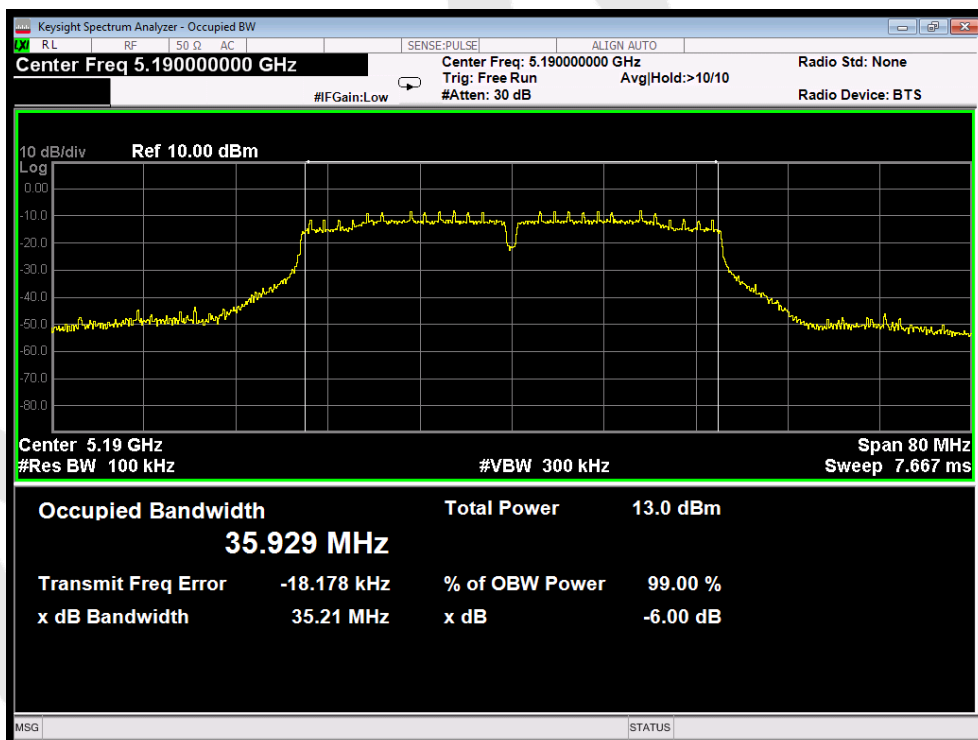

Test Mode: 802.11ac40---Low

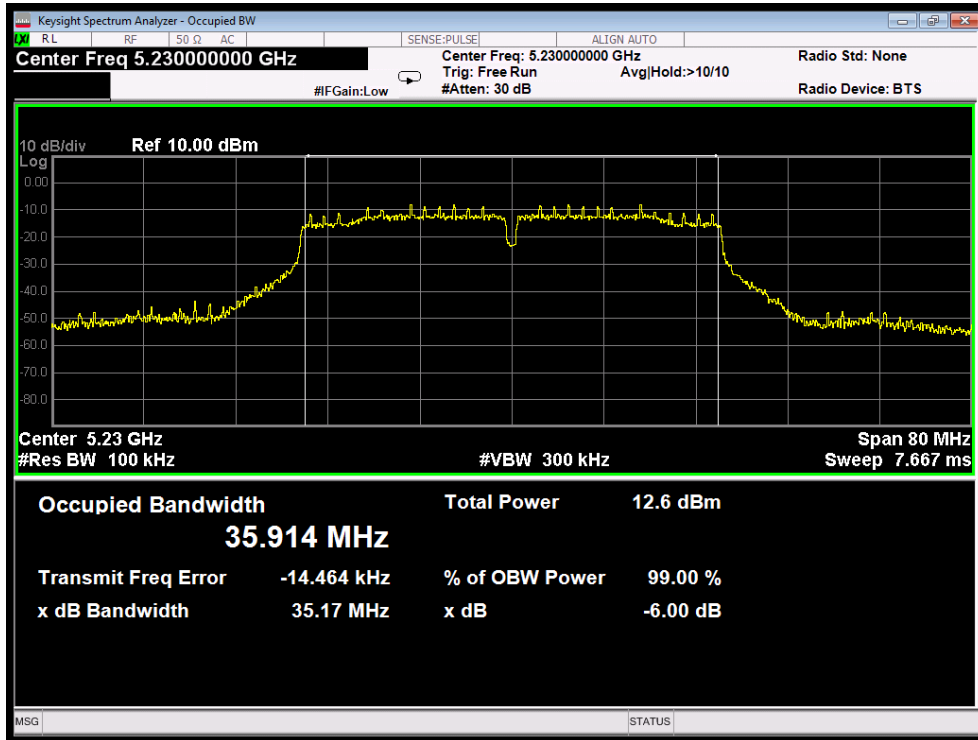

Test Mode: 802.11ac40---High

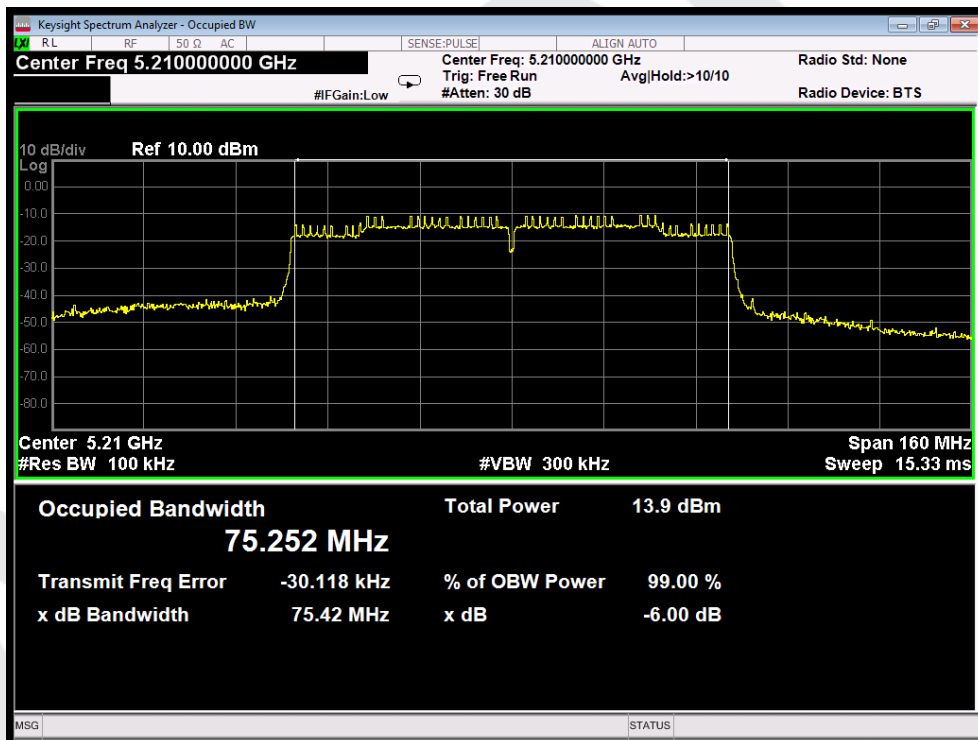

Test Mode: 802.11ac80

26dB & 99% Bandwidth

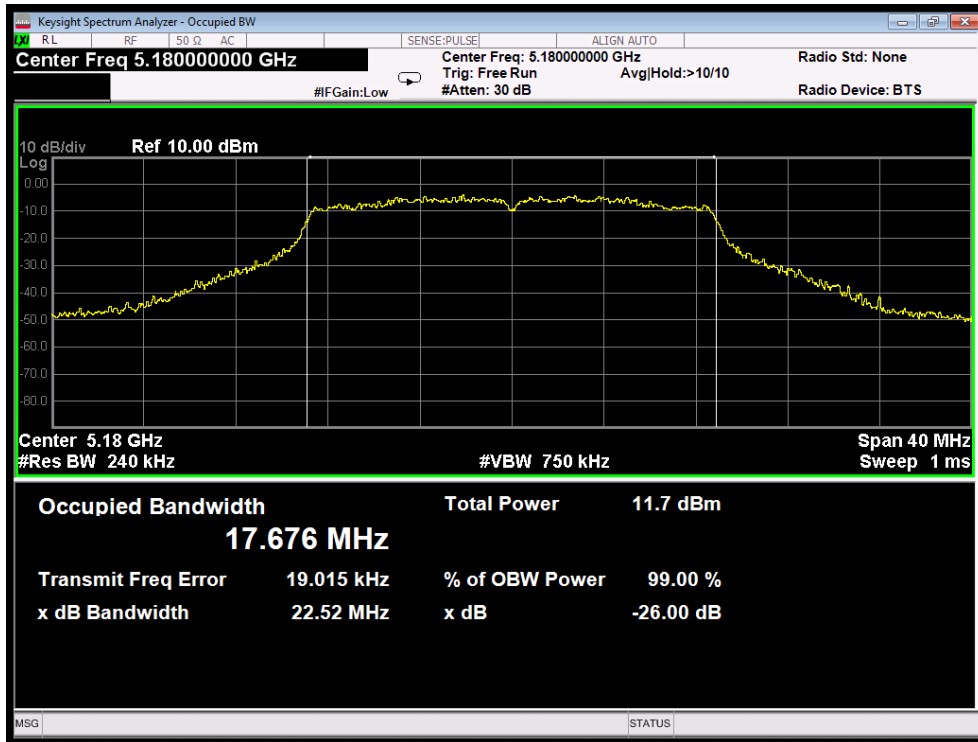

Test Mode: 802.11n20---Low

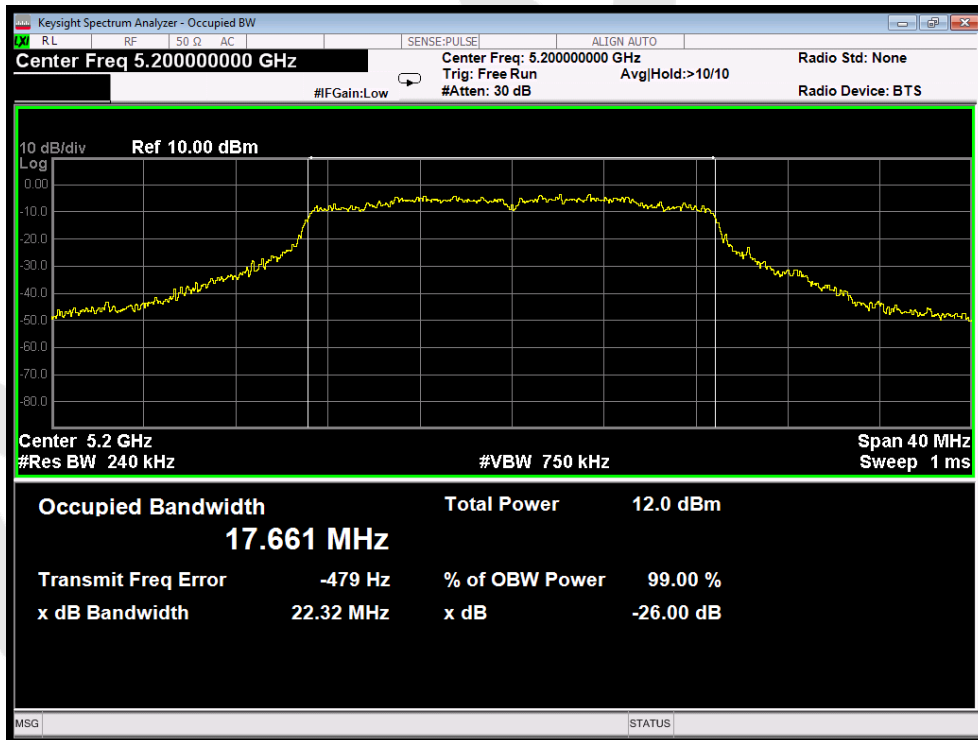

Test Mode: 802.11n20---Middle

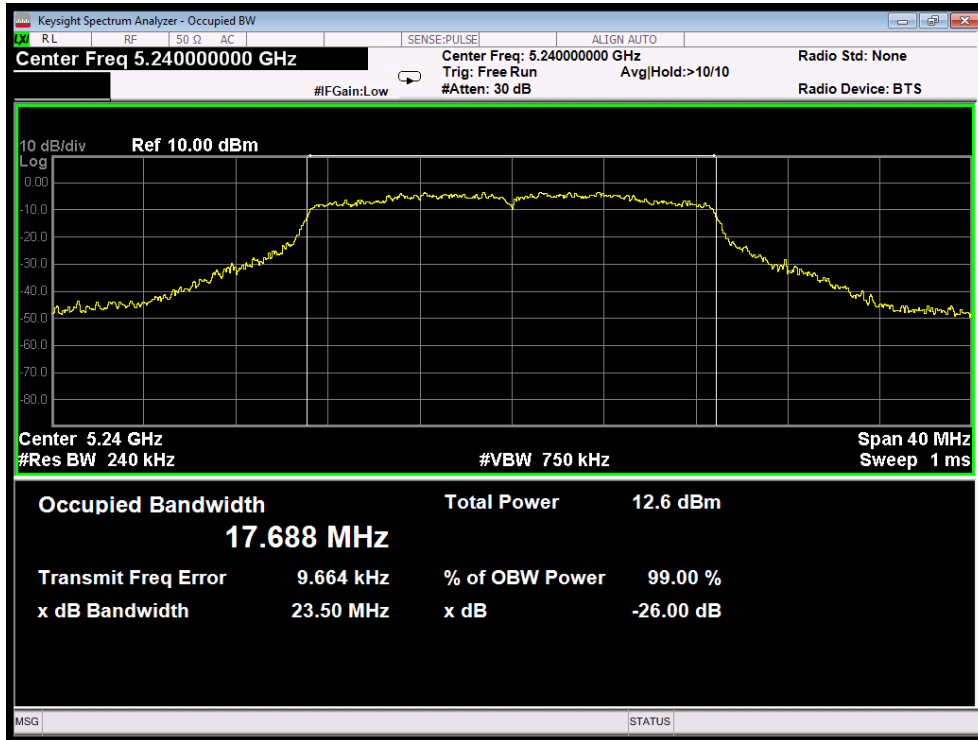

Test Mode: 802.11n20---High

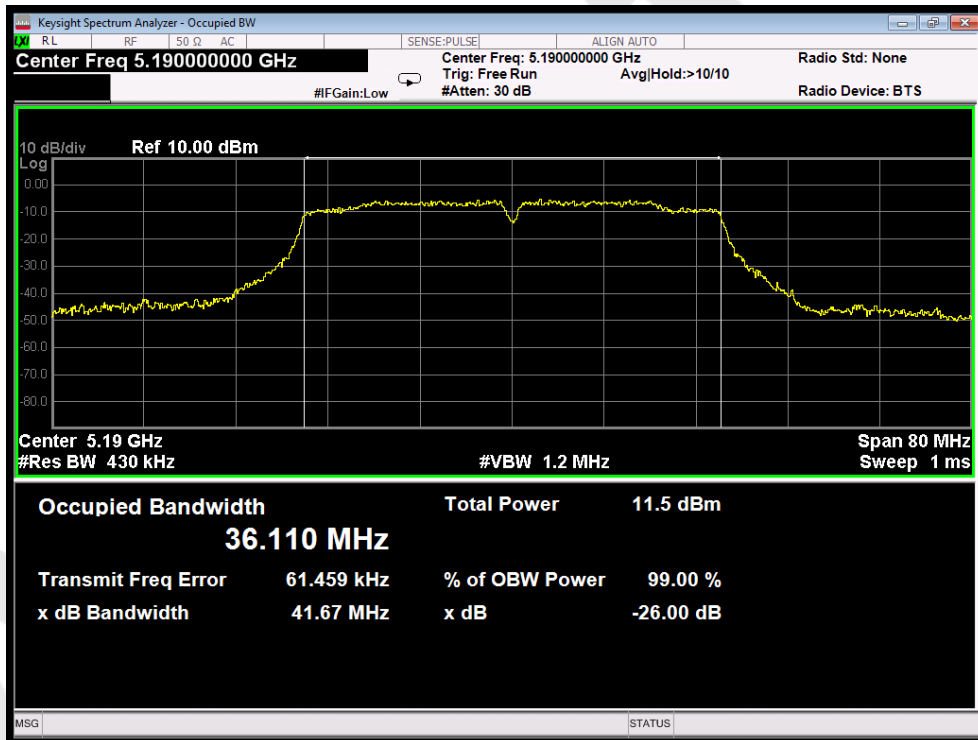

Test Mode: 802.11n40---Low

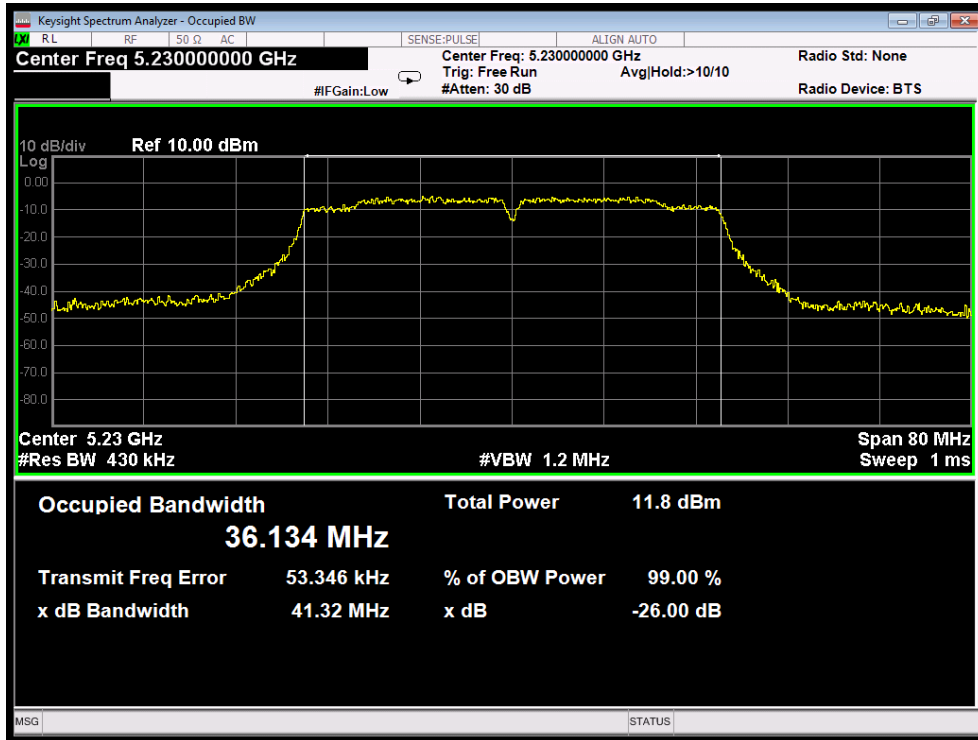

Test Mode: 802.11n40--High

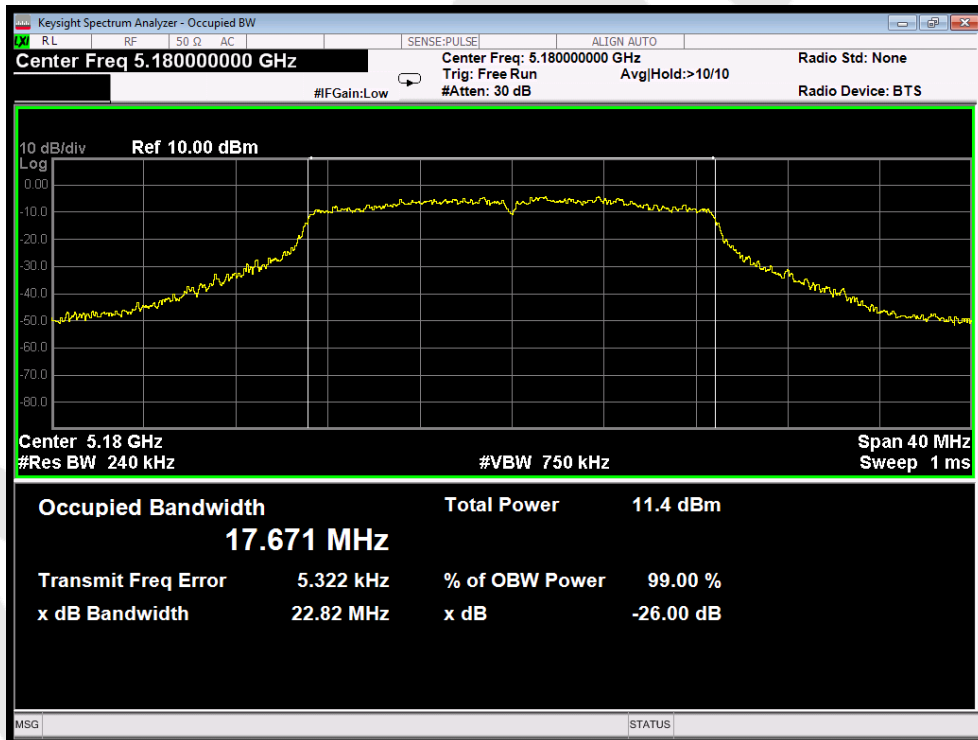

Test Mode: 802.11ac20--Low

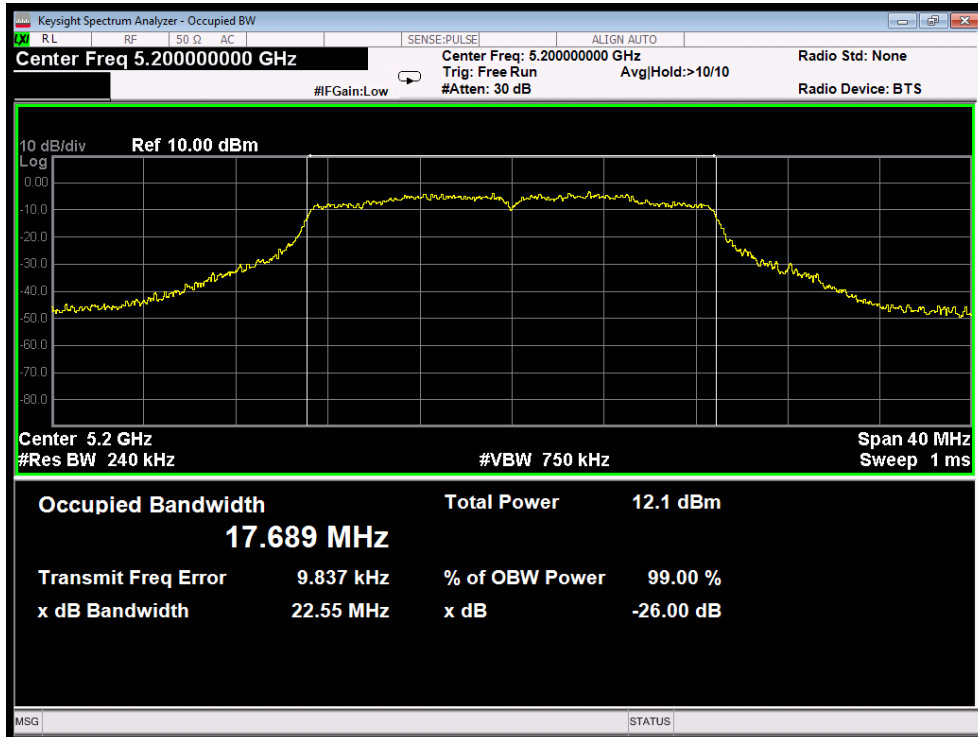

Test Mode: 802.11ac20---Middle

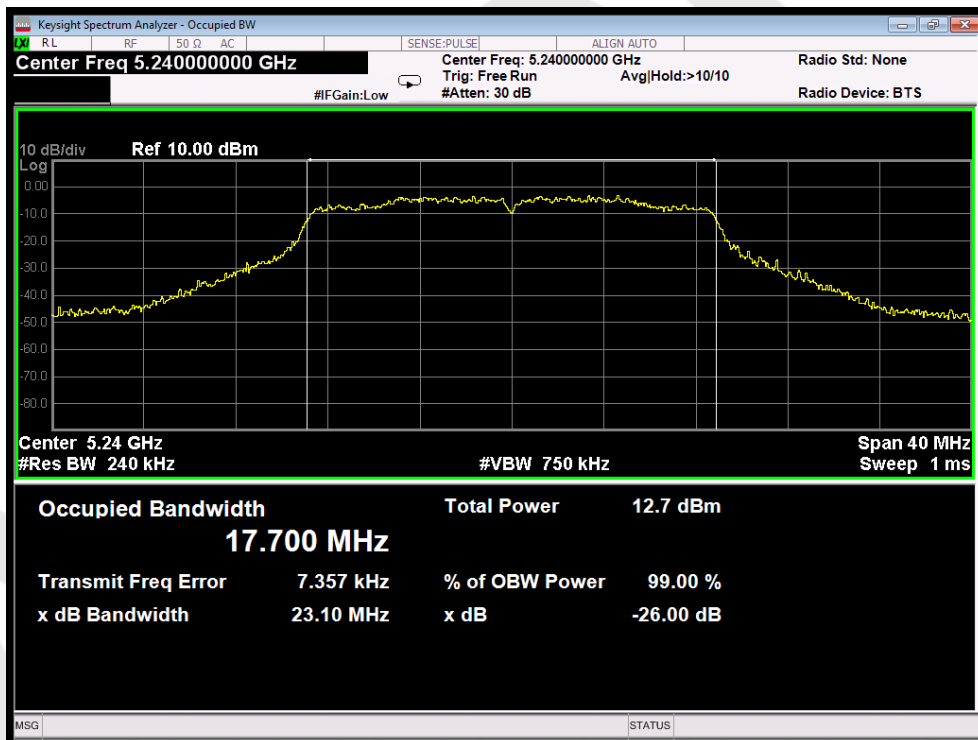

Test Mode: 802.11ac20---High

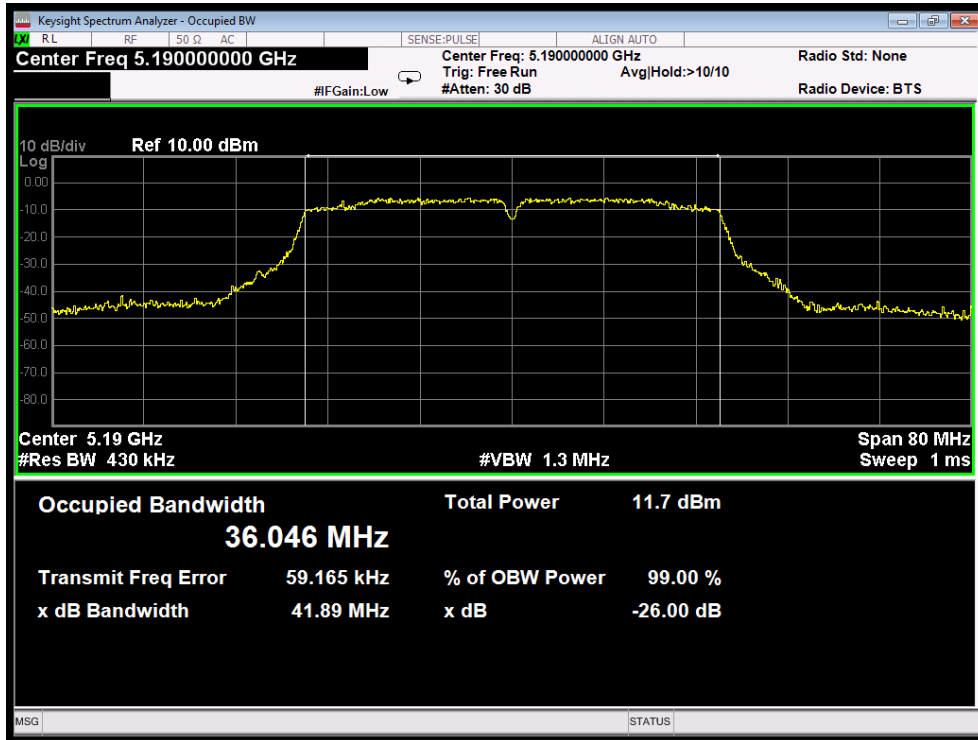

Test Mode: 802.11ac40---Low

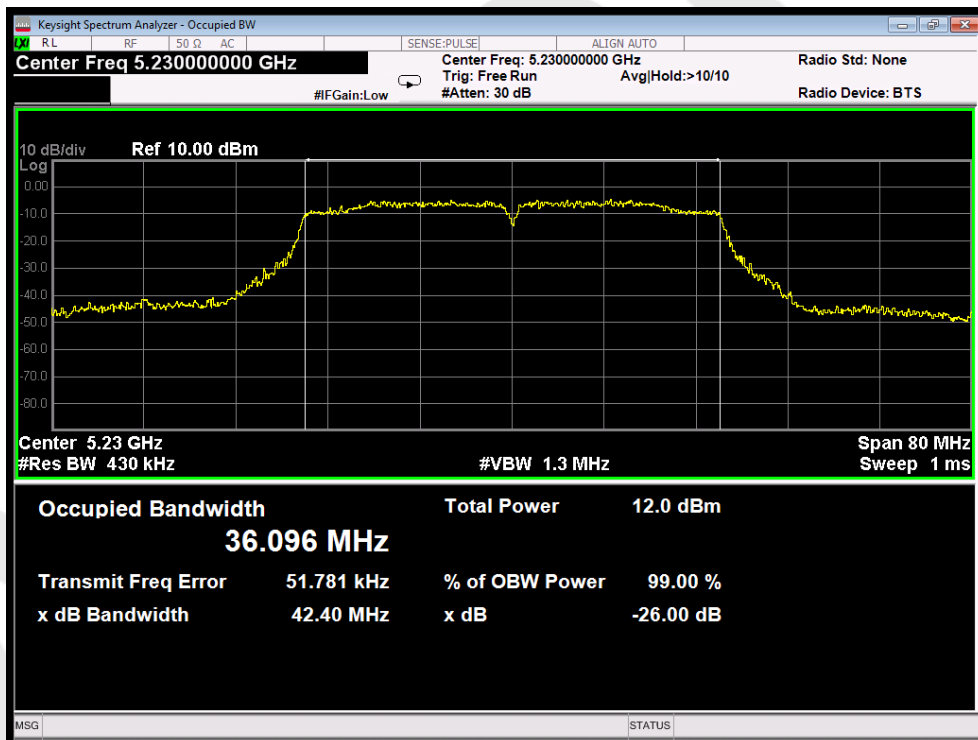

Test Mode: 802.11ac40---High

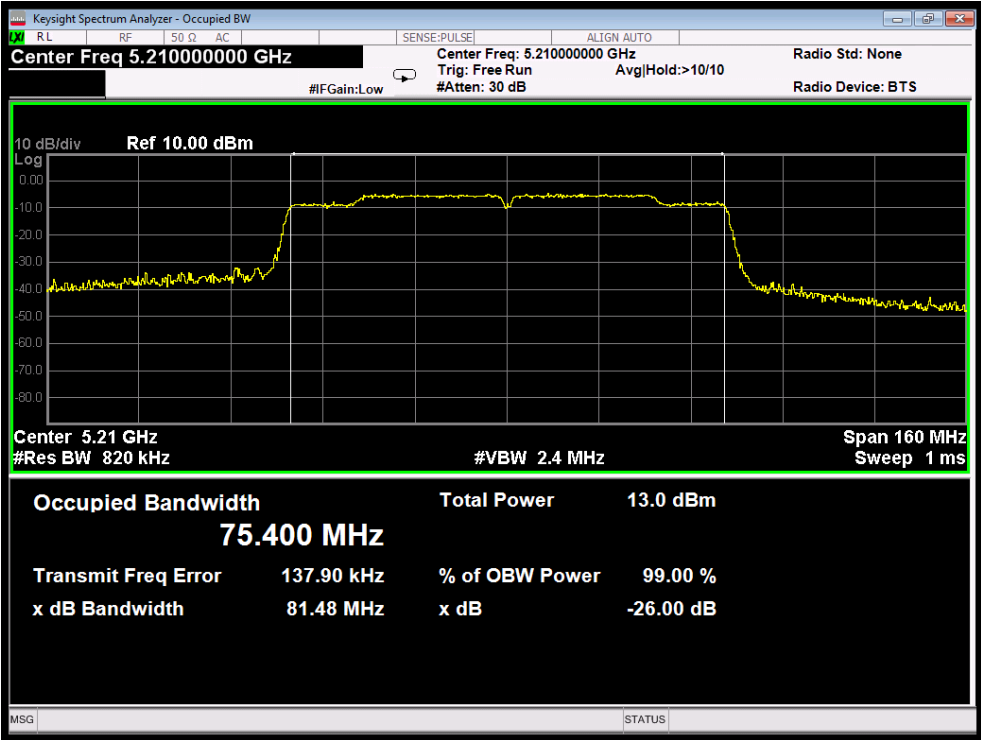

Test Mode: 802.11ac80

7. Power Spectral Density Test

7.1. Test Standard and Limit

Test Standard	FCC Part15 C Section 15.407 (a) (1) (2) (3)
Test Limit	11dBm

7.2. Test Setup

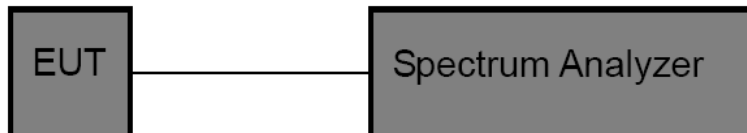

7.3. Test Procedure

For devices operating in the bands 5.15-5.25 GHz, 5.25-5.35 GHz, and 5.47-5.725 GHz, the above procedures make use of 1 MHz RBW to satisfy directly the 1 MHz reference bandwidth specified in § 15.407(a)(5). For devices operating in the band 5.725-5.85 GHz, the rules specify a measurement bandwidth of 500 kHz. Many spectrum analyzers do not have 500 kHz RBW, thus a narrower RBW may need to be used. The rules permit the use of a RBWs less than 1 MHz, or 500 kHz, “provided that the measured power is integrated over the full reference bandwidth” to show the total power over the specified measurement bandwidth (i.e., 1 MHz, or 500 kHz).

1. The EUT is directly connected to the spectrum analyzer;
2. Set RBW =1MHz;
3. Set VBW \geq 3 RBW=3MHz;
3. Set the span to encompass the entire emissions bandwidth (EBW) of the signal;
5. Detector=RMS;
6. Sweep time= auto couple;
7. Trace mode=max. hold;

7.4. Test Data

Test Item	: Power Spectral Density	Test Mode	: CH Low ~ CH High
Test Voltage	: DC 5V USB Port	Temperature	: 24°C
Test Result	: PASS	Humidity	: 55%RH

Mode	Channel Frequency (MHz)	Final Power Spectral Density (dBm)	Limit	Results
802.11n20	5180	0.341	11dBm	PASS
	5200	0.394		PASS
	5240	0.309		PASS
802.11ac20	5180	-0.081		PASS
	5200	0.223		PASS
	5240	0.361		PASS
802.11ac40	5190	-3.782		PASS
	5230	-2.722		PASS
802.11n40	5190	-3.386		PASS
	5230	-2.700		PASS
802.11ac80	5210	-5.672		PASS

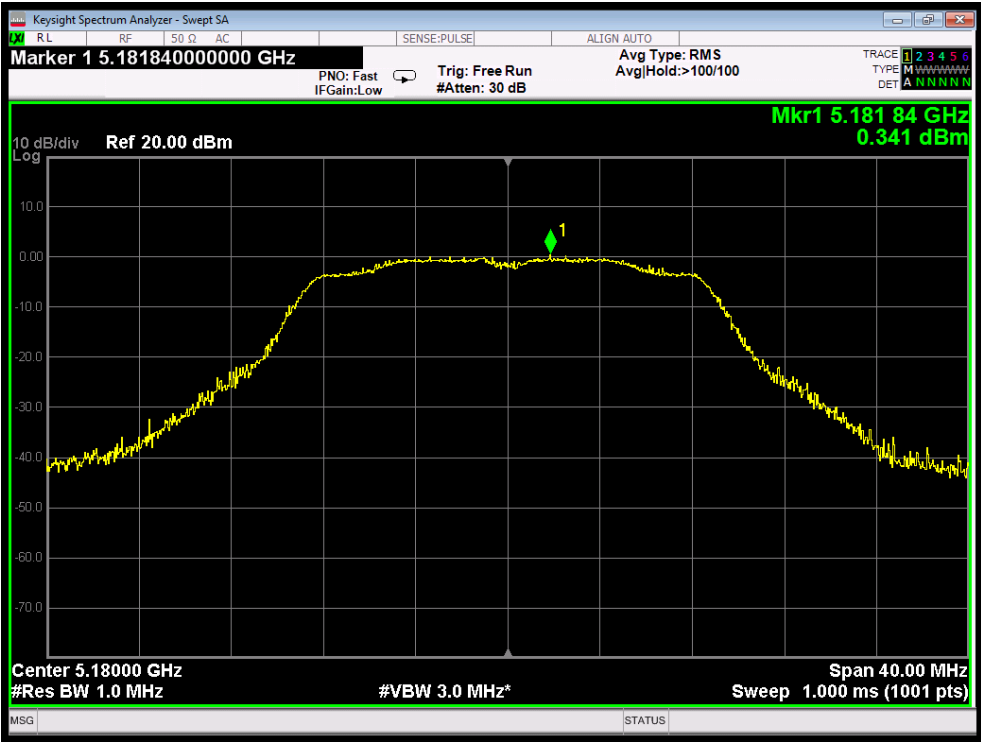

Test Mode: 802.11n20---Low

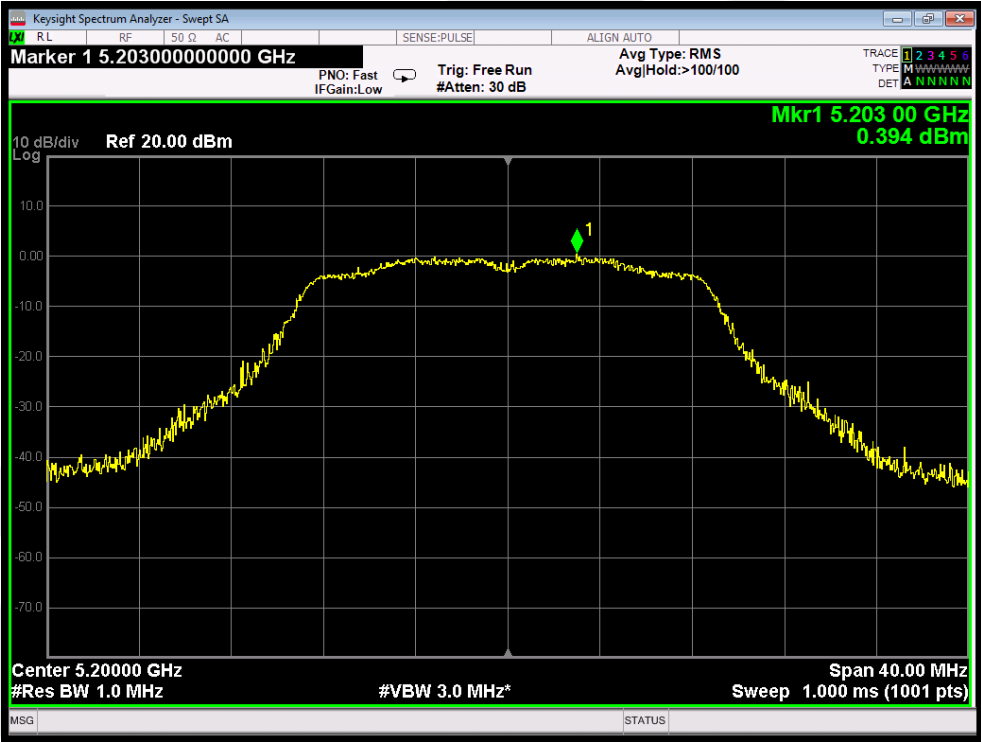

Test Mode: 802.11n20---Middle

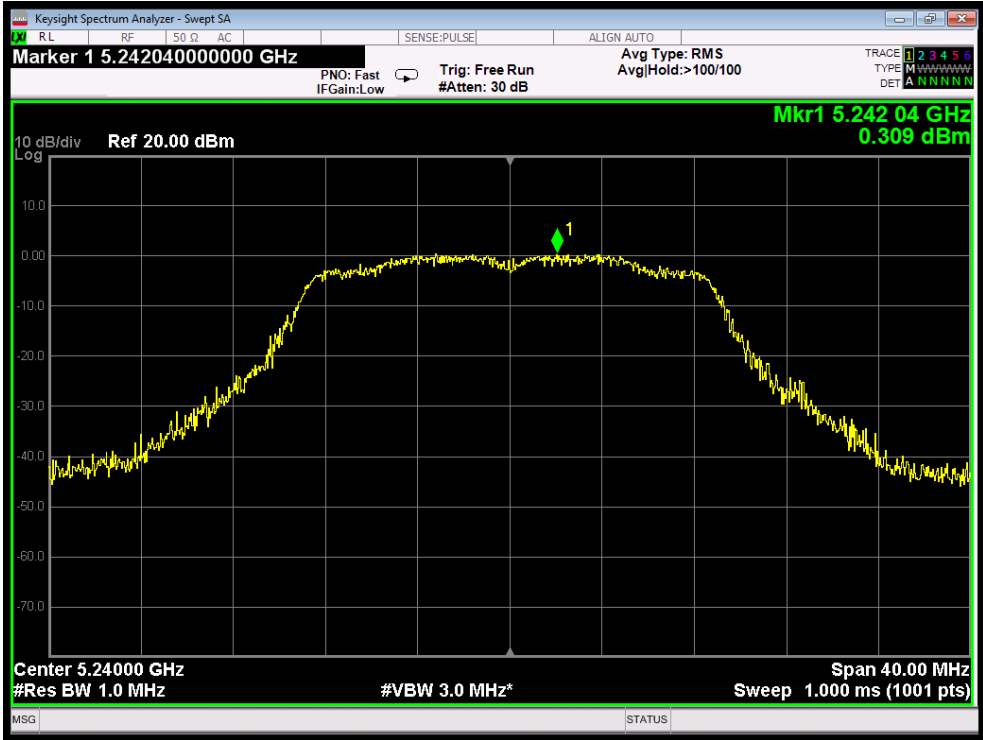

Test Mode: 802.11n20---High

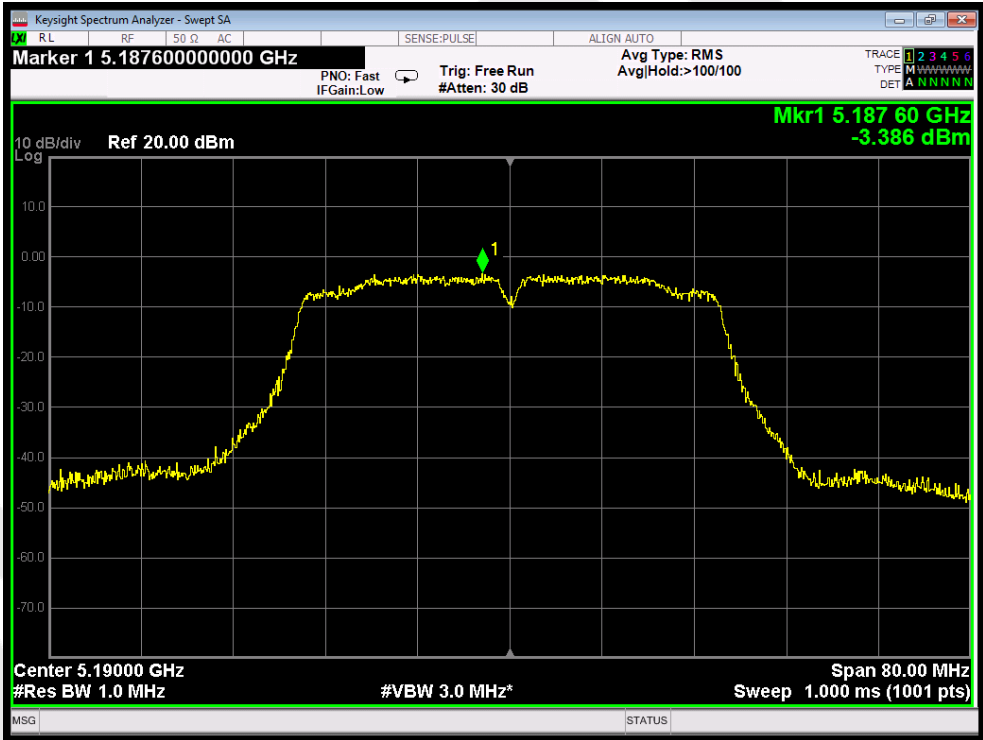

Test Mode: 802.11n40--Low

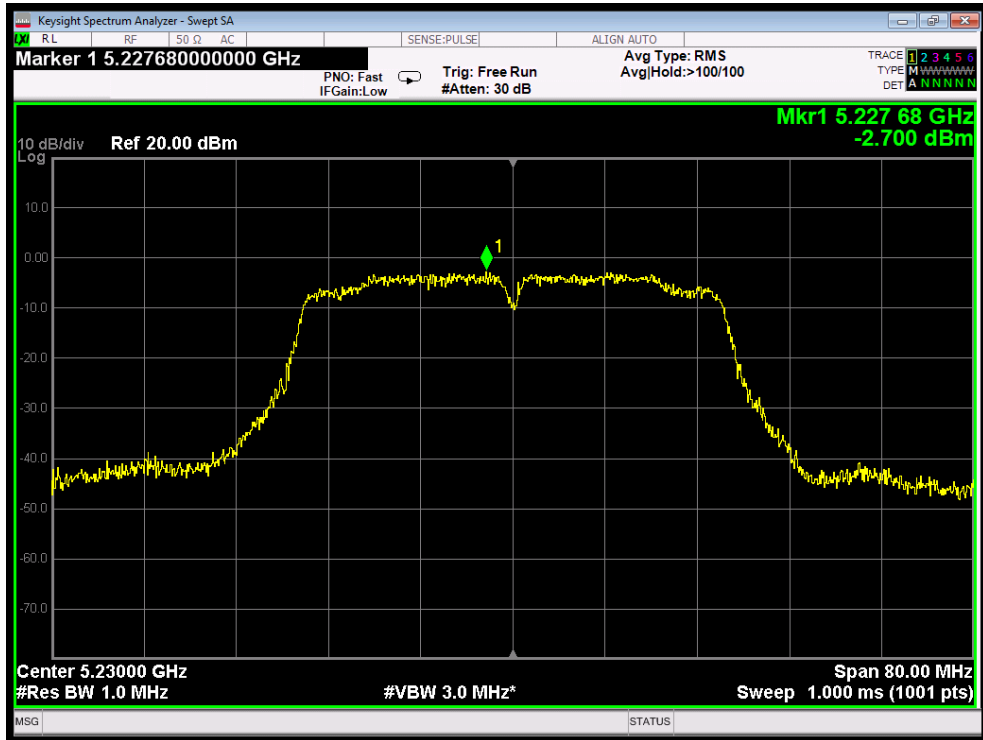

Test Mode: 802.11n40---High

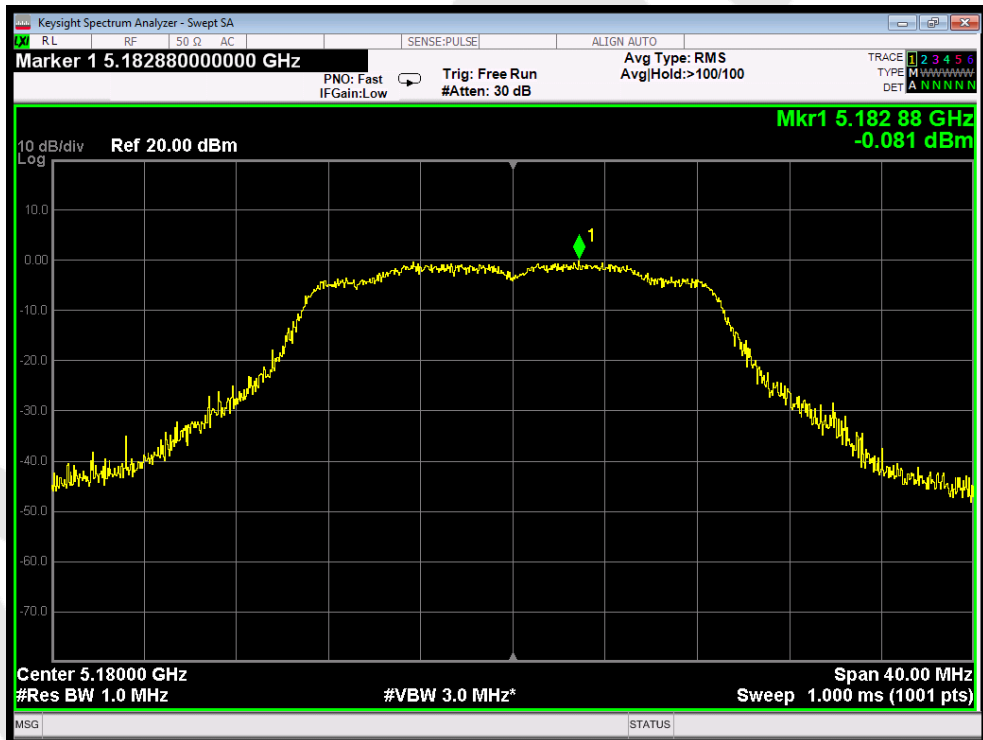

Test Mode: 802.11ac20--Low

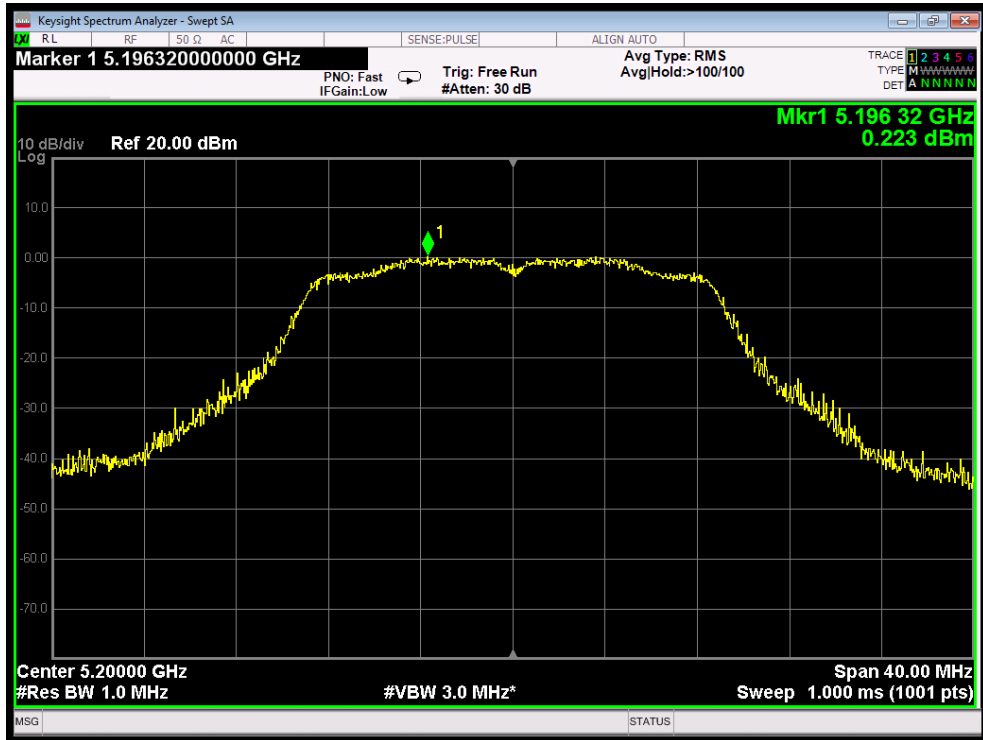

Test Mode: 802.11ac20---Middle

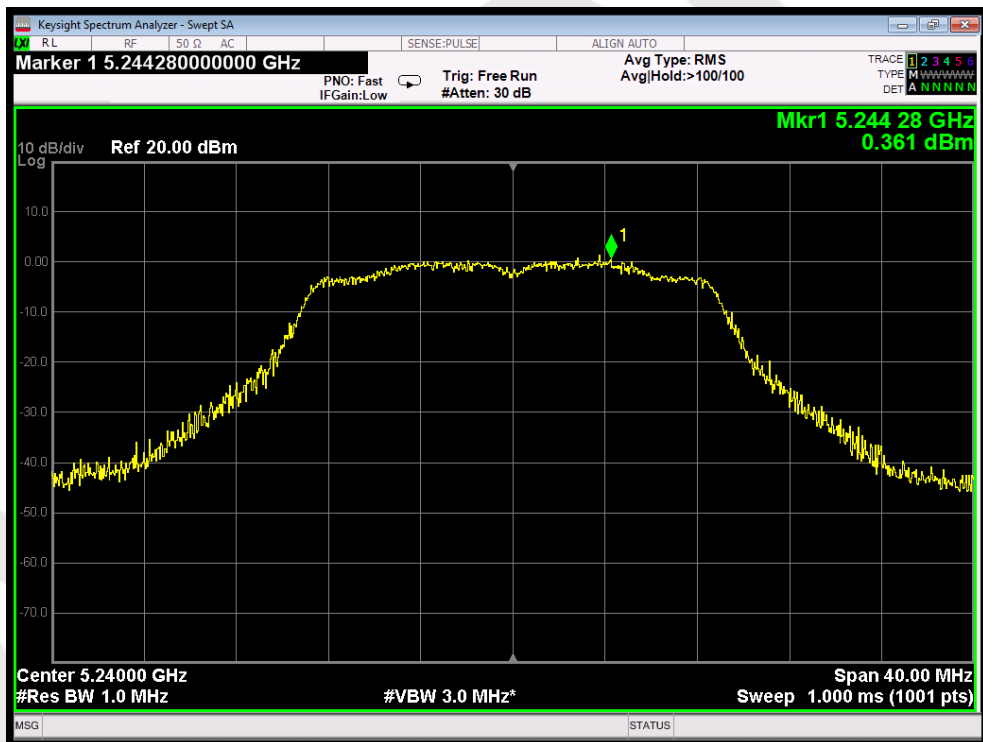

Test Mode: 802.11ac20---High

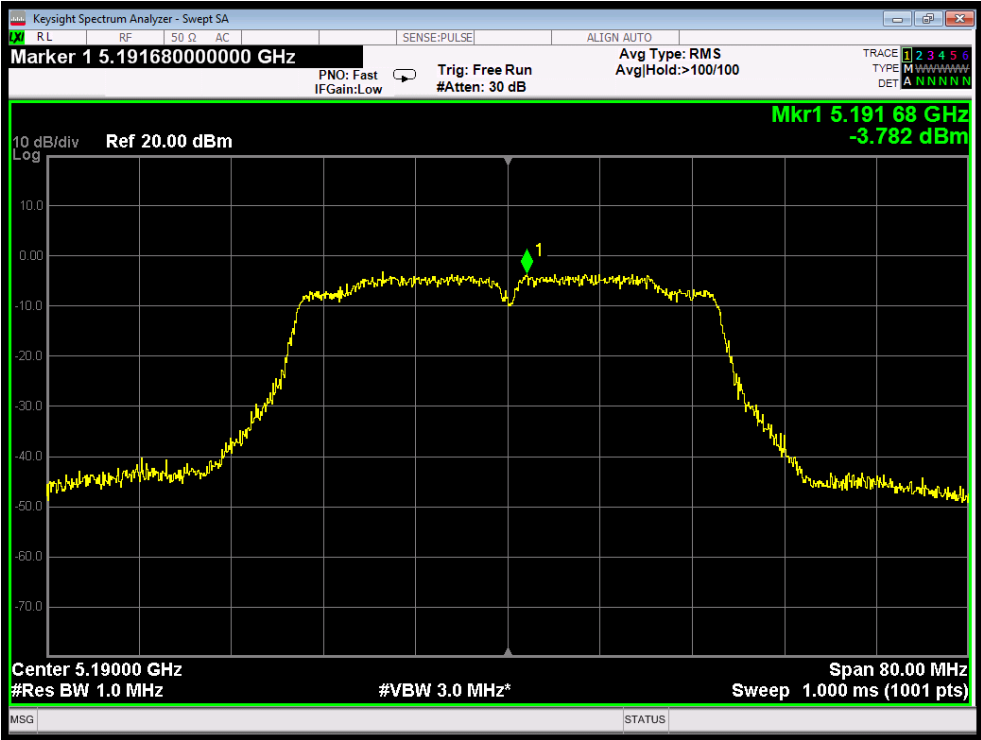

Test Mode: 802.11ac40---Low

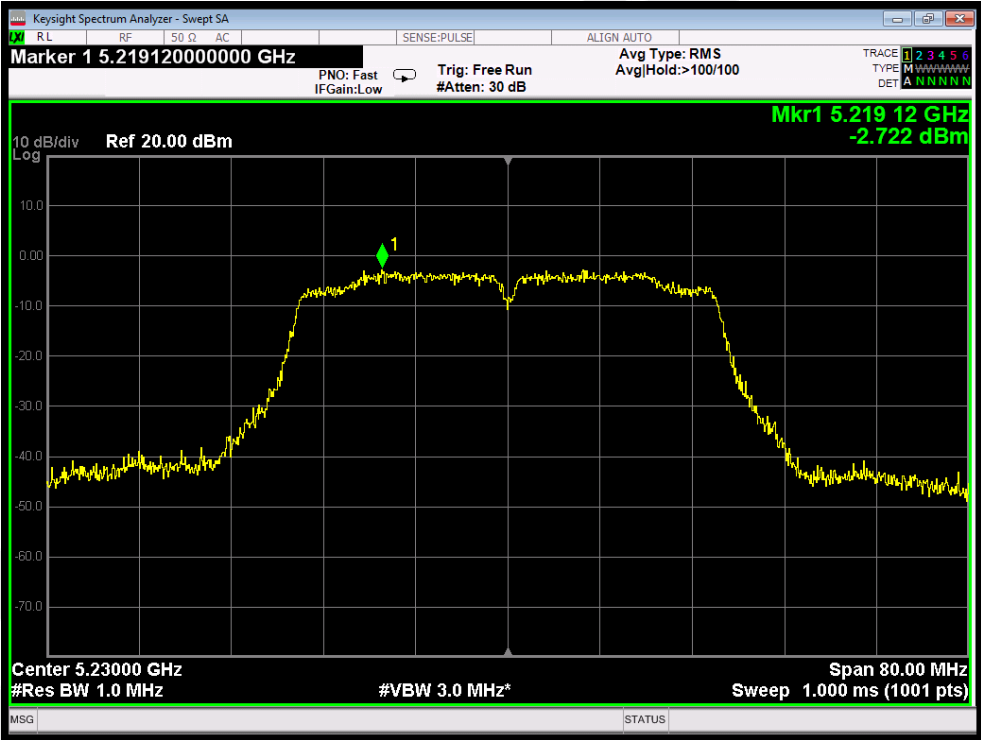

Test Mode: 802.11ac40---High

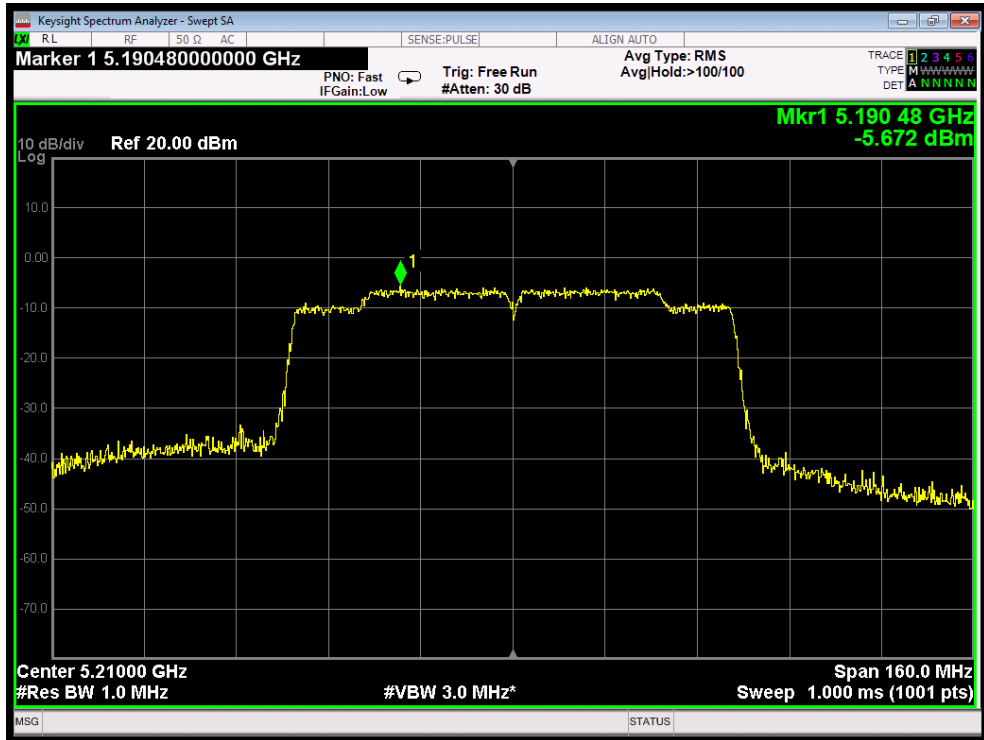

Test Mode: 802.11ac80

8. Antenna Requirement

8.1. Test Standard and Requirement

Test Standard	FCC Part15 Section 15.203 /15.407
Requirement	<p>1) 15.203 requirement: An intentional radiator shall be designed to ensure that no antenna other than that furnished by the responsible party shall be used with the device. The use of a permanently attached antenna or of an antenna that uses a unique coupling to the intentional radiator, the manufacturer may design the unit so that a broken antenna can be replaced by the user, but the use of a standard antenna jack or electrical connector is prohibited.</p> <p>2) 15.407 requirement: An intentional radiator shall be designed to ensure that no antenna other than that furnished by the responsible party shall be used with the device. The use of a permanently attached antenna or of an antenna that uses a unique coupling to the intentional radiator shall be considered sufficient to comply with the provisions of this section. The manufacturer may design the unit so that a broken antenna can be replaced by the user, but the use of a standard antenna jack or electrical connector is prohibited. This requirement does not apply to carrier current devices or to devices operated under the provisions of §15.211, §15.213, §15.217, §15.219, or §15.221. Further, this requirement does not apply to intentional radiators that must be professionally installed, such as perimeter protection systems and some field disturbance sensors, or to other intentional radiators which, in accordance with §15.31(d), must be measured at the installation site. However, the installer shall be responsible for ensuring that the proper antenna is employed so that the limits in this part are not exceeded.</p>

8.2. Antenna Connected Construction

The WIFI antenna is a PIFA Antenna which permanently attached, and the best case gain of the antenna is 3 dBi. It complies with the standard requirement.

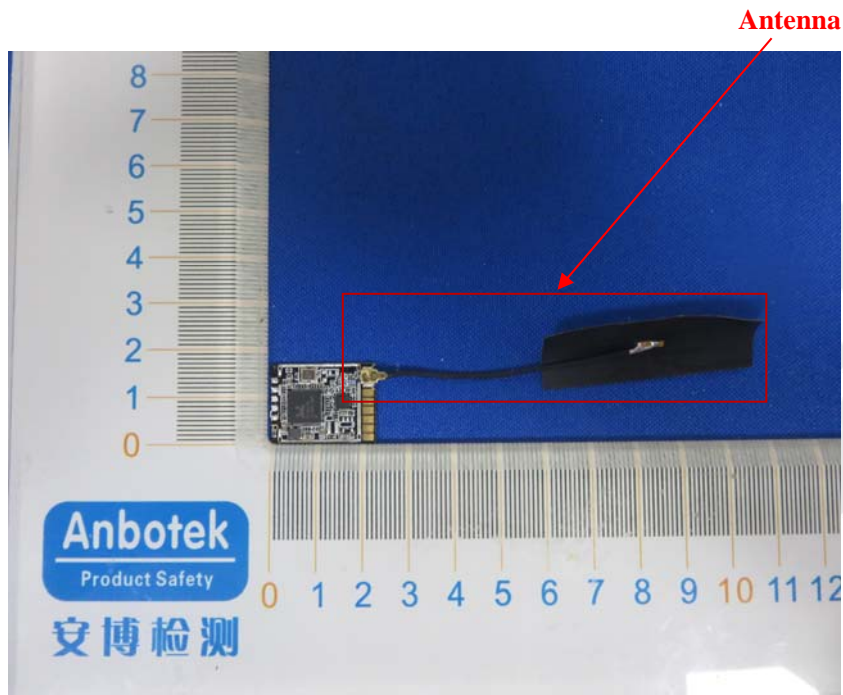

APPENDIX I -- TEST SETUP PHOTOGRAPH

Photo of Conducted Emission Measurement



Photo of Radiation Emission Test

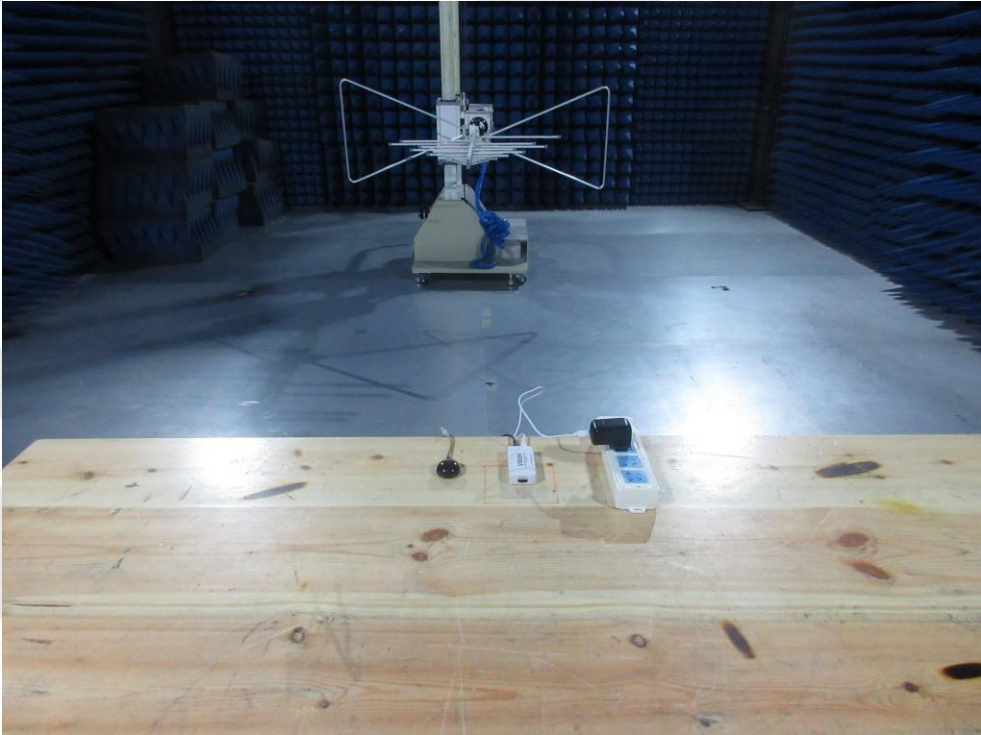

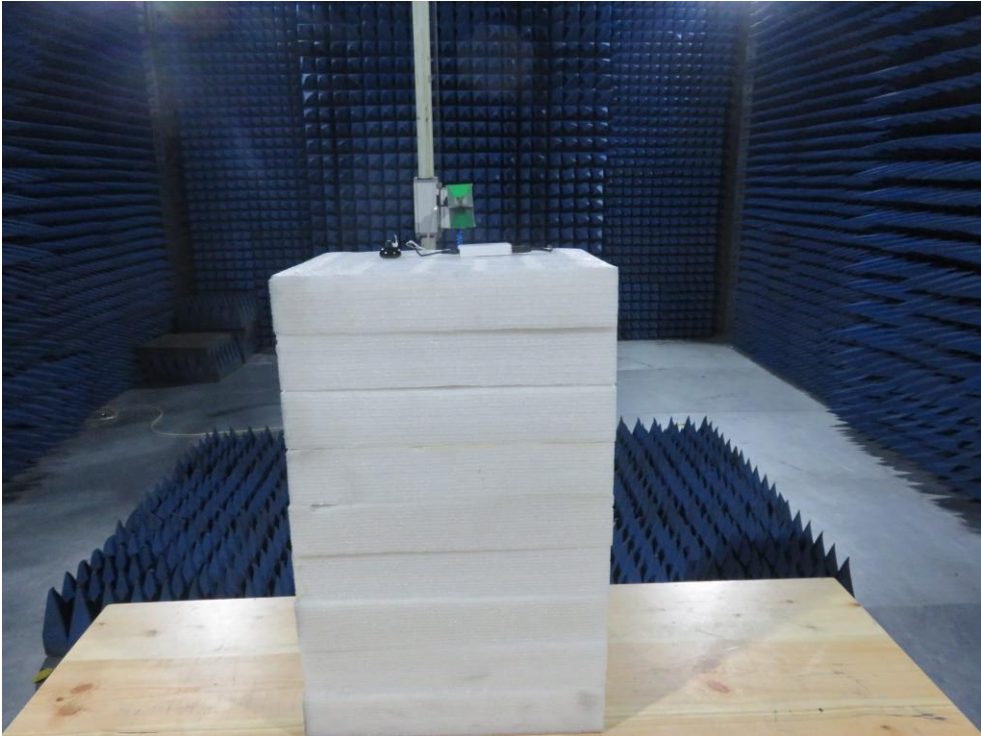

Anbotek

APPENDIX II -- EXTERNAL PHOTOGRAPH



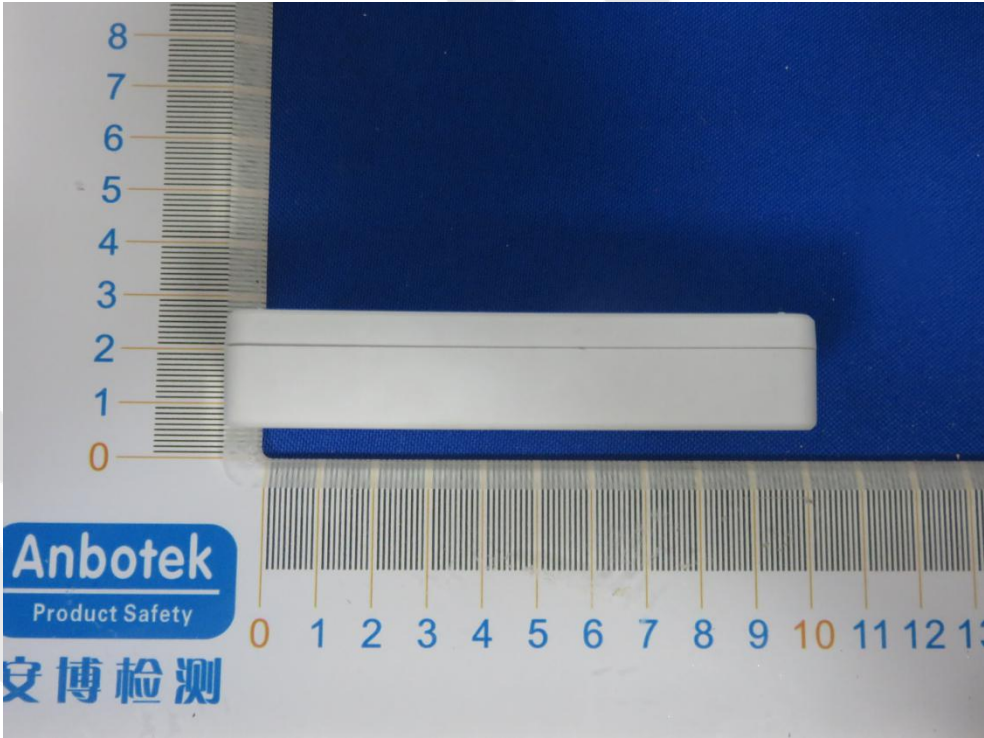
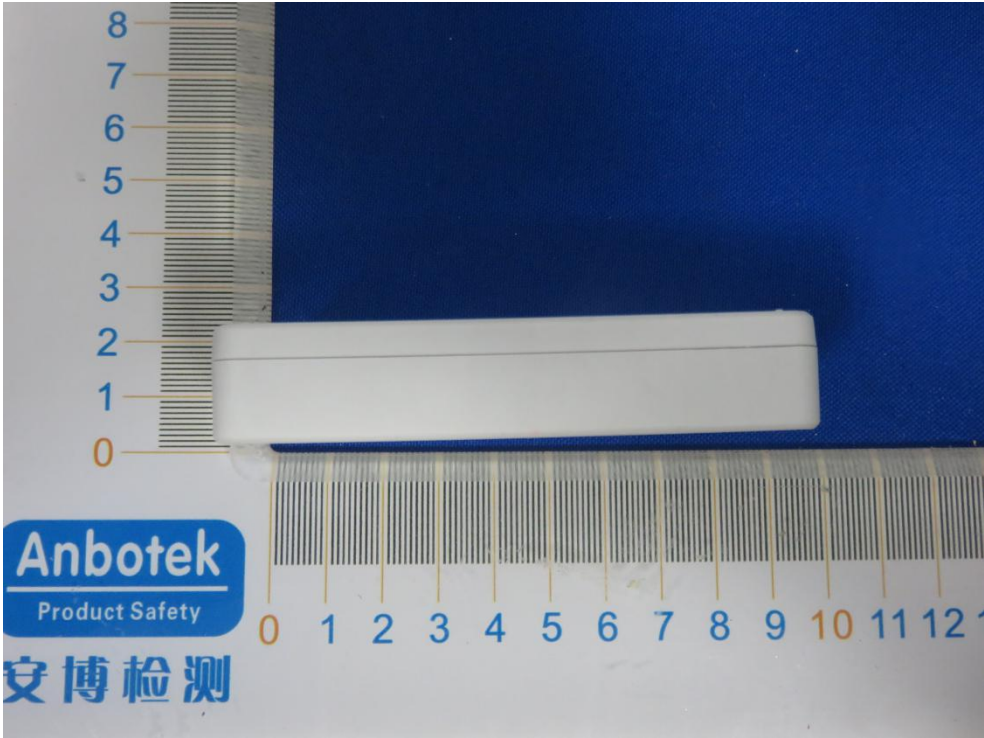



APPENDIX III -- INTERNAL PHOTOGRAPH

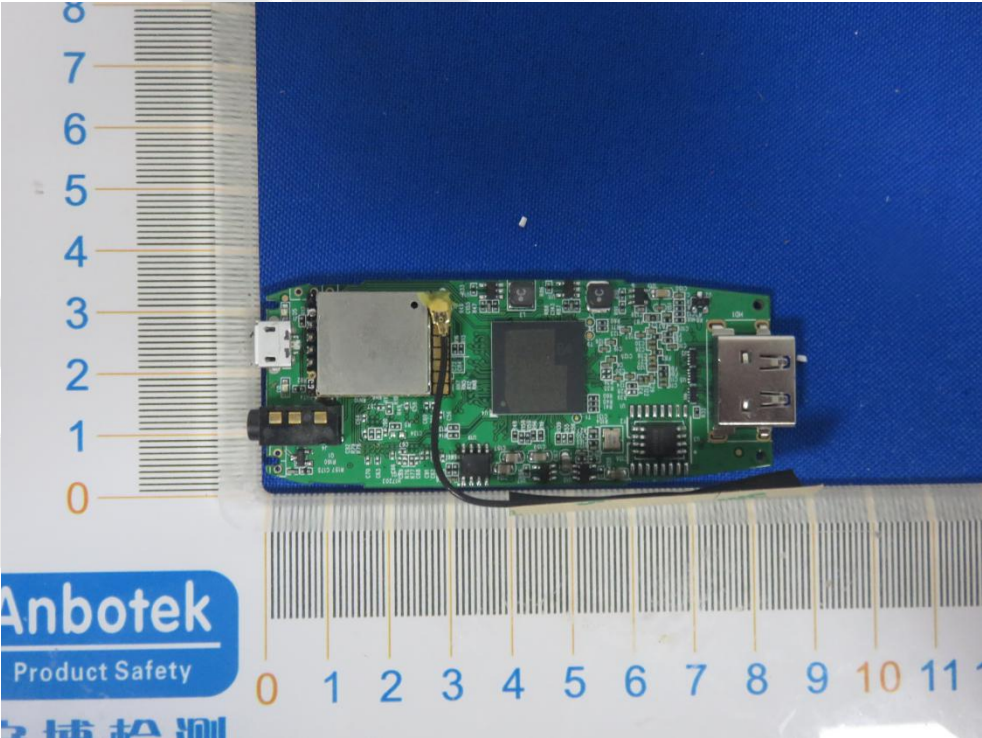

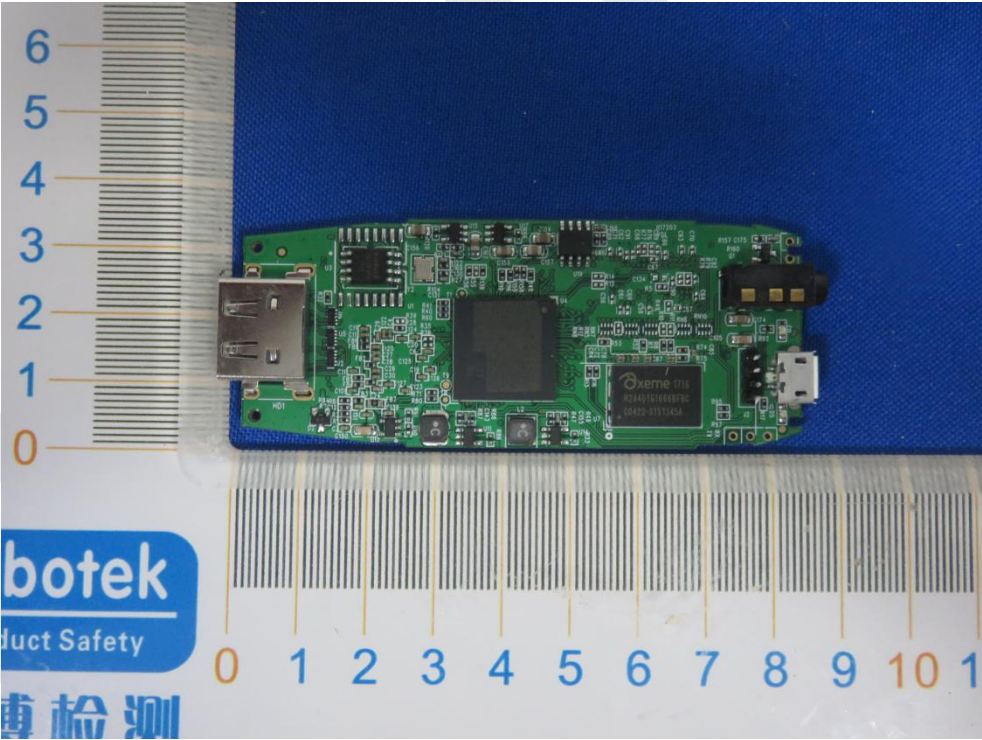
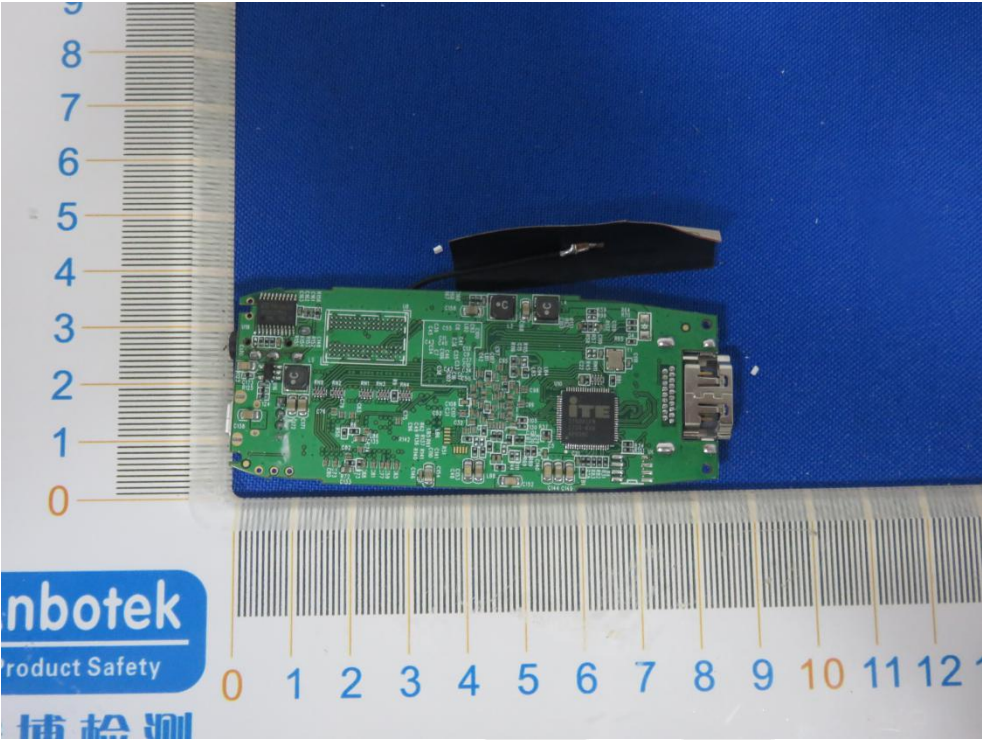

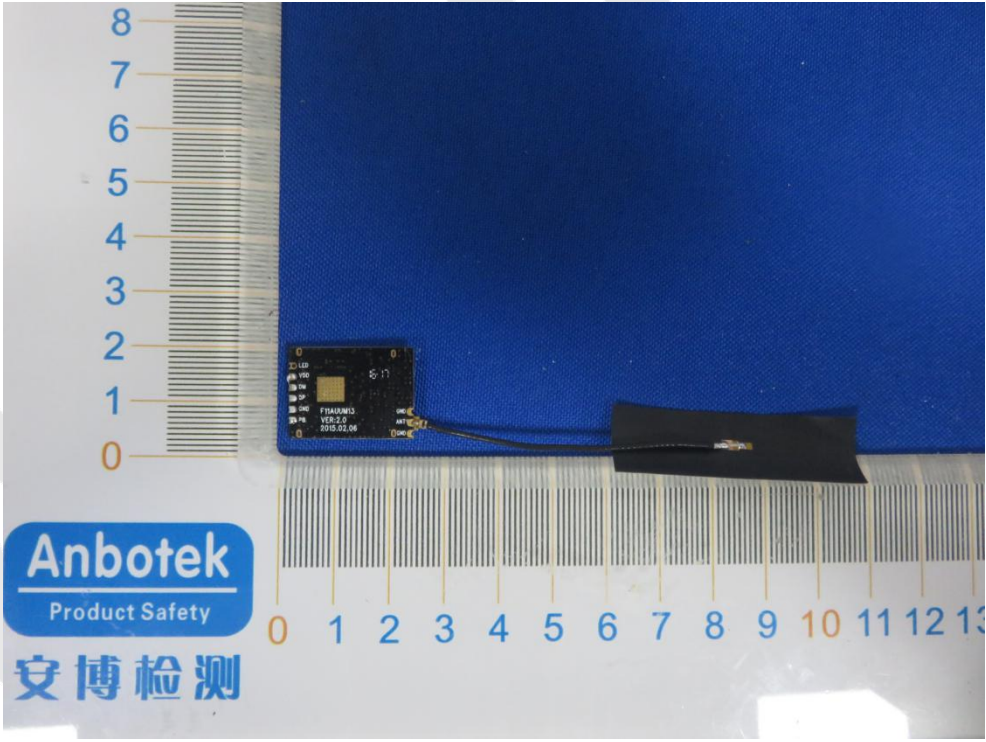
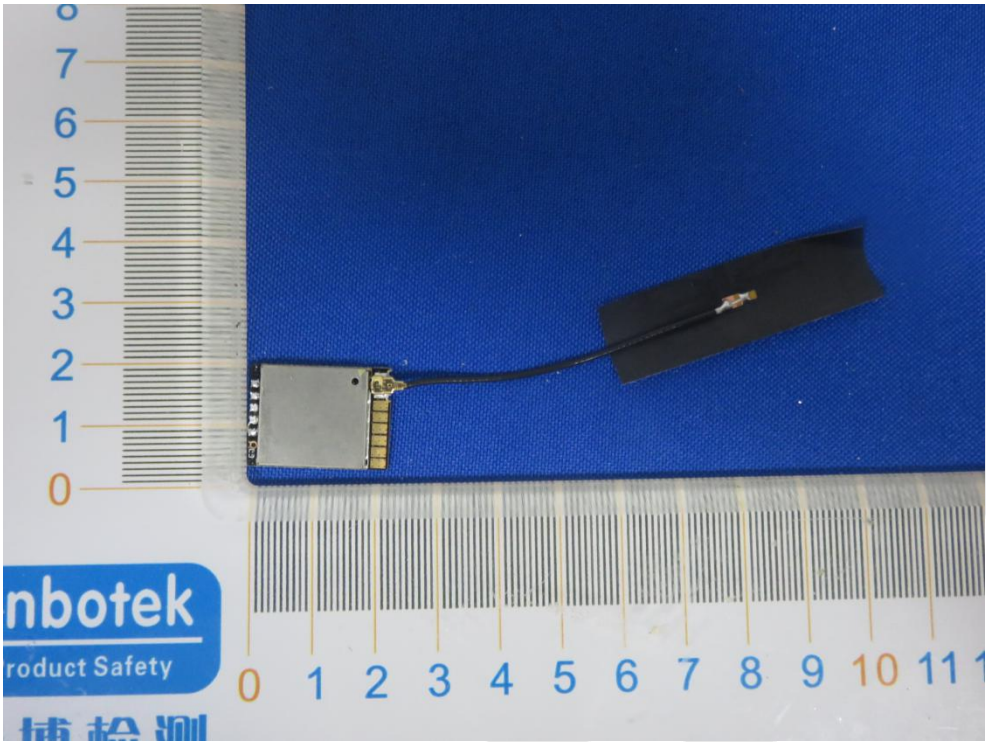

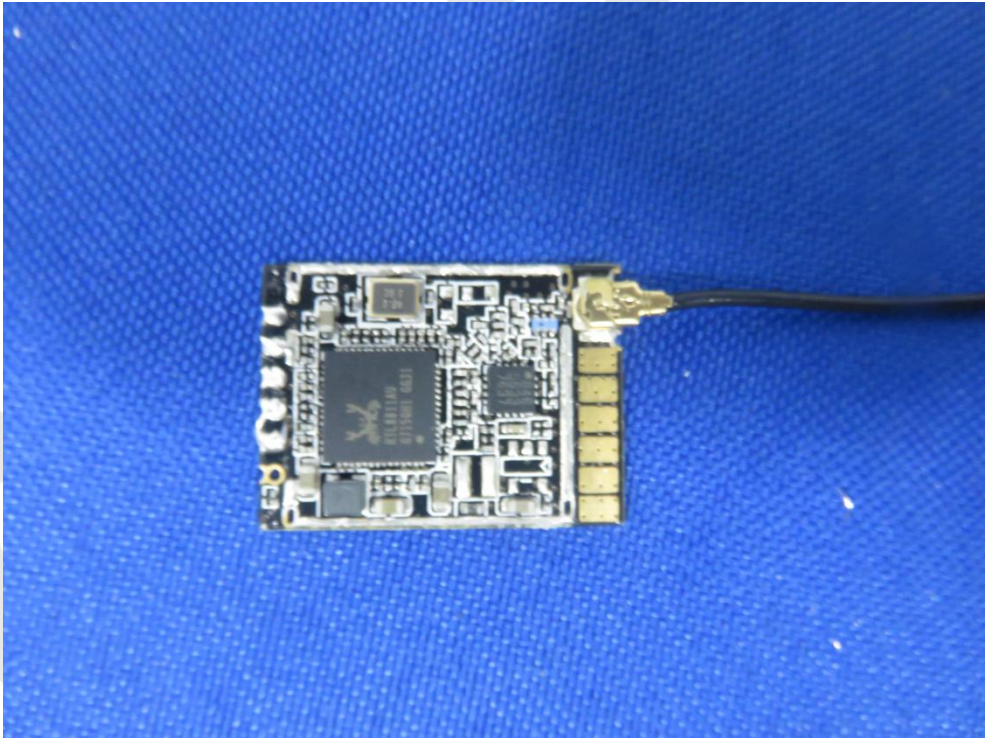
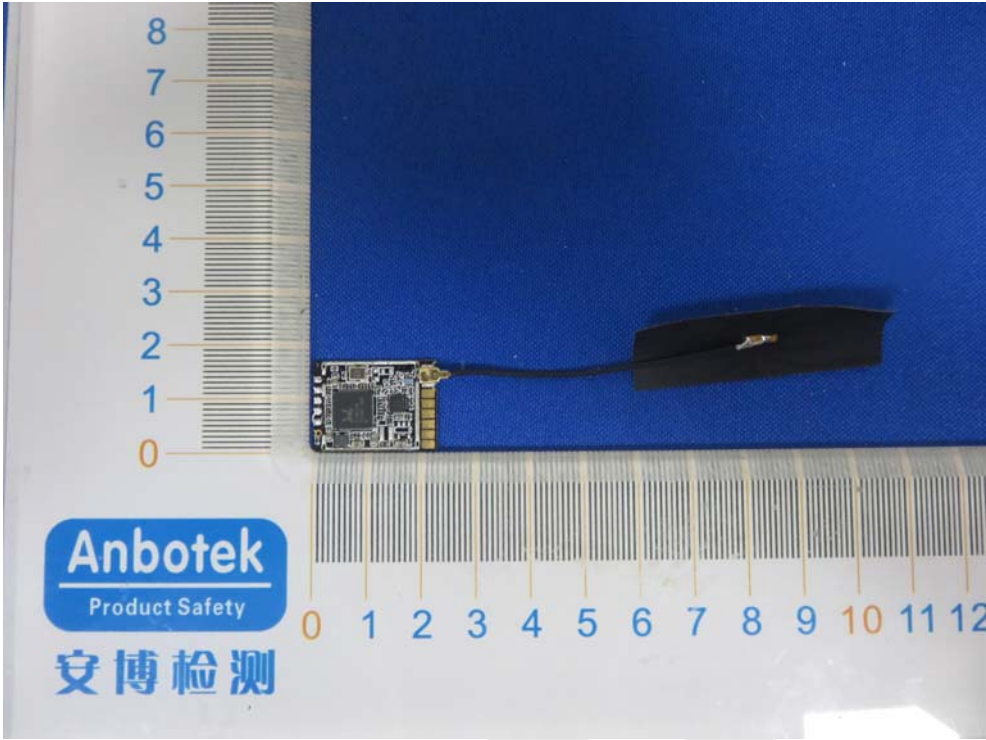

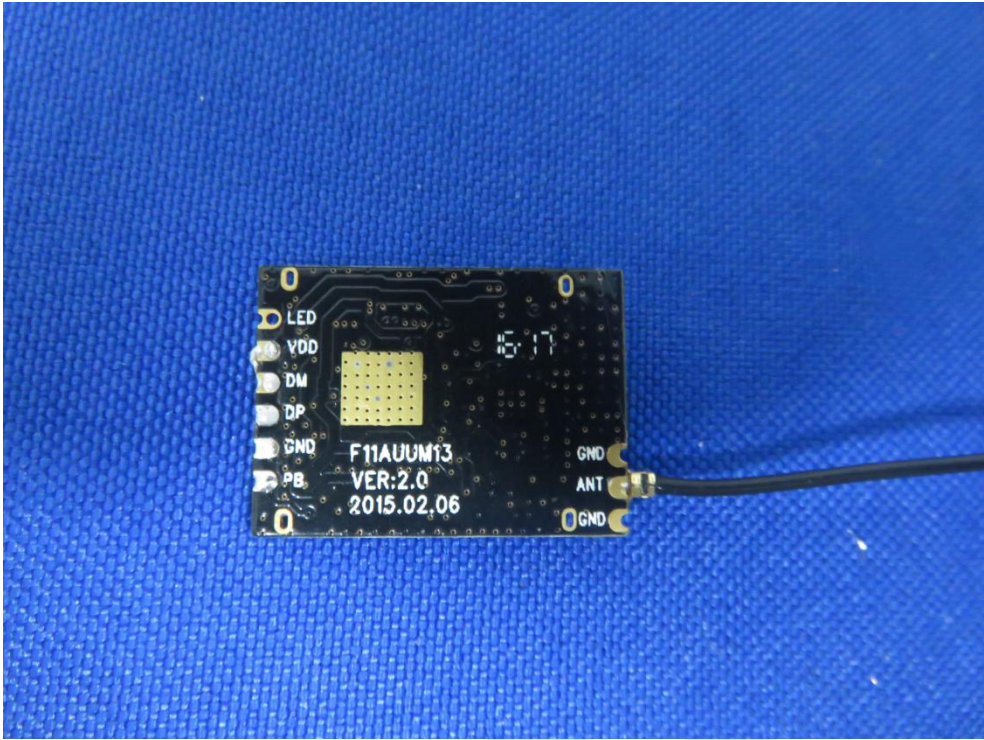

End of Report