

FCC TEST REPORT

For

Azlan Logistics Limited

HDMI Wireless Extender

Model No.: TC-HDMIW30

Prepared For : Azlan Logistics Limited
Address : Redwood 2, Chineham Business Park, Crockford Lane, Basingstoke,
Hampshire, RG24 8WQ United Kingdom

Prepared By : Shenzhen Anbotek Compliance Laboratory Limited
Address : 1/F, Building D, Sogood Science and Technology Park, Sanwei
community, Hangcheng Street, Bao'an District, Shenzhen, Guangdong,
China.518102
Tel: (86) 755-26066365 Fax: (86) 755-26014772

Report Number : R0217110130W2
Date of Test : Dec. 07, 2017~Mar. 30, 2018
Date of Report : Mar. 30, 2018

Contents

1. General Information.....	4
1.1. Client Information.....	4
1.2. Description of Device (EUT).....	4
1.3. Auxiliary Equipment Used During Test.....	5
1.4. Description of Test Modes.....	5
1.5. List of channels.....	6
1.6. Description Of Test Setup.....	7
1.7. Test Equipment List.....	8
1.8. Measurement Uncertainty.....	9
1.9. Description of Test Facility.....	9
2. Summary of Test Results.....	10
3. Conducted Emission Test.....	11
3.1. Test Standard and Limit.....	11
3.2. Test Setup.....	11
3.3. Test Procedure.....	11
3.4. Test Data.....	11
4. Radiation Spurious Emission and Band Edge.....	16
4.1. Test Standard and Limit.....	16
4.2. Test Setup.....	17
4.3. Test Procedure.....	18
4.4. Test Data.....	19
5. Maximum Peak Output Power Test.....	36
5.1. Test Standard and Limit.....	36
5.2. Test Setup.....	36
5.3. Test Procedure.....	36
5.4. Test Data.....	36
6. Occupy Bandwidth Test.....	38
6.1. Test Standard.....	38
6.2. Test Setup.....	38
6.3. Test Procedure.....	38
6.4. Test Data.....	38
7. Power Spectral Density Test.....	52
7.1. Test Standard and Limit.....	52
7.2. Test Setup.....	52
7.3. Test Procedure.....	52
7.4. Test Data.....	52
8. Antenna Requirement.....	60
8.1. Test Standard and Requirement.....	60
8.2. Antenna Connected Construction.....	61
APPENDIX I -- TEST SETUP PHOTOGRAPH.....	62
APPENDIX II -- EXTERNAL PHOTOGRAPH.....	63
APPENDIX III -- INTERNAL PHOTOGRAPH.....	64

TEST REPORT

Applicant : Azlan Logistics Limited
Manufacturer : Azlan Logistics Limited
Product Name : HDMI Wireless Extender
Model No. : TC-HDMIW30
Trade Mark : VISION
Rating(s) : Input: DC 5V

Test Standard(s) : FCC Part15 Subpart E 2017, Paragraph 15.407
ANSI C63.10: 2013
Test Method(s) : KDB 789033 D02 General UNII Test Procedures New Rules v02r01

The device described above is tested by Shenzhen Anbotek Compliance Laboratory Limited to determine the maximum emission levels emanating from the device and the severe levels of the device can endure and its performance criterion. The measurement results are contained in this test report and Shenzhen Anbotek Compliance Laboratory Limited is assumed full of responsibility for the accuracy and completeness of these measurements. Also, this report shows that the EUT (Equipment Under Test) is technically compliant with the FCC Part 15 Subpart E requirements.

This report applies to above tested sample only and shall not be reproduced in part without written approval of Shenzhen Anbotek Compliance Laboratory Limited.

Date of Test : Dec. 07, 2017~Mar. 30, 2018

Prepared by :



Winkey Wang

(Tested Engineer / Winkey Wang)

Reviewer :

Tangcy. T.

(Project Manager / Tangcy. T)

Approved & Authorized Signer :

Tom Chen

(Manager / Tom Chen)

1. General Information

1.1. Client Information

Applicant	:	Azlan Logistics Limited
Address	:	Redwood 2, Chineham Business Park, Crockford Lane, Basingstoke, Hampshire, RG24 8WQ United Kingdom
Manufacturer	:	Azlan Logistics Limited
Address	:	Redwood 2, Chineham Business Park, Crockford Lane, Basingstoke, Hampshire, RG24 8WQ United Kingdom

1.2. Description of Device (EUT)

Product Name	:	HDMI Wireless Extender	
Model No.	:	TC-HDMIW30	
Trade Mark	:	VISION	
Test Power Supply	:	AC 120V, 60Hz for adapter/AC 240V, 60Hz for adapter DC 5V USB Port	
Product Description	:	Operation Frequency:	WIFI 5.8G: 5745MHz~5825MHz
	:	Number of Channel:	WIFI 5G: 5 Channels for 802.11n(HT20) 5 Channels for 802.11ac(HT20) 2 Channels for 802.11n(HT40) 2 Channels for 802.11ac(HT40) 1 Channels for 802.11ac(HT80)
	:	Modulation Type:	OFDM with BPSK/QPSK/16QAM/64QAM for 802.11n; OFDM with BPSK/QPSK/16QAM/64QAM/256QAM for 802.11ac
	:	Antenna Type:	PIFA Antenna
	:	Antenna Gain(Peak):	3 dBi
<p>Remark: 1) For a more detailed features description, please refer to the manufacturer's specifications or the User's Manual. 2) This report is for WIFI 5.8G.</p>			

1.3. Auxiliary Equipment Used During Test

TV	:	Manufacturer: SONY
		M/N: KDL-26EX550 S/N: 1012240 CE , FCC: DOC
Notebook	:	Manufacturer: LIFE BOOK Model: LH531 CE, FCC DOC
Adapter	:	M/N: MX15Z-0502000YU Input: 100-240V~50/60Hz 0.4A Output: DC 5V USB Port, 2A
HDMI Wireless Extender		Manufacturer: Azlan Logistics Limited M/N: TC-HDMIW30

1.4. Description of Test Modes

To investigate the maximum EMI emission characteristics generates from EUT, the test system was pre-scanning tested base on the consideration of following EUT operation mode or test configuration mode which possible have effect on EMI emission level. Each of these EUT operation mode(s) or test configuration mode(s) mentioned above was evaluated respectively.

Mode	Test channel	Frequency (MHz)
OFDM(802.11n20/ac20)	CH 149	5745MHz
	CH 157	5785MHz
	CH 165	5825MHz
OFDM(802.11n40/ac40)	CH 151	5755MHz
	CH159	5795MHz
OFDM(802.11ac80)	CH 155	5775MHz

Note:

1. The measurements are performed at the highest, middle, lowest available channels.
2. The EUT has been tested as an independent unit. And Continual Transmitting in maximum power.
3. For the relevant Conducted Measurement, the temporary antenna connector is used during the measurement. Antenna Connector Impedance: 50 Ω , Cable Loss: 1.0 dB
4. The EUT was programmed to be in continuously transmitting mode and the transmit duty cycle is more than 98%

1.5. List of channels

802.11n20/ac20

Channel	Freq. (MHz)	Channel	Freq. (MHz)
149	5745	153	5765
157	5785	161	5805
165	5825		

802.11n40/ac40

Channel	Freq. (MHz)	Channel	Freq. (MHz)
151	5755	159	5795

802.11ac80

Channel	Freq. (MHz)
155	5775

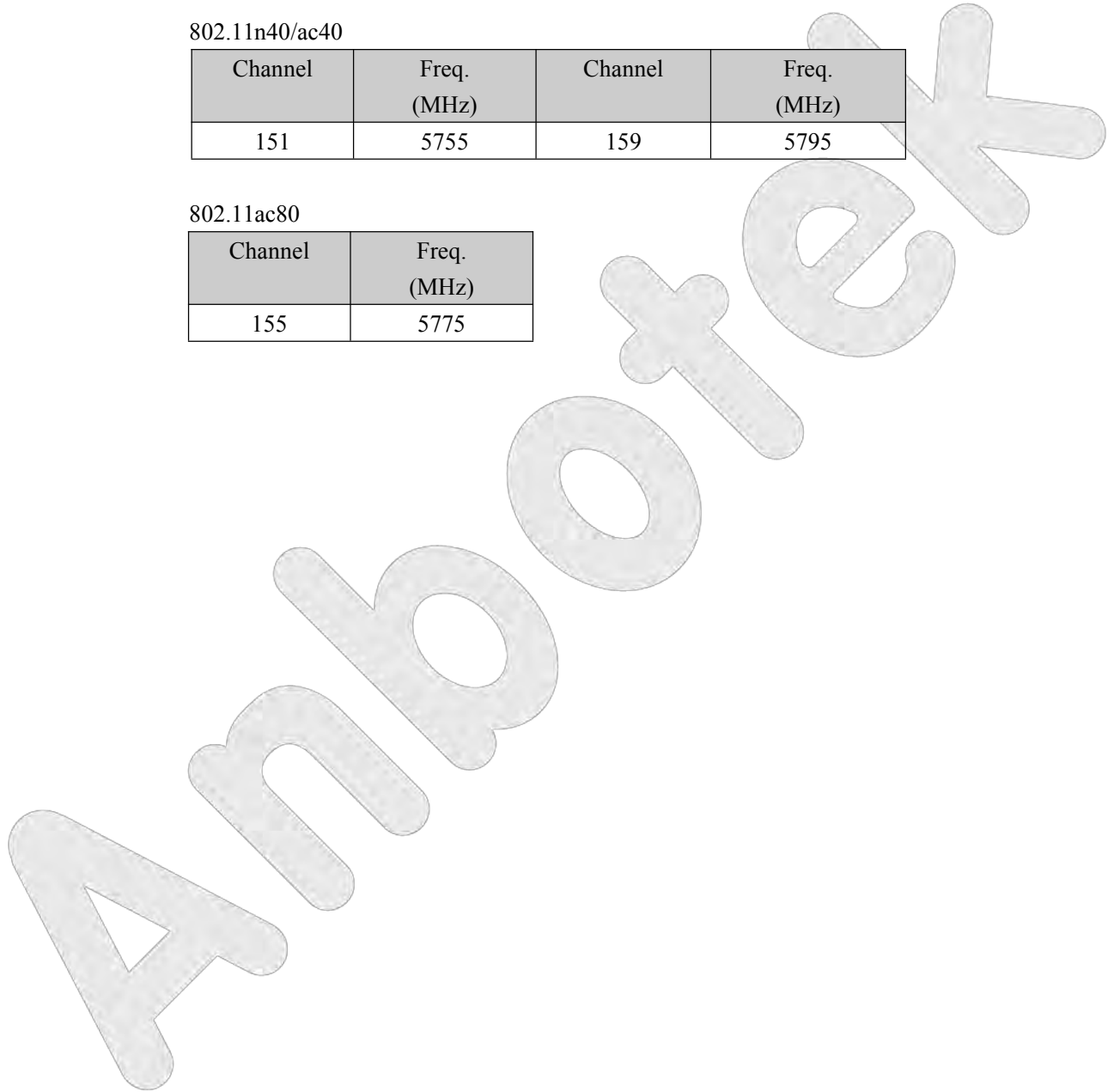

1.6. Description Of Test Setup

CE

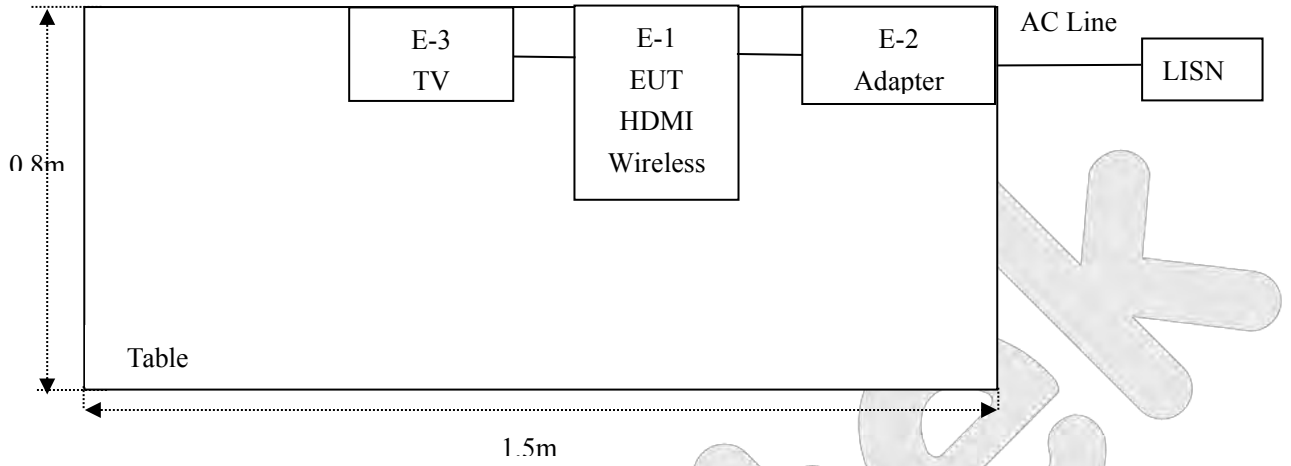

RE

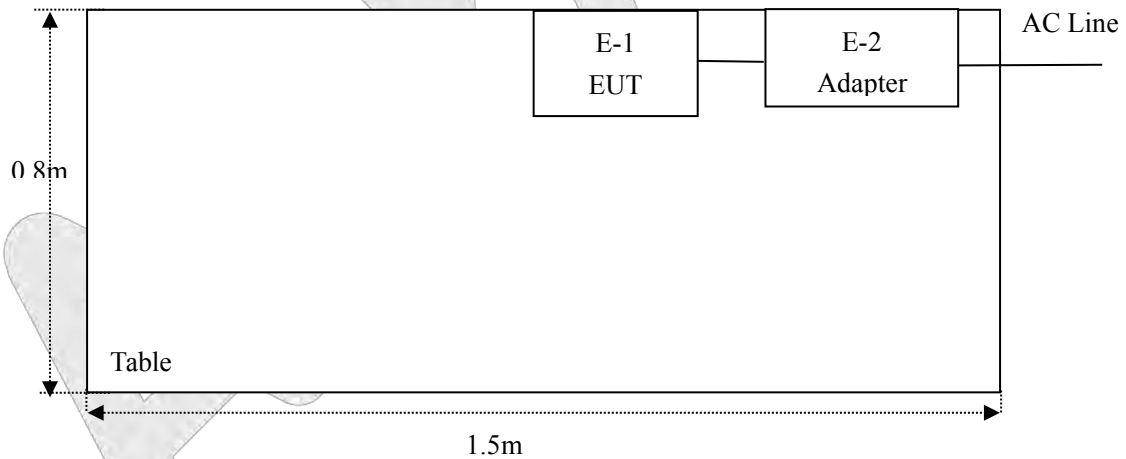

1.7. Test Equipment List

Item	Equipment	Manufacturer	Model No.	Serial No.	Last Cal.	Cal. Interval
1.	L.I.S.N. Artificial Mains Network	Rohde & Schwarz	ENV216	100055	Nov. 17, 2017	1 Year
2.	EMI Test Receiver	Rohde & Schwarz	ESCI	100627	Nov. 17, 2017	1 Year
3.	RF Switching Unit	Compliance Direction	RSU-M2	38303	Nov. 17, 2017	1 Year
4.	Spectrum Analysis	Agilent	E4407B	US39390582	Nov. 17, 2017	1 Year
5.	Spectrum Analysis	Agilent	N9038A	MY53227295	Nov. 17, 2017	1 Year
6.	Preamplifier	SKET Electronic	BK1G18G30 D	KD17503	Nov. 17, 2017	1 Year
7.	EMI Test Receiver	Rohde & Schwarz	ESPI	101604	Nov. 17, 2017	1 Year
8.	Double Ridged Horn Antenna	Instruments corporation	GTH-0118	351600	Nov. 20, 2017	1 Year
9.	Bilog Broadband Antenna	Schwarzbeck	VULB9163	VULB 9163-289	Nov. 20, 2017	1 Year
10.	Loop Antenna	Schwarzbeck	HFH2-Z2	100047	Nov. 17, 2017	1 Year
11.	Horn Antenna	Schwarzbeck	BBHA9170	9170-375	Nov. 17, 2017	1 Year
12.	Pre-amplifier	SONOMA	310N	186860	Nov. 17, 2017	1 Year
13.	EMI Test Software EZ-EMC	SHURPLE	N/A	N/A	N/A	N/A
14.	RF Test Control System	YIHENG	YH3000	2017430	Nov. 18, 2017	1 Year
15.	Power Sensor	DAER	RPR3006W	15I00041SN045	Nov. 17, 2017	1 Year
16.	Power Sensor	DAER	RPR3006W	15I00041SN046	Nov. 17, 2017	1 Year
17.	MXA Spectrum Analysis	Agilent	N9020A	MY51170037	Nov. 18, 2017	1 Year
18.	MXG RF Vector Signal Generator	Agilent	N5182A	MY48180656	Nov. 18, 2017	1 Year
19.	Signal Generator	Agilent	E4421B	MY41000743	Nov. 18, 2017	1 Year
20.	DC Power Supply	LW	TPR-6410D	349315	Nov. 01, 2017	1 Year
21.	Constant Temperature Humidity Chamber	Sertep	ZJ-HWHS80 B	ZJ-17042804	Nov. 01, 2017	1 Year

1.8. Measurement Uncertainty

Radiation Uncertainty	:	Ur = 4.1 dB (Horizontal)
		Ur = 4.3 dB (Vertical)
Conduction Uncertainty	:	Uc = 3.4dB

1.9. Description of Test Facility

The test facility is recognized, certified, or accredited by the following organizations:

FCC-Registration No.: 184111

Shenzhen Anbotek Compliance Laboratory Limited, EMC Laboratory has been registered and fully described in a report filed with the (FCC) Federal Communications Commission. The acceptance letter from the FCC is maintained in our files. Registration No. 184111, July 31, 2017.

ISED-Registration No.: 8058A-1

Shenzhen Anbotek Compliance Laboratory Limited, EMC Laboratory has been registered and fully described in a report filed with the (ISED) Innovation, Science and Economic Development Canada. The acceptance letter from the ISED is maintained in our files. Registration 8058A-1, June 13, 2016.

Test Location

All Emissions tests were performed at Shenzhen Anbotek Compliance Laboratory Limited. at 1/F, Building D, Sogood Science and Technology Park, Sanwei community, Hangcheng Street, Bao'an District, Shenzhen, Guangdong, China.518102

2. Summary of Test Results

Standard	Test Type	Result
15.207 & 15.407	Conducted Emission	PASS
15.205/15.209	Spurious Emission	PASS
15.407(b)	Band Edge	PASS
15.407(a)(5)	Occupy Bandwidth	PASS
15.407(a)(1)(3)	Maximum Conducted Output Power	PASS
15.407(a)(1)(3)	Peak Power Spectral Density	PASS
15.203/15.407g	Antenna Requirement	PASS

Anbotek

3. Conducted Emission Test

3.1. Test Standard and Limit

Test Standard	FCC Part15 Section 15.207&15.407		
Test Limit	Frequency	Maximum RF Line Voltage (dBuV)	
		Quasi-peak Level	Average Level
	150kHz~500kHz	66 ~ 56 *	56 ~ 46 *
	500kHz~5MHz	56	46
5MHz~30MHz	60	50	

Remark: (1) *Decreasing linearly with logarithm of the frequency.
(2) The lower limit shall apply at the transition frequency.

3.2. Test Setup

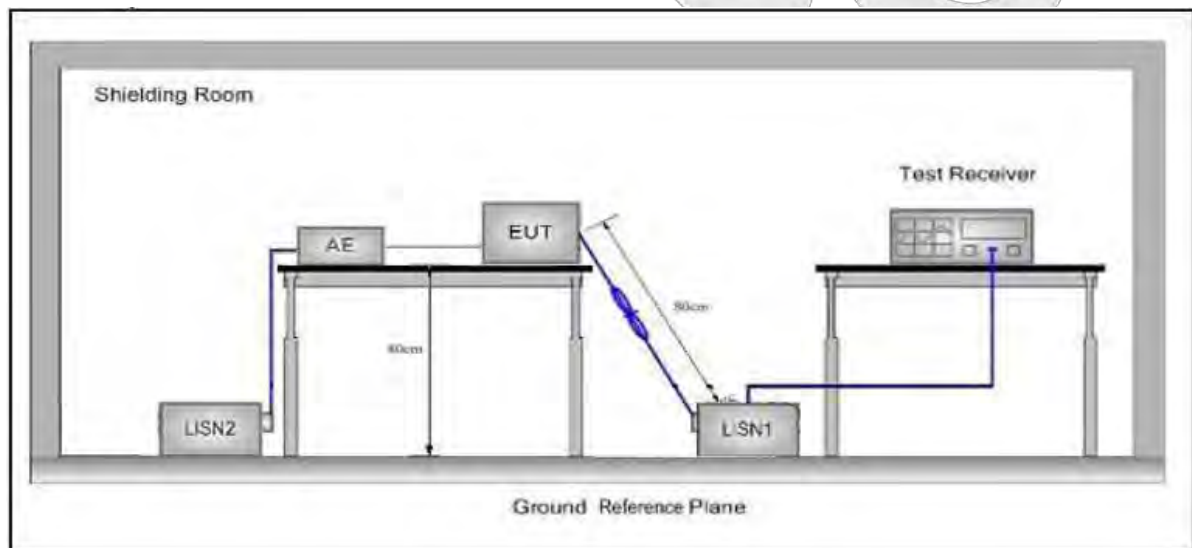

3.3. Test Procedure

The EUT system is connected to the power mains through a line impedance stabilization network (L.I.S.N.). This provides a 50ohm coupling impedance for the EUT system. Please refer the block diagram of the test setup and photographs. Both sides of AC line are checked to find out the maximum conducted emission. In order to find the maximum emission levels, the relative positions of equipment and all of the interface cables shall be changed according to FCC ANSI C63.10-2013 on Conducted Emission Measurement.

The bandwidth of test receiver (ESCI) set at 9kHz.

The frequency range from 150kHz to 30MHz is checked.

3.4. Test Data

Please to see the following pages

Conducted Emission Test Data

Test Site: 1# Shielded Room
 Operating Condition: TX+Charging mode
 Test Specification: AC 120V, 60Hz for adapter
 Comment: Live Line
 Tem.:22.3°C Hum.:57%

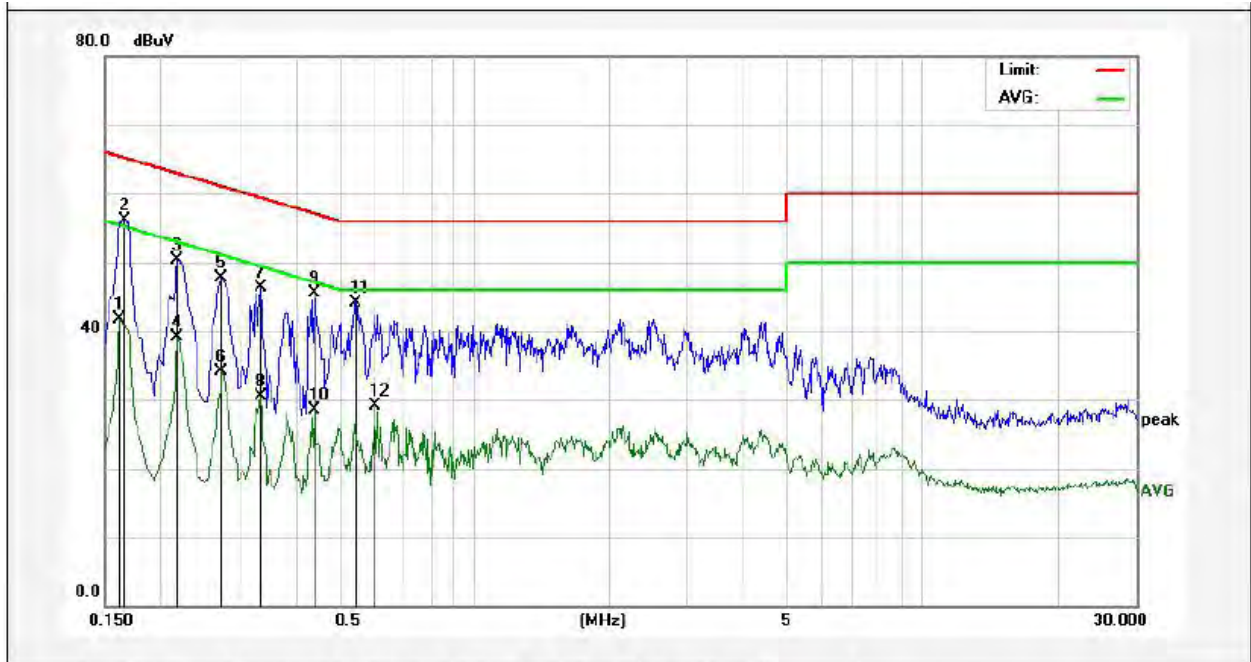

No.	Freq. (MHz)	Reading (dBuV)	Factor (dB)	Result (dBuV)	Limit dBuV	Over Limit (dB)	Detector	Remark
1	0.1620	21.73	19.90	41.63	55.36	-13.73	AVG	
2	0.1660	36.28	19.90	56.18	65.15	-8.97	QP	
3	0.2180	30.49	19.90	50.39	62.89	-12.50	QP	
4	0.2180	19.22	19.90	39.12	52.89	-13.77	AVG	
5	0.2740	27.91	19.89	47.80	60.99	-13.19	QP	
6	0.2740	14.20	19.89	34.09	50.99	-16.90	AVG	
7	0.3339	26.31	19.91	46.22	59.35	-13.13	QP	
8	0.3339	10.59	19.91	30.50	49.35	-18.85	AVG	
9	0.4420	25.61	19.95	45.56	57.02	-11.46	QP	
10	0.4420	8.60	19.95	28.55	47.02	-18.47	AVG	
11	0.5460	24.10	19.99	44.09	56.00	-11.91	QP	
12	0.6020	9.02	20.01	29.03	46.00	-16.97	AVG	

Conducted Emission Test Data

Test Site: 1# Shielded Room
 Operating Condition: TX+Charging mode
 Test Specification: AC 120V, 60Hz for adapter
 Comment: Neutral Line
 Tem.:22.3°C Hum.:57%

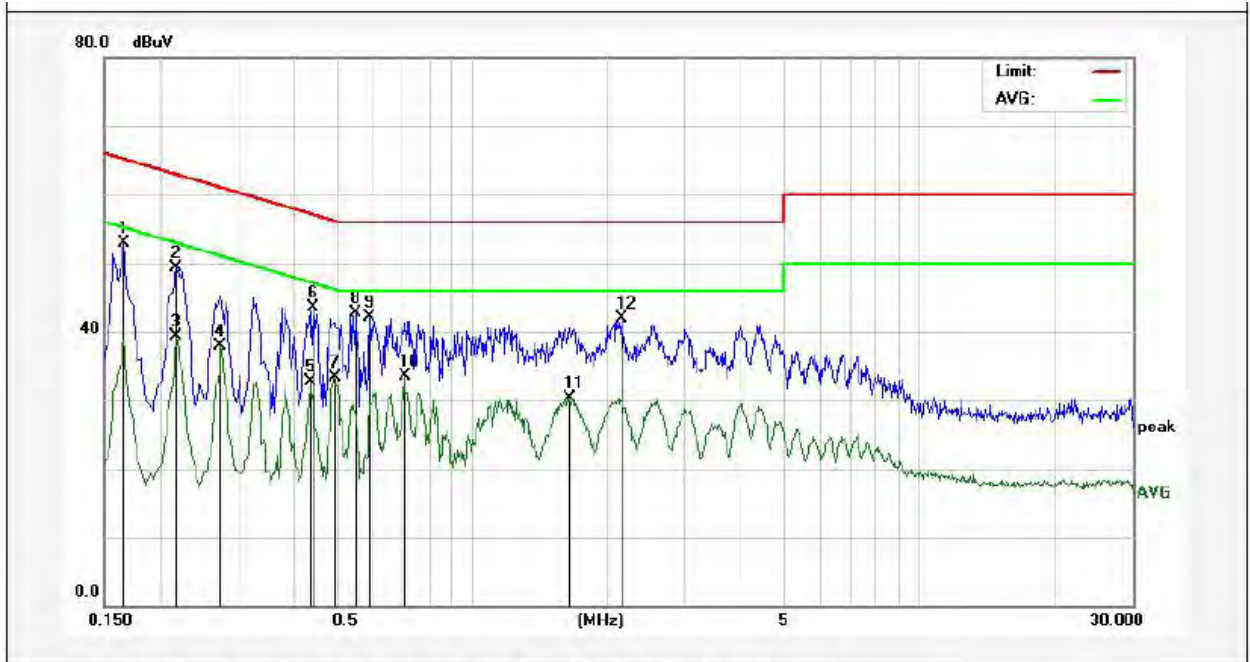

No.	Freq. (MHz)	Reading (dBuV)	Factor (dB)	Result (dBuV)	Limit (dBuV)	Over Limit (dB)	Detector	Remark
1	0.1660	33.04	19.90	52.94	65.15	-12.21	QP	
2	0.2180	29.39	19.90	49.29	62.89	-13.60	QP	
3	0.2180	19.36	19.90	39.26	52.89	-13.63	AVG	
4	0.2740	17.92	19.89	37.81	50.99	-13.18	AVG	
5	0.4340	12.70	19.95	32.65	47.18	-14.53	AVG	
6	0.4420	23.48	19.95	43.43	57.02	-13.59	QP	
7	0.4900	13.37	19.98	33.35	46.17	-12.82	AVG	
8	0.5500	22.75	19.99	42.74	56.00	-13.26	QP	
9	0.5899	22.08	20.01	42.09	56.00	-13.91	QP	
10	0.7060	13.54	20.04	33.58	46.00	-12.42	AVG	
11	1.6380	10.16	20.13	30.29	46.00	-15.71	AVG	
12	2.1580	21.83	20.14	41.97	56.00	-14.03	QP	

Conducted Emission Test Data

Test Site: 1# Shielded Room
 Operating Condition: TX+Charging mode
 Test Specification: AC 240V, 60Hz for adapter
 Comment: Live Line
 Tem.:22.3°C Hum.:57%

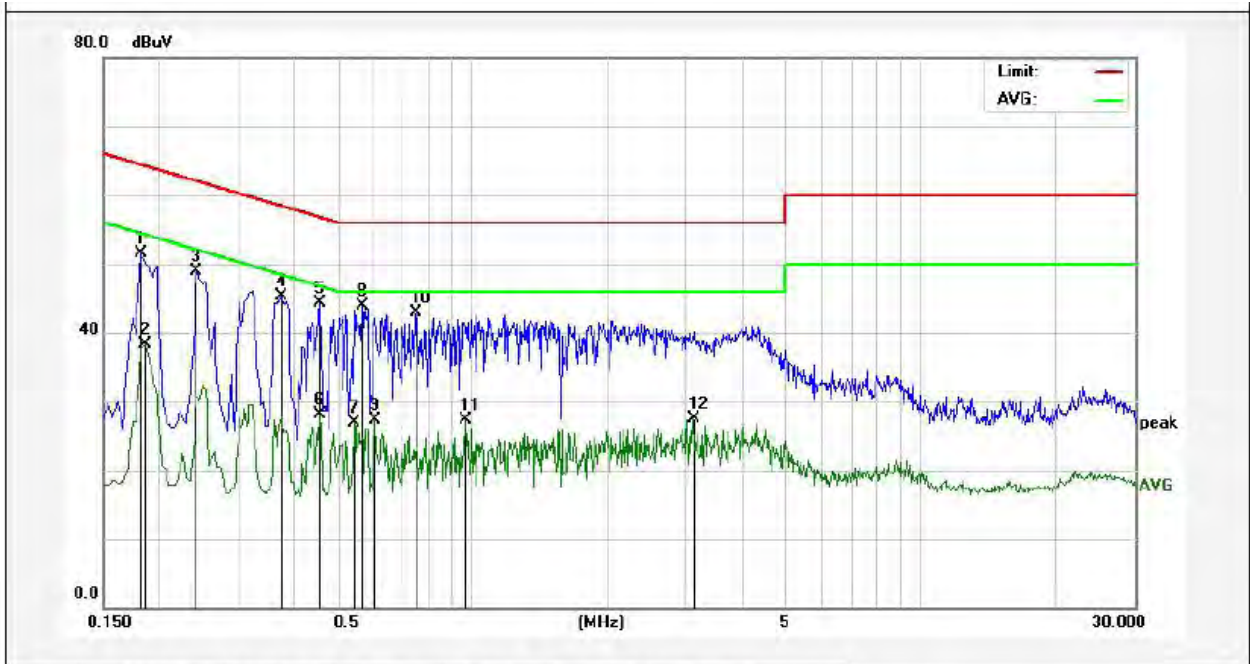

No.	Freq. (MHz)	Reading (dBuV)	Factor (dB)	Result (dBuV)	Limit dBuV	Over Limit (dB)	Detector	Remark
1	0.1819	31.70	19.90	51.60	64.39	-12.79	QP	
2	0.1860	18.47	19.90	38.37	54.21	-15.84	AVG	
3	0.2420	28.98	19.89	48.87	62.02	-13.15	QP	
4	0.3740	25.44	19.92	45.36	58.41	-13.05	QP	
5	0.4580	24.30	19.96	44.26	56.73	-12.47	QP	
6	0.4580	8.11	19.96	28.07	46.73	-18.66	AVG	
7	0.5460	6.99	19.99	26.98	46.00	-19.02	AVG	
8	0.5700	23.94	20.00	43.94	56.00	-12.06	QP	
9	0.6060	7.31	20.01	27.32	46.00	-18.68	AVG	
10	0.7500	22.87	20.05	42.92	56.00	-13.08	QP	
11	0.9660	7.23	20.11	27.34	46.00	-18.66	AVG	
12	3.1060	7.34	20.16	27.50	46.00	-18.50	AVG	

Conducted Emission Test Data

Test Site: 1# Shielded Room
 Operating Condition: TX+Charging mode
 Test Specification: AC 240V, 60Hz for adapter
 Comment: Neutral Line
 Tem.:22.3°C Hum.:57%

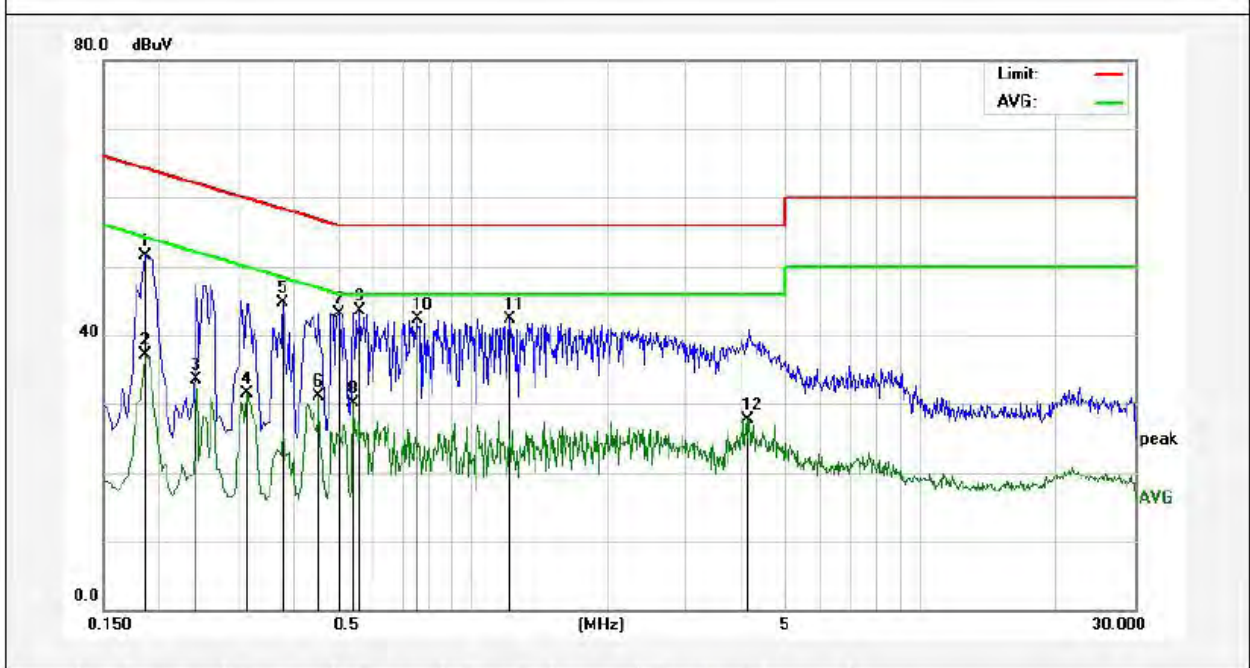

No.	Freq. (MHz)	Reading (dBuV)	Factor (dB)	Result (dBuV)	Limit dBuV	Over Limit (dB)	Detector	Remark
1	0.1860	31.63	19.90	51.53	64.21	-12.68	QP	
2	0.1860	17.12	19.90	37.02	54.21	-17.19	AVG	
3	0.2420	13.67	19.89	33.56	52.02	-18.46	AVG	
4	0.3140	11.65	19.90	31.55	49.86	-18.31	AVG	
5	0.3780	24.74	19.93	44.67	58.32	-13.65	QP	
6	0.4540	11.18	19.96	31.14	46.80	-15.66	AVG	
7	0.5020	23.15	19.98	43.13	56.00	-12.87	QP	
8	0.5420	10.15	19.99	30.14	46.00	-15.86	AVG	
9	0.5620	23.41	20.00	43.41	56.00	-12.59	QP	
10	0.7539	22.26	20.05	42.31	56.00	-13.69	QP	
11	1.2140	22.19	20.12	42.31	56.00	-13.69	QP	
12	4.0939	7.56	20.18	27.74	46.00	-18.26	AVG	

4. Radiation Spurious Emission and Band Edge

4.1. Test Standard and Limit

Test Standard	FCC Part15 C Section 15.209, 15.205 and 15.407, KDB 789033 D02 General UNII Test Procedures New Rules v01r04
---------------	---

Unwanted spurious emissions fallen in restricted bands per FCC Part15.205 shall comply with the general field strength limits set forth in § 15.209 as below table,

	Frequency (MHz)	Field strength (microvolt/meter)	Limit (dBuV/m)	Remark	Measurement distance (m)
Test Limit	0.009MHz~0.490MHz	2400/F(kHz)	-	-	300
	0.490MHz-1.705MHz	24000/F(kHz)	-	-	30
	1.705MHz-30MHz	30	-	-	30
	30MHz~88MHz	100	40.0	Quasi-peak	3
	88MHz~216MHz	150	43.5	Quasi-peak	3
	216MHz~960MHz	200	46.0	Quasi-peak	3
	960MHz~1000MHz	500	54.0	Quasi-peak	3
	Above 1000MHz	500	54.0	Average	3

Remark:

- (1)The lower limit shall apply at the transition frequency.
- (2) 15.35(b), Unless otherwise specified, the limit on peak radio frequency emissions is 20dB above the maximum permitted average emission limit applicable to the equipment under test. This peak limit applies to the total peak emission level radiated by the device.
- (3) Above 1GHz limit: $E[\text{dB}\mu\text{V}/\text{m}] = \text{EIRP}[\text{dBm}] + 95.2 = 68.2 \text{ dB}\mu\text{V}/\text{m}$, for $\text{EIRP}[\text{dBm}] = -27\text{dBm}$.

For transmitters operating in the 5.725-5.85GHz band:

15.407(b)(4)(i) All emissions shall be limited to a level of -27dBm/MHz at 75MHz or more above or below the band edge increasing linearly to 10dBm/MHz at 25MHz above or below the band edge, and from 25MHz above or below the band edge increasing linearly to a level of 15.6dBm/MHz at 5MHz above or below the band edge, and from 5MHz above or below the band edge increasing linearly to a level of 27dBm/MHz at the band edge.

KDB789033 D02 v01r04 (G)(2)(c)

(i) Sections 15.407(b)(1) to (b)(3) specify the unwanted emission limits for the U-NII-1 and U-NII-2 bands. As specified, emissions above 1000 MHz that are outside of the restricted bands are subject to a peak emission limit of -27dBm/MHz.³

(ii) Section 15.407(b)(4) specifies the unwanted emission limit for the U-NII-3 band. A band emissions mask is specified in Section 15.407(b)(4)(i). The emission limits are in terms of a Peak detector. An alternative to the band emissions mask is specified in Section 15.407(b)(4)(ii). The alternative limits are based on the highest antenna gain specified in the filing. There are also marketing and importation restrictions for the devices using the alternative limit.⁴

Note 3: An out-of-band emission that complies with both the average and peak limits of Section 15.209 is not required to satisfy the -27 dBm/MHz peak emission limit.

Note 4: Only devices with antenna gains of 10 dBi or less may be approved using the emission limits specified in Section 15.247(d) till March 2, 2018; all other devices operating in this band must use the mask specified in Section 15.407(b)(4)(i).

4.2. Test Setup

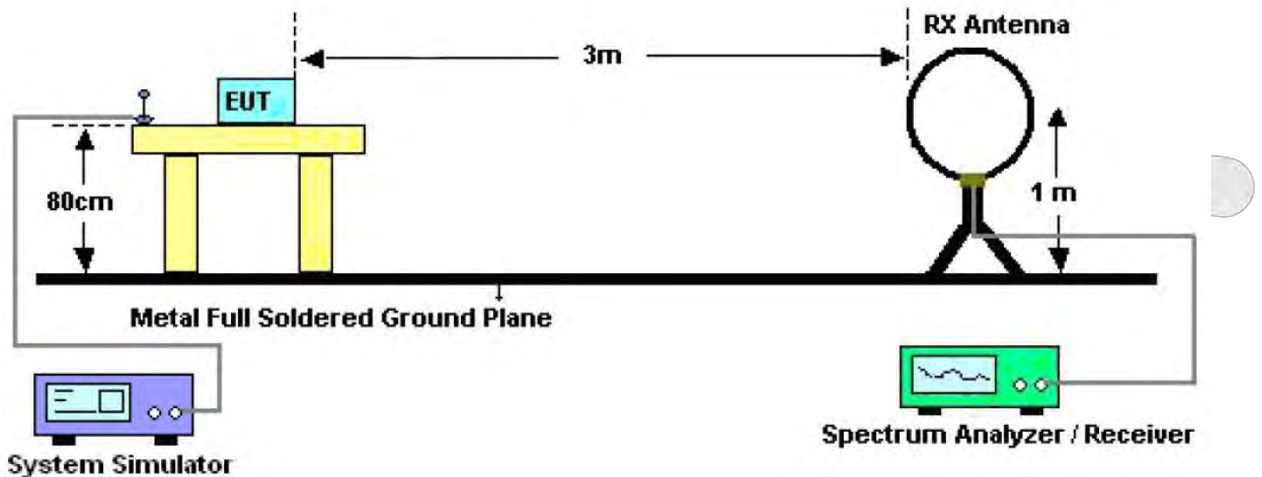

Figure 1. Below 30MHz

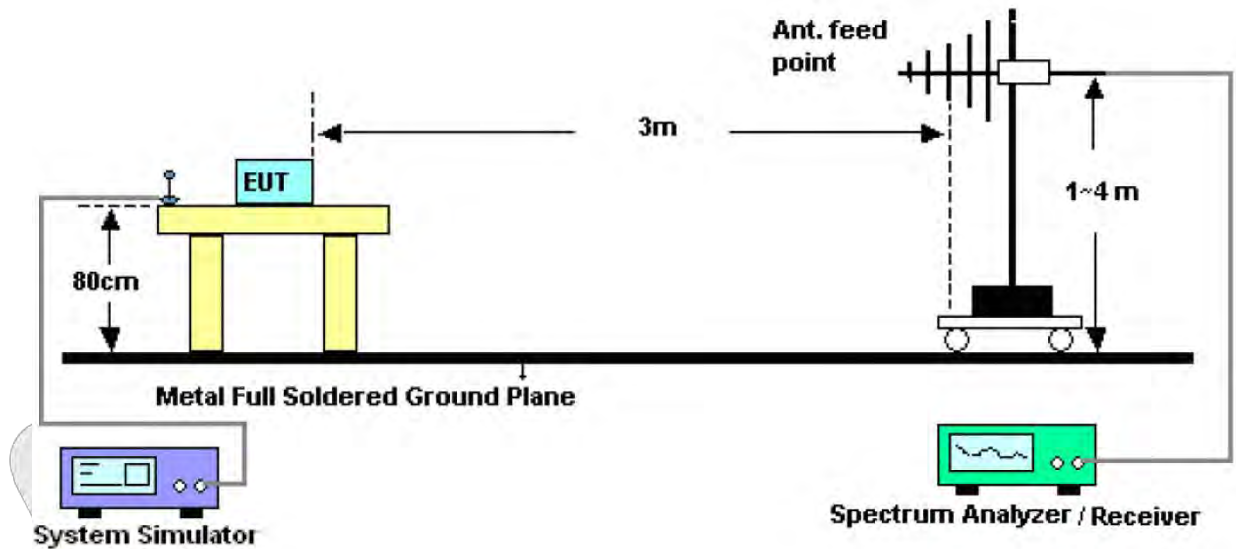

Figure 2. 30MHz to 1GHz

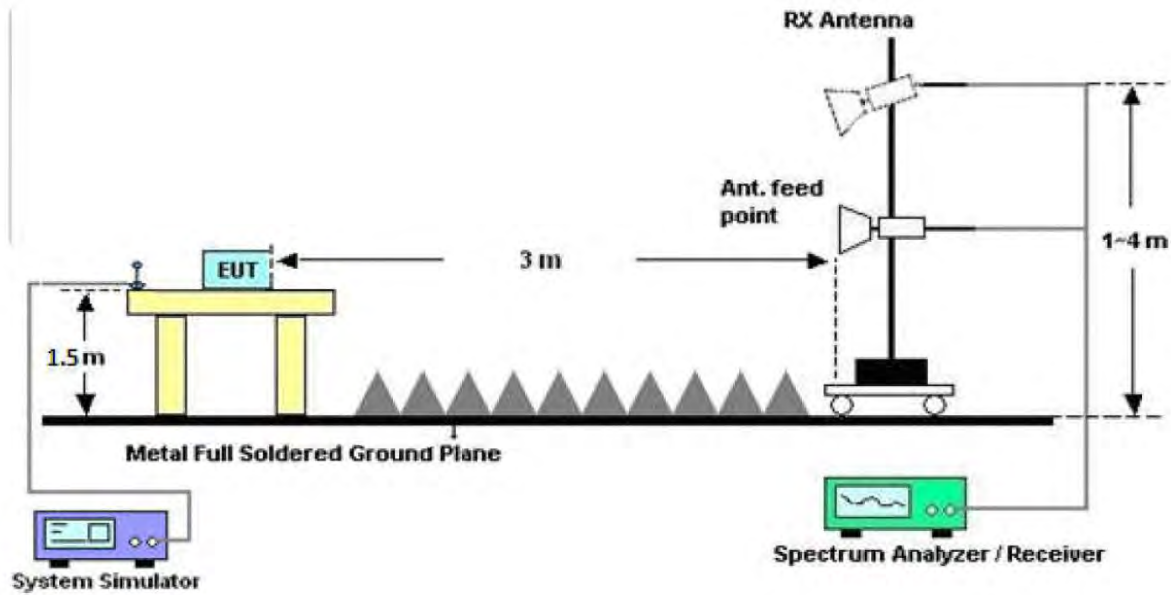

Figure 3. Above 1 GHz

4.3. Test Procedure

For below 1GHz: The EUT is placed on a turntable, which is 0.8m above the ground plane.

For above 1GHz: The EUT is placed on a turntable, which is 1.5m above the ground plane.

The turn table can rotate 360 degrees to determine the position of the maximum emission level. The EUT is set 3 meters away from the receiving antenna which is mounted on a antenna tower. The antenna can be moved up and down from 1 to 4 meters to find out the maximum emission level. Rotated the EUT through three orthogonal axes to determine the maximum emissions, both horizontal and vertical polarization of the antenna are set on test. The EUT is tested in 9*6*6 Chamber. The device is evaluated in xyz orientation.

For the radiated emission test above 1GHz:

Place the measurement antenna away from each area of the EUT determined to be a source of emissions at the specified measurement distance, while keeping the measurement antenna aimed at the source of emissions at each frequency of significant emissions, with polarization oriented for maximum response. The measurement antenna may have to be higher or lower than the EUT, depending on the radiation pattern of the emission and staying aimed at the emission source for receiving the maximum signal. The final measurement antenna elevation shall be that which maximizes the emissions. The measurement antenna elevation for maximum emissions shall be restricted to a range of heights of from 1 m to 4 m above the ground or reference ground plane.

For 9kHz to 150kHz, Set the spectrum analyzer as:

RBW = 200Hz, VBW =1kHz, Detector= Quasi-Peak, Trace mode= Max hold, Sweep- auto couple.

For 150kHz to 30MHz, Set the spectrum analyzer as:

RBW = 9KHz, VBW =30kHz, Detector= Quasi-Peak, Trace mode= Max hold, Sweep- auto couple.

For 30MHz to 1000MHz, Set the spectrum analyzer as:

RBW = 100kHz, VBW =300kHz, Detector= Quasi-Peak, Trace mode= Max hold, Sweep- auto couple.

For above 1GHz, Set the spectrum analyzer as:

RBW =1MHz, VBW =1MHz, Detector= Peak, Trace mode= Max hold, Sweep- auto couple.

RBW =1MHz, VBW =10Hz, Detector= Average, Trace mode= Max hold, Sweep- auto couple.

4.4. Test Data

PASS

The test results of 9kHz-30MHz was attenuated more than 20dB below the permissible limits, so the results don't record in the report.

Anbotek

Test Results (30~1000MHz)

Job No.: 0217110130W Temp.(°C)/Hum.(%RH): 24.3°C/55%RH
 Standard: FCC PART 15C Power Source: DC 5V USB Port
 Test Mode: TX+Charging Mode Polarization: Horizontal

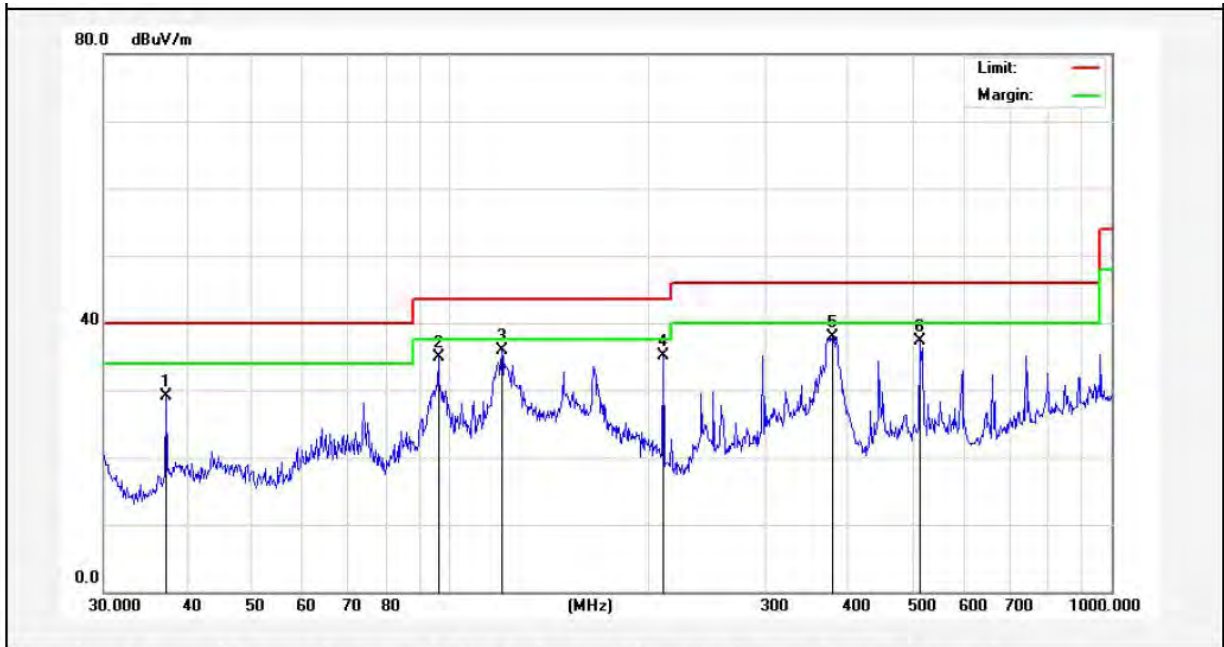

No.	Freq. (MHz)	Reading (dBuV/m)	Factor (dB/m)	Result (dBuV/m)	Limit (dBuV/)	Over Limit (dB)	Detector	Height (cm)	degree (deg)	Remark
1	37.2854	45.02	-15.84	29.18	40.00	-10.82	QP	300	0	
2	96.0986	56.10	-21.12	34.98	43.50	-8.52	QP	300	124	
3	119.8555	57.25	-21.32	35.93	43.50	-7.57	QP	300	151	
4	210.0482	54.17	-19.10	35.07	43.50	-8.43	QP	300	235	
5	378.5842	51.26	-13.30	37.96	46.00	-8.04	QP	300	302	
6	513.6331	48.33	-10.99	37.34	46.00	-8.66	QP	300	360	



Test Results (30~1000MHz)

Job No.: 0217110130W Temp.(°C)/Hum.(%RH): 24.3°C/55%RH
 Standard: FCC PART 15C Power Source: DC 5V USB Port
 Test Mode: TX+Charging Mode Polarization: Vertical

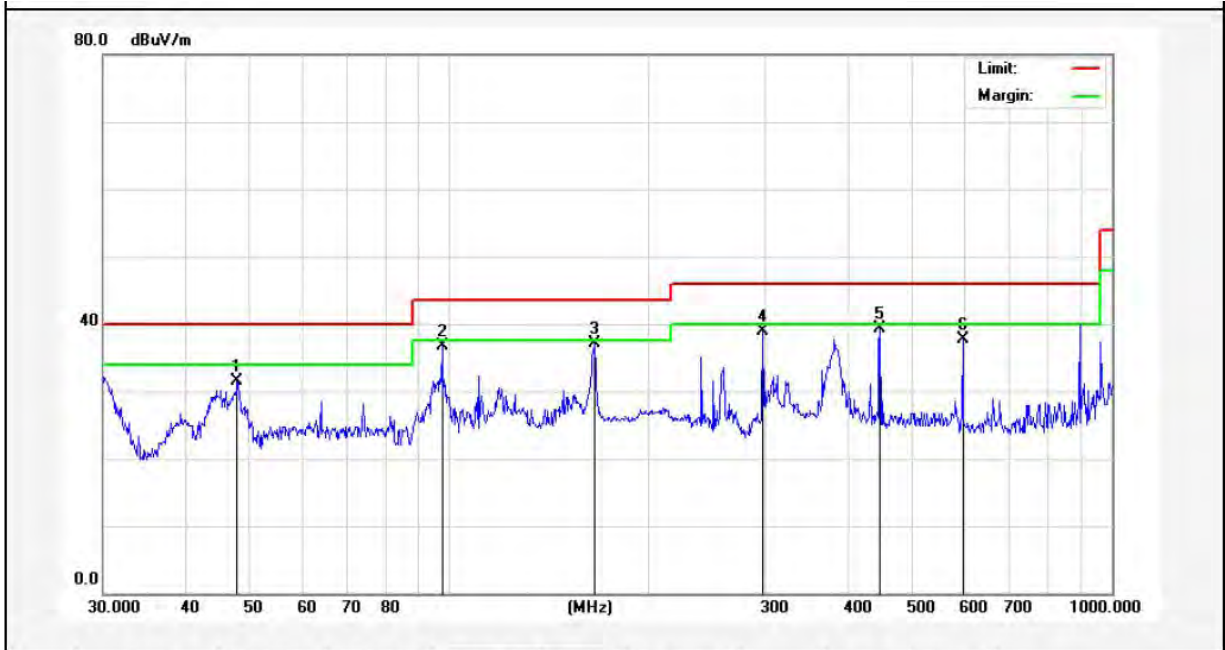

No.	Freq. (MHz)	Reading (dBuV/m)	Factor (dB/m)	Result (dBuV/m)	Limit (dBuV/)	Over Limit (dB)	Detector	Height (cm)	degree (deg)	Remark
1	47.8260	46.49	-15.04	31.45	40.00	-8.55	QP	300	0	
2	97.4560	51.70	-14.99	36.71	43.50	-6.79	QP	300	124	
3	165.4866	53.77	-16.70	37.07	43.50	-6.43	QP	300	235	
4	297.2241	53.69	-14.74	38.95	46.00	-7.05	QP	300	254	
5	446.4141	50.76	-11.49	39.27	46.00	-6.73	QP	300	321	
6	595.1326	47.10	-9.32	37.78	46.00	-8.22	QP	300	360	



Test Results (Above 1000MHz)

Test mode:	IEEE 802.11n(HT20)	Test channel:	Low CH
------------	--------------------	---------------	--------

Peak value:

Frequency (MHz)	Read Level (dBuV)	Antenna Factor (dB/m)	Cable Loss (dB)	Preamp Factor (dB)	Level (dBuV/m)	Limit Line (dBuV/m)	Over Limit (dB)	Pol.
11490.00	39.82	32.66	18.21	34.01	56.68	74.00	-17.32	V
17235.00	36.28	33.42	20.20	35.00	54.90	68.20	-13.30	V
11490.00	37.15	32.66	18.21	34.01	54.01	74.00	-19.99	H
17235.00	36.29	33.42	20.20	35.00	54.91	68.20	-13.29	H

Average value:

Frequency (MHz)	Read Level (dBuV)	Antenna Factor (dB/m)	Cable Loss (dB)	Preamp Factor (dB)	Level (dBuV/m)	Limit Line (dBuV/m)	Over Limit (dB)	Pol.
11490.00	31.19	32.66	18.21	34.01	48.05	54.00	-5.95	V
17235.00	28.32	33.42	20.20	35.00	46.94	54.00	-7.06	V
11490.00	30.51	32.66	18.21	34.01	47.37	54.00	-6.63	H
17235.00	28.35	33.42	20.20	35.00	46.97	54.00	-7.03	H

Test mode:	IEEE 802.11n(HT20)	Test channel:	Mid CH
------------	--------------------	---------------	--------

Peak value:

Frequency (MHz)	Read Level (dBuV)	Antenna Factor (dB/m)	Cable Loss (dB)	Preamp Factor (dB)	Level (dBuV/m)	Limit Line (dBuV/m)	Over Limit (dB)	Pol.
11570.00	41.28	32.67	18.24	34.02	58.17	74.00	-15.83	V
17355.00	38.19	33.44	20.22	35.01	56.84	68.20	-11.36	V
11570.00	37.66	32.67	18.24	34.02	54.55	74.00	-19.45	H
17355.00	35	33.44	20.22	35.01	53.65	68.20	-14.55	H

Average value:

Frequency (MHz)	Read Level (dBuV)	Antenna Factor (dB/m)	Cable Loss (dB)	Preamp Factor (dB)	Level (dBuV/m)	Limit Line (dBuV/m)	Over Limit (dB)	Pol.
11570.00	28.76	32.67	18.24	34.02	45.65	54.00	-8.35	V
17355.00	26.5	33.44	20.22	35.01	45.15	54.00	-8.85	V
11570.00	28.06	32.67	18.24	34.02	44.95	54.00	-9.05	H
17355.00	27.59	33.44	20.22	35.01	46.24	54.00	-7.76	H

Test mode:	IEEE 802.11n(HT20)	Test channel:	High CH
------------	--------------------	---------------	---------

Peak value:

Frequency (MHz)	Read Level (dBuV)	Antenna Factor (dB/m)	Cable Loss (dB)	Preamp Factor (dB)	Level (dBuV/m)	Limit Line (dBuV/m)	Over Limit (dB)	Pol.
11650.00	40.29	32.69	18.26	34.04	57.20	74.00	-16.80	V
17475.00	37.22	33.46	20.23	35.02	55.89	68.20	-12.31	V
11650.00	35.49	32.69	18.26	34.04	52.40	74.00	-21.60	H
17475.00	37.08	33.46	20.23	35.02	55.75	68.20	-12.45	H

Average value:

Frequency (MHz)	Read Level (dBuV)	Antenna Factor (dB/m)	Cable Loss (dB)	Preamp Factor (dB)	Level (dBuV/m)	Limit Line (dBuV/m)	Over Limit (dB)	Pol.
11650.00	30.11	32.69	18.26	34.04	47.02	54.00	-6.98	V
17475.00	29.78	33.46	20.23	35.02	48.45	54.00	-5.55	V
11650.00	28.78	32.69	18.26	34.04	45.69	54.00	-8.31	H
17475.00	27.65	33.46	20.23	35.02	46.32	54.00	-7.68	H

Test mode:	IEEE 802.11n(ac20)	Test channel:	Low CH
------------	--------------------	---------------	--------

Peak value:

Frequency (MHz)	Read Level (dBuV)	Antenna Factor (dB/m)	Cable Loss (dB)	Preamp Factor (dB)	Level (dBuV/m)	Limit Line (dBuV/m)	Over Limit (dB)	Pol.
11490.00	40.22	32.66	18.21	34.01	57.08	74.00	-16.92	V
17235.00	34.75	33.42	20.20	35.00	53.37	68.20	-14.83	V
11490.00	37.69	32.66	18.21	34.01	54.55	74.00	-19.45	H
17235.00	35.11	33.42	20.20	35.00	53.73	68.20	-14.47	H

Average value:

Frequency (MHz)	Read Level (dBuV)	Antenna Factor (dB/m)	Cable Loss (dB)	Preamp Factor (dB)	Level (dBuV/m)	Limit Line (dBuV/m)	Over Limit (dB)	Pol.
11490.00	31.74	32.66	18.21	34.01	48.60	54.00	-5.40	V
17235.00	28.62	33.42	20.20	35.00	47.24	54.00	-6.76	V
11490.00	29.16	32.66	18.21	34.01	46.02	54.00	-7.98	H
17235.00	27.58	33.42	20.20	35.00	46.20	54.00	-7.80	H

Test mode:	IEEE 802.11n(ac20)	Test channel:	Mid CH
------------	--------------------	---------------	--------

Peak value:

Frequency (MHz)	Read Level (dBuV)	Antenna Factor (dB/m)	Cable Loss (dB)	Preamp Factor (dB)	Level (dBuV/m)	Limit Line (dBuV/m)	Over Limit (dB)	Pol.
11570.00	41.08	32.67	18.24	34.02	57.97	74.00	-16.03	V
17355.00	34.75	33.44	20.22	35.01	53.40	68.20	-14.80	V
11570.00	40.09	32.67	18.24	34.02	56.98	74.00	-17.02	H
17355.00	35.77	33.44	20.22	35.01	54.42	68.20	-13.78	H

Average value:

Frequency (MHz)	Read Level (dBuV)	Antenna Factor (dB/m)	Cable Loss (dB)	Preamp Factor (dB)	Level (dBuV/m)	Limit Line (dBuV/m)	Over Limit (dB)	Pol.
11570.00	30.61	32.67	18.24	34.02	47.50	54.00	-6.50	V
17355.00	26.88	33.44	20.22	35.01	45.53	54.00	-8.47	V
11570.00	28.41	32.67	18.24	34.02	45.30	54.00	-8.70	H
17355.00	26.55	33.44	20.22	35.01	45.20	54.00	-8.80	H

Test mode:	IEEE 802.11n(ac20)	Test channel:	High CH
------------	--------------------	---------------	---------

Peak value:

Frequency (MHz)	Read Level (dBuV)	Antenna Factor (dB/m)	Cable Loss (dB)	Preamp Factor (dB)	Level (dBuV/m)	Limit Line (dBuV/m)	Over Limit (dB)	Pol.
11650.00	41.61	32.69	18.26	34.04	58.52	74.00	-15.48	V
17475.00	35.77	33.46	20.23	35.02	54.44	68.20	-13.76	V
11650.00	40.45	32.69	18.26	34.04	57.36	74.00	-16.64	H
17475.00	36.15	33.46	20.23	35.02	54.82	68.20	-13.38	H

Average value:

Frequency (MHz)	Read Level (dBuV)	Antenna Factor (dB/m)	Cable Loss (dB)	Preamp Factor (dB)	Level (dBuV/m)	Limit Line (dBuV/m)	Over Limit (dB)	Pol.
11650.00	31.19	32.69	18.26	34.04	48.10	54.00	-5.90	V
17475.00	28.63	33.46	20.23	35.02	47.30	54.00	-6.70	V
11650.00	28.30	32.69	18.26	34.04	45.21	54.00	-8.79	H
17475.00	27.06	33.46	20.23	35.02	45.73	54.00	-8.27	H

Test mode:	IEEE 802.11n(HT40)	Test channel:	Low CH
------------	--------------------	---------------	--------

Peak value:

Frequency (MHz)	Read Level (dBuV)	Antenna Factor (dB/m)	Cable Loss (dB)	Preamp Factor (dB)	Level (dBuV/m)	Limit Line (dBuV/m)	Over Limit (dB)	Pol.
11510.00	38.95	32.66	18.21	34.01	55.81	74.00	-18.19	V
17265.00	36.55	33.43	20.21	35.00	55.19	68.20	-13.01	V
11510.00	36.41	32.66	18.21	34.01	53.27	74.00	-20.73	H
17265.00	35.01	33.43	20.21	35.00	53.65	68.20	-14.55	H

Average value:

Frequency (MHz)	Read Level (dBuV)	Antenna Factor (dB/m)	Cable Loss (dB)	Preamp Factor (dB)	Level (dBuV/m)	Limit Line (dBuV/m)	Over Limit (dB)	Pol.
11510.00	33.54	32.66	18.21	34.01	50.40	54.00	-3.60	V
17265.00	30.54	33.43	20.21	35.00	49.18	54.00	-4.82	V
11510.00	30.12	32.66	18.21	34.01	46.98	54.00	-7.02	H
17265.00	25.99	33.43	20.21	35.00	44.63	54.00	-9.37	H

Test mode:	IEEE 802.11n(HT40)	Test channel:	High CH
------------	--------------------	---------------	---------

Peak value:

Frequency (MHz)	Read Level (dBuV)	Antenna Factor (dB/m)	Cable Loss (dB)	Preamp Factor (dB)	Level (dBuV/m)	Limit Line (dBuV/m)	Over Limit (dB)	Pol.
11590.00	41.21	32.68	18.24	34.03	58.10	74.00	-15.90	V
17385.00	38.24	33.45	20.22	35.02	56.89	68.20	-11.31	V
11590.00	36.99	32.68	18.24	34.03	53.88	74.00	-20.12	H
17385.00	35.21	33.45	20.22	35.02	53.86	68.20	-14.34	H

Average value:

Frequency (MHz)	Read Level (dBuV)	Antenna Factor (dB/m)	Cable Loss (dB)	Preamp Factor (dB)	Level (dBuV/m)	Limit Line (dBuV/m)	Over Limit (dB)	Pol.
11590.00	30.95	32.68	18.24	34.03	47.84	54.00	-6.16	V
17385.00	30.21	33.45	20.22	35.02	48.86	54.00	-5.14	V
11590.00	30.11	32.68	18.24	34.03	47.00	54.00	-7.00	H
17385.00	27.84	33.45	20.22	35.02	46.49	54.00	-7.51	H

Test mode:	IEEE 802.11ac(HT40)	Test channel:	Low CH
------------	---------------------	---------------	--------

Peak value:

Frequency (MHz)	Read Level (dBuV)	Antenna Factor (dB/m)	Cable Loss (dB)	Preamp Factor (dB)	Level (dBuV/m)	Limit Line (dBuV/m)	Over Limit (dB)	Pol.
11510.00	37.69	32.66	18.21	34.01	54.55	74.00	-19.45	V
17265.00	35.49	33.43	20.21	35.00	54.13	68.20	-14.07	V
11510.00	37.55	32.66	18.21	34.01	54.41	74.00	-19.59	H
17265.00	35.19	33.43	20.21	35.00	53.83	68.20	-14.37	H

Average value:

Frequency (MHz)	Read Level (dBuV)	Antenna Factor (dB/m)	Cable Loss (dB)	Preamp Factor (dB)	Level (dBuV/m)	Limit Line (dBuV/m)	Over Limit (dB)	Pol.
11510.00	32	32.66	18.21	34.01	48.86	54.00	-5.14	V
17265.00	27.61	33.43	20.21	35.00	46.25	54.00	-7.75	V
11510.00	29.31	32.66	18.21	34.01	46.17	54.00	-7.83	H
17265.00	26.68	33.43	20.21	35.00	45.32	54.00	-8.68	H

Test mode:	IEEE 802.11ac(HT40)	Test channel:	High CH
------------	---------------------	---------------	---------

Peak value:

Frequency (MHz)	Read Level (dBuV)	Antenna Factor (dB/m)	Cable Loss (dB)	Preamp Factor (dB)	Level (dBuV/m)	Limit Line (dBuV/m)	Over Limit (dB)	Pol.
11590.00	40.78	32.68	18.24	34.03	57.67	74.00	-16.33	V
17385.00	37.55	33.45	20.22	35.02	56.20	68.20	-12.00	V
11590.00	38.45	32.68	18.24	34.03	55.34	74.00	-18.66	H
17385.00	37.21	33.45	20.22	35.02	55.86	68.20	-12.34	H

Average value:

Frequency (MHz)	Read Level (dBuV)	Antenna Factor (dB/m)	Cable Loss (dB)	Preamp Factor (dB)	Level (dBuV/m)	Limit Line (dBuV/m)	Over Limit (dB)	Pol.
11590.00	31.51	32.68	18.24	34.03	48.40	54.00	-5.60	V
17385.00	29.88	33.45	20.22	35.02	48.53	54.00	-5.47	V
11590.00	31.25	32.68	18.24	34.03	48.14	54.00	-5.86	H
17385.00	28.38	33.45	20.22	35.02	47.03	54.00	-6.97	H

Test mode:	IEEE 802.11ac(HT80)	Test channel:	
------------	---------------------	---------------	--

Peak value:

Frequency (MHz)	Read Level (dBuV)	Antenna Factor (dB/m)	Cable Loss (dB)	Preamp Factor (dB)	Level (dBuV/m)	Limit Line (dBuV/m)	Over Limit (dB)	Pol.
11550.00	42.88	32.67	18.24	34.02	59.77	74.00	-14.23	V
17325.00	37.26	33.44	20.22	35.01	55.91	68.20	-12.29	V
11550.00	36.51	32.67	18.24	34.02	53.40	74.00	-20.60	H
17325.00	35.69	33.44	20.22	35.01	54.34	68.20	-13.86	H

Average value:

Frequency (MHz)	Read Level (dBuV)	Antenna Factor (dB/m)	Cable Loss (dB)	Preamp Factor (dB)	Level (dBuV/m)	Limit Line (dBuV/m)	Over Limit (dB)	Pol.
11550.00	31.49	32.67	18.24	34.02	48.38	54.00	-5.62	V
17325.00	27.61	33.44	20.22	35.01	46.26	54.00	-7.74	V
11550.00	31.08	32.67	18.24	34.02	47.97	54.00	-6.03	H
17325.00	27.49	33.44	20.22	35.01	46.14	54.00	-7.86	H

Note:

1. Final Level = Receiver Read level + Antenna Factor + Cable Loss - Pre-amplifier Factor

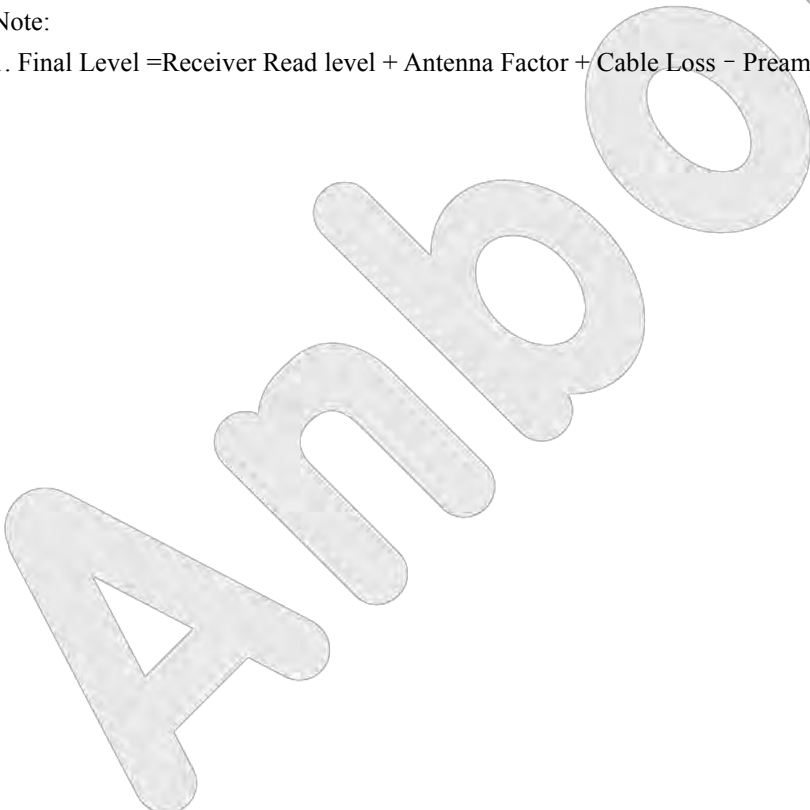

Radiated Band Edge:

Test Mode: 802.11n20								
Peak Value								
Frequency (MHz)	Read Level (dBuV)	Antenna Factor (dB/m)	Cable Loss (dB)	Preamp Factor (dB)	Level (dBuV/m)	Limit (dBuV/m)	Over Limit (dB)	Pol.
5725.00	41.08	29.78	15.69	31.08	55.47	68.20	-12.73	H
5850.00	41.83	30.01	16.82	32.09	56.57	68.20	-11.63	H
5725.00	41.88	29.78	15.69	31.08	56.27	68.20	-11.93	V
5850.00	42.33	30.01	16.82	32.09	57.07	68.20	-11.13	V
Average Value								
Frequency (MHz)	Read Level (dBuV)	Antenna Factor (dB/m)	Cable Loss (dB)	Preamp Factor (dB)	Level (dBuV/m)	Limit (dBuV/m)	Over Limit (dB)	Pol.
5725.00	34.19	29.78	15.69	31.08	48.58	54.00	-5.42	H
5850.00	33.21	30.01	16.82	32.09	47.95	54.00	-6.05	H
5725.00	34.51	29.78	15.69	31.08	48.90	54.00	-5.10	V
5850.00	34.39	30.01	16.82	32.09	49.13	54.00	-4.87	V

Test Mode: 802.11ac20								
Peak Value								
Frequency (MHz)	Read Level (dBuV)	Antenna Factor (dB/m)	Cable Loss (dB)	Preamp Factor (dB)	Level (dBuV/m)	Limit (dBuV/m)	Over Limit (dB)	Pol.
5725.00	41.28	29.78	15.69	31.08	55.67	68.20	-12.53	H
5850.00	42.35	30.01	16.82	32.09	57.09	68.20	-11.11	H
5725.00	41.59	29.78	15.69	31.08	55.98	68.20	-12.22	V
5850.00	40.61	30.01	16.82	32.09	55.35	68.20	-12.85	V
Average Value								
Frequency (MHz)	Read Level (dBuV)	Antenna Factor (dB/m)	Cable Loss (dB)	Preamp Factor (dB)	Level (dBuV/m)	Limit (dBuV/m)	Over Limit (dB)	Pol.
5725.00	32.71	29.78	15.69	31.08	47.10	54.00	-6.90	H
5850.00	33.48	30.01	16.82	32.09	48.22	54.00	-5.78	H
5725.00	32.78	29.78	15.69	31.08	47.17	54.00	-6.83	V
5850.00	32.90	30.01	16.82	32.09	47.64	54.00	-6.36	V

Test Mode: 802.11n40								
Peak Value								
Frequency (MHz)	Read Level (dBuV)	Antenna Factor (dB/m)	Cable Loss (dB)	Preamp Factor (dB)	Level (dBuV/m)	Limit (dBuV/m)	Over Limit (dB)	Pol.
5725.00	41.01	29.78	15.69	31.08	55.40	68.20	-12.80	H
5850.00	41.52	30.01	16.82	32.09	56.26	68.20	-11.94	H
5725.00	40.28	29.78	15.69	31.08	54.67	68.20	-13.53	V
5850.00	42.36	30.01	16.82	32.09	57.10	68.20	-11.10	V
Average Value								
Frequency (MHz)	Read Level (dBuV)	Antenna Factor (dB/m)	Cable Loss (dB)	Preamp Factor (dB)	Level (dBuV/m)	Limit (dBuV/m)	Over Limit (dB)	Pol.
5725.00	34.71	29.78	15.69	31.08	49.10	54.00	-4.90	H
5850.00	33.65	30.01	16.82	32.09	48.39	54.00	-5.61	H
5725.00	32.18	29.78	15.69	31.08	46.57	54.00	-7.43	V
5850.00	33.79	30.01	16.82	32.09	48.53	54.00	-5.47	V

Test Mode: 802.11ac40								
Peak Value								
Frequency (MHz)	Read Level (dBuV)	Antenna Factor (dB/m)	Cable Loss (dB)	Preamp Factor (dB)	Level (dBuV/m)	Limit (dBuV/m)	Over Limit (dB)	Pol.
5725.00	41.55	29.78	15.69	31.08	55.94	68.20	-12.26	H
5850.00	41.99	30.01	16.82	32.09	56.73	68.20	-11.47	H
5725.00	40.88	29.78	15.69	31.08	55.27	68.20	-12.93	V
5850.00	42.99	30.01	16.82	32.09	57.73	68.20	-10.47	V
Average Value								
Frequency (MHz)	Read Level (dBuV)	Antenna Factor (dB/m)	Cable Loss (dB)	Preamp Factor (dB)	Level (dBuV/m)	Limit (dBuV/m)	Over Limit (dB)	Pol.
5725.00	34.88	29.78	15.69	31.08	49.27	54.00	-4.73	H
5850.00	33.99	30.01	16.82	32.09	48.73	54.00	-5.27	H
5725.00	32.99	29.78	15.69	31.08	47.38	54.00	-6.62	V
5850.00	33.55	30.01	16.82	32.09	48.29	54.00	-5.71	V

Test Mode: 802.11ac80								
Peak Value								
Frequency (MHz)	Read Level (dBuV)	Antenna Factor (dB/m)	Cable Loss (dB)	Preamp Factor (dB)	Level (dBuV/m)	Limit (dBuV/m)	Over Limit (dB)	Pol.
5725.00	42.39	29.78	15.69	31.08	56.78	68.20	-11.42	H
5850.00	42.01	30.01	16.82	32.09	56.75	68.20	-11.45	H
5725.00	40.38	29.78	15.69	31.08	54.77	68.20	-13.43	V
5850.00	42.19	30.01	16.82	32.09	56.93	68.20	-11.27	V
Average Value								
Frequency (MHz)	Read Level (dBuV)	Antenna Factor (dB/m)	Cable Loss (dB)	Preamp Factor (dB)	Level (dBuV/m)	Limit (dBuV/m)	Over Limit (dB)	Pol.
5725.00	33.07	29.78	15.69	31.08	47.46	54.00	-6.54	H
5850.00	33.58	30.01	16.82	32.09	48.32	54.00	-5.68	H
5725.00	32.31	29.78	15.69	31.08	46.70	54.00	-7.30	V
5850.00	34.99	30.01	16.82	32.09	49.73	54.00	-4.27	V

Anbotek

For conducted test:

802.11n(20): Band Edge, Left Side

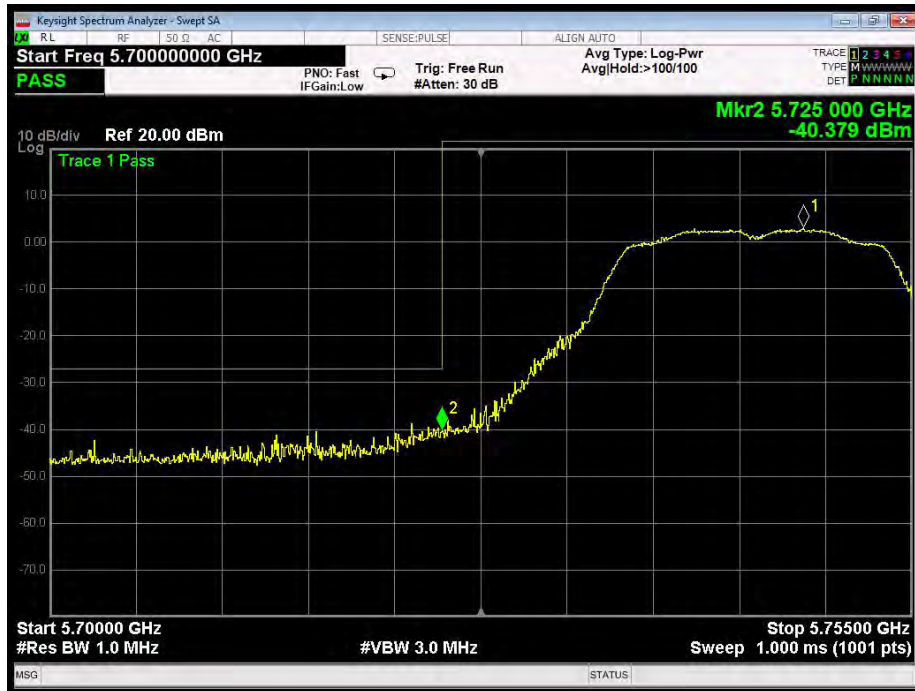

802.11n(20): Band Edge, Right Side



802.11ac(20): Band Edge, Left Side

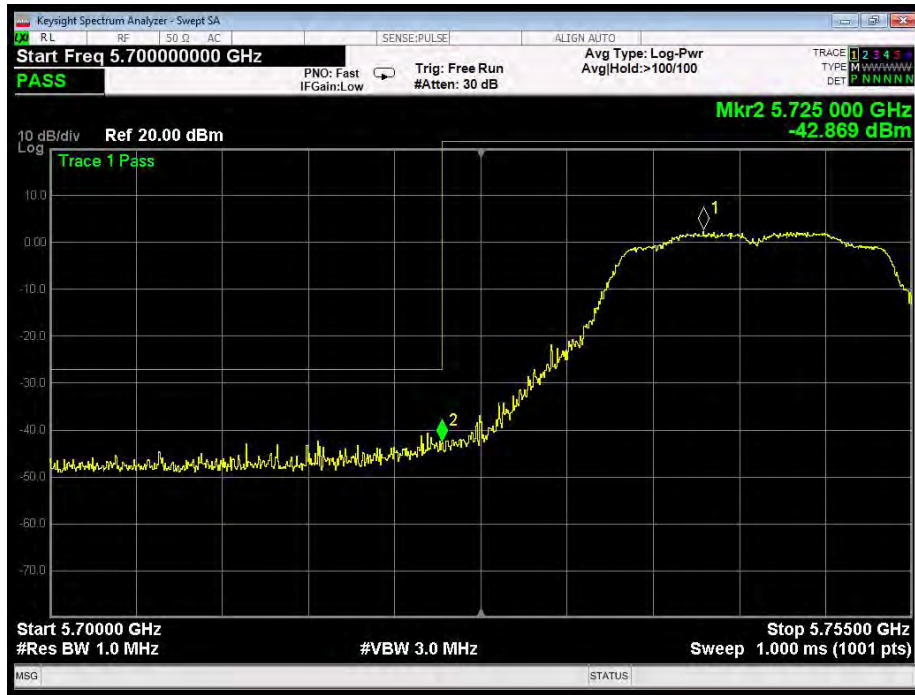

802.11ac(20): Band Edge, Right Side



802.11n(40): Band Edge, Left Side



802.11n(40): Band Edge, Right Side



802.11ac(40): Band Edge, Left Side



802.11ac(40): Band Edge, Right Side



802.11ac(80): Band Edge, Left Side

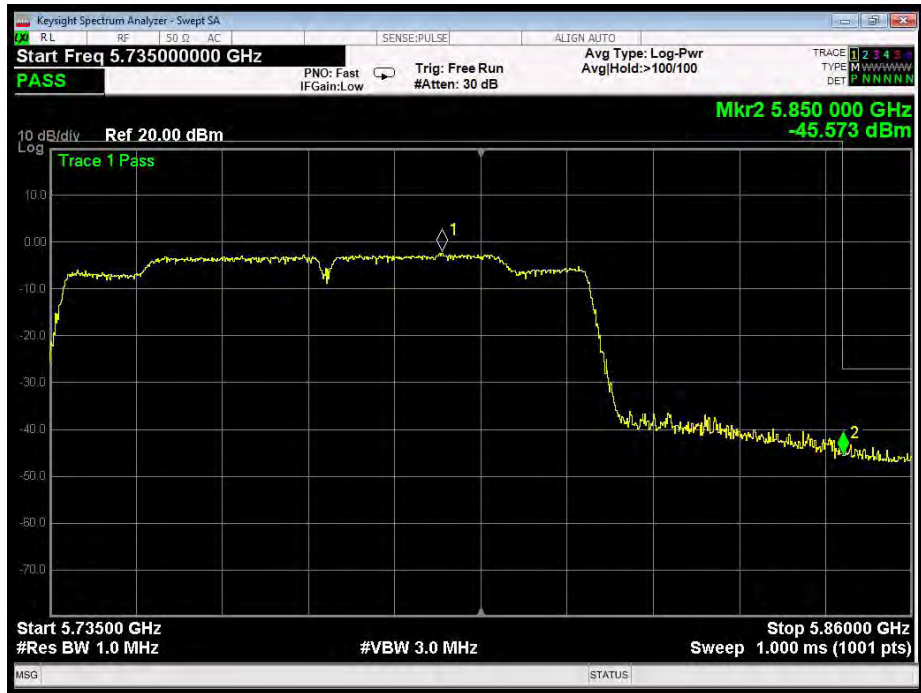

802.11ac(80): Band Edge, Right Side

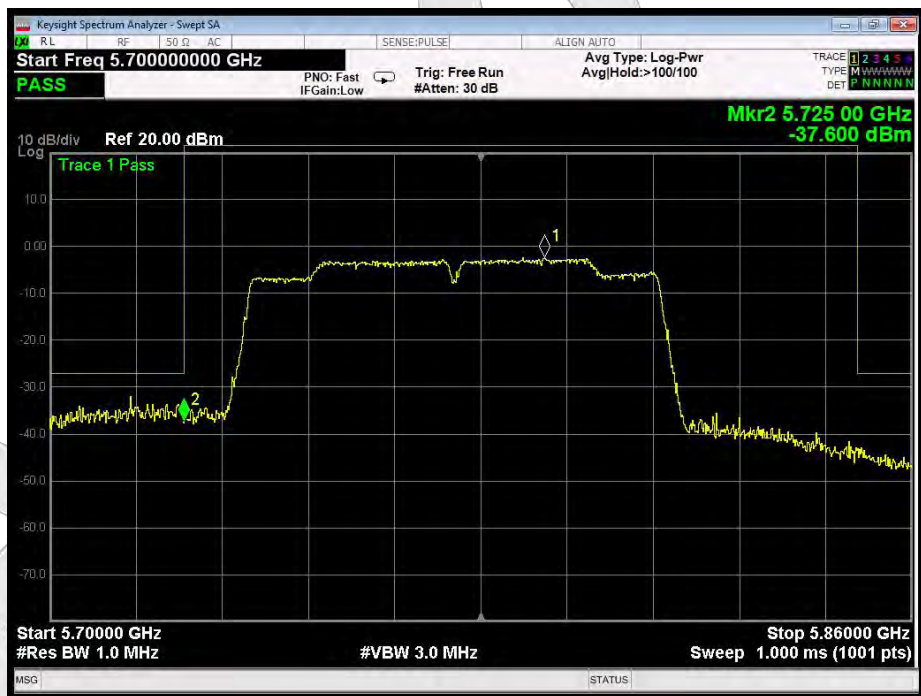

5. Maximum Peak Output Power Test

5.1. Test Standard and Limit

Test Standard	FCC Part15 C Section 15.407 (a)(1) (3)
Test Limit	30dBm (1W)

5.2. Test Setup

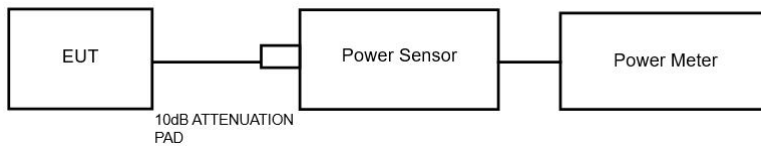

5.3. Test Procedure

1. The Transmitter output (antenna port) was connected to the power meter.
2. Turn on the EUT and power meter and then record the power value.
3. Repeat above procedures on all channels needed to be tested.

Note: The cable loss and attenuator loss were offset into measure device as an amplitude offset.

5.4. Test Data

Test Item	: Max. peak output power	Test Mode	: CH Low ~ CH High
Test Voltage	: DC 5V USB Port	Temperature	: 24°C
Test Result	: PASS	Humidity	: 55%RH

Mode	Channel Frequency (MHz)	Peak Power output (dBm)	Correctional Limit (dBm)	Results
		ANT		
802.11n20	5745	11.78	30.00	PASS
	5785	11.93	30.00	PASS
	5825	12.62	30.00	PASS
802.11ac20	5745	11.33	30.00	PASS
	5785	12.13	30.00	PASS
	5825	12.33	30.00	PASS
802.11n40	5755	11.44	30.00	PASS
	5795	12.39	30.00	PASS
802.11ac40	5755	11.28	30.00	PASS
	5795	12.26	30.00	PASS
802.11ac80	5775	12.11	30.00	PASS

Anbotek

6. Occupy Bandwidth Test

6.1. Test Standard

Test Standard	FCC Part15 C Section 15.403(i), 15.407 (e)
---------------	--

6.2. Test Setup

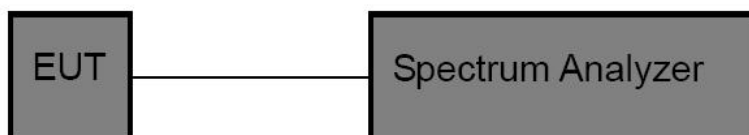

6.3. Test Procedure

1. Place the EUT on the table and set it in the transmitting mode.
2. Remove the antenna from the EUT and then connect a low loss RF cable from the antenna port to the spectrum analyzer.

3. Set the spectrum analyzer as:

26 dB & 99% bandwidth

RBW = approximately 1% of the emission bandwidth;

Set the VBW > RBW;

Detector = Peak

Trace mode = Max hold.

Sweep - auto couple.

6 dB bandwidth

RBW = 100kHz;

Set the video bandwidth (VBW) ≥ 3 RBW;

Detector = Peak

Trace mode = Max hold.

Sweep - auto couple.

4. Measure the maximum width of the emission that is 26dB /6dB down from the maximum of the emission. Compare this with the RBW setting of the analyzer.
5. Repeat until all the rest channels are investigated.

6.4. Test Data

Test Item	: 6dB & 26dB BW	Test Mode	: CH Low ~ CH High
Test Voltage	: DC 5V USB Port	Temperature	: 24°C
Test Result	: PASS	Humidity	: 55%RH

Mode	Channel Frequency (MHz)	6dB BW(MHz)	Limit	Results
802.11n20	5745	15.17	>0.5MHz	PASS
	5785	15.15		PASS
	5825	15.15		PASS
802.11ac20	5745	14.24		PASS
	5785	15.14		PASS
	5825	15.11		PASS
802.11n40	5755	35.21		PASS
	5795	35.20		PASS
802.11ac40	5755	35.09		PASS
	5795	35.21		PASS
802.11ac80	5775	75.38	PASS	

Mode	Channel Frequency (MHz)	26dB BW(MHz)	99% Bandwidth (MHz)
802.11n20	5745	22.48	17.722
	5785	23.36	17.705
	5825	22.85	17.684
802.11ac20	5745	22.82	17.732
	5785	22.45	17.736
	5825	22.93	17.748
802.11n40	5755	41.48	36.125
	5795	41.40	36.147
802.11ac40	5755	42.15	36.103
	5795	41.42	36.100
802.11ac80	5775	81.26	75.277

6dB Bandwidth

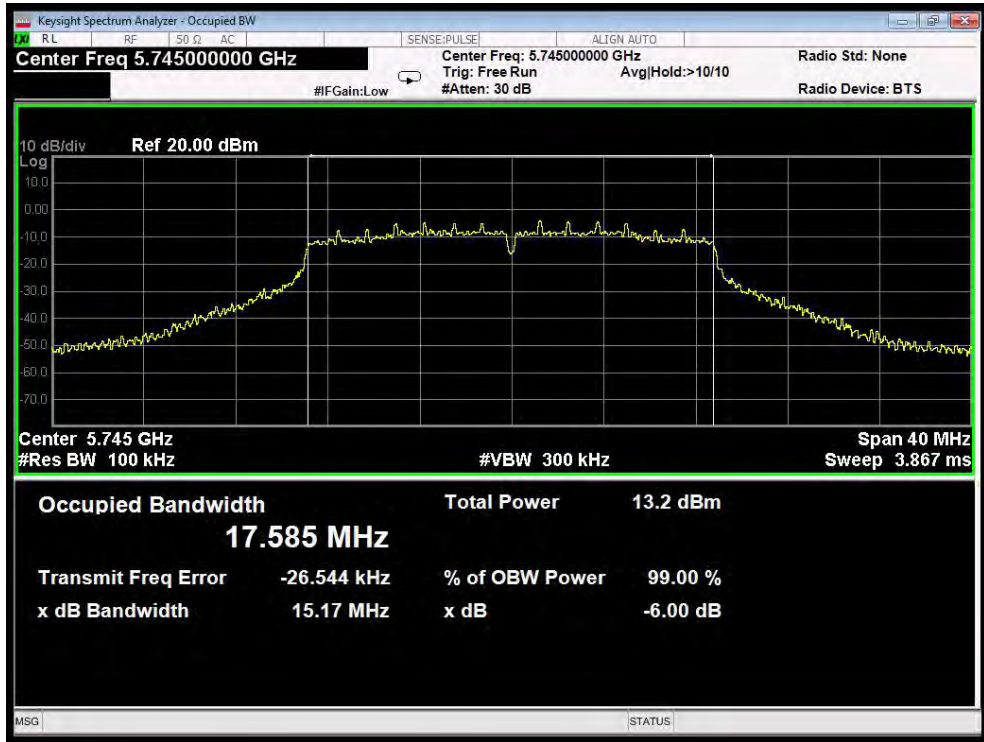

Test Mode: 802.11n20---Low

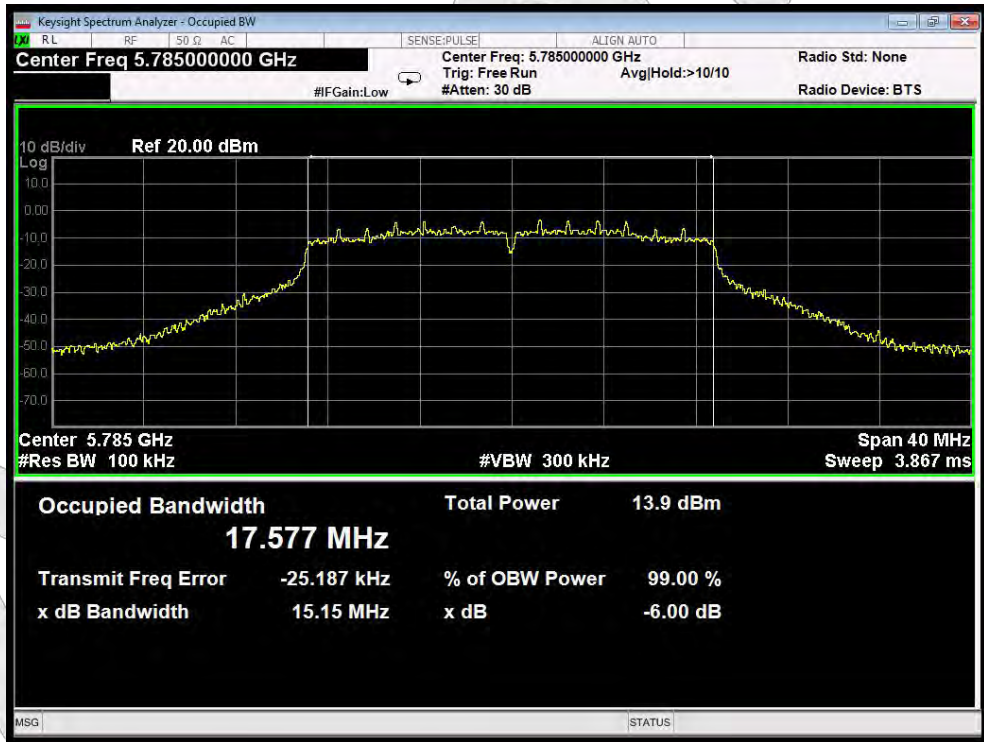

Test Mode: 802.11n20---Middle

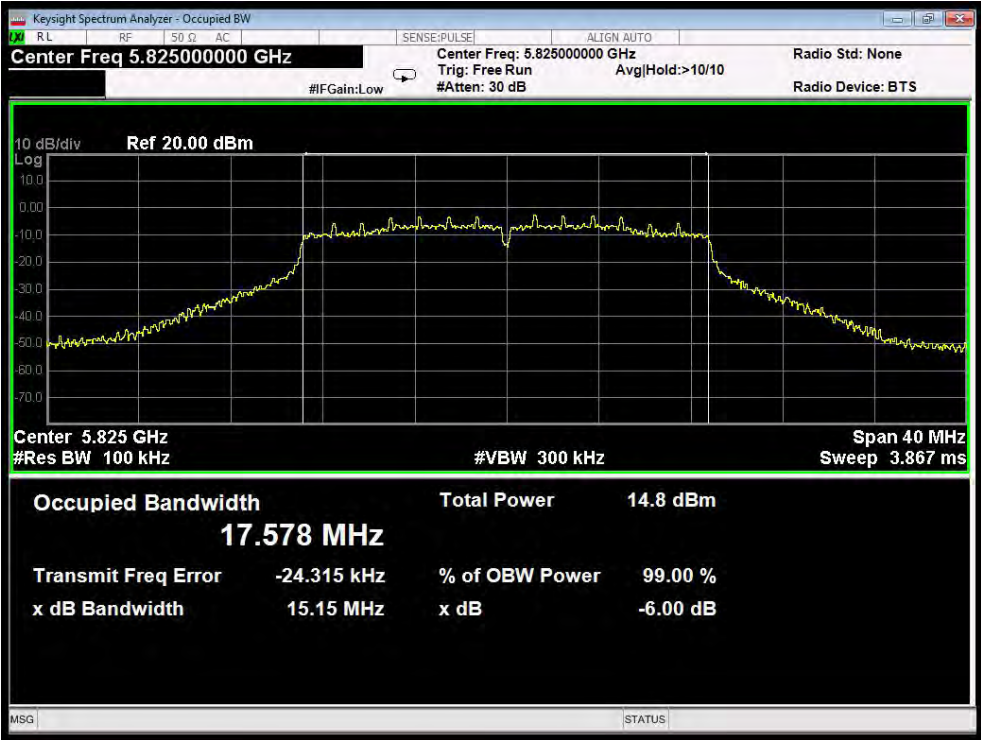

Test Mode: 802.11n20---High

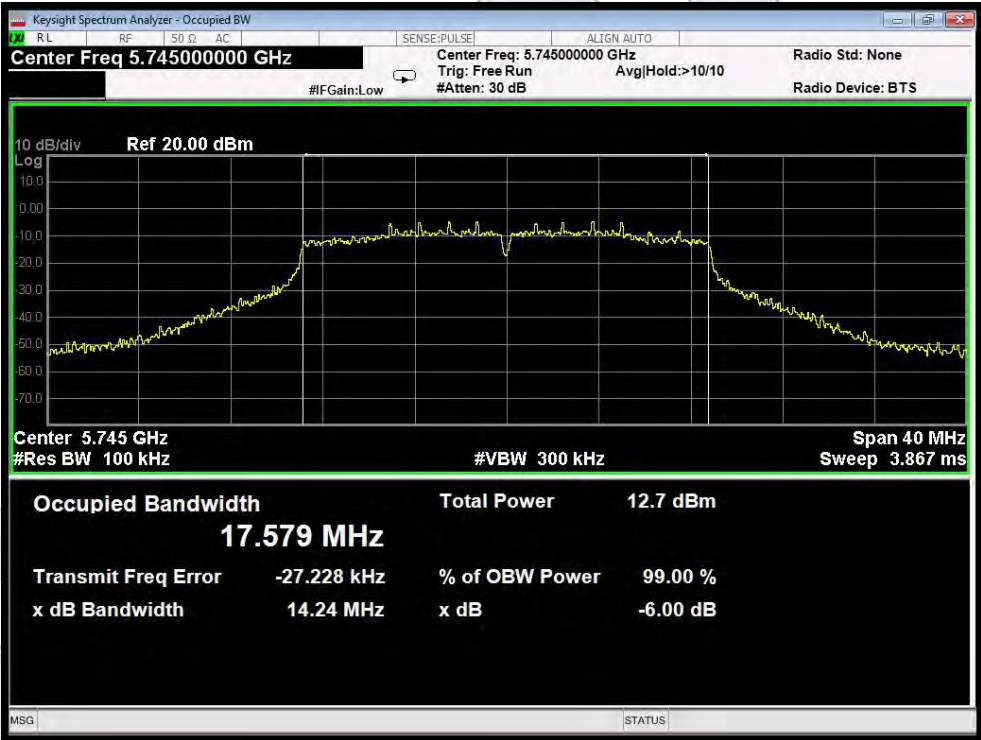

Test Mode: 802.11ac20--Low

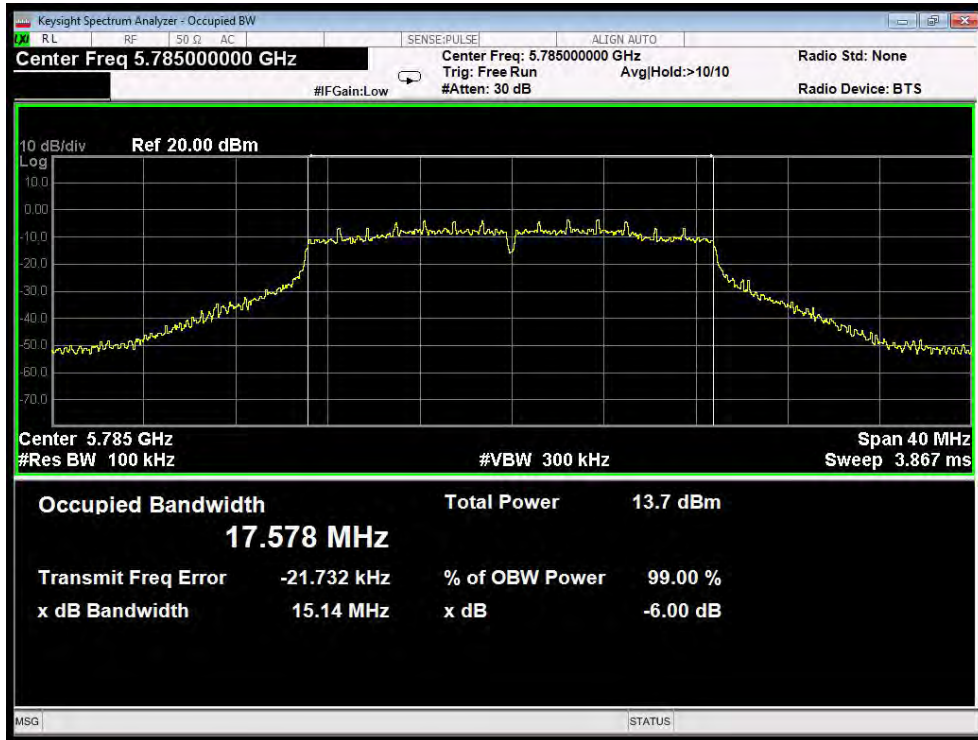

Test Mode: 802.11ac20---Middle

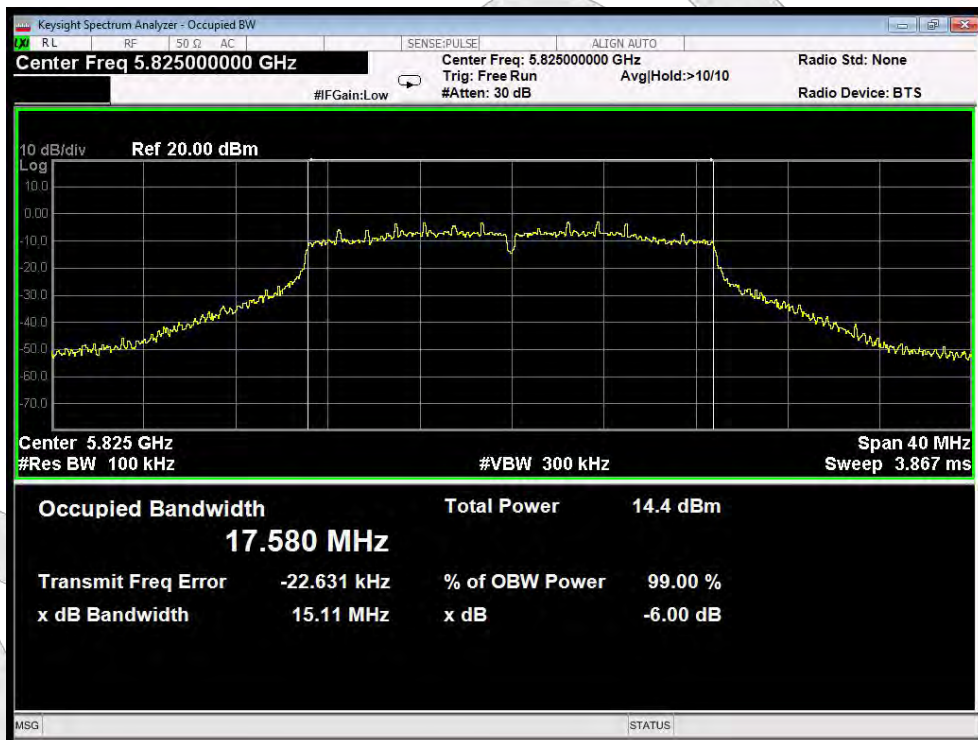

Test Mode: 802.11ac20---High

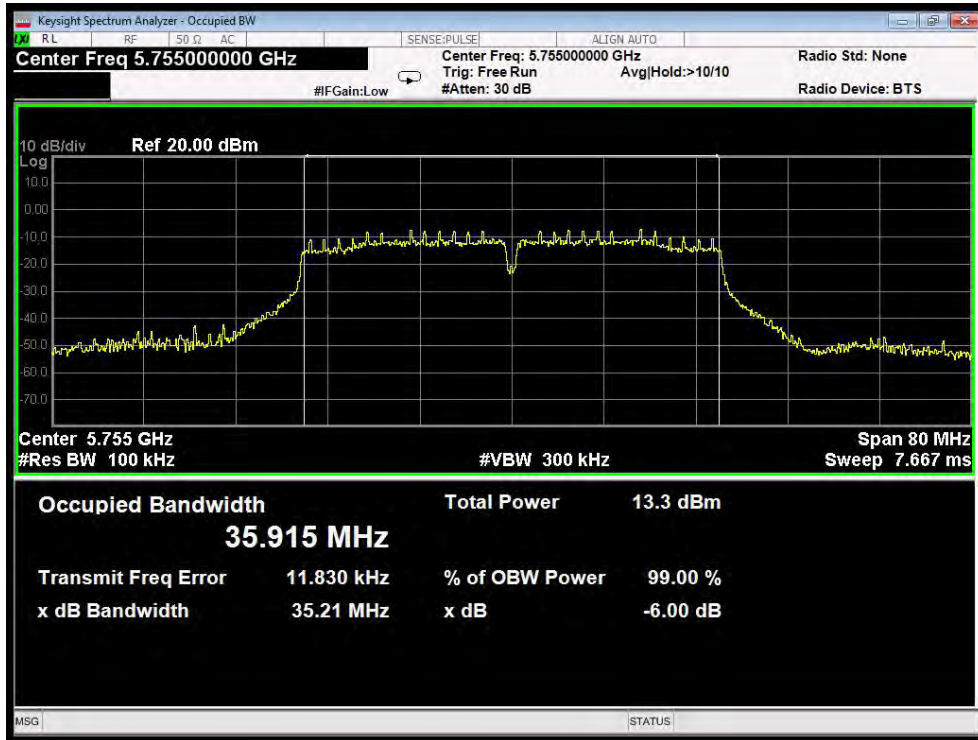

Test Mode: 802.11n40---Low

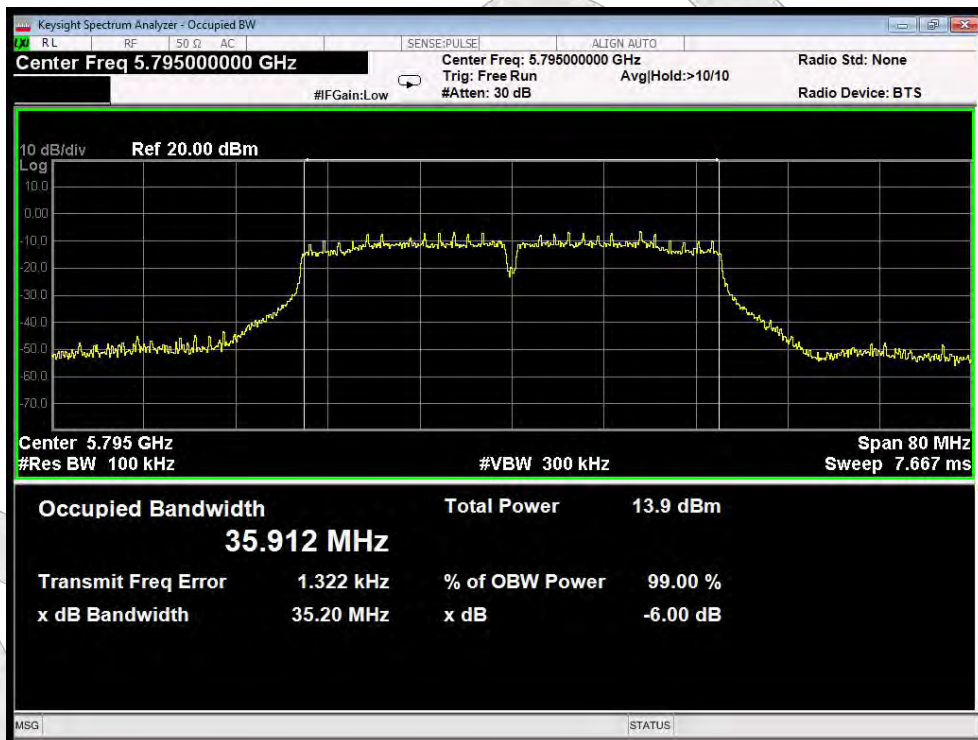

Test Mode: 802.11n40---High

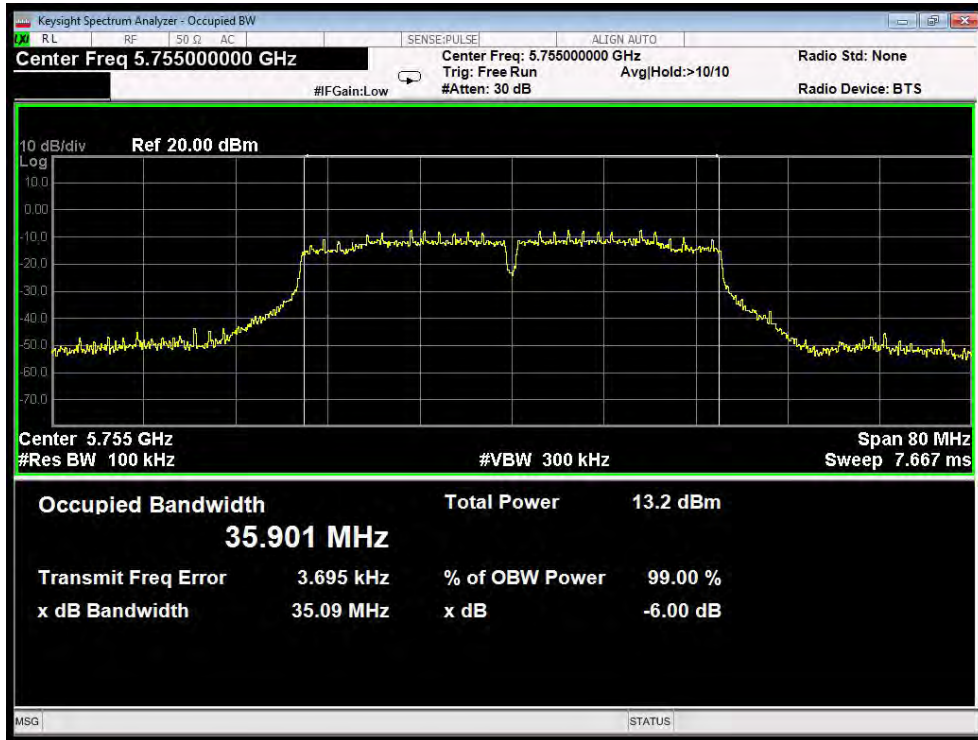

Test Mode: 802.11ac40---Low

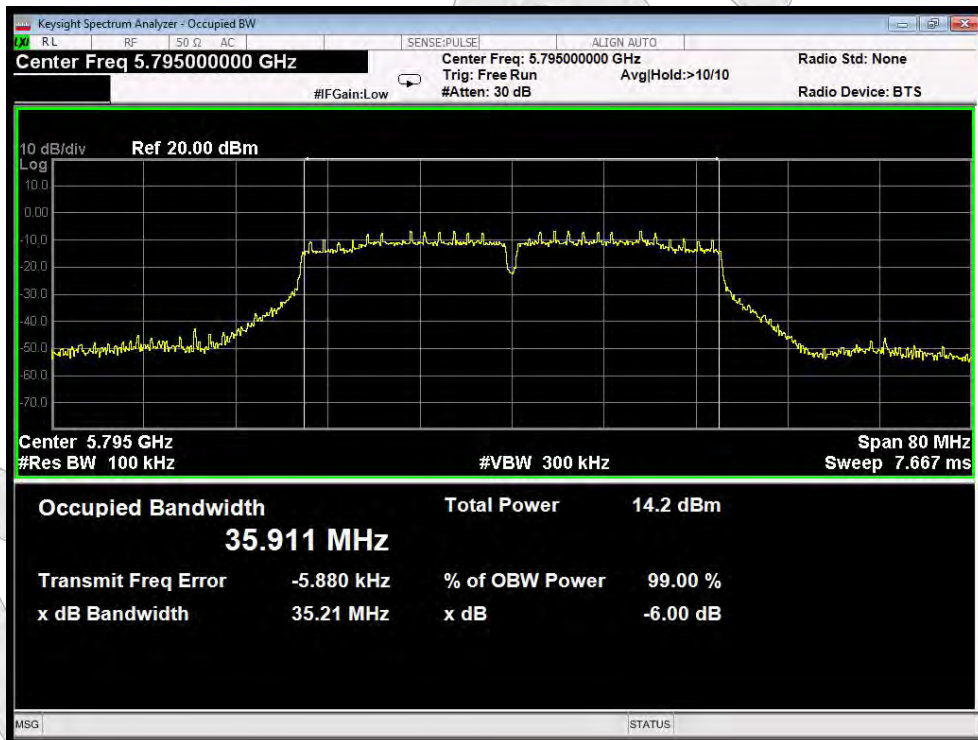

Test Mode: 802.11ac40---High

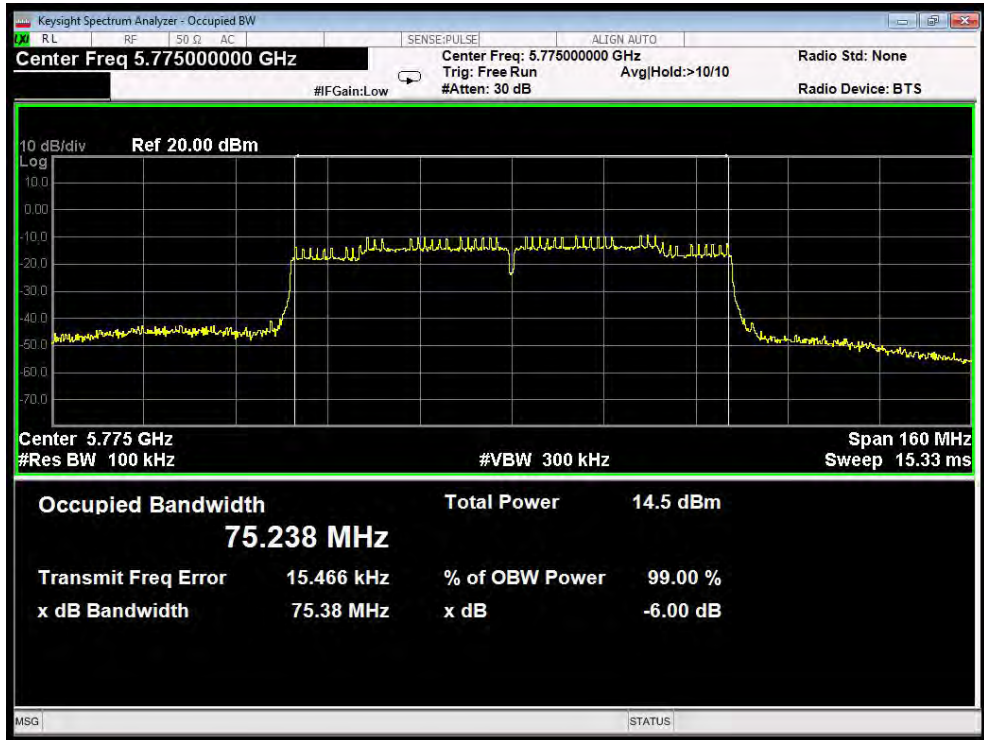

Anbotek

26dB & 99% Bandwidth

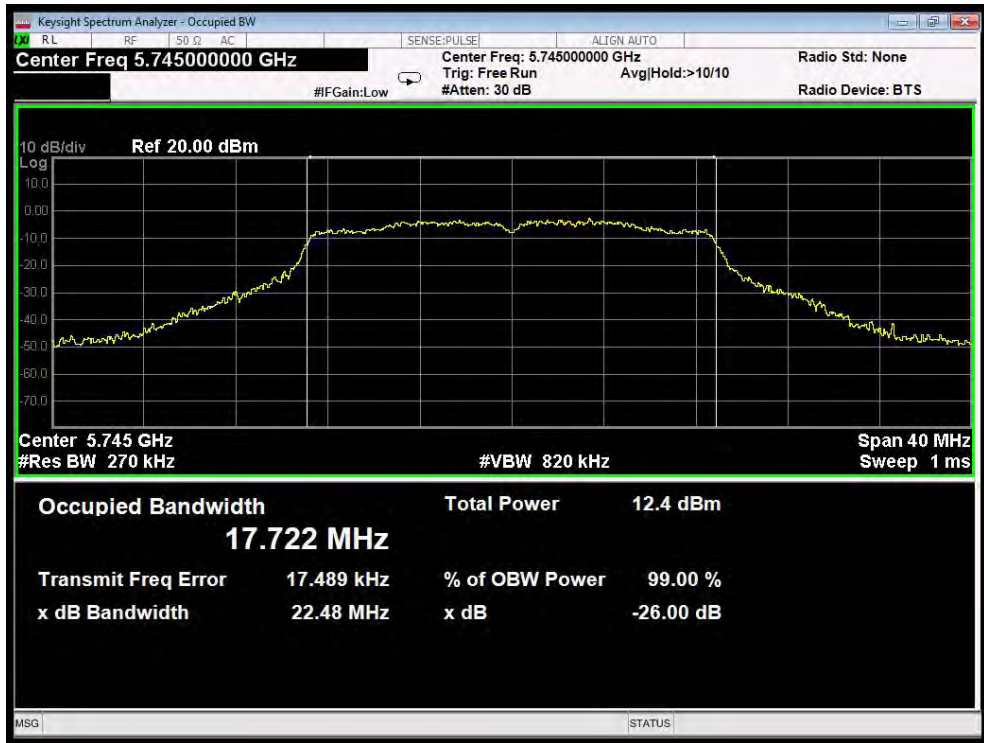

Test Mode: 802.11n20---Low

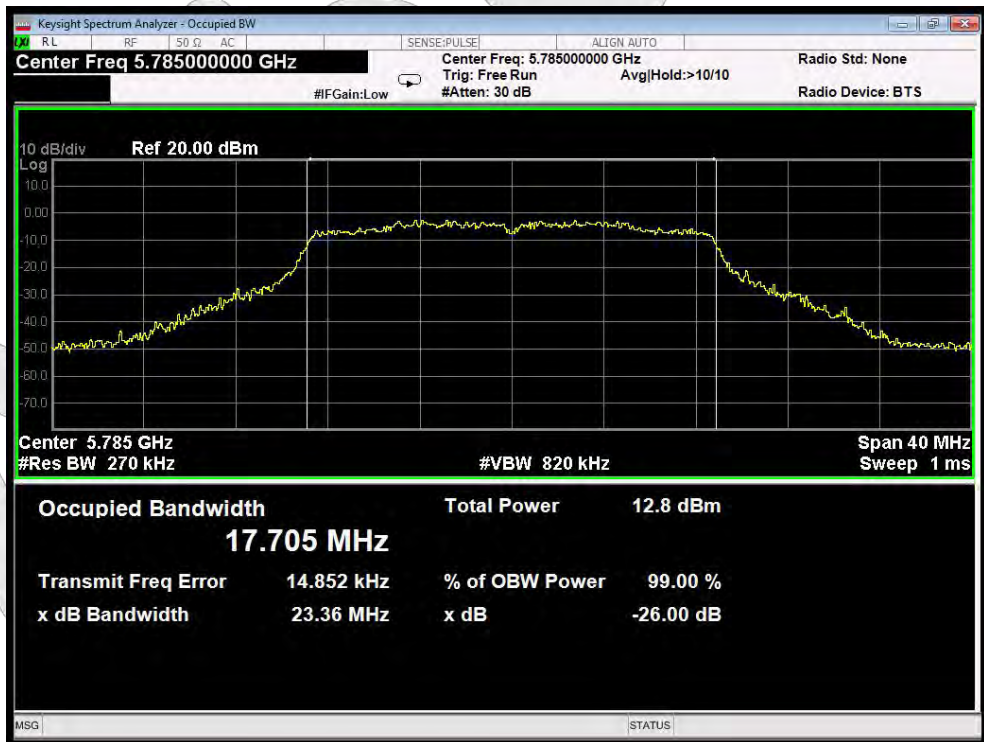

Test Mode: 802.11n20---Middle

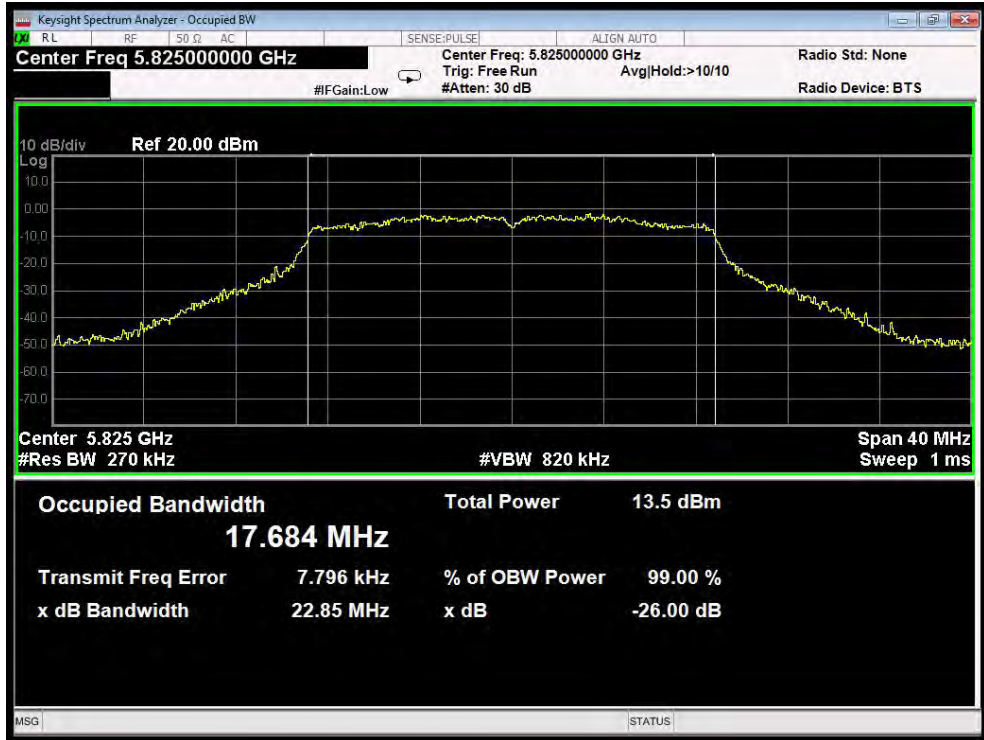

Test Mode: 802.11n20---High

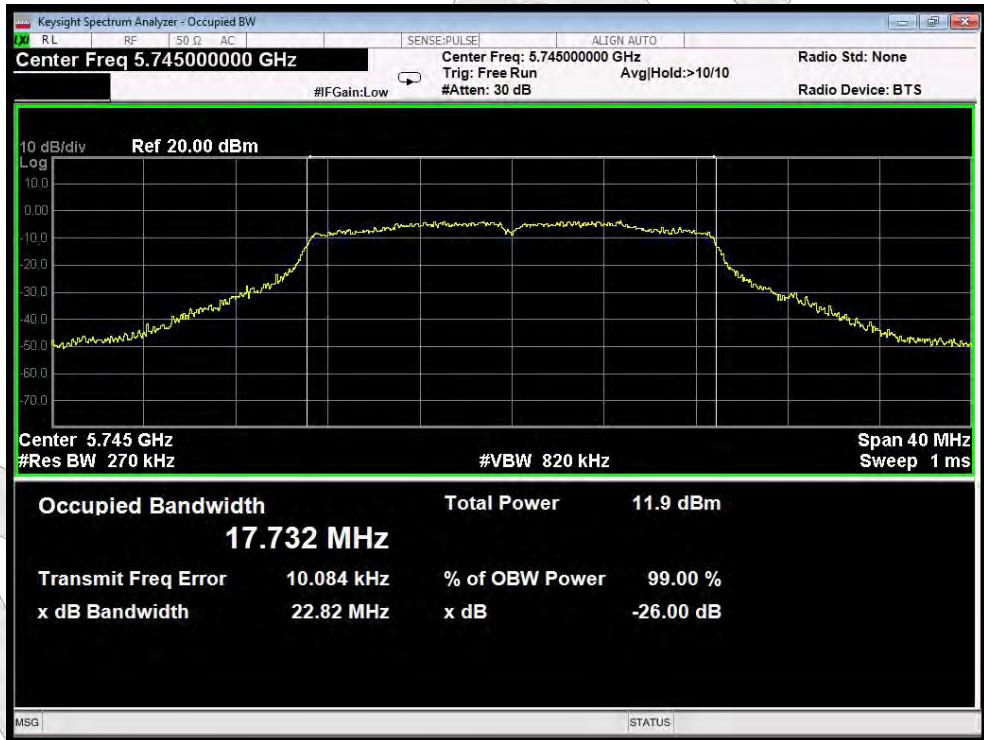

Test Mode: 802.11ac20---Low

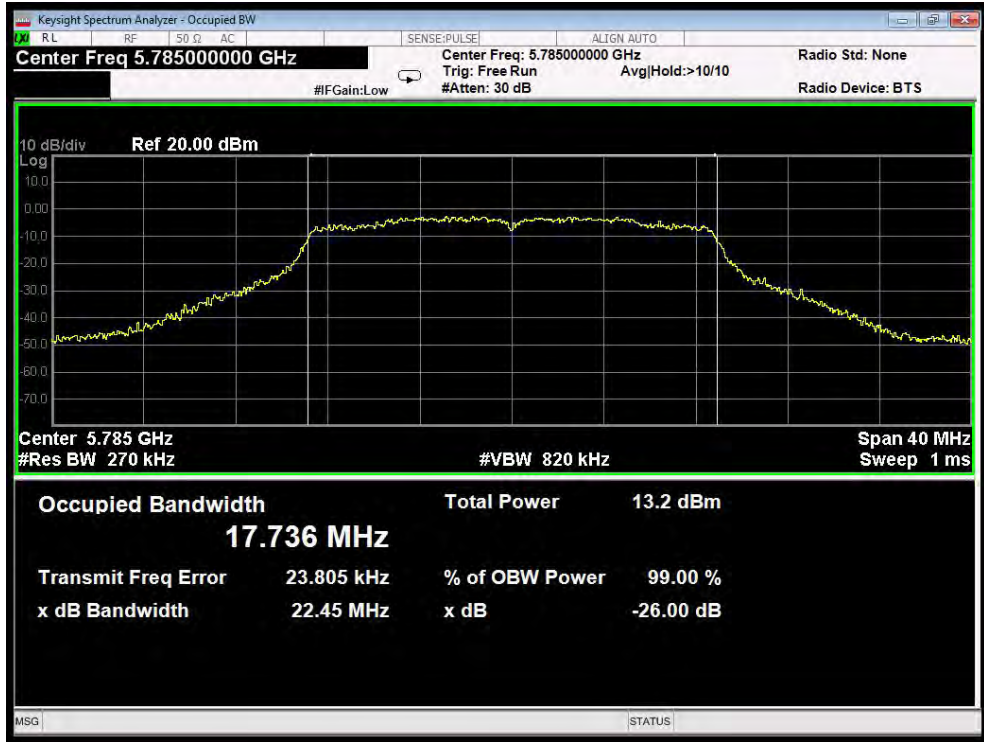

Test Mode: 802.11ac20---Middle

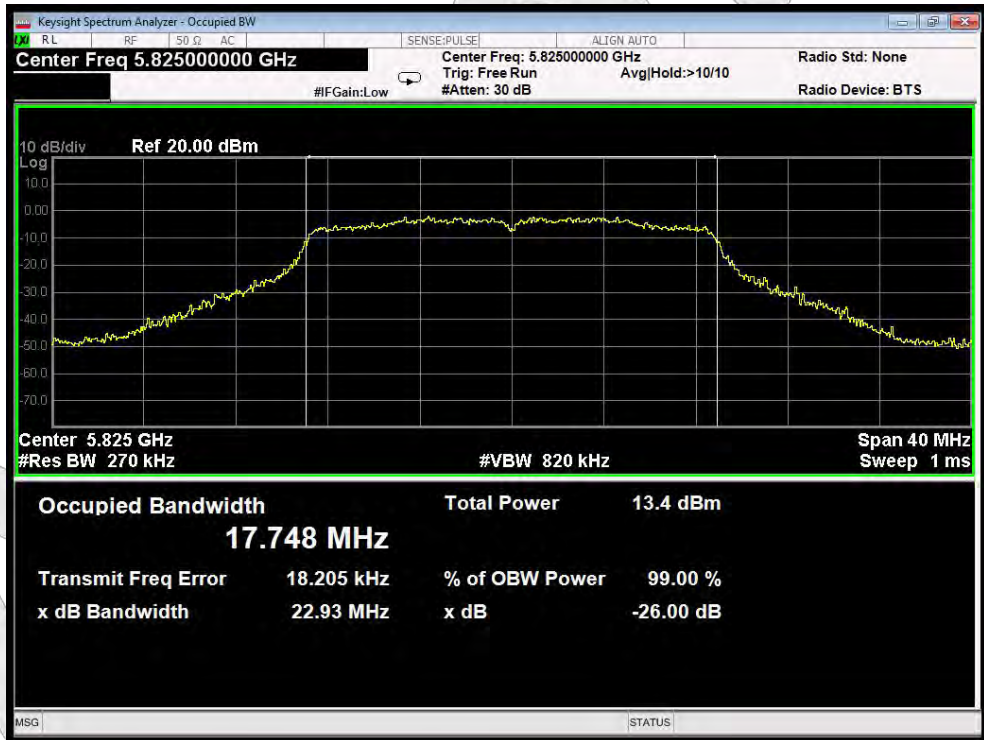

Test Mode: 802.11ac20---High

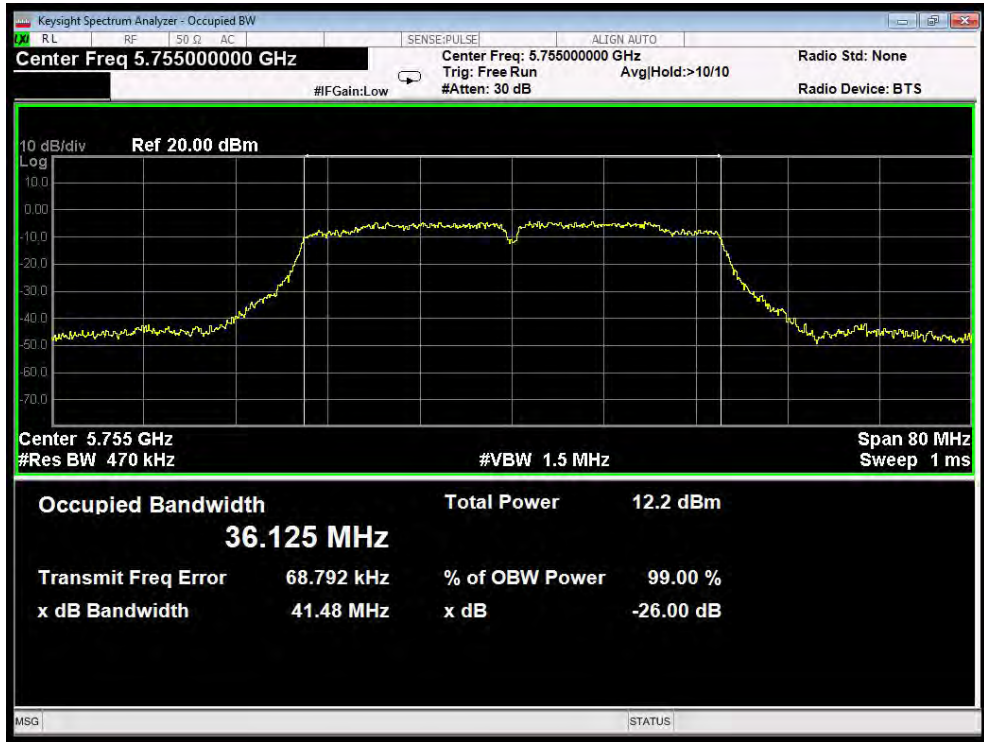

Test Mode: 802.11n40--Low

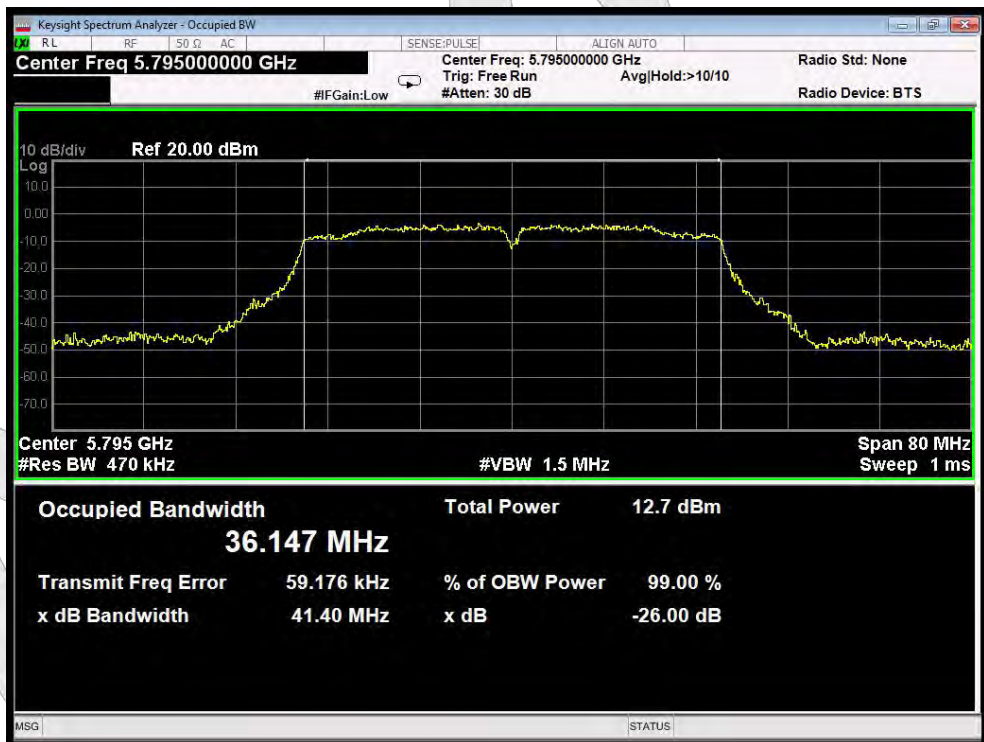

Test Mode: 802.11n40---High

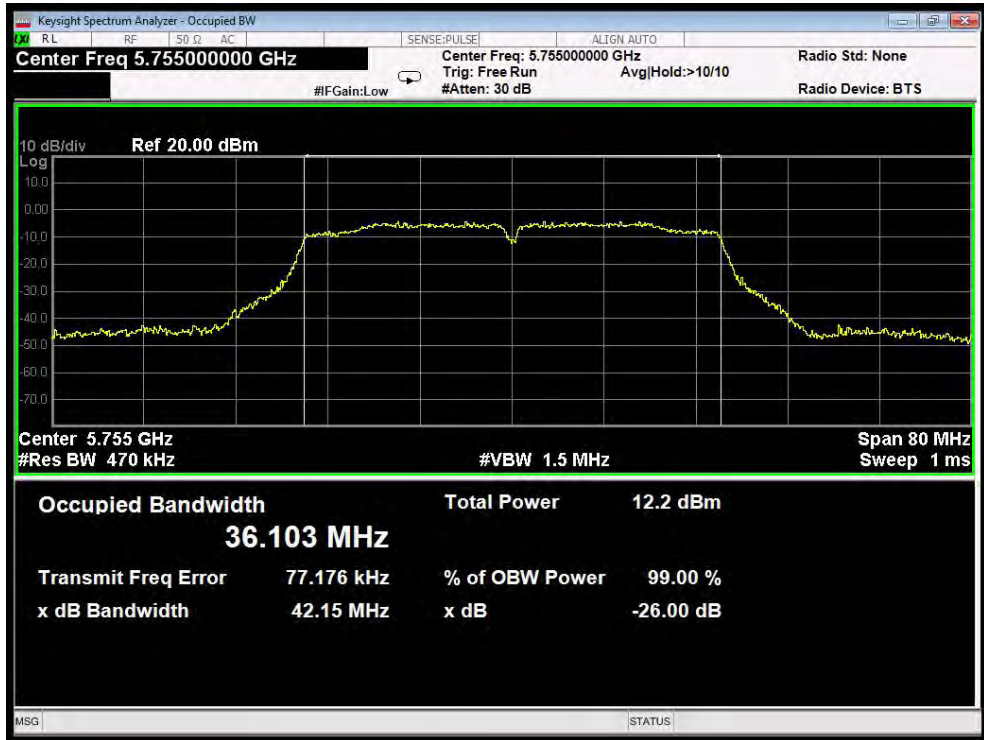

Test Mode: 802.11ac40---Low

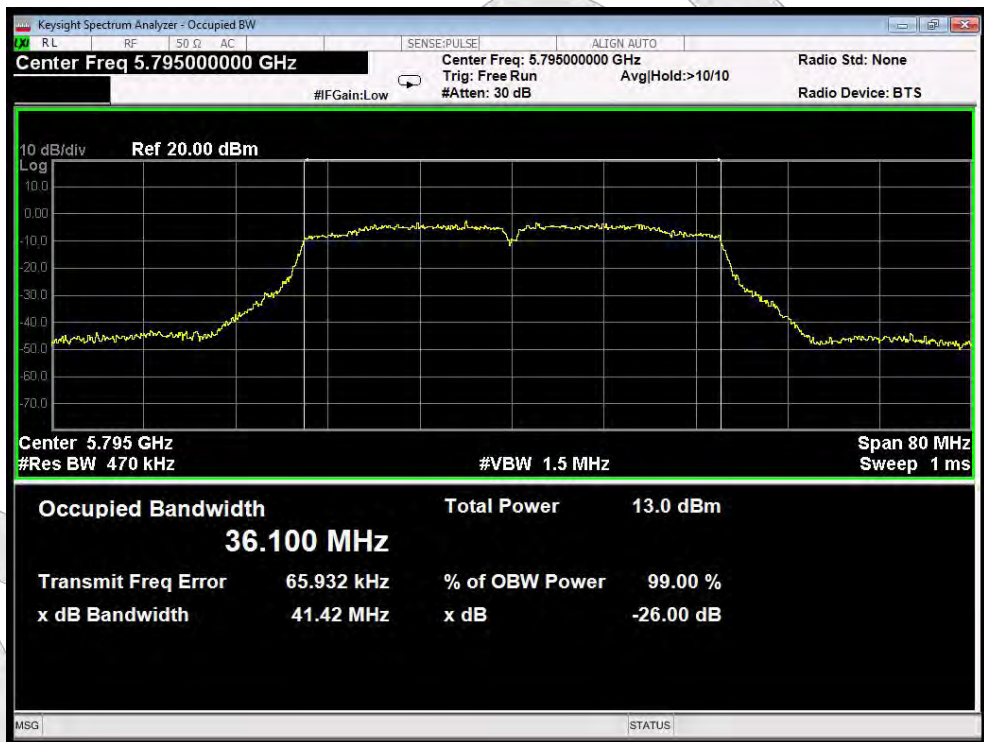

Test Mode: 802.11ac40---High

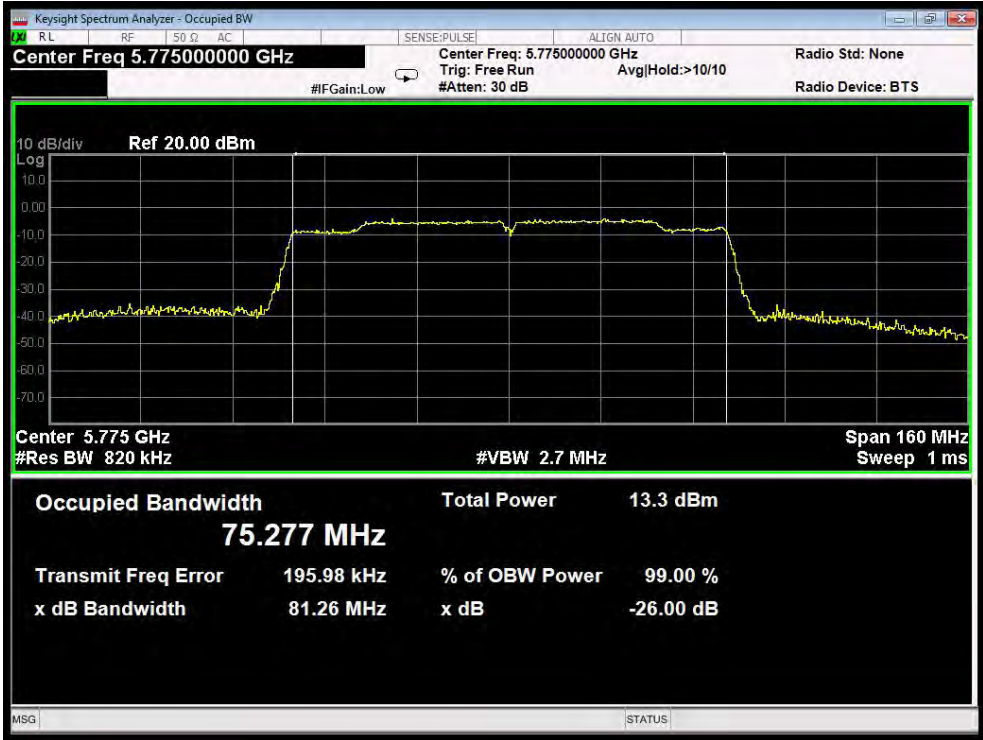

Test Mode: 802.11ac80

Anbotek

7. Power Spectral Density Test

7.1. Test Standard and Limit

Test Standard	FCC Part15 C Section 15.407 (a) (3)
Test Limit	not exceed 30dBm/500kHz

7.2. Test Setup

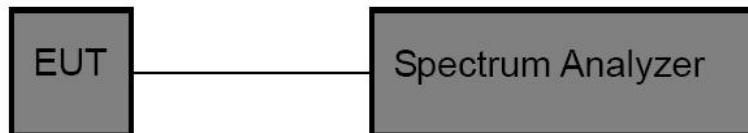

7.3. Test Procedure

For devices operating in the bands 5.15-5.25 GHz, 5.25-5.35 GHz, and 5.47-5.725 GHz, the above procedures make use of 1 MHz RBW to satisfy directly the 1 MHz reference bandwidth specified in § 15.407(a)(5). For devices operating in the band 5.725-5.85 GHz, the rules specify a measurement bandwidth of 500 kHz. Many spectrum analyzers do not have 500 kHz RBW, thus a narrower RBW may need to be used. The rules permit the use of a RBWs less than 1 MHz, or 500 kHz, "provided that the measured power is integrated over the full reference bandwidth" to show the total power over the specified measurement bandwidth (i.e., 1 MHz, or 500 kHz).

1. The EUT is directly connected to the spectrum analyzer;
2. Set RBW =510KHz;
3. Set VBW \geq 3 RBW;
3. Set the span to encompass the entire emissions bandwidth (EBW) of the signal;
5. Detector=RMS;
6. Sweep time= auto couple;
7. Trace mode=max. hold;

7.4. Test Data

Test Item	: Power Spectral Density	Test Mode	: CH Low ~ CH High
Test Voltage	: DC 5V USB Port	Temperature	: 24°C
Test Result	: PASS	Humidity	: 55%RH

Test Mode	Channel Frequency (MHz)	Final Power Spectral Density (dBm)	Correctional Limit (dBm)	Results
		ANT		
802.11n20	5745	-3.245	30.00	PASS
	5785	-2.562	30.00	PASS
	5825	-2.156	30.00	PASS
802.11ac20	5745	-3.696	30.00	PASS
	5785	-2.475	30.00	PASS
	5825	-2.053	30.00	PASS
802.11n40	5755	-6.753	30.00	PASS
	5795	-5.880	30.00	PASS
802.11ac40	5755	-6.727	30.00	PASS
	5795	-5.043	30.00	PASS
802.11ac80	5775	-8.837	30.00	PASS

Anbotek



Test Mode: 802.11n20--Low

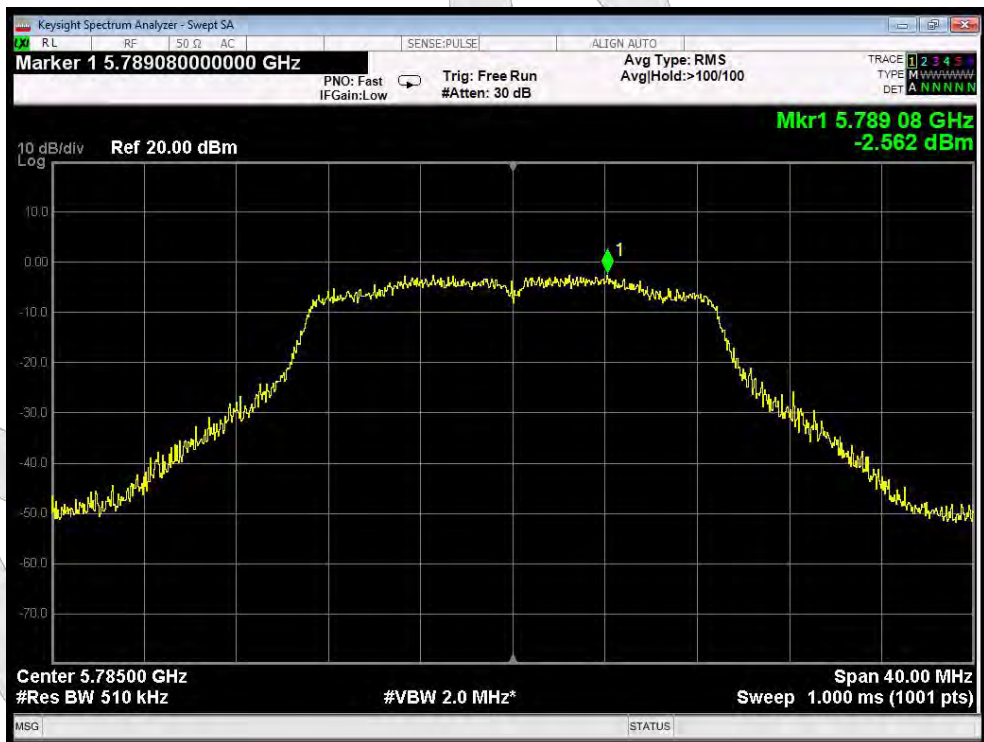

Test Mode: 802.11n20---Middle



Test Mode: 802.11n20---High

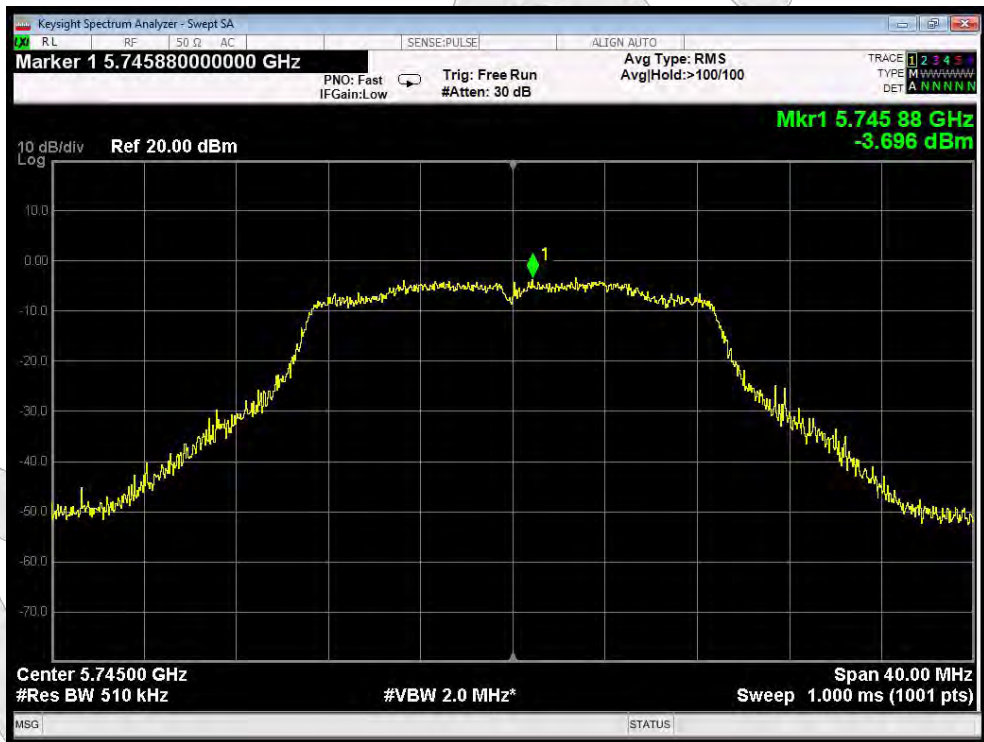

Test Mode: 802.11ac20---Low



Test Mode: 802.11ac20---Middle

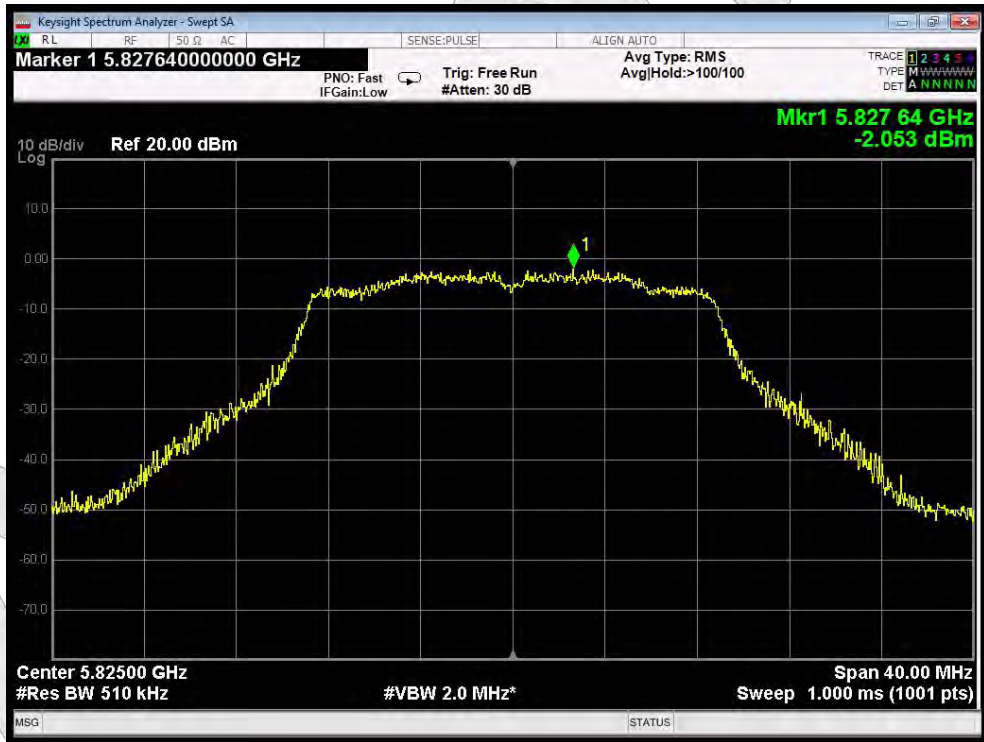

Test Mode: 802.11ac20---High

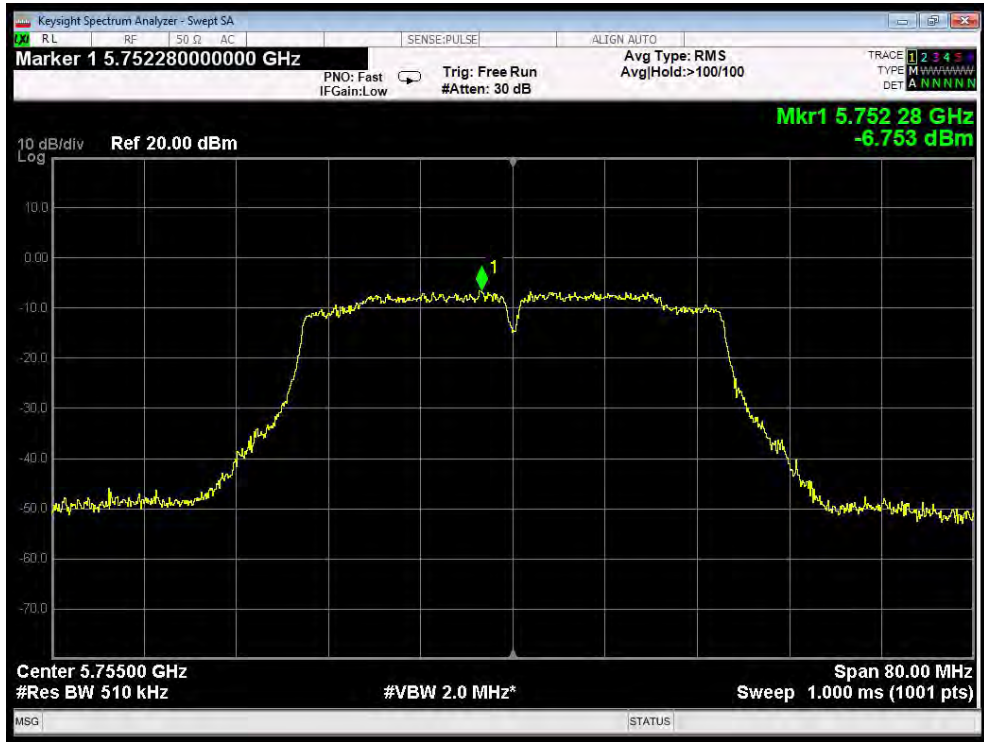

Test Mode: 802.11n40--Low

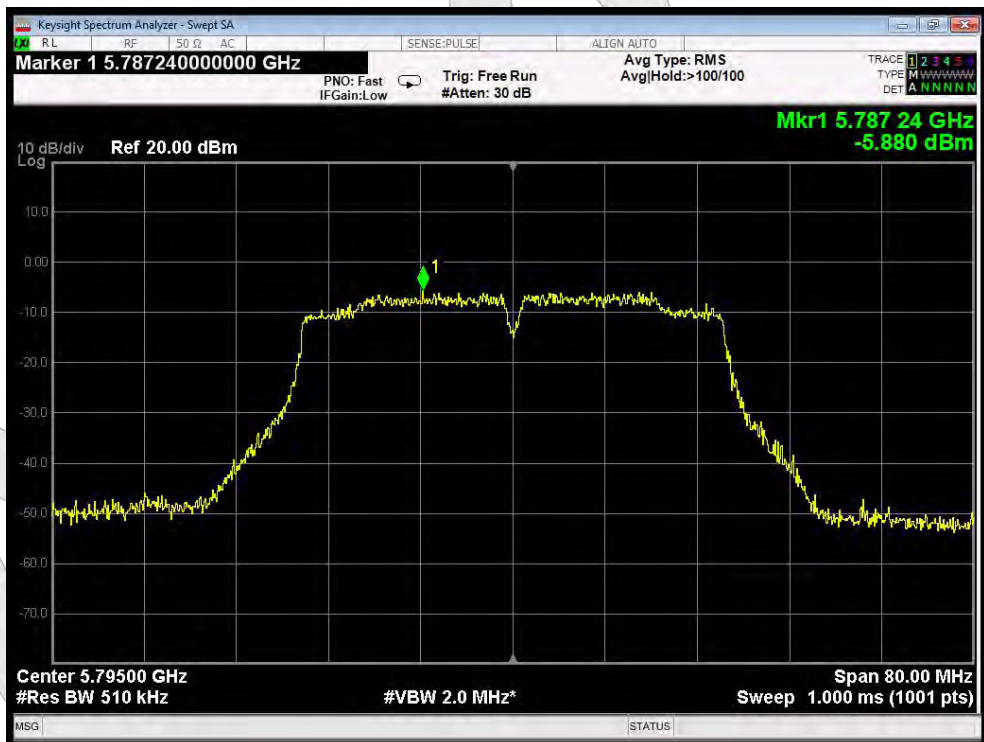

Test Mode: 802.11n40---High

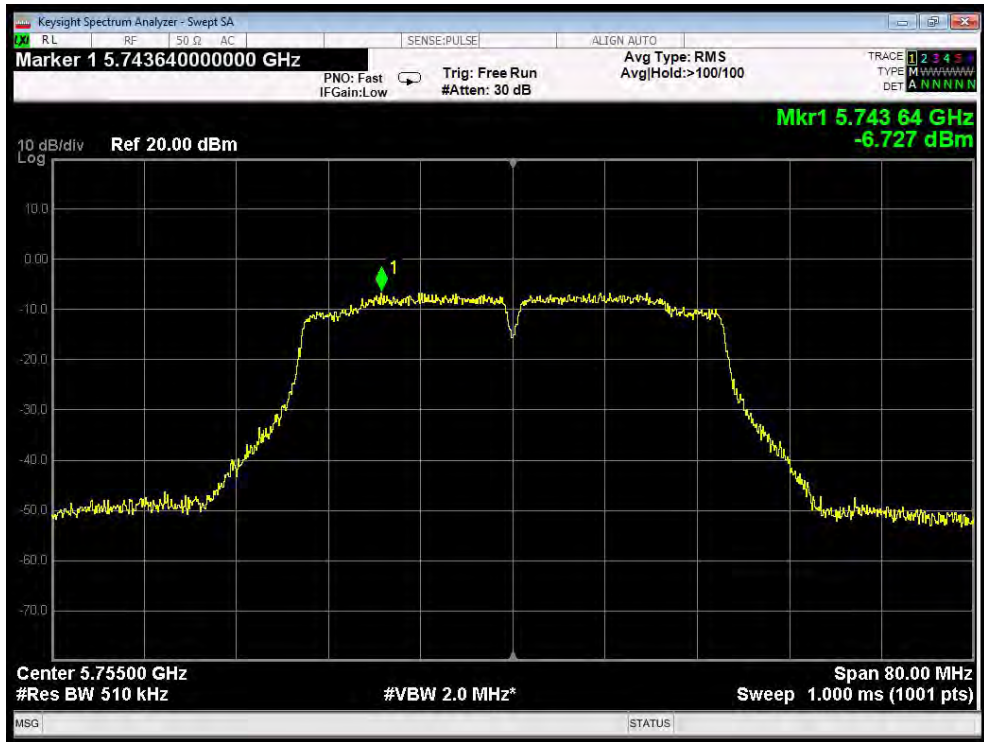

Test Mode: 802.11ac40---Low

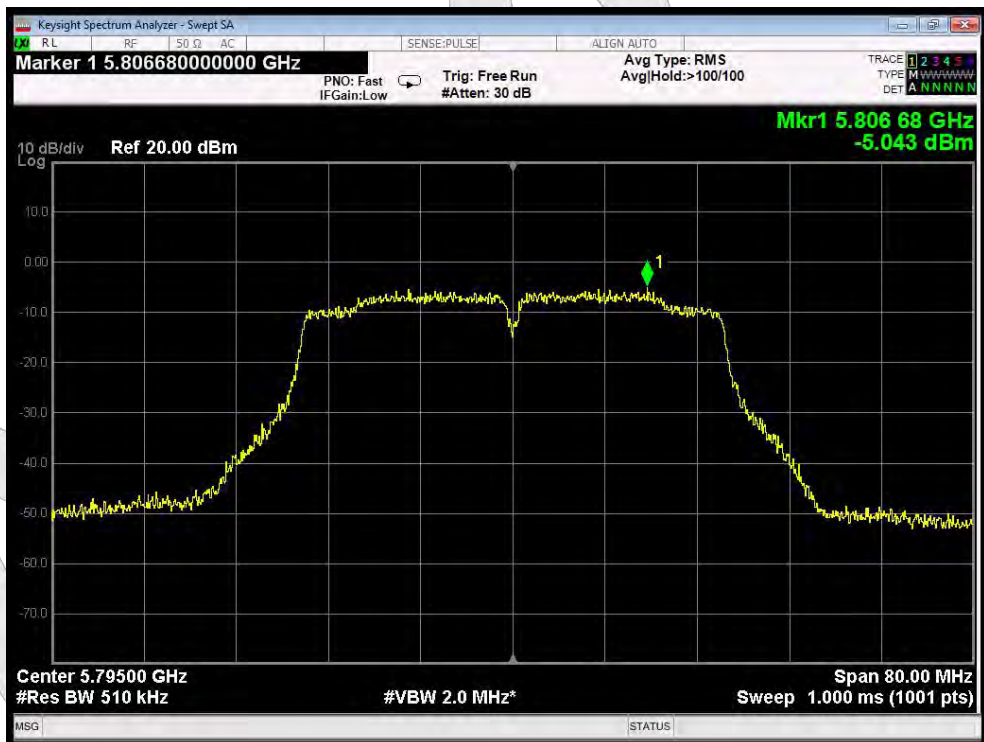

Test Mode: 802.11ac40---High

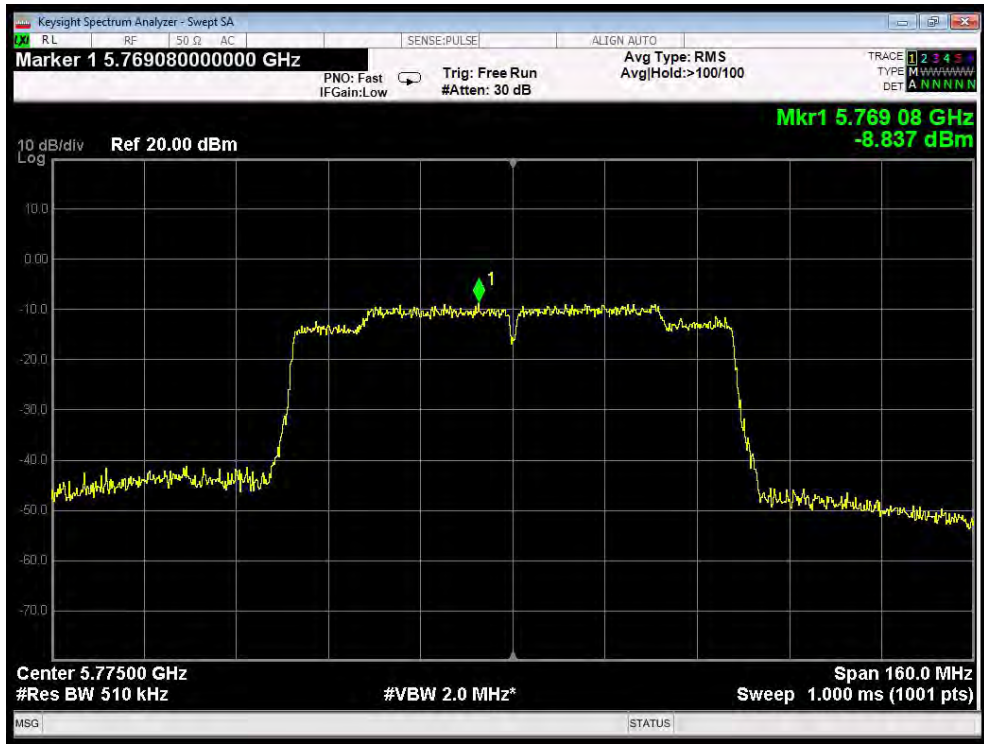

Test Mode: 802.11ac80

Anbotek

8. Antenna Requirement

8.1. Test Standard and Requirement

Test Standard	FCC Part15 Section 15.203 /15.407
Requirement	<p>1) 15.203 requirement: An intentional radiator shall be designed to ensure that no antenna other than that furnished by the responsible party shall be used with the device. The use of a permanently attached antenna or of an antenna that uses a unique coupling to the intentional radiator, the manufacturer may design the unit so that a broken antenna can be replaced by the user, but the use of a standard antenna jack or electrical connector is prohibited.</p> <p>2) 15.407 requirement: An intentional radiator shall be designed to ensure that no antenna other than that furnished by the responsible party shall be used with the device. The use of a permanently attached antenna or of an antenna that uses a unique coupling to the intentional radiator shall be considered sufficient to comply with the provisions of this section. The manufacturer may design the unit so that a broken antenna can be replaced by the user, but the use of a standard antenna jack or electrical connector is prohibited. This requirement does not apply to carrier current devices or to devices operated under the provisions of §15.211, §15.213, §15.217, §15.219, or §15.221. Further, this requirement does not apply to intentional radiators that must be professionally installed, such as perimeter protection systems and some field disturbance sensors, or to other intentional radiators which, in accordance with §15.31(d), must be measured at the installation site. However, the installer shall be responsible for ensuring that the proper antenna is employed so that the limits in this part are not exceeded.</p>

Anbotek

8.2. Antenna Connected Construction

The WIFI antenna is a PIFA Antenna which permanently attached, and the best case gain of the antenna is 3 dBi. It complies with the standard requirement.

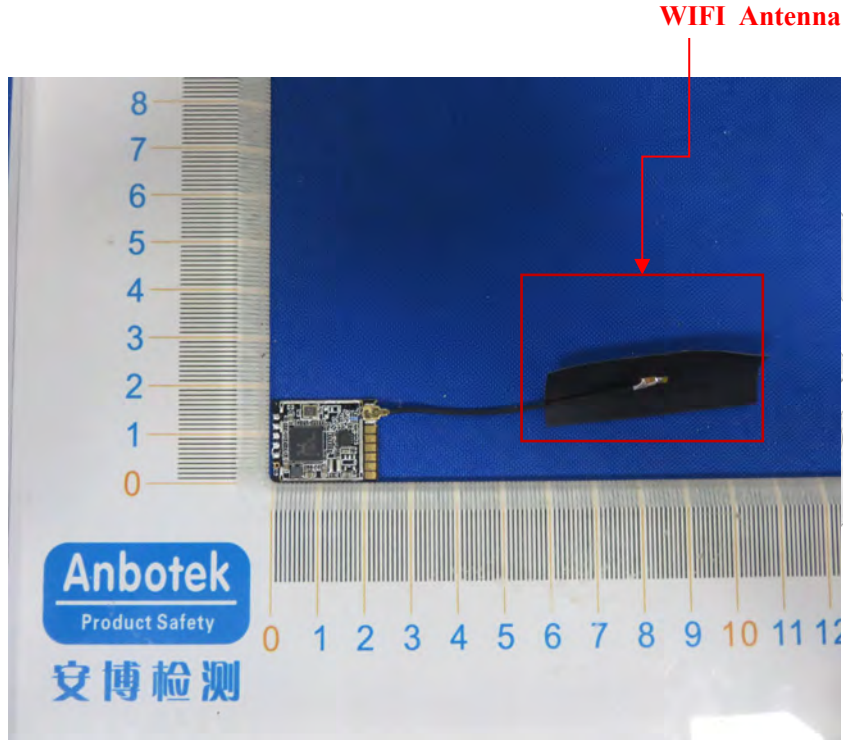

APPENDIX I -- TEST SETUP PHOTOGRAPH

Please see the test report of 0217110130W1

Anbotek

APPENDIX II -- EXTERNAL PHOTOGRAPH

Please see the test report of 0217110130W1

Anbotek

APPENDIX III -- INTERNAL PHOTOGRAPH

Please see the test report of 0217110130W1

Anbotek

End of Report