



RF TEST REPORT

Applicant Quectel Wireless Solutions Co., Ltd
FCC ID XMR201807EG95NA
Product LTE Module
Brand Quectel
Model EG95-NA
Report No. R1805A0249-R3
Issue Date July 4, 2018

TA Technology (Shanghai) Co., Ltd. tested the above equipment in accordance with the requirements in **FCC CFR47 Part 2 (2017)/ FCC CFR47 Part 27C (2017)**. The test results show that the equipment tested is capable of demonstrating compliance with the requirements as documented in this report.

Jiang peng Lan

Performed by: Jiangpeng Lan

Kai Xu

Approved by: Kai Xu

TA Technology (Shanghai) Co., Ltd.

No.145, Jintang Rd, Tangzhen Industry Park, Pudong Shanghai, China

TEL: +86-021-50791141/2/3

FAX: +86-021-50791141/2/3-8000

Table of Contents

1	Test Laboratory.....	4
1.1	Notes of the Test Report.....	4
1.2	Test facility.....	4
1.3	Testing Location.....	5
2	General Description of Equipment under Test.....	6
3	Applied Standards.....	7
4	Test Configuration.....	8
5	Test Case Results.....	10
5.1	RF Power Output.....	10
5.2	Effective Isotropic Radiated Power.....	17
5.3	Occupied Bandwidth.....	23
5.4	Band Edge Compliance.....	40
5.5	Peak-to-Average Power Ratio (PAPR).....	66
5.6	Frequency Stability.....	70
5.7	Spurious Emissions at Antenna Terminals.....	75
5.8	Radiates Spurious Emission.....	94
6	Main Test Instruments.....	111
ANNEX A:	EUT Appearance and Test Setup.....	112
A.1	EUT Appearance.....	112
A.2	Test Setup.....	114

Summary of Measurement Results

Number	Test Case	Clause in FCC rules	Verdict
1	RF power output	2.1046	PASS
2	Effective Isotropic Radiated power	27.50(d)(4)/27.50(b)(10)/27.50(c)(10)	PASS
3	Occupied Bandwidth	2.1049	PASS
4	Band Edge Compliance	27.53(h)/27.53(g)/27.53(f) /27.53(c)	PASS
5	Peak-to-Average Power Ratio	27.50(d)/KDB971168 D01(5.7)	PASS
6	Frequency Stability	2.1055 / 27.54	PASS
7	Spurious Emissions at Antenna Terminals	2.1051/27.53(h)/27.53(g)/27.53(f)	PASS
8	Radiates Spurious Emission	2.1051/27.53(h) /27.53(g) /27.53(f)	PASS
Date of Testing: May 25, 2018 ~ June 27, 2018			
Note: PASS: The EUT complies with the essential requirements in the standard. FAIL: The EUT does not comply with the essential requirements in the standard.			

1 Test Laboratory

1.1 Notes of the Test Report

This report shall not be reproduced in full or partial, without the written approval of **TA technology (shanghai) co., Ltd.** The results documented in this report apply only to the tested sample, under the conditions and modes of operation as described herein .Measurement Uncertainties were not taken into account and are published for informational purposes only. This report is written to support regulatory compliance of the applicable standards stated above.

1.2 Test facility

CNAS (accreditation number: L2264)

TA Technology (Shanghai) Co., Ltd. has obtained the accreditation of China National Accreditation Service for Conformity Assessment (CNAS).

FCC (Designation number: CN1179, Test Firm Registration Number: 446626)

TA Technology (Shanghai) Co., Ltd. has been listed on the US Federal Communications Commission list of test facilities recognized to perform electromagnetic emissions measurements.

IC (recognition number is 8510A)

TA Technology (Shanghai) Co., Ltd. has been listed by industry Canada to perform electromagnetic emission measurement.

VCCI (recognition number is C-4595, T-2154, R-4113, G-10766)

TA Technology (Shanghai) Co., Ltd. has been listed by industry Japan to perform electromagnetic emission measurement.

A2LA (Certificate Number: 3857.01)

TA Technology (Shanghai) Co., Ltd. has been listed by American Association for Laboratory Accreditation to perform electromagnetic emission measurement.

1.3 Testing Location

Company: TA Technology (Shanghai) Co., Ltd.
Address: No.145, Jintang Rd, Tangzhen Industry Park, Pudong Shanghai, China
City: Shanghai
Post code: 201201
Country: P. R. China
Contact: Xu Kai
Telephone: +86-021-50791141/2/3
Fax: +86-021-50791141/2/3-8000
Website: <http://www.ta-shanghai.com>
E-mail: xukai@ta-shanghai.com

2 General Description of Equipment under Test

Client Information

Applicant	Quectel Wireless Solutions Co., Ltd
Applicant address	7th Floor, Hongye Building, No.1801 Hongmei Road, Xuhui District, Shanghai 200233, China
Manufacturer	Quectel Wireless Solutions Co., Ltd
Manufacturer address	7th Floor, Hongye Building, No.1801 Hongmei Road, Xuhui District, Shanghai 200233, China

General information

EUT Description			
Model	EG95-NA		
IMEI	869394030001009		
Hardware Version	R1.0		
Software Version	EG95NAFBR05A03M4G		
Power Supply	External Power Supply		
Antenna Type	The EUT don't have standard Antenna, The Antenna used for testing in this report is the after-market accessory (Dipole Antenna)		
Test Mode(s)	WCDMA Band IV; LTE Band 4; LTE Band 12, LTE Band 13;		
Test Modulation	(WCDMA)QPSK; (LTE)QPSK 16QAM;		
HSDPA UE Category	24		
HSUPA UE Category	6		
DC-HSDPA UE Category	24		
LTE Category	4		
Maximum E.I.R.P./ E.R.P.	WCDMA Band IV:	25.63dBm	
	LTE Band 4:	25.14dBm	
	LTE Band 12:	19.7dBm	
	LTE Band 13:	22.41Bm	
Rated Power Supply Voltage:	3.8V		
Extreme Voltage	Minimum: 3.3V Maximum: 4.3V		
Extreme Temperature	Lowest: -40°C Highest: +85°C		
Operating Frequency Range(s)	Mode	Tx (MHz)	Rx (MHz)
	WCDMA Band IV	1710 ~ 1755	2110 ~ 2155
	LTE Band 4	1710 ~ 1755	2110 ~ 2155
	LTE Band 12	699 ~ 716	729 ~ 746
	LTE Band 13	777 ~ 787	746 ~ 756
Note: 1. The information of the EUT is declared by the manufacturer.			

3 Applied Standards

According to the specifications of the manufacturer, it must comply with the requirements of the following standards:

Test standards

FCC CFR47 Part 2 (2017)

FCC CFR47 Part 27C (2017)

ANSI/TIA-603-E (2016)

KDB 971168 D01 Power Meas License Digital Systems v03r01

4 Test Configuration

Radiated measurements are performed by rotating the EUT in three different orthogonal test planes. EUT stand-up position (Z axis), lie-down position (X, Y axis). Receiver antenna polarization (horizontal and vertical), the worst emission was found in position (Z axis, horizontal position) and the worst case was recorded.

All mode and data rates and positions and RB size and modulations were investigated. Subsequently, only the worst case emissions are reported.

The following testing in WCDMA/LTE is set based on the maximum RF Output Power.

The following testing in different Bandwidth is set to detail in the following table:

Test modes are chosen to be reported as the worst case configuration below for WCDMA Band IV:

	Test items	Modes/Modulation
		WCDMA Band IV
Conducted Test cases	RF power output	RMC HSDPA/HSUPA DC-HSDPA
	Occupied Bandwidth	RMC
	Band Edge Compliance	RMC
	Peak-to-Average Power Ratio	RMC
	Frequency Stability	RMC
	Spurious Emissions at Antenna Terminals	RMC
Radiated Test cases	Effective Isotropic Radiated power	RMC
	Radiates Spurious Emission	RMC

Test modes are chosen to be reported as the worst case configuration below for LTE Band 4/12/13:

Test items	Modes	Bandwidth (MHz)						Modulation		RB			Test Channel		
		1.4	3	5	10	15	20	QPSK	16QAM	1	50%	100%	L	M	H
RF power output	LTE 4	O	O	O	O	O	O	O	O	O	O	O	O	O	O
	LTE 12	O	O	O	O	-	-	O	O	O	O	O	O	O	O
	LTE 13	-	-	O	O	-	-	O	O	O	O	O	O	O	O
Effective Isotropic Radiated power	LTE 4	O	O	O	O	O	O	O	O	O	O	O	O	O	O
	LTE 12	O	O	O	O	-	-	O	O	O	O	O	O	O	O
	LTE 13	-	-	O	O	-	-	O	O	O	O	O	O	O	O
Occupied Bandwidth	LTE 4	O	O	O	O	O	O	O	O	-	-	O	O	O	O
	LTE 12	O	O	O	O	-	-	O	O	-	-	O	O	O	O
	LTE 13	-	-	O	O	-	-	O	O	-	-	O	O	O	O
Band Edge Compliance	LTE 4	O	O	O	O	O	O	O	O	O	-	O	O	-	O
	LTE 12	O	O	O	O	-	-	O	O	O	-	O	O	-	O
	LTE 13	-	-	O	O	-	-	O	O	O	-	O	O	-	O
Peak-to-Average Power Ratio	LTE 4	O	O	O	O	O	O	O	O	-	-	O	O	O	O
	LTE 12	O	O	O	O	-	-	O	O	-	-	O	O	O	O
	LTE 13	-	-	O	O	-	-	O	O	-	-	O	O	O	O
Frequency Stability	LTE 4	O	O	O	O	O	O	O	O	-	-	O	O	-	O
	LTE 12	O	O	O	O	-	-	O	O	-	-	O	O	-	O
	LTE 13	-	-	O	O	-	-	O	O	-	-	O	O	-	O
Spurious Emissions at Antenna Terminals	LTE 4	O	O	O	O	O	O	O	-	O	-	-	O	O	O
	LTE 12	O	O	O	O	-	-	O	-	O	-	-	O	O	O
	LTE 13	-	-	O	O	-	-	O	-	O	-	-	O	O	O
Radiates Spurious Emission	LTE 4	O	-	O	-	-	O	O	-	O	-	-	O	O	O
	LTE 12	O	-	O	O	-	-	O	-	O	-	-	O	O	O
	LTE 13	-	-	O	O	-	-	O	-	O	-	-	O	O	O
Note	1. The mark "O" means that this configuration is chosen for testing. 2. The mark "-" means that this configuration is not testing.														

5 Test Case Results

5.1 RF Power Output

Ambient condition

Temperature	Relative humidity	Pressure
23°C ~25°C	45%~50%	101.5kPa

Methods of Measurement

During the process of the testing, The EUT is controlled by the Base Station Simulator to ensure max power transmission and proper modulation.

Test Setup

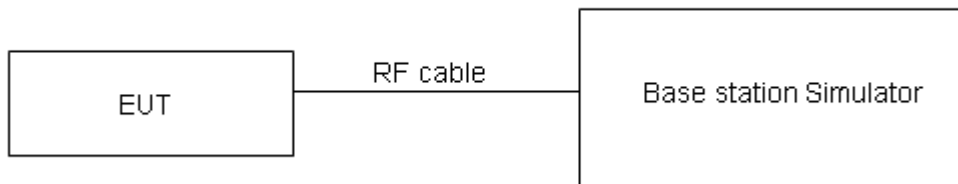

The loss between RF output port of the EUT and the input port of the tester has been taken into consideration.

Limits

No specific RF power output requirements in part 2.1046.

Measurement Uncertainty

The assessed measurement uncertainty to ensure 95% confidence level for the normal distribution is with the coverage factor $k = 2$, $U=0.4$ dB.

Test Results

WCDMA Band IV		AV Conducted Power(dBm)		
		Channel 1312	Channel 1413	Channel 1513
		1712.4 (MHz)	1732.6 (MHz)	1752.6(MHz)
RMC	12.2k	23.56	23.56	23.50
	64k	23.42	23.50	23.37
	144k	23.41	23.40	23.36
	384k	23.40	23.39	23.35
HSDPA	Sub - Test 1	22.76	22.81	22.71
	Sub - Test 2	22.86	22.77	22.73
	Sub - Test 3	22.85	22.77	22.72
	Sub - Test 4	22.85	22.78	22.68
HSUPA	Sub - Test 1	23.20	23.11	23.07
	Sub - Test 2	23.24	23.21	23.16
	Sub - Test 3	23.24	23.20	23.16
	Sub - Test 4	22.78	22.73	22.78
	Sub - Test 5	22.86	22.69	22.67
DC-HSDPA	Sub - Test 1	23.43	23.43	23.37
	Sub - Test 2	23.41	23.42	23.36
	Sub - Test 3	22.90	22.91	22.85
	Sub - Test 4	22.89	22.90	22.84

LTE Band 4				AV Conducted Power(dBm)		
Bandwidth	Modulation	RB size	RB offset	Channel/Frequency (MHz)		
				19957/1710.7	20175/1732.5	20393/1754.3
1.4MHz	QPSK	1	0	23.76	24.02	23.83
		1	2	23.56	23.92	23.99
		1	5	24.00	23.83	23.91
		3	0	23.82	23.68	23.89
		3	2	23.74	23.83	23.69
		3	3	23.89	23.86	23.75
		6	0	22.70	22.91	22.91
	16QAM	1	0	23.56	22.91	23.49
		1	2	23.60	22.88	23.32
		1	5	23.78	22.87	23.56
		3	0	22.60	22.68	22.92
		3	2	22.65	22.78	22.92
		3	3	22.71	22.89	22.83
		6	0	21.86	21.88	21.97
Bandwidth	Modulation	RB size	RB offset	Channel/Frequency (MHz)		
				19965/1711.5	20175/1732.5	20385/1753.5
3MHz	QPSK	1	0	23.78	24.06	23.86
		1	7	23.59	23.97	24.03
		1	14	24.03	23.88	23.95
		8	0	22.92	22.80	23.02
		8	4	22.86	22.93	22.81
		8	7	22.99	22.97	22.85
		15	0	22.73	22.95	22.94
	16QAM	1	0	23.59	22.93	23.52
		1	7	23.63	22.93	23.36
		1	14	23.80	22.91	23.59
		8	0	21.71	21.81	22.04
		8	4	21.76	21.91	22.04
		8	7	21.81	22.01	21.96
		15	0	21.89	21.92	22.00
Bandwidth	Modulation	RB size	RB offset	Channel/Frequency (MHz)		
				19975/1712.5	20175/1732.5	20375/1752.5
5MHz	QPSK	1	0	23.75	24.04	23.82
		1	13	23.57	23.93	24.00
		1	24	24.00	23.83	23.91
		12	0	22.89	22.75	22.98
		12	6	22.84	22.89	22.76
		12	13	22.97	22.95	22.81
		25	0	22.71	22.94	22.92



Bandwidth	Modulation	RB size	RB offset	Channel/Frequency (MHz)		
				20000/1715	20175/1732.5	20350/1750
	16QAM	1	0	23.56	22.89	23.49
		1	13	23.60	22.91	23.33
		1	24	23.77	22.89	23.55
		12	0	21.69	21.77	22.01
		12	6	21.73	21.86	22.00
		12	13	21.78	21.96	21.92
		25	0	21.87	21.88	21.95
Bandwidth	Modulation	RB size	RB offset	Channel/Frequency (MHz)		
				20025/1717.5	20175/1732.5	20325/1747.5
10MHz	QPSK	1	0	23.77	24.05	23.85
		1	25	23.60	23.98	24.04
		1	49	24.02	23.87	23.94
		25	0	22.92	22.80	23.02
		25	13	22.87	22.94	22.80
		25	25	22.99	22.99	22.86
		50	0	22.79	22.96	22.96
	16QAM	1	0	23.58	22.92	23.51
		1	25	23.63	22.95	23.36
		1	49	23.80	22.91	23.58
		25	0	21.72	21.82	22.05
		25	13	21.75	21.90	22.03
		25	25	21.81	22.01	21.96
		50	0	21.90	21.93	21.99
Bandwidth	Modulation	RB size	RB offset	Channel/Frequency (MHz)		
				20050/1720	20175/1732.5	20300/1745
15MHz	QPSK	1	0	23.76	24.01	23.83
		1	38	23.58	23.97	24.01
		1	74	23.99	23.82	23.90
		36	0	22.90	22.76	22.99
		36	18	22.84	22.89	22.76
		36	39	22.96	22.96	22.82
		75	0	22.77	22.92	22.91
	16QAM	1	0	23.53	22.90	23.49
		1	38	23.61	22.92	23.34
		1	74	23.77	22.87	23.55
		36	0	21.69	21.80	22.02
		36	18	21.72	21.85	21.99
		36	39	21.79	21.97	21.93
		75	0	21.87	21.88	21.95
Bandwidth	Modulation	RB size	RB offset	Channel/Frequency (MHz)		
				20050/1720	20175/1732.5	20300/1745
20MHz	QPSK	1	0	23.73	23.97	23.80
		1	50	23.57	23.93	23.99



		1	99	23.97	23.81	23.87
		50	0	22.87	22.71	22.95
		50	25	22.82	22.85	22.73
		50	50	22.93	22.91	22.78
		100	0	22.74	22.87	22.87
	16QAM	1	0	23.51	22.86	23.44
		1	50	23.57	22.90	23.30
		1	99	23.75	22.84	23.53
		50	0	21.66	21.76	21.99
		50	25	21.69	21.83	21.96
		50	50	21.76	21.92	21.89
		100	0	21.85	21.84	21.92

LTE Band 12				AV Conducted Power(dBm)		
Bandwidth	Modulation	RB size	RB offset	Channel/Frequency (MHz)		
				23017/699.7	23095/707.5	23173/715.3
1.4MHz	QPSK	1	0	23.32	23.88	23.58
		1	2	23.55	23.70	23.50
		1	5	23.52	23.31	23.50
		3	0	23.62	23.54	23.59
		3	2	23.81	23.61	23.51
		3	3	23.57	23.51	23.66
	16QAM	6	0	22.54	22.53	22.65
		1	0	22.53	22.31	23.13
		1	2	23.19	22.33	23.60
		1	5	22.70	22.19	22.81
		3	0	22.53	22.59	22.69
		3	2	22.70	22.57	22.78
		3	3	22.57	22.51	22.80
		6	0	21.44	21.60	21.69
Bandwidth	Modulation	RB size	RB offset	Channel/Frequency (MHz)		
				23025/700.5	23095/707.5	23165/714.5
3MHz	QPSK	1	0	23.33	23.91	23.60
		1	7	23.59	23.76	23.55
		1	14	23.54	23.35	23.53
		8	0	22.72	22.66	22.72
		8	4	22.94	22.72	22.62
		8	7	22.67	22.64	22.77
		15	0	22.63	22.58	22.70
	16QAM	1	0	22.55	22.32	23.15
		1	7	23.22	22.40	23.64



Bandwidth	Modulation	RB size	RB offset	Channel/Frequency (MHz)		
				23035/701.5	23095/707.5	23155/713.5
		1	14	22.72	22.23	22.83
		8	0	21.65	21.73	21.82
		8	4	21.80	21.69	21.89
		8	7	21.67	21.63	21.93
		15	0	21.48	21.65	21.71
5MHz	QPSK	1	0	23.32	23.87	23.58
		1	13	23.57	23.75	23.52
1		24	23.51	23.30	23.49	
12		0	22.70	22.62	22.69	
12		6	22.91	22.67	22.58	
12		13	22.64	22.61	22.73	
25		0	22.61	22.54	22.65	
5MHz	16QAM	1	0	22.50	22.30	23.13
		1	13	23.20	22.37	23.62
1		24	22.69	22.19	22.80	
12		0	21.62	21.71	21.79	
12		6	21.77	21.64	21.85	
12		13	21.65	21.59	21.90	
25		0	21.45	21.60	21.67	
10MHz	Modulation	RB size	RB offset	Channel/Frequency (MHz)		
				23060/704	23095/707.5	23130/711
10MHz	QPSK	1	0	23.29	23.83	23.55
		1	25	23.56	23.71	23.50
		1	49	23.49	23.29	23.46
		25	0	22.67	22.57	22.65
		25	13	22.89	22.63	22.55
		25	25	22.61	22.56	22.69
		50	0	22.58	22.49	22.61
	16QAM	1	0	22.48	22.26	23.08
		1	25	23.16	22.35	23.58
		1	49	22.67	22.16	22.78
		25	0	21.59	21.67	21.76
		25	13	21.74	21.62	21.82
		25	25	21.62	21.54	21.86
		50	0	21.43	21.56	21.64

LTE Band 13				Conducted Power(dBm)		
Bandwidth	Modulation	RB size	RB offset	Channel/Frequency (MHz)		
				23205/779.5	23230/782	23255/784.5
5MHz	QPSK	1	0	23.56	23.41	23.36
		1	13	23.31	23.60	23.58
		1	24	23.33	21.39	23.46
		12	0	22.58	22.49	22.43
		12	6	22.50	22.67	22.65
		12	13	22.49	22.60	22.54
		25	0	22.56	22.69	22.59
	16QAM	1	0	23.06	22.13	22.39
		1	13	22.75	22.11	22.39
		1	24	22.79	21.97	22.27
		12	0	21.35	21.40	21.55
		12	6	21.55	21.63	21.41
		12	13	21.36	21.44	21.33
		25	0	21.64	21.81	21.69
Bandwidth	Modulation	RB size	RB offset	Channel/Frequency (MHz)		
				/	23230/782	/
10MHz	QPSK	1	0	/	23.61	/
		1	25	/	23.78	/
		1	49	/	23.44	/
		25	0	/	22.56	/
		25	13	/	22.52	/
		25	25	/	22.63	/
		50	0	/	22.69	/
	16QAM	1	0	/	22.82	/
		1	25	/	23.21	/
		1	49	/	22.87	/
		25	0	/	21.54	/
		25	13	/	21.50	/
		25	25	/	21.82	/
		50	0	/	21.62	/

5.2 Effective Isotropic Radiated Power

Ambient condition

Temperature	Relative humidity	Pressure
23°C ~25°C	45%~50%	101.5kPa

Methods of Measurement

1. The testing follows FCC KDB 971168 D01 v03r01 Section 5.8 and ANSI/TIA-603-E (2016).

- a) Connect the equipment as illustrated. Mount the equipment with the manufacturer specified antenna in a vertical orientation on a manufacturer specified mounting surface located on a non-conducting rotating platform of a RF anechoic chamber (preferred) or a standard radiation site.
- b) Key the transmitter, then rotate the EUT 360° azimuthally and record spectrum analyzer power level (LVL) measurements at angular increments that are sufficiently small to permit resolution of all peaks. If a standard radiation test site is used, raise and lower the test antenna to obtain a maximum reading at each angular increment. (Note: several batteries may be needed to offset the effect of battery voltage droop, which should not exceed 5% of the manufactured specified battery voltage during transmission).
- c) Replace the transmitter under test with a vertically polarized half-wave dipole (or an antenna whose gain is known relative to an ideal half-wave dipole). The center of the antenna should be at the same location as the center of the antenna under test.
- d) Connect the antenna to a signal generator with a known output power and record the path loss (in dB) as LOSS. If a standard radiation test site is used, raise and lower the test antenna to obtain a maximum reading. $LOSS = \text{Generator Output Power (dBm)} - \text{Analyzer reading (dBm)}$
- e) Determine the effective radiated output power at each angular position from the readings in steps b) and d) using the following equation: $ERP \text{ (dBm)} = LVL \text{ (dBm)} + LOSS \text{ (dB)}$
- f) The maximum ERP is the maximum value determined in the preceding step.
- g) When calculating ERP, in addition to knowing the antenna radiation and matching characteristics, it is necessary to know the loss values of all elements (e.g. transmission line attenuation, mismatches, filters, combiners) interposed between the point where transmitter output power is measured, and the point where power is applied to the antenna. ERP can then be calculated as follows:
 $ERP \text{ (dBm)} = \text{Output Power (dBm)} - \text{Losses (dB)} + \text{Antenna Gain (dBd)}$
 where: dBd refers to gain relative to an ideal dipole.
 $EIRP \text{ (dBm)} = ERP \text{ (dBm)} + 2.15 \text{ (dB.)}$

The RB allocation refers to section 5.1, using the maximum output power configuration.

Test setup

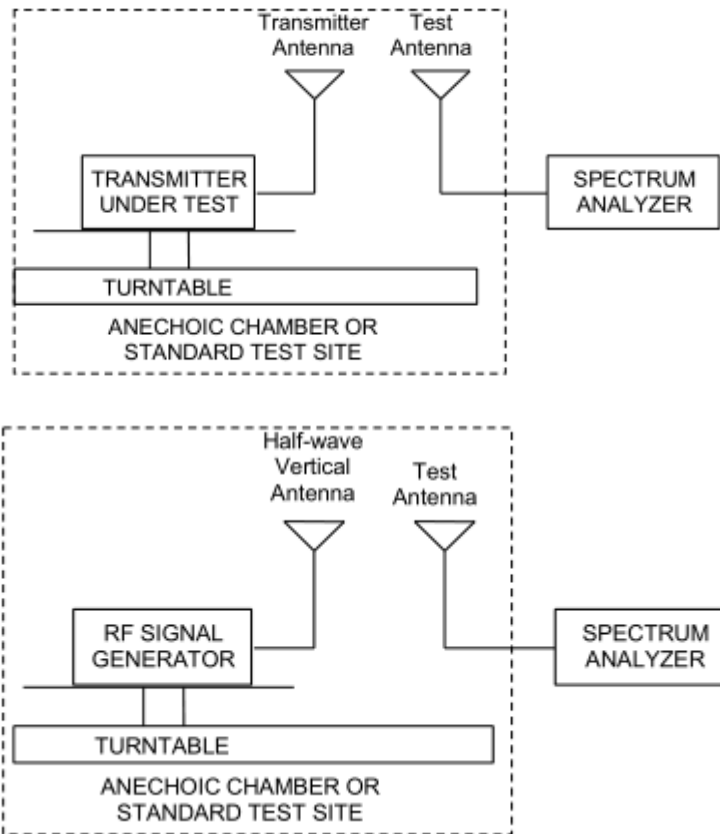

Note: Area side:2.4mX3.6m

The radiated emission was measured in the following position: EUT stand-up position (Z axis), lie-down position (X, Y axis). The worst emission was found in stand-up position (Z axis) and the worst case was recorded.

Limits

Rule Part 27.50(b) (10) specifies that “Portable stations (hand-held devices) transmitting in the 746-757 MHz, 776-788 MHz, and 805-806 MHz bands are limited to 3 watts ERP”

Rule Part 27.50(c) (10) specifies that “Portable stations (hand-held devices) in the 600 MHz uplink band and the 698-746 MHz band, and fixed and mobile stations in the 600 MHz uplink band are limited to 3 watts ERP”

Rule Part 27.50(d) (4) specifies that “Fixed, mobile and portable (hand-held) stations operating in the 1710–1755 MHz band are limited to 1 watt EIRP”

Part 27.50(b)(10)Limit	$\leq 3 \text{ W}$ (34.77 dBm)
Part 27.50(c)(10)Limit	$\leq 3 \text{ W}$ (34.77 dBm)
Part 27.50(d)(4)Limit	$\leq 1 \text{ W}$ (30 dBm)

Measurement Uncertainty

The assessed measurement uncertainty to ensure 95% confidence level for the normal distribution is with the coverage factor $k = 2$, $U = 1.19 \text{ dB}$

Test Results

The measurement is performed for both of horizontal and vertical antenna Polarization, and only the data of worst mode is recorded in this report.

Mode	Channel	Frequency (MHz)	Polarization	EIRP (dBm)	Limit (dBm)	Conclusion
WCDMA Band IV	Low	1712.4	Horizontal	25.49	30	Pass
	Mid	1732.6	Horizontal	25.50	30	Pass
	High	1752.6	Horizontal	25.63	30	Pass

LTE Band 4						
Bandwidth	Channel	Frequency (MHz)	Polarization	EIRP (dBm)	Limit (dBm)	Conclusion
1.4 MHz (QPSK)	Low	1710.7	Horizontal	25.13	30	Pass
	Mid	1732.5	Horizontal	24.25	30	Pass
	High	1754.3	Horizontal	24.33	30	Pass
3 MHz (QPSK)	Low	1711.5	Horizontal	24.95	30	Pass
	Mid	1732.5	Horizontal	24.33	30	Pass
	High	1753.5	Horizontal	24.43	30	Pass
5 MHz (QPSK)	Low	1712.5	Horizontal	25.06	30	Pass
	Mid	1732.5	Horizontal	24.44	30	Pass
	High	1752.5	Horizontal	24.67	30	Pass
10 MHz (QPSK)	Low	1715	Horizontal	24.88	30	Pass
	Mid	1732.5	Horizontal	24.43	30	Pass
	High	1750	Horizontal	24.20	30	Pass
15 MHz (QPSK)	Low	1717.5	Horizontal	25.14	30	Pass
	Mid	1732.5	Horizontal	24.43	30	Pass
	High	1747.5	Horizontal	24.60	30	Pass
20 MHz (QPSK)	Low	1720	Horizontal	24.90	30	Pass
	Mid	1732.5	Horizontal	24.47	30	Pass
	High	1745	Horizontal	24.41	30	Pass
1.4 MHz (16QAM)	Low	1710.7	Horizontal	24.89	30	Pass
	Mid	1732.5	Horizontal	24.01	30	Pass
	High	1754.3	Horizontal	24.03	30	Pass
3 MHz (16QAM)	Low	1711.5	Horizontal	24.76	30	Pass
	Mid	1732.5	Horizontal	24.13	30	Pass
	High	1753.5	Horizontal	24.02	30	Pass
5 MHz (16QAM)	Low	1712.5	Horizontal	24.78	30	Pass
	Mid	1732.5	Horizontal	24.03	30	Pass
	High	1752.5	Horizontal	24.13	30	Pass
10 MHz (16QAM)	Low	1715	Horizontal	24.66	30	Pass
	Mid	1732.5	Horizontal	24.21	30	Pass
	High	1750	Horizontal	24.00	30	Pass



15 MHz (16QAM)	Low	1717.5	Horizontal	24.86	30	Pass
	Mid	1732.5	Horizontal	24.21	30	Pass
	High	1747.5	Horizontal	24.30	30	Pass
20 MHz (16QAM)	Low	1720	Horizontal	24.57	30	Pass
	Mid	1732.5	Horizontal	24.04	30	Pass
	High	1745	Horizontal	24.01	30	Pass

LTE Band 12						
Bandwidth	Channel	Frequency (MHz)	Polarization	ERP (dBm)	Limit (dBm)	Conclusion
1.4 MHz (QPSK)	Low	699.7	Horizontal	19.20	34.77	Pass
	Mid	707.5	Horizontal	19.49	34.77	Pass
	High	715.3	Horizontal	19.70	34.77	Pass
3 MHz (QPSK)	Low	700.5	Horizontal	19.29	34.77	Pass
	Mid	707.5	Horizontal	19.57	34.77	Pass
	High	714.5	Horizontal	19.55	34.77	Pass
5 MHz (QPSK)	Low	701.5	Horizontal	19.31	34.77	Pass
	Mid	707.5	Horizontal	19.57	34.77	Pass
	High	713.5	Horizontal	19.41	34.77	Pass
10 MHz (QPSK)	Low	704	Horizontal	19.16	34.77	Pass
	Mid	707.5	Horizontal	19.44	34.77	Pass
	High	711	Horizontal	19.51	34.77	Pass
1.4 MHz (16QAM)	Low	699.7	Horizontal	18.63	34.77	Pass
	Mid	707.5	Horizontal	18.84	34.77	Pass
	High	715.3	Horizontal	19.06	34.77	Pass
3 MHz (16QAM)	Low	700.5	Horizontal	18.72	34.77	Pass
	Mid	707.5	Horizontal	18.98	34.77	Pass
	High	714.5	Horizontal	18.96	34.77	Pass
5 MHz (16QAM)	Low	701.5	Horizontal	18.82	34.77	Pass
	Mid	707.5	Horizontal	18.87	34.77	Pass
	High	713.5	Horizontal	18.52	34.77	Pass
10 MHz (16QAM)	Low	704	Horizontal	18.59	34.77	Pass
	Mid	707.5	Horizontal	18.81	34.77	Pass
	High	711	Horizontal	18.88	34.77	Pass

LTE Band 13						
Bandwidth	Channel	Frequency (MHz)	Polarization	ERP (dBm)	Limit (dBm)	Conclusion
5MHz (QPSK)	Low	779.5	Horizontal	22.17	34.77	Pass
	Mid	782	Horizontal	21.87	34.77	Pass
	High	784.5	Horizontal	21.96	34.77	Pass
10MHz (QPSK)	Mid	782	Horizontal	22.41	34.77	Pass
5MHz (16QAM)	Low	779.5	Horizontal	21.82	34.77	Pass
	Mid	782	Horizontal	21.61	34.77	Pass
	High	784.5	Horizontal	21.73	34.77	Pass
10MHz (16QAM)	Mid	782	Horizontal	21.87	34.77	Pass

5.3 Occupied Bandwidth

Ambient condition

Temperature	Relative humidity	Pressure
23°C ~25°C	45%~50%	101.5kPa

Method of Measurement

The EUT was connected to Spectrum Analyzer and Base Station Simulator via power Splitter. The occupied bandwidth is measured using spectrum analyzer.

RBW is set to 51 kHz, VBW is set to 160 kHz for WCDMA Band IV.

RBW is set to 51 kHz, VBW is set to 160 kHz for LTE Band 4/12 (1.4MHz).

RBW is set to 100 kHz, VBW is set to 300 kHz for LTE Band 4/12 (3MHz).

RBW is set to 100 kHz, VBW is set to 300 kHz for LTE Band 4/12/13 (5MHz).

RBW is set to 300 kHz, VBW is set to 1MHz for LTE Band 4/12/13 (10MHz).

RBW is set to 300 kHz, VBW is set to 1MHz for LTE Band 4 (15MHz/20MHz).

99% power and -26dBc occupied bandwidths are recorded. Spectrum analyzer plots are included on the following pages.

Test Setup

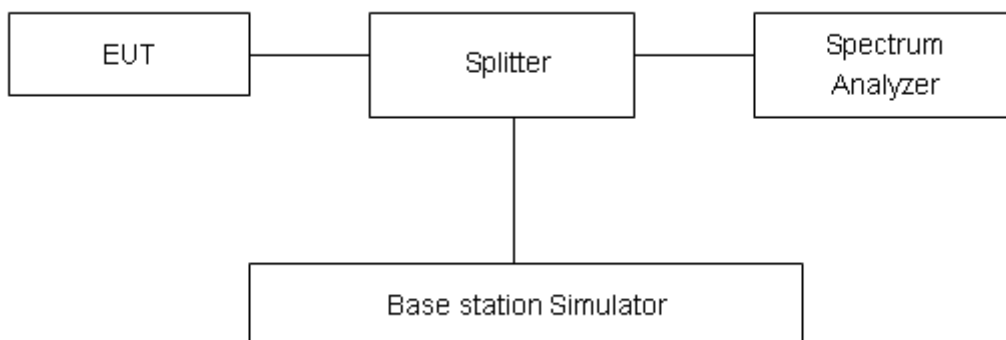

Limits

No specific occupied bandwidth requirements in part 2.1049.

Measurement Uncertainty

The assessed measurement uncertainty to ensure 95% confidence level for the normal distribution is with the coverage factor $k = 2$, $U=624\text{Hz}$.

Test Result

Mode	Channel	Frequency (MHz)	99% Power Bandwidth(MHz)	-26dBc Bandwidth(MHz)
WCDMA Band IV (RMC)	1312	1712.4	4.1071	4.678
	1413	1732.6	4.1193	4.679
	1513	1752.6	4.1284	4.703

LTE Band 4						
RB	Modulation	Bandwidth (MHz)	Channel	Frequency (MHz)	99% Power Bandwidth(MHz)	-26dBc Bandwidth(MHz)
100%	QPSK	1.4	19957	1710.7	1.1274	1.337
			20175	1732.5	1.1077	1.315
			20393	1754.3	1.1108	1.335
		3	19965	1711.5	2.7345	3.04
			20175	1732.5	2.7353	3.064
			20385	1753.5	2.7424	3.034
		5	19975	1712.5	4.5308	5.03
			20175	1732.5	4.514	4.976
			20375	1752.5	4.5177	5.022
		10	20000	1715	9.0214	10.04
			20175	1732.5	9.0081	10.02
			20350	1750	9.0092	10.08
		15	20025	1717.5	13.474	14.7
			20175	1732.5	13.438	14.56
			20325	1747.5	13.431	14.61
		20	20050	1720	17.896	19.21
			20175	1732.5	17.911	19.04
			20300	1745	17.861	19.36
	16QAM	1.4	19957	1710.7	1.1224	1.35
			20175	1732.5	1.1055	1.309
			20393	1754.3	1.1183	1.342
		3	19965	1711.5	2.7288	3.066
			20175	1732.5	2.744	3.05
			20385	1753.5	2.7395	3.045
5		19975	1712.5	4.5457	5.016	
		20175	1732.5	4.5193	5.001	
		20375	1752.5	4.5362	5.011	
10		20000	1715	9.0281	9.965	
		20175	1732.5	9.0551	9.913	



		15	20350	1750	9.0086	9.943
			20025	1717.5	13.428	14.69
			20175	1732.5	13.467	14.65
			20325	1747.5	13.447	14.66
		20	20050	1720	17.865	19.04
			20175	1732.5	17.91	19.22
			20300	1745	17.873	19.48

LTE Band 12						
RB	Modulation	Bandwidth (MHz)	Channel	Frequency (MHz)	99% Power Bandwidth(MHz)	-26dBc Bandwidth(MHz)
100%	QPSK	1.4	23017	699.7	1.1165	1.315
			23095	707.5	1.1136	1.335
			23173	715.3	1.1154	1.319
		3	23025	700.5	2.7422	3.059
			23095	707.5	2.7444	3.052
			23165	714.5	2.7392	3.072
		5	23035	701.5	4.5137	5.013
			23095	707.5	4.516	4.972
			23155	713.5	4.5174	5.013
		10	23060	704	9.0155	10.1
			23095	707.5	9.0102	10.03
			23130	711	9.0204	9.967
	16QAM	1.4	23017	699.7	1.1057	1.305
			23095	707.5	1.1087	1.343
			23173	715.3	1.1209	1.328
		3	23025	700.5	2.7444	3.083
			23095	707.5	2.7409	3.038
			23165	714.5	2.7411	3.053
		5	23035	701.5	4.5136	4.969
			23095	707.5	4.5062	4.964
			23155	713.5	4.5132	5.003
		10	23060	704	9.0129	10.01
			23095	707.5	8.9972	10.06
			23130	711	9.0348	10.03



LTE Band 13						
RB	Modulation	Bandwidth (MHz)	Channel	Frequency (MHz)	99% Power Bandwidth(MHz)	-26dBc Bandwidth(MHz)
100%	QPSK	5	23205	779.5	4.4928	4.95
			23230	782	4.533	5.062
			23255	784.5	4.5082	4.948
	16QAM	10	23230	782	9.035	10.05
				23205	779.5	4.5002
		5	23230	782	4.5258	5.029
				23255	784.5	4.5057
		10	23230	782	9.0513	10.08

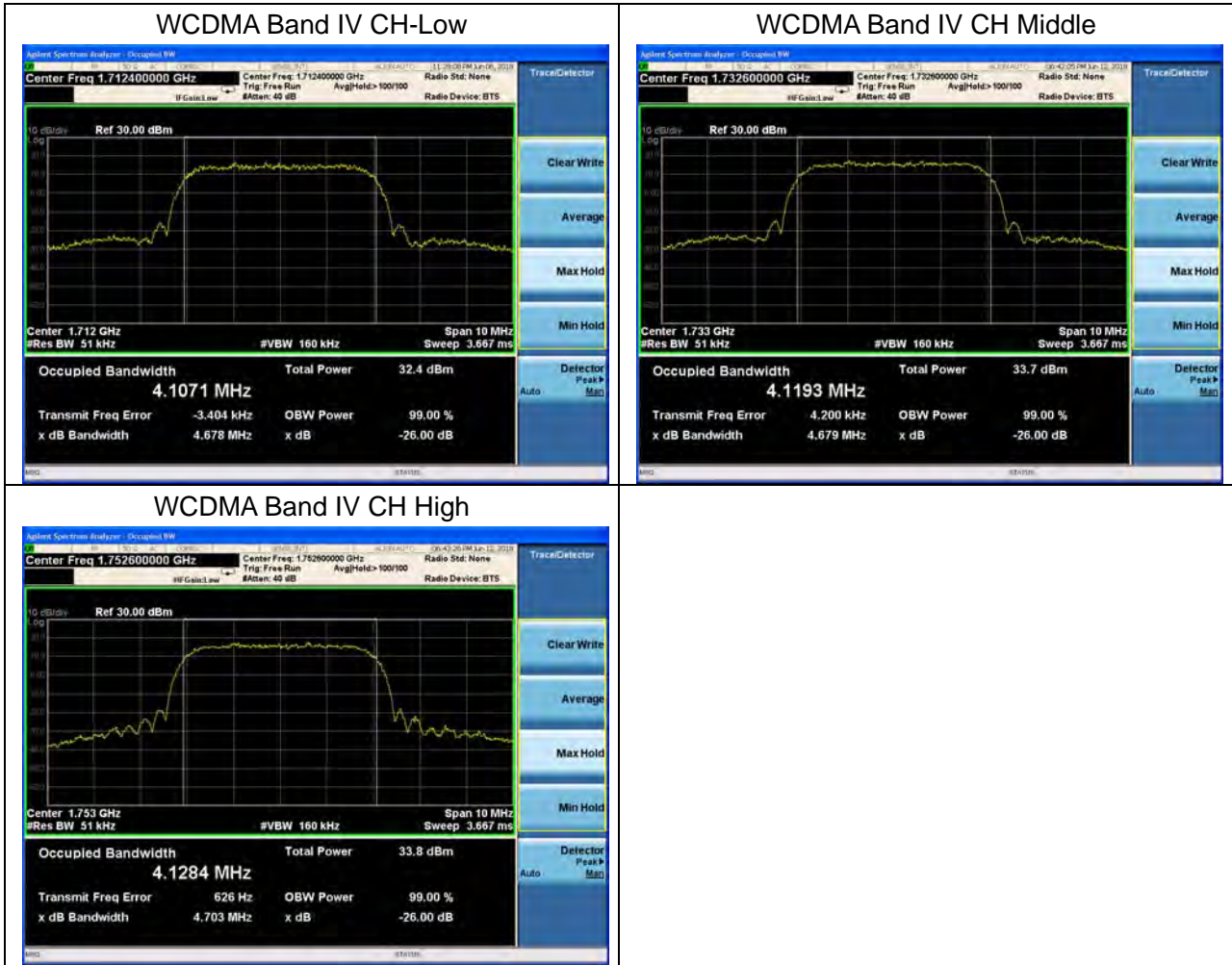

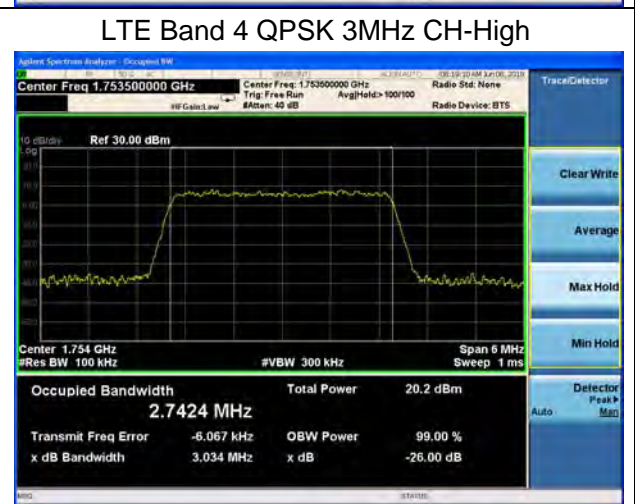
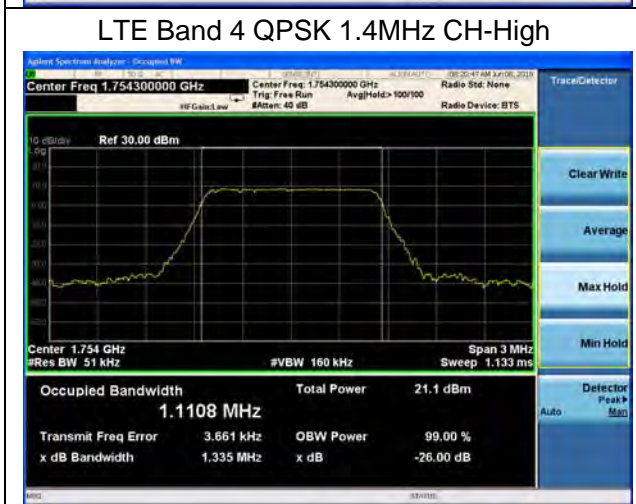
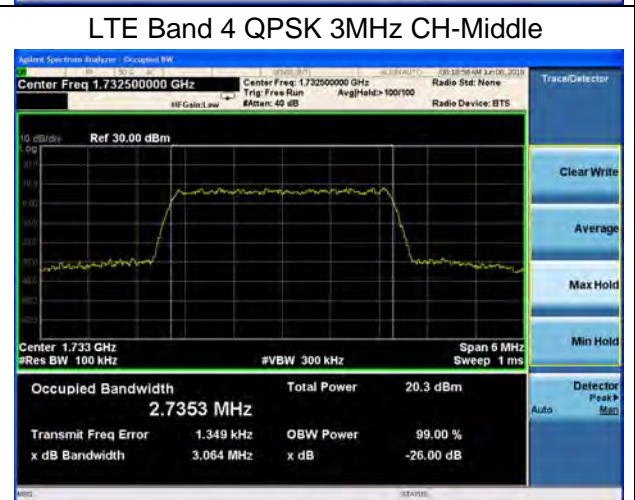
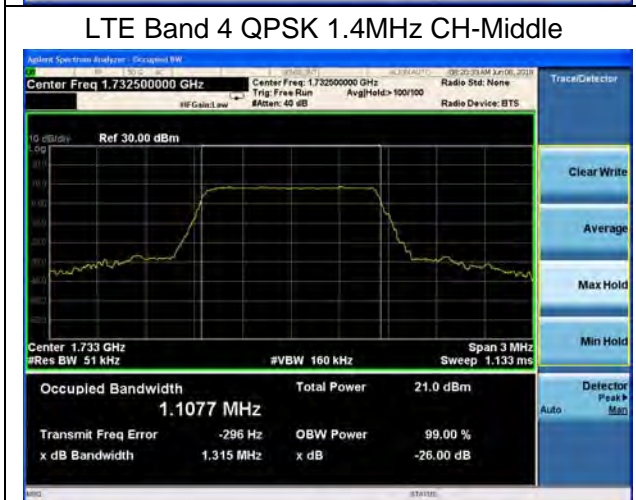
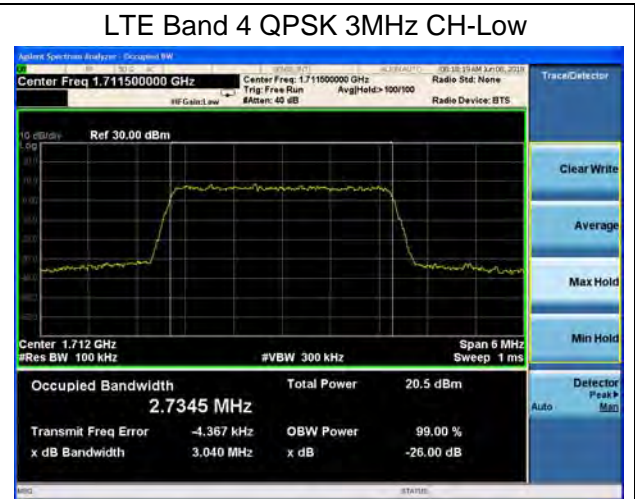
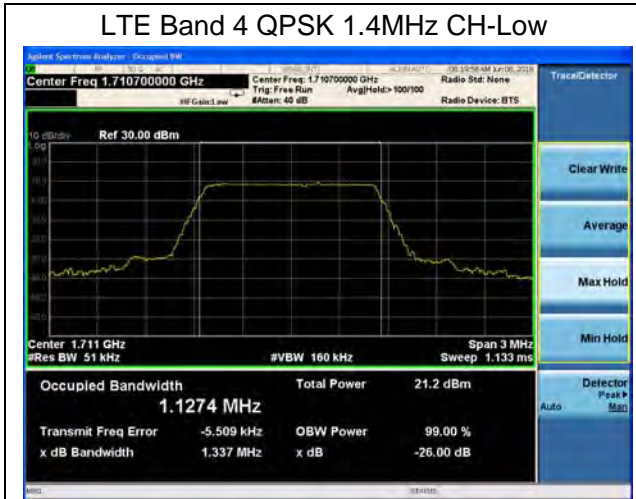

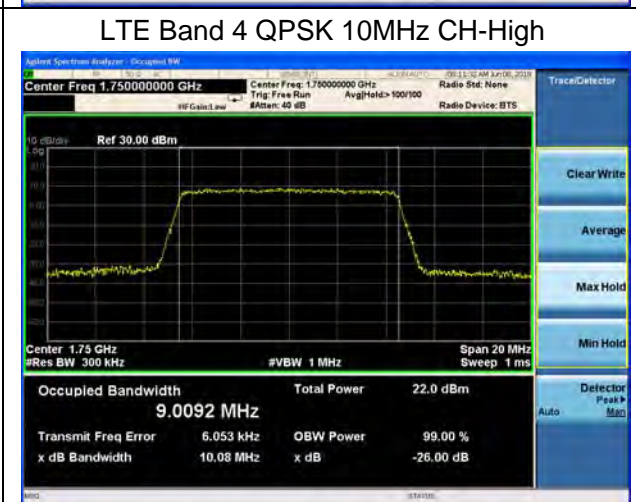
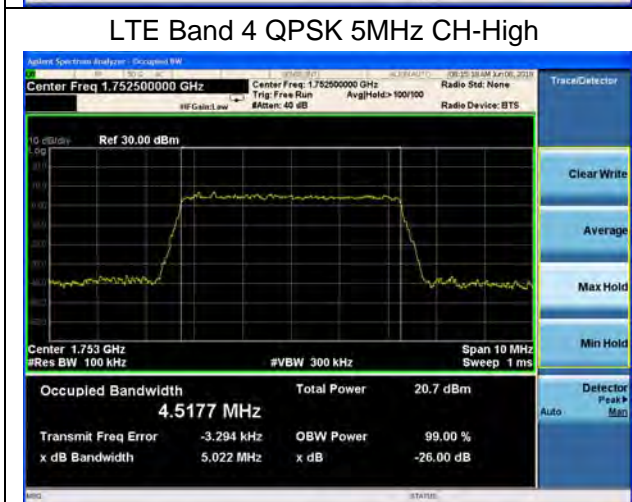
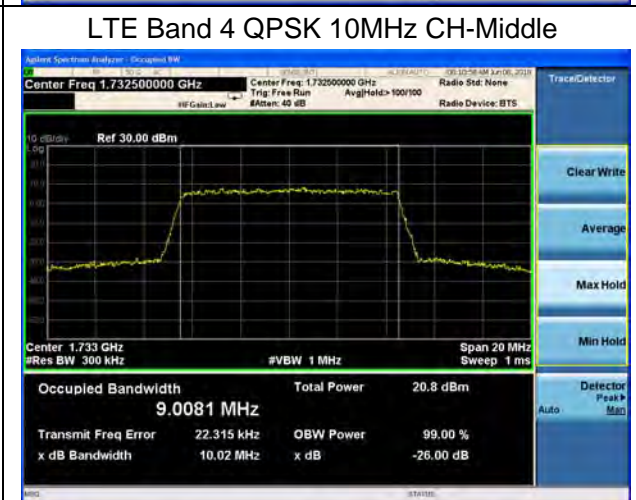
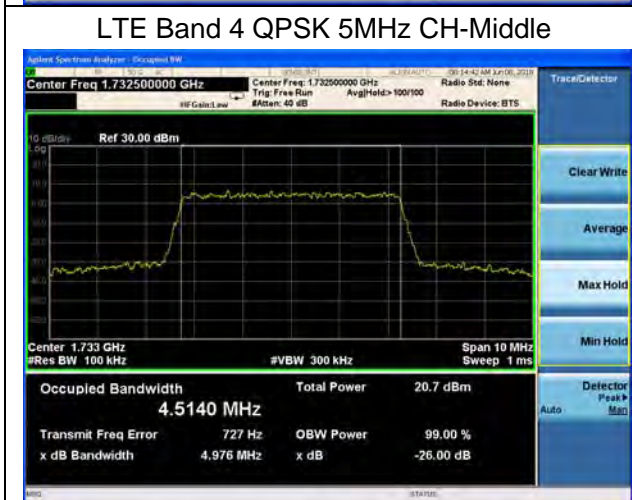
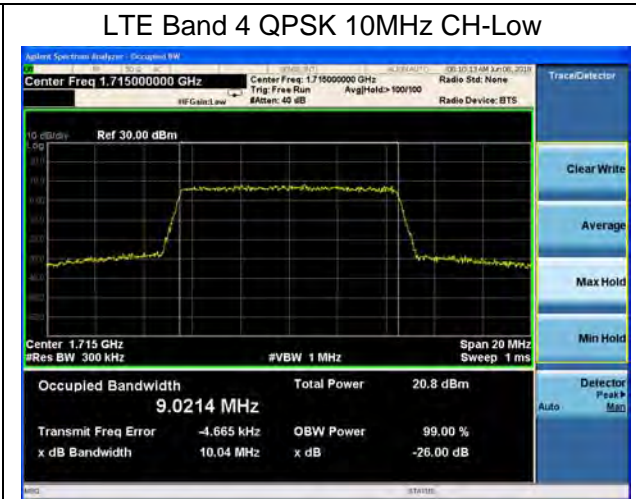
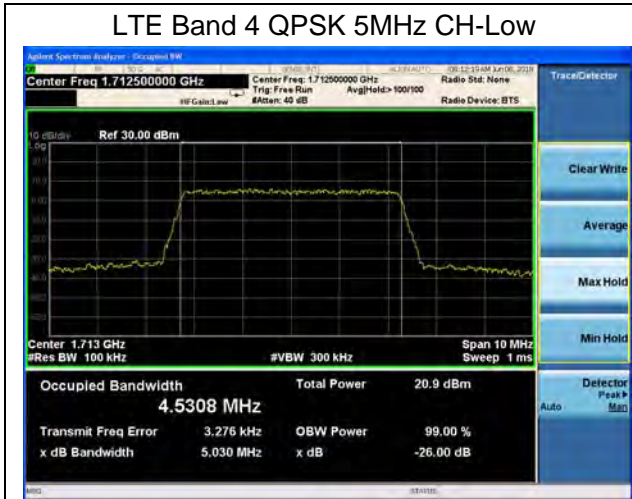

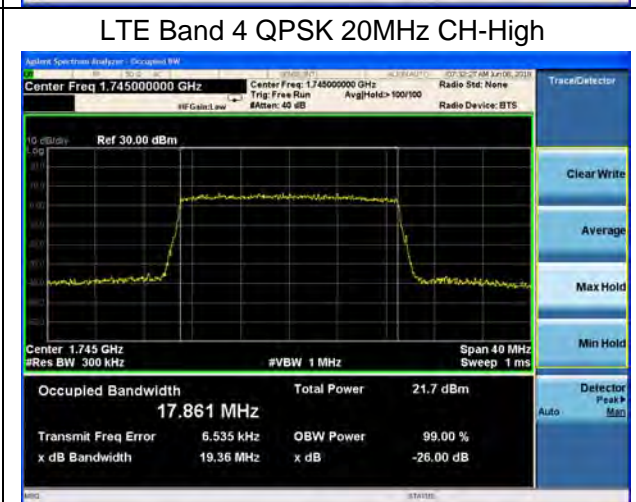
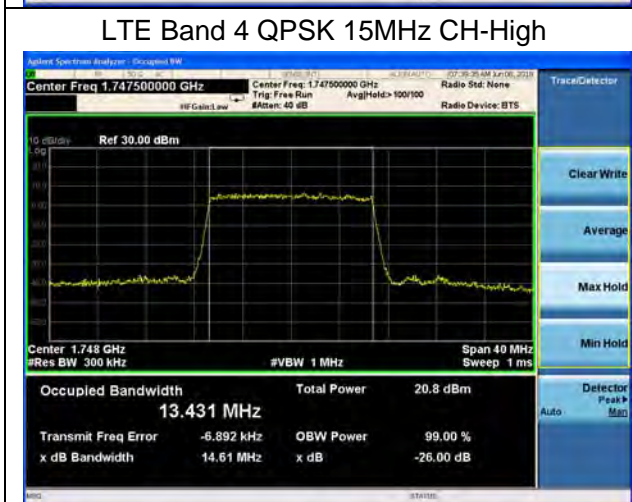
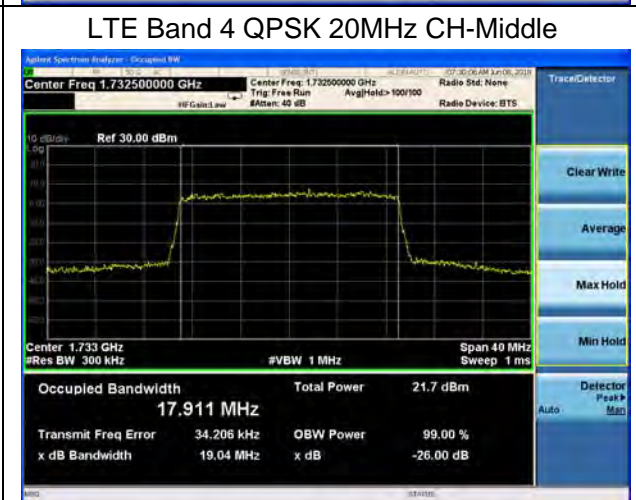
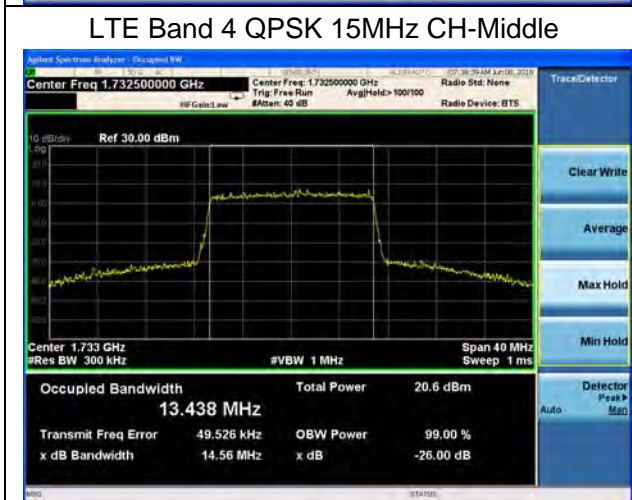
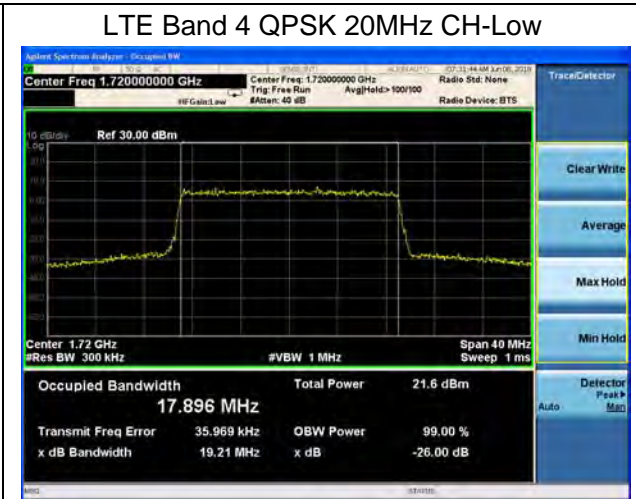
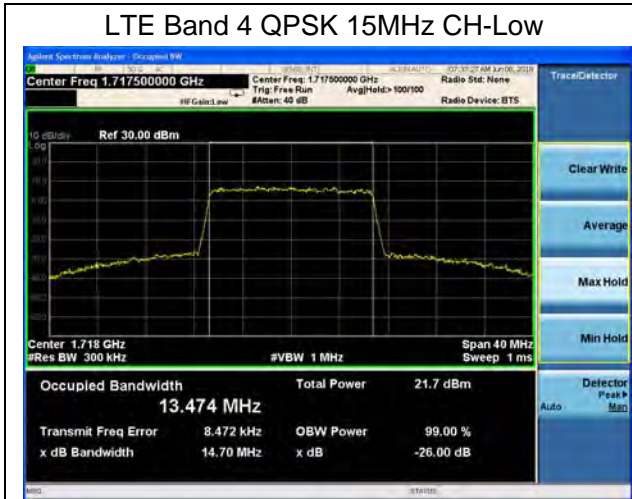

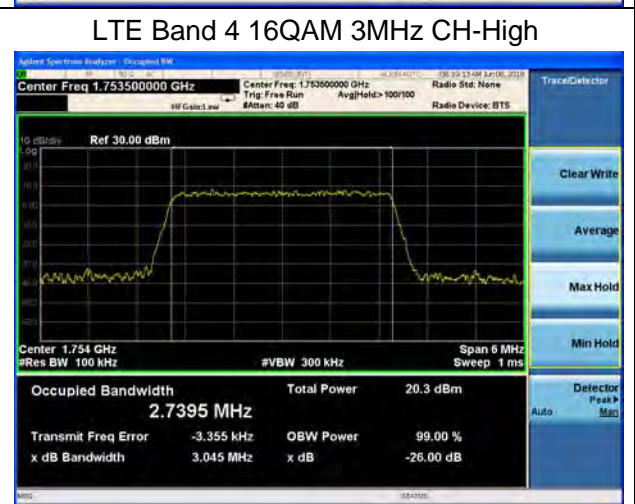
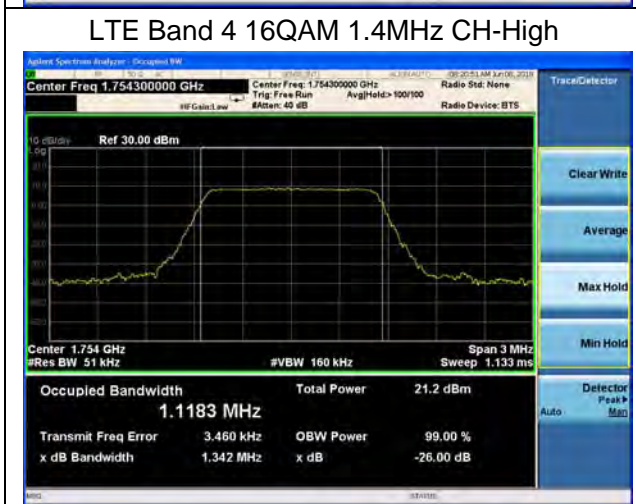
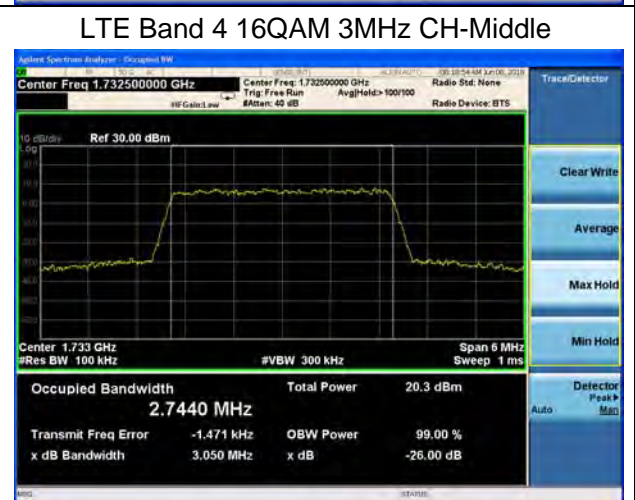
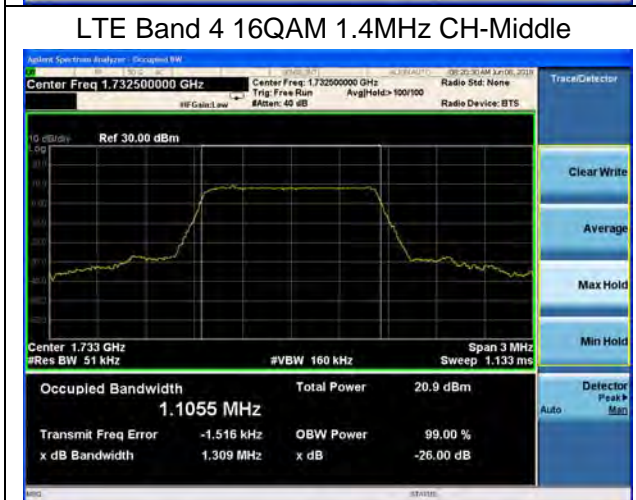
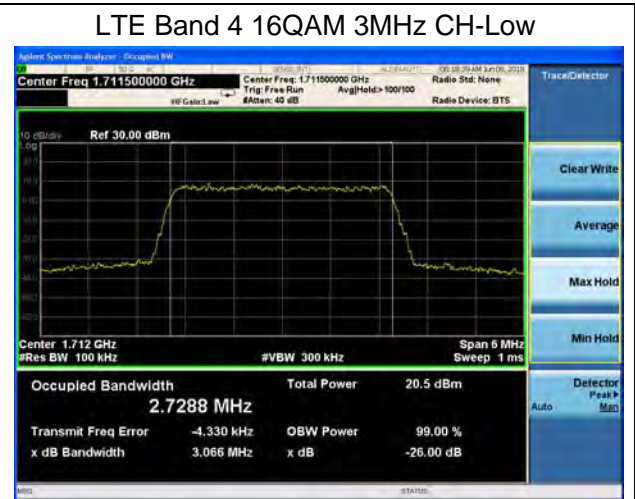
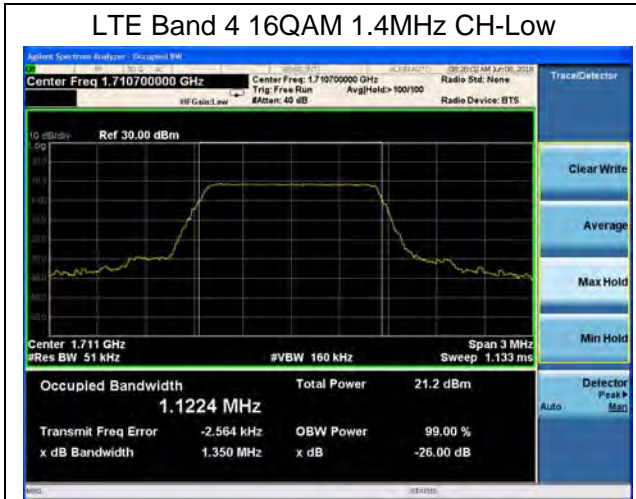

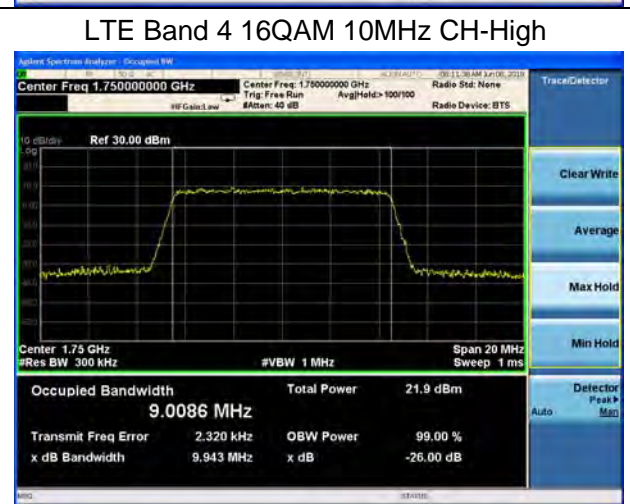
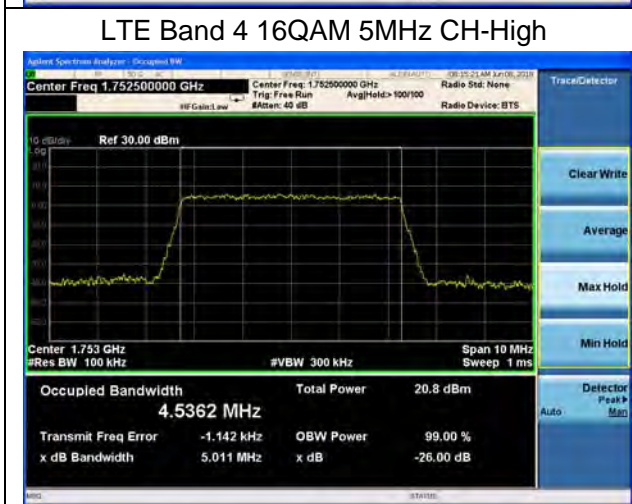
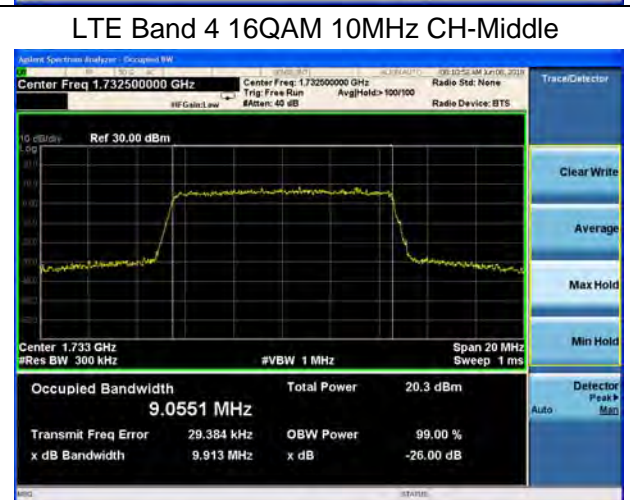
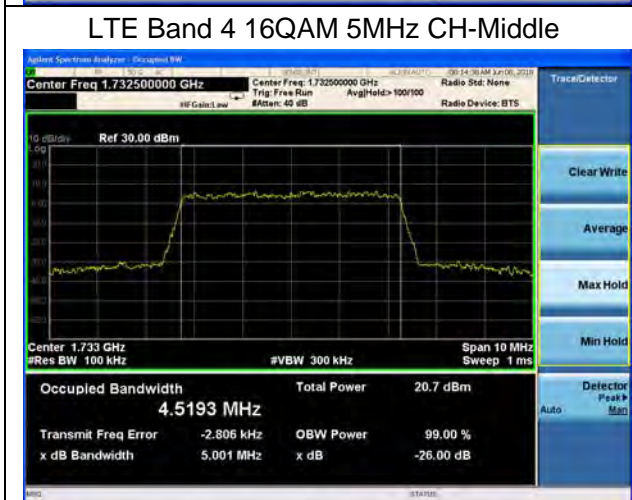
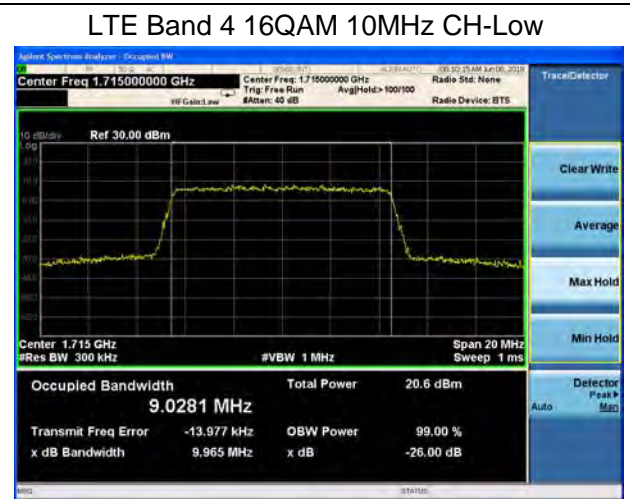
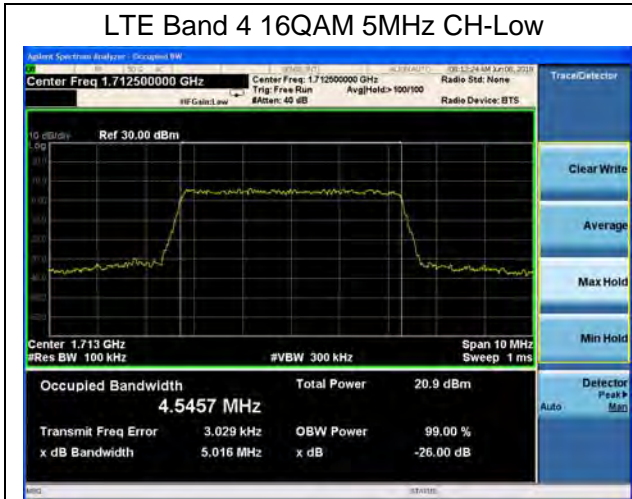



LTE Band 4 16QAM 15MHz CH-Low



LTE Band 4 16QAM 20MHz CH-Low

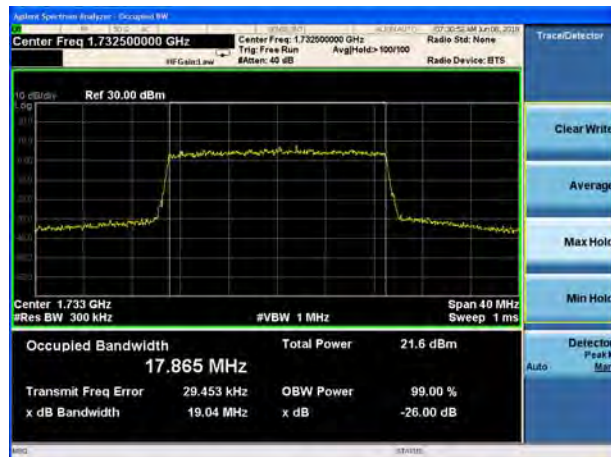

LTE Band 4 16QAM 15MHz CH-Middle



LTE Band 4 16QAM 20MHz CH-Middle



LTE Band 4 16QAM 15MHz CH-High

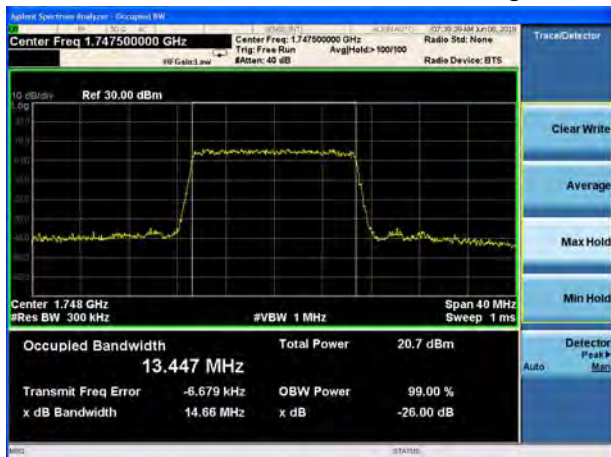

LTE Band 4 16QAM 20MHz CH-High

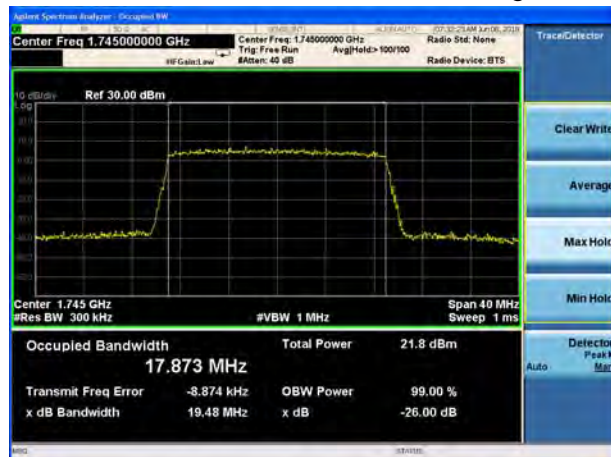

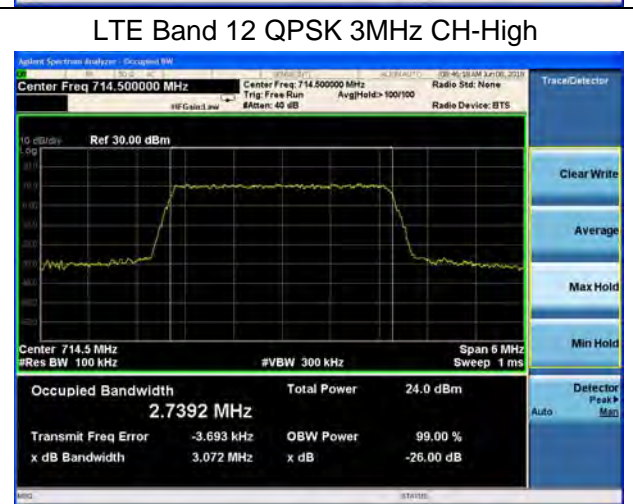
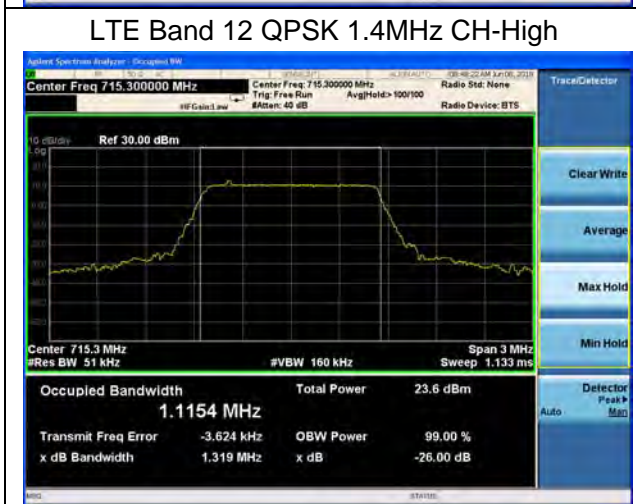
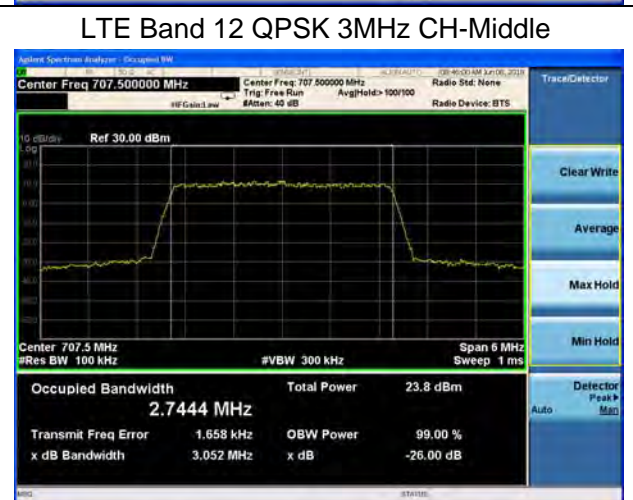
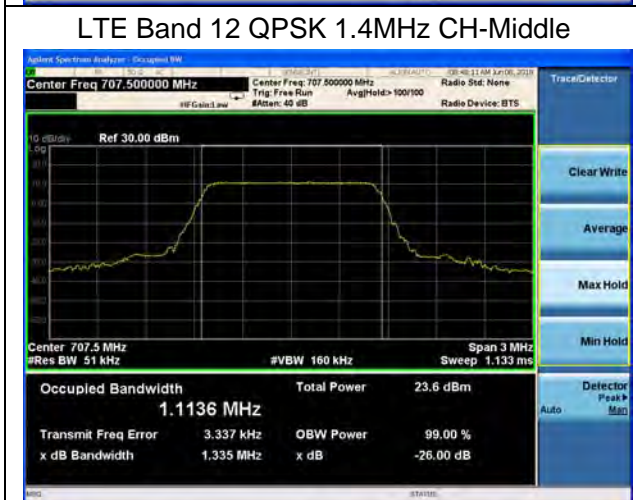
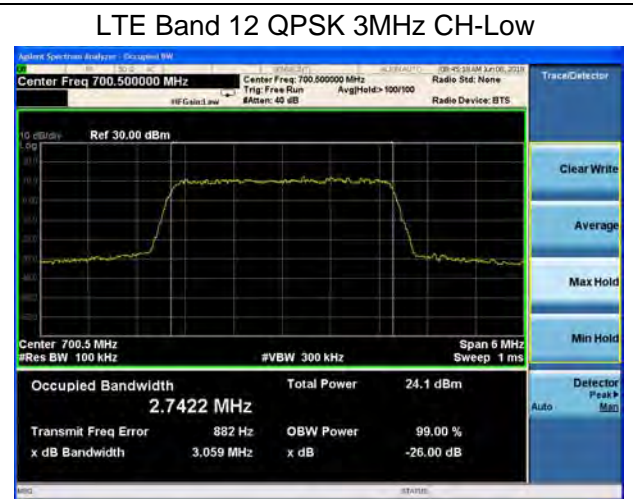
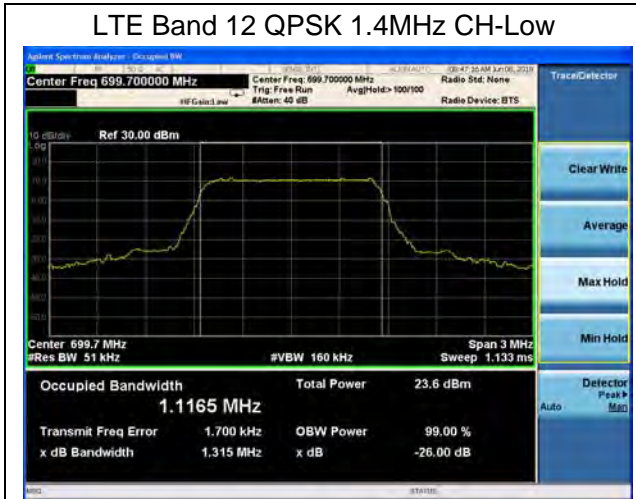

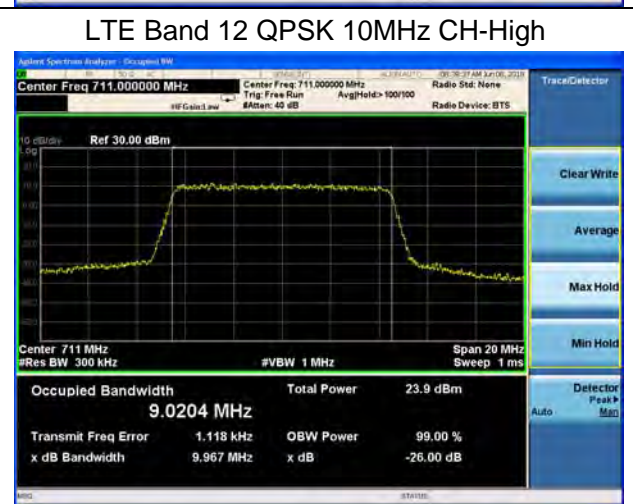
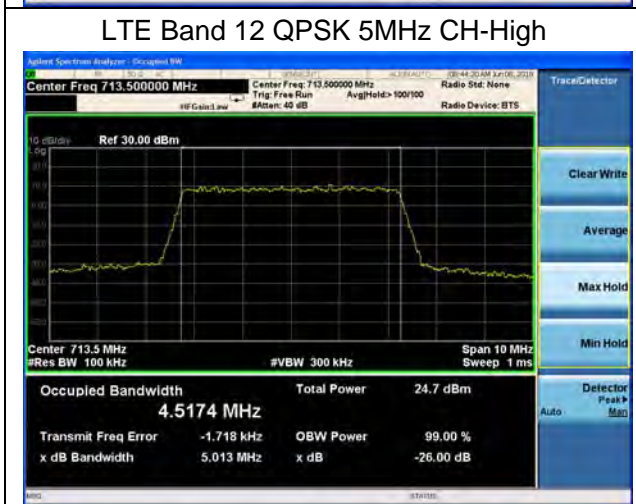
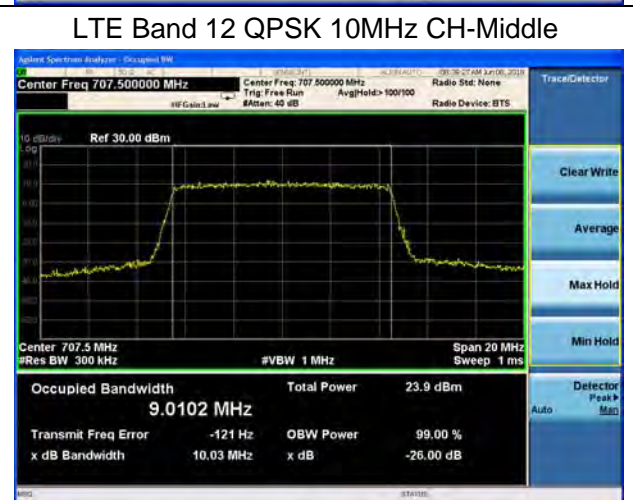
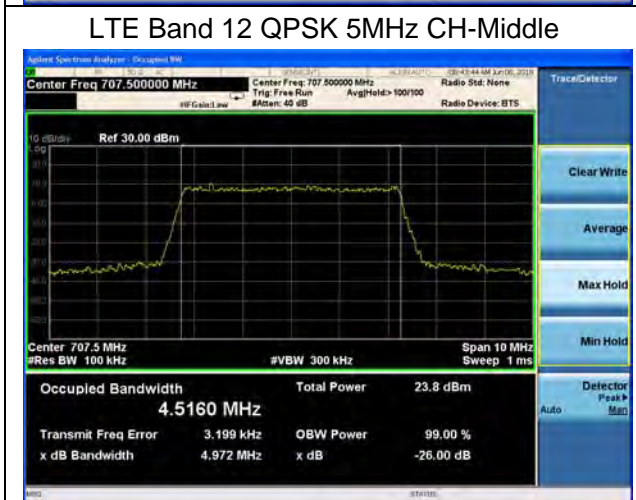
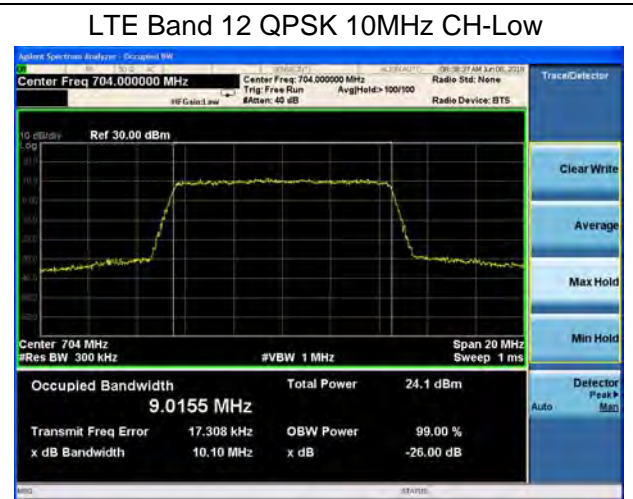
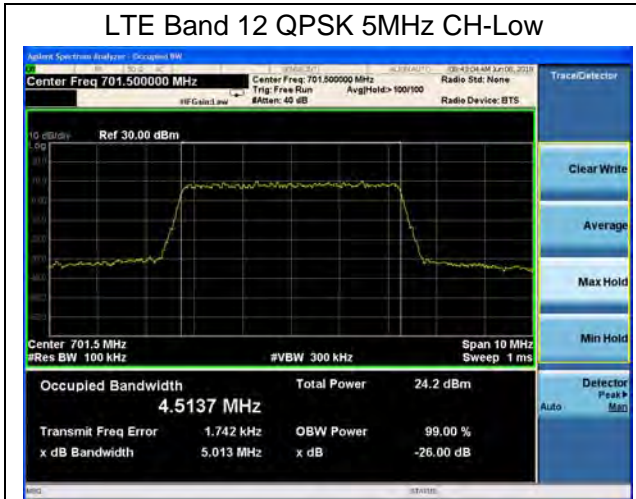

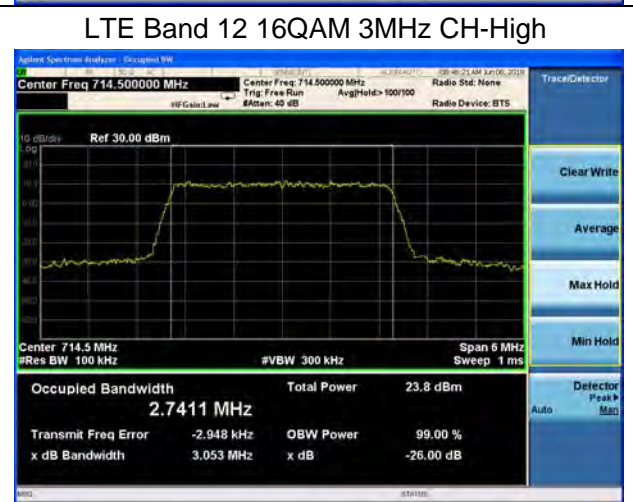
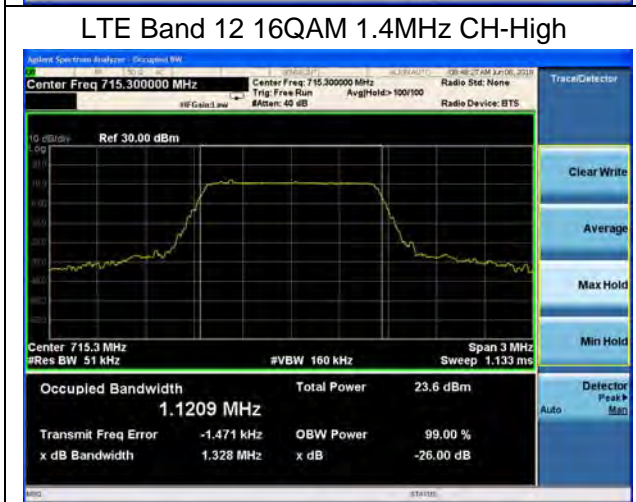
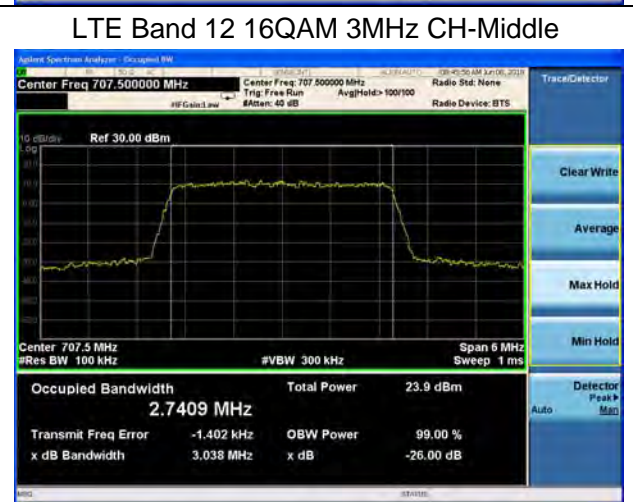
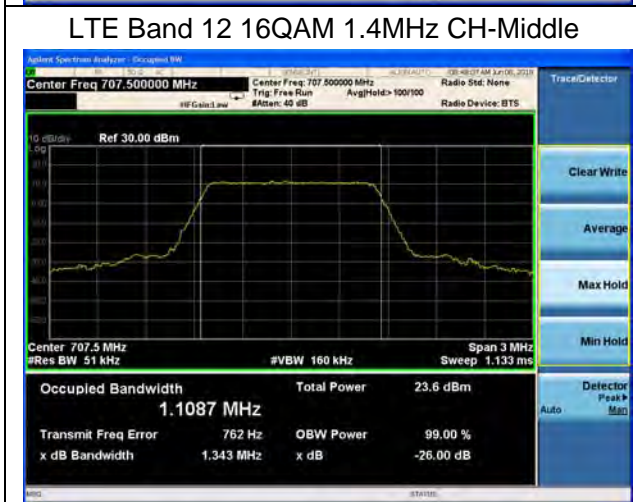
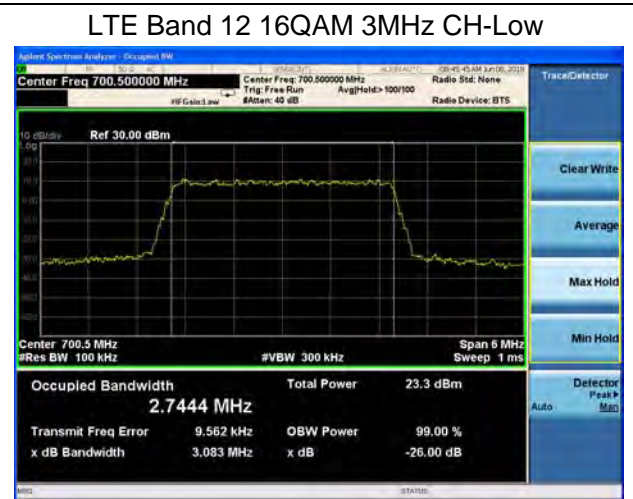
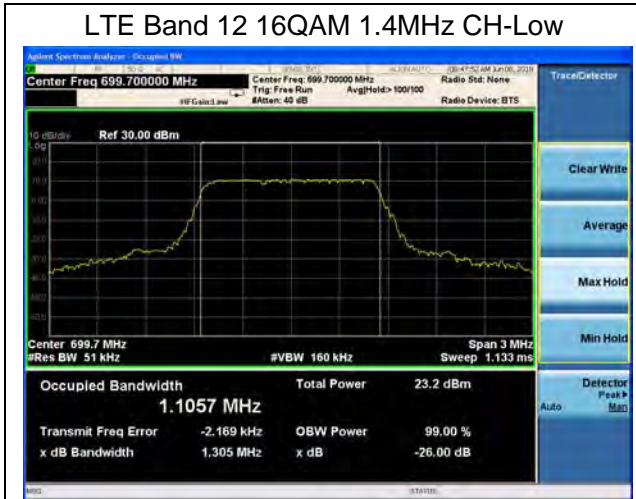

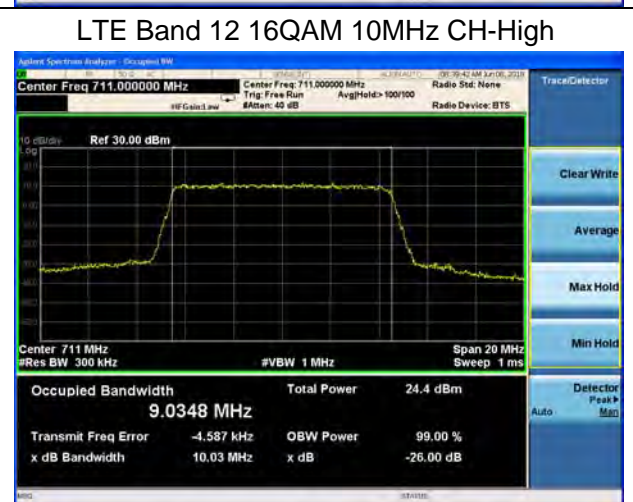
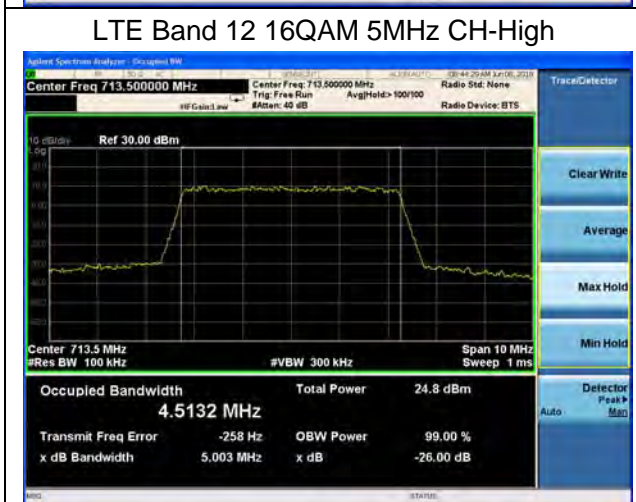
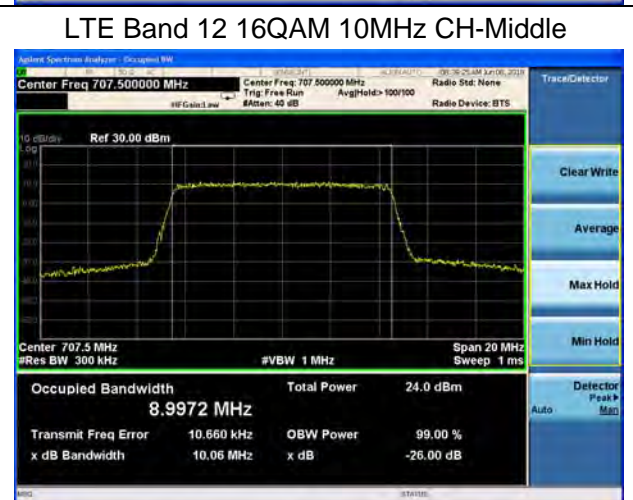
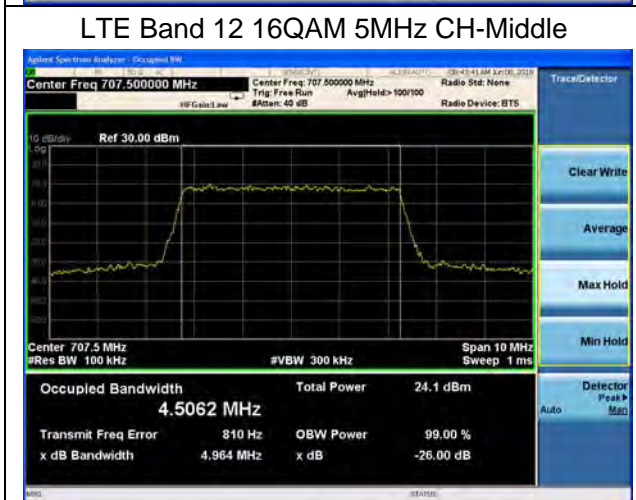
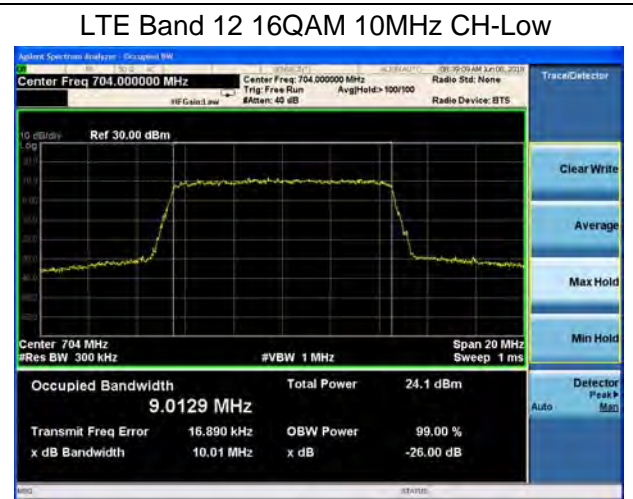
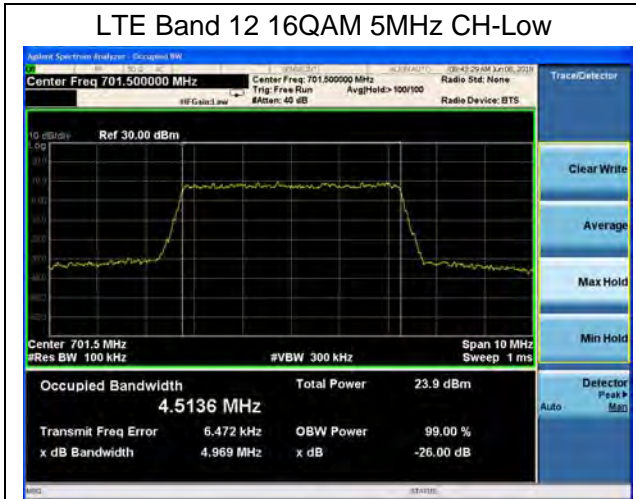



LTE Band 13 QPSK 5MHz CH-Low



LTE Band 13 16QAM 5MHz CH-Low



LTE Band 13 QPSK 5MHz CH-Middle

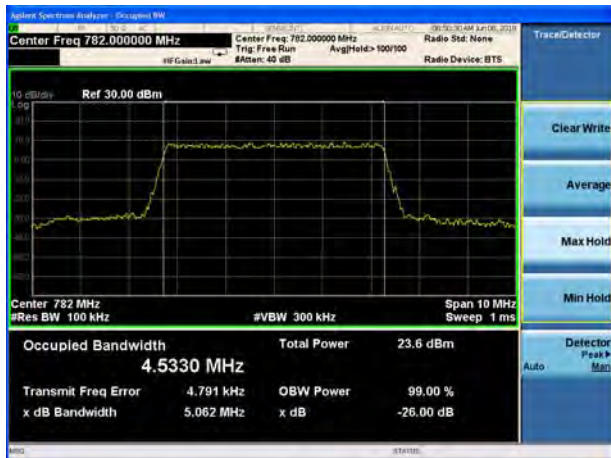

LTE Band 13 16QAM 5MHz CH-Middle



LTE Band 13 QPSK 5MHz CH-High



LTE Band 13 16QAM 5MHz CH-High

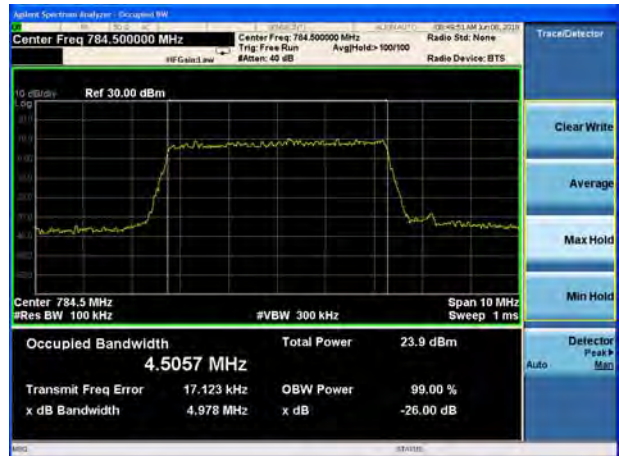

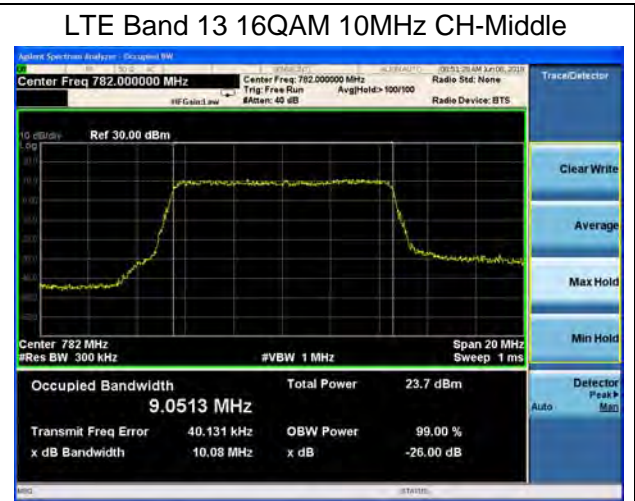
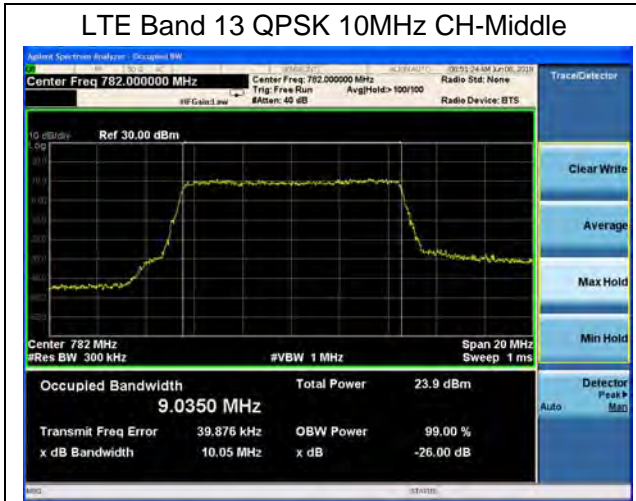

5.4 Band Edge Compliance

Ambient condition

Temperature	Relative humidity	Pressure
23°C ~25°C	45%~50%	101.5kPa

Method of Measurement

The EUT was connected to Spectrum Analyzer and Base Station Simulator via power Splitter. The band edge of the lowest and highest channels were measured.

The testing follows KDB 971168 D01 v03r01 Section 6.0

1. The EUT was connected to spectrum analyzer and system simulator via a power divider.
2. The band edges of low and high channels for the highest RF powers were measured.
3. RBW is set to 51 kHz, VBW is set to 160 kHz for WCDMA Band IV.
 RBW is set to 15 kHz, VBW is set to 51 kHz for LTE Band 4 (1.4MHz).
 RBW is set to 30 kHz, VBW is set to 100 kHz for LTE Band 4 (3MHz).
 RBW is set to 51 kHz, VBW is set to 160 kHz for LTE Band 4 (5MHz).
 RBW is set to 100 kHz, VBW is set to 300kHz for LTE Band 4 (10MHz).
 RBW is set to 150 kHz, VBW is set to 510 kHz for LTE Band 4(15MHz).
 RBW is set to 200 kHz, VBW is set to 620 kHz for LTE Band 4(20MHz)
 RBW is set to 100 kHz, VBW is set to 300kHz for LTE Band 12(1.4MHz/3MHz/5MHz/10MHz).
 RBW is set to 10 kHz, VBW is set to 30 kHz for LTE Band 13 (763MHz~775MHz).
 RBW is set to 100 kHz, VBW is set to 300 kHz for LTE Band 13 (775MHz~777MHz).
 RBW is set to 100 kHz, VBW is set to 300 kHz for LTE Band 13 (787MHz~793MHz).
 RBW is set to 10 kHz, VBW is set to 30 kHz for LTE Band 13 (793MHz~805MHz).
 on spectrum analyzer.
4. Set spectrum analyzer with RMS detector.
5. The RF fundamental frequency should be excluded against the limit line in the operating frequency band.
6. Checked that all the results comply with the emission limit line.

Test Setup

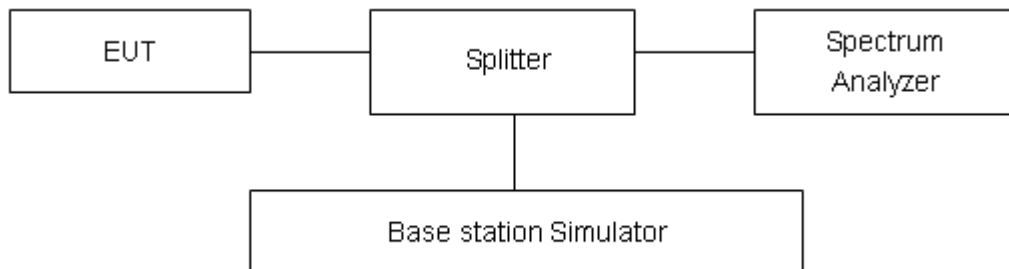

Limits

Rule Part 27.53(h)/ specifies that “ for operations in the 1695-1710 MHz, 1710-1755 MHz, 1755-1780 MHz, 1915-1920 MHz, 1995-2000 MHz, 2000-2020 MHz, 2110-2155 MHz, 2155-2180 MHz, and 2180-2200 bands, the power of any emission outside a licensee's frequency block shall be attenuated below the transmitter power (P) in watts by at least $43 + 10 \log_{10} (P)$ dB”

Part 27.53(g) For operations in the 600 MHz band and the 698-746 MHz band, the power of any emission outside a licensee's frequency band(s) of operation shall be attenuated below the transmitter power (P) within the licensed band(s) of operation, measured in watts, by at least $43 + 10 \log (P)$ dB. Compliance with this provision is based on the use of measurement instrumentation employing a resolution bandwidth of 100 kilohertz or greater. However, in the 100 kilohertz bands immediately outside and adjacent to a licensee's frequency block, a resolution bandwidth of at least 30 kHz may be employed.

Rule Part 27.53(f) For operations in the 746-758 MHz, 775-788 MHz, and 805-806 MHz bands, emissions in the band 1559-1610 MHz shall be limited to -70 dBW/MHz equivalent isotropically radiated power (EIRP) for wideband signals, and -80 dBW EIRP for discrete emissions of less than 700 Hz bandwidth. For the purpose of equipment authorization, a transmitter shall be tested with an antenna that is representative of the type that will be used with the equipment in normal operation.

Part 27.53 (c) For operations in the 746-758 MHz band and the 776-788 MHz band, the power of any emission outside the licensee's frequency band(s) of operation shall be attenuated below the transmitter power (P) within the licensed band(s) of operation, measured in watts, in accordance with the following:

- (1) On any frequency outside the 746-758 MHz band, the power of any emission shall be attenuated outside the band below the transmitter power (P) by at least $43 + 10 \log (P)$ dB;
- (2) On any frequency outside the 776-788 MHz band, the power of any emission shall be attenuated outside the band below the transmitter power (P) by at least $43 + 10 \log (P)$ dB;
- (3) On all frequencies between 763-775 MHz and 793-805 MHz, by a factor not less than $76 + 10 \log (P)$ dB in a 6.25 kHz band segment, for base and fixed stations;
- (4) On all frequencies between 763-775 MHz and 793-805 MHz, by a factor not less than $65 + 10 \log (P)$ dB in a 6.25 kHz band segment, for mobile and portable stations;
- (5) Compliance with the provisions of paragraphs (c)(1) and (c)(2) of this section is based on the use of measurement instrumentation employing a resolution bandwidth of 100 kHz or greater. However, in the 100 kHz bands immediately outside and adjacent to the frequency block, a resolution bandwidth of at least 30 kHz may be employed;

Measurement Uncertainty

The assessed measurement uncertainty to ensure 95% confidence level for the normal distribution is with the coverage factor $k = 1.96$, $U=0.684$ dB.

Test Result

All the test traces in the plots shows the test results clearly.





LTE Band 4 QPSK 1.4MHz CH-Low, 1 RB



LTE Band 4 QPSK 1.4MHz CH-High, 1 RB



LTE Band 4 QPSK 1.4MHz CH-Low, 100%RB



LTE Band 4 QPSK 1.4MHz CH-High, 100%RB

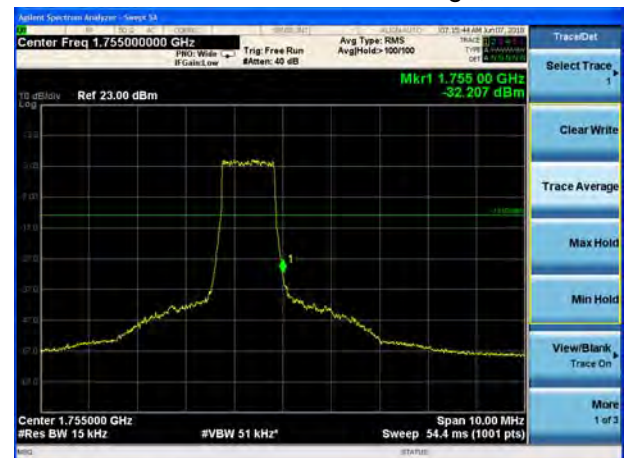

LTE Band 4 QPSK 3MHz CH-Low, 1 RB

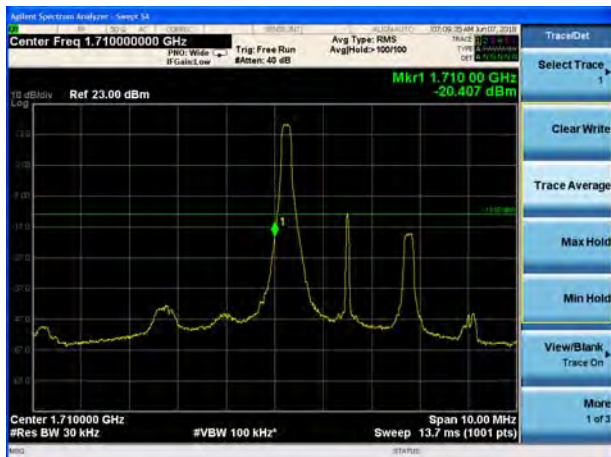

LTE Band 4 QPSK 3MHz CH-High, 1 RB





LTE Band 4 QPSK 3MHz CH-Low, 100%RB



LTE Band 4 QPSK 3MHz CH-High, 100%RB



LTE Band 4 QPSK 5MHz CH-Low, 1 RB

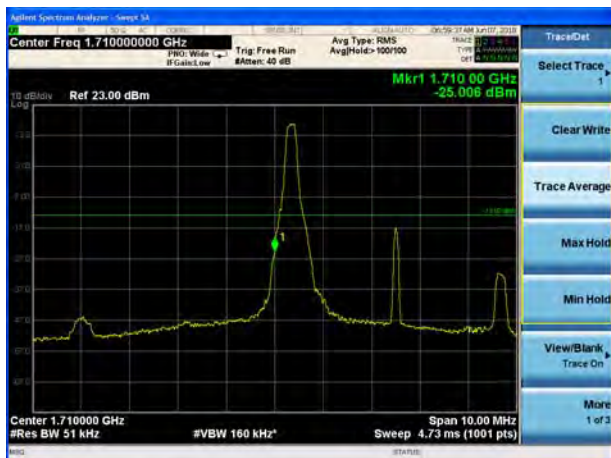

LTE Band 4 QPSK 5MHz CH-High, 1 RB



LTE Band 4 QPSK 5MHz CH-Low, 100%RB



LTE Band 4 QPSK 5MHz CH-High, 100%RB



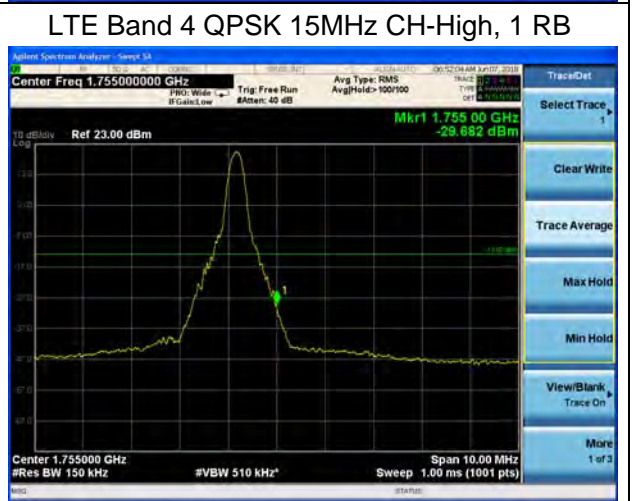
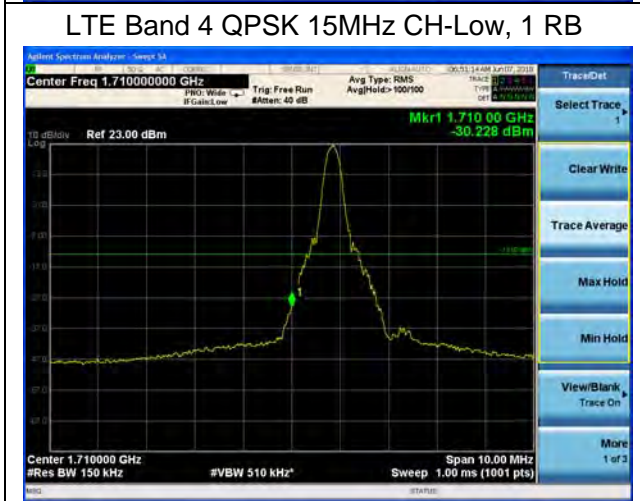
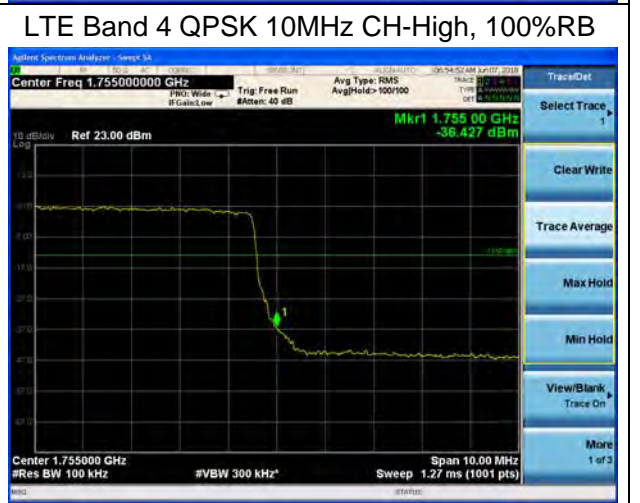
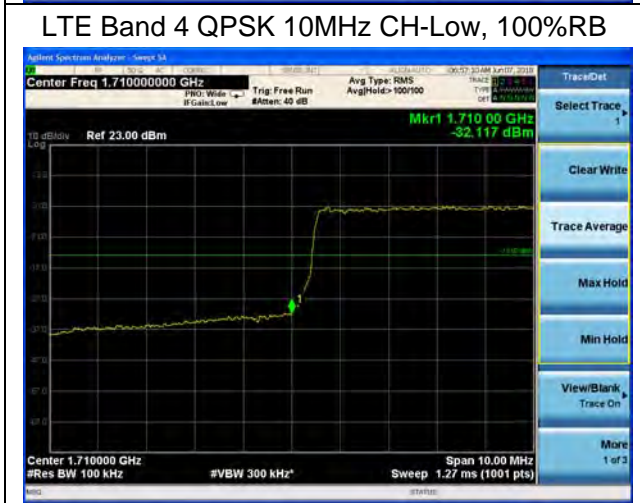
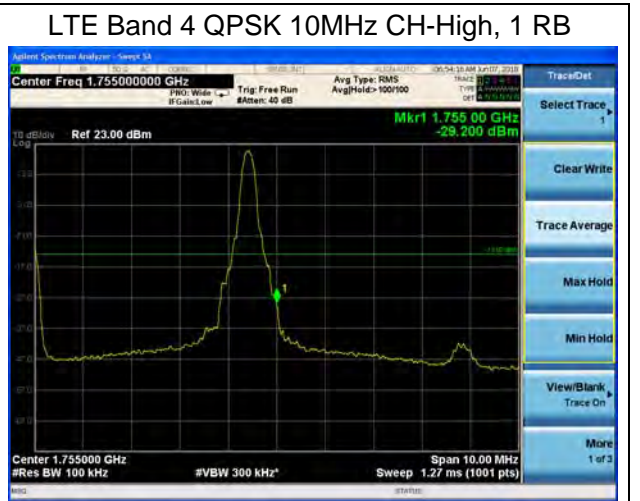
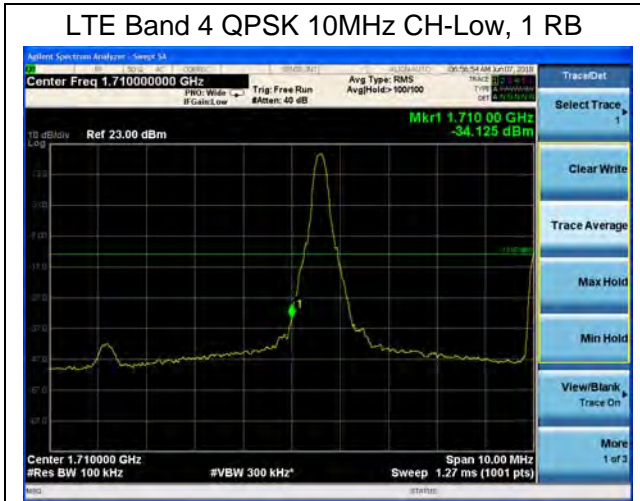

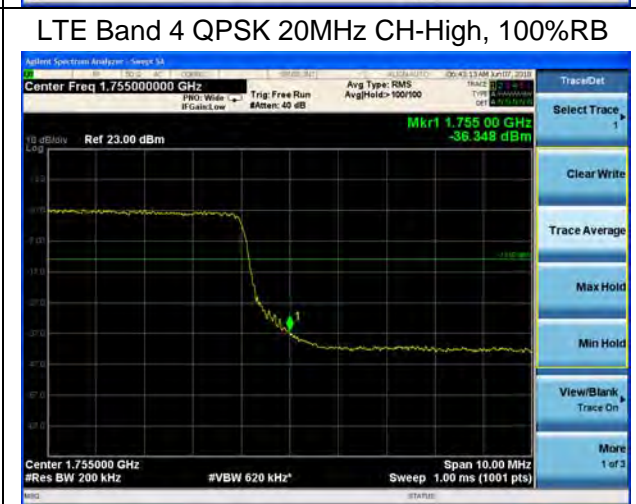
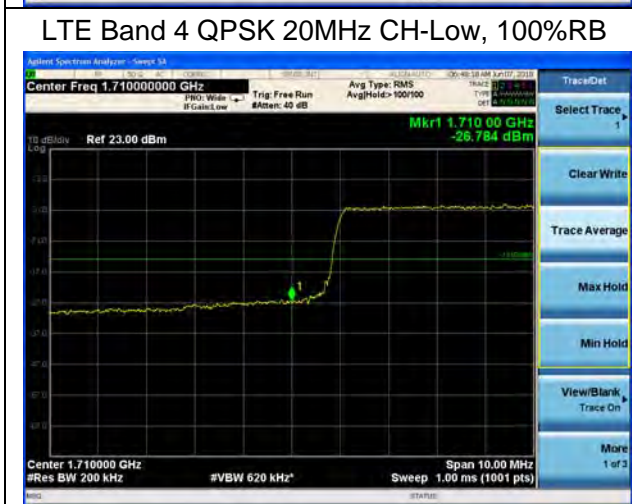
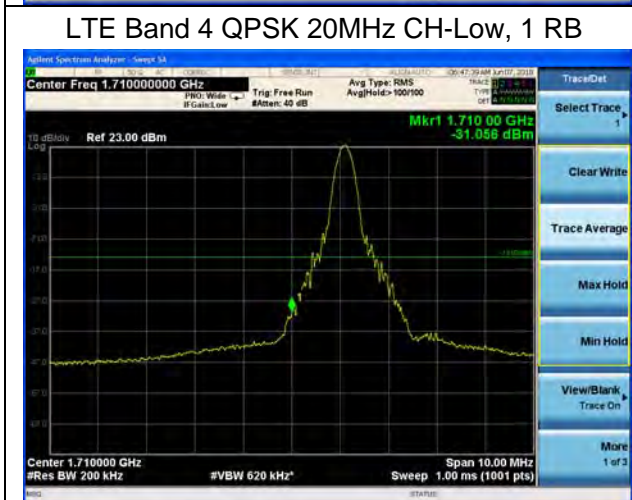
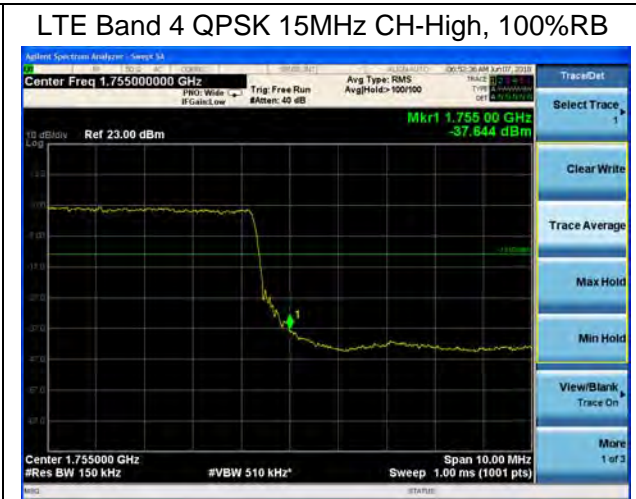
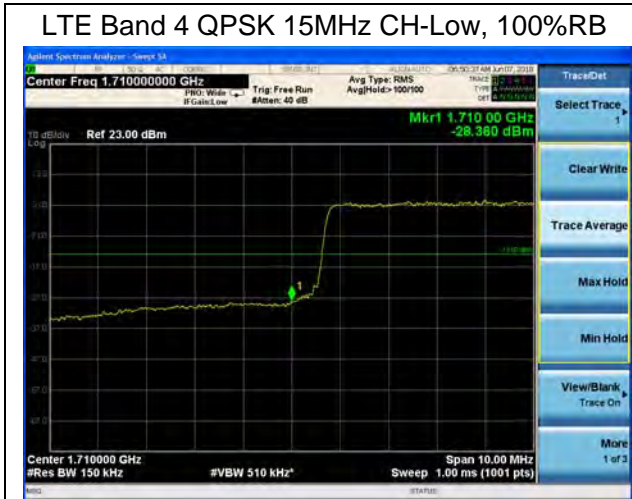

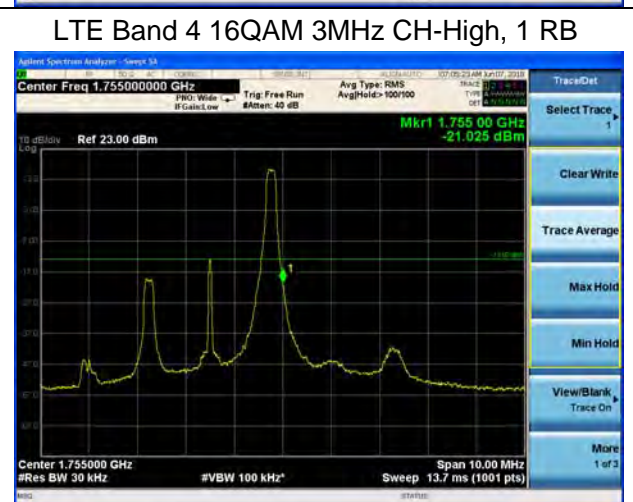
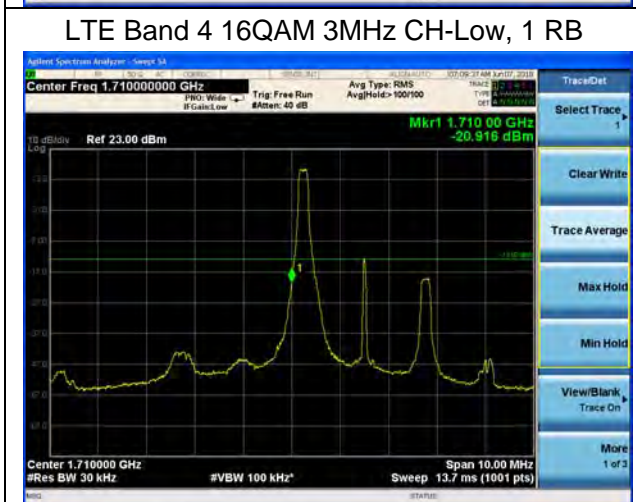
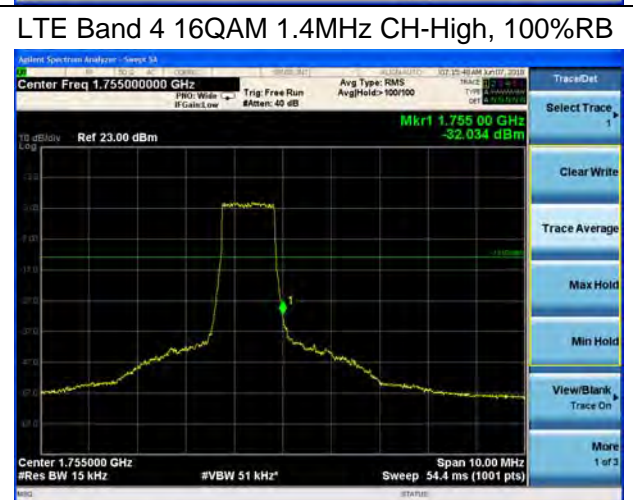
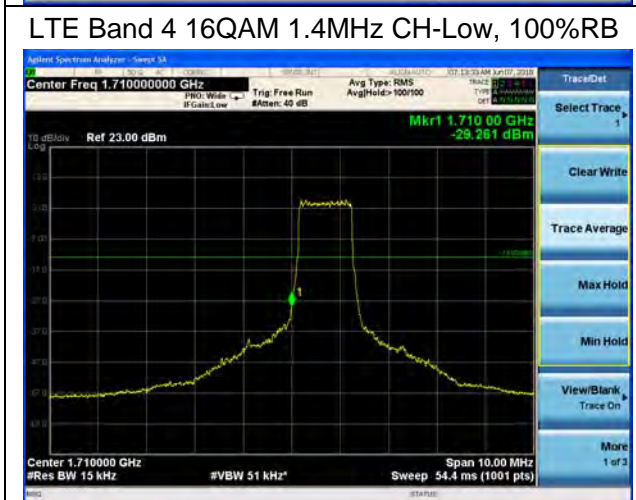
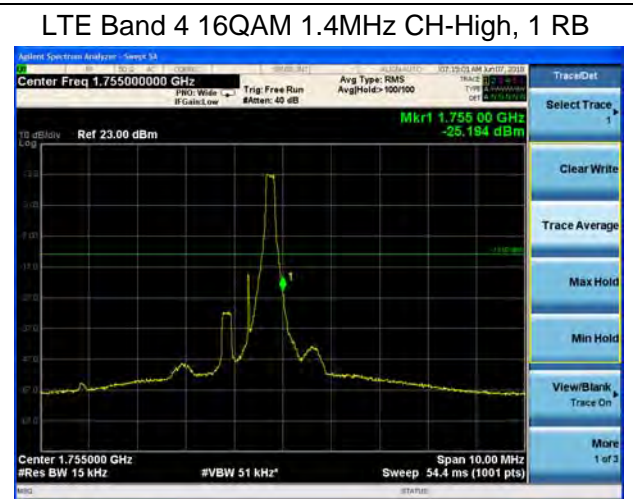
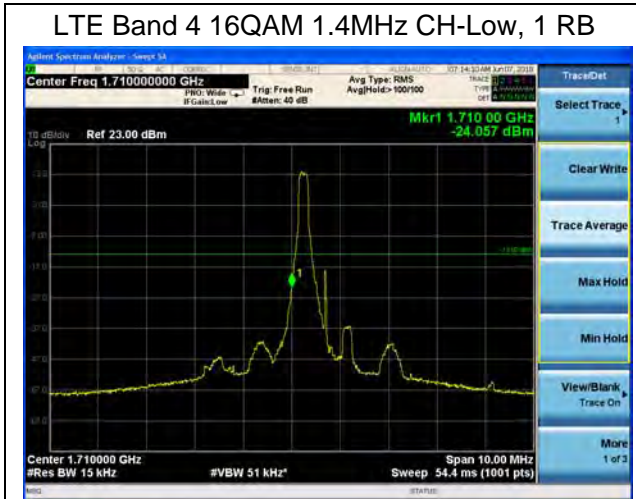



LTE Band 4 16QAM 3MHz CH-Low, 100%RB



LTE Band 4 16QAM 3MHz CH-High, 100%RB



LTE Band 4 16QAM 5MHz CH-Low, 1 RB

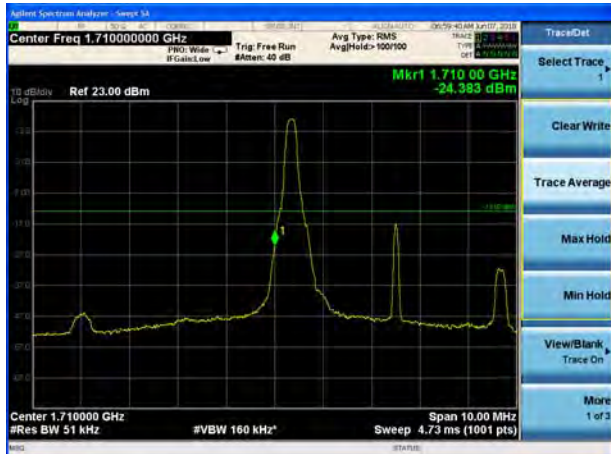

LTE Band 4 16QAM 5MHz CH-High, 1 RB

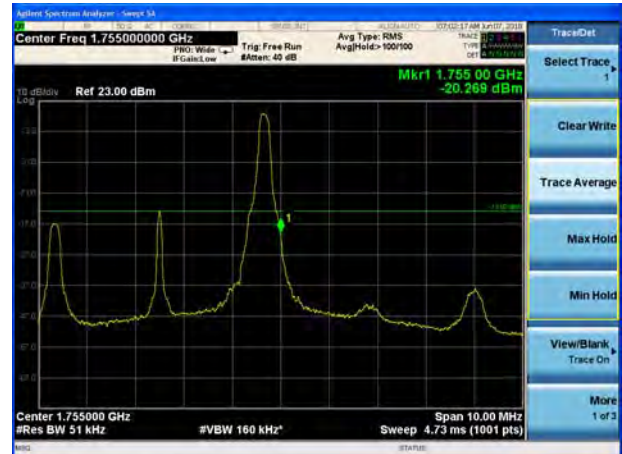

LTE Band 4 16QAM 5MHz CH-Low, 100%RB



LTE Band 4 16QAM 5MHz CH-High, 100%RB



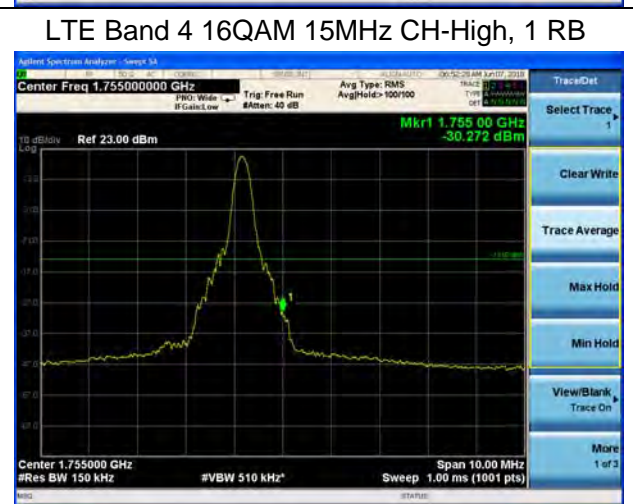
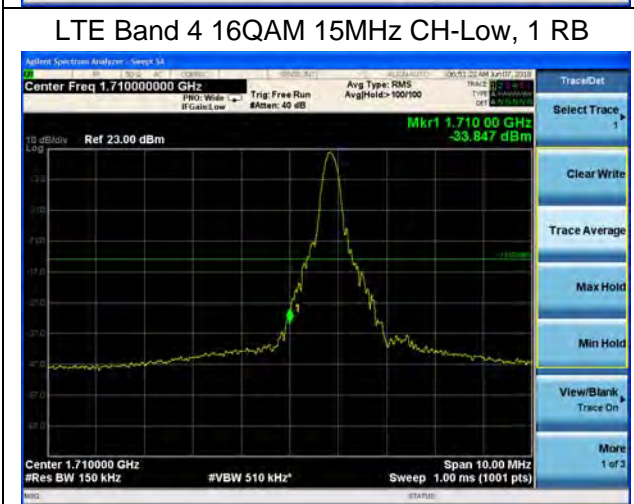
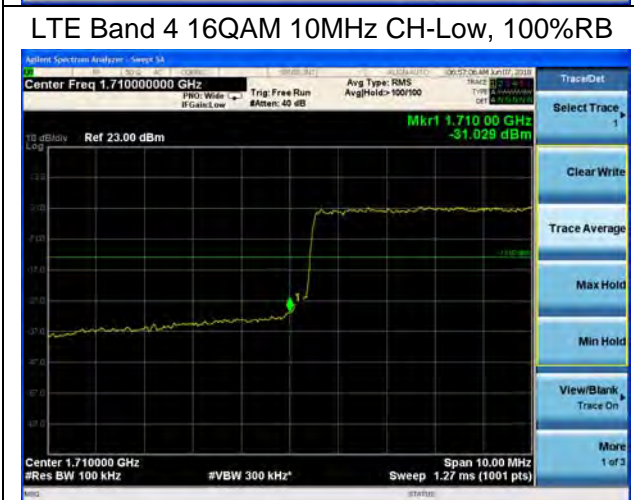
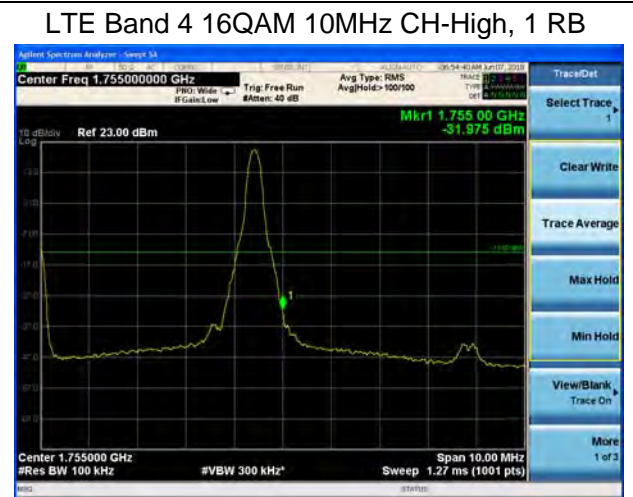
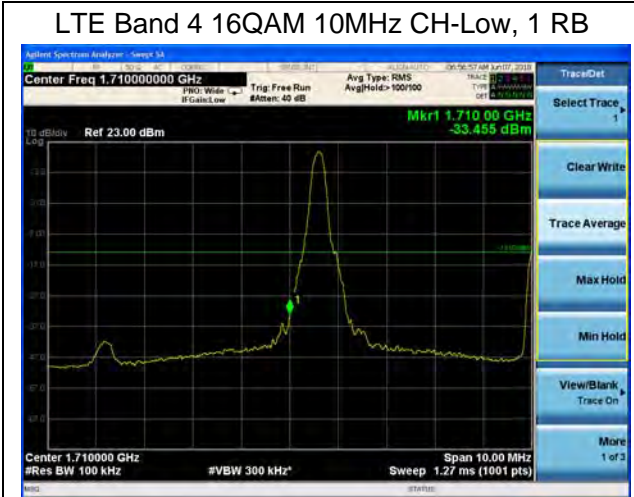

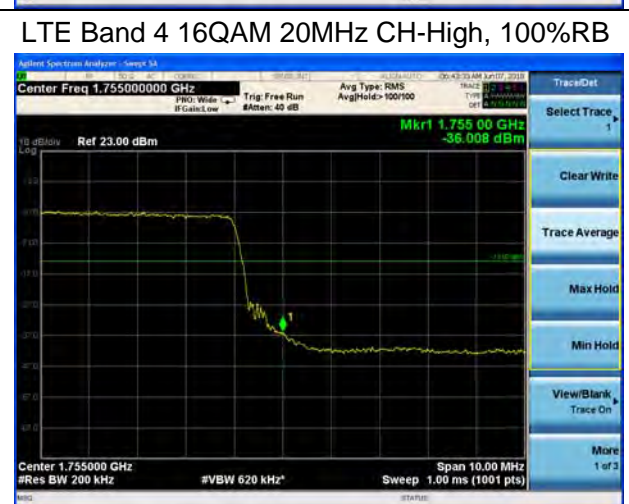
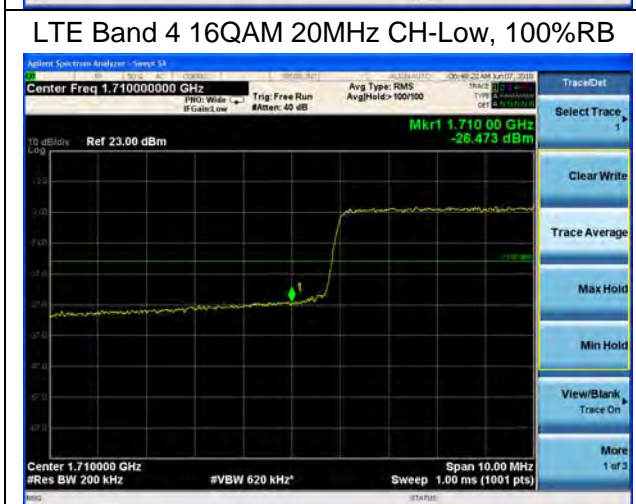
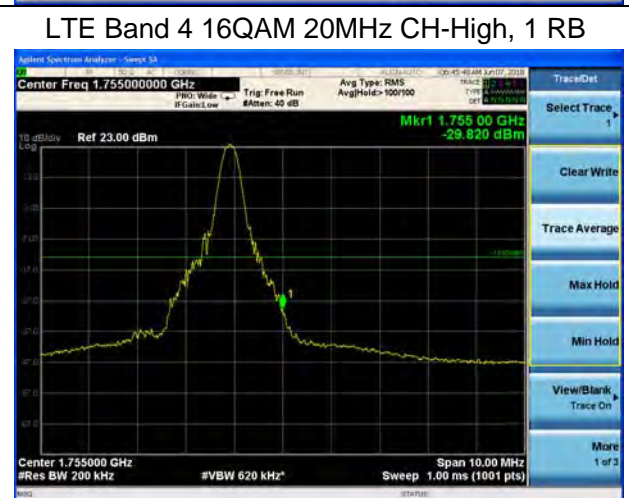
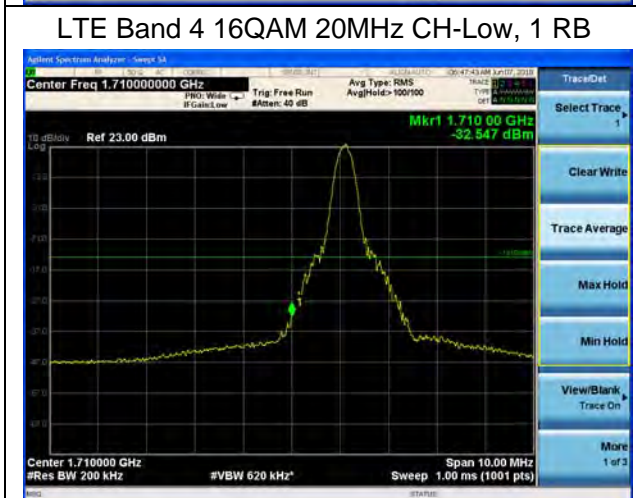
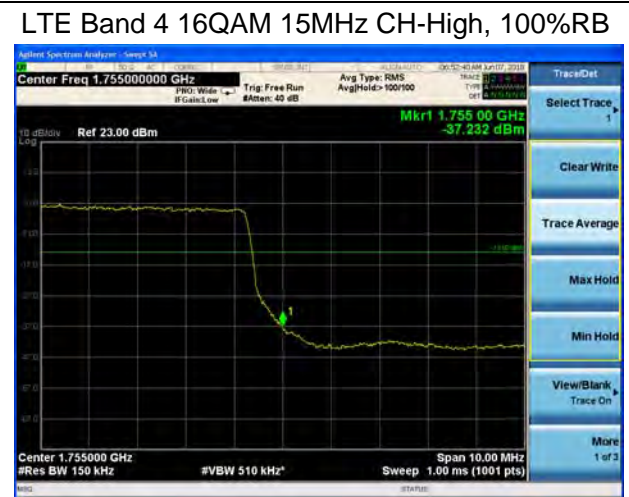
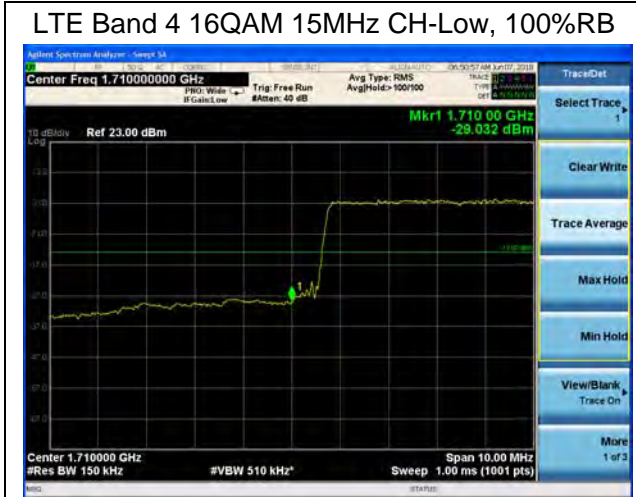



LTE Band 12 QPSK 1.4MHz CH-Low, 1 RB



LTE Band 12 QPSK 1.4MHz CH-High, 1 RB

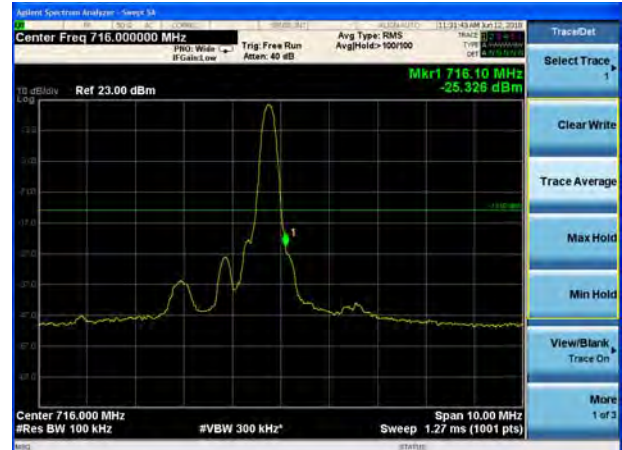

LTE Band 12 QPSK 1.4MHz CH-Low, 100%RB



LTE Band 12 QPSK 1.4MHz CH-High, 100%RB





LTE Band 12 QPSK 3MHz CH-Low, 1 RB

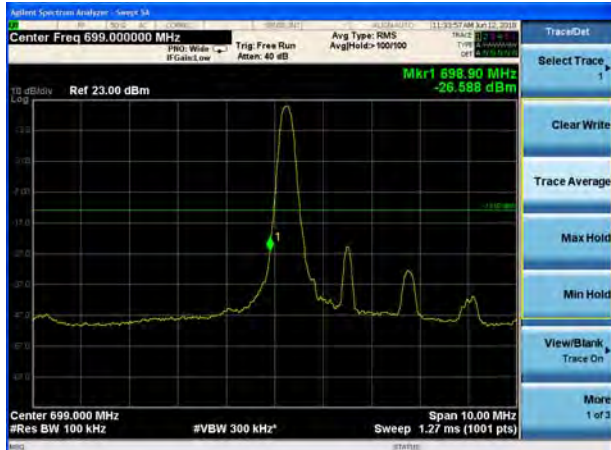

LTE Band 12 QPSK 3MHz CH-High, 1 RB

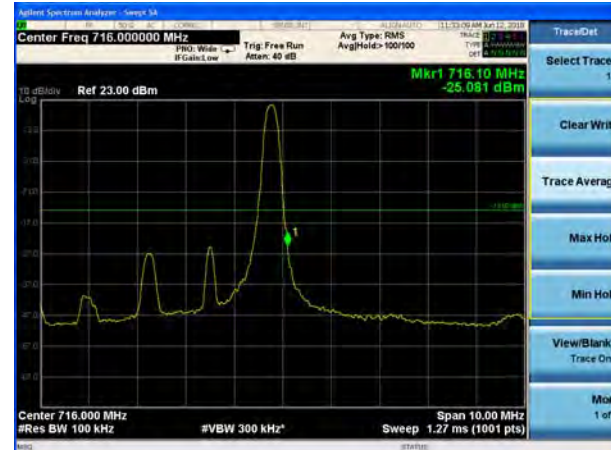

LTE Band 12 QPSK 3MHz CH-Low, 100%RB



LTE Band 12 QPSK 3MHz CH-High, 100%RB

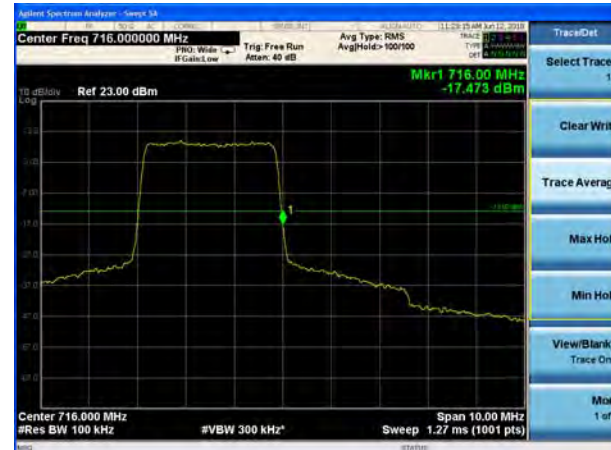

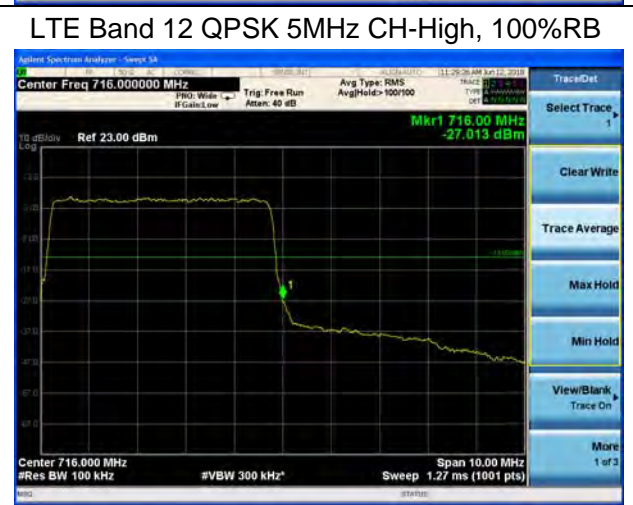
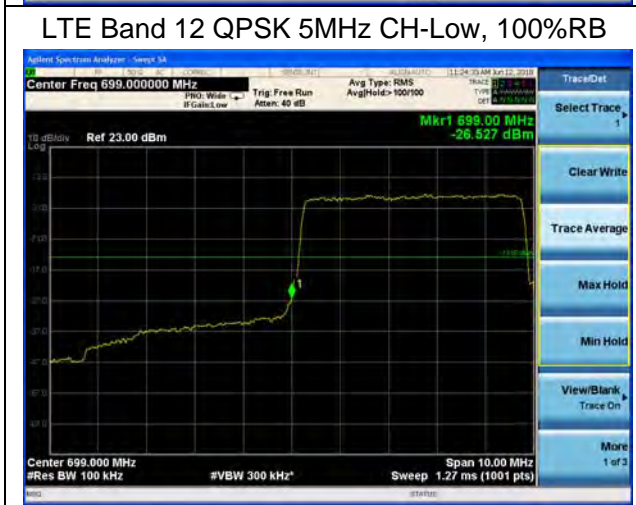
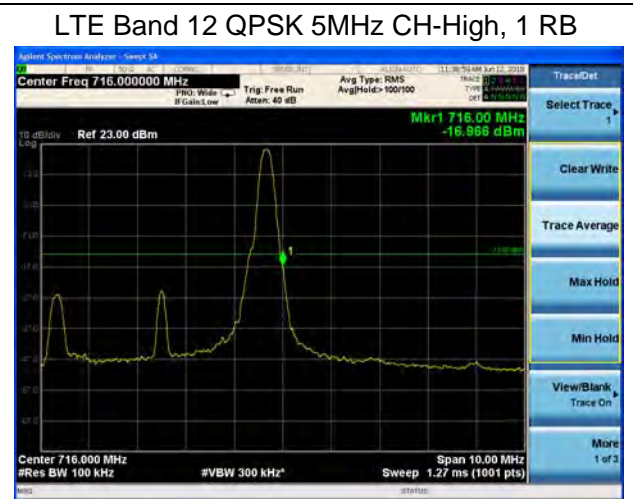
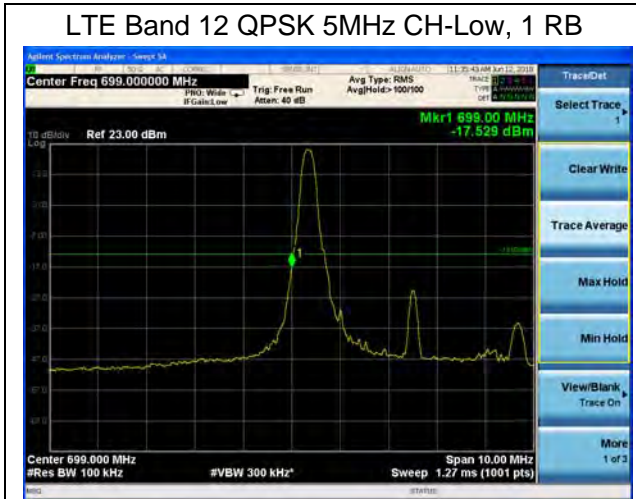



LTE Band 12 QPSK 10MHz CH-Low, 1 RB

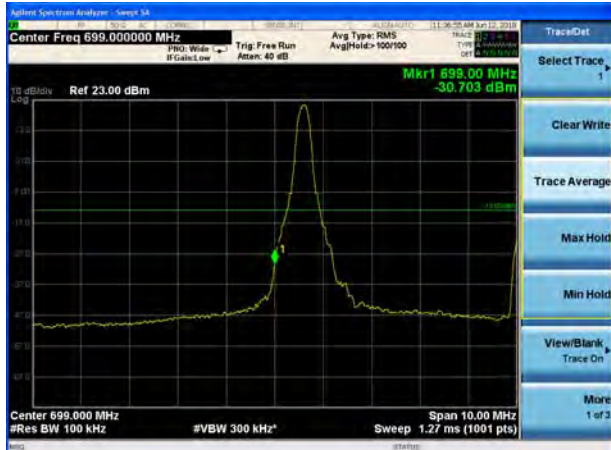

LTE Band 12 QPSK 10MHz CH-High, 1 RB

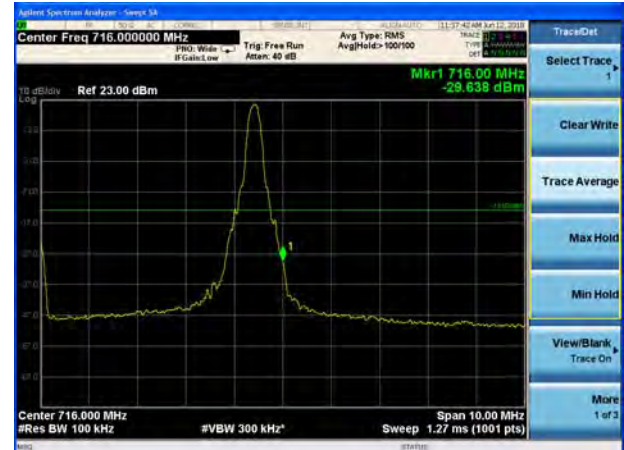

LTE Band 12 QPSK 10MHz CH-Low, 100%RB



LTE Band 12 QPSK 10MHz CH-High, 100%RB



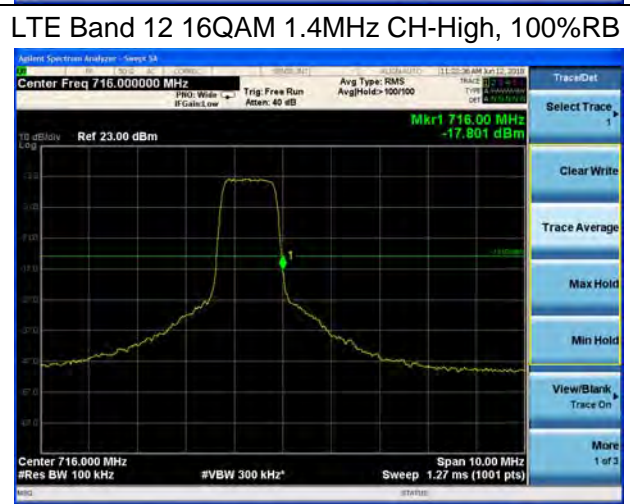
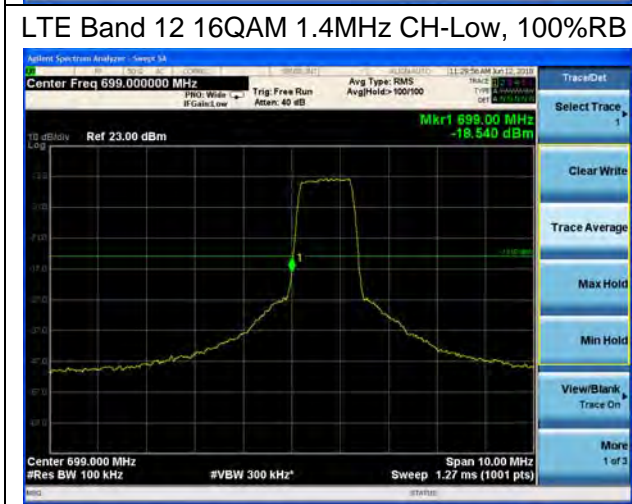
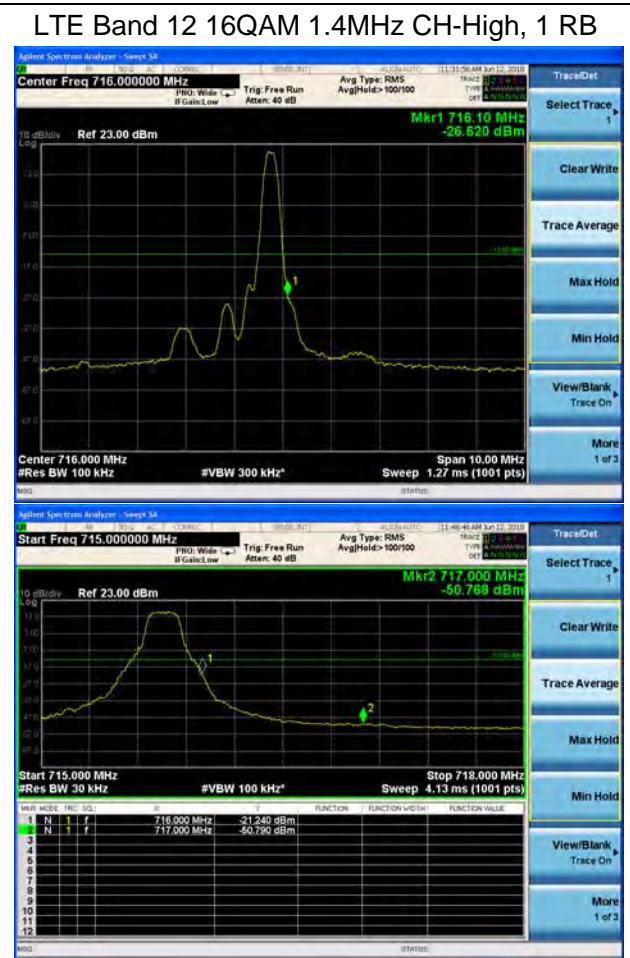

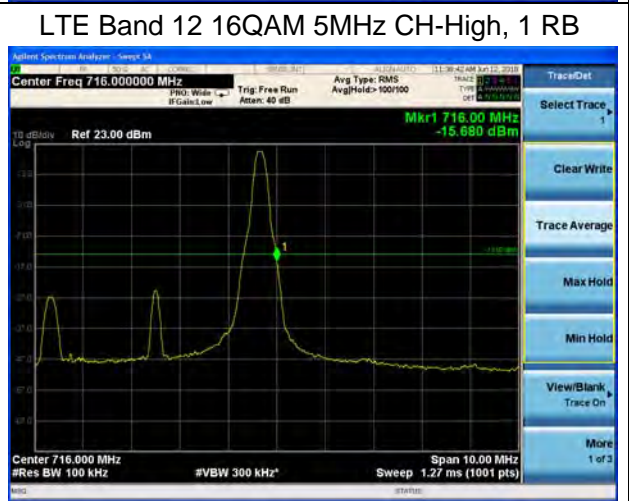
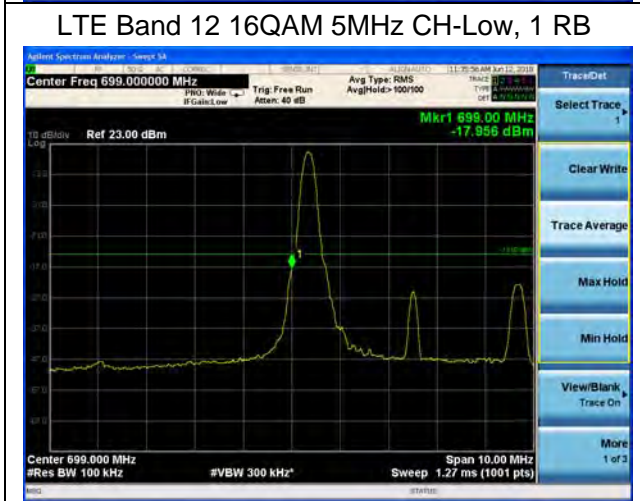
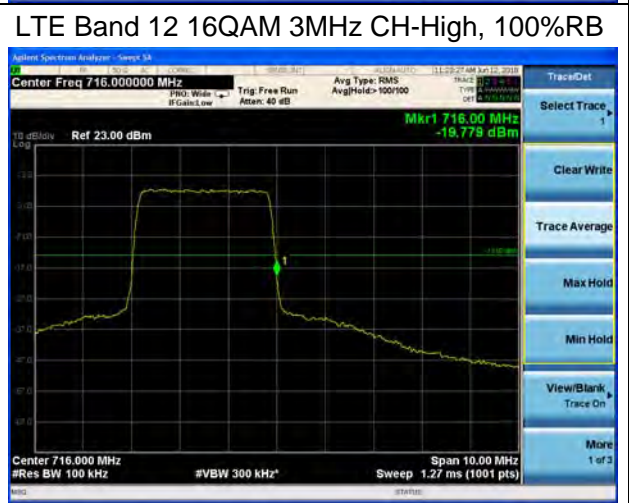
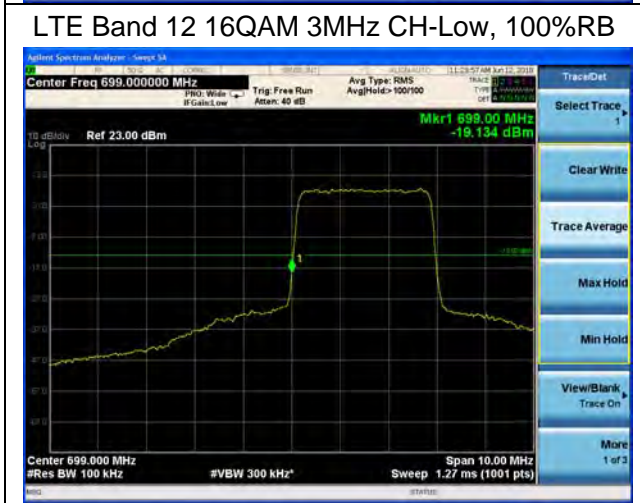
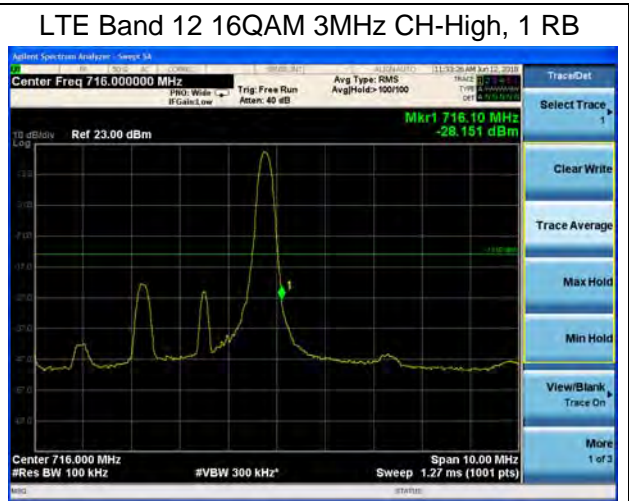
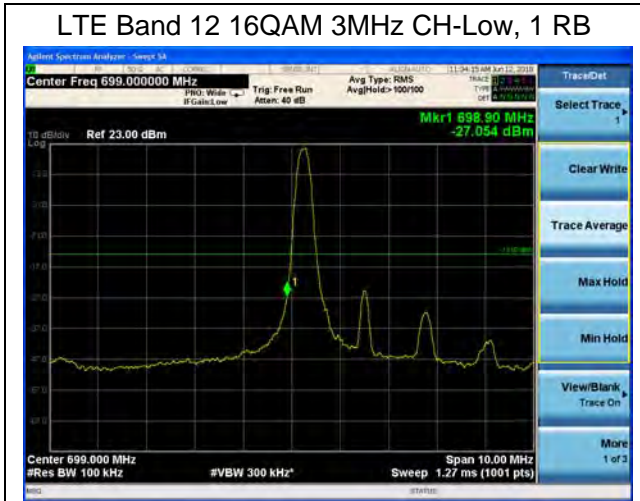

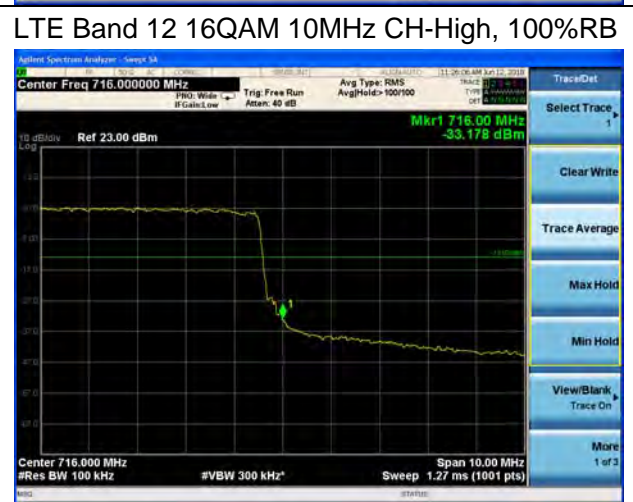
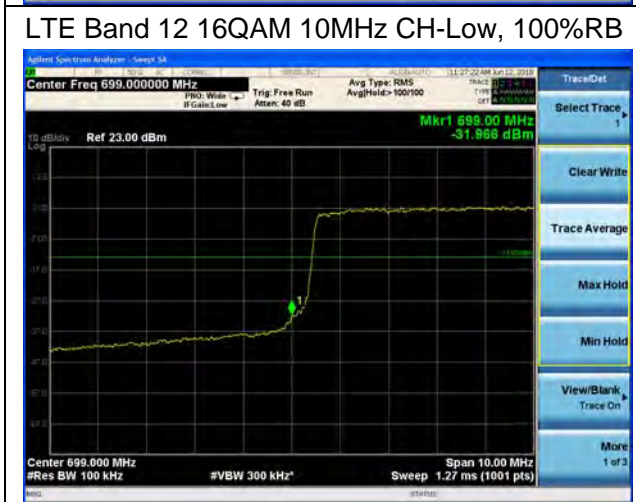
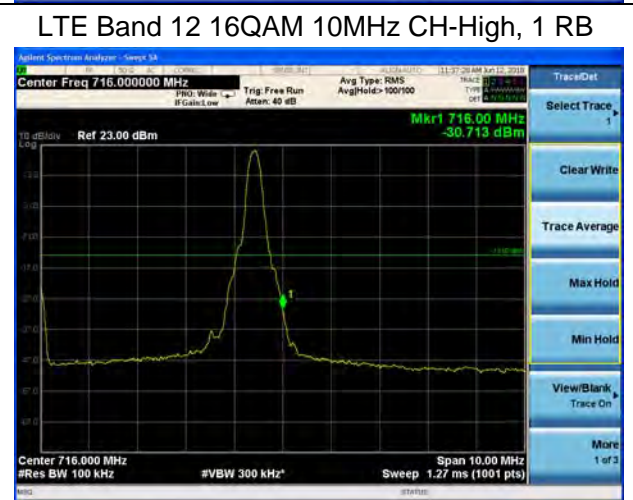
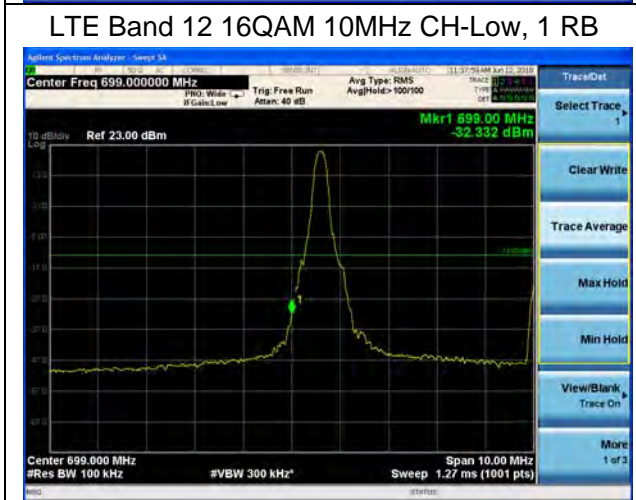
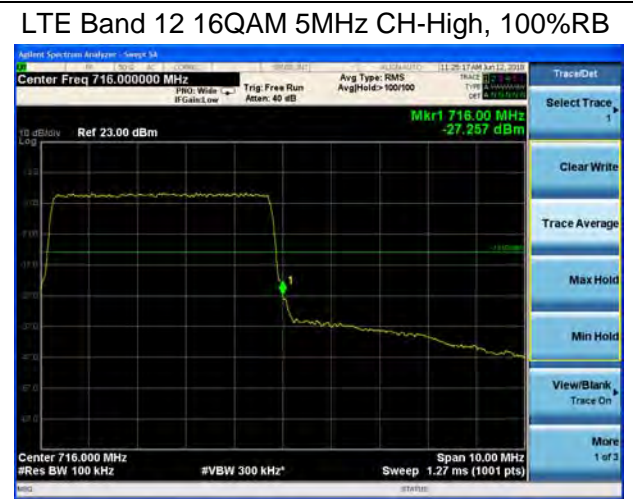



LTE Band 13 QPSK 5MHz CH-Low, 1 RB (763MHz ~775MHz)



LTE Band 13 QPSK 5MHz CH-Low, 1 RB (775MHz ~777MHz)

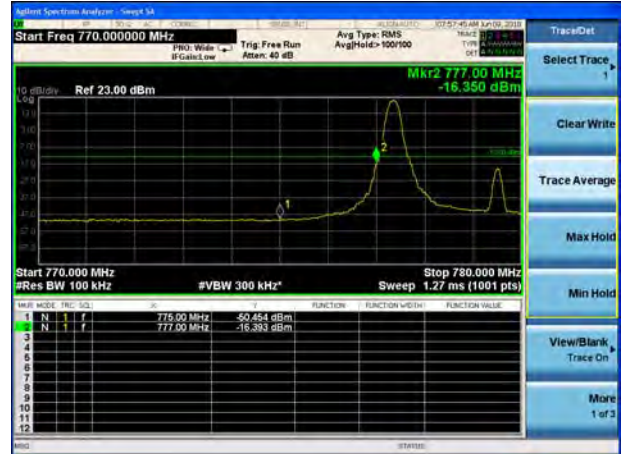

LTE Band 13 QPSK 5MHz CH-High, 1 RB (787MHz ~793MHz)

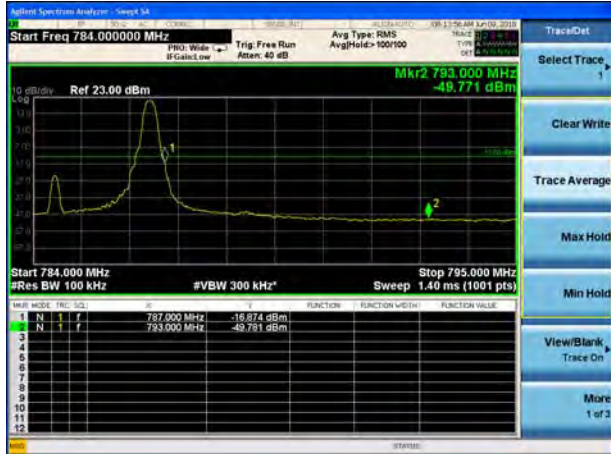

LTE Band 13 QPSK 5MHz CH-High, 1 RB (793MHz ~805MHz)





LTE Band 13 QPSK 5MHz CH-Low, 100%RB (763MHz ~775MHz)



LTE Band 13 QPSK 5MHz CH-Low, 100%RB (775MHz ~777MHz)



LTE Band 13 QPSK 5MHz CH-High, 100%RB (787MHz ~793MHz)



LTE Band 13 QPSK 5MHz CH-High, 100%RB (793MHz ~805MHz)





LTE Band 13 QPSK 10MHz CH-Low, 1 RB (763MHz ~775MHz)



LTE Band 13 QPSK 10MHz CH-Low, 1 RB (775MHz ~777MHz)

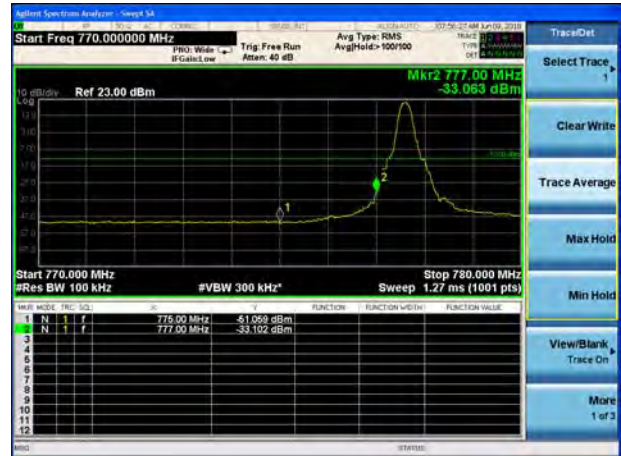

LTE Band 13 QPSK 10MHz CH-High, 1 RB (787MHz ~793MHz)



LTE Band 13 QPSK 10MHz CH-High, 1 RB (793MHz ~805MHz)



LTE Band 13 QPSK 10MHz CH-Low, 100%RB
(763MHz ~775MHz)



LTE Band 13 QPSK 10MHz CH-Low, 100%RB
(775MHz ~777MHz)



LTE Band 13 QPSK 10MHz CH-High, 100%RB
(787MHz ~793MHz)



LTE Band 13 QPSK 10MHz CH-High, 100%RB
(793MHz ~805MHz)





LTE Band 13 16QAM 5MHz CH-Low, 1 RB (763MHz ~775MHz)



LTE Band 13 16QAM 5MHz CH-Low, 1 RB (775MHz ~777MHz)

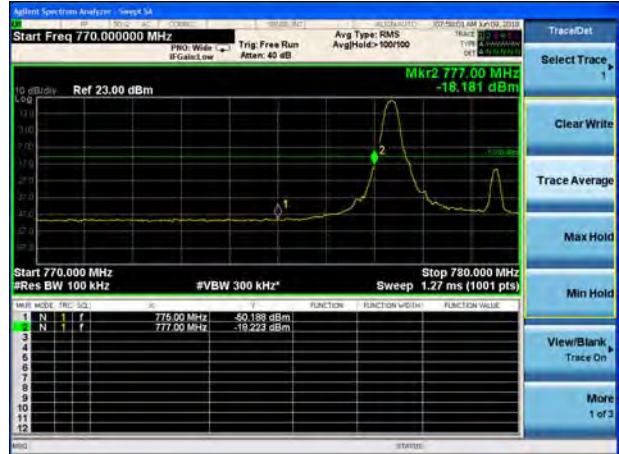

LTE Band 13 16QAM 5MHz CH-High, 1 RB (787MHz ~793MHz)

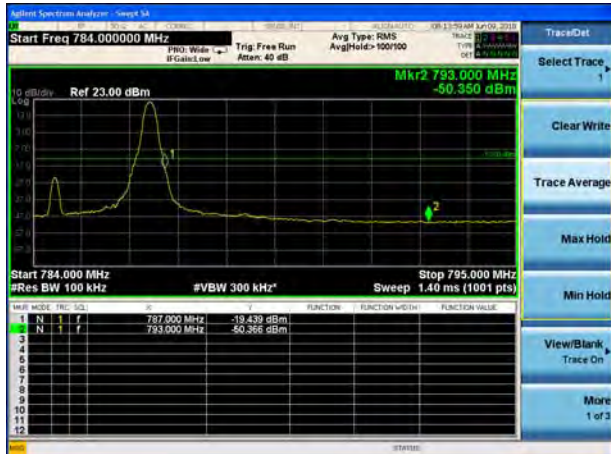

LTE Band 13 16QAM 5MHz CH-High, 1 RB (793MHz ~805MHz)



LTE Band 13 16QAM 5MHz CH-Low, 100%RB
(763MHz ~775MHz)



LTE Band 13 16QAM 5MHz CH-Low, 100%RB
(775MHz ~777MHz)

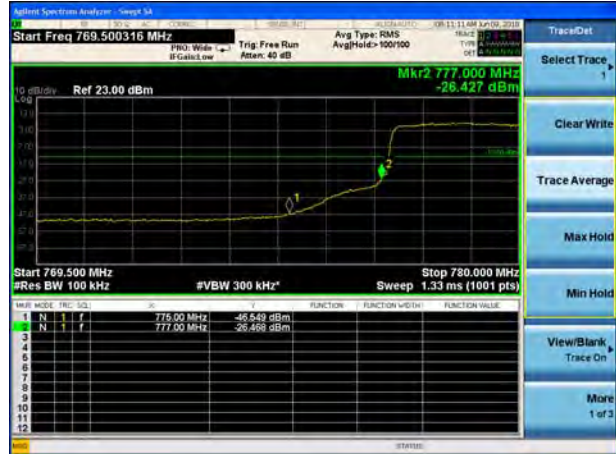

LTE Band 13 16QAM 5MHz CH-High, 100%RB
(787MHz ~793MHz)



LTE Band 13 16QAM 5MHz CH-High, 100%RB
(793MHz ~805MHz)





LTE Band 13 16QAM 10MHz CH-Low, 1 RB (763MHz ~775MHz)



LTE Band 13 16QAM 10MHz CH-Low, 1 RB (775MHz ~777MHz)

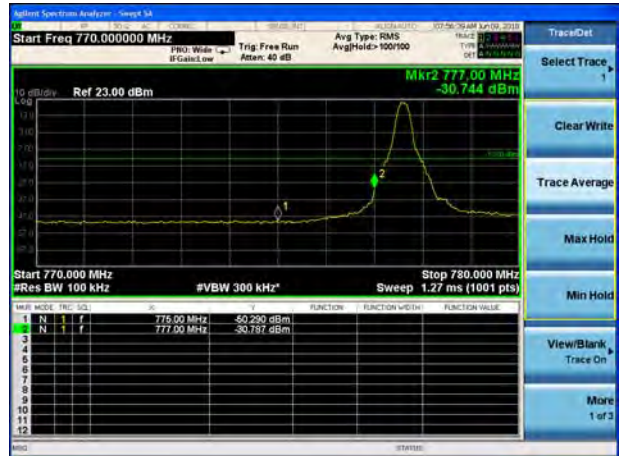

LTE Band 13 16QAM 10MHz CH-High, 1 RB (787MHz ~793MHz)



LTE Band 13 16QAM 10MHz CH-High, 1 RB (793MHz ~805MHz)



LTE Band 13 16QAM 10MHz CH-Low, 100%RB
(763MHz ~775MHz)



LTE Band 13 16QAM 10MHz CH-Low, 100%RB
(775MHz ~777MHz)



LTE Band 13 16QAM 10MHz CH-High, 100%RB
(787MHz ~793MHz)



LTE Band 13 16QAM 10MHz CH-High, 100%RB
(793MHz ~805MHz)



5.5 Peak-to-Average Power Ratio (PAPR)

Ambient condition

Temperature	Relative humidity	Pressure
23°C ~25°C	45%~50%	101.5kPa

Methods of Measurement

Measure the total peak power and record as PPk. And measure the total average power and record as PAvg. Both the peak and average power levels must be expressed in the same logarithmic units (e.g., dBm). Determine the PAPR from:

$$PAPR (dB) = PPk (dBm) - PAvg (dBm).$$

Test Setup

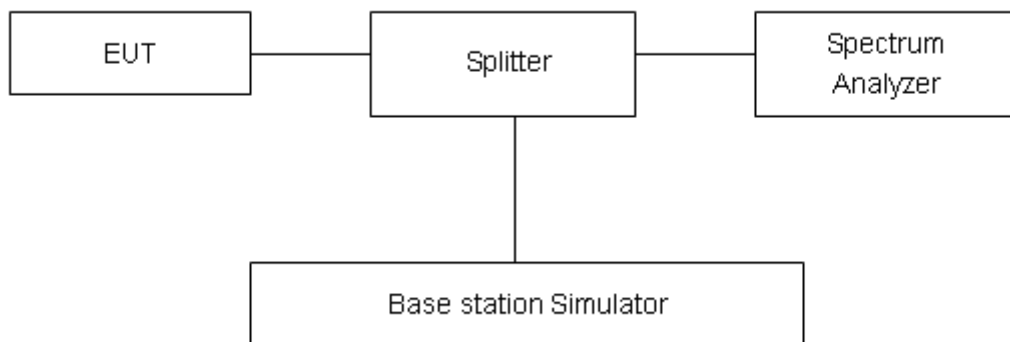

Limits

Rule Part 27.50(d)(5) Equipment employed must be authorized in accordance with the provisions of 24.51. Power measurements for transmissions by stations authorized under this section may be made either in accordance with a Commission-approved average power technique or in compliance with paragraph (d)(6) of this section. In measuring transmissions in this band using an average power technique, the peak-to-average ratio (PAR) of the transmission may not exceed 13 dB.

Measurement Uncertainty

The assessed measurement uncertainty to ensure 95% confidence level for the normal distribution is with the coverage factor $k = 2$, $U = 0.4$ dB.

Test Results

WCDMA Band IV	Channel	Frequency (MHz)	Peak (dBm)	Avg (dBm)	PAPR (dB)	Limit (dB)	Conclusion
RMC	1312	1712.4	26.81	23.56	3.25	≤13	PASS
	1413	1732.6	26.91	23.56	3.35	≤13	PASS
	1513	1752.6	26.45	23.50	2.95	≤13	PASS

LTE Band 4								
Modulation	Bandwidth (MHz)	Channel	Frequency (MHz)	Peak (dBm)	Avg (dBm)	PAPR (dB)	Limit (dB)	Conclusion
QPSK	1.4	19957	1710.7	28.22	22.70	5.52	≤13	PASS
		20175	1732.5	28.42	22.91	5.51	≤13	PASS
		20393	1754.3	28.47	22.91	5.56	≤13	PASS
	3	19965	1711.5	28.01	22.73	5.28	≤13	PASS
		20175	1732.5	28.25	22.95	5.30	≤13	PASS
		20385	1753.5	28.29	22.94	5.35	≤13	PASS
	5	19975	1712.5	28.40	22.71	5.69	≤13	PASS
		20175	1732.5	28.58	22.94	5.64	≤13	PASS
		20375	1752.5	28.67	22.92	5.75	≤13	PASS
	10	20000	1715	28.11	22.79	5.32	≤13	PASS
		20175	1732.5	28.22	22.96	5.26	≤13	PASS
		20350	1750	28.33	22.96	5.37	≤13	PASS
	15	20025	1717.5	29.25	22.77	6.48	≤13	PASS
		20175	1732.5	29.40	22.92	6.48	≤13	PASS
		20325	1747.5	29.46	22.91	6.55	≤13	PASS
	20	20050	1720	29.08	22.74	6.34	≤13	PASS
		20175	1732.5	29.22	22.87	6.35	≤13	PASS
		20300	1745	29.33	22.87	6.46	≤13	PASS
16QAM	1.4	19957	1710.7	28.43	21.86	6.57	≤13	PASS
		20175	1732.5	28.41	21.88	6.53	≤13	PASS
		20393	1754.3	28.60	21.97	6.63	≤13	PASS
	3	19965	1711.5	28.26	21.89	6.37	≤13	PASS
		20175	1732.5	28.23	21.92	6.31	≤13	PASS
		20385	1753.5	28.45	22.00	6.45	≤13	PASS
	5	19975	1712.5	27.49	21.87	5.62	≤13	PASS
		20175	1732.5	27.95	21.88	6.07	≤13	PASS
		20375	1752.5	27.15	21.95	5.20	≤13	PASS
	10	20000	1715	28.33	21.90	6.43	≤13	PASS
		20175	1732.5	27.48	21.93	5.55	≤13	PASS
		20350	1750	27.23	21.99	5.24	≤13	PASS



	15	20025	1717.5	27.30	21.87	5.43	≤13	PASS
		20175	1732.5	27.85	21.88	5.97	≤13	PASS
		20325	1747.5	28.00	21.95	6.05	≤13	PASS
	20	20050	1720	28.72	21.85	6.87	≤13	PASS
		20175	1732.5	28.97	21.84	7.13	≤13	PASS
		20300	1745	27.97	21.92	6.05	≤13	PASS

LTE Band 12								
Modulation	Bandwidth (MHz)	Channel	Frequency (MHz)	Peak (dBm)	Avg (dBm)	PAPR (dB)	Limit (dB)	Conclusion
QPSK	1.4	23017	699.7	28.94	22.54	6.40	≤13	PASS
		23095	707.5	29.03	22.53	6.50	≤13	PASS
		23173	715.3	29.60	22.65	6.95	≤13	PASS
	3	23025	700.5	29.76	22.63	7.13	≤13	PASS
		23095	707.5	28.96	22.58	6.38	≤13	PASS
		23165	714.5	29.25	22.70	6.55	≤13	PASS
	5	23035	701.5	29.93	22.61	7.32	≤13	PASS
		23095	707.5	29.44	22.54	6.90	≤13	PASS
		23155	713.5	29.57	22.65	6.92	≤13	PASS
	10	23060	704	30.76	22.58	8.18	≤13	PASS
		23095	707.5	29.01	22.49	6.52	≤13	PASS
		23130	711	29.12	22.61	6.51	≤13	PASS
16QAM	1.4	23017	699.7	29.04	21.44	7.60	≤13	PASS
		23095	707.5	28.94	21.60	7.34	≤13	PASS
		23173	715.3	29.44	21.69	7.75	≤13	PASS
	3	23025	700.5	29.07	21.48	7.59	≤13	PASS
		23095	707.5	29.26	21.65	7.61	≤13	PASS
		23165	714.5	28.98	21.71	7.27	≤13	PASS
	5	23035	701.5	28.61	21.45	7.16	≤13	PASS
		23095	707.5	29.26	21.60	7.66	≤13	PASS
		23155	713.5	29.29	21.67	7.62	≤13	PASS
	10	23060	704	29.35	21.43	7.92	≤13	PASS
		23095	707.5	28.82	21.56	7.26	≤13	PASS
		23130	711	29.32	21.64	7.68	≤13	PASS

LTE Band 13								
Modulation	Bandwidth (MHz)	Channel	Frequency (MHz)	Peak (dBm)	Avg (dBm)	PAPR (dB)	Limit (dB)	Conclusion
QPSK	5	23205	779.5	29.29	22.56	6.73	≤13	PASS
		23230	782	30.23	22.69	7.54	≤13	PASS
		23255	784.5	29.60	22.59	7.01	≤13	PASS
	10	23230	782	28.56	22.69	5.87	≤13	PASS
16QAM	5	23205	779.5	27.98	21.64	6.34	≤13	PASS
		23230	782	28.08	21.81	6.27	≤13	PASS
		23255	784.5	28.74	21.69	7.05	≤13	PASS
	10	23230	782	28.46	21.62	6.84	≤13	PASS

5.6 Frequency Stability

Ambient condition

Temperature	Relative humidity	Pressure
23°C ~25°C	45%~50%	101.5kPa

Method of Measurement

Frequency Stability (Temperature Variation)

The temperature inside the climate chamber is varied from -40°C to +85°C in 10°C step size.

(1) With all power removed, the temperature was decreased to -10°C and permitted to stabilize for three hours.

(2) Measure the carrier frequency with the test equipment in a “call mode”. These measurements should be made within 1 minute of powering up the mobile station, to prevent significant self warming.

(3) Repeat the above measurements at 10°C increments from -40°C to +85°C. Allow at least 1.5 hours at each temperature, un-powered, before making measurements.

Frequency Stability (Voltage Variation)

The frequency stability shall be measured with variation of primary supply voltage as follows:

(1) Vary primary supply voltage from 85 to 115 percent of the nominal value for other than hand carried battery equipment.

(2) For hand carried, battery powered equipment, reduce primary supply voltage to the battery-operating end point which shall be specified by the manufacturer.

This transceiver is specified to operate with an input voltage of between 3.3 V and 4.3 V, with a nominal voltage of 3.8V.

Test setup

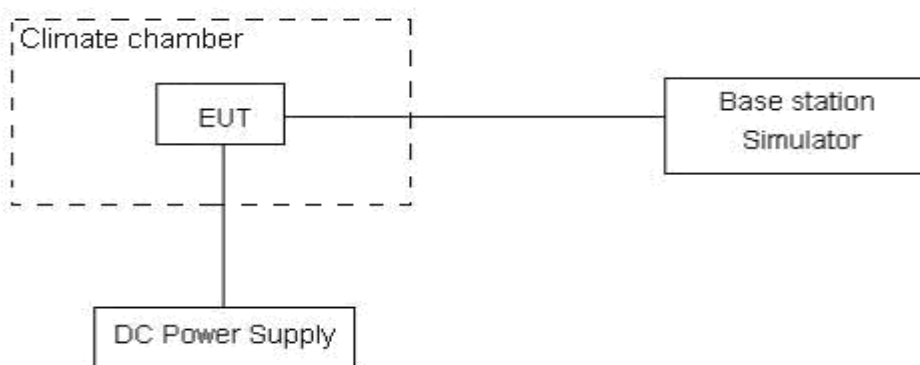

Limits

No specific frequency stability requirements in part 27.54

Measurement Uncertainty

The assessed measurement uncertainty to ensure 99.75% confidence level for the normal distribution is with the coverage factor $k = 3, U=0.01\text{ppm}$.

Test Result

WCDMA Band IV					
(QPSK, 20MHz BANDWIDTH)					
Condition		1710	1755	Delta (Hz)	Frequency Stability(ppm)
Temperature	Voltage	F low@-13dBm(MHz)	F high@-13dBm(MHz)		
Normal (25°C)	Normal	1710.0279	1754.9113	-1.67	-0.00089
Extreme (85°C)		1710.0281	1754.9112	1.86	0.00099
Extreme (80°C)		1710.0276	1754.9116	0.76	0.00041
Extreme (70°C)		1710.0291	1754.9101	1.10	0.00059
Extreme (60°C)		1710.0272	1754.9122	0.53	0.00028
Extreme (50°C)		1710.0269	1754.9123	-1.69	-0.00090
Extreme (40°C)		1710.0284	1754.9108	-1.71	-0.00091
Extreme (30°C)		1710.0273	1754.9119	-1.74	-0.00092
Extreme (20°C)		1710.0271	1754.9122	-2.55	-0.00135
Extreme (10°C)		1710.0286	1754.9106	-0.12	-0.00006
Extreme (0°C)		1710.0277	1754.9115	-2.82	-0.00150
Extreme (-10°C)		1710.0291	1754.9122	-1.44	-0.00077
Extreme (-20°C)		1710.0323	1754.9153	2.09	0.00111
Extreme (-30°C)		1710.0339	1754.9175	0.99	0.00053
Extreme (-40°C)		1710.0345	1754.9187	1.33	0.00071
25°C	LV	1710.0316	1754.9147	-1.46	-0.00078
	HV	1710.0303	1754.9156	-1.48	-0.00079

LTE Band 4					
(QPSK, 20MHz BANDWIDTH)					
Condition		1710	1755	Delta (Hz)	Frequency Stability(ppm)
Temperature	Voltage	F low@-13dBm(MHz)	F high@-13dBm(MHz)		
Normal (25°C)	Normal	1710.6538	1754.4302	2.85	0.00165
Extreme (85°C)		1710.6549	1754.4314	-1.94	-0.00112
Extreme (80°C)		1710.6516	1754.4275	-0.59	-0.00034
Extreme (70°C)		1710.6529	1754.4294	2.36	0.00136
Extreme (60°C)		1710.6515	1754.4285	-2.76	-0.00159
Extreme (50°C)		1710.6521	1754.4286	-0.49	-0.00028
Extreme (40°C)		1710.6534	1754.4299	2.02	0.00117
Extreme (30°C)		1710.6541	1754.4306	0.39	0.00023
Extreme (20°C)		1710.6523	1754.4285	4.42	0.00255
Extreme (10°C)		1710.6532	1754.4297	2.96	0.00171
Extreme (0°C)		1710.6519	1754.4284	0.33	0.00019
Extreme (-10°C)		1710.6514	1754.4279	-0.59	-0.00034

Extreme (-20°C)		1710.6525	1754.4291	-2.76	-0.00159
Extreme (-30°C)		1710.6558	1754.4323	-0.49	-0.00028
Extreme (-40°C)		1710.6576	1754.4335	4.42	0.00255
25°C	LV	1710.6522	1754.4287	-1.44	-0.00083
	HV	1710.6528	1754.4293	-0.43	-0.00025
(16QAM,20MHz BANDWIDTH)					
Condition		1710	1755	Delta (Hz)	Frequency Stability(ppm)
Temperature	Voltage	F low@-13dBm(MHz)	F high@-13dBm(MHz)		
Normal (25°C)	Normal	1710.6387	1754.5105	5.16	0.00298
Extreme (85°C)		1710.6369	1754.5094	1.12	0.00065
Extreme (80°C)		1710.6408	1754.5133	-0.57	-0.00033
Extreme (70°C)		1710.6389	1754.5114	3.36	0.00194
Extreme (60°C)		1710.6403	1754.5128	1.46	0.00084
Extreme (50°C)		1710.6397	1754.5122	0.99	0.00057
Extreme (40°C)		1710.6384	1754.5109	-0.43	-0.00025
Extreme (30°C)		1710.6377	1754.5102	-3.58	-0.00207
Extreme (20°C)		1710.6398	1754.5123	3.19	0.00184
Extreme (10°C)		1710.6386	1754.5111	0.60	0.00035
Extreme (0°C)		1710.6399	1754.5124	-0.41	-0.00024
Extreme (-10°C)		1710.6404	1754.5129	1.12	0.00065
Extreme (-20°C)		1710.6393	1754.5118	-0.57	-0.00033
Extreme (-30°C)		1710.6363	1754.5085	1.46	0.00084
Extreme (-40°C)		1710.6348	1754.5073	-0.43	-0.00025
25°C	LV	1710.6396	1754.5121	2.50	0.00144
	HV	1710.6391	1754.5115	4.01	0.00231

LTE Band 12					
(QPSK, 20MHz BANDWIDTH)					
Condition		699	716	Delta (Hz)	Frequency Stability(ppm)
Temperature	Voltage	F low@-13dBm(MHz)	F high@-13dBm(MHz)		
Normal (25°C)	Normal	699.2572	715.7323	3.24	0.00387
Extreme (85°C)		699.2583	715.7311	2.60	0.00311
Extreme (80°C)		699.2544	715.7272	1.62	0.00193
Extreme (70°C)		699.2563	715.7291	2.57	0.00307
Extreme (60°C)		699.2549	715.7277	-1.22	-0.00146
Extreme (50°C)		699.2555	715.7283	0.51	0.00061
Extreme (40°C)		699.2568	715.7296	1.50	0.00179
Extreme (30°C)		699.2575	715.7303	1.25	0.00149
Extreme (20°C)		699.2554	715.7282	-1.18	-0.00141



Extreme (10°C)		699.2566	715.7294	-0.34	-0.00041
Extreme (0°C)		699.2553	715.7281	-2.09	-0.00249
Extreme (-10°C)		699.2548	715.7276	-3.04	-0.00363
Extreme (-20°C)		699.2559	715.7287	-2.96	-0.00354
Extreme (-30°C)		699.2592	715.7324	-0.11	-0.00013
Extreme (-40°C)		699.2604	715.7332	0.95	0.00114
25°C	LV	699.2556	715.7284	3.08	0.00369
	HV	699.2562	715.7295	1.55	0.00186
(16QAM,20MHz BANDWIDTH)					
Condition		699	716	Delta (Hz)	Frequency Stability(ppm)
Temperature	Voltage	F low@-13dBm(MHz)	F high@-13dBm(MHz)		
Normal (25°C)	Normal	699.3118	715.6805	0.45	0.00054
Extreme (85°C)		699.3107	715.6794	0.89	0.00106
Extreme (80°C)		699.3146	715.6833	1.11	0.00132
Extreme (70°C)		699.3127	715.6814	-1.98	-0.00237
Extreme (60°C)		699.3141	715.6828	1.81	0.00216
Extreme (50°C)		699.3135	715.6822	2.57	0.00307
Extreme (40°C)		699.3122	715.6809	0.21	0.00025
Extreme (30°C)		699.3115	715.6802	6.10	0.00729
Extreme (20°C)		699.3136	715.6823	1.50	0.00179
Extreme (10°C)		699.3124	715.6811	-0.22	-0.00027
Extreme (0°C)		699.3137	715.6824	-0.15	-0.00018
Extreme (-10°C)		699.3142	715.6829	-3.03	-0.00362
Extreme (-20°C)		699.3131	715.6818	-4.13	-0.00494
Extreme (-30°C)		699.3098	715.6785	0.65	0.00078
Extreme (-40°C)	699.3086	715.6773	0.81	0.00097	
25°C	LV	699.3134	715.6821	3.35	0.00401
	HV	699.3128	715.6815	1.90	0.00228

LTE Band13					
(QPSK, 20MHz BANDWIDTH)					
Condition		777	787	Delta (Hz)	Frequency Stability(ppm)
Temperature	Voltage	F low@-13dBm(MHz)	F high@-13dBm(MHz)		
Normal (25°C)	Normal	777.4363	786.5756	8.15	0.00974
Extreme (85°C)		777.4364	786.5755	6.27	0.00750
Extreme (80°C)		777.4360	786.5759	-7.65	-0.00915
Extreme (70°C)		777.4375	786.5744	2.53	0.00302
Extreme (60°C)		777.4356	786.5763	7.23	0.00864
Extreme (50°C)		777.4353	786.5766	0.47	0.00056
Extreme (40°C)		777.4368	786.5751	2.56	0.00306



Extreme (30°C)		777.4357	786.5762	-2.36	-0.00282
Extreme (20°C)		777.4354	786.5765	-4.40	-0.00526
Extreme (10°C)		777.4370	786.5749	1.88	0.00225
Extreme (0°C)		777.4361	786.5758	8.14	0.00973
Extreme (-10°C)		777.4356	786.5751	-2.53	-0.00302
Extreme (-20°C)		777.4362	786.5765	-0.76	-0.00091
Extreme (-30°C)		777.4356	786.5763	-0.95	-0.00114
Extreme (-40°C)		777.4362	786.5757	1.09	0.00130
25°C	LV	777.4356	786.5755	1.22	0.00146
	HV	777.4362	786.5744	-5.71	-0.00683
(16QAM,20MHz BANDWIDTH)					
Condition		777	787	Delta (Hz)	Frequency Stability(ppm)
Temperature	Voltage	F low@-13dBm(MHz)	F high@-13dBm(MHz)		
Normal (25°C)	Normal	777.5179	786.5012	2.67	0.00319
Extreme (85°C)		777.5180	786.5011	-1.37	-0.00164
Extreme (80°C)		777.5176	786.5015	-0.11	-0.00013
Extreme (70°C)		777.5191	786.5131	-0.74	-0.00088
Extreme (60°C)		777.5172	786.5019	-4.77	-0.00570
Extreme (50°C)		777.5169	786.5022	1.50	0.00179
Extreme (40°C)		777.5184	786.5007	4.39	0.00525
Extreme (30°C)		777.5173	786.5018	-6.29	-0.00752
Extreme (20°C)		777.5170	786.5021	7.78	0.00930
Extreme (10°C)		777.5186	786.5005	8.80	0.01052
Extreme (0°C)		777.5177	786.5014	-7.79	-0.00931
Extreme (-10°C)		777.5176	786.5011	2.41	0.00288
Extreme (-20°C)		777.5169	786.5131	-3.46	-0.00414
Extreme (-30°C)		777.5173	786.5018	-2.86	-0.00342
Extreme (-40°C)		777.5186	786.5005	1.41	0.00169
25°C	LV	777.5172	786.5019	-10.13	-0.01211
	HV	777.5178	786.5013	-3.01	-0.00360

5.7 Spurious Emissions at Antenna Terminals

Ambient condition

Temperature	Relative humidity	Pressure
23°C ~25°C	45%~50%	101.5kPa

Method of Measurement

The EUT was connected to Spectrum Analyzer and Base Station Simulator via power Splitter. The measurement is carried out using a spectrum analyzer. The spectrum analyzer scans from 9kHz to the 10th harmonic of the carrier. The peak detector is used.

RBW is set to 100kHz, VBW is set to 300kHz for 30MHz~1GHz

RBW is set to 1MHz, VBW is set to 3MHz for above 1GHz, Sweep is set to ATUO.

Of those disturbances below (limit – 20 dB), the mark is not required for the EUT.

The modulation mode and RB allocation refer to section 5.1, using the maximum output power configuration.

Test setup

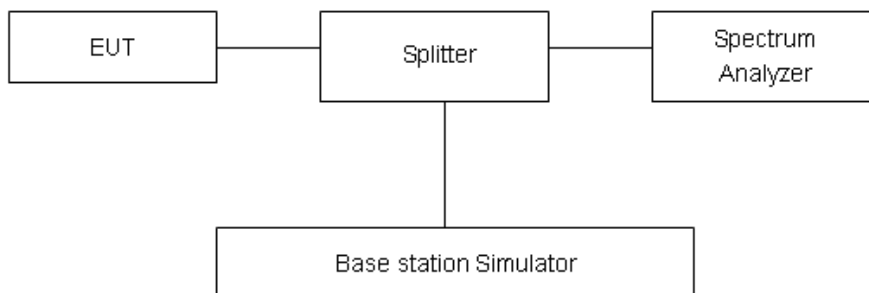

Limits

Rule Part 27.53(h) specifies that “for operations in the 1695-1710 MHz, 1710-1755 MHz, 1755-1780 MHz, 1915-1920 MHz, 1995-2000 MHz, 2000-2020 MHz, 2110-2155 MHz, 2155-2180 MHz, and 2180-2200 bands, the power of any emission outside a licensee's frequency block shall be attenuated below the transmitter power (P) in watts by at least $43 + 10 \log_{10}(P)$ dB..”

Rule Part 27.53 (g) For operations in the 600 MHz band and the 698-746 MHz band, the power of any emission outside a licensee's frequency band(s) of operation shall be attenuated below the transmitter power (P) within the licensed band(s) of operation, measured in watts, by at least $43 + 10 \log(P)$ dB. Compliance with this provision is based on the use of measurement instrumentation employing a resolution bandwidth of 100 kilohertz or greater. However, in the 100 kilohertz bands immediately outside and adjacent to a licensee's frequency block, a resolution bandwidth of at least 30 kHz may be employed.

Rule Part 27.53(f) For operations in the 746-758 MHz, 775-788 MHz, and 805-806 MHz bands, emissions in the band 1559-1610 MHz shall be limited to -70 dBW/MHz equivalent isotropically



radiated power (EIRP) for wideband signals, and -80 dBW EIRP for discrete emissions of less than 700 Hz bandwidth. For the purpose of equipment authorization, a transmitter shall be tested with an antenna that is representative of the type that will be used with the equipment in normal operation.

Part 27.53(h)/(g) Limit		-13 dBm
Part 27.53(f) Limit	Limit out of the band 1559-1610 MHz	-13 dBm
	Limit in the band 1559-1610 MHz	-40 dBm

Measurement Uncertainty

The assessed measurement uncertainty to ensure 99.75% confidence level for the normal distribution is with the coverage factor $k = 1.96$.

Frequency	Uncertainty
9kHz-1GHz	0.684 dB
1GHz-18GHz	1.407 dB

Test Result

Sweep the whole frequency band through the range from 9kHz to the 10th harmonic of the carrier, the emissions more than 20 dB below the limit are not reported.

The signal beyond the limit is carrier.

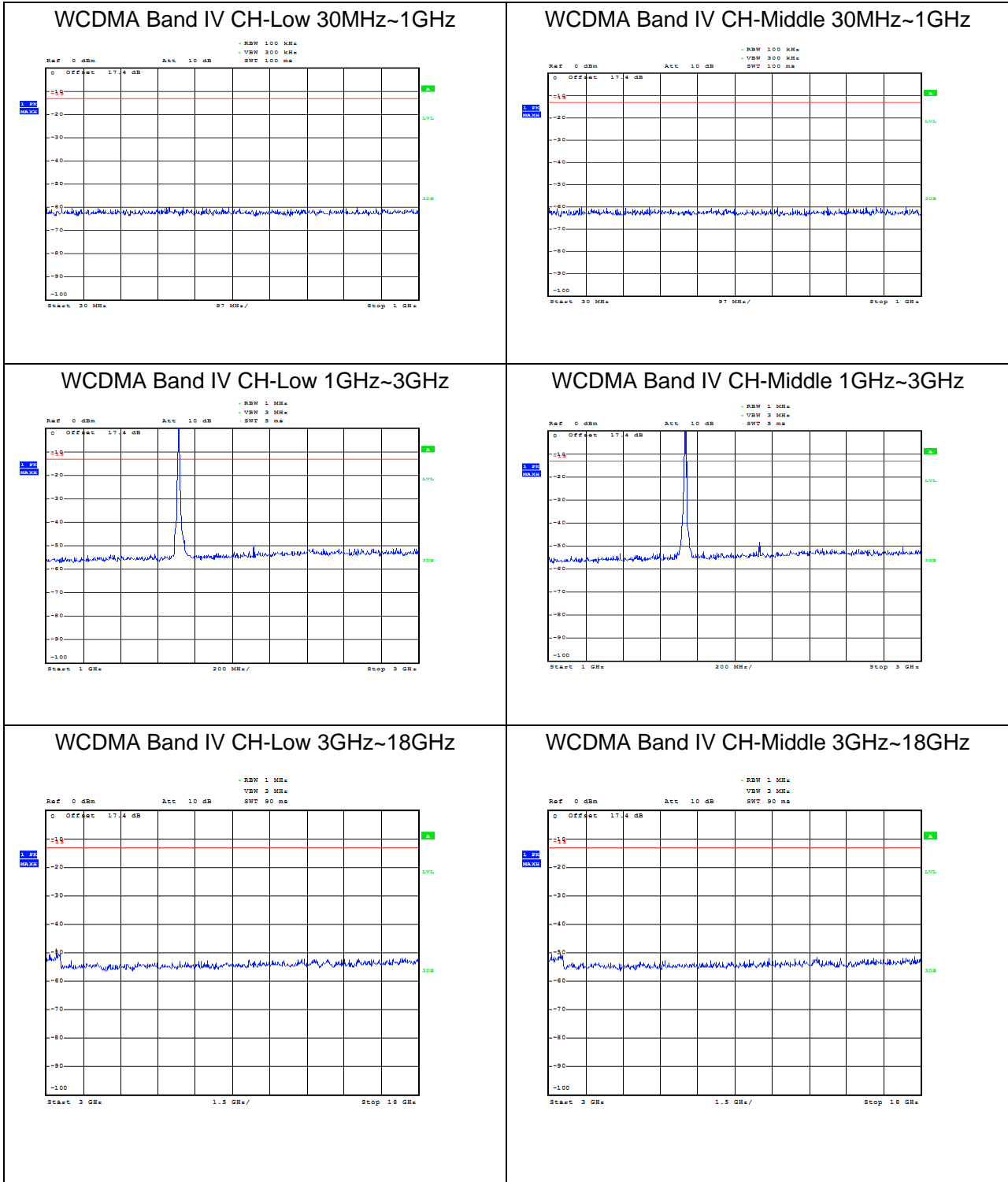



WCDMA Band IV CH-High 30MHz~1GHz

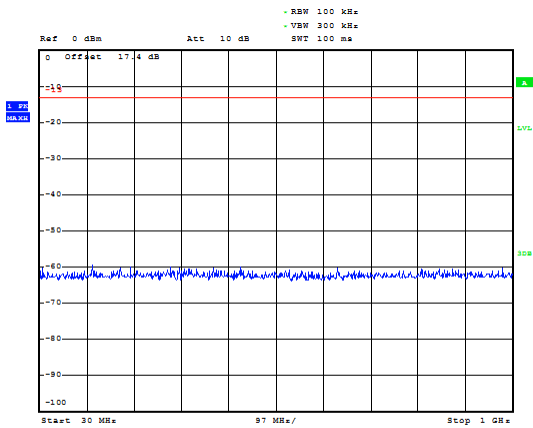

WCDMA Band IV CH-High 1GHz~3GHz

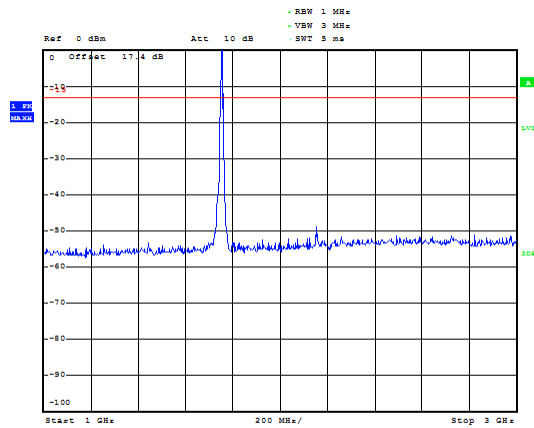

WCDMA Band IV CH-High 3GHz~18GHz

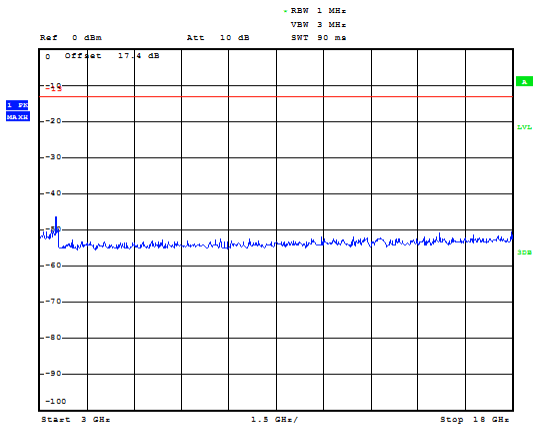



LTE Band 4 1.4MHz CH-Low 30MHz~1GHz

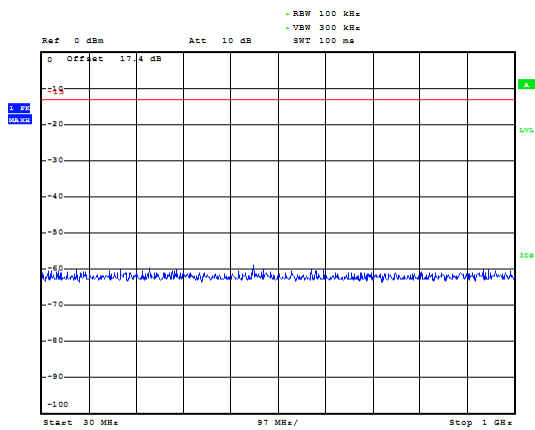

LTE Band 4 1.4MHz CH-Middle 30MHz~1GHz

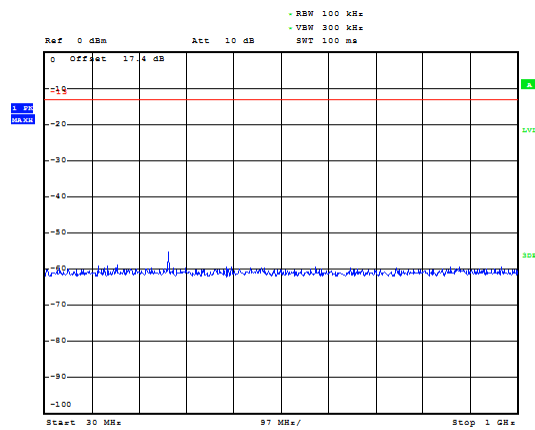

LTE Band 4 1.4MHz CH-Low 1GHz~3GHz

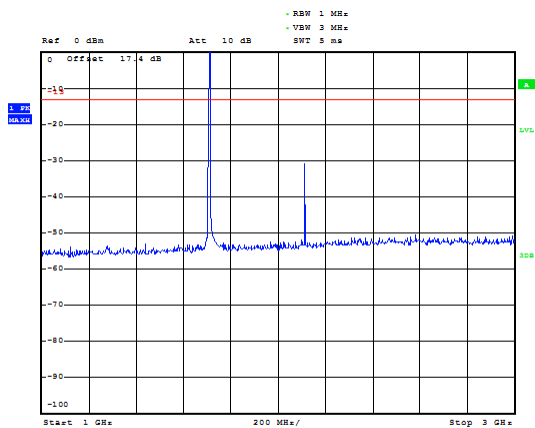

LTE Band 4 1.4MHz CH-Middle 1GHz~3GHz

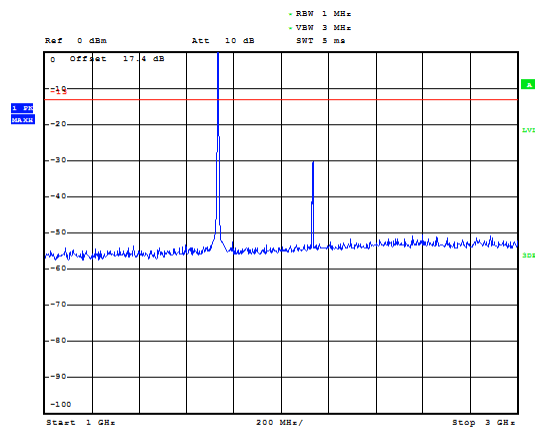

LTE Band 4 1.4MHz CH-Low 3GHz~18GHz

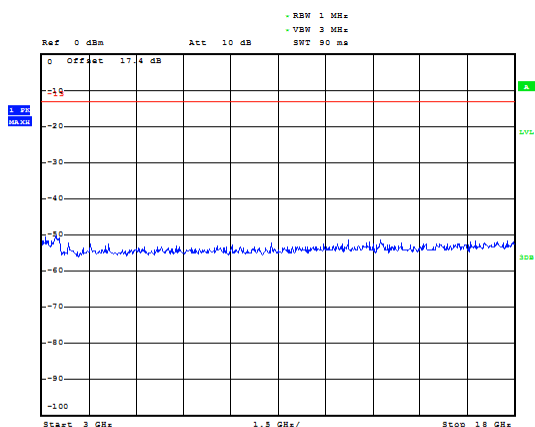

LTE Band 4 1.4MHz CH-Middle 3GHz~18GHz

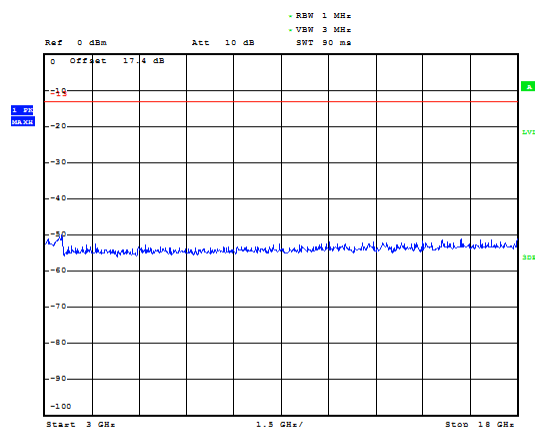



LTE Band 4 1.4MHz CH-High 30MHz~1GHz

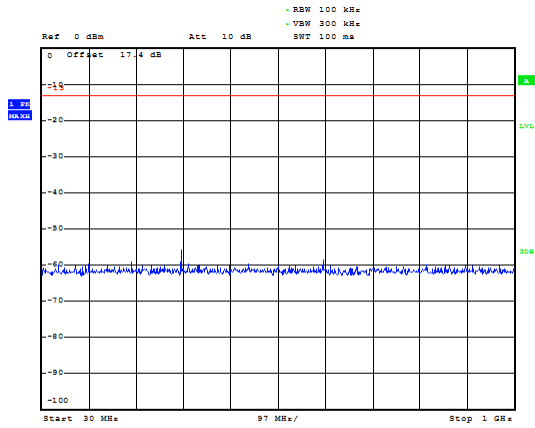

LTE Band 4 3MHz CH-Low 30MHz~1GHz

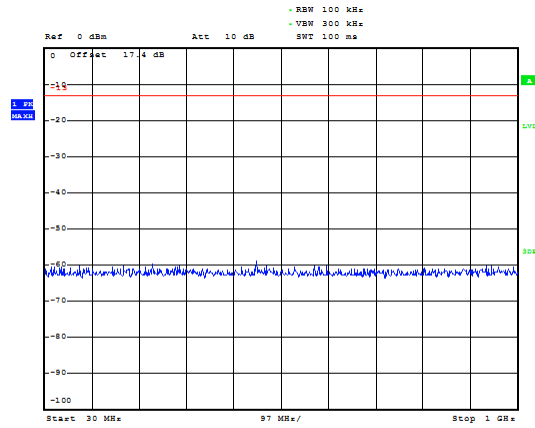

LTE Band 4 1.4MHz CH-High 1GHz~3GHz

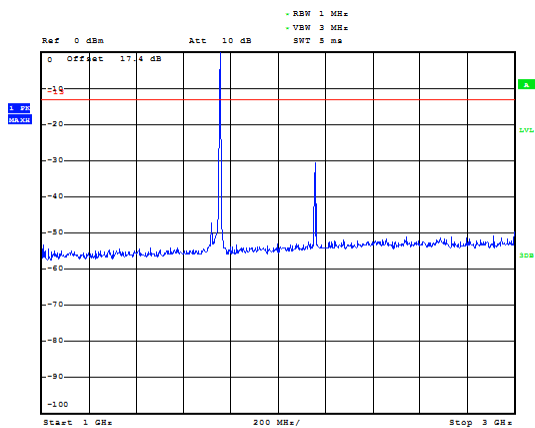

LTE Band 4 3MHz CH-Low 1GHz~3GHz

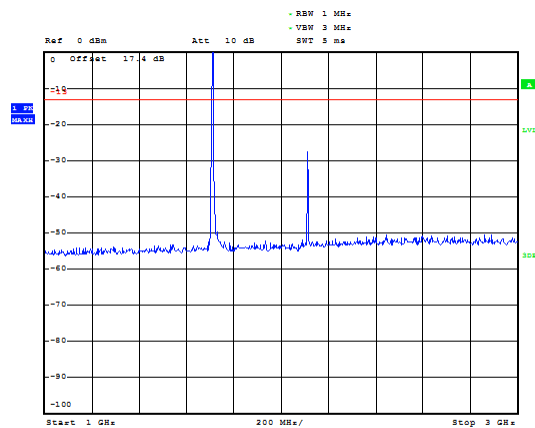

LTE Band 4 1.4MHz CH-High 3GHz~18GHz

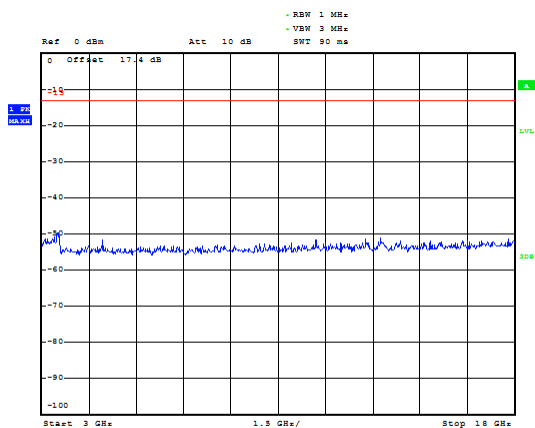

LTE Band 4 3MHz CH-Low 3GHz~18GHz

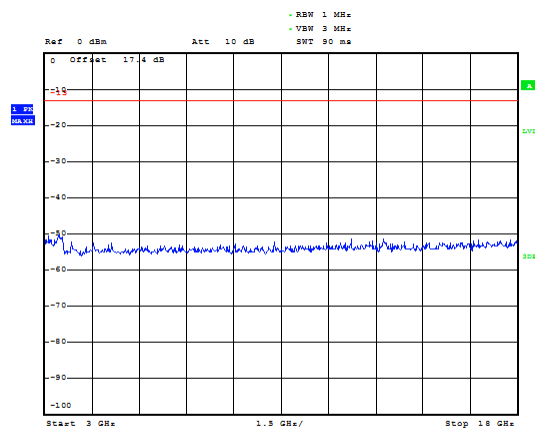



LTE Band 4 3MHz CH-Middle 30MHz~1GHz

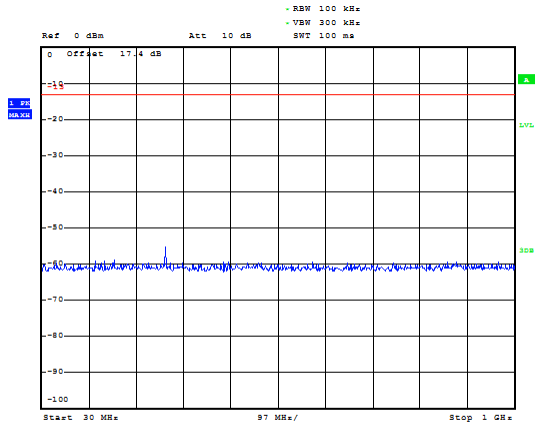

LTE Band 4 3MHz CH-High 30MHz~1GHz

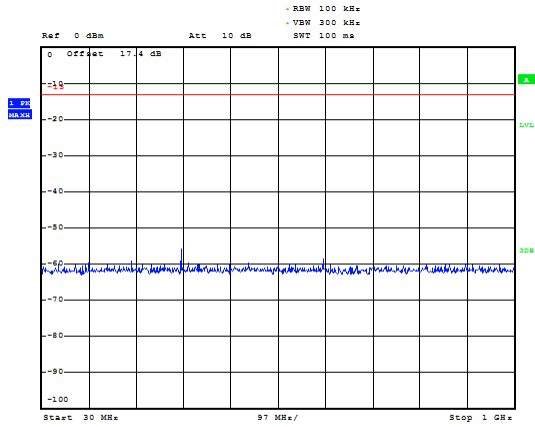

LTE Band 4 3MHz CH-Middle 1GHz~3GHz

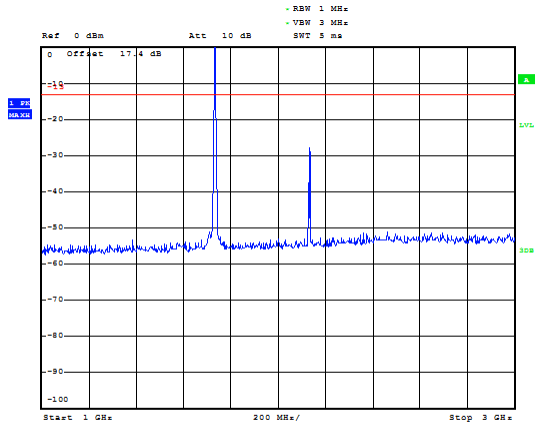

LTE Band 4 3MHz CH-High 1GHz~3GHz

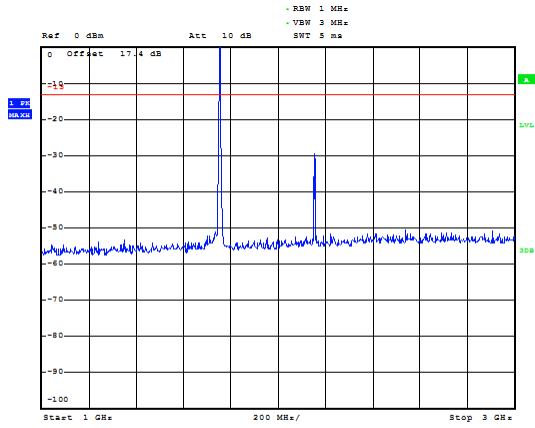

LTE Band 4 3MHz CH-Middle 3GHz~18GHz

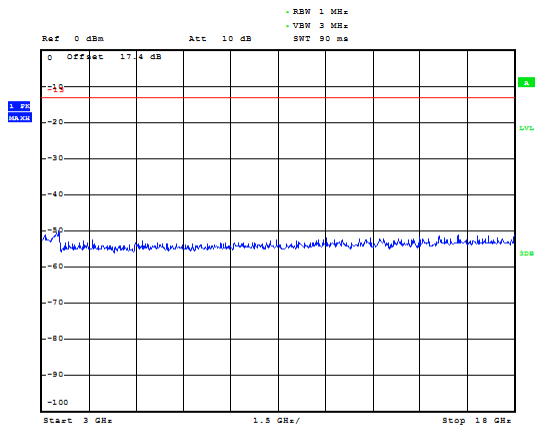

LTE Band 4 3MHz CH-High 3GHz~18GHz

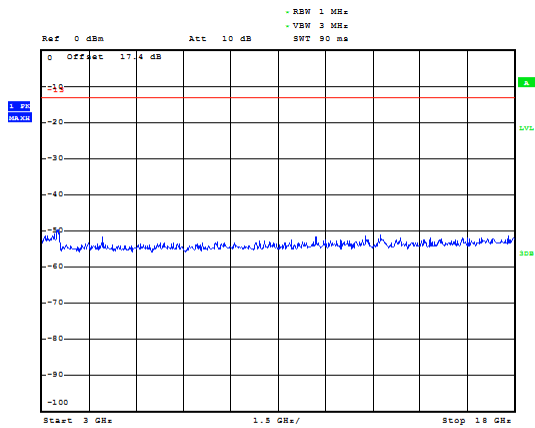



LTE Band 4 5MHz CH-Low 30MHz~1GHz

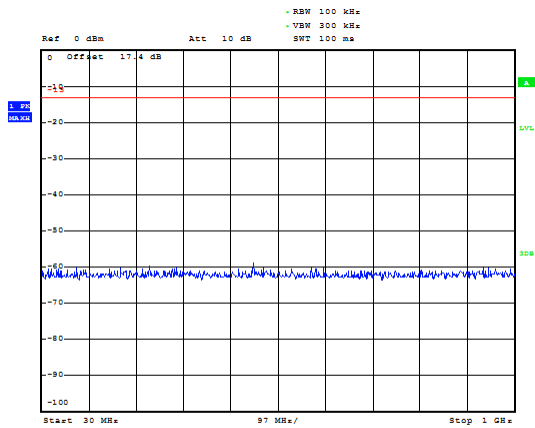

LTE Band 4 5MHz CH-Middle 30MHz~1GHz

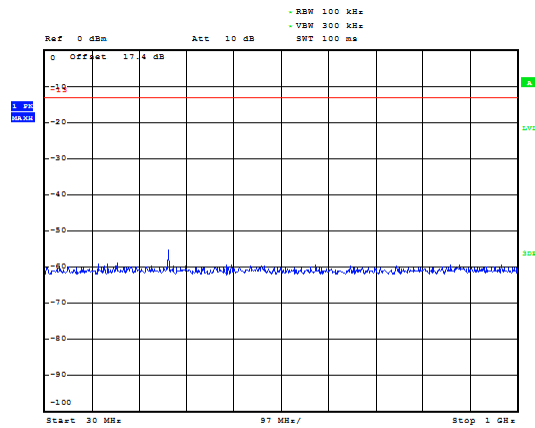

LTE Band 4 5MHz CH-Low 1GHz~3GHz

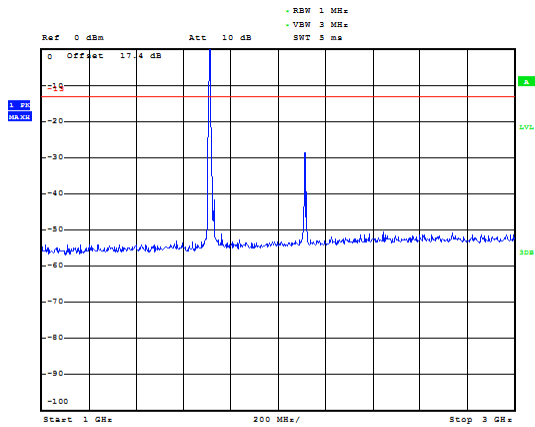

LTE Band 4 5MHz CH-Middle 1GHz~3GHz

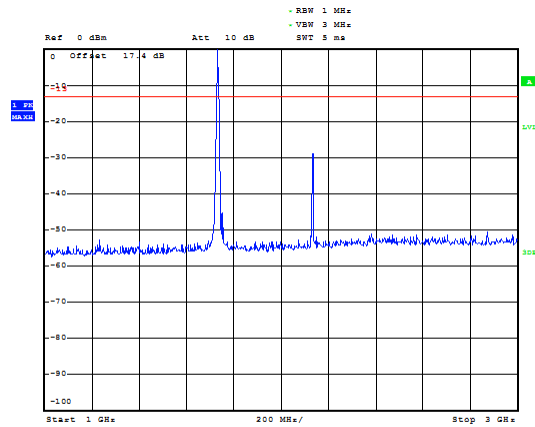

LTE Band 4 5MHz CH-Low 3GHz~18GHz

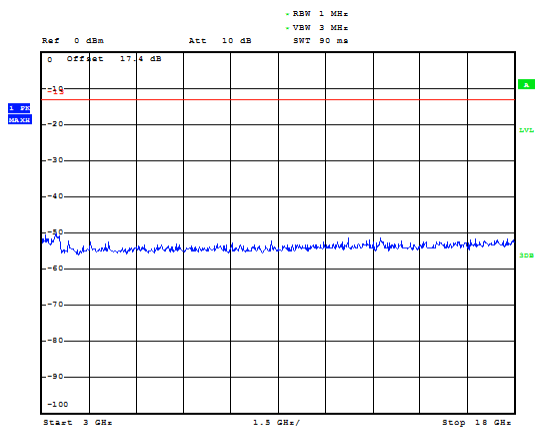

LTE Band 4 5MHz CH-Middle 3GHz~18GHz

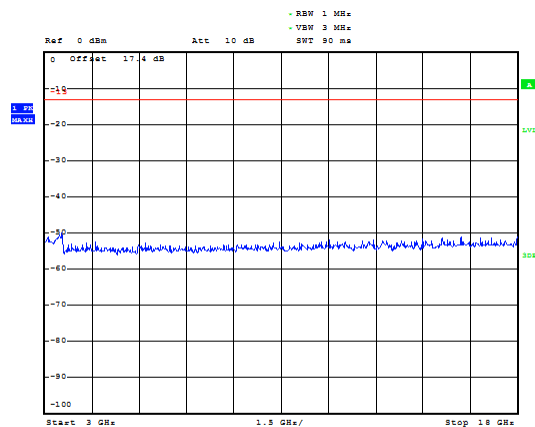



LTE Band 4 5MHz CH-High 30MHz~1GHz

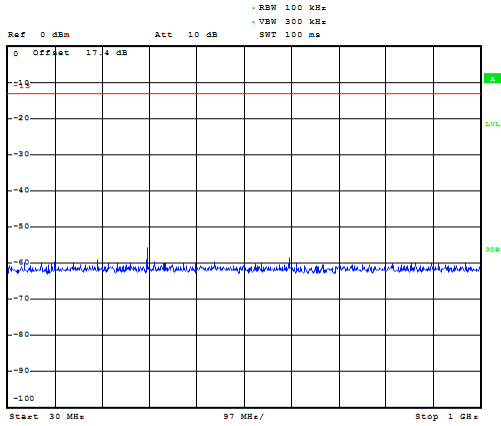

LTE Band 4 10MHz CH-Low 30MHz~1GHz

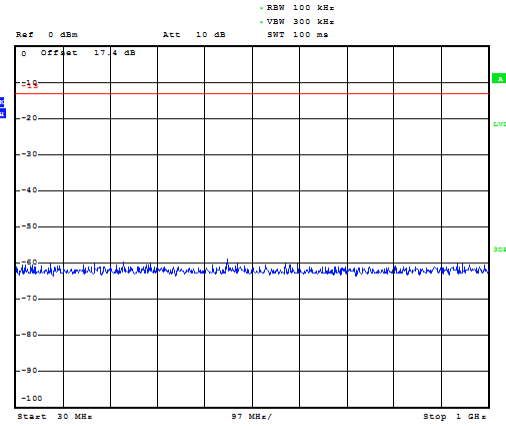

LTE Band 4 5MHz CH-High 1GHz~3GHz

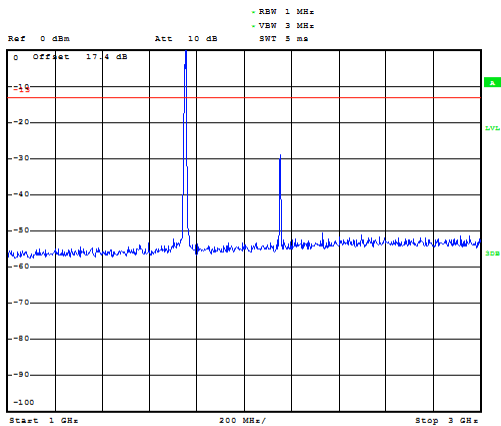

LTE Band 4 10MHz CH-Low 1GHz~3GHz

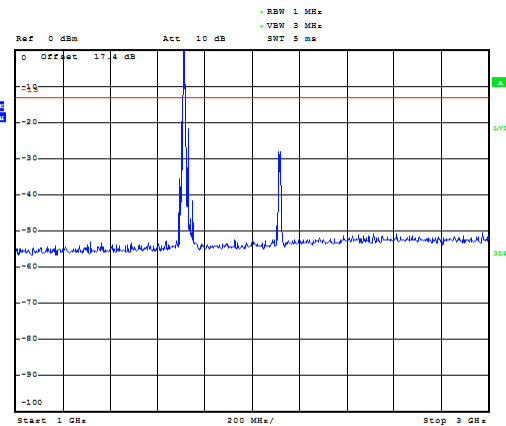

LTE Band 4 5MHz CH-High 3GHz~18GHz

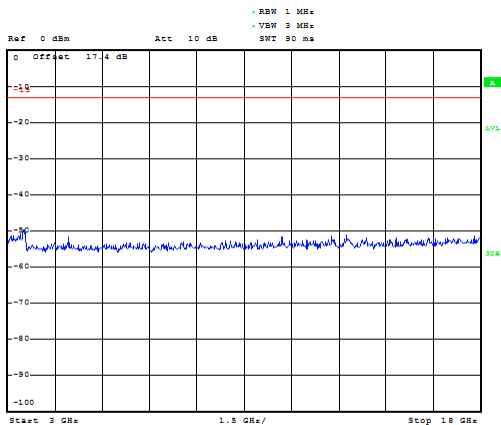

LTE Band 4 10MHz CH-Low 3GHz~18GHz

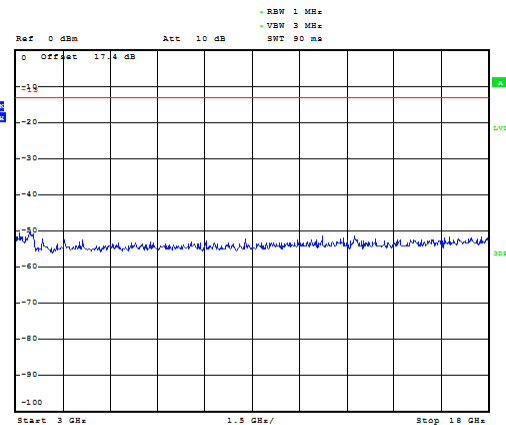



LTE Band 4 10MHz CH-Middle 30MHz~1GHz

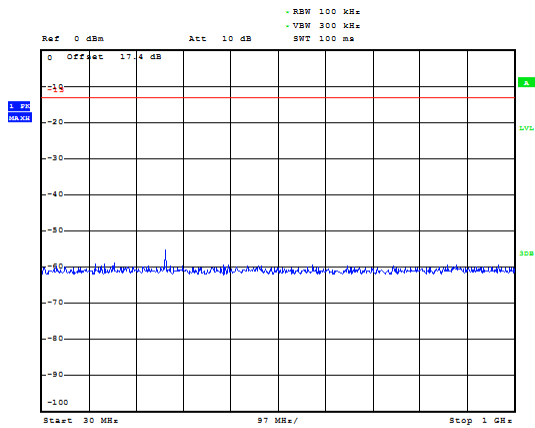

LTE Band 4 10MHz CH-High 30MHz~1GHz

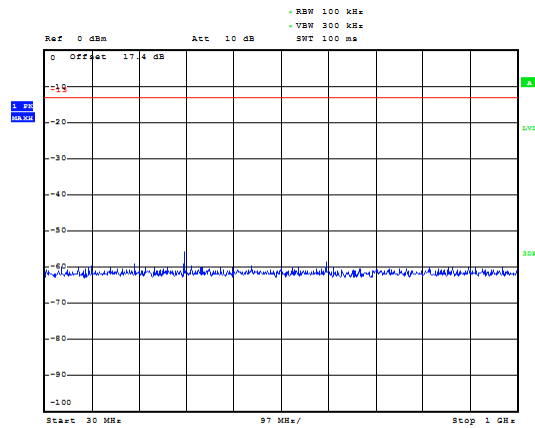

LTE Band 4 10MHz CH-Middle 1GHz~3GHz

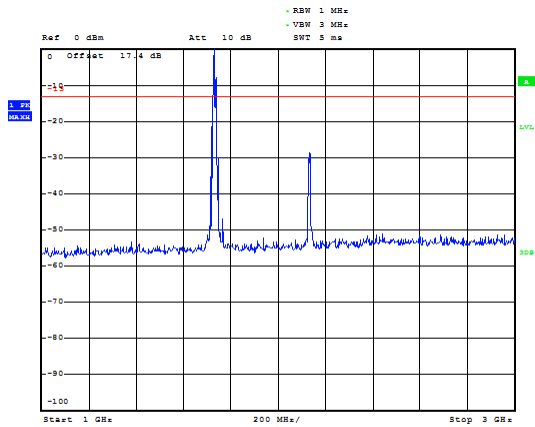

LTE Band 4 10MHz CH-High 1GHz~3GHz

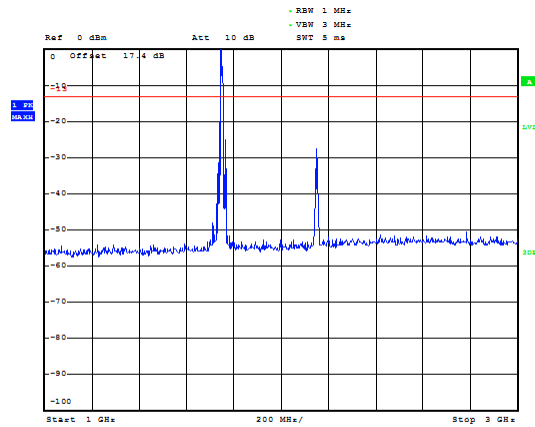

LTE Band 4 10MHz CH-Middle 3GHz~18GHz

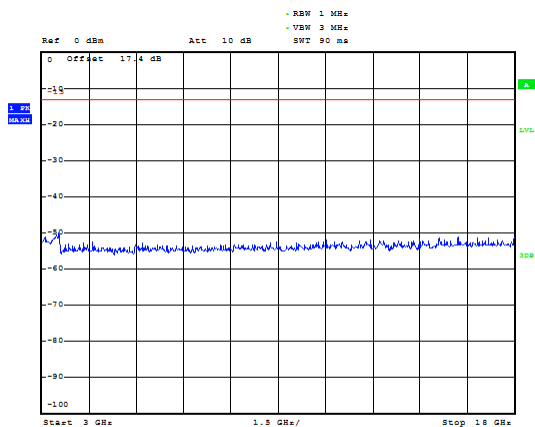

LTE Band 4 10MHz CH-High 3GHz~18GHz

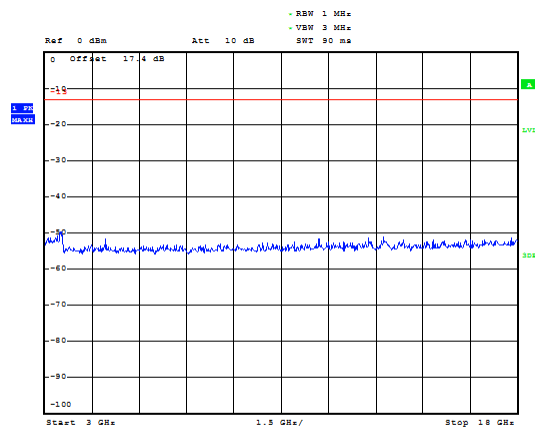



LTE Band 4 15MHz CH-Low 30MHz~1GHz

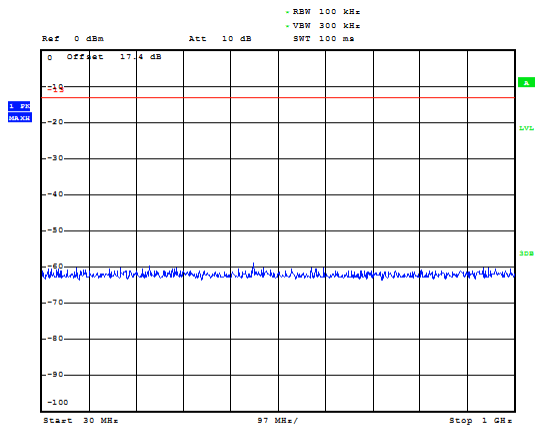

LTE Band 4 15MHz CH-Middle 30MHz~1GHz

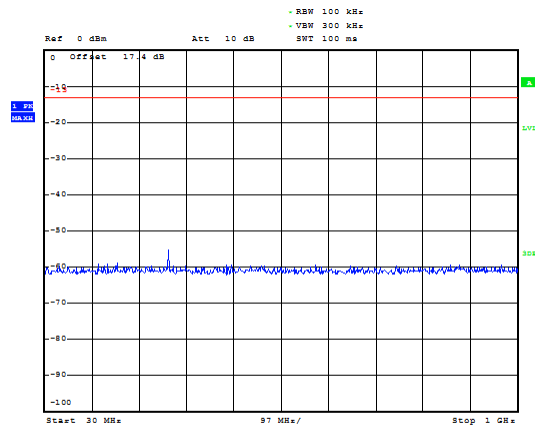

LTE Band 4 15MHz CH-Low 1GHz~3GHz

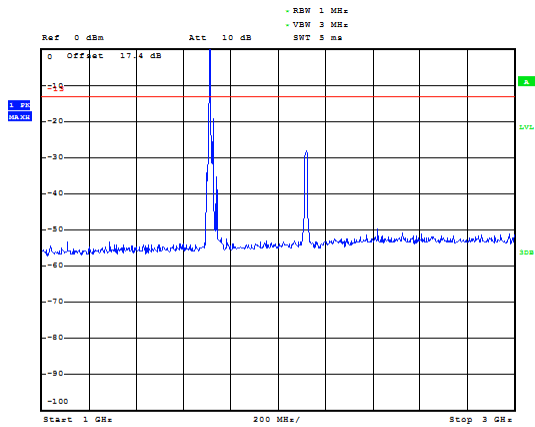

LTE Band 4 15MHz CH-Middle 1GHz~3GHz

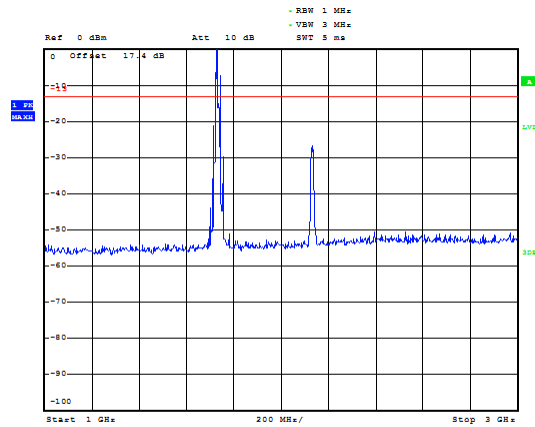

LTE Band 4 15MHz CH-Low 3GHz~18GHz

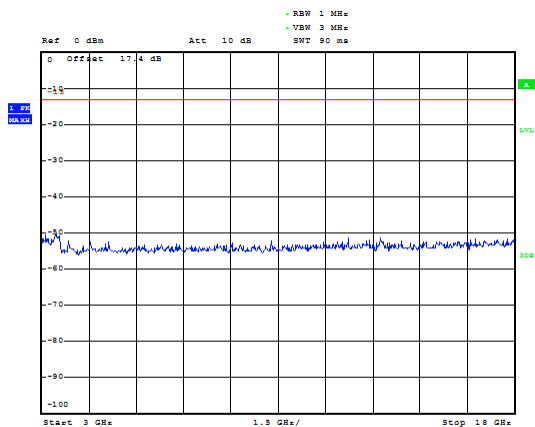

LTE Band 4 15MHz CH-Middle 3GHz~18GHz

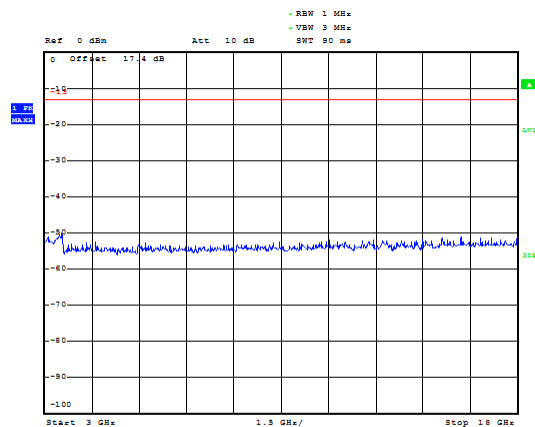



LTE Band 4 15MHz CH-High 30MHz~1GHz

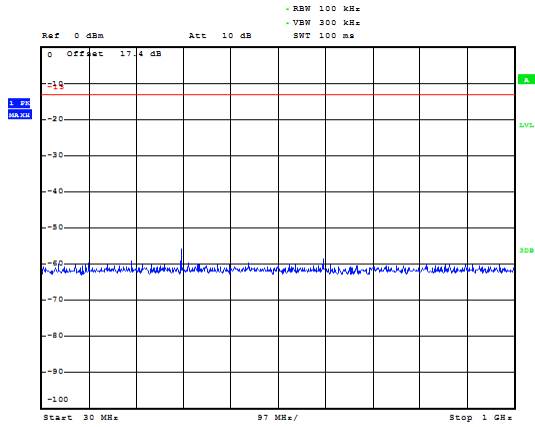

LTE Band 4 20MHz CH-Low 30MHz~1GHz

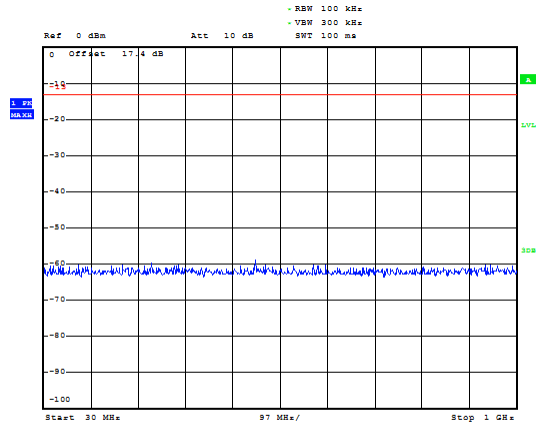

LTE Band 4 15MHz CH-High 1GHz~3GHz

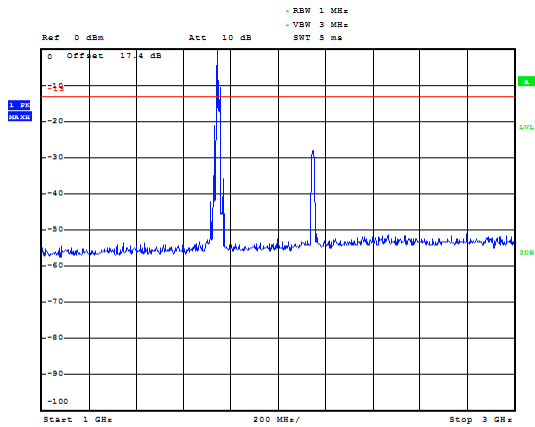

LTE Band 4 20MHz CH-Low 1GHz~3GHz

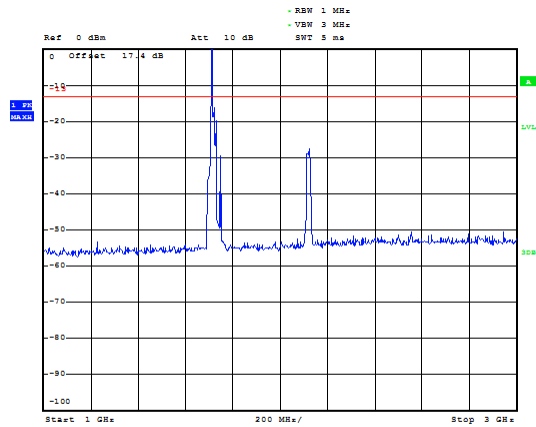

LTE Band 4 15MHz CH-High 3GHz~18GHz

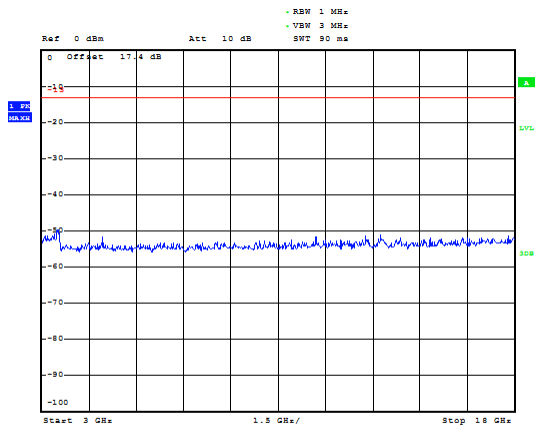

LTE Band 4 20MHz CH-Low 3GHz~18GHz

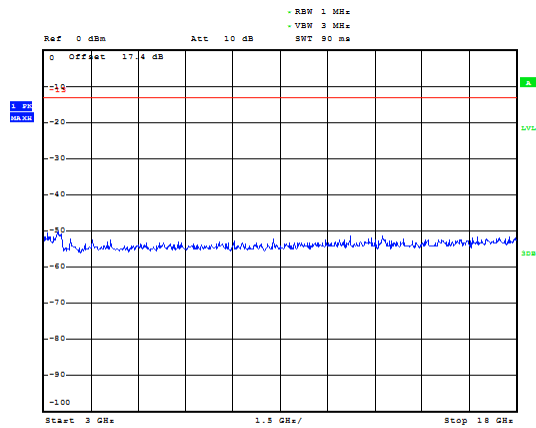



LTE Band 4 20MHz CH-Middle 30MHz~1GHz

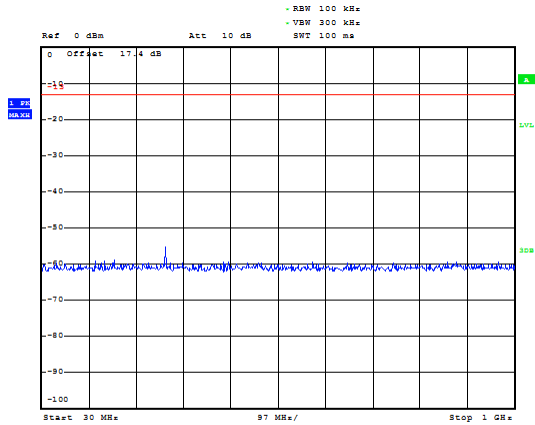

LTE Band 4 20MHz CH-High 30MHz~1GHz

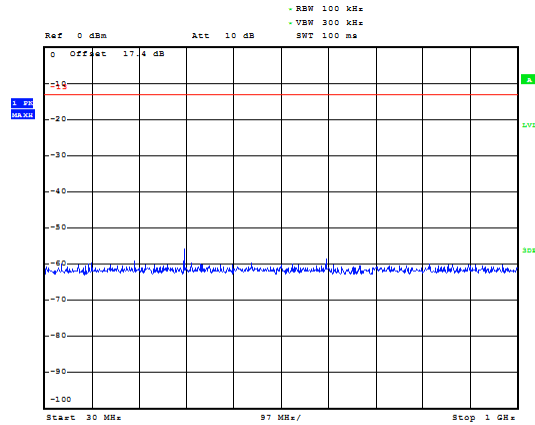

LTE Band 4 20MHz CH-Middle 1GHz~3GHz

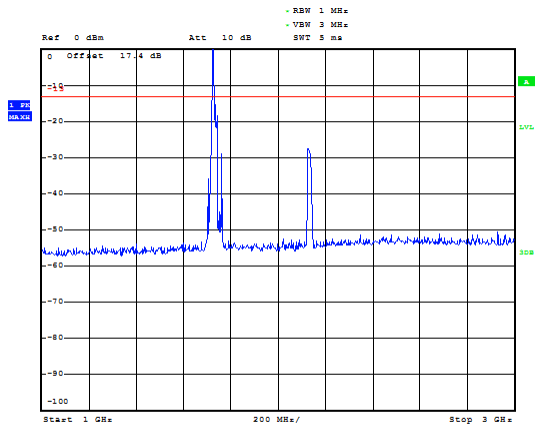

LTE Band 4 20MHz CH-High 1GHz~3GHz

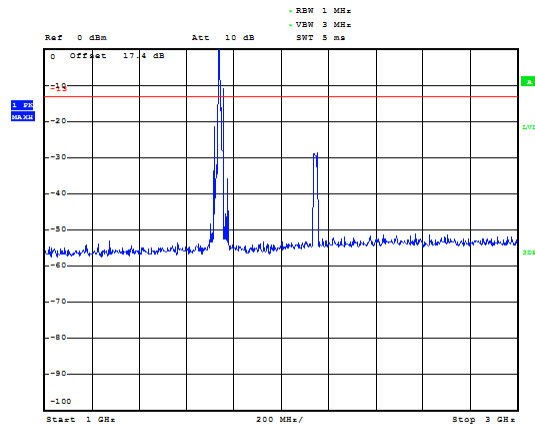

LTE Band 4 20MHz CH-Middle 3GHz~18GHz

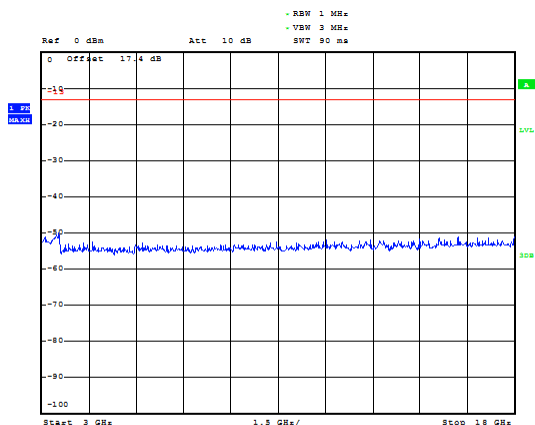

LTE Band 4 20MHz CH-High 3GHz~18GHz

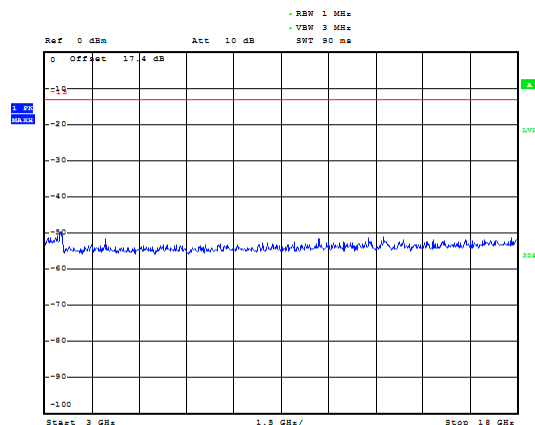



LTE Band 12 1.4MHz CH-Low 30MHz~1GHz

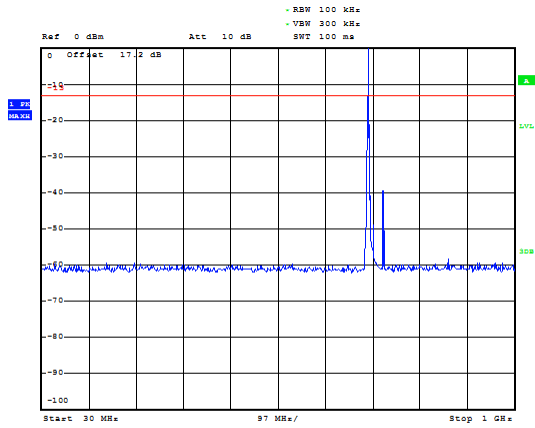

LTE Band 12 1.4MHz CH-Low 1GHz~9GHz

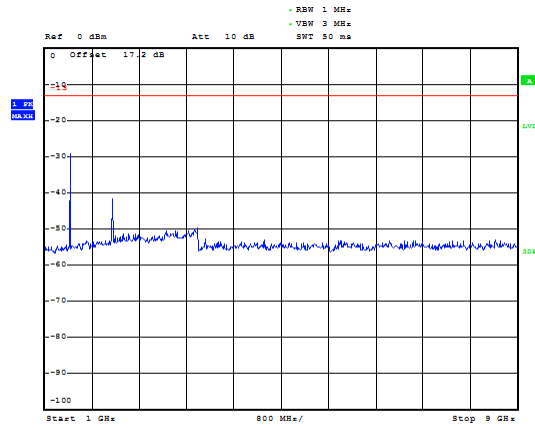

LTE Band 12 1.4MHz CH- Middle 30MHz~1GHz

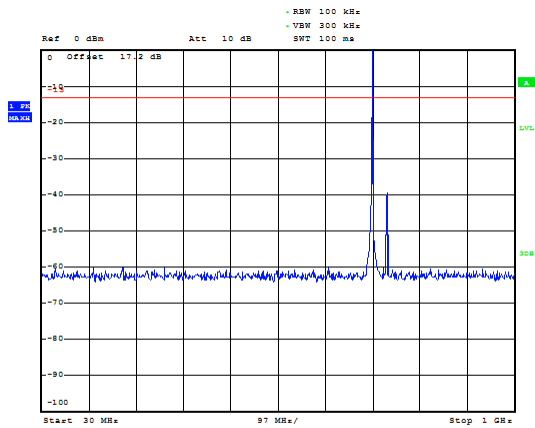

LTE Band 12 1.4MHz CH- Middle 1GHz~9GHz

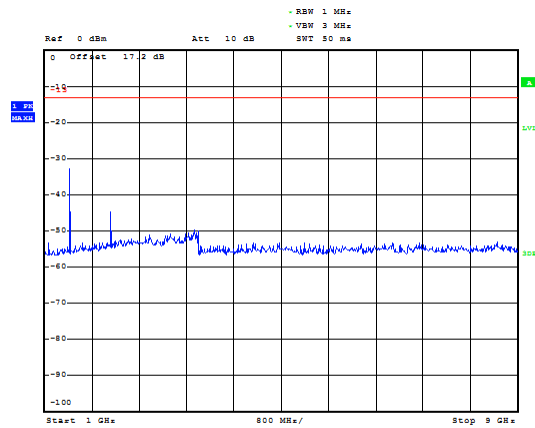

LTE Band 12 1.4MHz CH-High 30MHz~1GHz

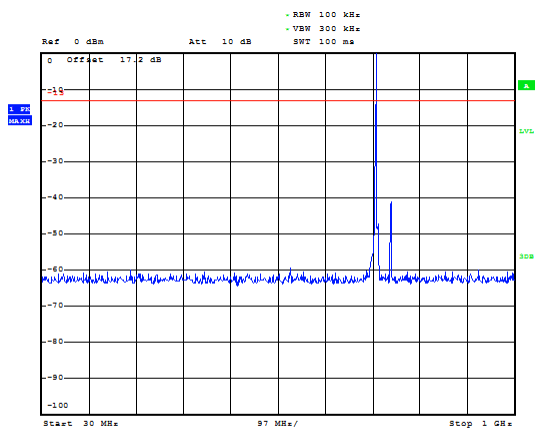

LTE Band 12 1.4MHz CH-High 1GHz~9GHz

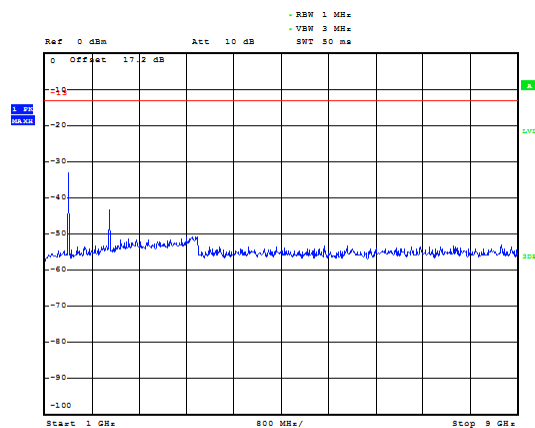



LTE Band 12 3MHz CH-Low 30MHz~1GHz

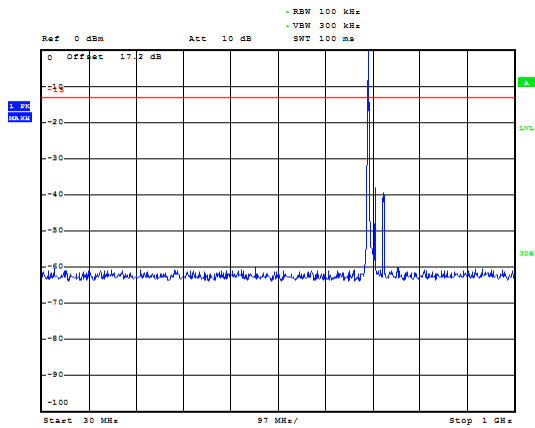

LTE Band 12 3MHz CH-Low 1GHz~9GHz

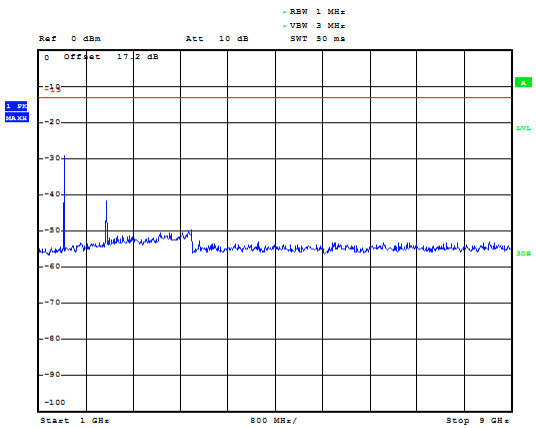

LTE Band 12 3MHz CH- Middle 30MHz~1GHz

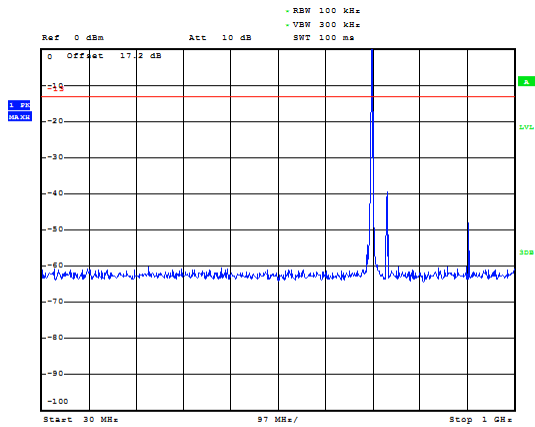

LTE Band 12 3MHz CH- Middle 1GHz~9GHz

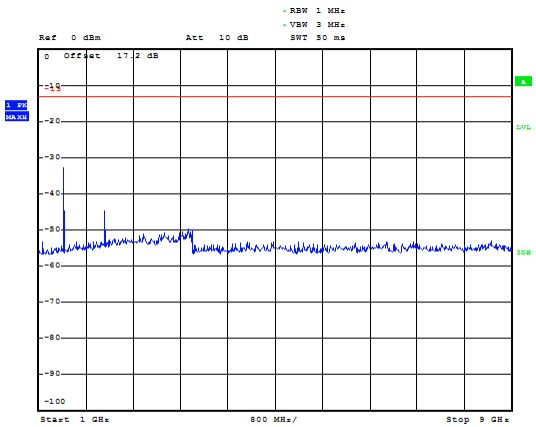

LTE Band 12 3MHz CH-High 30MHz~1GHz

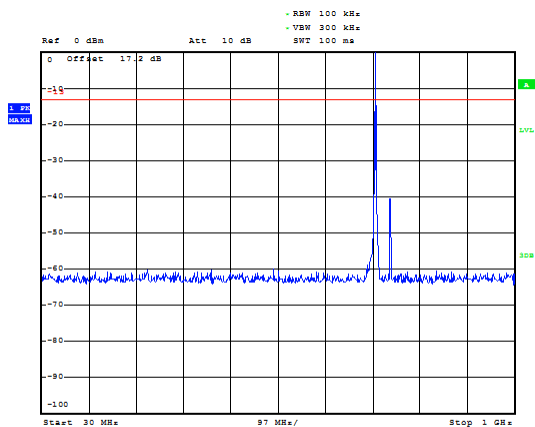

LTE Band 12 3MHz CH-High 1GHz~9GHz

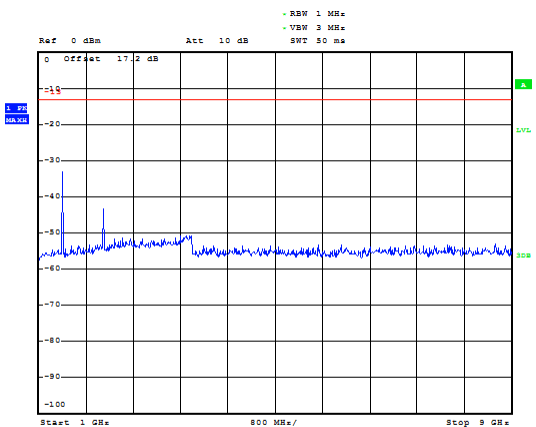



LTE Band 12 5MHz CH-Low 30MHz~1GHz

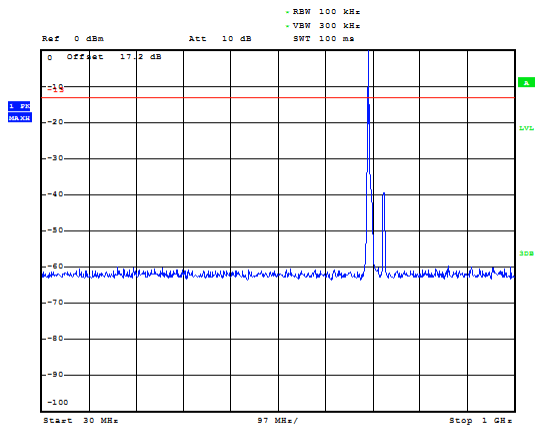

LTE Band 12 5MHz CH-Low 1GHz~9GHz

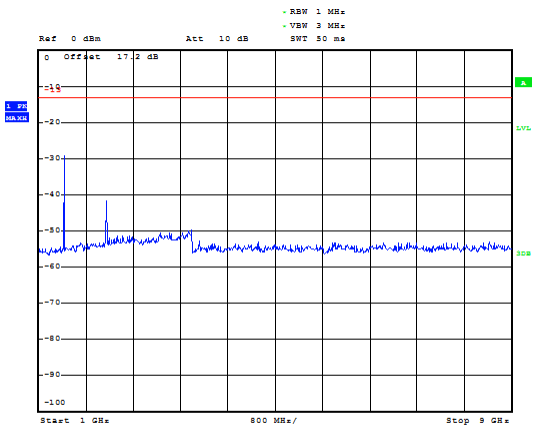

LTE Band 12 5MHz CH- Middle 30MHz~1GHz

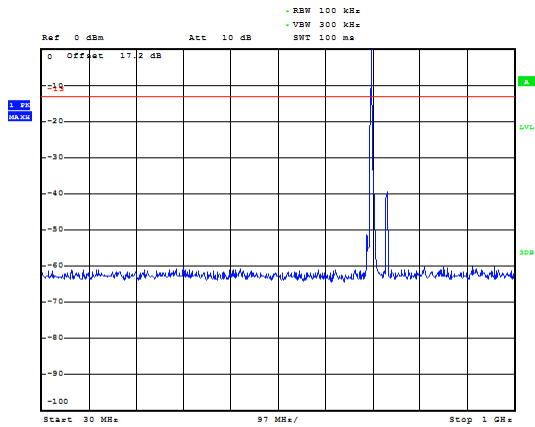

LTE Band 12 5MHz CH- Middle 1GHz~9GHz

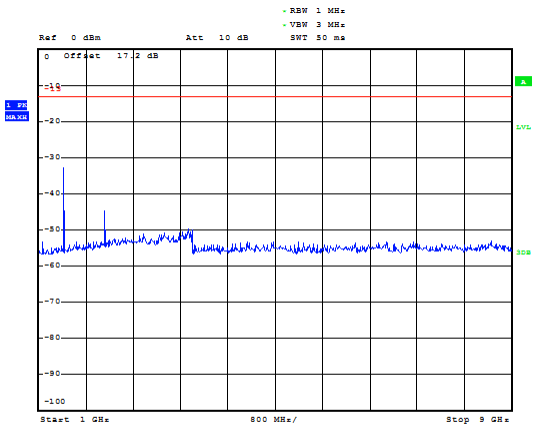

LTE Band 12 5MHz CH-High 30MHz~1GHz

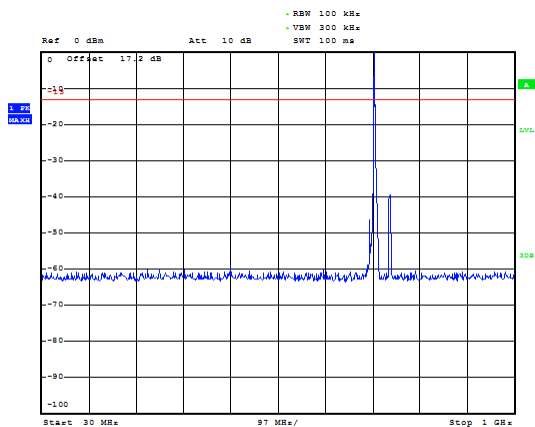

LTE Band 12 5MHz CH-High 1GHz~9GHz

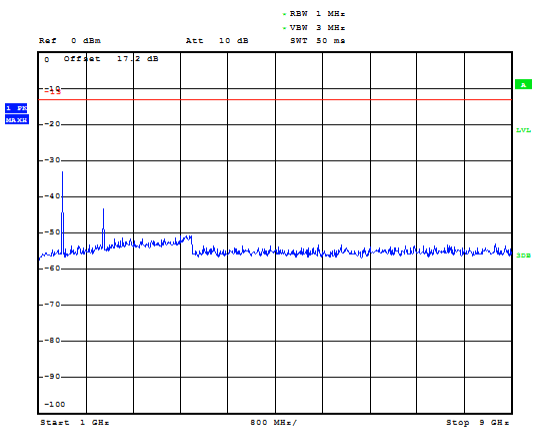



LTE Band 12 10MHz CH-Low 30MHz~1GHz

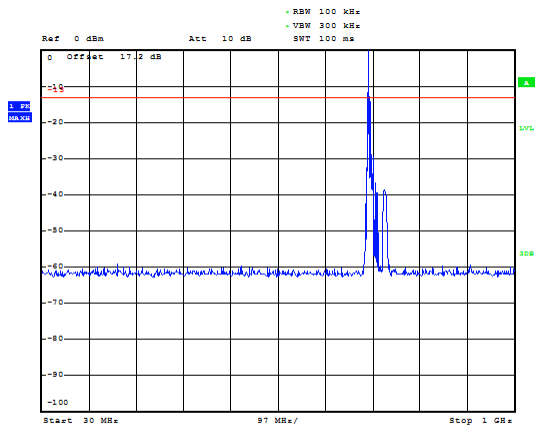

LTE Band 12 10MHz CH-Low 1GHz~9GHz

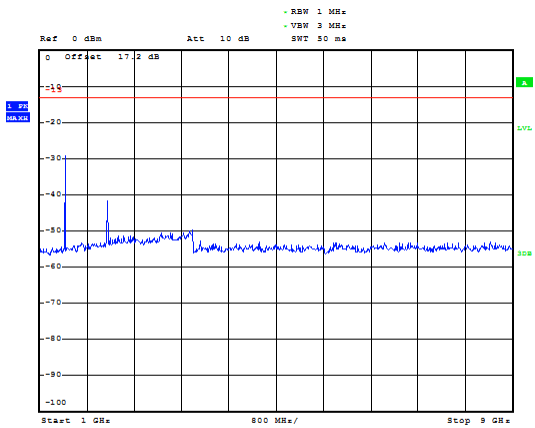

LTE Band 12 10MHz CH- Middle 30MHz~1GHz

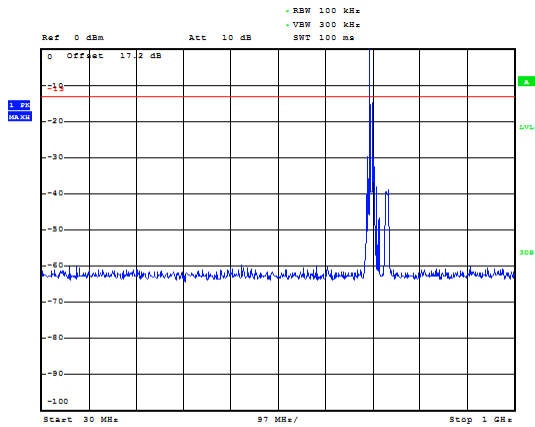

LTE Band 12 10MHz CH- Middle 1GHz~9GHz

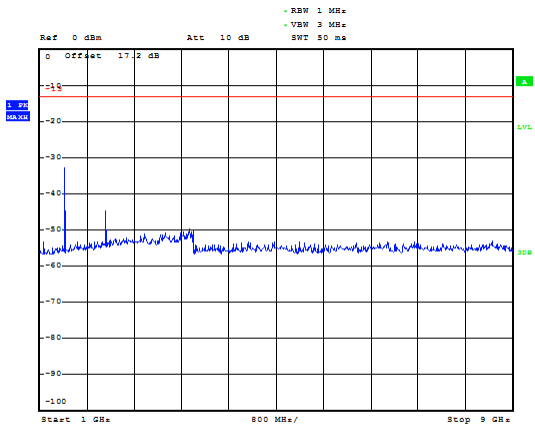

LTE Band 12 10MHz CH-High 30MHz~1GHz

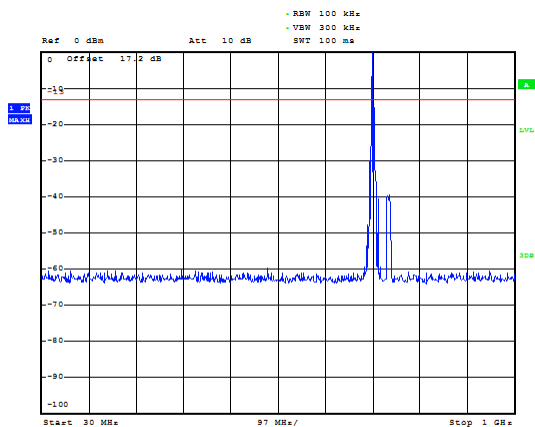

LTE Band 12 10MHz CH-High 1GHz~9GHz

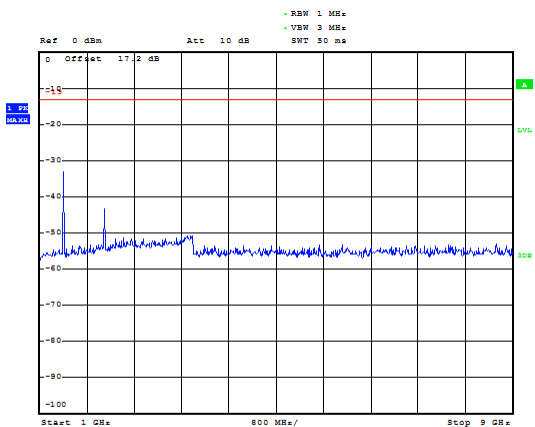



LTE Band 13 5MHz CH-Low 30MHz~1GHz

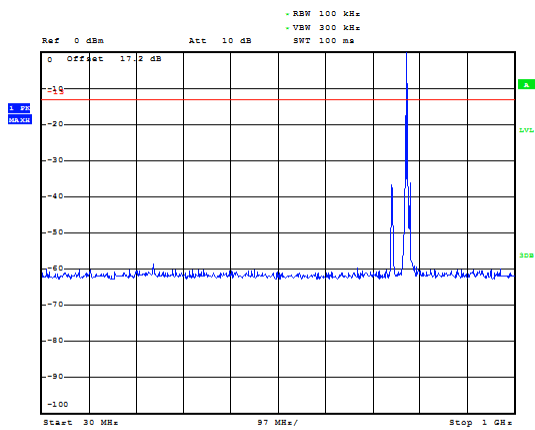

LTE Band 13 5MHz CH-Low 1GHz~9GHz

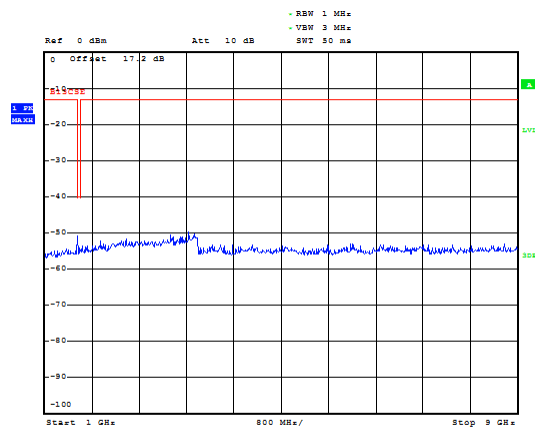

LTE Band 13 5MHz CH-Middle 30MHz~1GHz

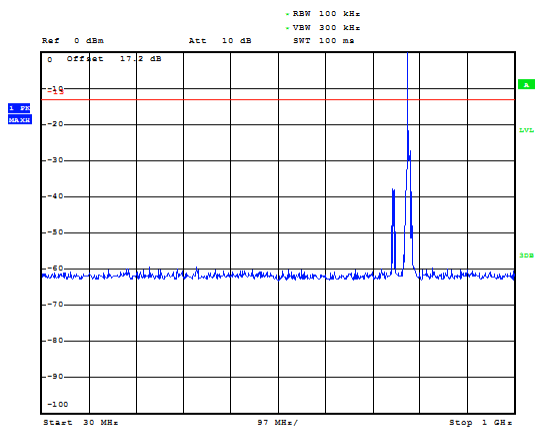

LTE Band 13 5MHz CH-Middle 1GHz~9GHz

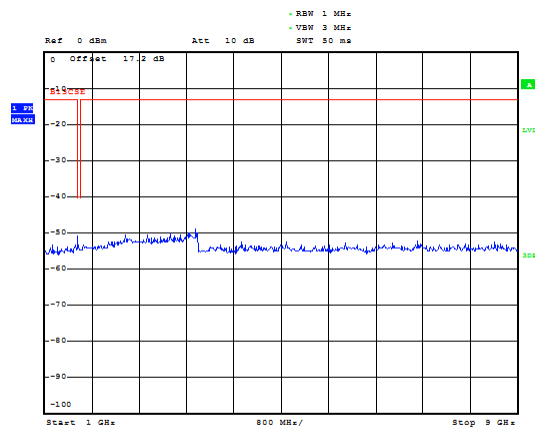

LTE Band 13 5MHz CH-High 30MHz~1GHz

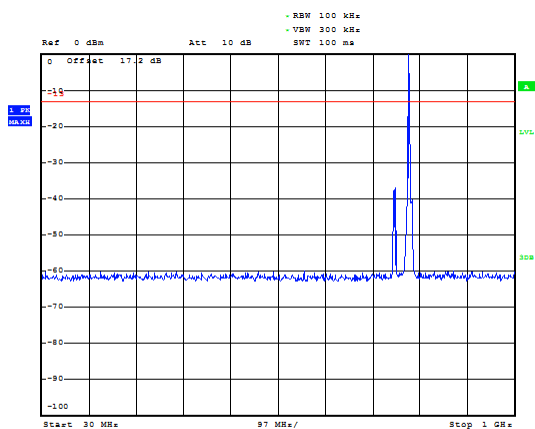

LTE Band 13 5MHz CH-High 1GHz~9GHz

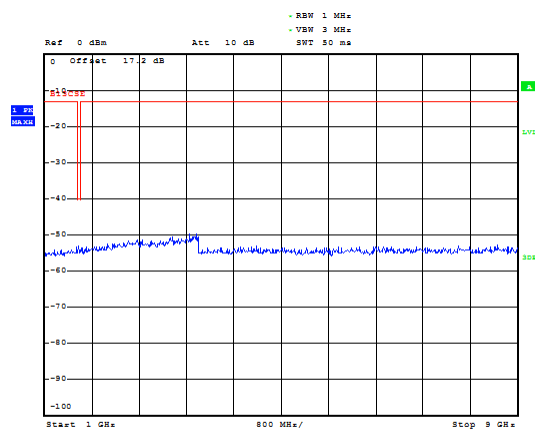

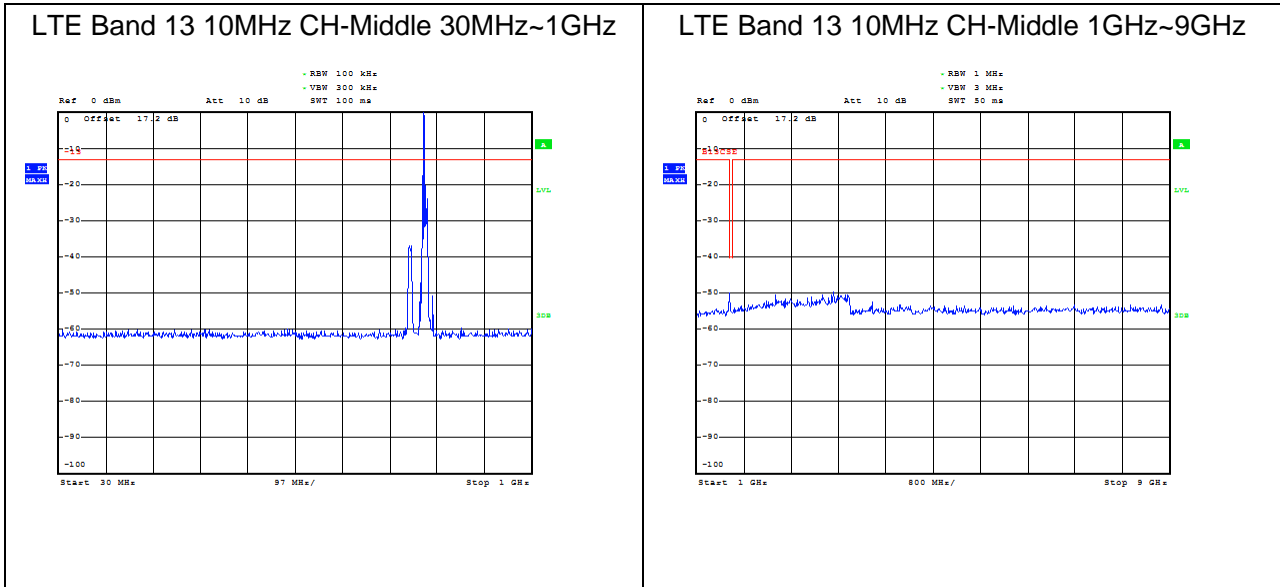

If disturbances were found more than 20dB below limit line, the mark is not required for the EUT. The signal beyond the limit is carrier in the following plots.

Test Data File Name	Frequency (MHz)	Level (dBm)	Limit (dBm)	Margin (dB)
B12_CHLOW_1.4M_RB1_1-9GHz	1353.9	-29.465	-13	16.465
B12_CHMID_1.4M_RB1_1-9GHz	1363.6	-32.283	-13	19.283
B12_CHLOW_3M_RB1_1-9GHz	1359.7	-29.465	-13	16.465
B12_CHMID_3M_RB1_1-9GHz	1365.6	-32.151	-13	19.151
B12_CHHIGH_3M_RB1_1-9GHz	1384.7	-32.881	-13	19.881
B12_CHLOW_5M_RB1_1-9GHz	1366.2	-29.207	-13	16.207
B12_CHMID_5M_RB1_1-9GHz	1375.9	-32.025	-13	19.025
B12_CHHIGH_5M_RB1_1-9GHz	1388.0	-32.909	-13	19.909
B12_CHLOW_10M_RB1_1-9GHz	1372.0	-29.212	-13	16.212
B12_CHMID_10M_RB1_1-9GHz	1377.9	-31.892	-13	18.892
B12_CHHIGH_10M_RB1_1-9GHz	1397.0	-32.611	-13	19.611

5.8 Radiates Spurious Emission

Ambient condition

Temperature	Relative humidity	Pressure
23°C ~25°C	45%~50%	101.5kPa

Method of Measurement

1. The testing follows FCC KDB 971168 D01 v03r01 Section 5.8 and ANSI/TIA-603-E (2016).
 2. The EUT is placed on a turntable 0.8 meters above the ground in the chamber, 3 meter away from the antenna. The maximal emission value is acquired by adjusting the antenna height, polarisation and turntable azimuth. Normally, the height range of antenna is 1 m to 4 m, the azimuth range of turntable is 0° to 360°, and the receive antenna has two polarizations Vertical (V) and Horizontal (H).
 3. A log-periodic antenna or double-ridged waveguide horn antenna shall be substituted in place of the EUT. The log-periodic antenna will be driven by a signal generator and the level will be adjusted till the same power value on the spectrum analyzer or receiver. The level of the spurious emissions can be calculated through the level of the signal generator, cable loss, the gain of the substitution antenna and the reading of the spectrum analyzer or receiver.
 4. The EUT is then put into continuously transmitting mode at its maximum power level during the test. Set Test Receiver or Spectrum RBW=1MHz, VBW=3MHz, And the maximum value of the receiver should be recorded as (Pr).
 5. The EUT shall be replaced by a substitution antenna. In the chamber, an substitution antenna for the frequency band of interest is placed at the reference point of the chamber. An RF Signal source for the frequency band of interest is connected to the substitution antenna with a cable that has been constructed to not interfere with the radiation pattern of the antenna. A power (PMea) is applied to the input of the substitution antenna, and adjust the level of the signal generator output until the value of the receiver reach the previously recorded (Pr). The power of signal source (PMea) is recorded. The test should be performed by rotating the test item and adjusting the receiving antenna polarization.
 6. A amplifier should be connected to the Signal Source output port. And the cable should be connect between the Amplifier and the Substitution Antenna. The cable loss (Pcl) ,the Substitution Antenna Gain (Ga) and the Amplifier Gain (PAg) should be recorded after test.
 7. The measurement results are obtained as described below:

$$\text{Power(EIRP)} = \text{PMea} - \text{PAg} - \text{Pcl} + \text{Ga}$$
 The measurement results are amend as described below:

$$\text{Power(EIRP)} = \text{PMea} - \text{Pcl} + \text{Ga}$$
 8. This value is EIRP since the measurement is calibrated using an antenna of known gain (2.15 dBi) and known input power. ERP can be calculated from EIRP by subtracting the gain of the dipole, $\text{ERP} = \text{EIRP} - 2.15\text{dBi}$.
- The modulation mode and RB allocation refer to section 5.1, using the maximum output power configuration.

Test setup

30MHz~~~ 1GHz

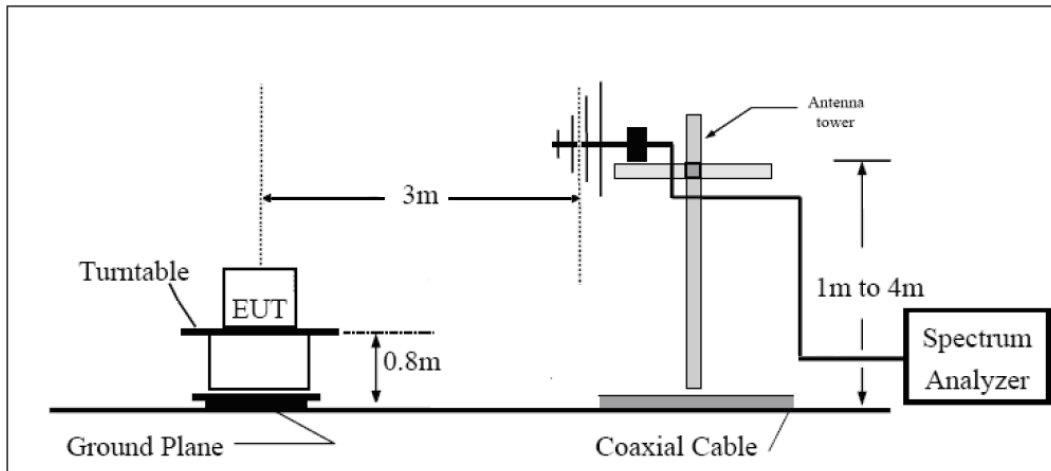

Above 1GHz

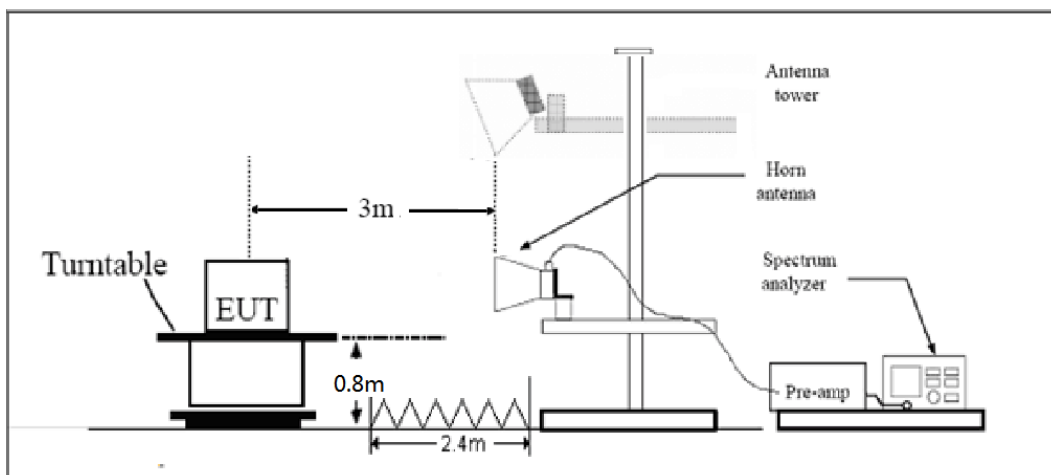

Note: Area side:2.4mX3.6m

The radiated emission was measured in the following position: EUT stand-up position (Z axis), lie-down position (X, Y axis). The worst emission was found in lie-down position (X axis) and the worst case was recorded.

Limits

Rule Part 27.53(h) specifies that “for operations in the 1695-1710 MHz, 1710-1755 MHz, 1755-1780 MHz, 1915-1920 MHz, 1995-2000 MHz, 2000-2020 MHz, 2110-2155 MHz, 2155-2180 MHz, and 2180-2200 bands, the power of any emission outside a licensee's frequency block shall be attenuated below the transmitter power (P) in watts by at least $43 + 10 \log_{10} (P)$ dB..”

Rule Part 27.53 (g) For operations in the 600 MHz band and the 698-746 MHz band, the power of any emission outside a licensee's frequency band(s) of operation shall be attenuated below the transmitter power (P) within the licensed band(s) of operation, measured in watts, by at least $43 + 10 \log (P)$ dB. Compliance with this provision is based on the use of measurement instrumentation employing a resolution bandwidth of 100 kilohertz or greater. However, in the 100 kilohertz bands



immediately outside and adjacent to a licensee's frequency block, a resolution bandwidth of at least 30 kHz may be employed.

Rule Part 27.53(f) For operations in the 746-758 MHz, 775-788 MHz, and 805-806 MHz bands, emissions in the band 1559-1610 MHz shall be limited to -70 dBW/MHz equivalent isotropically radiated power (EIRP) for wideband signals, and -80 dBW EIRP for discrete emissions of less than 700 Hz bandwidth. For the purpose of equipment authorization, a transmitter shall be tested with an antenna that is representative of the type that will be used with the equipment in normal operation.

Part 27.53(h)(g) Limit		-13 dBm
Part 27.53(f) Limit	Limit out of the band 1559-1610 MHz	-13 dBm
	Limit in the band 1559-1610 MHz	-40 dBm

Measurement Uncertainty

The assessed measurement uncertainty to ensure 95% confidence level for the normal distribution is with the coverage factor $k = \pm 1.96$, $U = \pm 3.55$ dB.

Test Result

Sweep the whole frequency band through the range from 30MHz to the 10th harmonic of the carrier, the emissions below the noise floor will not be recorded in the report.

WCDMA Band IV CH-Low

Harmonic	Frequency (MHz)	SG (dBm)	Cable Loss (dB)	Gain (dBi)	Antenna Polarization	EIRP Level (dBm)	Limit (dBm)	Margin (dB)	Azimuth (deg)
2	3424.8	-51.25	2.6	10.15	Horizontal	-43.7	-13.0	30.7	315
3	5137.2	-51.75	2.4	11.35	Horizontal	-42.8	-13.0	29.8	45
4	6850.1	-56.75	4.5	10.85	Horizontal	-50.4	-13.0	37.4	90
5	8562.0	-53.85	5.1	11.35	Horizontal	-47.6	-13.0	34.6	0
6	10274.4	-52.55	5.3	11.95	Horizontal	-45.9	-13.0	32.9	225
7	11986.8	-51.75	5.5	13.55	Horizontal	-43.7	-13.0	30.7	135
8	13699.2	-48.35	6.3	13.75	Horizontal	-40.9	-13.0	27.9	180
9	15411.6	-50.25	6.7	13.85	Horizontal	-43.1	-13.0	30.1	0
10	17124.0	-46.55	6.8	14.25	Horizontal	-39.1	-13.0	26.1	90

Note: 1.The other Spurious RF Radiated emissions level is no more than noise floor.
2. The worst emission was found in the antenna is Horizontal position.

WCDMA Band IV CH-Middle

Harmonic	Frequency (MHz)	SG (dBm)	Cable Loss (dB)	Gain (dBi)	Antenna Polarization	EIRP Level (dBm)	Limit (dBm)	Margin (dB)	Azimuth (deg)
2	3462.8	-53.85	2.6	10.75	Horizontal	-45.7	-13.0	32.7	270
3	5201.3	-51.75	2.4	11.05	Horizontal	-43.1	-13.0	30.1	135
4	6925.1	-55.75	4.5	11.15	Horizontal	-49.1	-13.0	36.1	180
5	8663.0	-53.15	5.1	11.35	Horizontal	-46.9	-13.0	33.9	45
6	10395.6	-50.05	5.3	11.95	Horizontal	-43.4	-13.0	30.4	0
7	12128.2	-50.75	5.5	13.55	Horizontal	-42.7	-13.0	29.7	180
8	13860.8	-47.65	6.3	13.75	Horizontal	-40.2	-13.0	27.2	315
9	15593.4	-49.75	6.7	13.85	Horizontal	-42.6	-13.0	29.6	45
10	17326.0	-46.55	6.8	14.25	Horizontal	-39.1	-13.0	26.1	90

Note: 1.The other Spurious RF Radiated emissions level is no more than noise floor.
2. The worst emission was found in the antenna is Horizontal position.

WCDMA Band IV CH-High

Harmonic	Frequency (MHz)	SG (dBm)	Cable Loss (dB)	Gain (dBi)	Antenna Polarization	EIRP Level (dBm)	Limit (dBm)	Margin (dB)	Azimuth (deg)
2	3503.3	-54.05	2.6	10.15	Horizontal	-46.5	-13.0	33.5	90
3	5254.1	-55.85	2.4	11.05	Horizontal	-47.2	-13.0	34.2	135
4	7010.4	-54.75	4.5	11.15	Horizontal	-48.1	-13.0	35.1	270
5	8763.0	-52.45	5.1	11.35	Horizontal	-46.2	-13.0	33.2	45
6	10515.6	-49.85	5.3	11.95	Horizontal	-43.2	-13.0	30.2	315
7	12268.2	-49.95	5.5	13.55	Horizontal	-41.9	-13.0	28.9	0
8	14020.8	-46.35	6.3	13.75	Horizontal	-38.9	-13.0	25.9	0
9	15773.4	-49.05	6.7	13.85	Horizontal	-41.9	-13.0	28.9	90
10	17526.0	-46.45	6.8	14.25	Horizontal	-39.0	-13.0	26.0	225

Note: 1. The other Spurious RF Radiated emissions level is no more than noise floor.

2. The worst emission was found in the antenna is Horizontal position.

LTE Band 4 QPSK 1.4MHz CH-Low, RB 1

Harmonic	Frequency (MHz)	SG (dBm)	Cable Loss (dB)	Gain (dBi)	Antenna Polarization	EIRP Level (dBm)	Limit (dBm)	Margin (dB)	Azimuth (deg)
2	3421.4	-35.15	2.6	10.15	Horizontal	-27.6	-13.0	14.6	90
3	5131.1	-45.15	2.4	11.35	Horizontal	-36.2	-13.0	23.2	180
4	6842.8	-47.15	4.5	10.85	Horizontal	-40.8	-13.0	27.8	0
5	8553.5	-48.95	5.1	11.35	Horizontal	-42.7	-13.0	29.7	180
6	10264.2	-51.55	5.3	11.95	Horizontal	-44.9	-13.0	31.9	90
7	11974.9	-50.75	5.5	13.55	Horizontal	-42.7	-13.0	29.7	315
8	13685.6	-47.95	6.3	13.75	Horizontal	-40.5	-13.0	27.5	135
9	15396.3	-48.25	6.7	13.85	Horizontal	-41.1	-13.0	28.1	45
10	17107.0	-47.35	6.8	14.25	Horizontal	-39.9	-13.0	26.9	90

Note: 1. The other Spurious RF Radiated emissions level is no more than noise floor.

2. The worst emission was found in the antenna is Horizontal position.

LTE Band 4 QPSK 1.4MHz CH-Middle, RB 1

Harmonic	Frequency (MHz)	SG (dBm)	Cable Loss (dB)	Gain (dBi)	Antenna Polarization	EIRP Level (dBm)	Limit (dBm)	Margin (dB)	Azimuth (deg)
2	3464.3	-39.95	2.6	10.75	Horizontal	-31.8	-13.0	18.8	225
3	5197.5	-48.85	2.4	11.05	Horizontal	-40.2	-13.0	27.2	135
4	6930.0	-53.75	4.5	11.15	Horizontal	-47.1	-13.0	34.1	370
5	8662.5	-47.35	5.1	11.35	Horizontal	-41.1	-13.0	28.1	0
6	10395.0	-50.15	5.3	11.95	Horizontal	-43.5	-13.0	30.5	0
7	12127.5	-50.45	5.5	13.55	Horizontal	-42.4	-13.0	29.4	180
8	13860.0	-47.65	6.3	13.75	Horizontal	-40.2	-13.0	27.2	90
9	15592.5	-48.15	6.7	13.85	Horizontal	-41.0	-13.0	28.0	315
10	17325.0	-47.25	6.8	14.25	Horizontal	-39.8	-13.0	26.8	135

Note: 1.The other Spurious RF Radiated emissions level is no more than noise floor.
2. The worst emission was found in the antenna is Horizontal position.

LTE Band 4 QPSK 1.4MHz CH-High, RB 1

Harmonic	Frequency (MHz)	SG (dBm)	Cable Loss (dB)	Gain (dBi)	Antenna Polarization	EIRP Level (dBm)	Limit (dBm)	Margin (dB)	Azimuth (deg)
2	3507.8	-44.45	2.6	10.15	Horizontal	-36.9	-13.0	23.9	45
3	5261.6	-50.35	2.4	11.05	Horizontal	-41.7	-13.0	28.7	90
4	7017.2	-48.35	4.5	11.15	Horizontal	-41.7	-13.0	28.7	135
5	8771.5	-50.65	5.1	11.35	Horizontal	-44.4	-13.0	31.4	370
6	10525.8	-49.55	5.3	11.95	Horizontal	-42.9	-13.0	29.9	0
7	12280.1	-50.35	5.5	13.55	Horizontal	-42.3	-13.0	29.3	0
8	14034.4	-46.55	6.3	13.75	Horizontal	-39.1	-13.0	26.1	180
9	15788.7	-47.35	6.7	13.85	Horizontal	-40.2	-13.0	27.2	90
10	17543.0	-46.85	6.8	14.25	Horizontal	-39.4	-13.0	26.4	315

Note: 1.The other Spurious RF Radiated emissions level is no more than noise floor.
2. The worst emission was found in the antenna is Horizontal position.



LTE Band 4 QPSK 5MHz CH-Low, RB 1

Harmonic	Frequency (MHz)	SG (dBm)	Cable Loss (dB)	Gain (dBi)	Antenna Polarization	EIRP Level (dBm)	Limit (dBm)	Margin (dB)	Azimuth (deg)
2	3425.0	-35.35	2.6	10.15	Horizontal	-27.8	-13.0	14.8	135
3	5131.1	-45.35	2.4	11.35	Horizontal	-36.4	-13.0	23.4	370
4	6850.0	-48.05	4.5	10.85	Horizontal	-41.7	-13.0	28.7	315
5	8562.5	-48.85	5.1	11.35	Horizontal	-42.6	-13.0	29.6	45
6	10275.0	-50.75	5.3	11.95	Horizontal	-44.1	-13.0	31.1	90
7	11987.5	-49.85	5.5	13.55	Horizontal	-41.8	-13.0	28.8	135
8	13700.0	-47.15	6.3	13.75	Horizontal	-39.7	-13.0	26.7	370
9	15412.5	-48.65	6.7	13.85	Horizontal	-41.5	-13.0	28.5	0
10	17125.0	-46.95	6.8	14.25	Horizontal	-39.5	-13.0	26.5	45

Note: 1.The other Spurious RF Radiated emissions level is no more than noise floor.
2. The worst emission was found in the antenna is Horizontal position.

LTE Band 4 QPSK 5MHz CH-Middle, RB 1

Harmonic	Frequency (MHz)	SG (dBm)	Cable Loss (dB)	Gain (dBi)	Antenna Polarization	EIRP Level (dBm)	Limit (dBm)	Margin (dB)	Azimuth (deg)
2	3460.5	-40.05	2.6	10.75	Horizontal	-31.9	-13.0	18.9	90
3	5191.5	-48.95	2.4	11.05	Horizontal	-40.3	-13.0	27.3	135
4	6930.0	-52.45	4.5	11.15	Horizontal	-45.8	-13.0	32.8	370
5	8662.5	-46.65	5.1	11.35	Horizontal	-40.4	-13.0	27.4	90
6	10395.0	-49.45	5.3	11.95	Horizontal	-42.8	-13.0	29.8	315
7	12127.5	-50.55	5.5	13.55	Horizontal	-42.5	-13.0	29.5	45
8	13860.0	-47.15	6.3	13.75	Horizontal	-39.7	-13.0	26.7	90
9	15592.5	-48.65	6.7	13.85	Horizontal	-41.5	-13.0	28.5	135
10	17325.0	-46.05	6.8	14.25	Horizontal	-38.6	-13.0	25.6	370

Note: 1.The other Spurious RF Radiated emissions level is no more than noise floor.
2. The worst emission was found in the antenna is Horizontal position.

LTE Band 4 QPSK 5MHz CH-High, RB 1

Harmonic	Frequency (MHz)	SG (dBm)	Cable Loss (dB)	Gain (dBi)	Antenna Polarization	EIRP Level (dBm)	Limit (dBm)	Margin (dB)	Azimuth (deg)
2	3500.6	-44.15	2.6	10.15	Horizontal	-36.6	-13.0	23.6	315
3	5250.8	-51.95	2.4	11.05	Horizontal	-43.3	-13.0	30.3	45
4	7010.0	-52.05	4.5	11.15	Horizontal	-45.4	-13.0	32.4	90
5	8762.5	-51.95	5.1	11.35	Horizontal	-45.7	-13.0	32.7	135
6	10515.0	-49.55	5.3	11.95	Horizontal	-42.9	-13.0	29.9	370
7	12267.5	-51.75	5.5	13.55	Horizontal	-43.7	-13.0	30.7	0
8	14020.0	-47.25	6.3	13.75	Horizontal	-39.8	-13.0	26.8	45
9	15772.5	-48.35	6.7	13.85	Horizontal	-41.2	-13.0	28.2	90
10	17525.0	-45.65	6.8	14.25	Horizontal	-38.2	-13.0	25.2	135

Note: 1.The other Spurious RF Radiated emissions level is no more than noise floor.

2. The worst emission was found in the antenna is Horizontal position.

LTE Band 4 QPSK 20MHz CH-Low, RB 1

Harmonic	Frequency (MHz)	SG (dBm)	Cable Loss (dB)	Gain (dBi)	Antenna Polarization	EIRP Level (dBm)	Limit (dBm)	Margin (dB)	Azimuth (deg)
2	3421.9	-37.45	2.6	10.15	Horizontal	-29.9	-13.0	16.9	370
3	5133.0	-47.65	2.4	11.35	Horizontal	-38.7	-13.0	25.7	90
4	6880.0	-50.75	4.5	10.85	Horizontal	-44.4	-13.0	31.4	315
5	8600.0	-49.25	5.1	11.35	Horizontal	-43.0	-13.0	30.0	45
6	10320.0	-49.15	5.3	11.95	Horizontal	-42.5	-13.0	29.5	90
7	12040.0	-51.75	5.5	13.55	Horizontal	-43.7	-13.0	30.7	135
8	13760.0	-46.95	6.3	13.75	Horizontal	-39.5	-13.0	26.5	315
9	15480.0	-49.75	6.7	13.85	Horizontal	-42.6	-13.0	29.6	45
10	17200.0	-47.35	6.8	14.25	Horizontal	-39.9	-13.0	26.9	90

Note: 1.The other Spurious RF Radiated emissions level is no more than noise floor.

2. The worst emission was found in the antenna is Horizontal position.

LTE Band 4 QPSK 20MHz CH-Middle, RB 1

Harmonic	Frequency (MHz)	SG (dBm)	Cable Loss (dB)	Gain (dBi)	Antenna Polarization	EIRP Level (dBm)	Limit (dBm)	Margin (dB)	Azimuth (deg)
2	3447.0	-38.35	2.6	10.75	Horizontal	-30.2	-13.0	17.2	135
3	5170.5	-47.45	2.4	11.05	Horizontal	-38.8	-13.0	25.8	370
4	6930.0	-50.65	4.5	11.15	Horizontal	-44.0	-13.0	31.0	0
5	8662.5	-49.85	5.1	11.35	Horizontal	-43.6	-13.0	30.6	45
6	10395.0	-49.05	5.3	11.95	Horizontal	-42.4	-13.0	29.4	90
7	12127.5	-51.45	5.5	13.55	Horizontal	-43.4	-13.0	30.4	135
8	13860.0	-46.75	6.3	13.75	Horizontal	-39.3	-13.0	26.3	45
9	15592.5	-50.05	6.7	13.85	Horizontal	-42.9	-13.0	29.9	90
10	17325.0	-47.25	6.8	14.25	Horizontal	-39.8	-13.0	26.8	135

Note: 1.The other Spurious RF Radiated emissions level is no more than noise floor.
 2. The worst emission was found in the antenna is Horizontal position.

LTE Band 4 QPSK 20MHz CH-High, RB 1

Harmonic	Frequency (MHz)	SG (dBm)	Cable Loss (dB)	Gain (dBi)	Antenna Polarization	EIRP Level (dBm)	Limit (dBm)	Margin (dB)	Azimuth (deg)
2	3472.1	-38.85	2.6	10.15	Horizontal	-31.3	-13.0	18.3	315
3	5208.4	-48.15	2.4	11.05	Horizontal	-39.5	-13.0	26.5	45
4	6980.0	-50.85	4.5	11.15	Horizontal	-44.2	-13.0	31.2	90
5	8725.0	-48.25	5.1	11.35	Horizontal	-42.0	-13.0	29.0	135
6	10470.0	-48.75	5.3	11.95	Horizontal	-42.1	-13.0	29.1	370
7	12215.0	-50.55	5.5	13.55	Horizontal	-42.5	-13.0	29.5	0
8	13960.0	-46.85	6.3	13.75	Horizontal	-39.4	-13.0	26.4	45
9	15705.0	-48.75	6.7	13.85	Horizontal	-41.6	-13.0	28.6	135
10	17450.0	-46.65	6.8	14.25	Horizontal	-39.2	-13.0	26.2	370

Note: 1.The other Spurious RF Radiated emissions level is no more than noise floor.
 2. The worst emission was found in the antenna is Horizontal position.



LTE Band 12 QPSK 1.4MHz CH-Low, RB 1

Harmonic	Frequency (MHz)	SG (dBm)	Cable Loss (dB)	Gain (dBi)	Antenna Polarization	ERP Level (dBm)	Limit (dBm)	Margin (dB)	Azimuth (deg)
2	1399.40	-56.30	2.00	10.15	Horizontal	-50.3	-13.0	37.3	315
3	2099.10	-60.20	2.50	11.35	Horizontal	-53.5	-13.0	40.5	45
4	2798.80	-59.00	4.20	10.85	Horizontal	-54.5	-13.0	41.5	45
5	3498.50	-59.80	5.20	11.35	Horizontal	-55.8	-13.0	42.8	135
6	4198.20	-59.40	5.50	11.95	Horizontal	-55.1	-13.0	42.1	135
7	4897.90	-60.00	5.70	13.55	Horizontal	-54.3	-13.0	41.3	370
8	5597.60	-58.20	6.30	13.75	Horizontal	-52.9	-13.0	39.9	90
9	6297.30	-55.90	6.80	13.85	Horizontal	-51.0	-13.0	38.0	315
10	6997.00	-54.00	6.90	14.25	Horizontal	-48.8	-13.0	35.8	45

Note: 1. The other Spurious RF Radiated emissions level is no more than noise floor.
2. The worst emission was found in the antenna is Horizontal position.

LTE Band 12 QPSK 1.4MHz CH-Middle, RB 1

Harmonic	Frequency (MHz)	SG (dBm)	Cable Loss (dB)	Gain (dBi)	Antenna Polarization	ERP Level (dBm)	Limit (dBm)	Margin (dB)	Azimuth (deg)
2	1415.00	-59.30	2.00	10.75	Horizontal	-52.7	-13.0	39.7	0
3	2122.50	-58.29	2.51	11.05	Horizontal	-51.9	-13.0	38.9	45
4	2830.00	-60.30	4.20	11.15	Horizontal	-55.5	-13.0	42.5	90
5	3537.50	-60.00	5.20	11.15	Horizontal	-56.2	-13.0	43.2	45
6	4245.00	-59.20	5.50	11.95	Horizontal	-54.9	-13.0	41.9	0
7	4952.50	-59.40	5.70	13.55	Horizontal	-53.7	-13.0	40.7	45
8	5660.00	-58.20	6.30	13.75	Horizontal	-52.9	-13.0	39.9	90
9	6367.50	-55.80	6.80	13.85	Horizontal	-50.9	-13.0	37.9	135
10	7075.00	-53.20	6.90	14.25	Horizontal	-48.0	-13.0	35.0	135

Note: 1. The other Spurious RF Radiated emissions level is no more than noise floor.
2. The worst emission was found in the antenna is Horizontal position.

LTE Band 12 QPSK 1.4MHz CH-High, RB 1

Harmonic	Frequency (MHz)	SG (dBm)	Cable Loss (dB)	Gain (dBi)	Antenna Polarization	ERP Level (dBm)	Limit (dBm)	Margin (dB)	Azimuth (deg)
2	1430.60	-61.50	2.00	10.15	Horizontal	-55.5	-13.0	42.5	135
3	2145.90	-57.59	2.51	11.05	Horizontal	-51.2	-13.0	38.2	135
4	2861.20	-59.90	4.20	11.15	Horizontal	-55.1	-13.0	42.1	45
5	3576.50	-59.60	5.20	11.15	Horizontal	-55.8	-13.0	42.8	45
6	4291.80	-59.40	5.50	11.95	Horizontal	-55.1	-13.0	42.1	0
7	5007.10	-58.10	5.70	13.55	Horizontal	-52.4	-13.0	39.4	45
8	5722.40	-55.60	6.30	13.75	Horizontal	-50.3	-13.0	37.3	45
9	6437.70	-54.70	6.80	13.85	Horizontal	-49.8	-13.0	36.8	90
10	7153.00	-52.80	6.90	14.25	Horizontal	-47.6	-13.0	34.6	135

Note: 1.The other Spurious RF Radiated emissions level is no more than noise floor.
2. The worst emission was found in the antenna is Horizontal position.

LTE Band 12 QPSK 5MHz CH-Low, RB 1

Harmonic	Frequency (MHz)	SG (dBm)	Cable Loss (dB)	Gain (dBi)	Antenna Polarization	ERP Level (dBm)	Limit (dBm)	Margin (dB)	Azimuth (deg)
2	1403.00	-60.00	2.00	10.15	Horizontal	-54.0	-13.0	41.0	90
3	2104.50	-63.20	2.50	11.35	Horizontal	-56.5	-13.0	43.5	135
4	2806.00	-59.50	4.20	10.85	Horizontal	-55.0	-13.0	42.0	135
5	3507.50	-60.20	5.20	11.35	Horizontal	-56.2	-13.0	43.2	315
6	4209.00	-59.60	5.50	11.95	Horizontal	-55.3	-13.0	42.3	45
7	4910.50	-59.50	5.70	13.55	Horizontal	-53.8	-13.0	40.8	90
8	5612.00	-56.50	6.30	13.75	Horizontal	-51.2	-13.0	38.2	135
9	6313.50	-55.50	6.80	13.85	Horizontal	-50.6	-13.0	37.6	315
10	7015.00	-52.00	6.90	14.25	Horizontal	-46.8	-13.0	33.8	45

Note: 1.The other Spurious RF Radiated emissions level is no more than noise floor.
2. The worst emission was found in the antenna is Horizontal position.

LTE Band 12 QPSK 5MHz CH-Middle, RB 1

Harmonic	Frequency (MHz)	SG (dBm)	Cable Loss (dB)	Gain (dBi)	Antenna Polarization	ERP Level (dBm)	Limit (dBm)	Margin (dB)	Azimuth (deg)
2	1415.00	-60.80	2.00	10.75	Horizontal	-54.2	-13.0	41.2	370
3	2122.50	-61.79	2.51	11.05	Horizontal	-55.4	-13.0	42.4	90
4	2830.00	-60.70	4.20	11.15	Horizontal	-55.9	-13.0	42.9	315
5	3537.50	-60.10	5.20	11.15	Horizontal	-56.3	-13.0	43.3	90
6	4245.00	-59.30	5.50	11.95	Horizontal	-55.0	-13.0	42.0	135
7	4952.50	-59.20	5.70	13.55	Horizontal	-53.5	-13.0	40.5	315
8	5660.00	-58.40	6.30	13.75	Horizontal	-53.1	-13.0	40.1	45
9	6367.50	-55.20	6.80	13.85	Horizontal	-50.3	-13.0	37.3	0
10	7075.00	-51.80	6.90	14.25	Horizontal	-46.6	-13.0	33.6	45

Note: 1.The other Spurious RF Radiated emissions level is no more than noise floor.
 2. The worst emission was found in the antenna is Horizontal position.

LTE Band 12 QPSK 5MHz CH-High, RB 1

Harmonic	Frequency (MHz)	SG (dBm)	Cable Loss (dB)	Gain (dBi)	Antenna Polarization	ERP Level (dBm)	Limit (dBm)	Margin (dB)	Azimuth (deg)
2	1427.00	-60.90	2.00	10.15	Horizontal	-54.9	-13.0	41.9	45
3	2140.50	-61.89	2.51	11.05	Horizontal	-55.5	-13.0	42.5	90
4	2854.00	-58.50	4.20	11.15	Horizontal	-53.7	-13.0	40.7	315
5	3567.50	-59.50	5.20	11.15	Horizontal	-55.7	-13.0	42.7	45
6	4281.00	-58.90	5.50	11.95	Horizontal	-54.6	-13.0	41.6	90
7	4994.50	-58.50	5.70	13.55	Horizontal	-52.8	-13.0	39.8	135
8	5708.00	-56.60	6.30	13.75	Horizontal	-51.3	-13.0	38.3	315
9	6421.50	-54.70	6.80	13.85	Horizontal	-49.8	-13.0	36.8	45
10	7135.00	-51.40	6.90	14.25	Horizontal	-46.2	-13.0	33.2	90

Note: 1.The other Spurious RF Radiated emissions level is no more than noise floor.
 2. The worst emission was found in the antenna is Horizontal position.

LTE Band 12 QPSK 10MHz CH-Low, RB 1

Harmonic	Frequency (MHz)	SG (dBm)	Cable Loss (dB)	Gain (dBi)	Antenna Polarization	ERP Level (dBm)	Limit (dBm)	Margin (dB)	Azimuth (deg)
2	1408.00	-55.70	2.00	10.15	Horizontal	-49.7	-13.0	36.7	45
3	2112.00	-59.69	2.51	11.35	Horizontal	-53.0	-13.0	40.0	90
4	2816.00	-59.50	4.20	10.85	Horizontal	-55.0	-13.0	42.0	135
5	3520.00	-60.20	5.20	11.35	Horizontal	-56.2	-13.0	43.2	135
6	4224.00	-59.60	5.50	11.95	Horizontal	-55.3	-13.0	42.3	315
7	4928.00	-58.10	5.70	13.55	Horizontal	-52.4	-13.0	39.4	45
8	5632.00	-58.70	6.30	13.75	Horizontal	-53.4	-13.0	40.4	0
9	6336.00	-55.50	6.80	13.85	Horizontal	-50.6	-13.0	37.6	45
10	7040.00	-53.00	6.90	14.25	Horizontal	-47.8	-13.0	34.8	90

Note: 1.The other Spurious RF Radiated emissions level is no more than noise floor.
2. The worst emission was found in the antenna is Horizontal position.

LTE Band 12 QPSK 10MHz CH-Middle, RB 1

Harmonic	Frequency (MHz)	SG (dBm)	Cable Loss (dB)	Gain (dBi)	Antenna Polarization	ERP Level (dBm)	Limit (dBm)	Margin (dB)	Azimuth (deg)
2	1415.00	-61.10	2.00	10.75	Horizontal	-54.5	-13.0	41.5	315
3	2122.50	-59.69	2.51	11.05	Horizontal	-53.3	-13.0	40.3	90
4	2830.00	-59.60	4.20	11.15	Horizontal	-54.8	-13.0	41.8	135
5	3537.50	-59.60	5.20	11.15	Horizontal	-55.8	-13.0	42.8	90
6	4245.00	-59.60	5.50	11.95	Horizontal	-55.3	-13.0	42.3	135
7	4952.50	-58.00	5.70	13.55	Horizontal	-52.3	-13.0	39.3	315
8	5660.00	-57.40	6.30	13.75	Horizontal	-52.1	-13.0	39.1	45
9	6367.50	-55.50	6.80	13.85	Horizontal	-50.6	-13.0	37.6	90
10	7075.00	-52.70	6.90	14.25	Horizontal	-47.5	-13.0	34.5	135

Note: 1.The other Spurious RF Radiated emissions level is no more than noise floor.
2. The worst emission was found in the antenna is Horizontal position.

LTE Band 12 QPSK 10MHz CH-High, RB 1

Harmonic	Frequency (MHz)	SG (dBm)	Cable Loss (dB)	Gain (dBi)	Antenna Polarization	ERP Level (dBm)	Limit (dBm)	Margin (dB)	Azimuth (deg)
2	1422.00	-59.10	2.00	10.15	Horizontal	-53.1	-13.0	40.1	315
3	2133.00	-59.49	2.51	11.05	Horizontal	-53.1	-13.0	40.1	45
4	2844.00	-58.80	4.20	11.15	Horizontal	-54.0	-13.0	41.0	90
5	3555.00	-59.10	5.20	11.15	Horizontal	-55.3	-13.0	42.3	315
6	4266.00	-59.40	5.50	11.95	Horizontal	-55.1	-13.0	42.1	45
7	4977.00	-58.10	5.70	13.55	Horizontal	-52.4	-13.0	39.4	0
8	5688.00	-56.90	6.30	13.75	Horizontal	-51.6	-13.0	38.6	45
9	6399.00	-54.40	6.80	13.85	Horizontal	-49.5	-13.0	36.5	90
10	7110.00	-52.50	6.90	14.25	Horizontal	-47.3	-13.0	34.3	90

Note: 1.The other Spurious RF Radiated emissions level is no more than noise floor.
2. The worst emission was found in the antenna is Horizontal position.

LTE Band 13 QPSK 5MHz CH-Low, RB 1

Harmonic	Frequency (MHz)	SG (dBm)	Cable Loss (dB)	Gain (dBi)	Antenna Polarization	ERP Level (dBm)	Limit (dBm)	Margin (dB)	Azimuth (deg)
2	1555.8	-58.10	2.00	10.15	Horizontal	-52.1	-40.0	12.1	315
3	2338.5	-56.00	2.50	11.35	Horizontal	-49.3	-13.0	36.3	45
4	3118.0	-59.60	4.20	10.85	Horizontal	-55.1	-13.0	42.1	135
5	3897.5	-58.70	5.20	11.35	Horizontal	-54.7	-13.0	41.7	315
6	4677.0	-58.90	5.50	11.95	Horizontal	-54.6	-13.0	41.6	45
7	5456.5	-58.30	5.70	13.55	Horizontal	-52.6	-13.0	39.6	90
8	6236.0	-56.70	6.30	13.75	Horizontal	-51.4	-13.0	38.4	135
9	7015.5	-53.50	6.80	13.85	Horizontal	-48.6	-13.0	35.6	315
10	7795.0	-53.40	6.90	14.25	Horizontal	-48.2	-13.0	35.2	45

Note: 1.The other Spurious RF Radiated emissions level is no more than noise floor.
2. The worst emission was found in the antenna is Horizontal position.

LTE Band 13 QPSK 5MHz CH-Middle, RB 1

Harmonic	Frequency (MHz)	SG (dBm)	Cable Loss (dB)	Gain (dBi)	Antenna Polarization	ERP Level (dBm)	Limit (dBm)	Margin (dB)	Azimuth (deg)
2	1564.0	-59.90	2.00	10.75	Horizontal	-53.3	-40.0	13.3	0
3	2346.0	-54.29	2.51	11.05	Horizontal	-47.9	-13.0	34.9	45
4	3128.0	-59.40	4.20	11.15	Horizontal	-54.6	-13.0	41.6	0
5	3910.0	-58.00	5.20	11.15	Horizontal	-54.2	-13.0	41.2	45
6	4692.0	-57.70	5.50	11.95	Horizontal	-53.4	-13.0	40.4	45
7	5474.0	-58.50	5.70	13.55	Horizontal	-52.8	-13.0	39.8	90
8	6256.0	-56.10	6.30	13.75	Horizontal	-50.8	-13.0	37.8	135
9	7038.0	-53.20	6.80	13.85	Horizontal	-48.3	-13.0	35.3	315
10	7820.0	-53.30	6.90	14.25	Horizontal	-48.1	-13.0	35.1	45

Note: 1.The other Spurious RF Radiated emissions level is no more than noise floor.
2. The worst emission was found in the antenna is Horizontal position.

LTE Band 13 QPSK 5MHz CH-High, RB 1

Harmonic	Frequency (MHz)	SG (dBm)	Cable Loss (dB)	Gain (dBi)	Antenna Polarization	ERP Level (dBm)	Limit (dBm)	Margin (dB)	Azimuth (deg)
2	1569.0	-56.70	2.00	10.15	Horizontal	-50.7	-40.0	10.7	45
3	2353.5	-56.59	2.51	11.05	Horizontal	-50.2	-13.0	37.2	90
4	3138.0	-59.10	4.20	11.15	Horizontal	-54.3	-13.0	41.3	90
5	3922.5	-57.90	5.20	11.15	Horizontal	-54.1	-13.0	41.1	135
6	4707.0	-55.90	5.50	11.95	Horizontal	-51.6	-13.0	38.6	315
7	5491.5	-56.20	5.70	13.55	Horizontal	-50.5	-13.0	37.5	45
8	6276.0	-55.60	6.30	13.75	Horizontal	-50.3	-13.0	37.3	0
9	7060.5	-53.10	6.80	13.85	Horizontal	-48.2	-13.0	35.2	45
10	7845.0	-53.10	6.90	14.25	Horizontal	-47.9	-13.0	34.9	45

Note: 1.The other Spurious RF Radiated emissions level is no more than noise floor.
2. The worst emission was found in the antenna is Horizontal position.

LTE Band 13 QPSK 10MHz CH-Low, RB 1

Harmonic	Frequency (MHz)	SG (dBm)	Cable Loss (dB)	Gain (dBi)	Antenna Polarization	ERP Level (dBm)	Limit (dBm)	Margin (dB)	Azimuth (deg)
2	1556.5	-55.50	2.00	10.15	Horizontal	-49.5	-40.0	9.5	135
3	2346.0	-51.29	2.51	11.35	Horizontal	-44.6	-13.0	31.6	315
4	3128.0	-59.10	4.20	10.85	Horizontal	-54.6	-13.0	41.6	90
5	3910.0	-58.10	5.20	11.35	Horizontal	-54.1	-13.0	41.1	135
6	4692.0	-57.10	5.50	11.95	Horizontal	-52.8	-13.0	39.8	315
7	5474.0	-57.40	5.70	13.55	Horizontal	-51.7	-13.0	38.7	90
8	6256.0	-57.60	6.30	13.75	Horizontal	-52.3	-13.0	39.3	135
9	7038.0	-53.50	6.80	13.85	Horizontal	-48.6	-13.0	35.6	315
10	7820.0	-53.40	6.90	14.25	Horizontal	-48.2	-13.0	35.2	45

Note: 1.The other Spurious RF Radiated emissions level is no more than noise floor.
2. The worst emission was found in the antenna is Horizontal position.

LTE Band 13 QPSK 10MHz CH-Middle, RB 1

Harmonic	Frequency (MHz)	SG (dBm)	Cable Loss (dB)	Gain (dBi)	Antenna Polarization	ERP Level (dBm)	Limit (dBm)	Margin (dB)	Azimuth (deg)
2	1555.3	-59.50	2.00	10.75	Horizontal	-52.9	-40.0	12.9	90
3	2346.0	-56.09	2.51	11.05	Horizontal	-49.7	-13.0	36.7	90
4	3128.0	-58.80	4.20	11.15	Horizontal	-54.0	-13.0	41.0	90
5	3910.0	-58.00	5.20	11.15	Horizontal	-54.2	-13.0	41.2	135
6	4692.0	-56.90	5.50	11.95	Horizontal	-52.6	-13.0	39.6	315
7	5474.0	-57.80	5.70	13.55	Horizontal	-52.1	-13.0	39.1	45
8	6256.0	-57.00	6.30	13.75	Horizontal	-51.7	-13.0	38.7	0
9	7038.0	-52.70	6.80	13.85	Horizontal	-47.8	-13.0	34.8	45
10	7820.0	-52.50	6.90	14.25	Horizontal	-47.3	-13.0	34.3	315

Note: 1.The other Spurious RF Radiated emissions level is no more than noise floor.
2. The worst emission was found in the antenna is Horizontal position.



LTE Band 13 QPSK 10MHz CH-High, RB 1

Harmonic	Frequency (MHz)	SG (dBm)	Cable Loss (dB)	Gain (dBi)	Antenna Polarization	ERP Level (dBm)	Limit (dBm)	Margin (dB)	Azimuth (deg)
2	1564.0	-55.90	2.00	10.15	Horizontal	-49.9	-40.0	9.9	135
3	2346.0	-51.29	2.51	11.05	Horizontal	-44.9	-13.0	31.9	315
4	3128.0	-59.00	4.20	11.15	Horizontal	-54.2	-13.0	41.2	45
5	3910.0	-57.60	5.20	11.15	Horizontal	-53.8	-13.0	40.8	45
6	4692.0	-56.90	5.50	11.95	Horizontal	-52.6	-13.0	39.6	0
7	5474.0	-57.80	5.70	13.55	Horizontal	-52.1	-13.0	39.1	45
8	6256.0	-56.50	6.30	13.75	Horizontal	-51.2	-13.0	38.2	90
9	7038.0	-52.80	6.80	13.85	Horizontal	-47.9	-13.0	34.9	135
10	7820.0	-52.40	6.90	14.25	Horizontal	-47.2	-13.0	34.2	135

Note: 1. The other Spurious RF Radiated emissions level is no more than noise floor.

2. The worst emission was found in the antenna is Horizontal position.

6 Main Test Instruments

Name	Manufacturer	Type	Serial Number	Calibration Date	Expiration Date
Base Station Simulator	R&S	CMW500	113645	2018-05-20	2019-05-19
Power Splitter	Hua Xiang	SHX-GF2-2-13	10120101	2018-05-20	2019-05-19
Spectrum Analyzer	Key sight	N9010A	MY50210259	2018-05-20	2019-05-19
Signal Analyzer	R&S	FSV30	100815	2017-12-17	2018-12-16
Signal generator	R&S	SMB 100A	102594	2018-05-20	2019-05-19
EMI Test Receiver	R&S	ESCI	100948	2018-05-20	2019-05-19
Loop Antenna	SCHWARZBECK	FMZB1519	1519-047	2014-12-06	2019-12-05
Trilog Antenna	SCHWARZBECK	VUBL 9163	9163-201	2017-11-18	2020-11-17
Horn Antenna	R&S	HF907	100126	2014-12-06	2019-12-05
Horn Antenna	ETS-Lindgren	3160-09	00102643	2015-01-30	2020-01-29
Climatic Chamber	Re Ce	PT-30B	20101891	2015-07-18	2018-07-17
RF Cable	Agilent	SMA 15cm	0001	NA	NA
Preamplifier	R&S	SCU18	102327	2018-05-20	2019-05-19
MOB COMMS DC SUPPLY	Keysight	66319D	MY43004105	2018-05-20	2019-05-19
Software	R&S	EMC32	V 8.52.0	NA	NA

*****END OF REPORT *****

ANNEX A: EUT Appearance and Test Setup

A.1 EUT Appearance

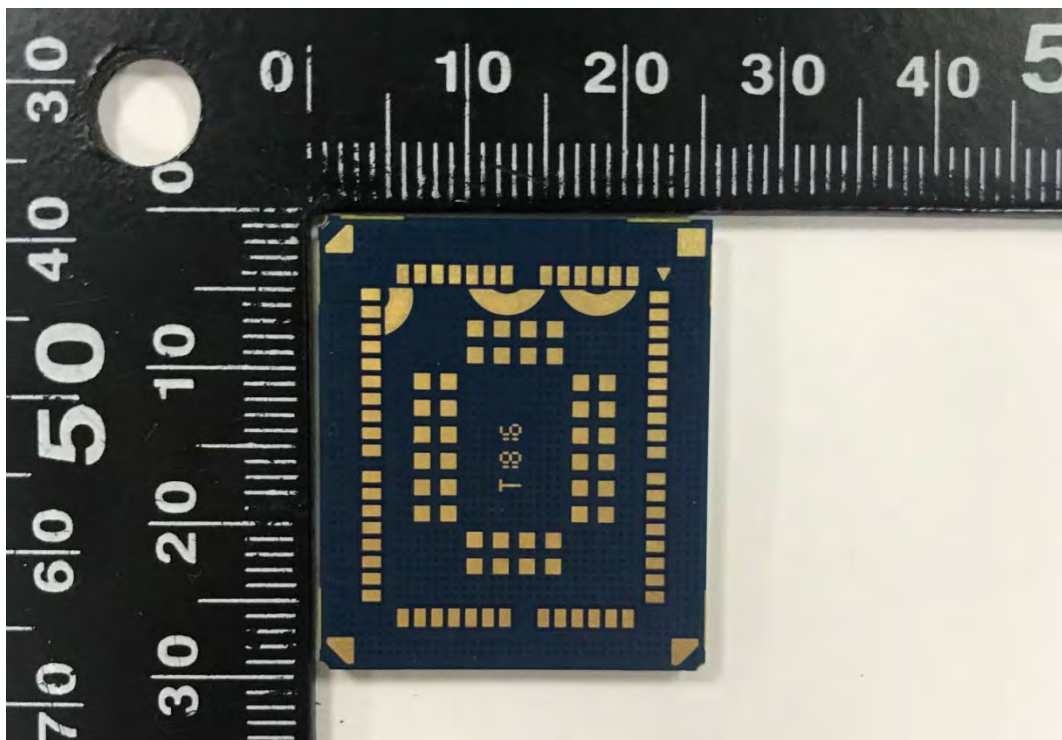

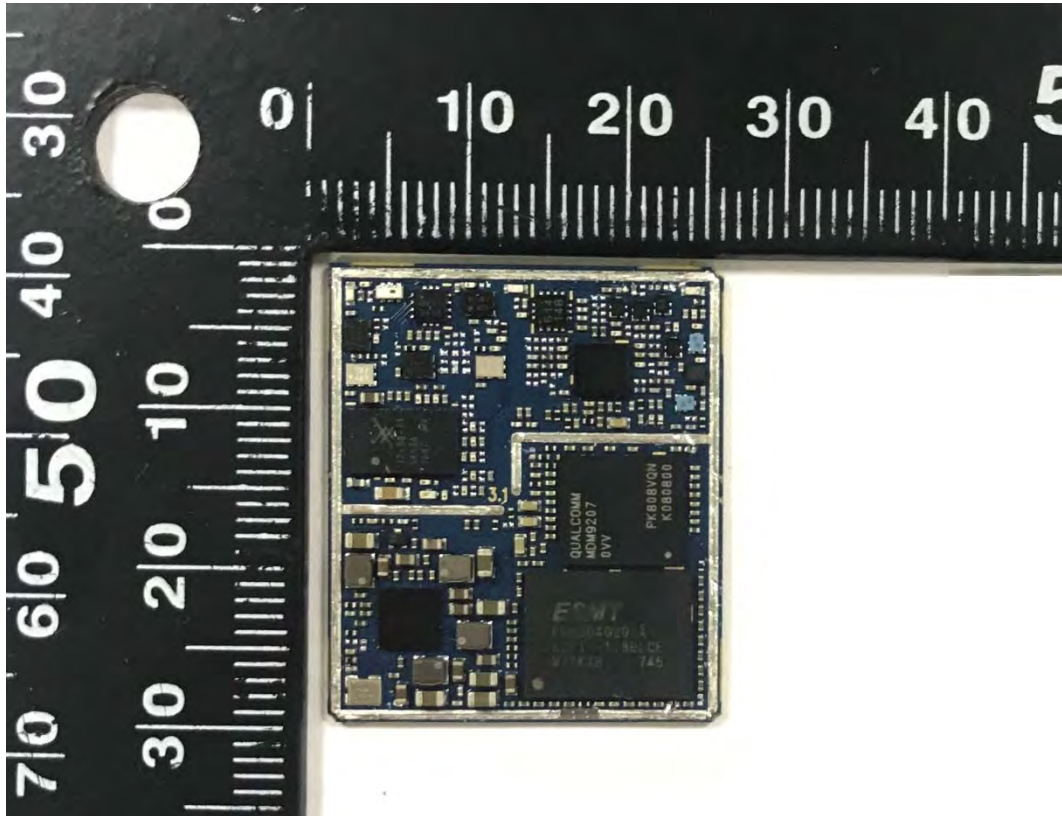

a: EUT

Picture 1 EUT and Accessory

A.2 Test Setup

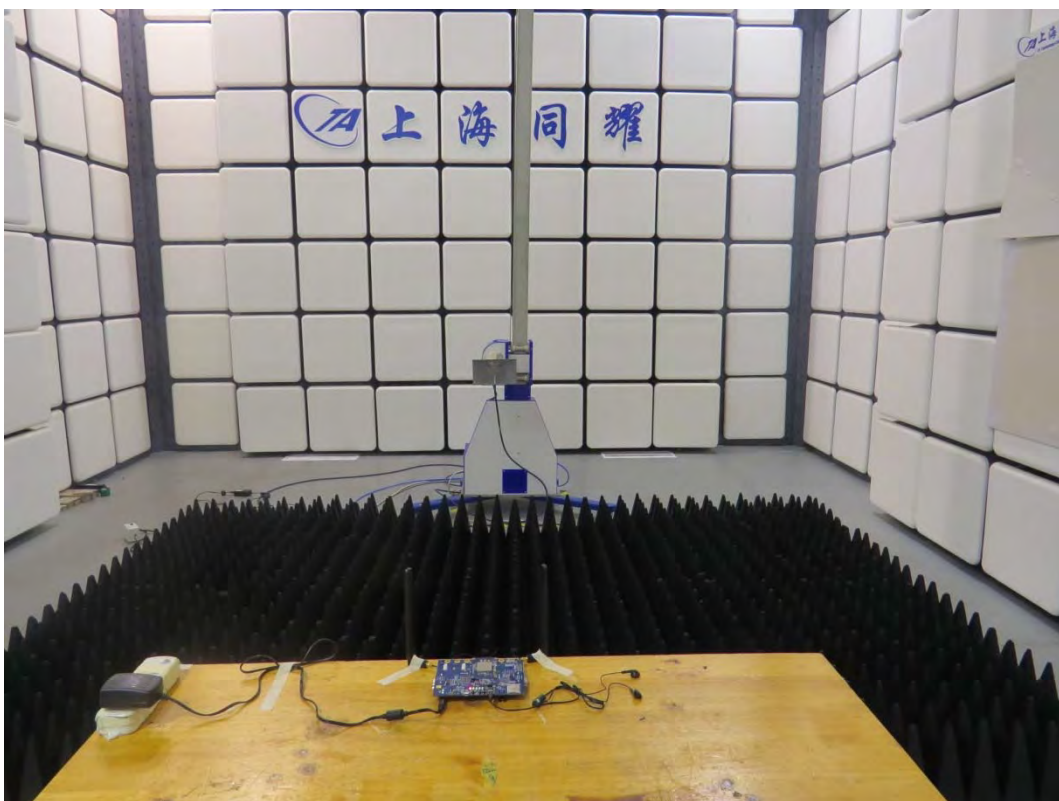
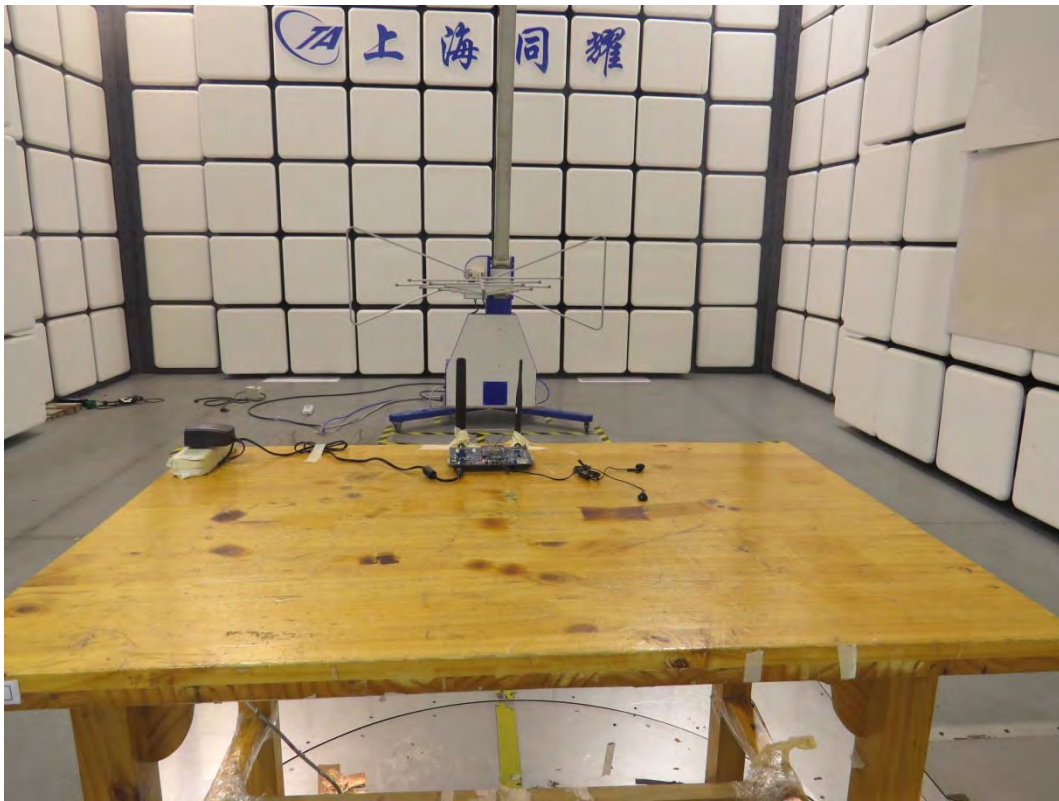

Picture 2: Radiated Spurious Emissions Test setup