



Prüfbericht-Nr.: <i>Test report no.:</i>	CN21AUGI 001	Auftrags-Nr.: <i>Order no.:</i>	168332007	Seite 1 von 32 <i>Page 1 of 32</i>	
Kunden-Referenz-Nr.: <i>Client reference no.:</i>	N/A	Auftragsdatum: <i>Order date:</i>	2021-08-04		
Auftraggeber: <i>Client:</i>	Shenzhen RAKwireless Technology Co.,Ltd. Room 506, Building B, New Compark, Pingshan First Road, Taoyuan Street, Nanshan District, Shenzhen, Guangdong, China				
Prüfgegenstand: <i>Test item:</i>	WisLink LPWAN Concentrator				
Bezeichnung / Typ-Nr.: <i>Identification / Type no.:</i>	RAK5146 (Trademark: RAK)				
Auftrags-Inhalt: <i>Order content:</i>	FCC and IC approval				
Prüfgrundlage: <i>Test specification:</i>	CFR47 FCC Part 15: Subpart C Section 15.247 CFR47 FCC Part 15: Subpart C Section 15.207 CFR47 FCC Part 15: Subpart C Section 15.209 CFR47 FCC Part 2: Section 2.1093		RSS-247 Issue 2 February 2017 RSS-Gen Issue 5 March 2019 RSS-102 Issue 5 March 2015		
Wareneingangsdatum: <i>Date of sample receipt:</i>	2021-08-20	Please refer to photo documents			
Prüfmuster-Nr.: <i>Test sample no.:</i>	A003107075				
Prüfzeitraum: <i>Testing period:</i>	2021-09-02 - 2021-09-20				
Ort der Prüfung: <i>Place of testing:</i>	TÜV Rheinland (Shenzhen) Co., Ltd.				
Prüflaboratorium: <i>Testing laboratory:</i>	TÜV Rheinland (Shenzhen) Co., Ltd.				
Prüfergebnis*: <i>Test result*:</i>	Pass				
geprüft von: <i>tested by:</i>			genehmigt von: <i>authorized by:</i>		
Datum: <i>Date:</i> 2021-09-22	Signed by: Alex Lan		Ausstellungsdatum: <i>Issue date:</i> 2021-09-22	Signed by: Lin Lin	
Stellung / Position	Senior Project Engineer		Stellung / Position	Reviewer	
Sonstiges / Other:	FCC ID: 2AF6B-RAK5146 IC: 25908-RAK5146, HVIN: RAK5146				
Zustand des Prüfgegenstandes bei Anlieferung: <i>Condition of the test item at delivery:</i>	Prüfmuster vollständig und unbeschädigt <i>Test item complete and undamaged:</i>				
Legend:	1 = sehr gut P(ass) = entspricht o.g. Prüfgrundlage(n) 1 = very good P(ass) = passed a.m. test specifications(s)	2 = gut 2 = good	3 = befriedigend F(ail) = entspricht nicht o.g. Prüfgrundlage(n) 3 = satisfactory F(ail) = failed a.m. test specifications(s)	4 = ausreichend 4 = sufficient N/A = nicht anwendbar N/A = not applicable	5 = mangelhaft N/T = nicht getestet 5 = poor N/T = not tested
Dieser Prüfbericht bezieht sich nur auf das o.g. Prüfmuster und darf ohne Genehmigung der Prüfstelle nicht auszugsweise vervielfältigt werden. Dieser Bericht berechtigt nicht zur Verwendung eines Prüfzeichens. <i>This test report only relates to the a. m. test sample. Without permission of the test center this test report is not permitted to be duplicated in extracts. This test report does not entitle to carry any test mark.</i>					

V05

Test Summary

5.1.1 ANTENNA REQUIREMENT*RESULT: Pass***5.1.2 MAXIMUM CONDUCTED OUTPUT POWER***RESULT: Pass***5.1.3 CONDUCTED POWER SPECTRAL DENSITY***RESULT: Pass***5.1.4 6dB BANDWIDTH***RESULT: Pass***5.1.5 20dB BANDWIDTH***RESULT: Pass***5.1.6 99% BANDWIDTH***RESULT: Pass***5.1.7 CONDUCTED SPURIOUS EMISSIONS MEASURED IN 100 KHz BANDWIDTH***RESULT: Pass***5.1.8 RADIATED SPURIOUS EMISSION***RESULT: Pass***5.1.9 CARRIER FREQUENCY SEPARATION***RESULT: Pass***5.1.10 NUMBER OF HOPPING FREQUENCY***RESULT: Pass***5.1.11 TIME OF OCCUPANCY***RESULT: Pass***5.1.12 CONDUCTED EMISSION ON AC MAINS***RESULT: Pass***6.1.1 ELECTROMAGNETIC FIELDS***RESULT: Pass*

Contents

1	GENERAL REMARKS	5
1.1	COMPLEMENTARY MATERIALS.....	5
2	TEST SITES.....	5
2.1	TEST FACILITIES	5
2.2	LIST OF TEST AND MEASUREMENT INSTRUMENTS	6
2.3	TRACEABILITY	7
2.4	CALIBRATION.....	7
2.5	MEASUREMENT UNCERTAINTY.....	7
2.6	LOCATION OF ORIGINAL DATA.....	8
2.7	STATUS OF FACILITY USED FOR TESTING	8
3	GENERAL PRODUCT INFORMATION	9
3.1	PRODUCT FUNCTION AND INTENDED USE	9
3.2	RATINGS AND SYSTEM DETAILS.....	10
3.3	INDEPENDENT OPERATION MODES.....	11
3.4	NOISE GENERATING AND NOISE SUPPRESSING PARTS	11
3.5	SUBMITTED DOCUMENTS.....	11
4	TEST SET-UP AND OPERATION MODES.....	12
4.1	PRINCIPLE OF CONFIGURATION SELECTION	12
4.2	TEST OPERATION AND TEST SOFTWARE	12
4.3	SPECIAL ACCESSORIES AND AUXILIARY EQUIPMENT	12
4.4	COUNTERMEASURES TO ACHIEVE EMC COMPLIANCE	12
4.5	TEST SETUP DIAGRAM	13
5	TEST RESULTS	15
5.1	TRANSMITTER REQUIREMENT & TEST SUITES.....	15
5.1.1	<i>Antenna Requirement.....</i>	<i>15</i>
5.1.2	<i>Maximum Conducted Output Power.....</i>	<i>16</i>
5.1.3	<i>Conducted Power Spectral Density.....</i>	<i>18</i>
5.1.4	<i>6dB Bandwidth</i>	<i>20</i>
5.1.5	<i>20dB Bandwidth</i>	<i>21</i>
5.1.6	<i>99% Bandwidth.....</i>	<i>22</i>
5.1.7	<i>Conducted Spurious Emissions Measured in 100 kHz Bandwidth.....</i>	<i>23</i>
5.1.8	<i>Radiated Spurious Emission</i>	<i>24</i>
5.1.9	<i>Carrier Frequency Separation</i>	<i>25</i>
5.1.10	<i>Number of Hopping Frequency.....</i>	<i>27</i>
5.1.11	<i>Time of Occupancy</i>	<i>28</i>
5.1.12	<i>Conducted Emission on AC Mains.....</i>	<i>29</i>
6	SAFETY HUMAN EXPOSURE.....	30
6.1	RADIO FREQUENCY EXPOSURE COMPLIANCE.....	30
6.1.1	<i>Electromagnetic Fields</i>	<i>30</i>

7 **PHOTOGRAPHS OF THE TEST SET-UP32**

8 **LIST OF TABLES.....32**

1 General Remarks

1.1 Complementary Materials

All attachments are integral parts of this test report. This applies especially to the following appendix:

Appendix A: Photographs of the Test Set-up

Appendix B: Test Results.

2 Test Sites

2.1 Test Facilities

TÜV Rheinland (Shenzhen) Co., Ltd.

362 Huanguan Road Middle Longhua District, Shenzhen 518110 People's Republic of China

FCC Registration No.: 694916

ISED wireless device testing laboratory: 25069

2.2 List of Test and Measurement Instruments

Table 1: List of Test and Measurement Equipment

TÜV Rheinland (Shenzhen) Co., Ltd.

Radio Spectrum Testing (TS8997)				
Equipment	Manufacturer	Model	Serial No.	Cal. until
Wireless Connectivity Tester	R&S	CMW270	101375	2022-08-09
Signal Analyzer	R&S	FSV 40	101441	2022-08-09
Vector Signal Generator	R&S	SMBV100A	263301	2022-08-09
Signal Generator	R&S	SMB100A	115186	2022-08-09
OSP	R&S	OSP 150	101017	2021-12-10
Control PC	DELL	OptiPlex 7050	FTJZ9P2	N/A
Test Software	R&S	WMS32 (V11.00.00)	N/A	N/A
Power Meter	R&S	NRP2	107105	2021-12-10
Power Sensor	R&S	NRP-Z81	105677	2022-08-09
Shielding Room 8#	Albatross	SR8	APC17151-SR8	2024-06-22
Unwanted Emission Testing (TS9975)				
Equipment	Manufacturer	Model	Serial No.	Cal. until
EMI Test Receiver	R&S	ESR 7	102021	2022-08-10
Signal Analyzer	R&S	FSV 40	101439	2022-08-09
System Controller Interface	R&S	SCI-100	S10010038	N/A
Filterbank	R&S	Wlan	100759	2022-08-09
OSP	R&S	OSP 120	102040	N/A
Pre-amplifier	R&S	SCU08F1	08320031	2022-08-09
Amplifier	R&S	SCU-18F	180070	2022-08-09
Amplifier	R&S	SCU40A	100475	2022-08-09
Trilog Broadband Antenna (30 MHz - 7 GHz)	Schwarzbeck	VULB 9162	193	2022-08-08
Double-Ridged Antenna (1 -18 GHz)	ETS-LINDGREN	3117	00218717	2022-08-08
Wideband Ridged Horn Antenna (18-40 GHz)	Steatite	QMS-00880	19067	2022-08-08
Active Loop Antenna	Schwarzbeck	FMZB 1513	302	2022-09-13
Test software	R&S	EMC32 (V10.60.10)	N/A	N/A
Control PC	Dell	OptiPlex 7050	36NV9P2	N/A
3m Semi-Anechoic Chamber	Albatross	SAC-3m	APC17151-SAC	2024-06-22
Conducted Emission on AC Mains				
Equipment	Manufacturer	Model No.	Serial No.	Cali. until
EMI Test Receiver	R&S	ESR3	102680	2022-04-25

Artificial Mains Network	R&S	ENV216	101445	2022-04-25
EMC32 test software	R&S	EMC32(Ver.10.50.00)	N/A	N/A

2.3 Traceability

All measurement equipment calibrations are traceable to NIM (National Institute of Metrology) or where calibration is performed in other countries, to equivalent nationally recognized standards organizations.

2.4 Calibration

Equipment requiring calibration is calibrated periodically by the manufacturer or according to manufacturer's specifications. Additionally all equipment is verified for proper performance on a regular basis using in house standards or comparisons.

2.5 Measurement Uncertainty

The estimated combined standard uncertainty for radiated emissions and conducted emissions measurements as below table.

Parameter	Uncertainty
Radio Frequency	$\pm 1 \times 10^{-7}$
RF Power (conducted)	± 2.5 dB
Radiated Emission of Transmitter, valid up to 26.5 GHz	± 6 dB
Radiated Emission of Receiver, valid up to 26.5 GHz	± 6 dB
Conducted Emission, (9kHz to 150kHz)/(150kHz to 30MHz)	± 3.70 dB / ± 3.30 dB
Radiated Emission (3m SAC), 30MHz to 1000MHz	± 4.52 dB
Radiated Emission (3m SAC), above 1000MHz	± 4.37 dB
Temperature	± 1 °C
Humidity	± 5 %
Voltage (DC)	± 1 %
Voltage (AC, <10kHz)	± 2 %

2.6 Location of Original Data

The original copies of all test data taken during actual testing were attached at Appendix A & B of this report and delivered to the applicant. A copy has been retained in the TÜV Rheinland (Shenzhen) Co., Ltd. file for certification follow-up purposes.

2.7 Status of Facility Used for Testing

The TÜV Rheinland (Shenzhen) Co., Ltd. Test facility located at 362 Huanguan Road Middle Longhua District, Shenzhen 518110 People's Republic of China is listed on the US Federal Communications Commission list of facilities approved to perform measurements.

3 General Product Information

3.1 Product Function and Intended Use

The EUT is a WisLink LPWAN Concentrator which supports Lora technology.

This product has two construction, one has an additional baseboard and other doesn't have, the baseboard is the extension of I/O.

This module has six different antennas, the details specifications for these antennas as below:

Antenna #	Model	Antenna Gain	Antenna Type	Connector Type
1#	RAKARG15	8dBi	Fiber Glass Antenna	N-type male connector
2#	RAKARG14	5.8dBi	Fiber Glass Antenna	N-type male connector
3#	RAKARG19	5.1dBi	Fiber Glass Antenna	N-type male connector
4#	RAKARJ14	2.3 dBi	Dipole Antenna	RPSMA connector
5#	RAKARJ16	2.3 dBi	Dipole Antenna	RPSMA connector
6#	ANT-916-CW-HWR	1.2 dBi	Dipole Antenna	RPSMA connector

Note:

- When connecting to the module, all antennas listed above need to transfer to an **IPEX connector**.
- Antennas 1#, 2# and 3# have the same type and similar in-band and out-of-band characteristics, they are considered as equivalent antennas. Thus, the antenna 1# with highest gain was selected to be tested.
- Antennas 4#, 5# and 6# have the same type and similar in-band and out-of-band characteristics, they are considered as equivalent antennas. Thus, the antenna 4# with highest gain was selected to be tested.

Antenna 4# RAKARJ14 is identical with Antenna 5# RAKARJ16 except the color of enclosure different.

Data Rate	Configuration	Indicative physical bit rate [bit/sec]
0	LoRa Modulation: SF10 / Bandwidth 125 kHz	980
1	LoRa Modulation: SF9 / Bandwidth 125 kHz	1760
2	LoRa Modulation: SF8 / Bandwidth 125 kHz	3125
3	LoRa Modulation: SF7 / Bandwidth 125 kHz	5470
4	LoRa Modulation: SF8 / Bandwidth 500 kHz	12500
8	LoRa Modulation: SF12 / Bandwidth 500 kHz	980
9	LoRa Modulation: SF11 / Bandwidth 500 kHz	1760
10	LoRa Modulation: SF10 / Bandwidth 500 kHz	3900
11	LoRa Modulation: SF9 / Bandwidth 500 kHz	7000
12	LoRa Modulation: SF8 / Bandwidth 500 kHz	12500
13	LoRa Modulation: SF7 / Bandwidth 500 kHz	21900

For details refer to the User Manual, Technical Description and Circuit Diagram.

3.2 Ratings and System Details

Table 2: Technical Specification of EUT

General Information of EUT	Value
Kind of Equipment	WisLink LPWAN Concentrator
Type Designation	RAK5146
Trademark	RAK
FCC ID	2AF6B-RAK5146
IC	25908-RAK5146
HVIN	RAK5146
Operating Voltage	DC 3.3V (Supplied by socket of PCB board)

Technical Specification of Lora DTS	
Operating Frequency	923.3 - 927.5MHz
Type of Modulation	Lora
Data Rate	SF7 – SF12
Channel Number	8 channels
Channel Separation	600 KHz
Occupied Bandwidth	500 KHz
Technical Specification of Lora Hybrid	
Frequency Range	903.9MHz - 905.3MHz
Type of Modulation	Lora
Data Rate	SF7 – SF10
Channel Number	8 channels (DSS & DTS)
Channel Separation	200 KHz
Occupied Bandwidth	125 KHz

Table 3: RF Channel and Frequency of Lora DTS

RF Channel	Frequency (MHz)	RF Channel	Frequency (MHz)	RF Channel	Frequency (MHz)	RF Channel	Frequency (MHz)
0	923.3	2	924.5	4	925.7	6	926.9
1	923.9	3	925.1	5	926.3	7	927.5

Table 4: RF Channel and Frequency of Lora Hybrid

RF Channel	Frequency (MHz)	RF Channel	Frequency (MHz)	RF Channel	Frequency (MHz)	RF Channel	Frequency (MHz)
0	903.9	2	904.3	4	904.7	6	905.1
1	904.1	3	904.5	5	904.9	7	905.3

3.3 Independent Operation Modes

The basic operation modes are:

- A. On, Lora transmitting mode (DTS & Hybrid)
 - 1) Low Channel
 - 2) Middle Channel
 - 3) High Channel
- B. On, Transmitting on Hopping channel (Hybrid)
- C. Off

3.4 Noise Generating and Noise Suppressing Parts

Refer to Circuit Diagram for further details.

3.5 Submitted Documents

- ID Label and Location Info

- User Manual

4 Test Set-up and Operation Modes

4.1 Principle of Configuration Selection

Radio Spectrum: The equipment under test (EUT) was configured at its highest power output in order to measure its highest possible radiation and conducted level. The test modes were adapted accordingly in reference to the instructions for use.

Emission: The equipment under test (EUT) was configured to measure its highest possible radiation level. The test modes were adapted accordingly in reference to the instructions for use.

4.2 Test Operation and Test Software

Test operation refers to test setup in chapter 5. All tests were performed according to the procedures in ANSI C63.10: 2013 and ANSI C63.4: 2014.

According to clause 3.1, all tests were performed on model RAK5146 with baseboard for RAKARG15 & RAKARj14 antennas in this report.

4.3 Special Accessories and Auxiliary Equipment

Table 5: Auxiliary Equipment Used during Test

Description	Manufacturer	Model	S/N	Rating
PC	Lenovo	ThinkPad T480	N/A	PC
PC adapter	Lenovo	ADLX65YDC3A	01FR030	PC adapter

4.4 Countermeasures to Achieve EMC Compliance

The test sample which has been tested contained the noise suppression parts as described in the Technical Construction File (TCF).

No additional measures were employed to achieve compliance.

4.5 Test Setup Diagram

Diagram of Measurement Configuration for Radiation Test (Below 30MHz)

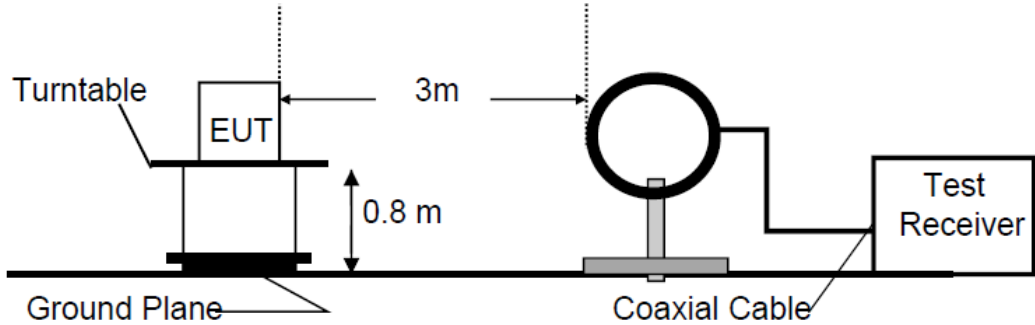

Diagram of Measurement Configuration for Radiation Test (Below 1GHz)

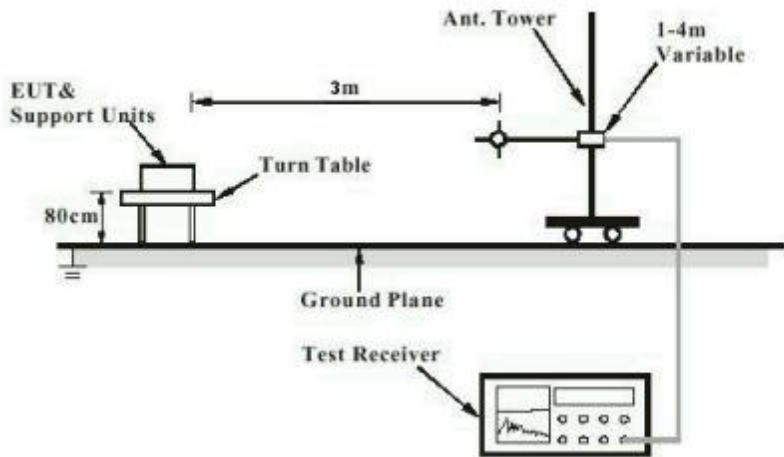

Diagram of Measurement Configuration for Radiation Test (Above 1GHz)

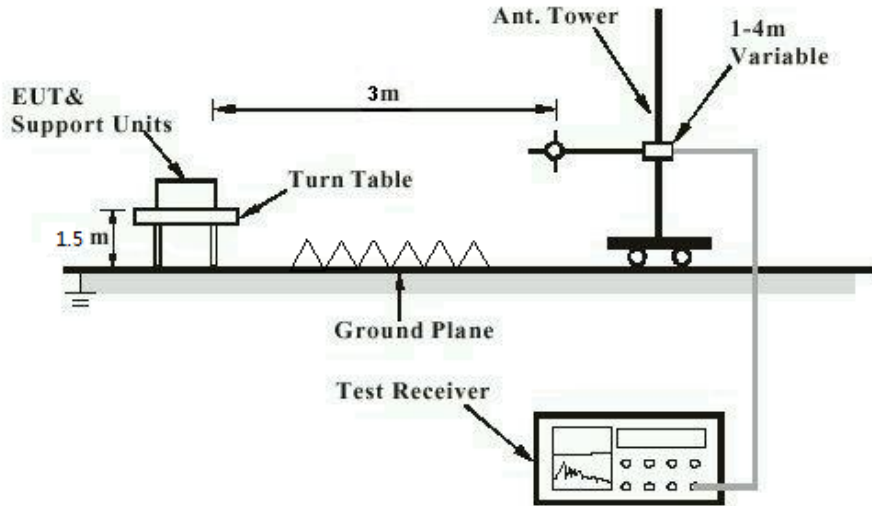

Diagram of Measurement Configuration for Mains Conduction Measurement

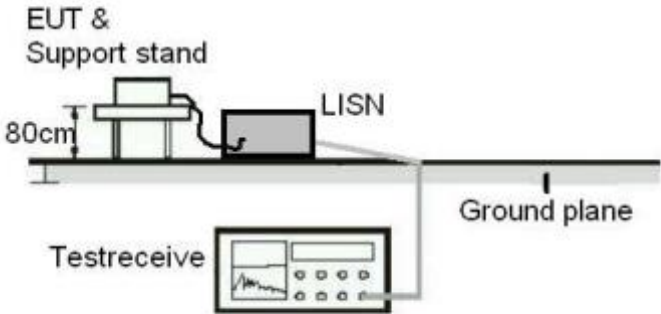
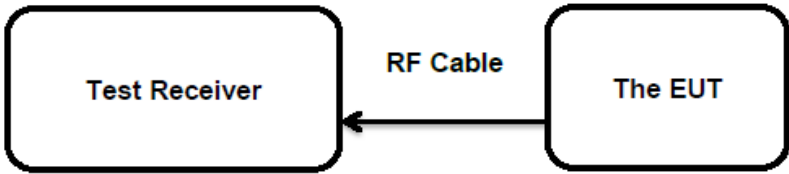

Diagram of Measurement Configuration for Conducted Transmitter Measurement



5 Test Results

5.1 Transmitter Requirement & Test Suites

5.1.1 Antenna Requirement

RESULT:**Pass****Test Specification**

Test standard : FCC Part 15.247(b)(4) and Part 15.203
RSS-Gen Clause 6.8

According to the manufacturer declared, the EUT has a external antenna, the maximum directional gain of antenna is 8dBi, and the antenna connector is designed with permanent attachment and no consideration of replacement. Therefore the EUT is considered sufficient to comply with the provision.

Refer to EUT Photo for further details.

5.1.2 Maximum Conducted Output Power

RESULT:
Pass
Test Specification

Test standard	: FCC Part 15.247(b)(2)&(3) RSS-247 Clause 5.4(a)&(d)
Basic standard	: ANSI C63.10: 2013
Limits	: < 1.0 W (30 dBm) for antenna gain less than 6dBi < 0.631 W (28 dBm) for antenna gain more than 6dBi
Kind of test site	: Shielded Room

Test Setup

Date of testing	: 2021-09-17 - 2021-09-20
Input voltage	: DC 3.3V
Operation mode	: A, B
Test channel	: Low / Middle / High
Ambient temperature	: 25 °C
Relative humidity	: 56 %
Atmospheric pressure	: 101 kPa

For Antenna Gain less than 6dBi

Table 6: Test Result of Maximum Conducted Output Power, Lora DTS

Test Mode	Test Channel (MHz)	Measured Conducted Power		Limit	
		(dBm)	(W)		
Lora DTS SF7	923.3	24.69	0.2944	< 1.0 W (30 dBm)	
	925.1	24.67	0.2931		
	927.5	24.05	0.2541		
Lora DTS SF12	923.3	24.59	0.2877		
	925.1	24.69	0.2944		
	927.5	24.12	0.2582		
Max. Measured Value		24.69	0.2944		

Table 7: Test Result of Maximum Conducted Output Power, Lora Hybrid

Test Mode	Test Channel (MHz)	Measured Conducted Power		Limit (W)
		(dBm)	(W)	
Lora Hybrid SF7	903.9	19.49	0.0889	< 1.0 W (30 dBm)
	904.5	19.30	0.0851	
	905.3	19.27	0.0845	
Lora Hybrid SF9	903.9	19.77	0.0948	
	904.5	19.45	0.0881	
	905.3	19.23	0.0838	
Lora Hybrid SF10	903.9	19.54	0.0899	
	904.5	19.41	0.0873	
	905.3	19.32	0.0855	
Max. Measured Value		19.77	0.0948	

Note:

- 1) The cable loss is taken into account in results.
- 2) Maximum Antenna gain(G) : 5.8 dBi,
 Maximum e.i.r.p.=30.49dBm = 0.112W, which is far below the 4 W

For Antenna Gain 8dBi

Table 8: Test Result of Maximum Conducted Output Power, Lora DTS

Test Mode	Test Channel (MHz)	Measured Conducted Power		Limit	
		(dBm)	(W)		
Lora DTS SF7	923.3	22.15	0.1641	< 0.631 W (28 dBm)	
	925.1	22.21	0.1663		
	927.5	22.37	0.1726		
Lora DTS SF12	923.3	22.10	0.1622		
	925.1	22.23	0.1671		
	927.5	22.27	0.1687		
Max. Measured Value		22.37	0.1726		

Table 9: Test Result of Maximum Conducted Output Power, Lora Hybrid

Test Mode	Test Channel (MHz)	Measured Conducted Power		Limit (W)
		(dBm)	(W)	
Lora Hybrid SF7	903.9	17.77	0.0598	< 0.631 W (28 dBm)
	904.5	17.54	0.0568	
	905.3	17.62	0.0578	
Lora Hybrid SF9	903.9	17.83	0.0607	
	904.5	17.69	0.0587	
	905.3	18.44	0.0698	
Lora Hybrid SF10	903.9	17.91	0.0618	
	904.5	17.81	0.0604	
	905.3	17.55	0.0569	
Max. Measured Value		18.44	0.0698	

Note:

- 3) The cable loss is taken into account in results.
- 4) Maximum Antenna gain(G) : 8 dBi,
 Maximum e.i.r.p.=30.37dBm = 0.109W, which is far below the 4 W

5.1.3 Conducted Power Spectral Density

RESULT:
Pass
Test Specification

Test standard : FCC Part 15.247(e), FCC Part 15.247(f)
 RSS-247 Clause 5.2(b), RSS-247 Clause 5.3
 Basic standard : ANSI C63.10: 2013
 Limits : < 8 dBm / 3kHz for antenna gain less than 6dBi
 : < 6 dBm / 3kHz for antenna gain 8dBi
 Kind of test site : Shielded Room

Test Setup

Date of testing : 2021-09-17 - 2021-09-20
 Input voltage : DC 3.3V
 Operation mode : B
 Test channel : Low / Middle / High
 Ambient temperature : 25 °C
 Relative humidity : 56 %
 Atmospheric pressure : 101 kPa

For Antenna Gain less than 6dBi

Table 10: Test Result of Maximum Peak Power Spectral Density, Lora DTS

Test Mode	Test Channel (MHz)	Measured Peak Power Spectral Density (dBm/3KHz)
Lora DTS SF7	923.3	4.817
	925.1	5.126
	927.5	3.676
Lora DTS SF12	923.3	6.156
	925.1	6.057
	927.5	5.684
Maximum Measured Value		6.156

Table 11: Test Result of Maximum Peak Power Spectral Density, Lora Hybrid

Test Mode	Test Channel (MHz)	Measured Peak Power Spectral Density (dBm/3KHz)
Lora Hybrid SF7	903.9	7.400
	904.5	7.469
	905.3	6.965
Lora Hybrid SF9	903.9	6.930
	904.5	7.245
	905.3	6.107
Lora Hybrid SF10	903.9	7.275
	904.5	7.130
	905.3	7.177
Maximum Measured Value		7.469

For Antenna Gain 8dBi

Table 12: Test Result of Maximum Peak Power Spectral Density, Lora DTS

Test Mode	Test Channel (MHz)	Measured Peak Power Spectral Density (dBm/3KHz)
Lora DTS SF7	923.3	2.412
	925.1	2.654
	927.5	2.217
Lora DTS SF12	923.3	4.422
	925.1	3.966
	927.5	4.211
Maximum Measured Value		4.422

Table 13: Test Result of Maximum Peak Power Spectral Density, Lora Hybrid

Test Mode	Test Channel (MHz)	Measured Peak Power Spectral Density (dBm/3KHz)
Lora Hybrid SF7	903.9	5.606
	904.5	5.526
	905.3	5.522
Lora Hybrid SF9	903.9	4.774
	904.5	5.488
	905.3	5.426
Lora Hybrid SF10	903.9	5.408
	904.5	5.686
	905.3	4.941
Maximum Measured Value		5.686

5.1.4 6dB Bandwidth

RESULT:
Pass
Test Specification

Test standard	: FCC Part 15.247(a)(2) RSS-247 Clause 5.2(a)
Basic standard	: ANSI C63.10: 2013
Limits	: At least 500kHz for bandwidth(DTS)
Kind of test site	: Shielded Room

Test Setup

Date of testing	: 2021-09-02
Input voltage	: DC 3.3V
Operation mode	: B
Test channel	: Low / Middle / High
Ambient temperature	: 25 °C
Relative humidity	: 56 %
Atmospheric pressure	: 101 kPa

For the measurement records, refer to the appendix B.

Table 14: Test Result of 6dB Bandwidth, Lora DTS

Test Mode	Test Channel (MHz)	6dB Bandwidth (MHz)	Limit (MHz)	
Lora DTS SF7	923.3	612.2	>500KHz	
	925.1	612.2		
	927.5	616.5		
Lora DTS SF12	923.3	640.4		
	925.1	640.4		
	927.5	636.0		
Minimum Measured Value		640.4		

5.1.5 20dB Bandwidth

RESULT:
Pass
Test Specification

Test standard	: FCC Part 15.247(a)(1) (i) RSS-247 Clause 5.1(a)
Basic standard	: ANSI C63.10: 2013 Not more than 500kHz and
Limits	: < 250KHz for at least 50 hopping frequencies >=250KHz for at least 25 hopping frequencies
Kind of test site	: Shielded Room

Test Setup

Date of testing	: 2021-09-17
Input voltage	: DC 3.3V
Operation mode	: A
Test channel	: Low / Middle / High
Ambient temperature	: 25 °C
Relative humidity	: 56 %
Atmospheric pressure	: 101 kPa

For the measurement records, refer to the appendix B.

Table 15: Test Result of 20dB Bandwidth, Lora Hybrid

Test Mode	Channel Frequency (MHz)	20dB Bandwidth (kHz)	Limit (MHz)
Lora Hybrid SF7	903.9	134.59	<500KHz
	904.5	134.59	
	905.3	134.59	
Lora Hybrid SF9	903.9	135.31	
	904.5	135.31	
	905.3	136.03	
Lora Hybrid SF10	903.9	133.86	
	904.5	133.14	
	905.3	133.86	

5.1.6 99% Bandwidth

RESULT:
Pass
Test Specification

Test standard : RSS-Gen Clause 6.7
 Basic standard : ANSI C63.10: 2013
 Kind of test site : Shielded Room

Test Setup

Date of testing : 2021-06-18 - 2021-06-24
 Input voltage : DC 3.3V
 Operation mode : A, B
 Test channel : Low / Middle / High
 Ambient temperature : 25 °C
 Relative humidity : 56 %
 Atmospheric pressure : 101 kPa

For the measurement records, refer to the appendix B.

Table 16: Test Result of 99% Bandwidth, Lora DTS

Test Mode	Test Channel (MHz)	99% Bandwidth (KHz)	Limit (MHz)	
Lora DTS SF7	923.3	516.64	/	
	925.1	501.45		
	927.5	507.96		
Lora DTS SF12	923.3	501.45		
	925.1	501.45		
	927.5	501.45		
Minimum Measured Value		516.64		

Table 17: Test Result of 99% Bandwidth, Lora Hybrid

Test Mode	Test Channel (MHz)	99% Bandwidth (KHz)	Limit (MHz)
Lora Hybrid SF7	903.9	120.84	/
	904.5	120.84	
	905.3	120.84	
Lora Hybrid SF9	903.9	123.73	
	904.5	123.01	
	905.3	123.73	
Lora Hybrid SF10	903.9	123.01	
	904.5	123.01	
	905.3	123.01	
Minimum Measured Value		125.36	

5.1.7 Conducted Spurious Emissions Measured in 100 kHz Bandwidth

RESULT:**Pass****Test Specification**

Test standard	: FCC Part 15.247(d) RSS-247 Clause 5.5
Basic standard	: ANSI C63.10: 2013
Limits	: 20dB (below that in the 100kHz bandwidth within the band that contains the highest level of the desired power); In addition, radiated emissions which fall in the restricted bands, must also comply with the radiated emission limits specified in 15.209(a)
Kind of test site	: Shielded Room

Test Setup

Date of testing	: Refer to test result
Input voltage	: DC 3.3V
Operation mode	: A, B
Test channel	: Low / Middle / High
Ambient temperature	: 25 °C
Relative humidity	: 56 %
Atmospheric pressure	: 101 kPa

Test results of 100kHz Bandwidth of Frequency Band Edge by Conducted method refer to test plots, and compliance is achieved as well.

For the measurement records, refer to the appendix B.

5.1.8 Radiated Spurious Emission

RESULT:**Pass****Test Specification**

Test standard	: FCC Part 15.247(d) & FCC Part 15.205 RSS-247 Clause 3.3
Basic standard	: ANSI C63.10: 2013
Limits	: Refer to 15.209(a) of FCC part 15.247(d)
Kind of test site	: 3m Semi-anechoic Chamber

Test Setup

Date of testing	: 2021-09-09 to 2021-09-18
Input voltage	: DC 3.3V
Operation mode	: A, B
Test channel	: Low / Middle / High
Ambient temperature	: Refer to test result
Relative humidity	: Refer to test result
Atmospheric pressure	: 101 kPa

Remark:

Testing was carried out within frequency range 9kHz to the tenth harmonics. Only the worst case spurious emissions configuration of the each mode were reported.

For the measurement records, refer to the appendix B.

5.1.9 Carrier Frequency Separation

RESULT:**Pass****Test Specification**

Test standard : FCC Part 15.247(a)(1)
RSS-247 Clause 5.1(b)

Basic standard : ANSI C63.10: 2013

Limits : ≥ 20 dB bandwidth

Kind of test site : Shielded Room

Test Setup

Date of testing : 2021-09-07

Input voltage : DC 3.3V

Operation mode : C

Test channel : Low / Middle / High

Ambient temperature : 25 °C

Relative humidity : 56 %

Atmospheric pressure : 101 kPa

For the measurement records, refer to the appendix B.

Table 18: Test Result of Carrier Frequency Separation

Test Mode	Channel	Channel Frequency (MHz)	Measured Channel Separation (KHz)	Limit (kHz)	Result
Lora Hybrid (FHSS SF7)	Low Channel	903.90010	198.26	≥ 20dB bandwidth	Pass
	Adjacency Channel	904.09836			
	Middle Channel	904.49870	201.16		Pass
	Adjacency Channel	904.69986			
	High Channel	905.10010	201.20		Pass
	Adjacency Channel	905.30130			
Lora Hybrid (FHSS SF9)	Low Channel	903.90010	198.26	≥ 20dB bandwidth	Pass
	Adjacency Channel	904.09836			
	Middle Channel	904.49870	201.16		Pass
	Adjacency Channel	904.69986			
	High Channel	905.10010	201.20		Pass
	Adjacency Channel	905.30130			
Lora Hybrid (FHSS SF10)	Low Channel	903.89870	201.20	≥ 20dB bandwidth	Pass
	Adjacency Channel	904.09990			
	Middle Channel	904.50010	199.71		Pass
	Adjacency Channel	904.69981			
	High Channel	905.10010	201.20		Pass
	Adjacency Channel	905.30130			

Note:

The limit is maximum 20 dB bandwidth: 136.03KHz.

5.1.11 Time of Occupancy

RESULT:
Pass
Test Specification

Test standard : FCC part 15.247(f)
 : RSS-247 Clause 5.3
 Basic standard : ANSI C63.10: 2013
 Limits : < 0.4s
 Kind of test site : Shielded Room

Test Setup

Date of testing : 2021-09-07
 Input voltage : DC 3.3V
 Operation mode : C
 Test channel : Low / Middle / High
 Ambient temperature : 25 °C
 Relative humidity : 56 %
 Atmospheric pressure : 101 kPa

Table 20: Test result of Channel Occupancy

Test Mode	Period (s)	Channel Occupancy Time (ms)	Limit (ms)
Lora Hybrid (FHSS SF7)	20	29	400
Lora Hybrid (FHSS SF9)	20	115.9	400
Lora Hybrid (FHSS SF10)	20	202.9	400

5.1.12 Conducted Emission on AC Mains

RESULT:**Pass****Test Specification**

Test standard	: FCC Part 15.207(a) & FCC Part 15.107(a) RSS-Gen Clause 8.8 & ICES-003
Basic standard	: ANSI C63.10: 2013 & ANSI C63.4: 2014
Frequency range	: 0.15 – 30MHz
Limits	: FCC Part 15.207(a) & FCC Part 15.107(a) RSS-Gen Table 3 & ICES-003 Table 2
Kind of test site	: Shielded Room

Test Setup

Date of testing	: 2021-09-17
Input voltage	: Powered by PC Adapter
Operation mode	: A, B
Earthing	: Not connected
Ambient temperature	: 22 °C
Relative humidity	: 64 %
Atmospheric pressure	: 101 kPa

For the measurement records, refer to the appendix B.

6 Safety Human Exposure

6.1 Radio Frequency Exposure Compliance

6.1.1 Electromagnetic Fields

RESULT:**Pass****Test Specification**

Test standard : CFR47 FCC Part 2: Section 2.1091
CFR47 FCC Part 1: Section 1.1310
FCC KDB Publication 447498 v06
FCC KDB Publication 865664 D02 v01r02
OET Bulletin 65 (Edition 97-01)
RSS-102 Issue 5 March 2019

This module has six different antennas, and the maximum e.r.i.p. configuration be evaluated as below:

FCC requirement: Systems operating under the provisions of this section shall be operated in a manner that ensures that the public is not exposed to radio frequency energy level in excess limit for maximum permissible exposure. In accordance with 47 CFR FCC Part 2 Subpart J, section 2.1091 this device has been defined as a mobile device whereby a distance of 20cm normally can be maintained between the user and the device.

MPE Calculation Method according to OET Bulletin 65

Power Density: $S_{(mW/cm^2)} = PG/4\pi R^2$ or $EIRP/4\pi R^2$

Where:

S = power density (mW/cm²)

P = power input to the antenna (mW)

G = power gain of the antenna in the direction of interest relative to an isotropic radiator

R = distance to the center of radiation of the antenna (cm)

The worst-case mode (the configuration having highest EIRP) specified:

Lora DTS: 24.69 dBm with 5.8 dBi antenna gain

From the peak RF output power, the minimum mobile separation distance, d=20 cm, the RF power density can be calculated as below:

For Lora DTS: $S_{(mW/cm^2)} = PG/4\pi R^2 = 0.223$ mW/cm²

Limits for Maximum Permissible Exposure (MPE) according to FCC Part 1.1310: 0.6026 mW/cm²

- **IC requirements:** The EUT shall comply with the requirement of RSS-102 section 2.5.2.

Exemption from Routine Evaluation Limits – RF Exposure Evaluation

RF exposure evaluation is required if the separation distance between the user and/or bystander and the device's radiating element is greater than 20 cm, except when the device operates as follows:

at or above 300 MHz and below 6 GHz and the source-based, time-averaged maximum e.i.r.p. of the device is equal to or less than $1.31 \times 10^{-2} f^{0.6834}$ W (adjusted for tune-up tolerance), where f is in MHz;

- RF exposure evaluation exempted power for Lora Hybrid & DTS: 1.37 W

The worst-case mode (the configuration having highest EIRP) specified:

Lora DTS: 24.69 dBm

Antenna Gain: 5.8 dBi

The Max. e.i.r.p. for Lora DTS: 30.49dBm = 1.119 W

Both e.i.r.p. for the Lora FHSS and Lora DTS are less than the RF exposure evaluation exempted power. So RF exposure evaluation is not required.

“RF Radiation Exposure Statement Caution: This Transmitter must be installed to provide a separation distance of at least 20 cm from all persons.”

7 Photographs of the Test Set-Up

For photographs of the test set-up, refer to the appendix A.

8 List of Tables

Table 1: List of Test and Measurement Equipment.....	6
Table 2: Technical Specification of EUT.....	10
Table 3: RF Channel and Frequency of Lora DTS.....	10
Table 4: RF Channel and Frequency of Lora Hybrid.....	10
Table 5: Auxiliary Equipment Used during Test.....	12
Table 6: Test Result of Maximum Conducted Output Power, Lora DTS.....	16
Table 7: Test Result of Maximum Conducted Output Power, Lora Hybrid.....	16
Table 8: Test Result of Maximum Conducted Output Power, Lora DTS.....	17
Table 9: Test Result of Maximum Conducted Output Power, Lora Hybrid.....	17
Table 10: Test Result of Maximum Peak Power Spectral Density, Lora DTS.....	18
Table 11: Test Result of Maximum Peak Power Spectral Density, Lora Hybrid.....	19
Table 12: Test Result of Maximum Peak Power Spectral Density, Lora DTS.....	19
Table 13: Test Result of Maximum Peak Power Spectral Density, Lora Hybrid.....	19
Table 14: Test Result of 6dB Bandwidth, Lora DTS.....	20
Table 15: Test Result of 20dB Bandwidth, Lora Hybrid.....	21
Table 16: Test Result of 99% Bandwidth, Lora DTS.....	22
Table 17: Test Result of 99% Bandwidth, Lora Hybrid.....	22
Table 18: Test Result of Carrier Frequency Separation.....	26
Table 19: Test result of hopping channel number.....	27
Table 20: Test result of Channel Occupancy.....	28

Appendix B: Test Results

APPENDIX B: TEST RESULTS.....	1
APPENDIX B.1: 6dB BANDWIDTH	2
<i>Lora DTS 7</i>	2
<i>Lora DTS 12</i>	3
APPENDIX B.2: 20dB BANDWIDTH	5
<i>Lora Hybrid SF7</i>	5
<i>Lora Hybrid SF9</i>	7
<i>Lora Hybrid SF10</i>	9
APPENDIX B.3: 99% BANDWIDTH	11
<i>Lora DTS SF7</i>	11
<i>Lora DTS SF12</i>	12
<i>Lora Hybrid SF7</i>	14
<i>Lora Hybrid SF9</i>	15
<i>Lora Hybrid SF10</i>	17
APPENDIX B.4: CONDUCTED SPURIOUS EMISSIONS MEASURED IN 100 KHz BANDWIDTH	19
<i>Lora DTS SF7</i>	19
<i>Lora DTS SF12</i>	20
APPENDIX B.5: CARRIER FREQUENCY SEPARATION	22
<i>Lora Hybrid SF7</i>	22
<i>Lora Hybrid SF9</i>	23
<i>Lora Hybrid SF10</i>	25
APPENDIX B.6: NUMBER OF HOPPING FREQUENCY	27
<i>Lora Hybrid SF7</i>	27
<i>Lora Hybrid SF9</i>	27
<i>Lora Hybrid SF10</i>	28
APPENDIX B.7: TEST RESULTS OF RADIATED SPURIOUS EMISSIONS	29
<i>Lora DTS SF7 with 8dBi antenna</i>	29
<i>Lora DTS SF12 with 2.3dBi antenna</i>	35
<i>Lora Hybrid SF7 with 8 dBi antenna</i>	47
APPENDIX B.8: TEST RESULTS OF CONDUCTED EMISSION ON AC MAINS	51

Appendix B.1: 6dB Bandwidth

Lora DTS 7 Low Channel

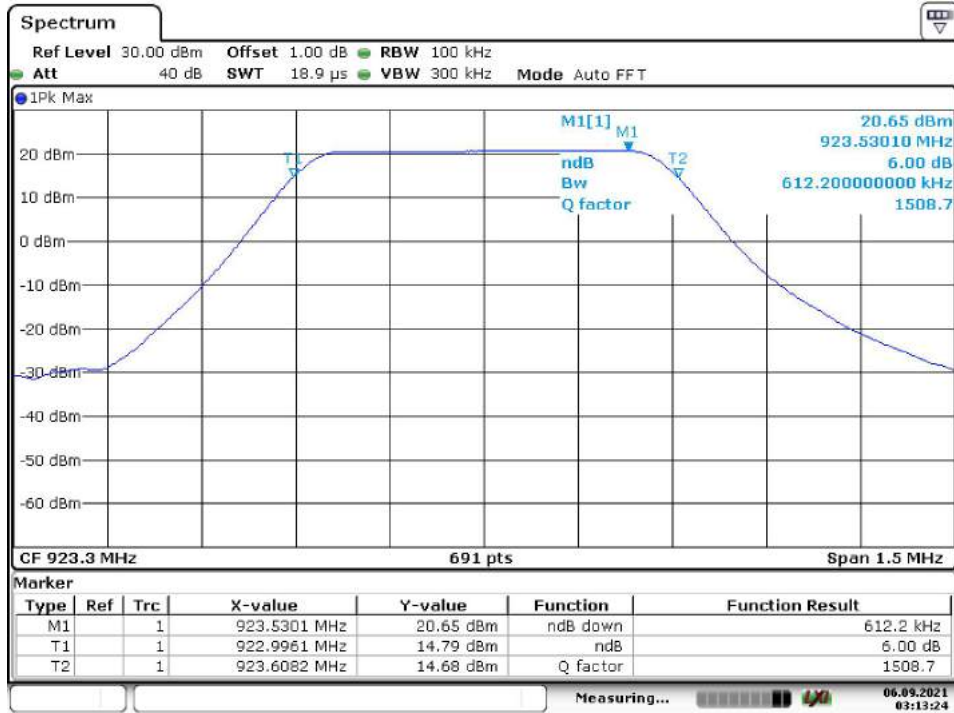

Date: 6.SEP.2021 03:13:24

Middle Channel

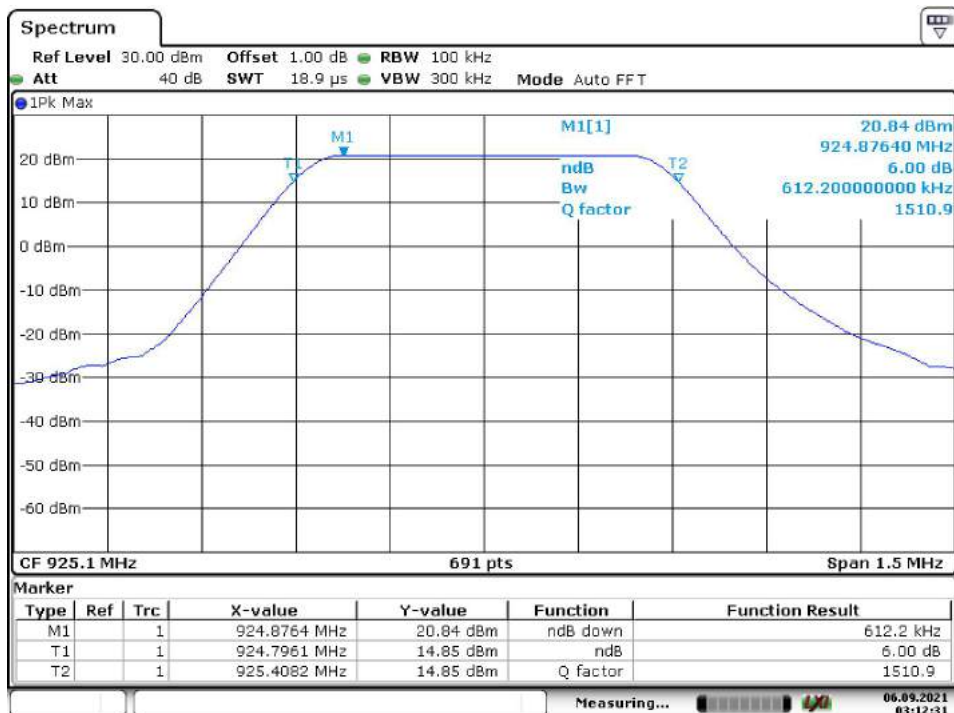

Date: 6.SEP.2021 03:12:32

High Channel

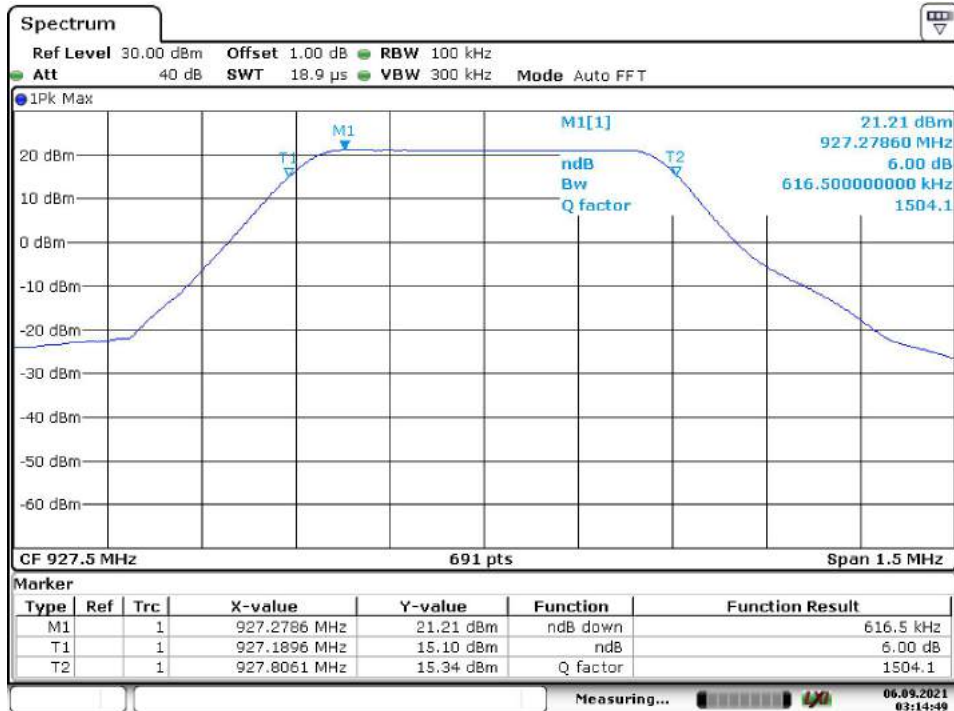

Date: 6.SEP.2021 03:14:49

Lora DTS 12

Low Channel

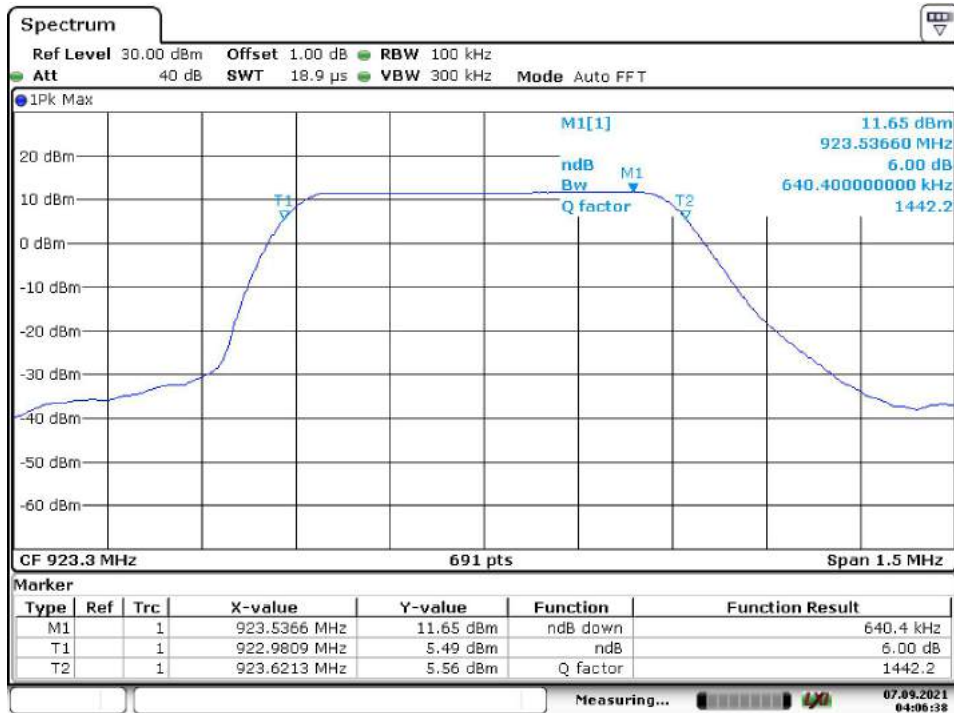

Date: 7.SEP.2021 04:06:38

Middle Channel

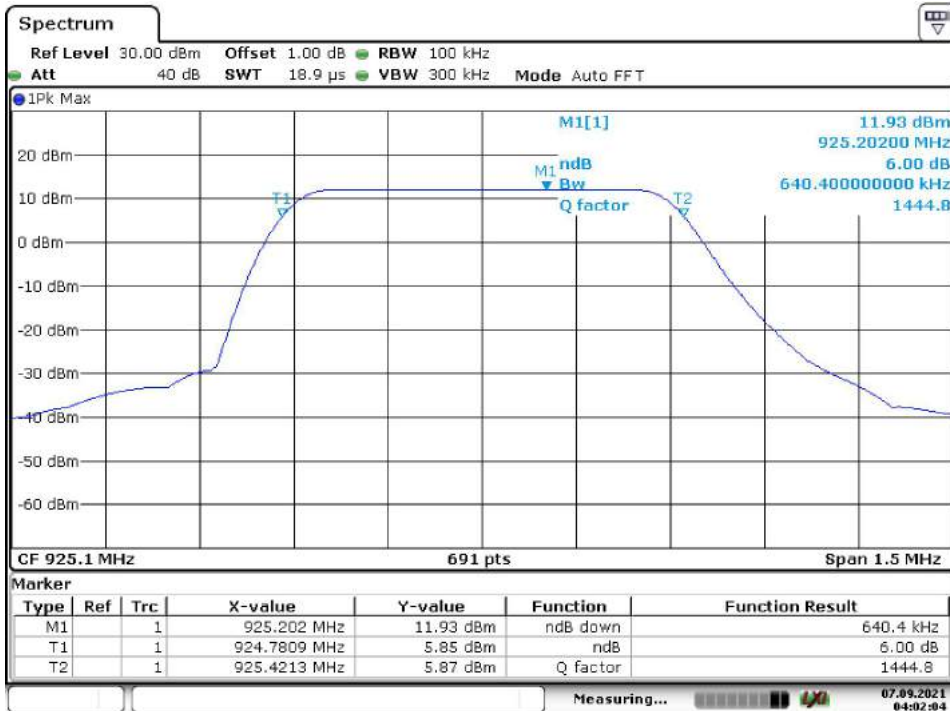

Date: 7.SEP.2021 04:02:04

High Channel

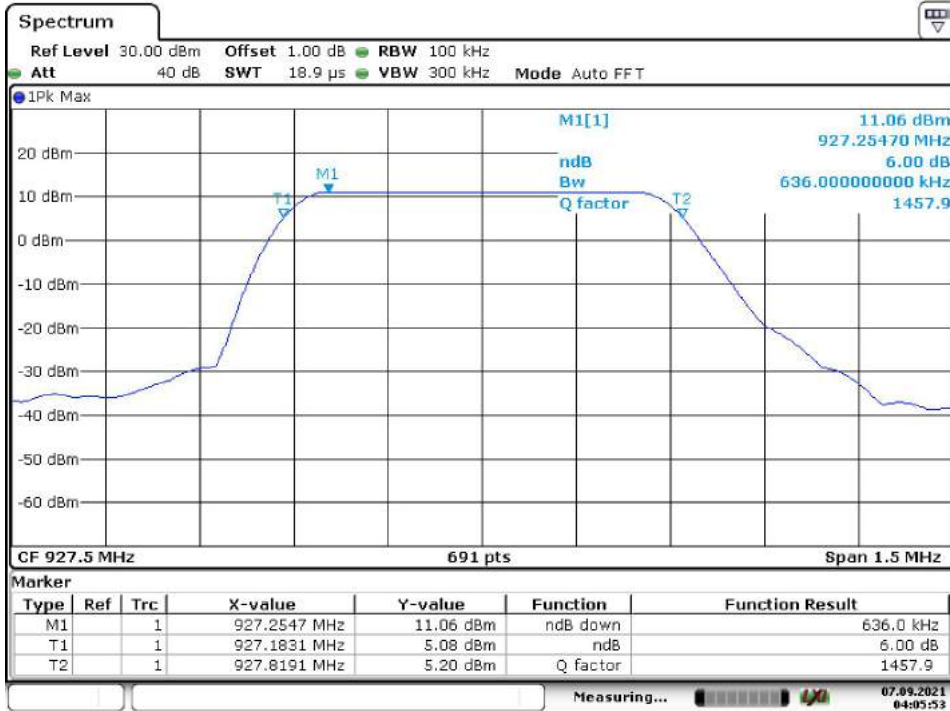

Date: 7.SEP.2021 04:05:53

Appendix B.2: 20dB Bandwidth

Lora Hybrid SF7

Low Channel

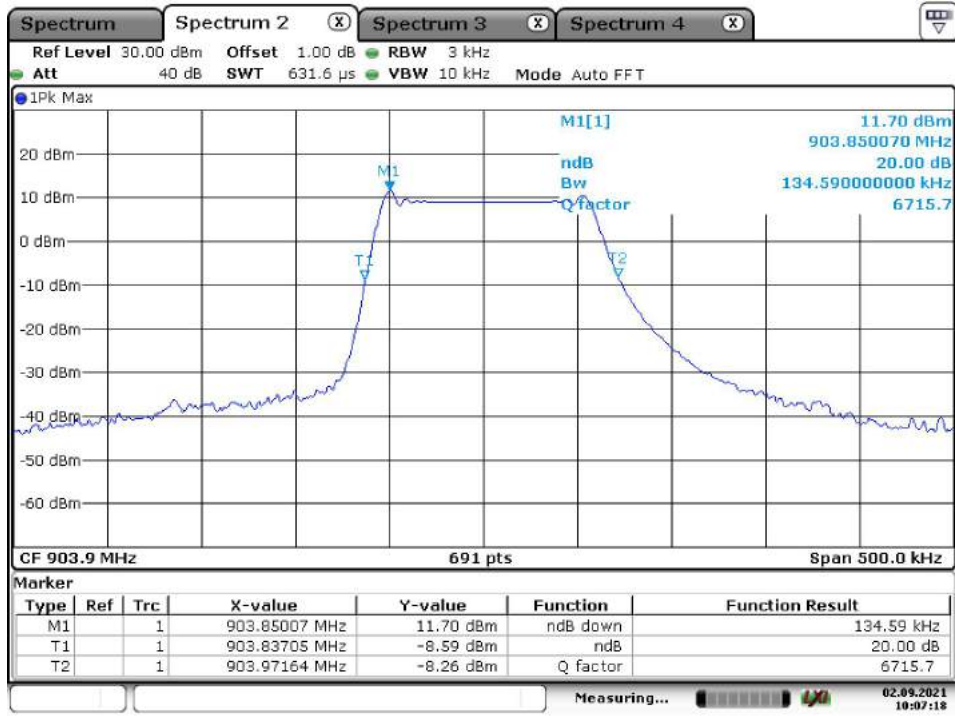

Date: 2.SEP.2021 10:07:19

Middle Channel

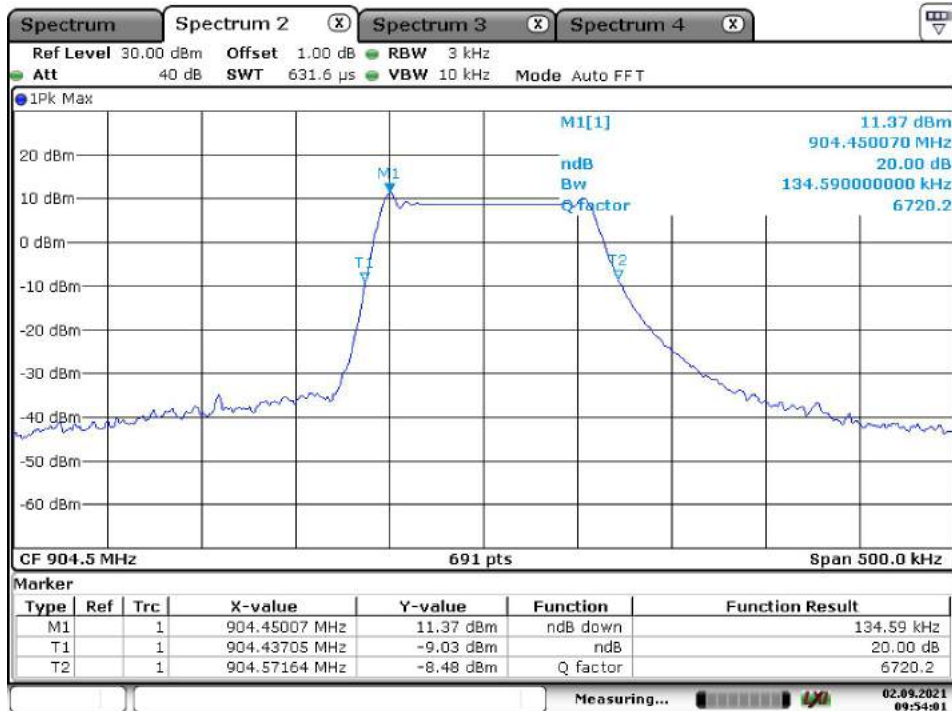

Date: 2.SEP.2021 09:54:01

High Channel

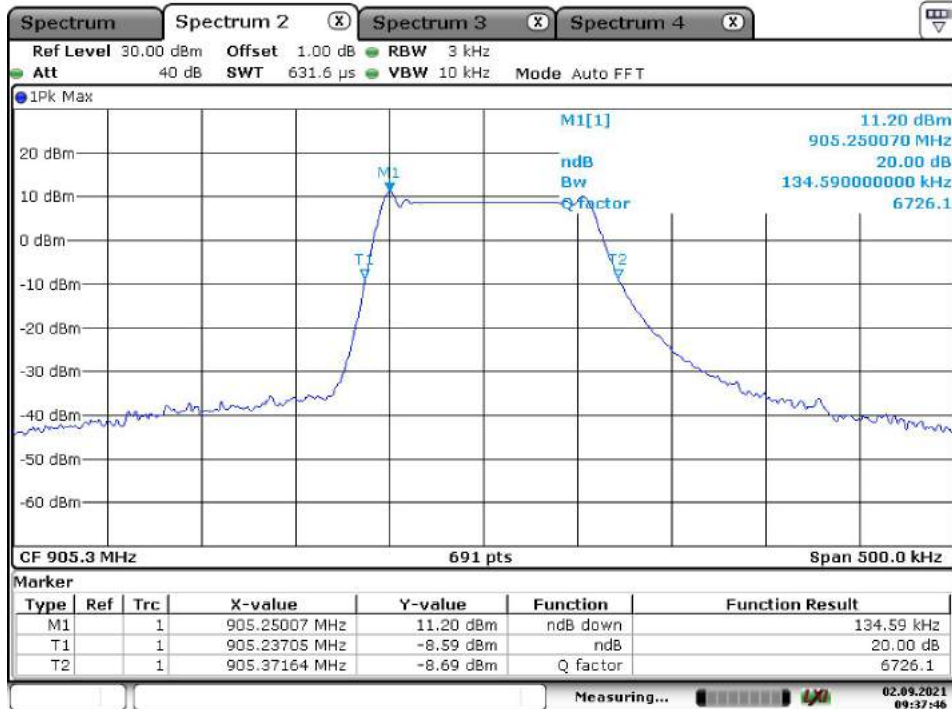

Date: 2.SEP.2021 09:37:46

Lora Hybrid SF9

Low Channel



Date: 16.SEP.2021 05:31:54

Middle Channel



Date: 16.SEP.2021 05:34:01

High Channel



Date: 16.SEP.2021 05:35:06

Lora Hybrid SF10

Low Channel

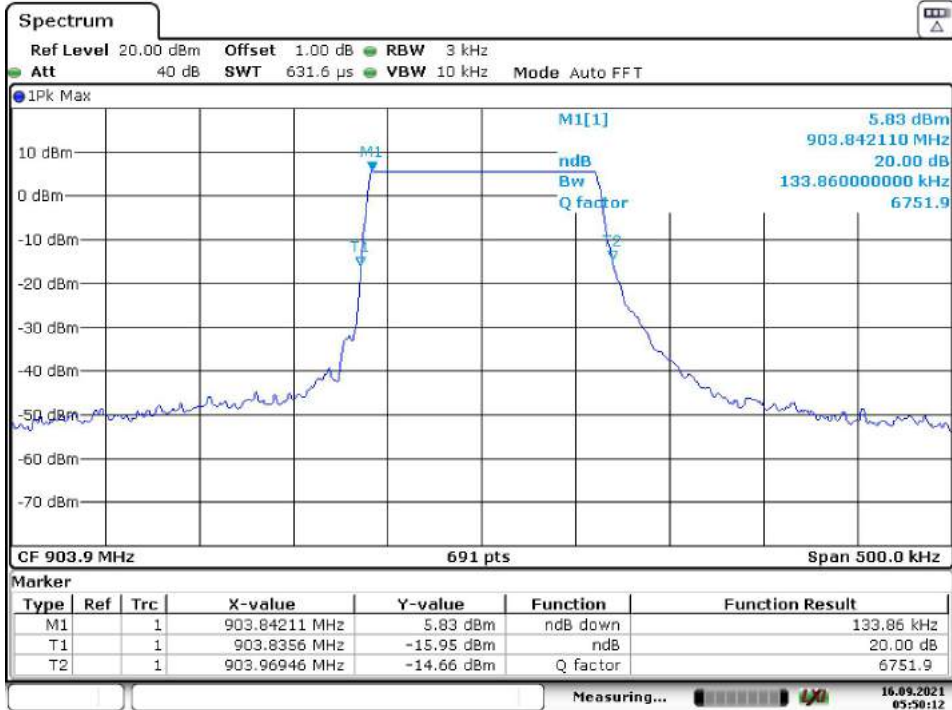

Date: 16.SEP.2021 05:50:13

Middle Channel

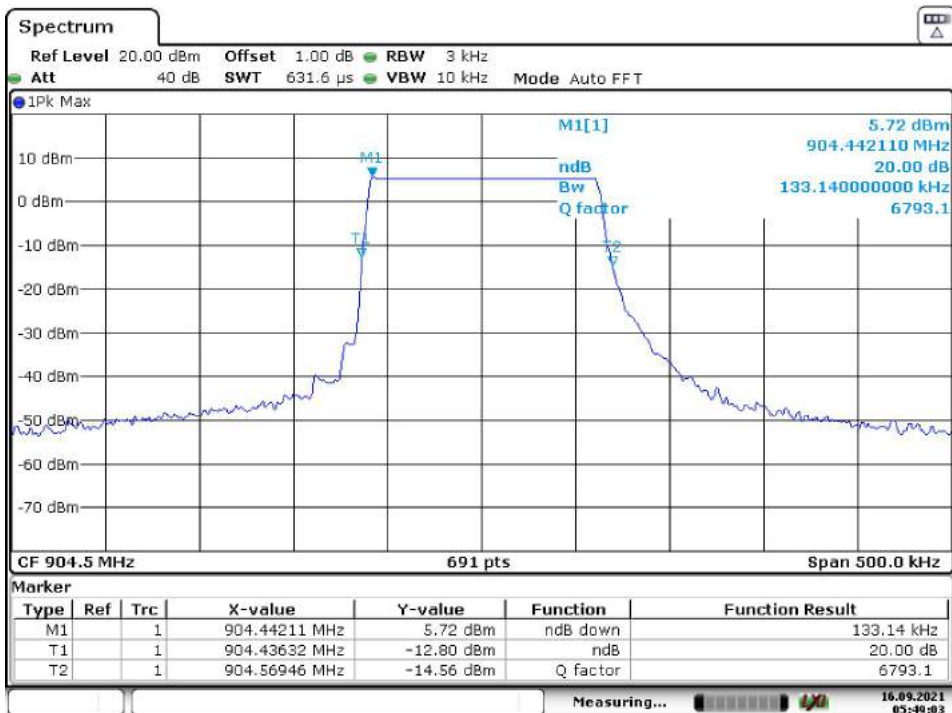

Date: 16.SEP.2021 05:49:03

High Channel

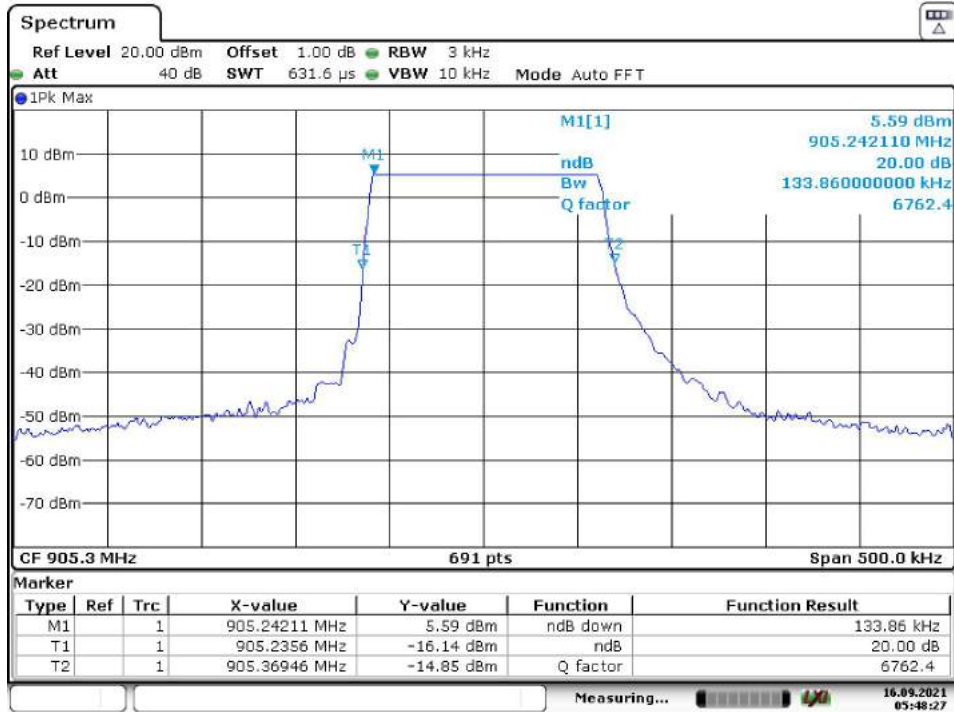

Date: 16.SEP.2021 05:48:28

Appendix B.3: 99% Bandwidth

Lora DTS SF7

Low Channel

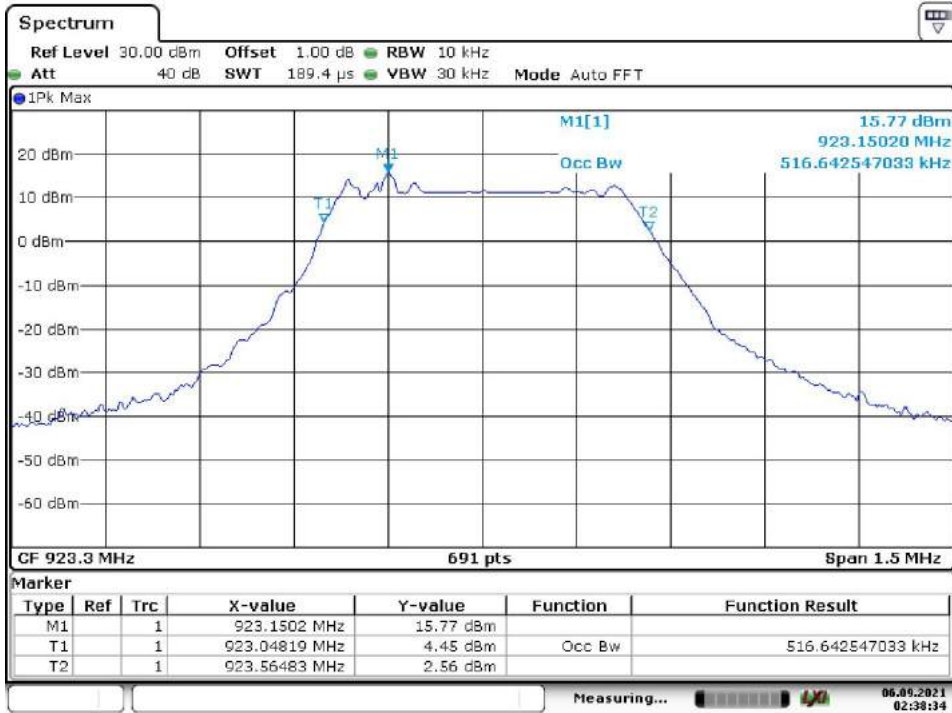

Date: 6.SEP.2021 02:38:34

Middle Channel

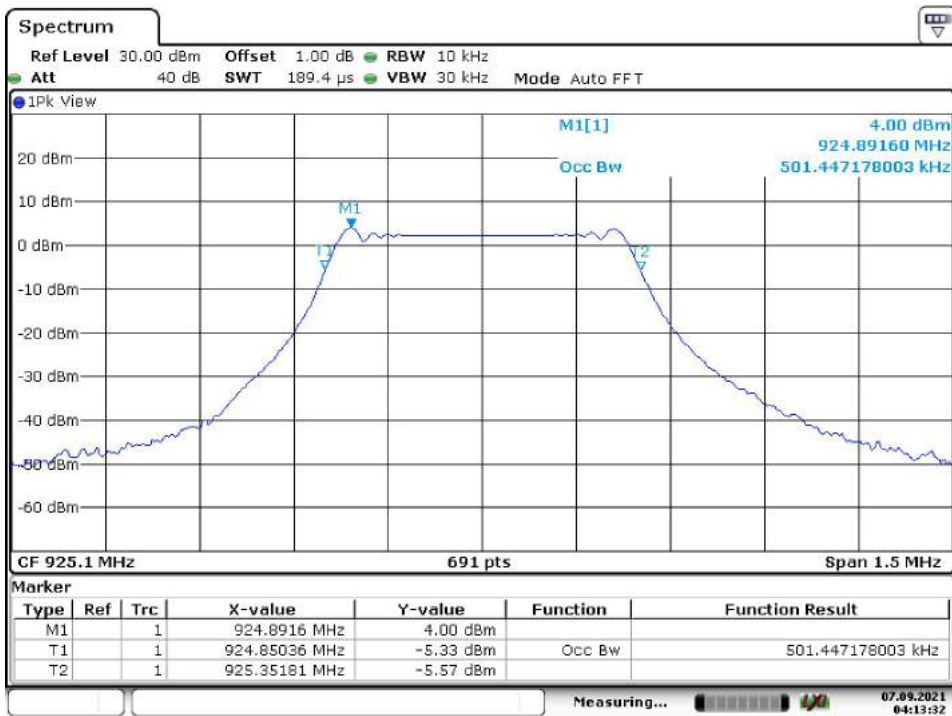

Date: 7.SEP.2021 04:13:32

High Channel

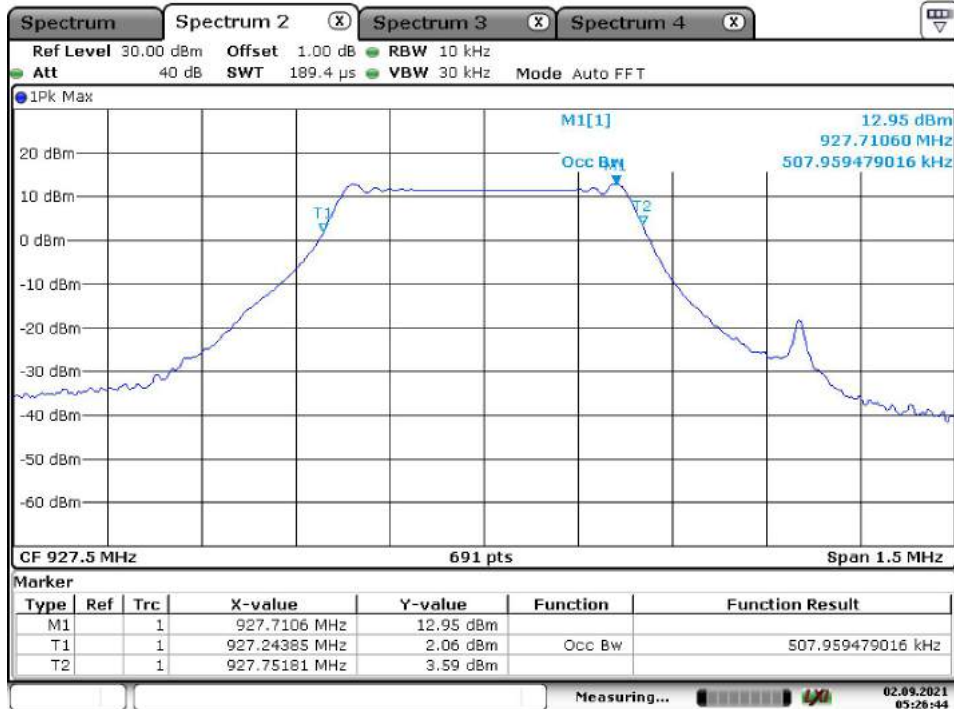

Date: 2.SEP.2021 05:26:45

Lora DTS SF12

Low Channel

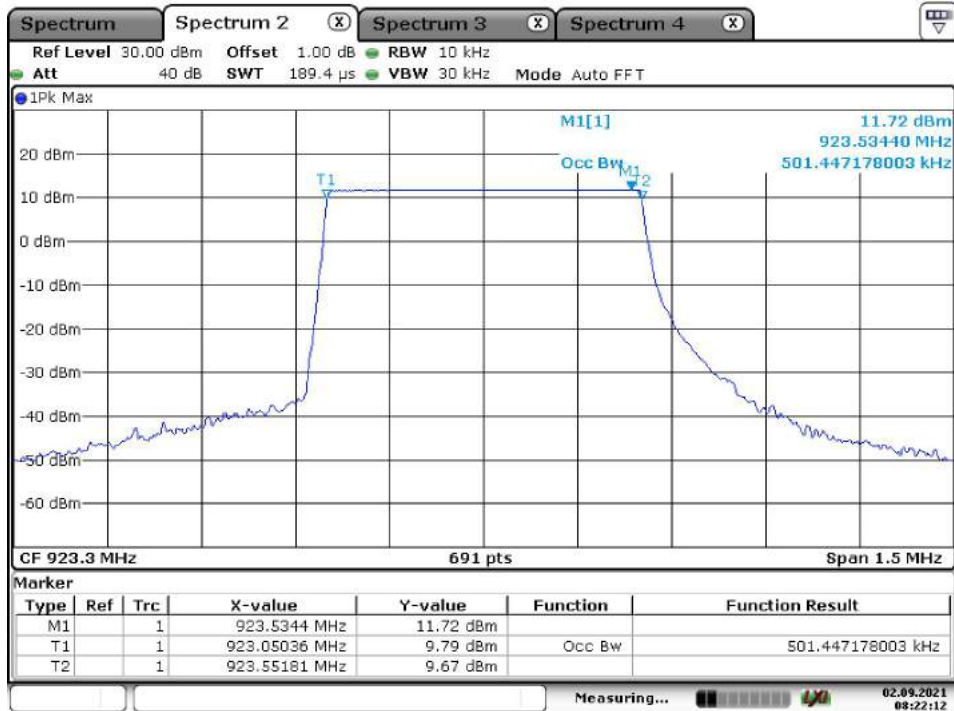

Date: 2.SEP.2021 08:22:12

Middle Channel

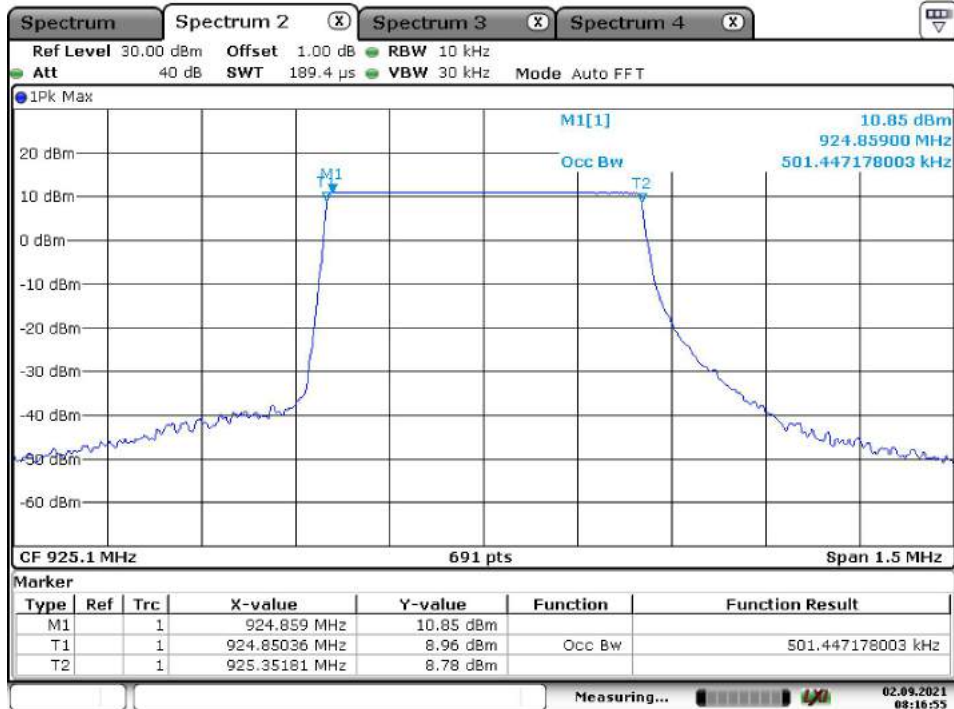

Date: 2.SEP.2021 08:16:55

High Channel

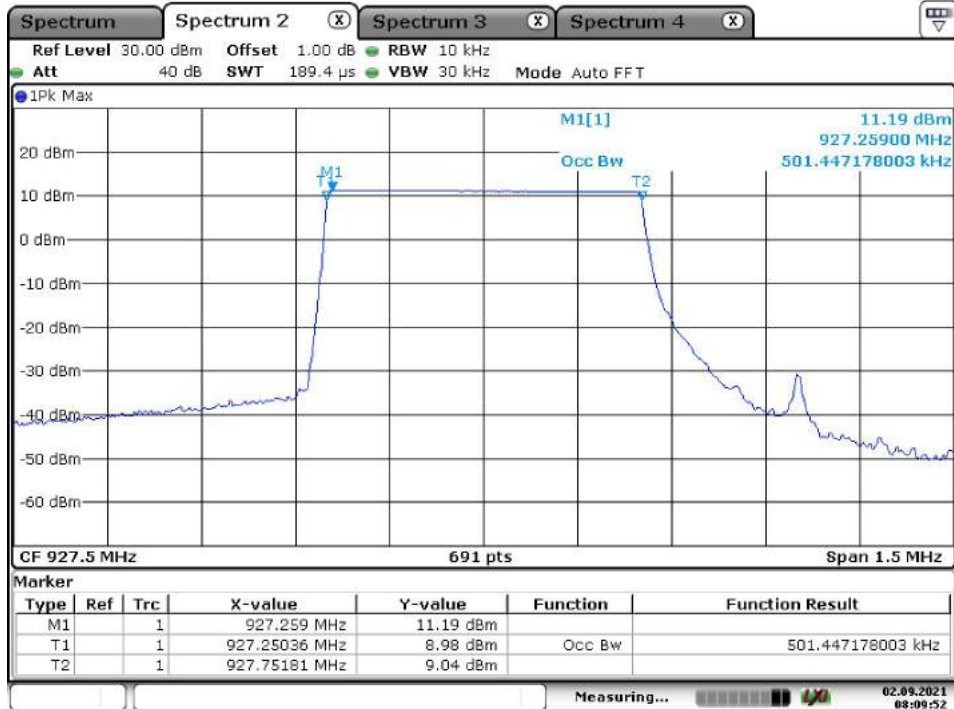

Date: 2.SEP.2021 08:09:52

Lora Hybrid SF7

Low Channel

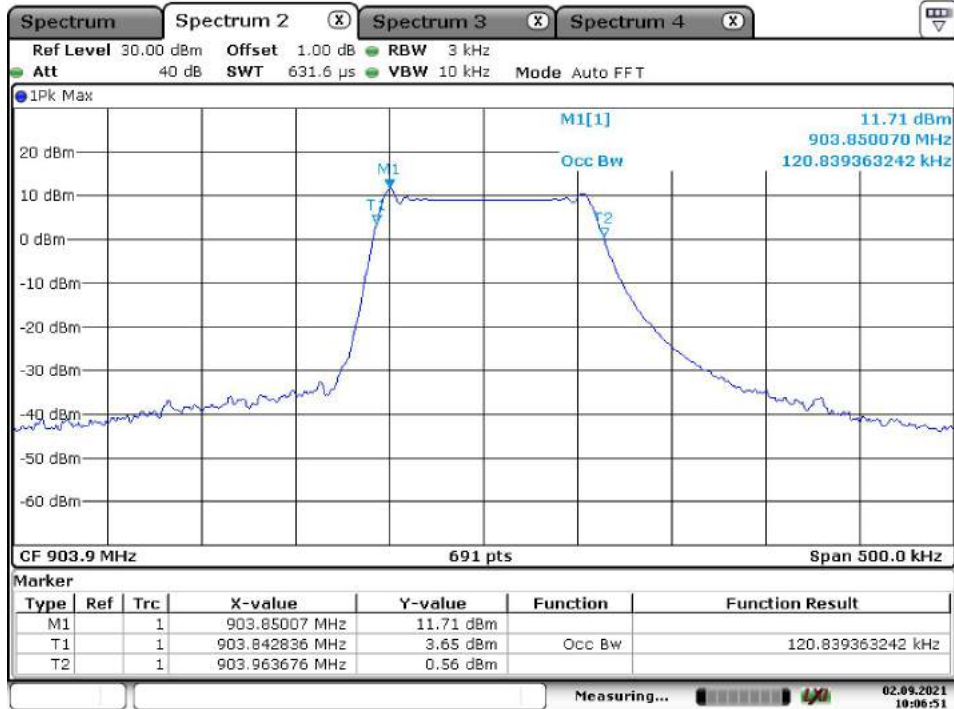

Date: 2.SEP.2021 10:06:51

Middle Channel

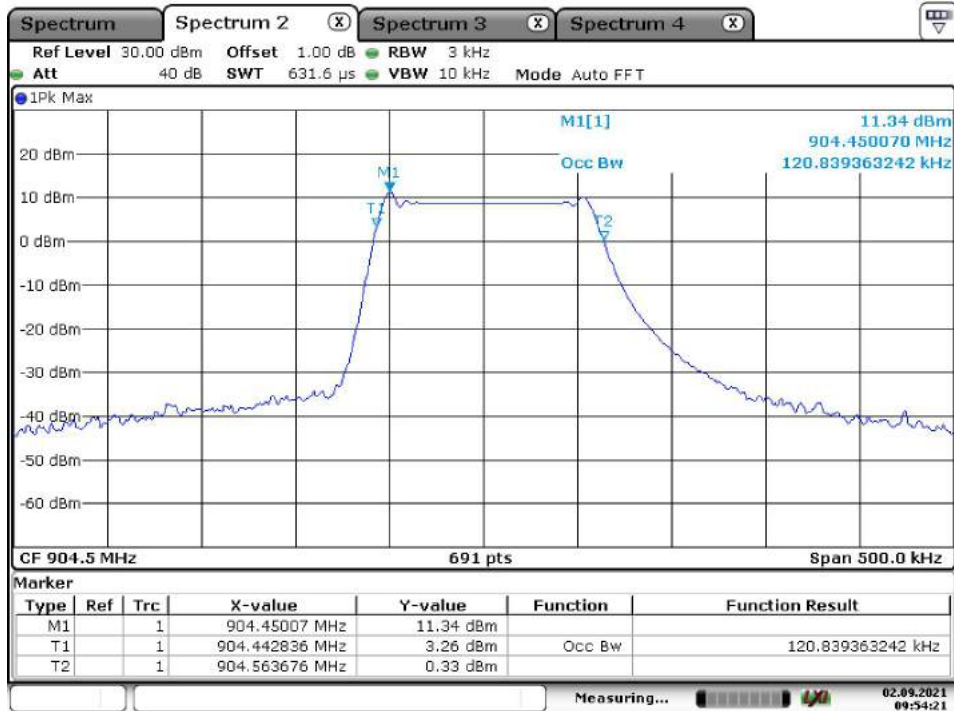

Date: 2.SEP.2021 09:54:22

High Channel

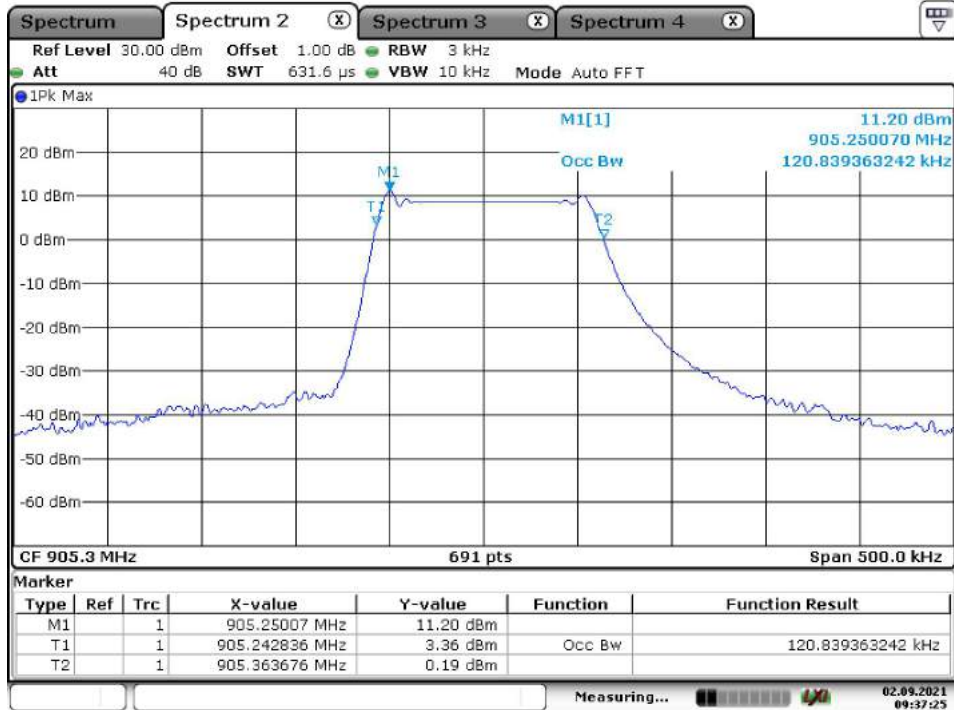

Date: 2.SEP.2021 09:37:26

Lora Hybrid SF9

Low Channel

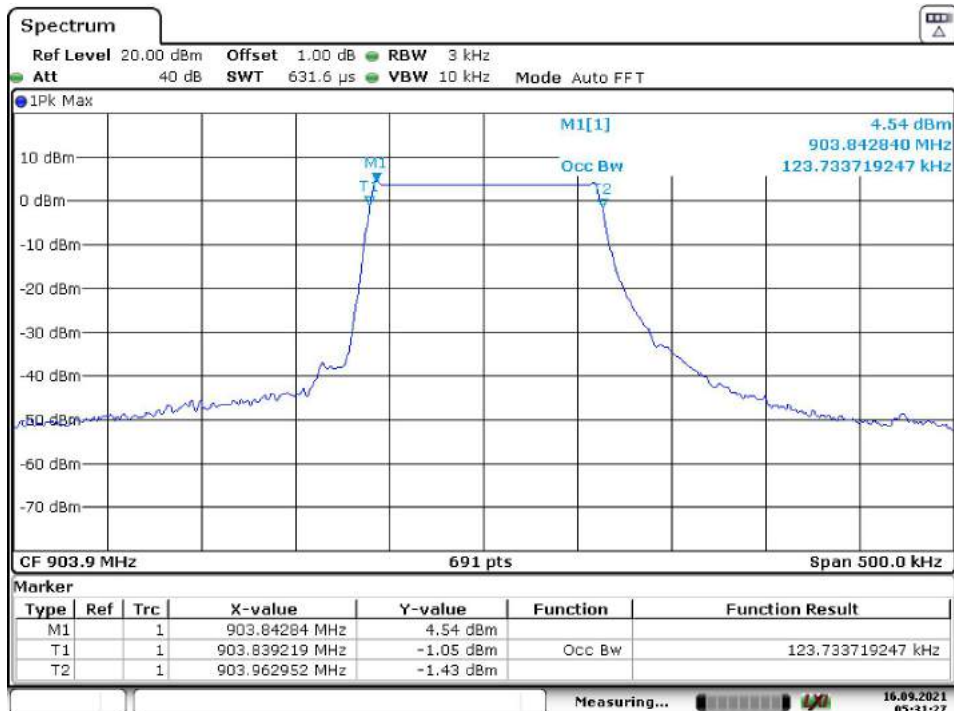

Date: 16.SEP.2021 05:31:26

Middle Channel



Date: 16.SEP.2021 05:34:13

High Channel

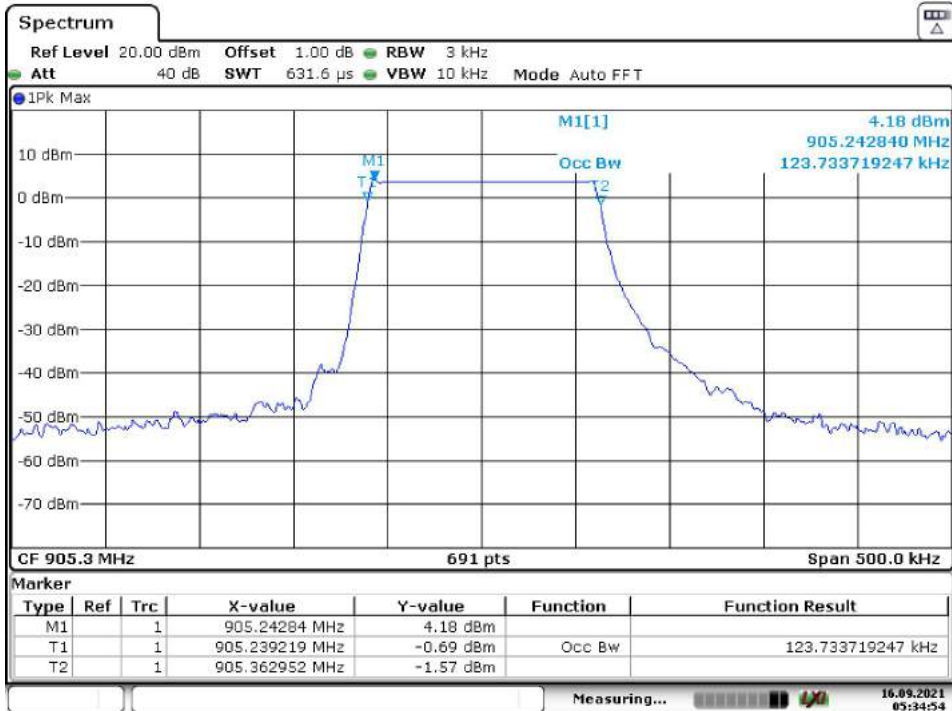

Date: 16.SEP.2021 05:34:54

Lora Hybrid SF10

Low Channel

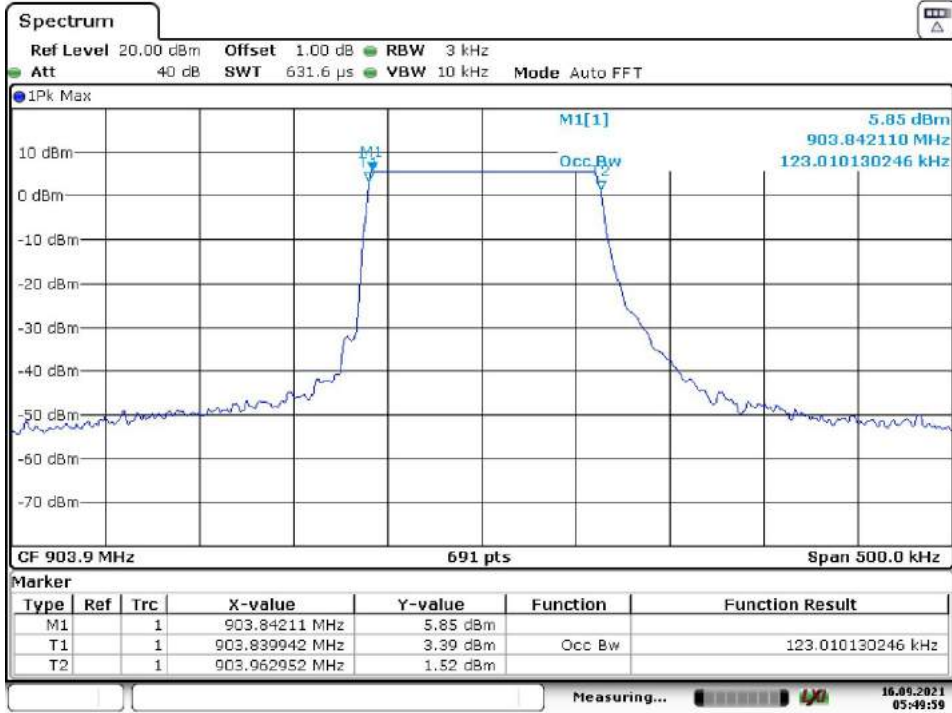

Date: 16.SEP.2021 05:50:00

Middle Channel

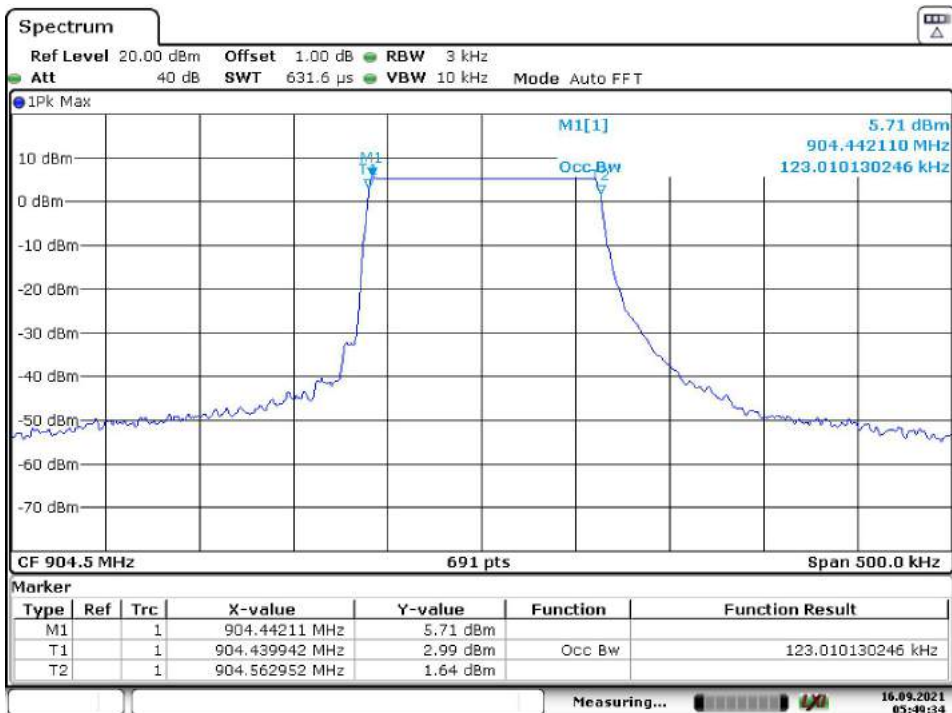

Date: 16.SEP.2021 05:49:35

High Channel

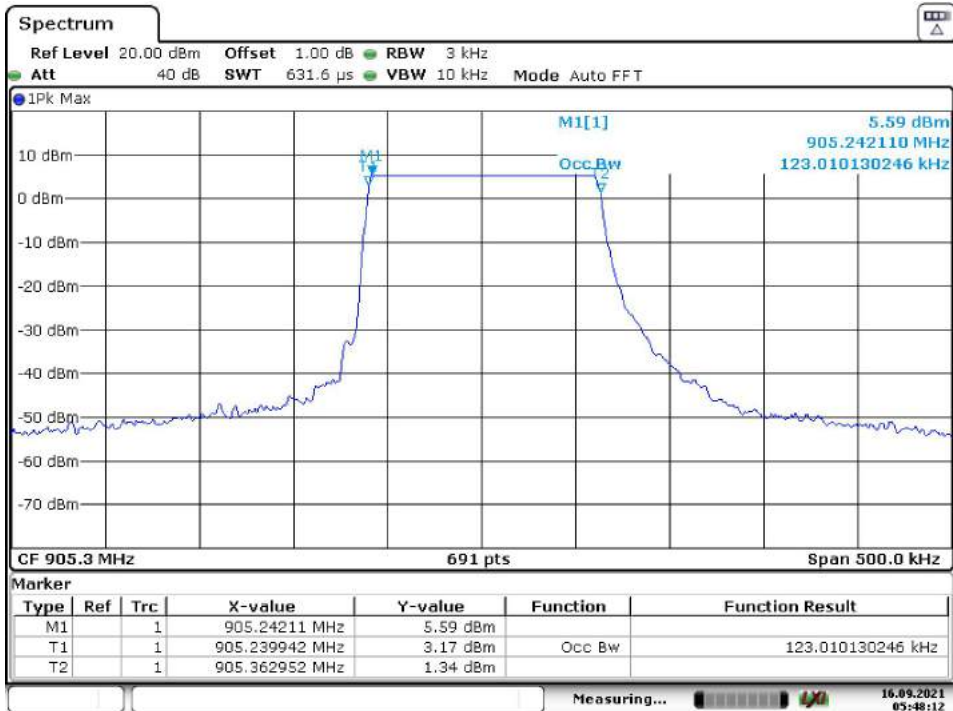

Date: 16.SEP.2021 05:48:13

Appendix B.4: Conducted Spurious Emissions Measured in 100 kHz Bandwidth

Lora DTS SF7

Low Channel

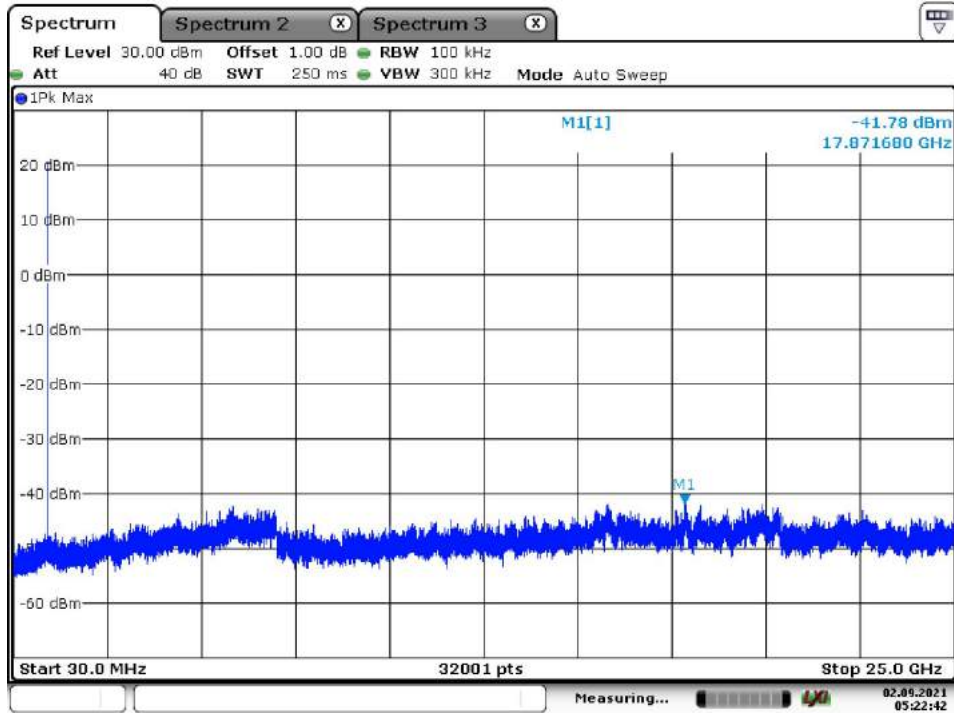

Date: 2.9.2021 05:22:42

Middle Channel

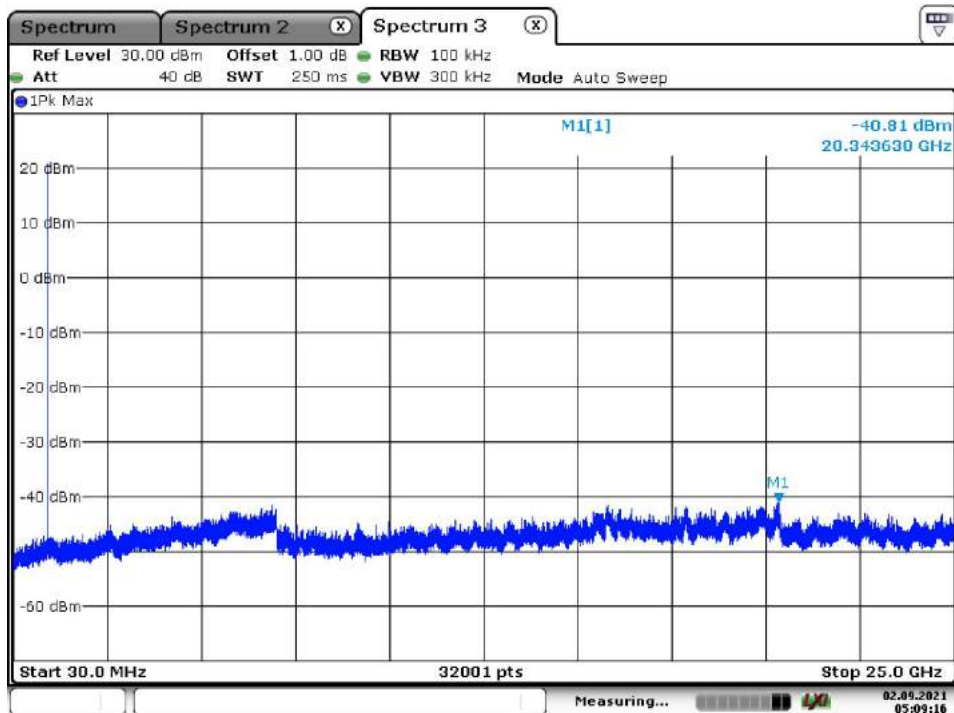

Date: 2.9.2021 05:09:16

High Channel

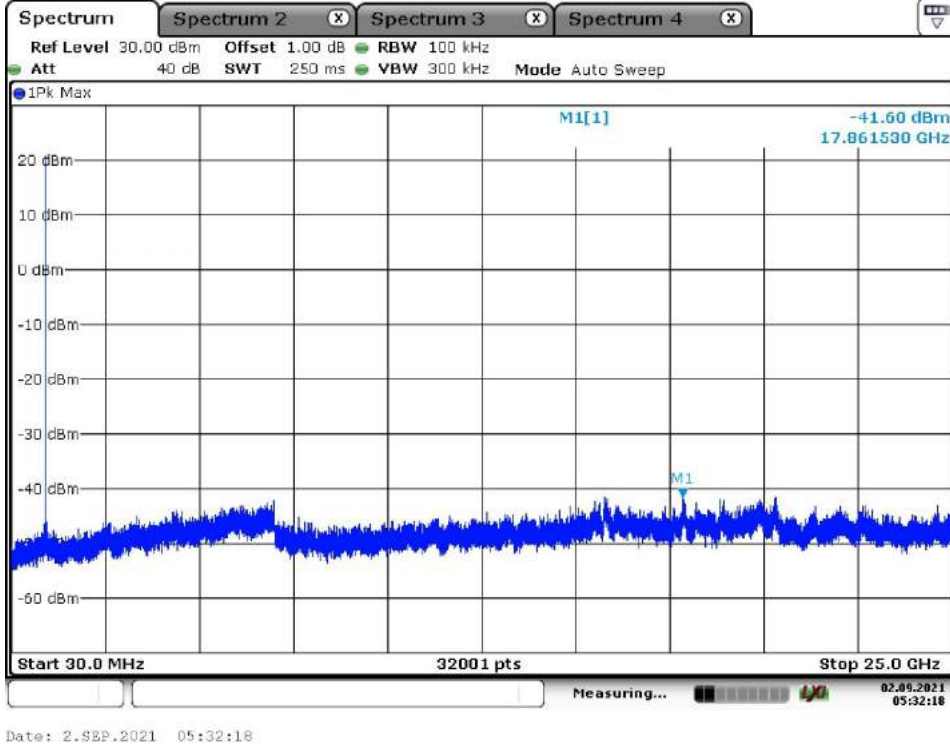

Lora DTS SF12

Low Channel

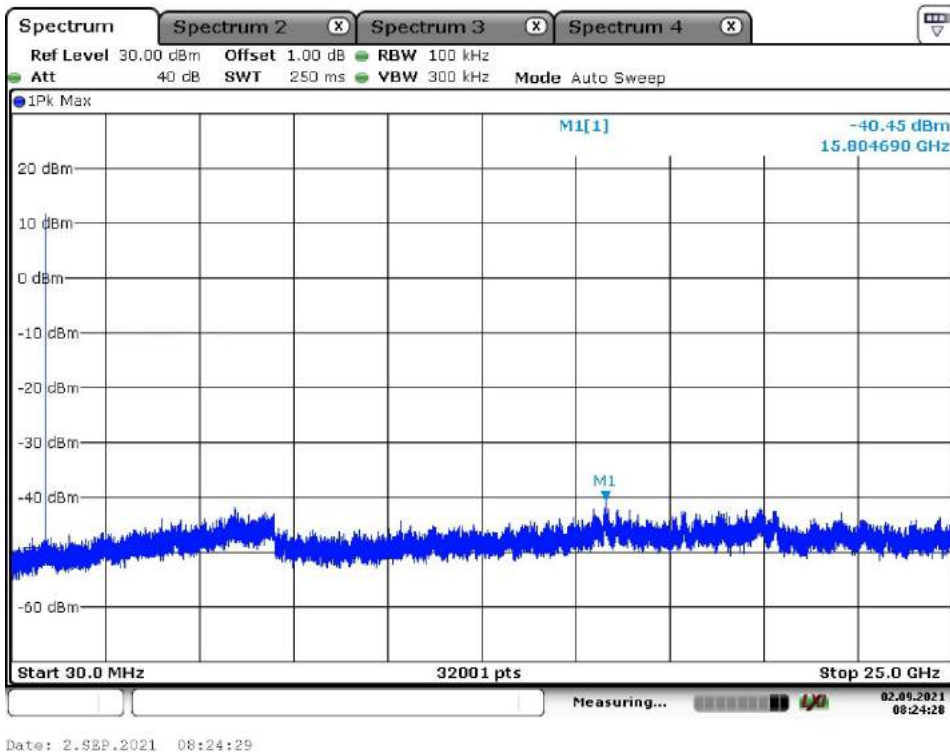

High Channel

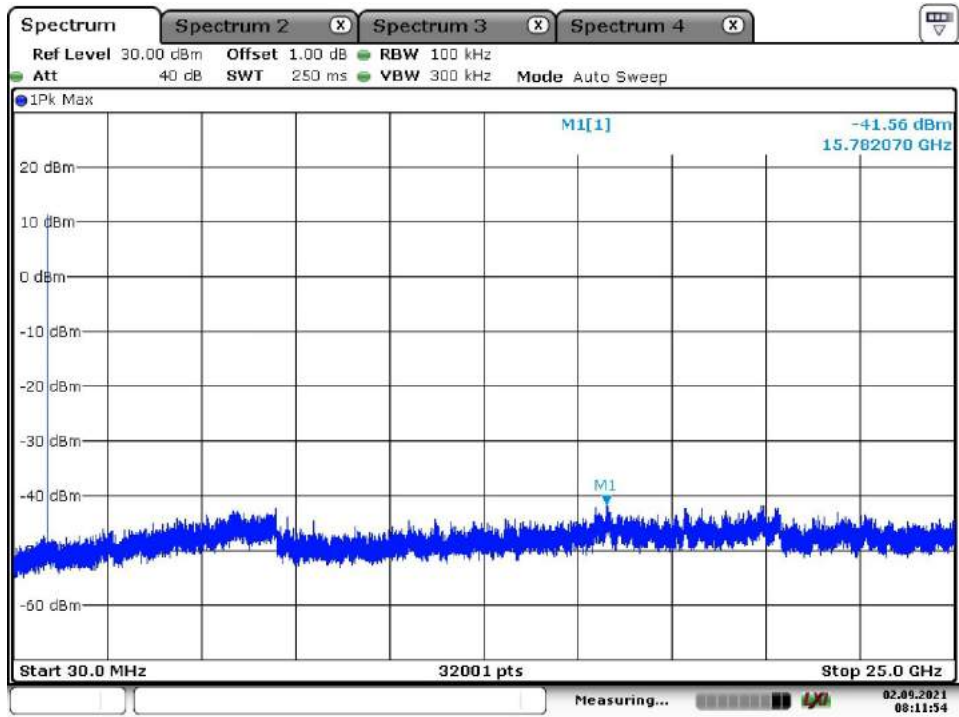
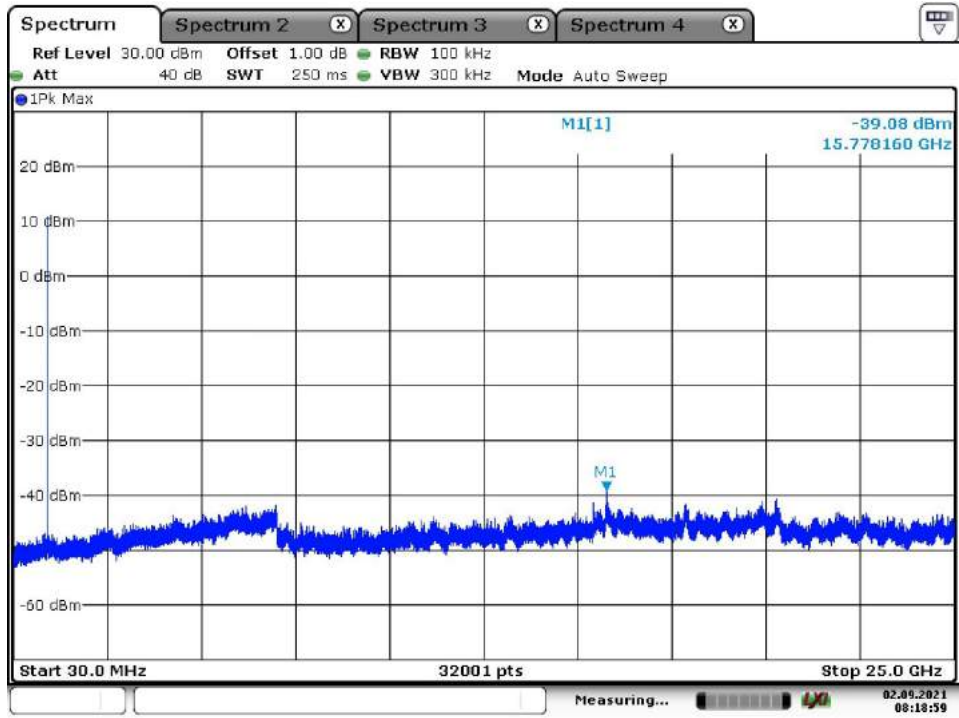

Appendix B.5: Carrier Frequency Separation

Lora Hybrid SF7

Low Channel

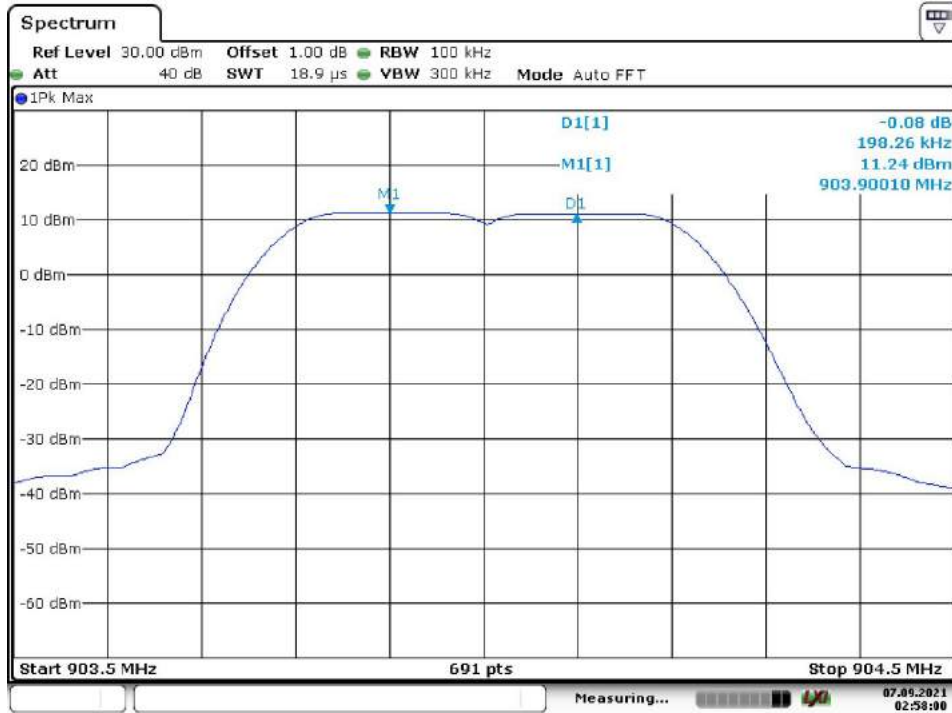

Date: 7.5.2021 02:58:00

Middle Channel

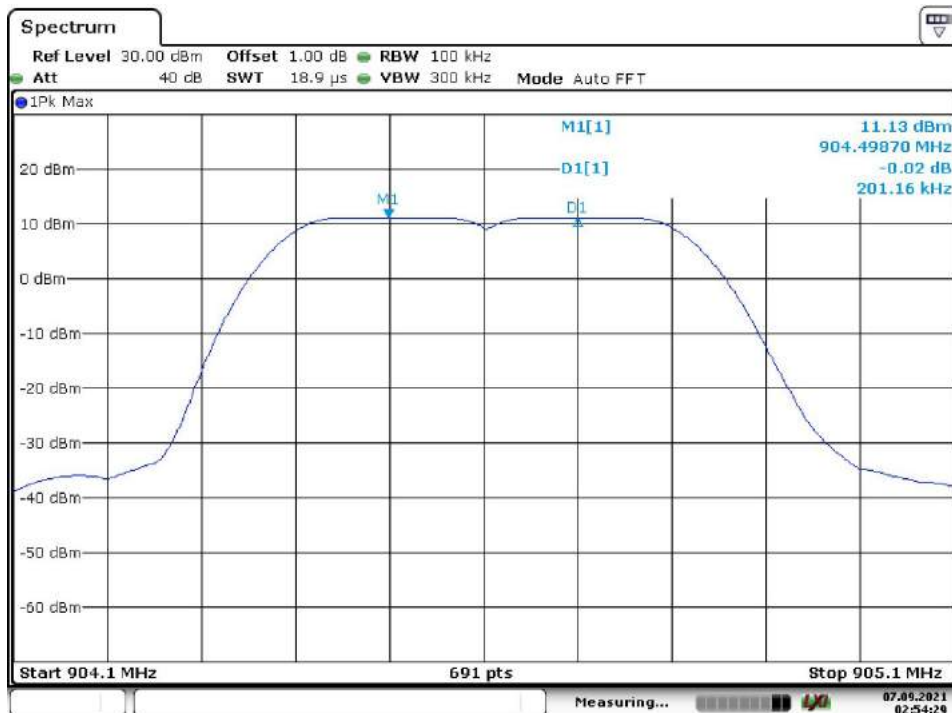

Date: 7.5.2021 02:54:29

High Channel

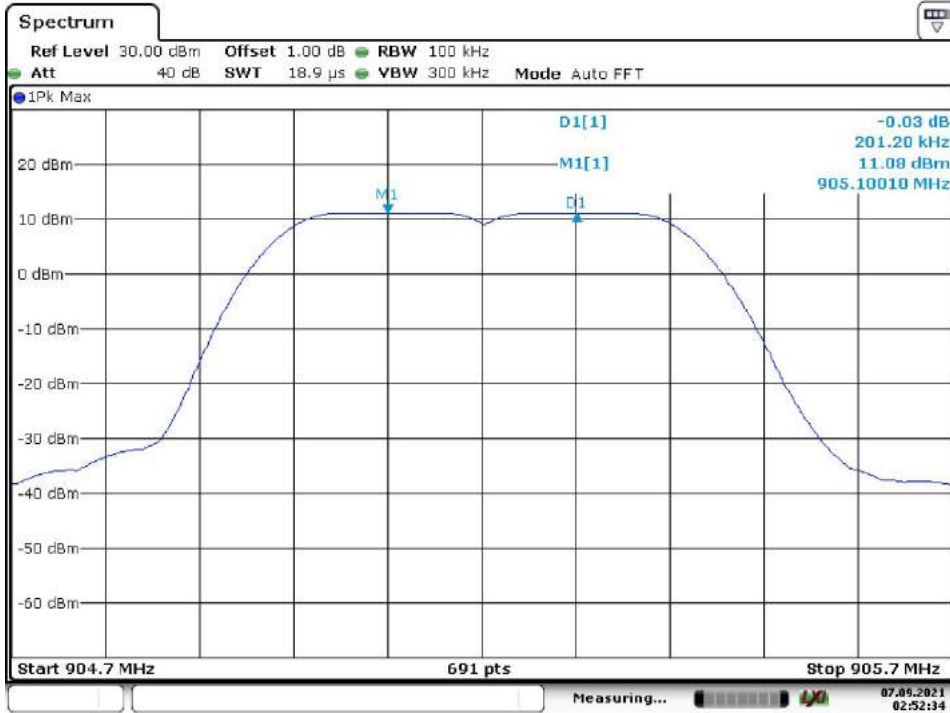

Date: 7.9.2021 02:52:35

Lora Hybrid SF9

Low Channel

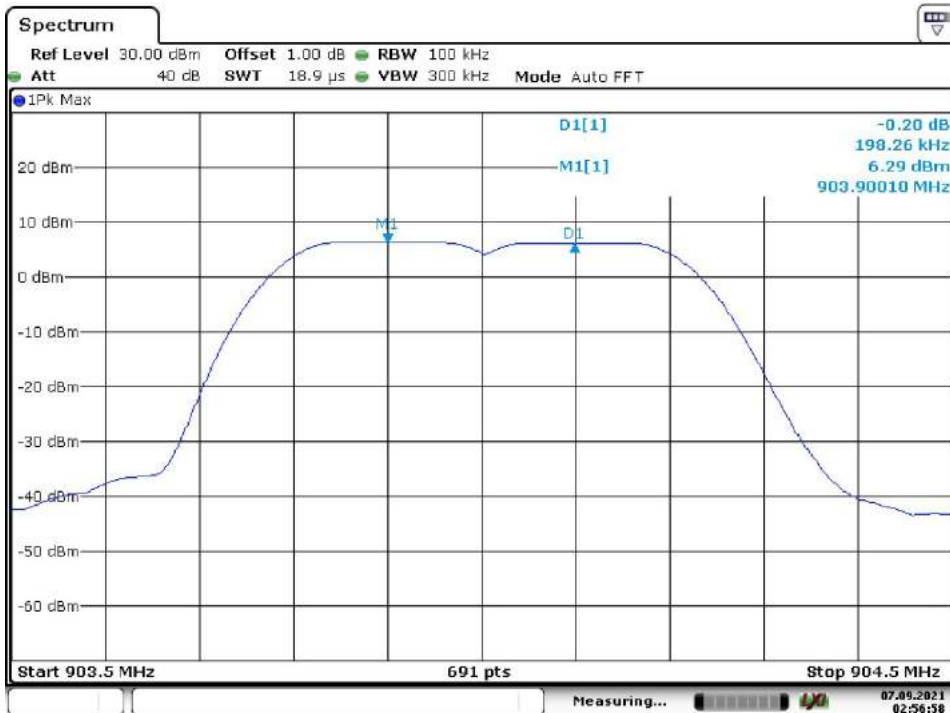

Date: 7.9.2021 02:56:58

Middle Channel



Date: 7.5.2021 02:55:15

High Channel

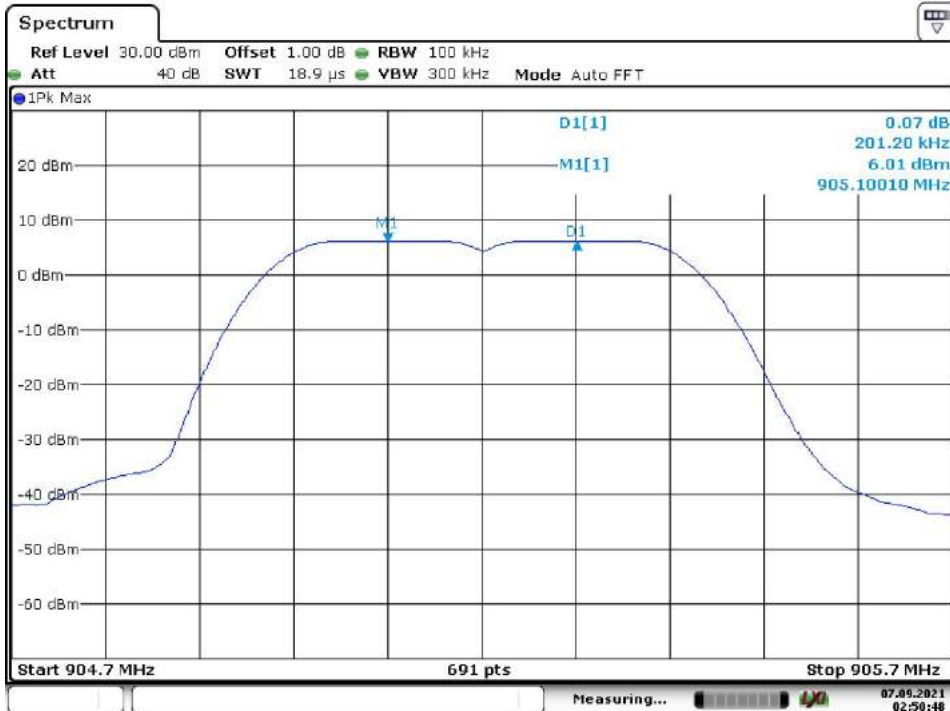

Date: 7.5.2021 02:50:48

Lora Hybrid SF10

Low Channel



Date: 7. SEP. 2021 02:44:20

Middle Channel

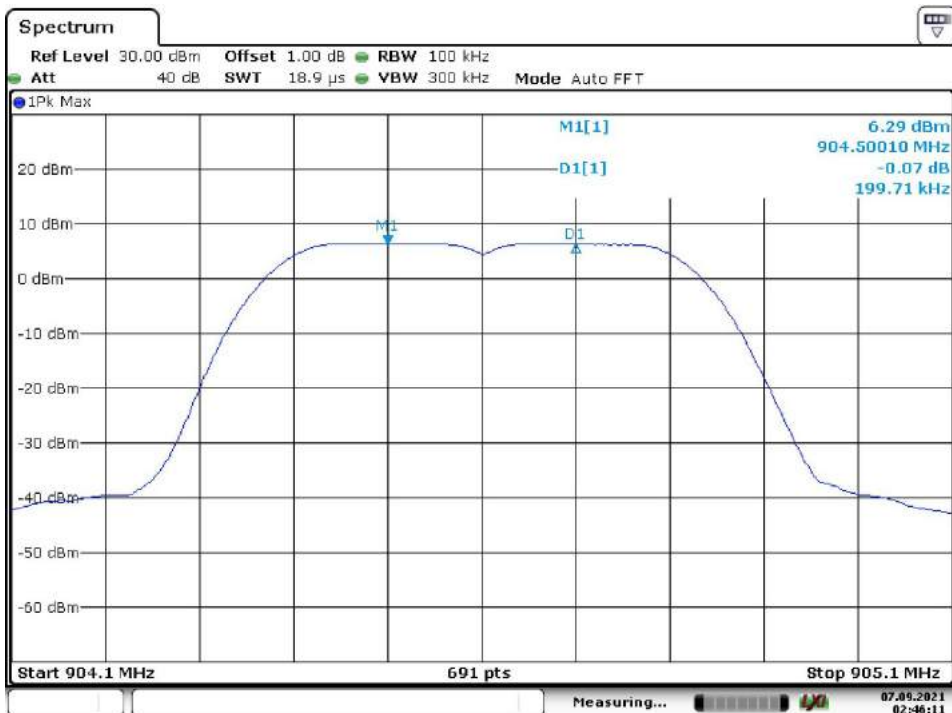

Date: 7. SEP. 2021 02:46:11

High Channel

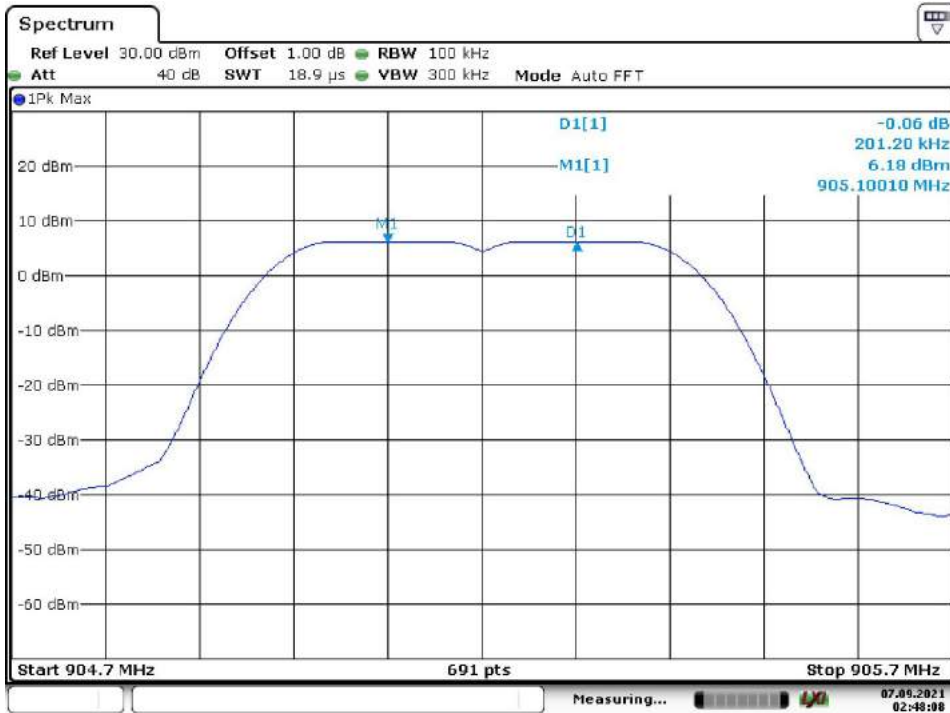

Date: 7.5.2021 02:48:08

Appendix B.6: Number of Hopping Frequency

Lora Hybrid SF7

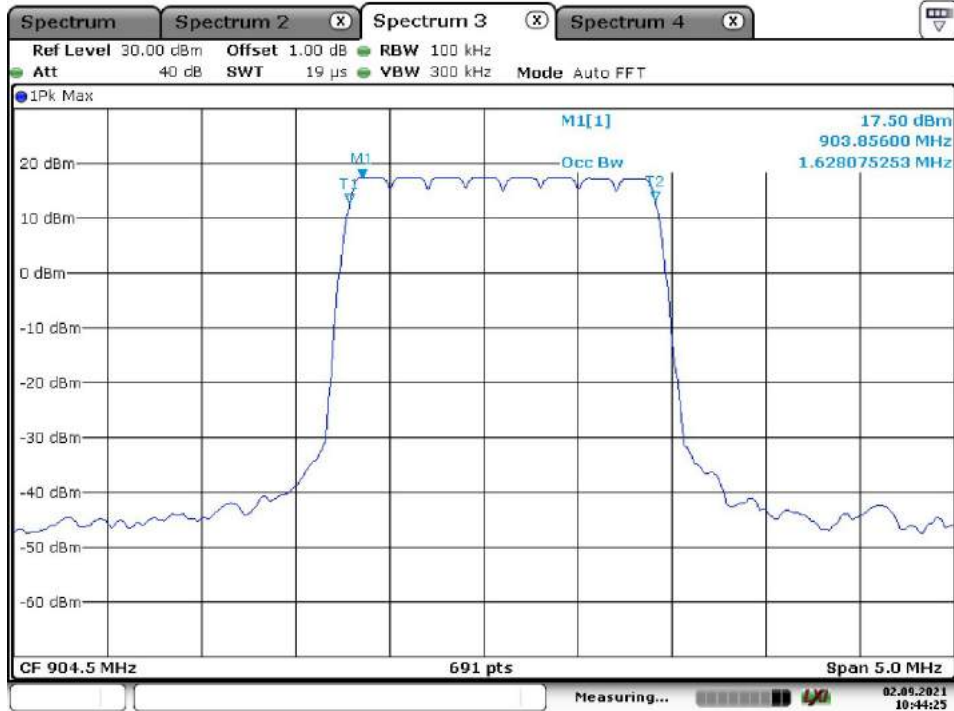

Date: 2.9EP.2021 10:44:26

Lora Hybrid SF9

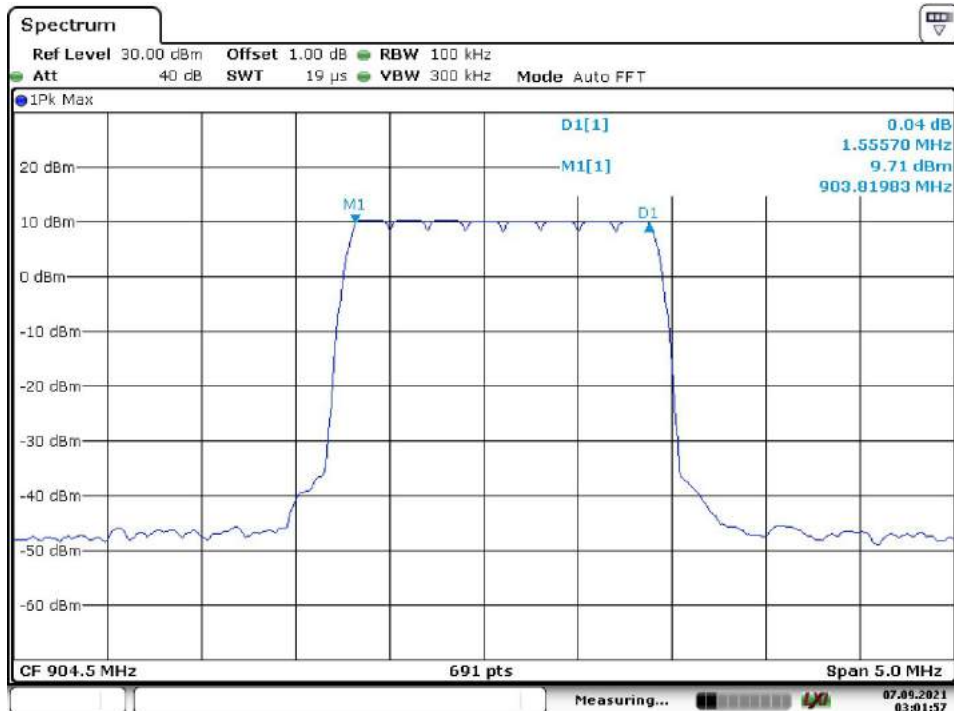

Date: 7.9EP.2021 03:01:57

Lora Hybrid SF10

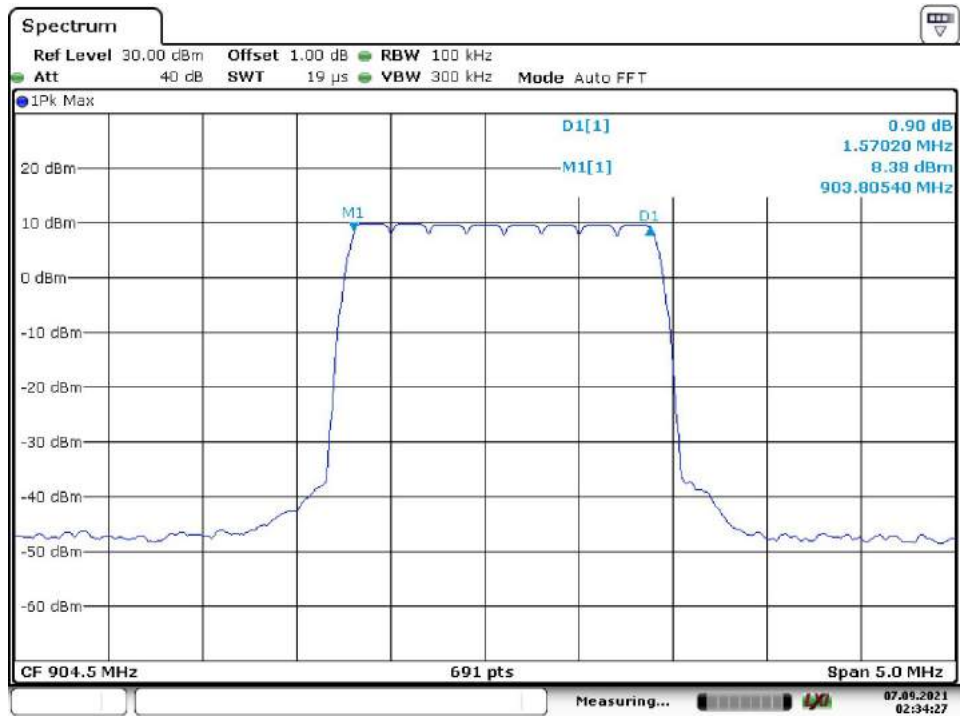

Date: 7.5BP.2021 02:34:27

Note 1: Testing was carried out within frequency range 9 kHz to the tenth harmonics. The measurement results below 30MHz and above 18GHz were greater than 20dB below the limit, so only the radiated spurious emissions from 30MHz to 18GHz were reported.

Appendix B.7: Test Results of Radiated Spurious Emissions

Lora DTS SF7 with 8dBi antenna

30MHz - 1GHz

EUT Information

EUT Name:	WisLink LPWAN Concentrator
Model	RAK5146
Test Mode:	ON, normal working
Test Voltage:	DC 3.3V
Test By:	Steve Lan
Review By:	Gary Chen
Remark:	3m Chamber

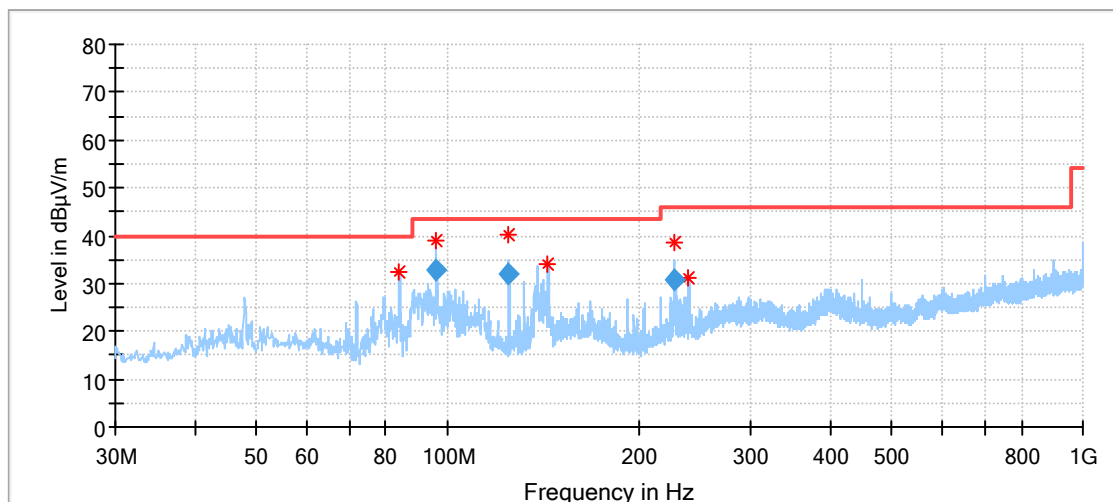

Critical_Freqs

Frequency (MHz)	MaxPeak (dBµV/m)	Limit (dBµV/m)	Margin (dB)	Height (cm)	Pol	Azimuth (deg)	Corr. (dB/m)
83.932000	32.58	40.00	7.42	200.0	H	243.0	15.3
95.980000	39.15	43.50	4.35	200.0	H	218.0	16.5
124.983000	40.32	43.50	3.18	100.0	H	226.0	19.1
143.975000	34.11	43.50	9.39	200.0	H	53.0	20.2
228.037000	38.65	46.00	7.35	200.0	H	171.0	18.8
239.908000	31.20	46.00	14.80	200.0	H	184.0	18.7

Final_Result

Frequency (MHz)	QuasiPeak (dBµV/m)	Limit (dBµV/m)	Margin (dB)	Meas. Time (ms)	Bandwidth (kHz)	Height (cm)	Pol	Azimuth (deg)	Corr. (dB/m)
95.980000	32.81	43.50	10.69	1000.0	120.000	200.0	H	218.0	16.5
124.983000	32.09	43.50	11.41	1000.0	120.000	100.0	H	226.0	19.1
228.037000	30.80	46.00	15.20	1000.0	120.000	200.0	H	171.0	18.8

EUT Information

EUT Name:	WisLink LPWAN Concentrator
Model	RAK5146
Test Mode:	ON, normal working
Test Voltage:	DC 3.3V
Test By:	Steve Lan
Review By:	Gary Chen
Remark:	3m Chamber

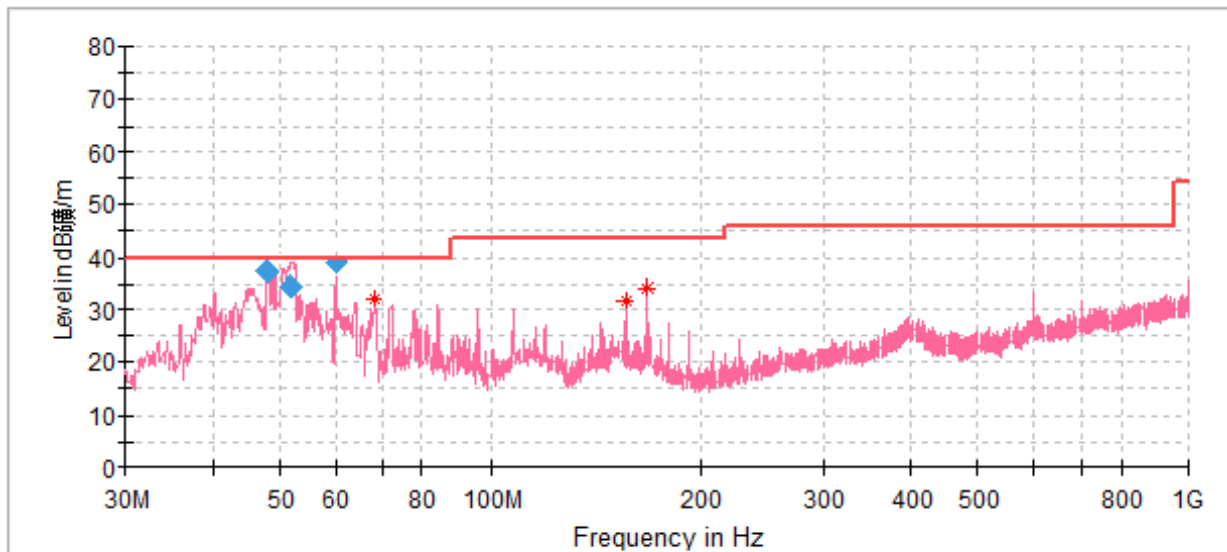

Critical_Freqs

Frequency (MHz)	MaxPeak (dBµV/m)	Limit (dBµV/m)	Margin (dB)	Height (cm)	Pol	Azimuth (deg)	Corr. (dB/m)
68.315000	32.03	40.00	7.97	200.0	V	231.0	19.0
155.906000	31.76	43.50	11.74	100.0	V	4.0	21.5
168.031000	34.07	43.50	9.43	200.0	V	338.0	21.5

Final_Result

Frequency (MHz)	QuasiPeak (dBµV/m)	Limit (dBµV/m)	Margin (dB)	Meas. Time (ms)	Bandwidth (kHz)	Height (cm)	Pol	Azimuth (deg)	Corr. (dB/m)
48.005000	37.49	40.00	2.51	1000.0	120.000	100.0	V	103.0	21.4
51.805000	34.46	40.00	5.54	1000.0	120.000	100.0	V	339.0	20.8
60.033000	38.91	40.00	1.09	1000.0	120.000	100.0	V	261.0	20.9

1GHz - 8GHz

EUT Information

EUT Name: WisLink LPWAN Concentrator
 Model: RAK5146
 Test Mode: Lora_DTS 500K_SF7_925.1MHz
 Test Voltage: DC 3.3V
 Remark: Temp 24 Humi:47%
 Test Standard: FCC 15.247
 Tested By: Kei Zhang
 Reviewed By: Terry Yin

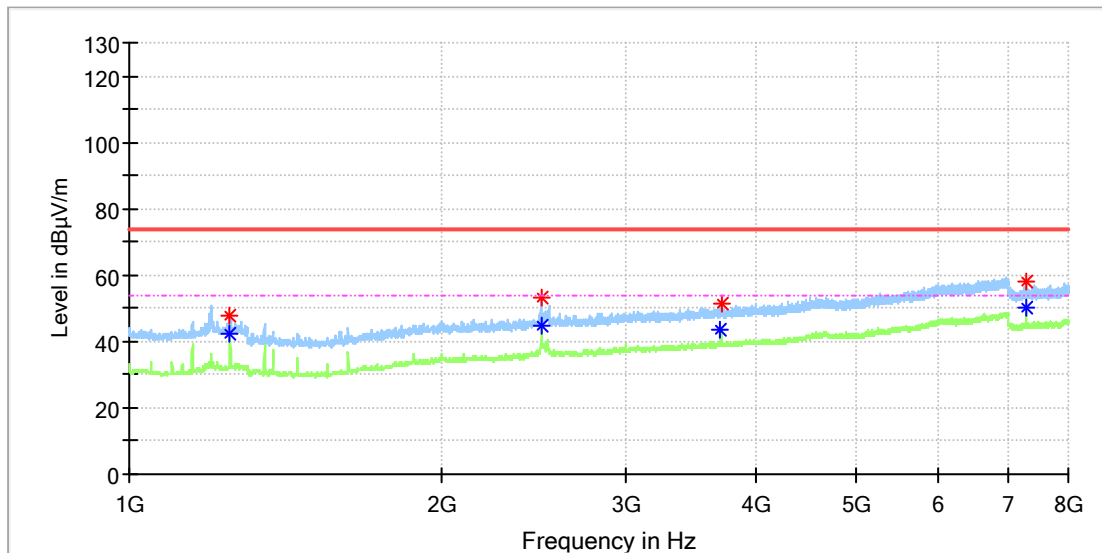

Critical Freqs

Frequency (MHz)	MaxPeak (dBµV/m)	Average (dBµV/m)	Limit (dBµV/m)	Margin (dB)	Height (cm)	Pol	Azimuth (deg)	Corr. (dB/m)
1250.000000	---	42.25	54.00	11.75	100.0	H	0.0	1.9
1250.000000	48.05	---	74.00	25.95	100.0	H	0.0	1.9
2487.575000	52.95	---	74.00	21.05	100.0	H	103.0	7.4
2488.412500	---	44.74	54.00	9.26	100.0	H	103.0	7.4
3706.137500	---	43.56	54.00	10.44	100.0	H	103.0	9.6
3709.487500	51.11	---	74.00	22.89	100.0	H	103.0	9.6
7278.912500	---	50.46	54.00	3.54	100.0	H	162.0	17.9
7278.912500	58.32	---	74.00	15.68	100.0	H	162.0	17.9

EUT Information

EUT Name: WisLink LPWAN Concentrator
 Model: RAK5146
 Test Mode: Lora_DTS 500K_SF7_925.1MHz
 Test Voltage:: DC 3.3V
 Remark: Temp 24 Humi:47%
 Test Standard: FCC 15.247
 Tested By: Kei Zhang
 Reviewed By: Terry Yin

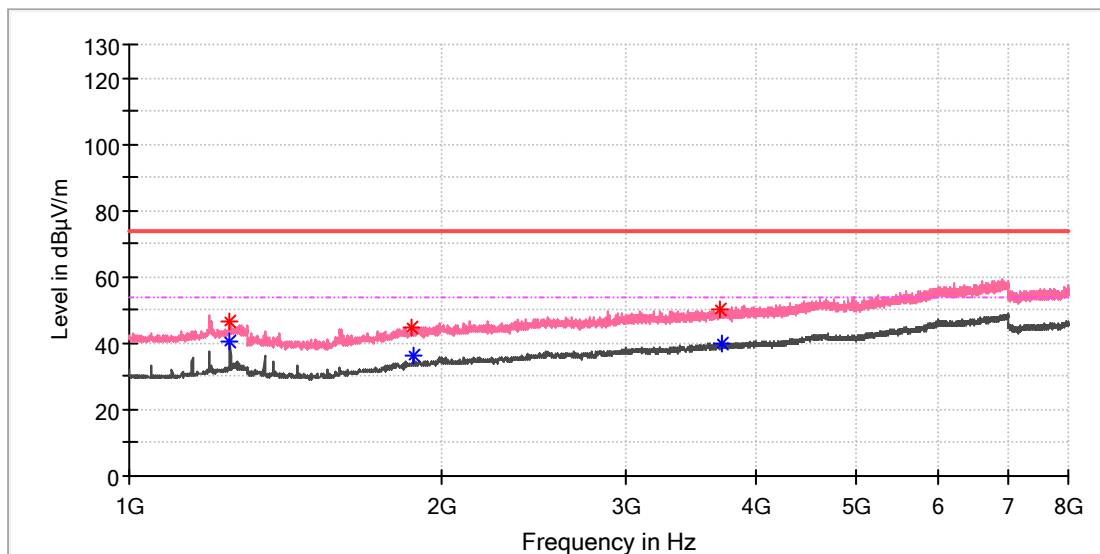

Critical Freqs

Frequency (MHz)	MaxPeak (dBµV/m)	Average (dBµV/m)	Limit (dBµV/m)	Margin (dB)	Height (cm)	Pol	Azimuth (deg)	Corr. (dB/m)
1250.000000	46.82	---	74.00	27.18	100.0	V	348.0	1.9
1250.500000	---	40.57	54.00	13.43	100.0	V	294.0	1.9
1872.012500	44.82	---	74.00	29.18	100.0	V	1.0	5.3
1874.525000	---	36.46	54.00	17.54	100.0	V	62.0	5.3
3705.300000	50.16	---	74.00	23.84	100.0	V	132.0	9.6
3712.000000	---	39.63	54.00	14.37	100.0	V	62.0	9.6

8GHz - 10GHz

EUT Information

EUT Name:	WisLink LPWAN Concentrator
Model:	RAK5146
Test Mode:	Lora_DTS 500K_SF7_925.1MHz
Test Voltage::	DC 3.3V
Remark:	Temp 24 Humi:47%
Test Standard:	FCC 15.247
Tested By:	Kei Zhang
Reviewed By:	Terry Yin

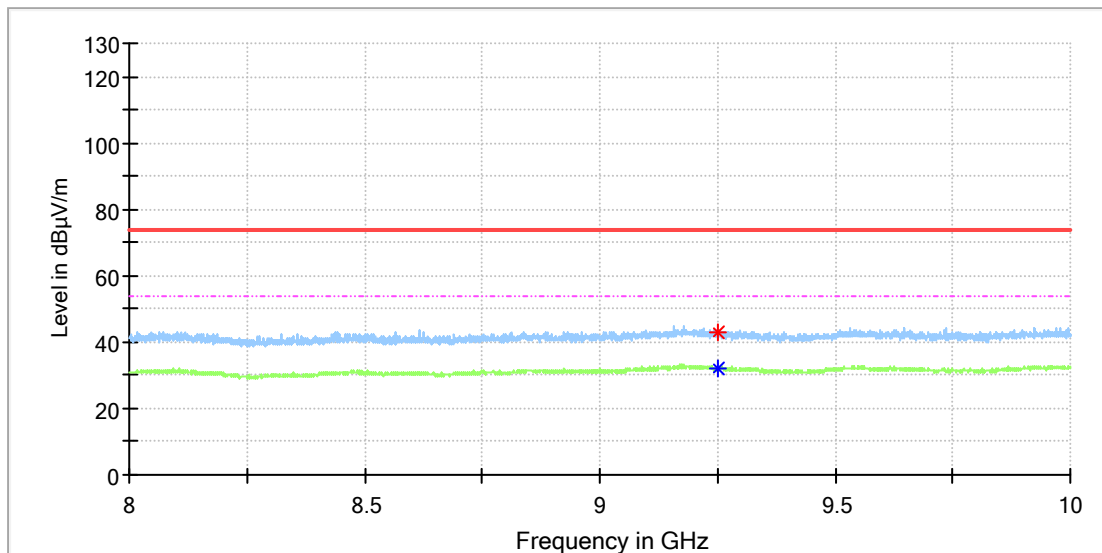

Critical Freqs

Frequency (MHz)	MaxPeak (dBµV/m)	Average (dBµV/m)	Limit (dBµV/m)	Margin (dB)	Height (cm)	Pol	Azimuth (deg)	Corr. (dB/m)
9249.000000	---	32.28	54.00	21.72	100.0	H	359.0	10.4
9252.000000	43.18	---	74.00	30.82	100.0	H	359.0	10.4

EUT Information

EUT Name: WisLink LPWAN Concentrator
 Model: RAK5146
 Test Mode: Lora_DTS 500K_SF7_925.1MHz
 Test Voltage:: DC 3.3V
 Remark: Temp 24 Humi:47%
 Test Standard: FCC 15.247
 Tested By: Kei Zhang
 Reviewed By: Terry Yin

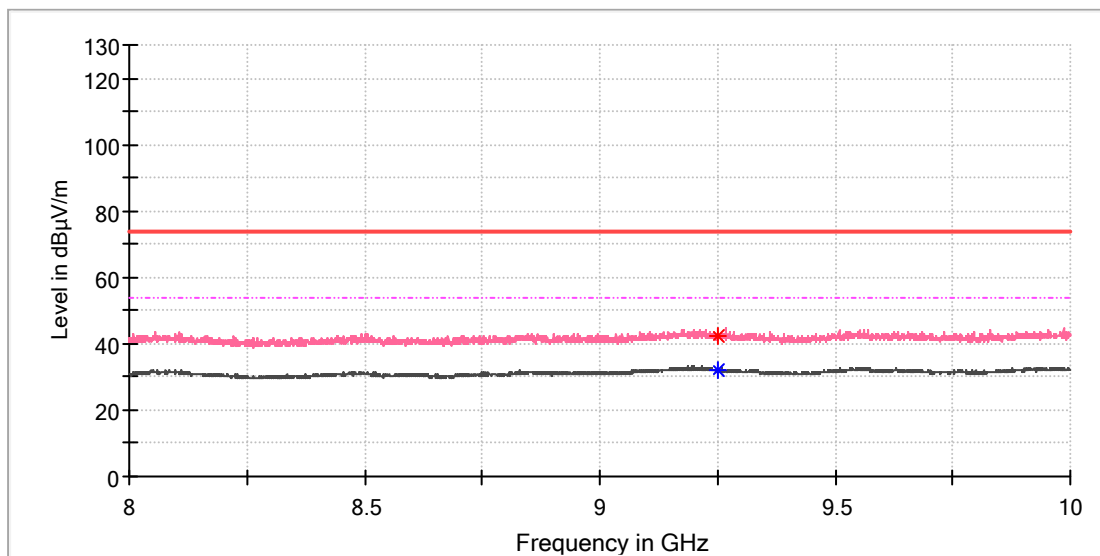

Critical Freqs

Frequency (MHz)	MaxPeak (dBµV/m)	Average (dBµV/m)	Limit (dBµV/m)	Margin (dB)	Height (cm)	Pol	Azimuth (deg)	Corr. (dB/m)
9250.500000	42.13	---	74.00	31.87	100.0	V	2.0	10.4
9251.000000	---	31.99	54.00	22.01	100.0	V	195.0	10.4

Lora DTS SF12 with 2.3dBi antenna

1GHz - 8GHz

EUT Information

EUT Name:	WisLink LPWAN Concentrator
Model:	RAK5146
Test Mode:	Lora_DTS 500K_SF12_923.3MHz
Test Voltage::	DC 3.3V
Remark:	Temp 24 Humi:47%
Test Standard:	FCC 15.247
Tested By:	Kei Zhang
Reviewed By:	Terry Yin

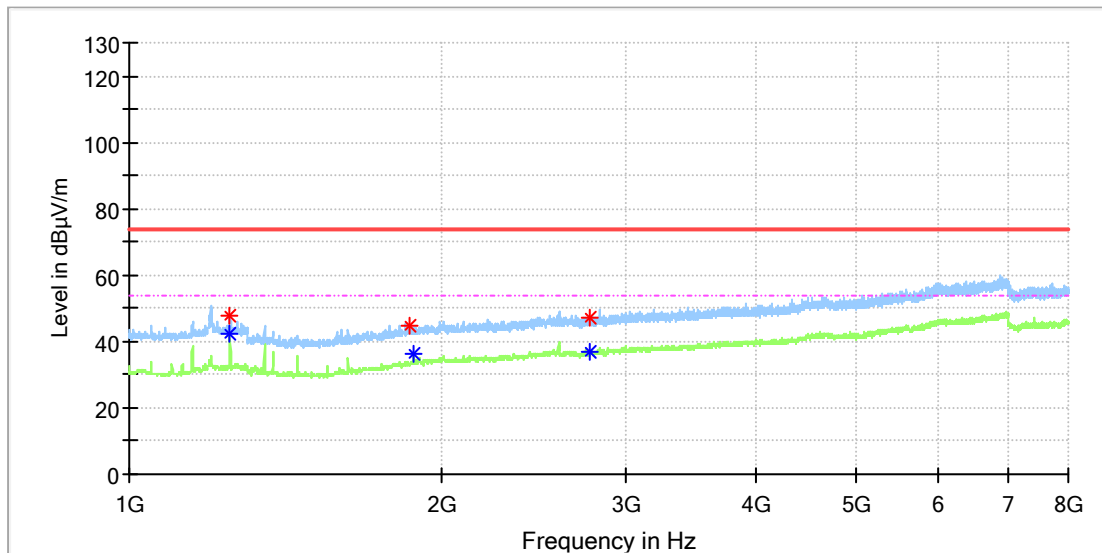

Critical Freqs

Frequency (MHz)	MaxPeak (dBµV/m)	Average (dBµV/m)	Limit (dBµV/m)	Margin (dB)	Height (cm)	Pol	Azimuth (deg)	Corr. (dB/m)
1250.000000	---	42.24	54.00	11.76	100.0	H	6.0	1.9
1250.000000	47.77	---	74.00	26.23	100.0	H	6.0	1.9
1859.450000	44.48	---	74.00	29.52	100.0	H	54.0	5.1
1874.525000	---	36.45	54.00	17.55	100.0	H	64.0	5.3
2769.812500	47.15	---	74.00	26.85	100.0	H	0.0	7.9
2772.325000	---	37.03	54.00	16.97	100.0	H	31.0	7.9

EUT Information

EUT Name:	WisLink LPWAN Concentrator
Model:	RAK5146
Test Mode:	Lora_DTS 500K_SF12_923.3MHz
Test Voltage::	DC 3.3V
Remark:	Temp 24 Humi:47%
Test Standard:	FCC 15.247
Tested By:	Kei Zhang
Reviewed By:	Terry Yin

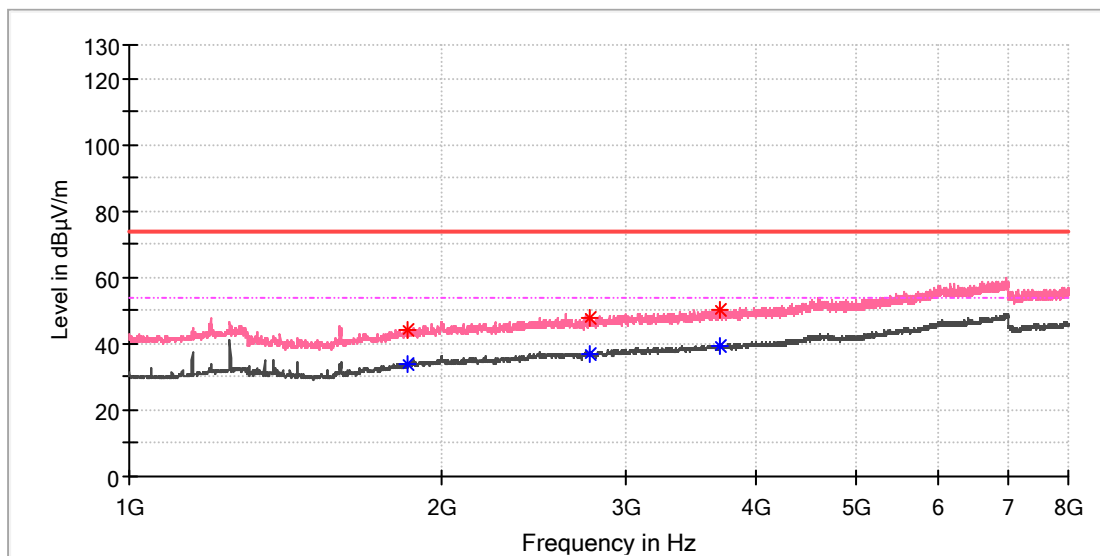

Critical Freqs

Frequency (MHz)	MaxPeak (dBµV/m)	Average (dBµV/m)	Limit (dBµV/m)	Margin (dB)	Height (cm)	Pol	Azimuth (deg)	Corr. (dB/m)
1852.750000	---	33.84	54.00	20.16	100.0	V	296.0	5.0
1853.587500	44.18	---	74.00	29.82	100.0	V	274.0	5.0
2771.487500	---	37.08	54.00	16.92	100.0	V	0.0	7.9
2772.325000	47.93	---	74.00	26.07	100.0	V	221.0	7.9
3696.925000	---	39.55	54.00	14.45	100.0	V	285.0	9.6
3702.787500	50.20	---	74.00	23.80	100.0	V	317.0	9.6

EUT Information

EUT Name:	WisLink LPWAN Concentrator
Model:	RAK5146
Test Mode:	Lora_DTS 500K_SF12_925.1MHz
Test Voltage::	DC 3.3V
Remark:	Temp 24 Humi:47%
Test Standard:	FCC 15.247
Tested By:	Kei Zhang
Reviewed By:	Terry Yin

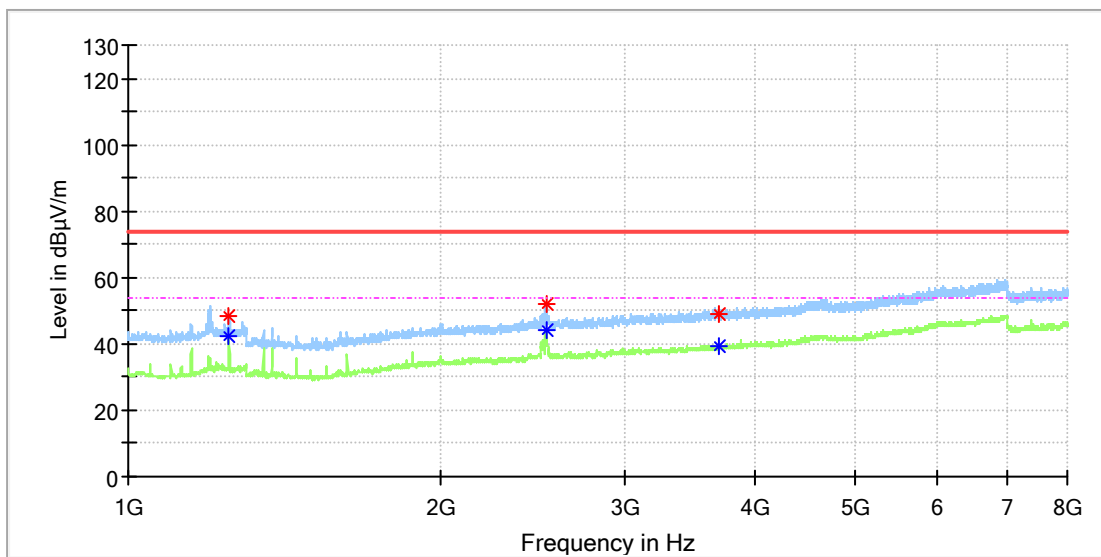

Critical_Freqs

Frequency (MHz)	MaxPeak (dBµV/m)	Average (dBµV/m)	Limit (dBµV/m)	Margin (dB)	Height (cm)	Pol	Azimuth (deg)	Corr. (dB/m)
1250.000000	---	42.10	54.00	11.90	100.0	H	10.0	1.9
1250.500000	48.67	---	74.00	25.33	100.0	H	10.0	1.9
2522.750000	---	44.16	54.00	9.84	100.0	H	210.0	7.5
2522.750000	52.06	---	74.00	21.94	100.0	H	210.0	7.5
3703.625000	49.22	---	74.00	24.78	100.0	H	44.0	9.6
3706.137500	---	39.50	54.00	14.50	100.0	H	67.0	9.6

EUT Information

EUT Name: WisLink LPWAN Concentrator
 Model: RAK5146
 Test Mode: Lora_DTS 500K_SF12_925.1MHz
 Test Voltage:: DC 3.3V
 Remark: Temp 24 Humi:47%
 Test Standard: FCC 15.247
 Tested By: Kei Zhang
 Reviewed By: Terry Yin

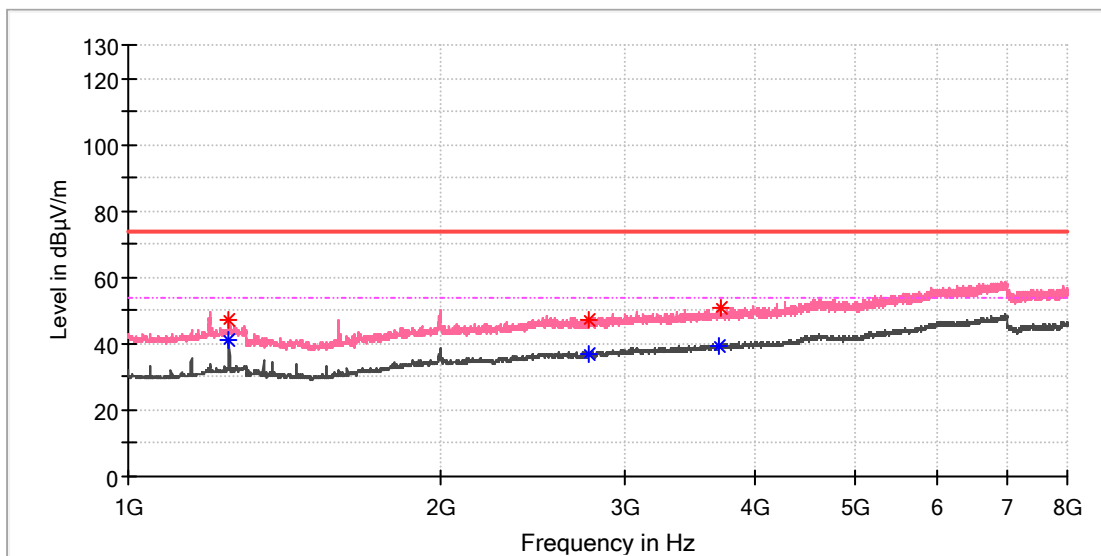

Critical Freqs

Frequency (MHz)	MaxPeak (dBµV/m)	Average (dBµV/m)	Limit (dBµV/m)	Margin (dB)	Height (cm)	Pol	Azimuth (deg)	Corr. (dB/m)
1250.000000	---	40.89	54.00	13.11	100.0	V	345.0	1.9
1250.500000	46.92	---	74.00	27.08	100.0	V	292.0	1.9
2776.512500	47.03	---	74.00	26.97	100.0	V	103.0	7.9
2776.512500	---	37.10	54.00	16.90	100.0	V	103.0	7.9
3701.112500	---	39.40	54.00	14.60	100.0	V	1.0	9.6
3706.975000	50.52	---	74.00	23.48	100.0	V	79.0	9.6

EUT Information

EUT Name:	WisLink LPWAN Concentrator
Model:	RAK5146
Test Mode:	Lora_DTS 500K_SF12_927.5MHz
Test Voltage::	DC 3.3V
Remark:	Temp 24 Humi:47%
Test Standard:	FCC 15.247
Tested By:	Kei Zhang
Reviewed By:	Terry Yin

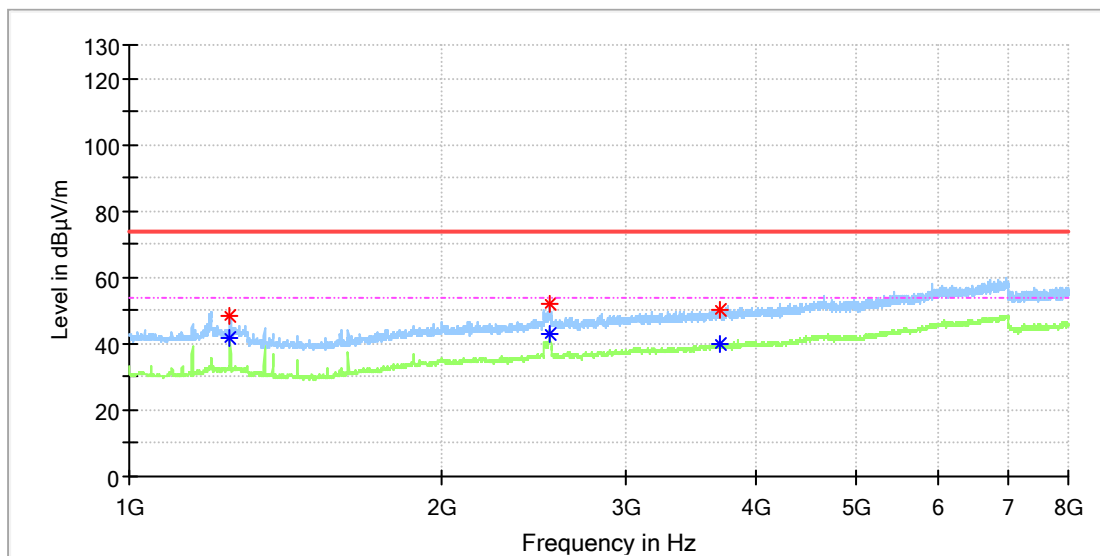

Critical Freqs

Frequency (MHz)	MaxPeak (dBµV/m)	Average (dBµV/m)	Limit (dBµV/m)	Margin (dB)	Height (cm)	Pol	Azimuth (deg)	Corr. (dB/m)
1250.000000	---	41.95	54.00	12.05	100.0	H	296.0	1.9
1250.000000	48.17	---	74.00	25.83	100.0	H	296.0	1.9
2536.150000	---	43.18	54.00	10.82	100.0	H	311.0	7.6
2536.150000	52.27	---	74.00	21.73	100.0	H	311.0	7.6
3701.950000	50.30	---	74.00	23.70	100.0	H	134.0	9.6
3706.137500	---	39.79	54.00	14.21	100.0	H	14.0	9.6

EUT Information

EUT Name:	WisLink LPWAN Concentrator
Model:	RAK5146
Test Mode:	Lora_DTS 500K_SF12_927.5MHz
Test Voltage::	DC 3.3V
Remark:	Temp 24 Humi:47%
Test Standard:	FCC 15.247
Tested By:	Kei Zhang
Reviewed By:	Terry Yin

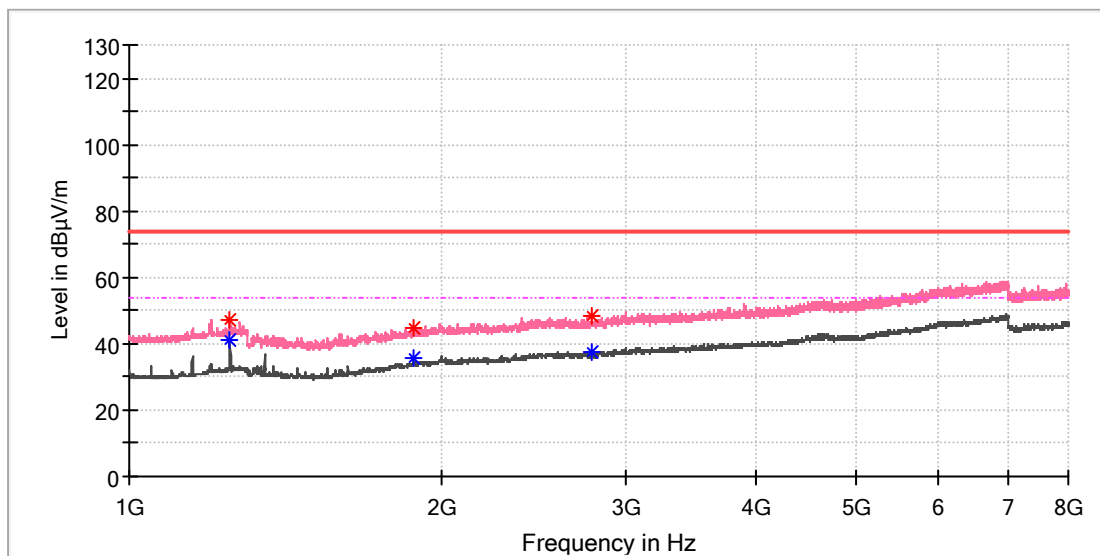

Critical Freqs

Frequency (MHz)	MaxPeak (dBµV/m)	Average (dBµV/m)	Limit (dBµV/m)	Margin (dB)	Height (cm)	Pol	Azimuth (deg)	Corr. (dB/m)
1250.000000	47.42	---	74.00	26.58	100.0	V	348.0	1.9
1250.000000	---	41.05	54.00	12.95	100.0	V	348.0	1.9
1872.850000	44.71	---	74.00	29.29	100.0	V	159.0	5.3
1874.525000	---	35.63	54.00	18.37	100.0	V	171.0	5.3
2779.862500	---	37.47	54.00	16.53	100.0	V	249.0	7.9
2783.212500	48.14	---	74.00	25.86	100.0	V	69.0	7.9

8GHz - 10GHz

EUT Information

EUT Name: WisLink LPWAN Concentrator
 Model: RAK5146
 Test Mode: Lora_DTS 500K_SF12_923.3MHz
 Test Voltage:: DC 3.3V
 Remark: Temp 24 Humi:47%
 Test Standard: FCC 15.247
 Tested By: Kei Zhang
 Reviewed By: Terry Yin

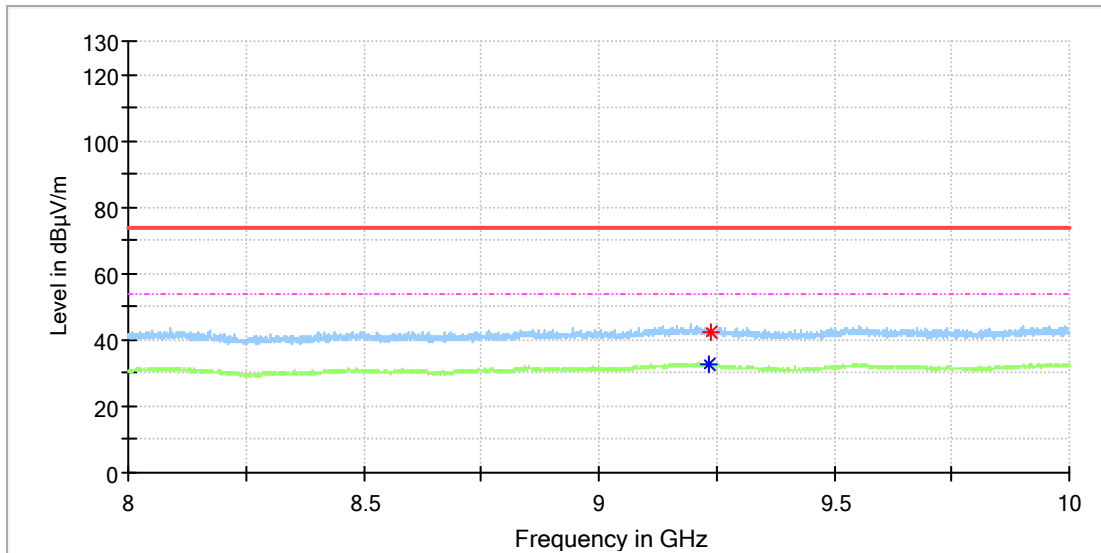

Critical Freqs

Frequency (MHz)	MaxPeak (dBµV/m)	Average (dBµV/m)	Limit (dBµV/m)	Margin (dB)	Height (cm)	Pol	Azimuth (deg)	Corr. (dB/m)
9234.000000	---	32.39	54.00	21.61	100.0	H	176.0	10.4
9236.500000	42.52	---	74.00	31.48	100.0	H	22.0	10.4

EUT Information

EUT Name: WisLink LPWAN Concentrator
 Model: RAK5146
 Test Mode: Lora_DTS 500K_SF12_923.3MHz
 Test Voltage:: DC 3.3V
 Remark: Temp 24 Humi:47%
 Test Standard: FCC 15.247
 Tested By: Kei Zhang
 Reviewed By: Terry Yin

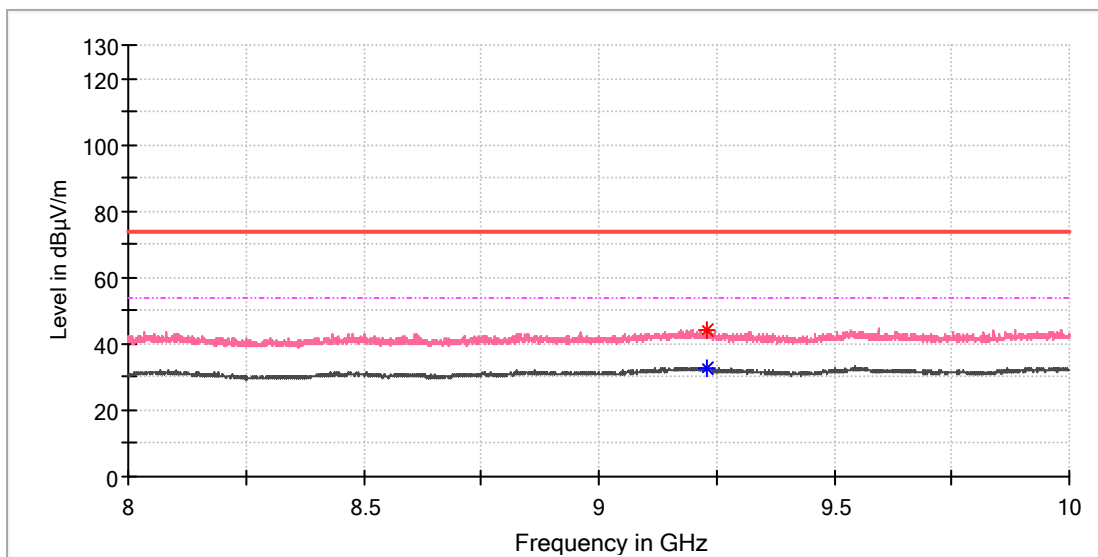

Critical_Freqs

Frequency (MHz)	MaxPeak (dBµV/m)	Average (dBµV/m)	Limit (dBµV/m)	Margin (dB)	Height (cm)	Pol	Azimuth (deg)	Corr. (dB/m)
9231.500000	43.93	---	74.00	30.07	100.0	V	263.0	10.4
9231.500000	---	32.58	54.00	21.42	100.0	V	263.0	10.4

EUT Information

EUT Name: WisLink LPWAN Concentrator
 Model: RAK5146
 Test Mode: Lora_DTS 500K_SF12_925.1MHz
 Test Voltage:: DC 3.3V
 Remark: Temp 24 Humi:47%
 Test Standard: FCC 15.247
 Tested By: Kei Zhang
 Reviewed By: Terry Yin

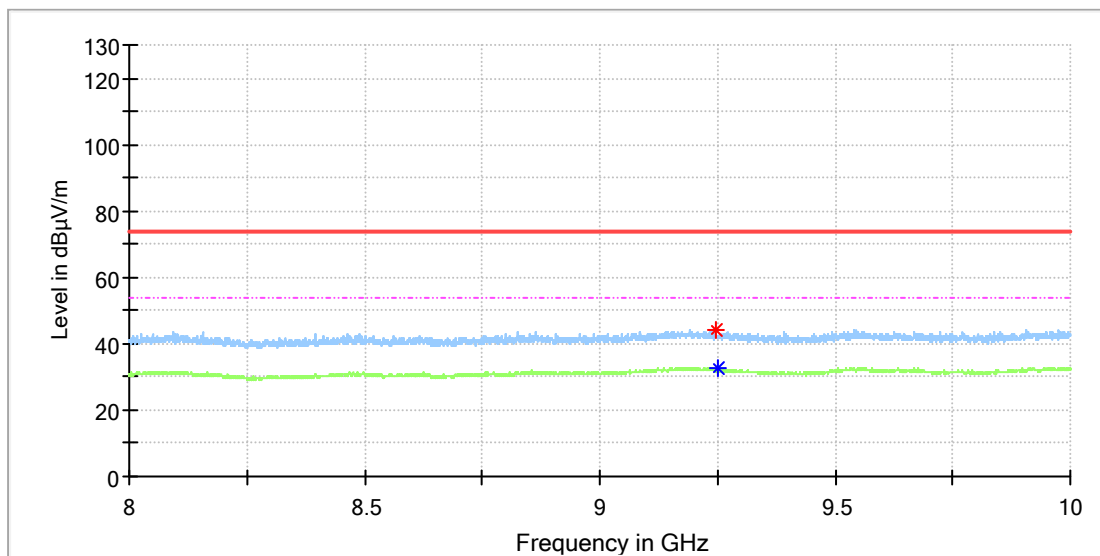

Critical_Freqs

Frequency (MHz)	MaxPeak (dBµV/m)	Average (dBµV/m)	Limit (dBµV/m)	Margin (dB)	Height (cm)	Pol	Azimuth (deg)	Corr. (dB/m)
9246.500000	44.12	---	74.00	29.88	100.0	H	36.0	10.4
9250.500000	---	32.46	54.00	21.54	100.0	H	53.0	10.4

EUT Information

EUT Name: WisLink LPWAN Concentrator
 Model: RAK5146
 Test Mode: Lora_DTS 500K_SF12_925.1MHz
 Test Voltage:: DC 3.3V
 Remark: Temp 24 Humi:47%
 Test Standard: FCC 15.247
 Tested By: Kei Zhang
 Reviewed By: Terry Yin

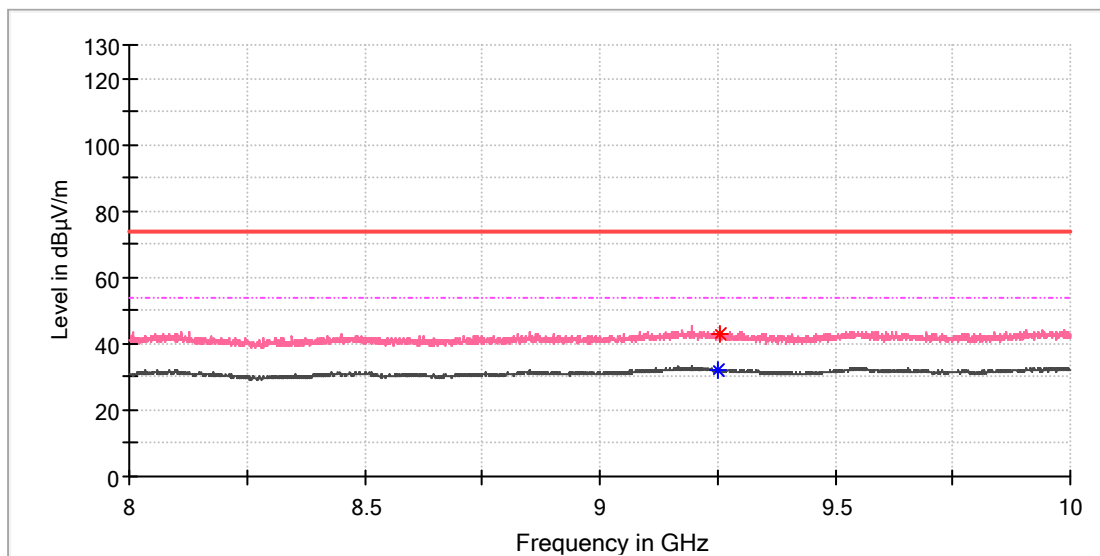

Critical Freqs

Frequency (MHz)	MaxPeak (dBµV/m)	Average (dBµV/m)	Limit (dBµV/m)	Margin (dB)	Height (cm)	Pol	Azimuth (deg)	Corr. (dB/m)
9252.500000	---	32.28	54.00	21.72	100.0	V	173.0	10.4
9256.000000	43.01	---	74.00	30.99	100.0	V	240.0	10.4

EUT Information

EUT Name: WisLink LPWAN Concentrator
 Model: RAK5146
 Test Mode: Lora_DTS 500K_SF12_927.5MHz
 Test Voltage:: DC 3.3V
 Remark: Temp 24 Humi:47%
 Test Standard: FCC 15.247
 Tested By: Kei Zhang
 Reviewed By: Terry Yin

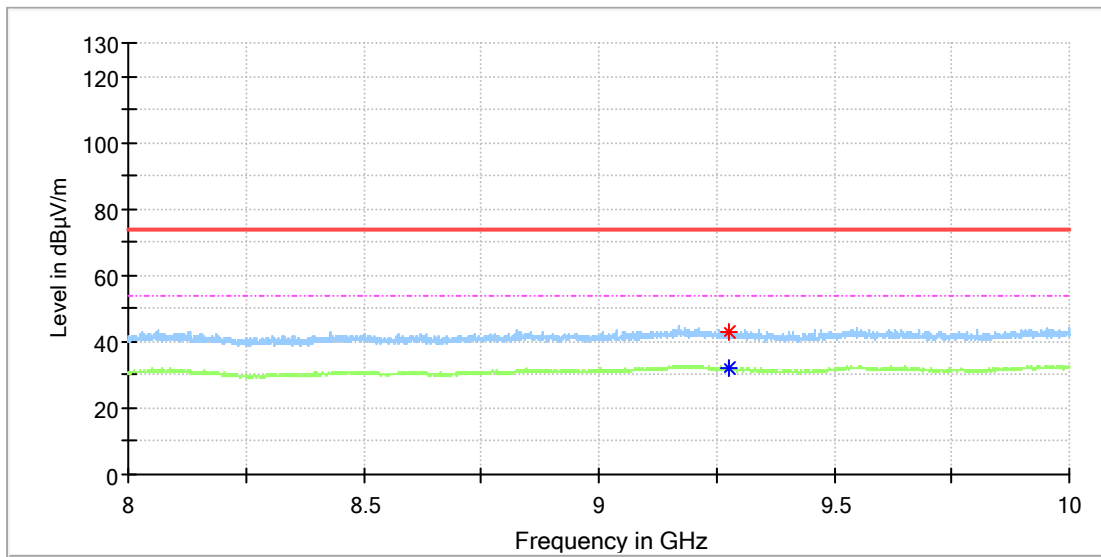

Critical_Freqs

Frequency (MHz)	MaxPeak (dBµV/m)	Average (dBµV/m)	Limit (dBµV/m)	Margin (dB)	Height (cm)	Pol	Azimuth (deg)	Corr. (dB/m)
9274.500000	---	31.96	54.00	22.04	100.0	H	159.0	10.2
9275.500000	42.78	---	74.00	31.22	100.0	H	308.0	10.2

EUT Information

EUT Name: WisLink LPWAN Concentrator
 Model: RAK5146
 Test Mode: Lora_DTS 500K_SF12_927.5MHz
 Test Voltage:: DC 3.3V
 Remark: Temp 24 Humi:47%
 Test Standard: FCC 15.247
 Tested By: Kei Zhang
 Reviewed By: Terry Yin

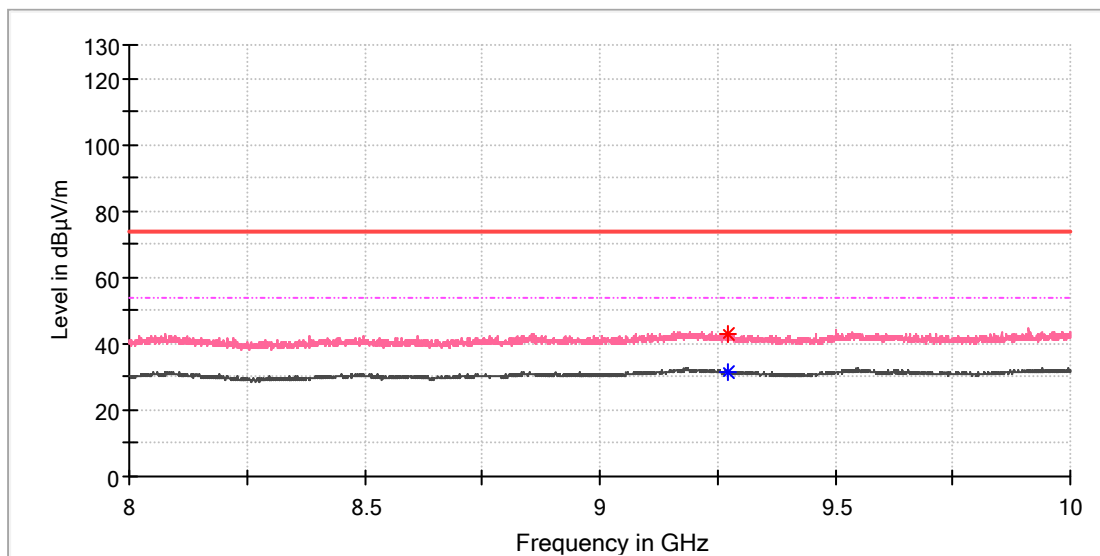

Critical Freqs

Frequency (MHz)	MaxPeak (dBµV/m)	Average (dBµV/m)	Limit (dBµV/m)	Margin (dB)	Height (cm)	Pol	Azimuth (deg)	Corr. (dB/m)
9272.000000	42.80	---	74.00	31.20	100.0	V	128.0	10.2
9272.500000	---	31.71	54.00	22.29	100.0	V	87.0	10.2

Lora Hybrid SF7 with 8 dBi antenna

1GHz - 8GHz

EUT Information

EUT Name:	WisLink LPWAN Concentrator
Model:	RAK5146
Test Mode:	Lora_DTS 500K_SF7_925.1MHz
Test Voltage::	DC 3.3V
Remark:	Temp 24 Humi:47%
Test Standard:	FCC 15.247
Tested By:	Kei Zhang
Reviewed By:	Terry Yin

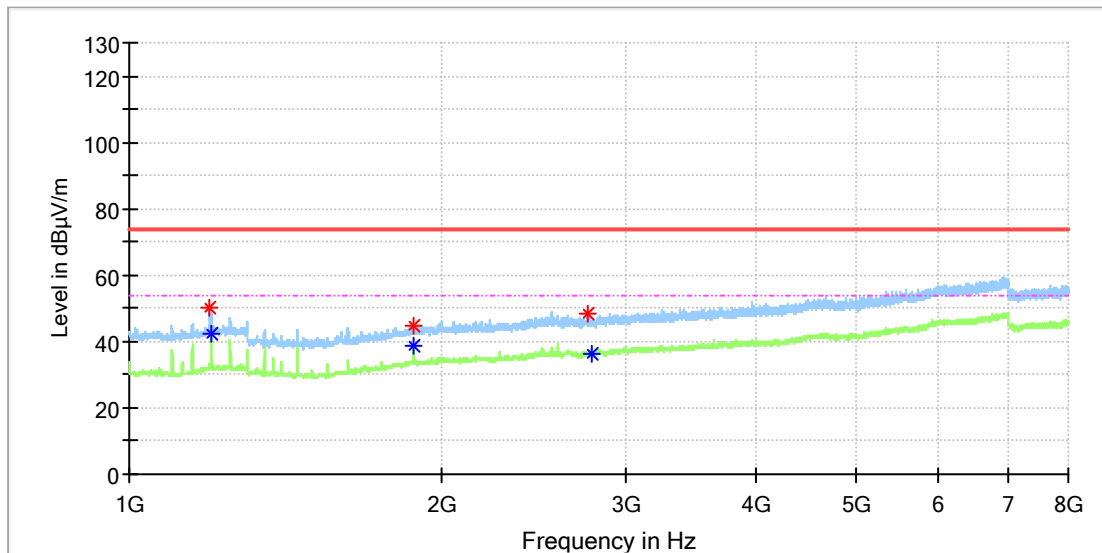

Critical_Freqs

Frequency (MHz)	MaxPeak (dBµV/m)	Average (dBµV/m)	Limit (dBµV/m)	Margin (dB)	Height (cm)	Pol	Azimuth (deg)	Corr. (dB/m)
1196.000000	50.49	---	74.00	23.51	100.0	H	151.0	1.1
1200.000000	---	42.18	54.00	11.82	100.0	H	352.0	1.1
1874.525000	45.00	---	74.00	29.00	100.0	H	101.0	5.3
1874.525000	---	38.75	54.00	15.25	100.0	H	101.0	5.3
2763.950000	48.15	---	74.00	25.85	100.0	H	253.0	7.9
2781.537500	---	36.40	54.00	17.60	100.0	H	6.0	7.9

EUT Information

EUT Name: WisLink LPWAN Concentrator
 Model: RAK5146
 Test Mode: Lora_DTS 500K_SF7_925.1MHz
 Test Voltage:: DC 3.3V
 Remark: Temp 24 Humi:47%
 Test Standard: FCC 15.247
 Tested By: Kei Zhang
 Reviewed By: Terry Yin

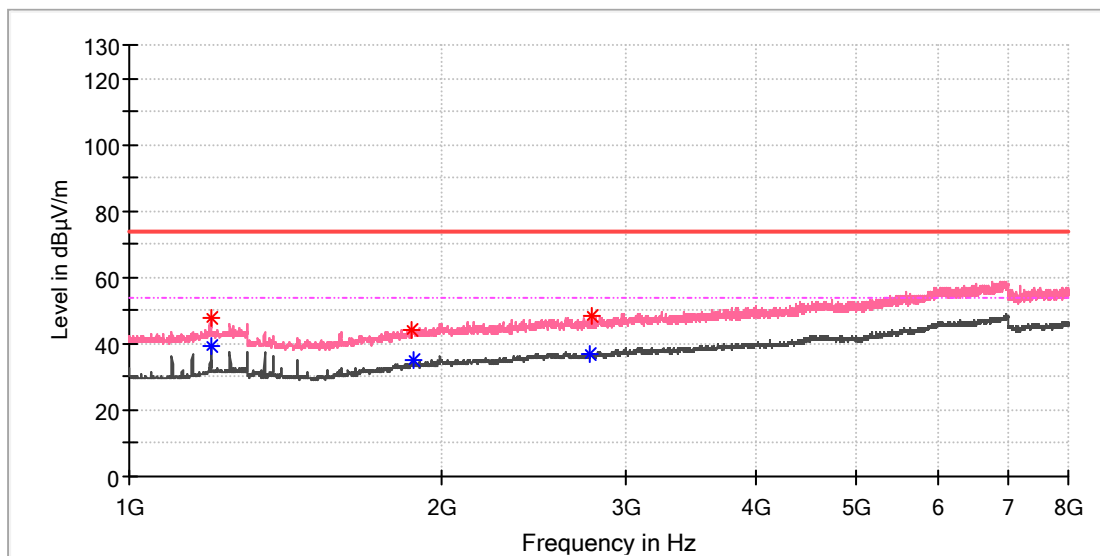

Critical Freqs

Frequency (MHz)	MaxPeak (dBµV/m)	Average (dBµV/m)	Limit (dBµV/m)	Margin (dB)	Height (cm)	Pol	Azimuth (deg)	Corr. (dB/m)
1200.000000	---	39.32	54.00	14.68	100.0	V	322.0	1.1
1200.500000	47.77	---	74.00	26.23	100.0	V	322.0	1.1
1869.500000	44.02	---	74.00	29.98	100.0	V	185.0	5.2
1874.525000	---	35.32	54.00	18.68	100.0	V	55.0	5.3
2776.512500	---	36.99	54.00	17.01	100.0	V	256.0	7.9
2781.537500	48.23	---	74.00	25.77	100.0	V	96.0	7.9

8GHz - 10GHz

EUT Information

EUT Name: WisLink LPWAN Concentrator
 Model: RAK5146
 Test Mode: Lora_DTS 500K_SF7_925.1MHz
 Test Voltage: DC 3.3V
 Remark: Temp 24 Humi:47%
 Test Standard: FCC 15.247
 Tested By: Kei Zhang
 Reviewed By: Terry Yin

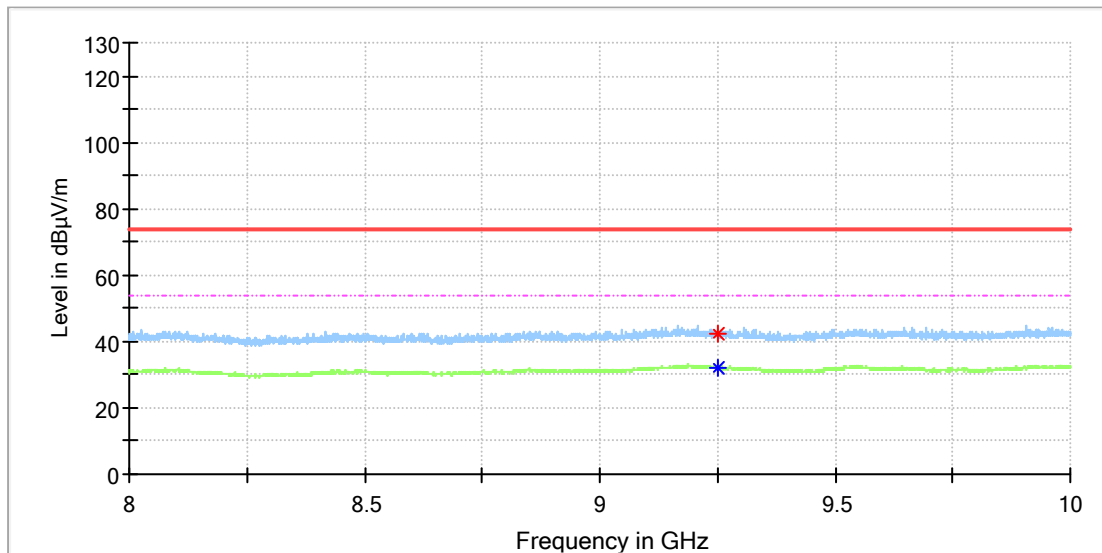

Critical Freqs

Frequency (MHz)	MaxPeak (dBµV/m)	Average (dBµV/m)	Limit (dBµV/m)	Margin (dB)	Height (cm)	Pol	Azimuth (deg)	Corr. (dB/m)
9250.000000	42.52	---	74.00	31.48	100.0	H	197.0	10.5
9252.000000	---	32.21	54.00	21.79	100.0	H	115.0	10.4

EUT Information

EUT Name: WisLink LPWAN Concentrator
 Model: RAK5146
 Test Mode: Lora_DTS 500K_SF7_925.1MHz
 Test Voltage:: DC 3.3V
 Remark: Temp 24 Humi:47%
 Test Standard: FCC 15.247
 Tested By: Kei Zhang
 Reviewed By: Terry Yin

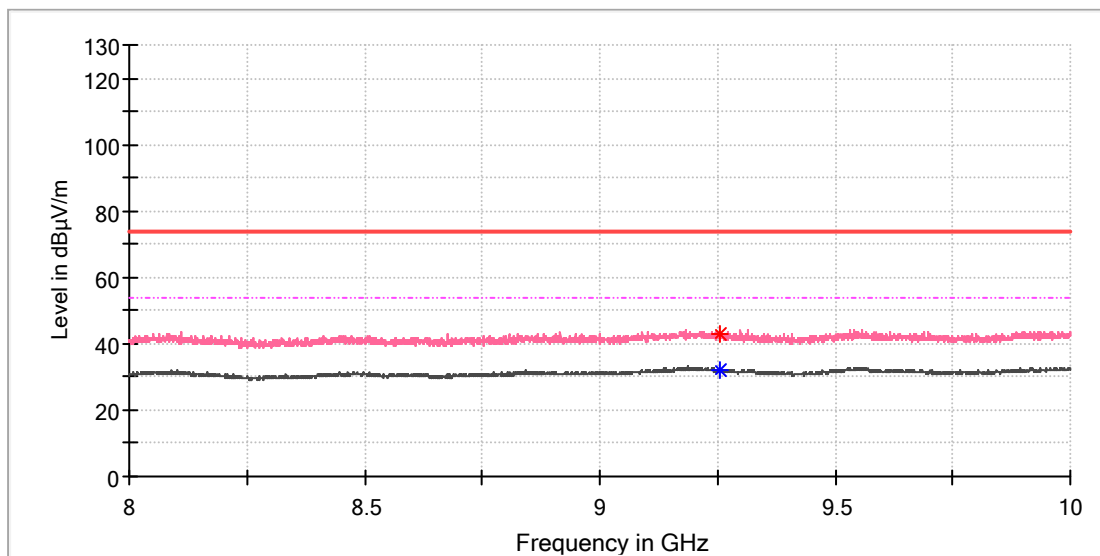

Critical Freqs

Frequency (MHz)	MaxPeak (dBµV/m)	Average (dBµV/m)	Limit (dBµV/m)	Margin (dB)	Height (cm)	Pol	Azimuth (deg)	Corr. (dB/m)
9254.000000	42.88	---	74.00	31.12	100.0	V	141.0	10.4
9256.500000	---	32.20	54.00	21.80	100.0	V	60.0	10.4

Appendix B.8: Test Results of Conducted Emission on AC Mains

EUT Information

EUT Name: WisLink LPWAN Concentrator
 Model: RAK5146
 Test mode: ON, normal working
 Test Voltage: AC 120V, 60Hz
 Test By: Steve Lan
 Review By: Gary Chen
 Remark: SR2

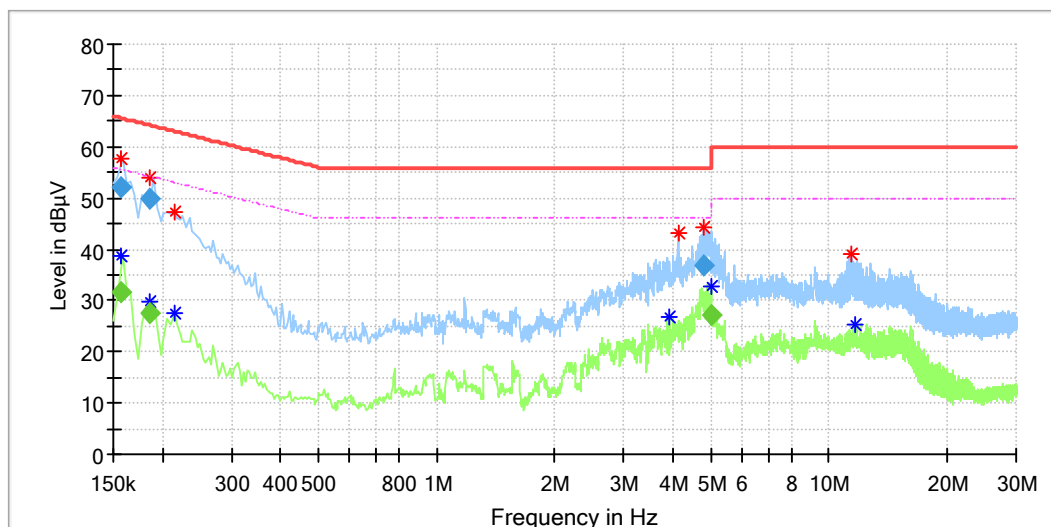

Critical Freqs

Frequency (MHz)	MaxPeak (dBµV)	Average (dBµV)	Limit (dBµV)	Margin (dB)	Line	Corr. (dB)
0.157500	---	38.55	55.57	17.02	L1	9.9
0.157500	57.52	---	65.57	8.05	L1	9.9
0.185500	---	29.81	54.04	24.22	L1	9.9
0.185500	53.95	---	64.04	10.09	L1	9.9
0.214000	---	27.40	53.05	25.65	L1	9.9
0.214000	47.38	---	63.05	15.66	L1	9.9
3.922000	---	26.84	46.00	19.16	L1	10.2
4.122000	43.21	---	56.00	12.79	L1	10.2
4.786500	44.15	---	56.00	11.85	L1	10.2
5.013500	---	32.72	50.00	17.28	L1	10.3
11.458000	38.96	---	60.00	21.04	L1	10.3
11.606000	---	25.24	50.00	24.76	L1	10.3

Final Result

Frequency (MHz)	QuasiPeak (dBµV)	Average (dBµV)	Limit (dBµV)	Margin (dB)	Meas. Time (ms)	Bandwidth (kHz)	Line	Corr. (dB)
0.157500	---	31.72	55.60	23.88	1000.0	9.000	L1	9.9
0.157500	52.17	---	65.60	13.42	1000.0	9.000	L1	9.9
0.185500	---	27.41	54.24	26.83	1000.0	9.000	L1	9.9
0.185500	49.68	---	64.24	14.55	1000.0	9.000	L1	9.9
4.786500	36.76	---	56.00	19.24	1000.0	9.000	L1	10.2
5.013500	---	27.26	50.00	22.74	1000.0	9.000	L1	10.3

EUT Information

EUT Name: WisLink LPWAN Concentrator
 Model: RAK5146
 Test mode: ON, normal working
 Test Voltage: AC 120V, 60Hz
 Test By: Steve Lan
 Review By: Gary Chen
 Remark: SR2

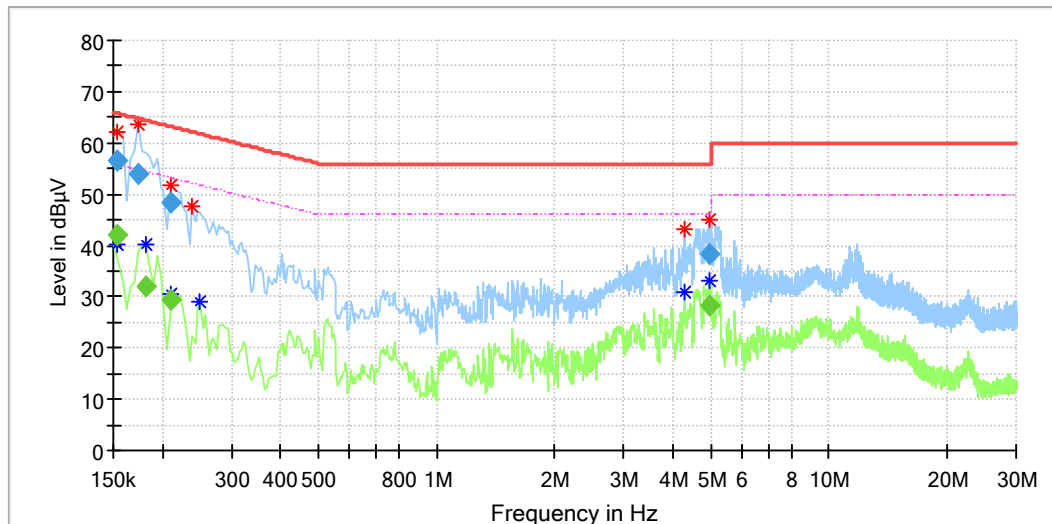

Critical Freqs

Frequency (MHz)	MaxPeak (dBµV)	Average (dBµV)	Limit (dBµV)	Margin (dB)	Line	Corr. (dB)
0.153500	62.09	---	65.57	3.48	N	9.8
0.154000	---	40.27	56.00	15.73	N	9.8
0.173500	63.49	---	64.77	1.27	N	9.8
0.182500	---	40.04	54.58	14.54	N	9.8
0.209500	---	30.34	53.05	22.71	N	9.8
0.209500	51.85	---	63.21	11.35	N	9.8
0.238000	47.59	---	62.17	14.57	N	9.8
0.250000	---	29.01	51.76	22.75	N	9.8
4.274000	---	30.96	46.00	15.04	N	9.9
4.274000	43.23	---	56.00	12.77	N	9.9
4.961500	---	33.28	46.00	12.72	N	9.9
4.985500	45.15	---	56.00	10.85	N	9.9

Final Result

Frequency (MHz)	QuasiPeak (dBµV)	Average (dBµV)	Limit (dBµV)	Margin (dB)	Meas. Time (ms)	Bandwidth (kHz)	Line	Corr. (dB)
0.153500	56.40	---	65.81	9.41	1000.0	9.000	N	9.8
0.154000	---	41.99	55.78	13.79	1000.0	9.000	N	9.8
0.173500	54.05	---	64.79	10.74	1000.0	9.000	N	9.8
0.182500	---	32.01	54.37	22.36	1000.0	9.000	N	9.8
0.209500	48.45	---	63.23	14.77	1000.0	9.000	N	9.8
0.209500	---	29.22	53.23	24.00	1000.0	9.000	N	9.8
4.961500	---	28.22	46.00	17.78	1000.0	9.000	N	9.9
4.985500	38.50	---	56.00	17.50	1000.0	9.000	N	9.9