

#### 4.5. Peak Power Spectral Density

##### **a. Limit**

1. For direct sequence systems, the peak power spectral density conducted from the intentional radiator to the antenna shall not be greater than 8dBm in any 3kHz band during any time interval of continuous transmission.
2. The direct sequence operating of the hybrid system, with the frequency hopping operation turned off, shall comply with the power density requirements of paragraph (d) of this section.

##### **b. Test Procedure**

1. Place the EUT on the table and set it in transmitting mode. Remove the antenna from the EUT and then connect a low loss RF cable from the antenna port to the spectrum analyzer.
2. Set the spectrum analyzer as RBW = 3kHz, VBW = 10kHz, Span = 1.5 times DTS BW, Sweep=500s
3. Record the max. reading.
4. Repeat the above procedure until the measurements for all frequencies are completed.

##### **c. Test Equipment**

Same as the equipment listed in 4.2.

##### **d. Test Setup**

See 4.1

##### **e. Test Results**

Pass

##### **f. Test Data**

Please refer to the following data.

##### **g. Test Plot** See the following pages

## External Antenna

Test mode: IEEE 802.11b

Channel	Frequency (MHz)	PPSD (dBm/3KHz)	$\Sigma$ PPSD (dBm/3KHz)	Limit (dBm)	Result
Low	2412	-14.890	-	8.00	Pass
Mid	2437	-14.292	-		Pass
High	2462	-13.826	-		Pass

Test mode: IEEE 802.11g

Channel	Frequency (MHz)	PPSD (dBm)	$\Sigma$ PPSD (dBm)	Limit (dBm)	Result
Low	2412	-18.949	-	8.00	Pass
Mid	2437	-20.231	-		Pass
High	2462	-20.266	-		Pass

Test mode: IEEE 802.11n (HT20)

Channel	Frequency (MHz)	PPSD (dBm/3KHz)	$\Sigma$ PPSD (dBm/3KHz)	Limit (dBm)	Result
Low	2412	-21.994	-	8.00	Pass
Mid	2437	-23.370	-		Pass
High	2462	-19.966	-		Pass

Onboard Antenna

Test mode: IEEE 802.11b

Channel	Frequency (MHz)	PPSD (dBm/3KHz)	ΣPPSD (dBm/3KHz)	Limit (dBm)	Result
Low	2412	-16.572	-	8.00	Pass
Mid	2437	-14.876	-		Pass
High	2462	-14.108	-		Pass

Test mode: IEEE 802.11g

Channel	Frequency (MHz)	PPSD (dBm)	ΣPPSD (dBm)	Limit (dBm)	Result
Low	2412	-20.436	-	8.00	Pass
Mid	2437	-19.375	-		Pass
High	2462	-17.827	-		Pass

Test mode: IEEE 802.11n (HT20)

Channel	Frequency (MHz)	PPSD (dBm/3KHz)	ΣPPSD (dBm/3KHz)	Limit (dBm)	Result
Low	2412	-22.493	-	8.00	Pass
Mid	2437	-21.623	-		Pass
High	2462	-21.088	-		Pass

Channel	Channel Frequency (MHz)	External Antenna PSD (dBm)	Onboard Antenna PSD (dBm)	Data Rate (Mbps)	MIMO PSD (dBm)	Limit (dBm)
<b>802.11n (20M MIMO) mode</b>						
Low	2412	-21.994	-22.493	MCS0	-19.23	8
Middle	2437	-23.370	-21.623	MCS0	-19.40	8
High	2462	-19.966	-21.088	MCS0	-17.46	8

External Antenna

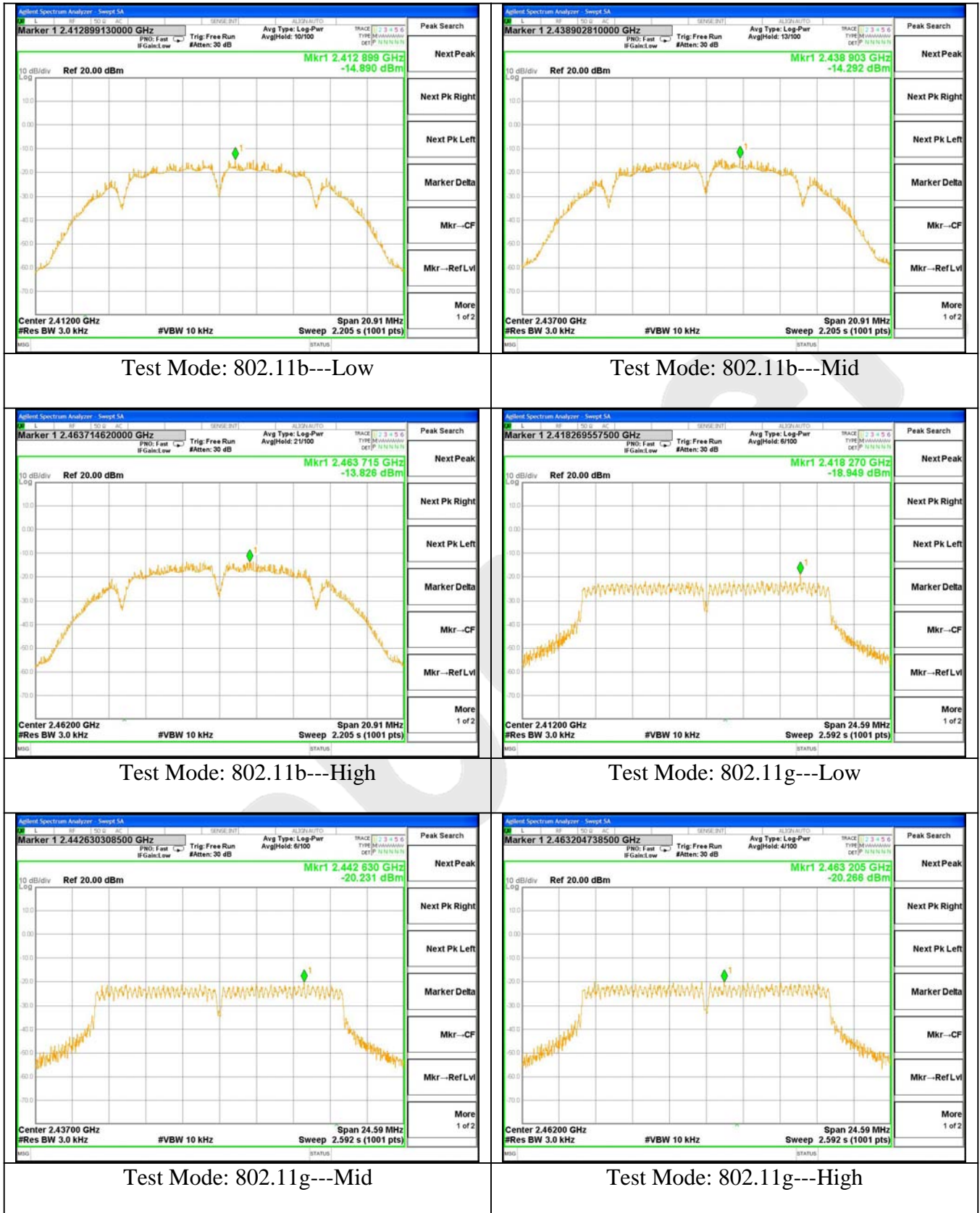



Onboard Antenna

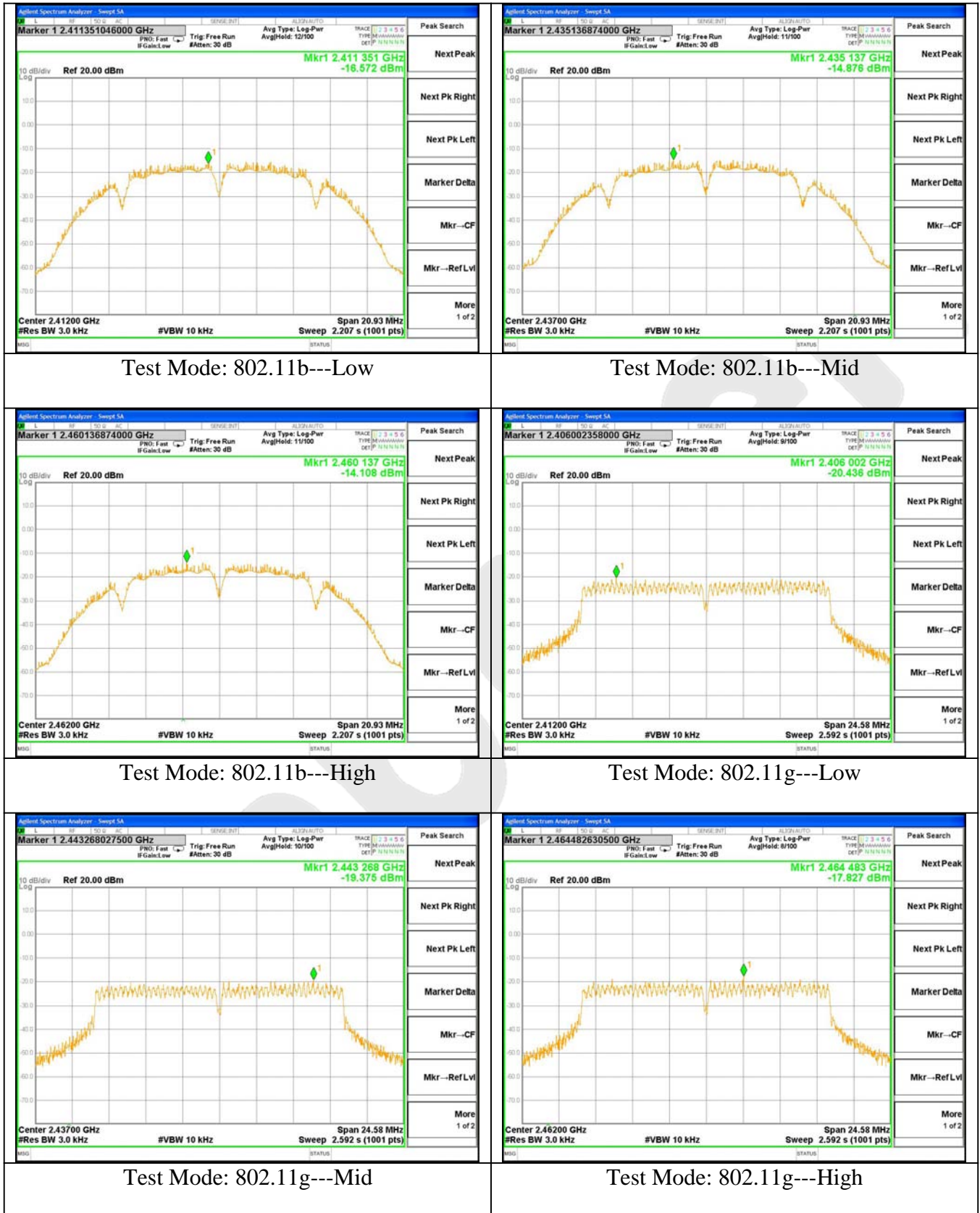



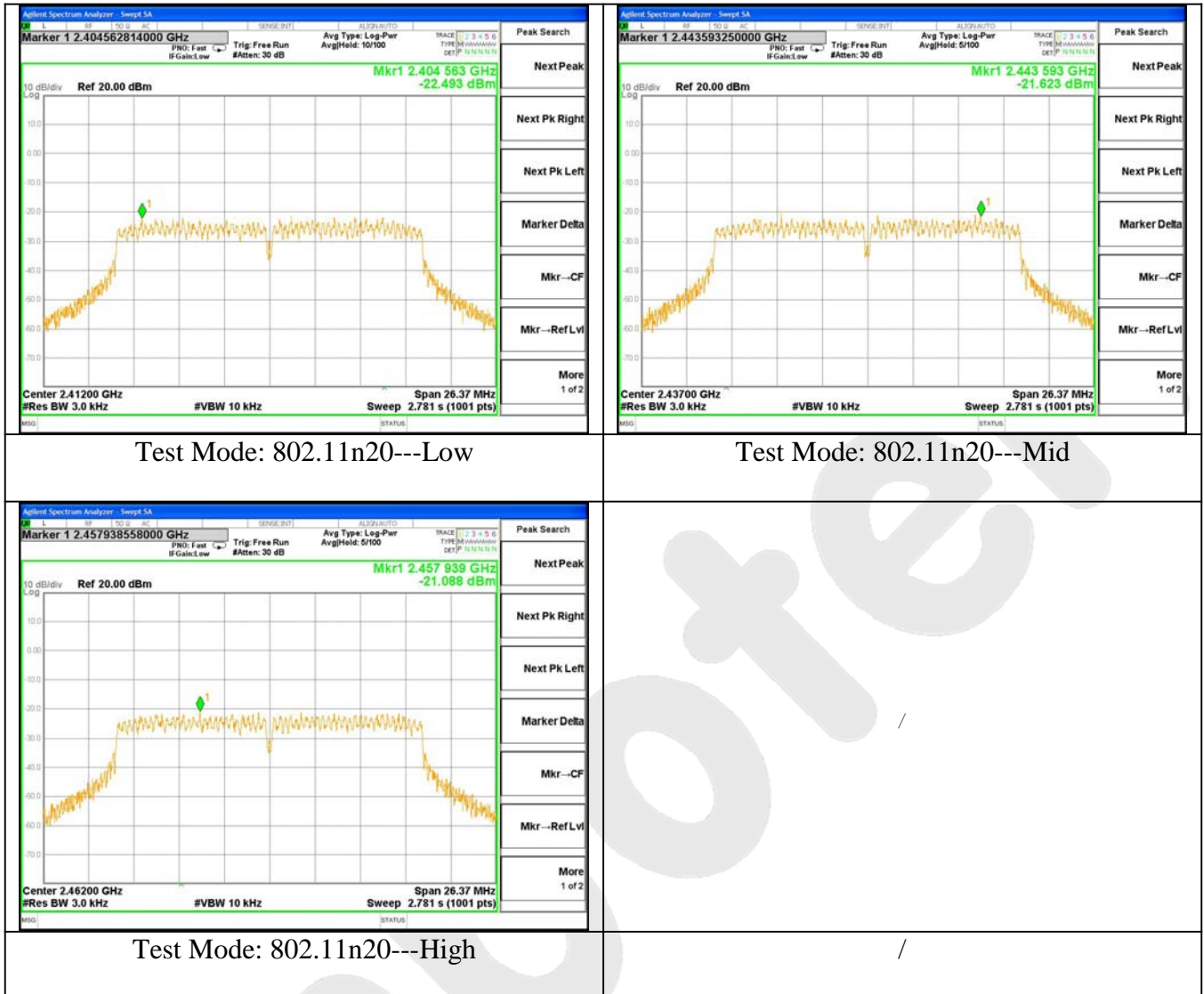

#### 4.6. Radiated Emissions

##### 4.6.1.1. Test Limits (< 30 MHz)

Frequency (MHz)	Field Strength (microvolts/meter)	Measurement Distance (meter)
0.009-0.490	2400/F(kHz)	300
0.490-1.705	24000/F(kHz)	30
1.705-30.0	30	30

##### 4.6.1.2. Test Limits ( $\geq$ 30 MHz)

FIELD STRENGTH of Fundamental: @3M	FIELD STRENGTH of Harmonics	S15.209 30 - 88 MHz	40 dBuV/m
902-928 MHz		88 - 216 MHz	43.5
2.4-2.4835 GHz		216 - 960 MHz	46
94 dB $\mu$ V/m @3m	54 dB $\mu$ V/m @3m	ABOVE 960 MHz	54dBuV/m

In any 100 kHz bandwidth outside the frequency band in which the spread spectrum or digitally modulated intentional radiator is operating, the radio frequency power that is produced by the intentional radiator shall be at least 20 dB below that in the 100 kHz bandwidth within the band that contains the highest level of the desired power, based on either an RF conducted or a radiated measurement. Attenuation below the general limits specified in Section 15.209(a) is not required. In addition, radiated emissions which fall in the restricted bands, as defined in Section 15.205(a), must also comply with the radiated emission limits specified in Section 15.209(a) (see Section 15.205(c)).

#### Test Equipment

Item	Equipment	Manufacturer	Model No.	Serial No.	Last Cal.	Cal. Interval
1.	Spectrum Analysis	Agilent	E4407B	US39390582	Apr. 17, 2015	1 Year
2.	Preamplifier	Instruments corporation	EMC011830	980100	Apr. 17, 2015	1 Year
3.	EMI Test Receiver	Rohde & Schwarz	ESPI	101604	Apr. 17, 2015	1 Year
4.	Double Ridged Horn Antenna	Instruments corporation	GTH-0118	351600	Apr. 20, 2015	1 Year
5.	Bilog Broadband Antenna	Schwarzbeck	VULB9163	VULB 9163-289	Apr. 20, 2015	1 Year
6.	Pre-amplifier	SONOMA	310N	186860	Apr. 17, 2015	1 Year
7.	EMI Test Software EZ-EMC	SHURPLE	N/A	N/A	N/A	N/A
8.	Power Sensor	DAER	RPR3006W	15I00041SN046	Jun 30, 2015	1 Year
9.	MXA Spectrum Analysis	Agilent	N9020A	MY51170037	Jun 30, 2015	1 Year
10.	MXG RF Vector Signal Generator	Agilent	N5182A	MY48180656	Jun 30, 2015	1 Year
11.	Signal Generator	Agilent	E4421B	MY41000743	Jun 30, 2015	1 Year
12.	DC Power supply	IV	IV-8080	YQSB0096	Jun 30, 2015	1 Year
13.	TEMP&HUMI PROGRAMMABLE CHAMBER	Bell Group	BE-THK-15 0M8	SE-0137	Mar 16, 2015	1 Year



4.6.2. Test Configuration:

4.6.2.1. 9k to 30MHz emissions:

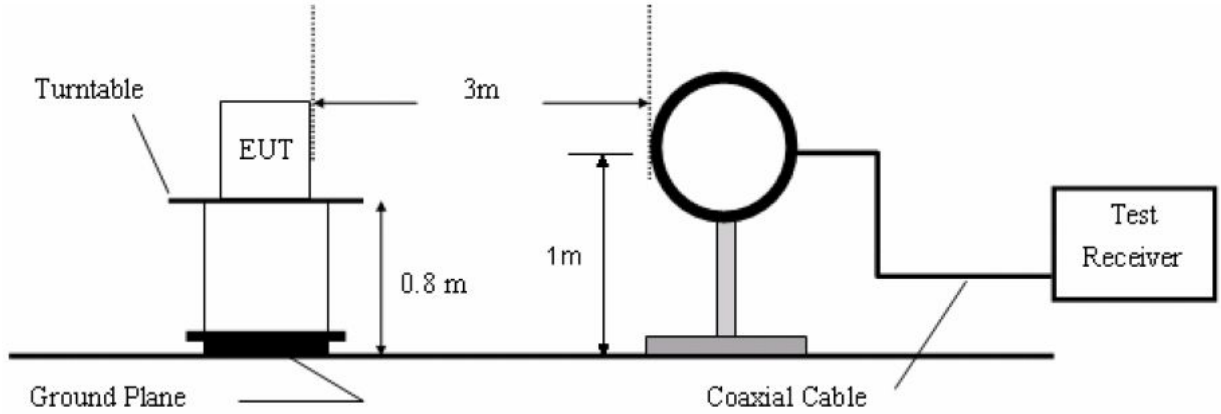

4.6.2.2. 30M to 1G emissions:

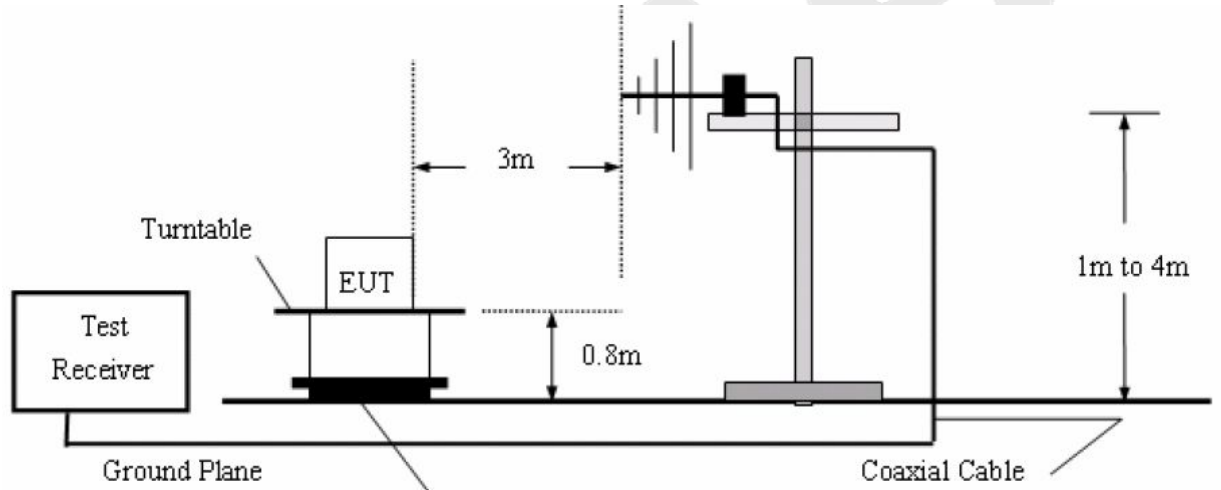

4.6.2.3. 1G to 40G emissions:

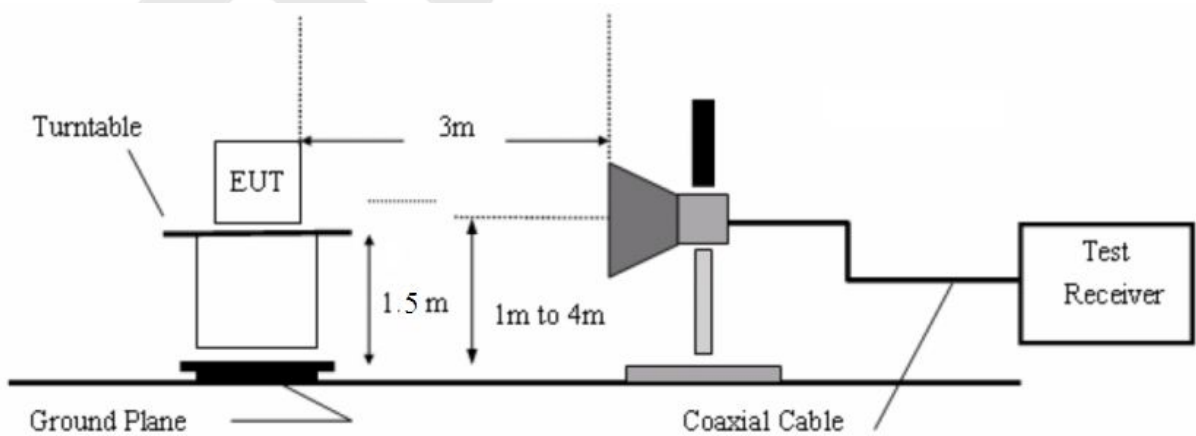

#### 4.6.3. Test Procedure

For below 1GHz: The EUT is placed on a turntable, which is 0.8m above the ground plane.  
For above 1GHz: The EUT is placed on a turntable, which is 1.5m above the ground plane.  
The turn table can rotate 360 degrees to determine the position of the maximum emission level.  
The EUT is set 3 meters away from the receiving antenna which is mounted on a antenna tower.  
The antenna can be moved up and down from 1 to 4 meters to find out the maximum emission level. Both horizontal and vertical polarization of the antenna are set on test.

Measurements are made on 9KHz to 30MHz and 30MHz to 26GHz range with the transmitter set to the lowest, middle, and highest channels.

All readings from 30MHz to 1GHz are quasi-peak values with a resolution bandwidth of 120kHz. All reading are above 1GHz, peak & average values with a resolution bandwidth of 1MHz.

The EUT is tested in 9\*6\*6 Chamber. The device is evaluated in xyz orientation.

The test results are listed in Section 4.6.4.

#### 4.6.4. Test Results

Please refer to the following pages. Only the worst case (x orientation).

The test results of above 18000MHz are attenuated more than 20dB below the permissible limits, so the results don't record in the report.

Job No.:	011508174I	Polarization:	Horizontal
Standard:	(RE)FCC PART15 C _3m	Power Source:	AC 120V, 60Hz for adapter
Test item:	Radiation Test	Temp.(C)/Hum.(%RH):	24.3(C)/55%RH
Test Mode:	ON	Distance:	3m

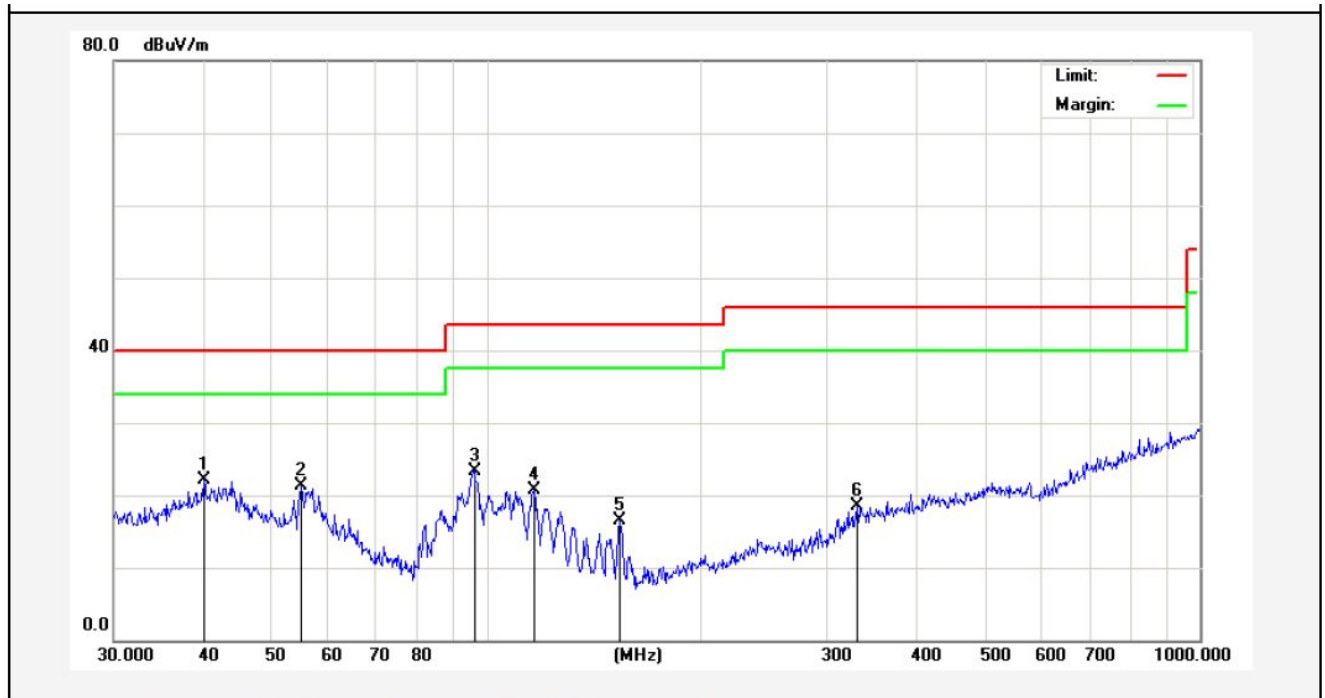

No.	Freq. (MHz)	Reading (dBuV/m)	Factor (dB/m)	Result (dBuV/m)	Limit (dBuV/)	Over Limit (dB)	Detector	Height (cm)	degree (deg)	Remark
1	40.1347	32.50	-10.42	22.08	40.00	-17.92	peak			
2	54.8348	36.27	-14.91	21.36	40.00	-18.64	peak			
3	96.0986	44.24	-20.97	23.27	43.50	-20.23	peak			
4	116.5401	41.73	-21.09	20.64	43.50	-22.86	peak			
5	153.7385	39.73	-23.17	16.56	43.50	-26.94	peak			
6	331.3546	33.20	-14.72	18.48	46.00	-27.52	peak			

Job No.:	011508174I	Polarization:	Vertical
Standard:	(RE)FCC PART15 C_3m	Power Source:	AC 120V, 60Hz for adapter
Test item:	Radiation Test	Temp.(C)/Hum.(%RH):	24.3(C)/55%RH
Test Mode:	ON	Distance:	3m

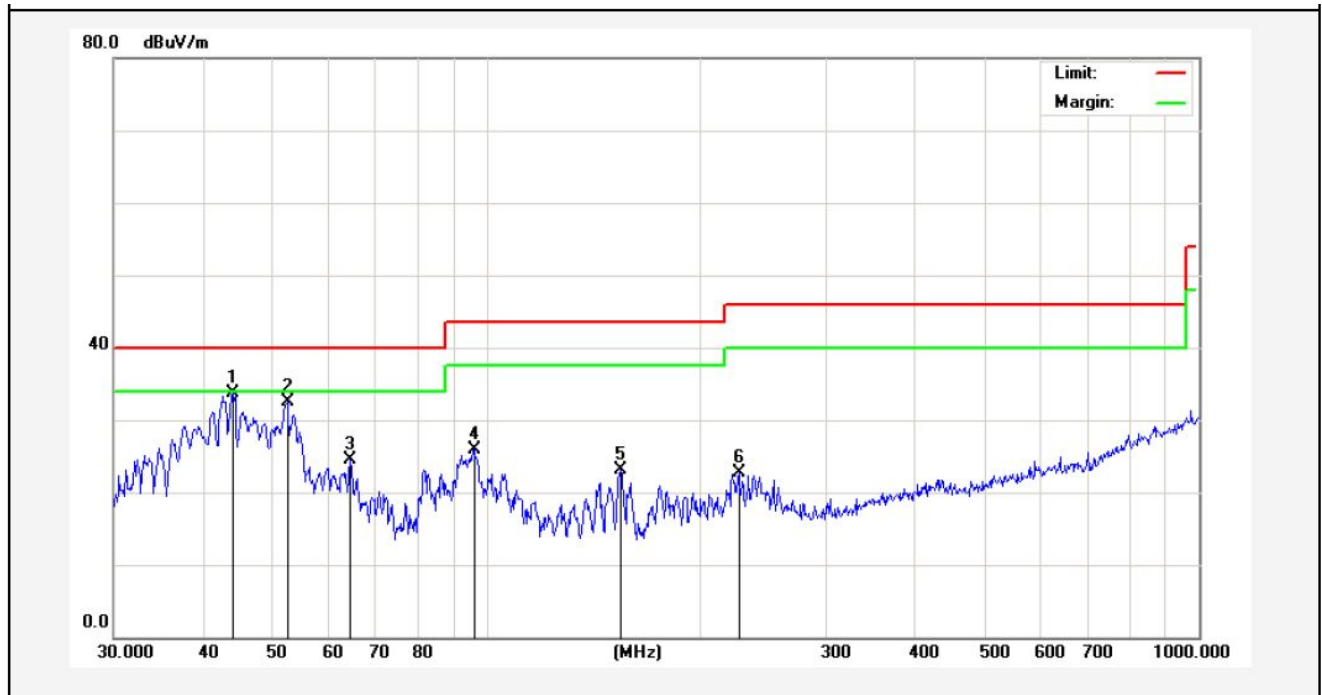

No.	Freq. (MHz)	Reading (dBuV/m)	Factor (dB/m)	Result (dBuV/m)	Limit (dBuV/)	Over Limit (dB)	Detector	Height (cm)	degree (deg)	Remark
1	44.1202	45.77	-11.98	33.79	40.00	-6.21	peak			
2	52.5753	47.19	-14.75	32.44	40.00	-7.56	peak			
3	64.4331	41.70	-17.24	24.46	40.00	-15.54	peak			
4	96.0986	41.94	-15.97	25.97	43.50	-17.53	peak			
5	154.2786	41.30	-18.14	23.16	43.50	-20.34	peak			
6	226.0994	37.53	-14.80	22.73	46.00	-23.27	peak			

Job No.:	011508174I	Polarization:	Horizontal
Standard:	(RE)FCC PART15 C_3m	Power Source:	AC 120V, 60Hz for adapter
Test item:	Radiation Test	Temp.(C)/Hum.(%RH):	24.3(C)/55%RH
Note:	External Antenna 802.11b(2412MHz)	Distance:	3m

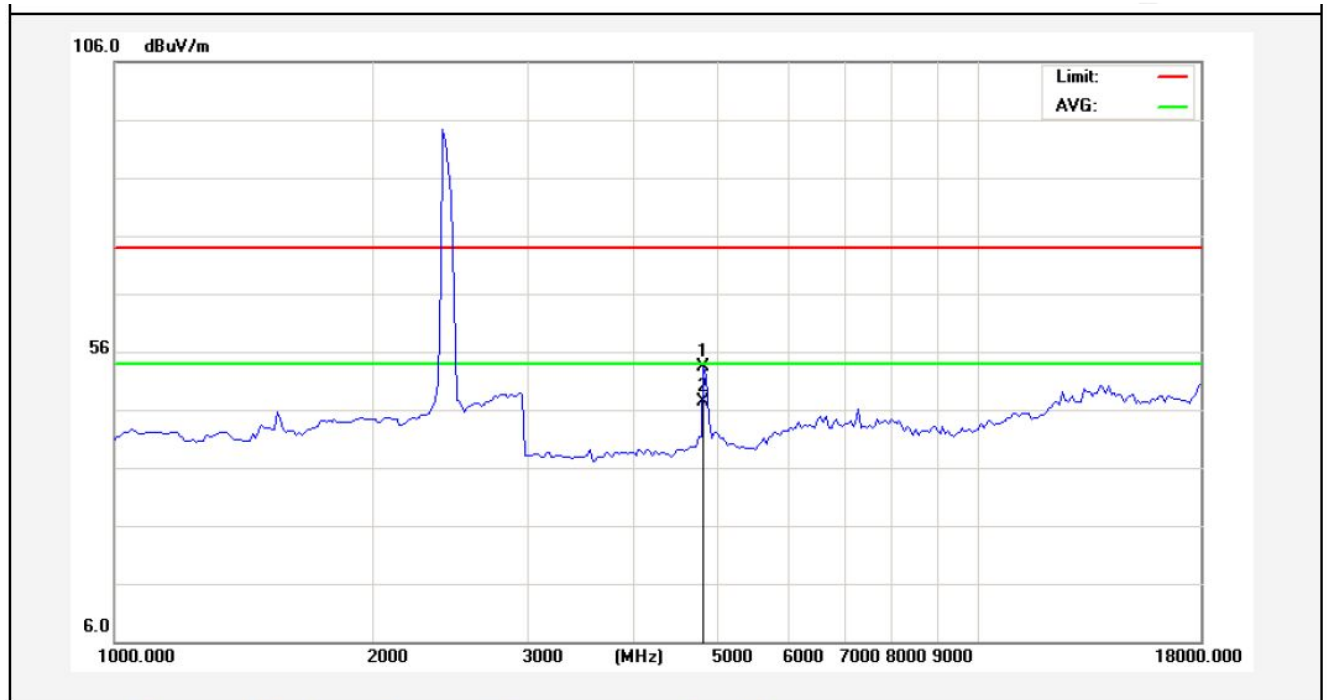

No.	Freq. (MHz)	Reading (dBuV/m)	Factor (dB/m)	Result (dBuV/m)	Limit (dBuV/)	Over Limit (dB)	Detector	Height (cm)	degree (deg)	Remark
1	4825.000	50.13	3.34	53.47	74.00	-20.53	peak			
2	4825.000	44.02	3.34	47.36	54.00	-6.64	AVG			

AM

Job No.:	011508174I	Polarization:	Vertical
Standard:	(RE)FCC PART15 C _3m	Power Source:	AC 120V, 60Hz for adapter
Test item:	Radiation Test	Temp.(C)/Hum.(%RH):	24.3(C)/55%RH
Note:	External Antenna 802.11b(2412MHz)	Distance:	3m

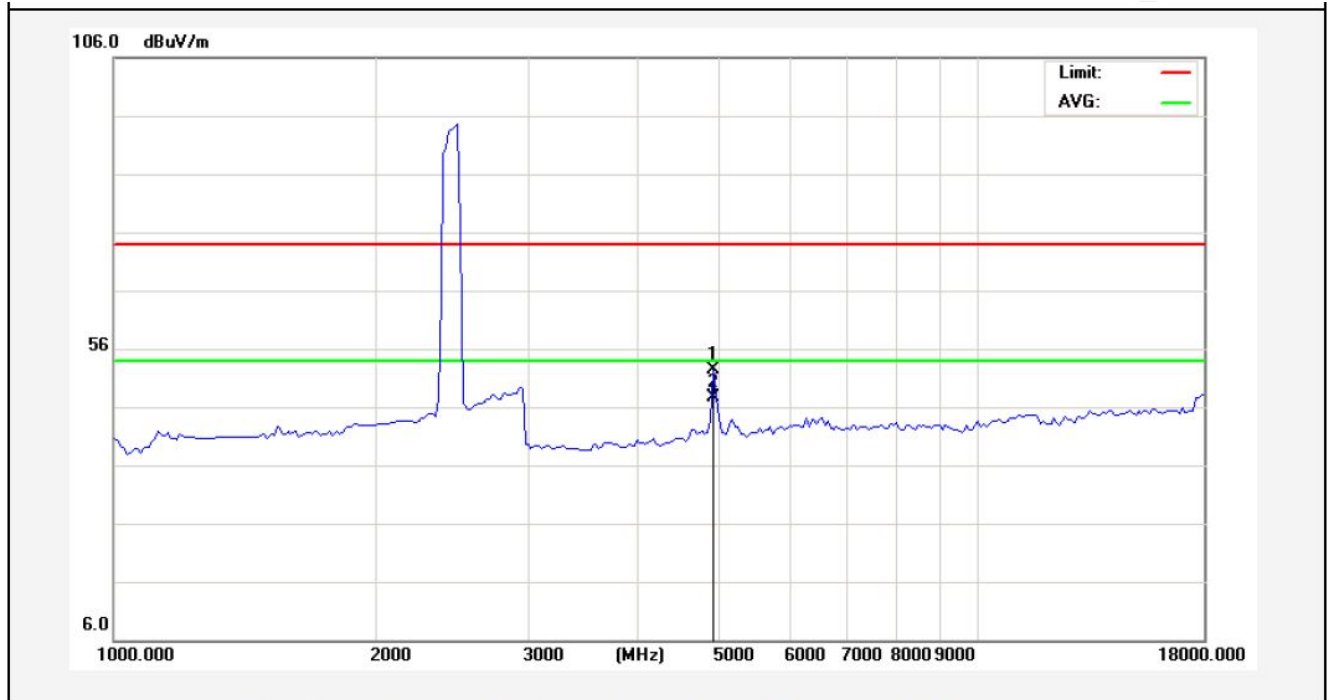

No.	Freq. (MHz)	Reading (dBuV/m)	Factor (dB/m)	Result (dBuV/m)	Limit (dBuV/)	Over Limit (dB)	Detector	Height (cm)	degree (deg)	Remark
1	4910.000	49.00	3.49	52.49	74.00	-21.51	peak			
2	4910.000	44.14	3.49	47.63	54.00	-6.37	AVG			

A.M.



Job No.:	011508174I	Polarization:	Horizontal
Standard:	(RE)FCC PART15 C _3m	Power Source:	AC 120V, 60Hz for adapter
Test item:	Radiation Test	Temp.(C)/Hum.(%RH):	24.3(C)/55%RH
Note:	External Antenna 802.11b(2437MHz)	Distance:	3m

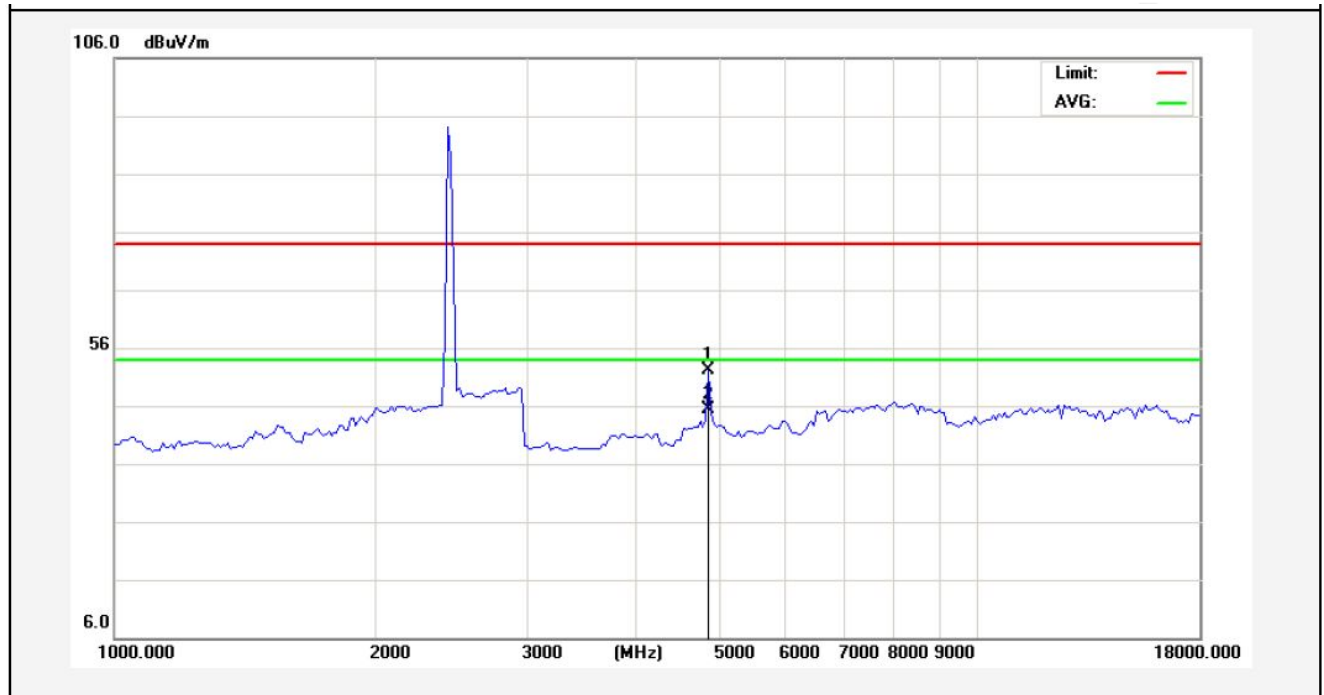

No.	Freq. (MHz)	Reading (dBuV/m)	Factor (dB/m)	Result (dBuV/m)	Limit (dBuV/)	Over Limit (dB)	Detector	Height (cm)	degree (deg)	Remark
1	4867.500	48.64	3.41	52.05	74.00	-21.95	peak			
2	4867.500	41.98	3.41	45.39	54.00	-8.61	AVG			

Job No.:	011508174I	Polarization:	Vertical
Standard:	(RE)FCC PART15 C _3m	Power Source:	AC 120V, 60Hz for adapter
Test item:	Radiation Test	Temp.(C)/Hum.(%RH):	24.3(C)/55%RH
Note:	External Antenna 802.11b(2437MHz)	Distance:	3m

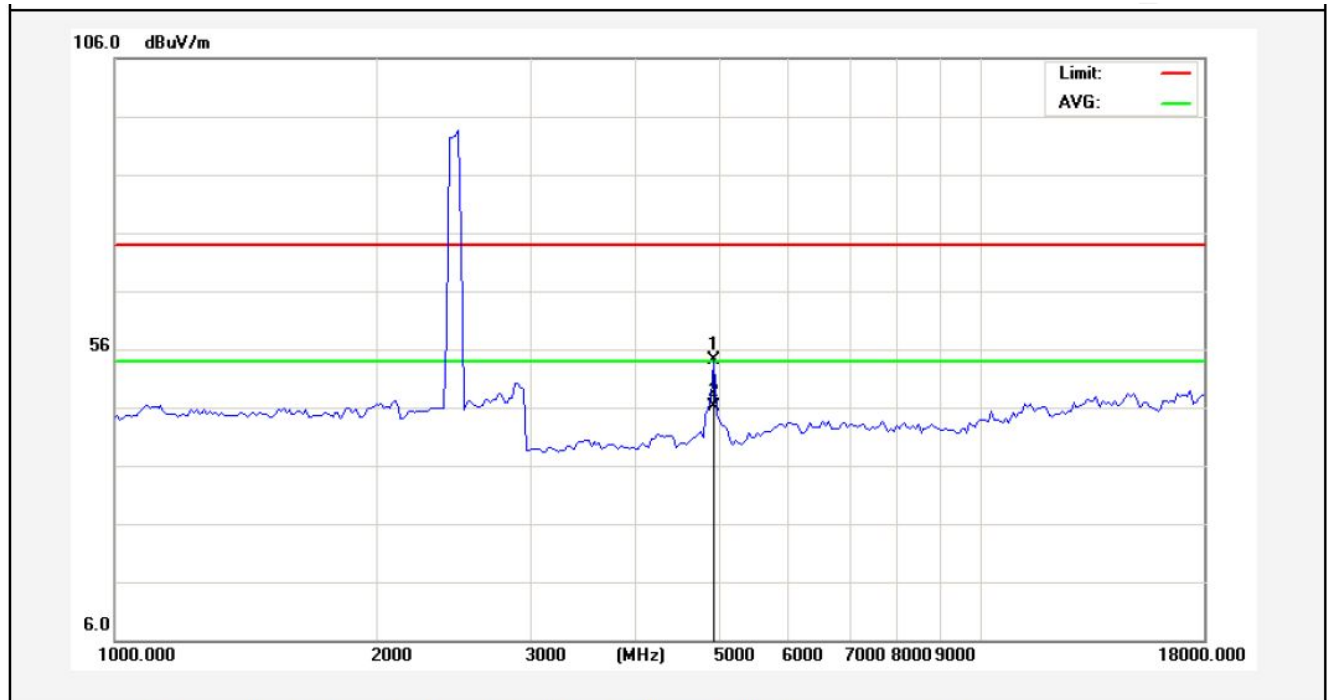

No.	Freq. (MHz)	Reading (dBuV/m)	Factor (dB/m)	Result (dBuV/m)	Limit (dBuV/)	Over Limit (dB)	Detector	Height (cm)	degree (deg)	Remark
1	4910.000	50.60	3.49	54.09	74.00	-19.91	peak			
2	4910.000	42.59	3.49	46.08	54.00	-7.92	AVG			

Job No.:	011508174I	Polarization:	Horizontal
Standard:	(RE)FCC PART15 C_3m	Power Source:	AC 120V, 60Hz for adapter
Test item:	Radiation Test	Temp.(C)/Hum.(%RH):	24.3(C)/55%RH
Note:	External Antenna 802.11b(2462MHz)	Distance:	3m

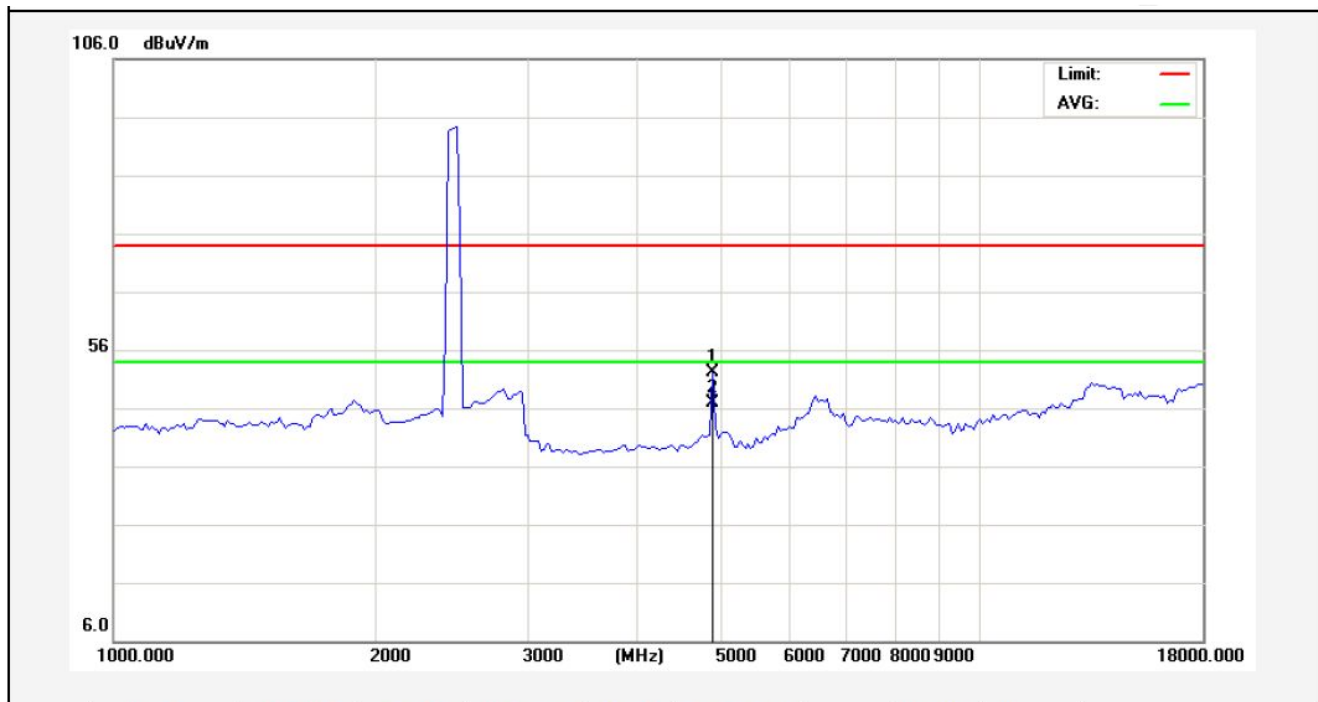

No.	Freq. (MHz)	Reading (dBuV/m)	Factor (dB/m)	Result (dBuV/m)	Limit (dBuV/)	Over Limit (dB)	Detector	Height (cm)	degree (deg)	Remark
1	4910.000	48.67	3.49	52.16	74.00	-21.84	peak			
2	4910.000	43.42	3.49	46.91	54.00	-7.09	AVG			

A.M.

Job No.:	011508174I	Polarization:	Vertical
Standard:	(RE)FCC PART15 C _3m	Power Source:	AC 120V, 60Hz for adapter
Test item:	Radiation Test	Temp.(C)/Hum.(%RH):	24.3(C)/55%RH
Note:	External Antenna 802.11b(2462MHz)	Distance:	3m

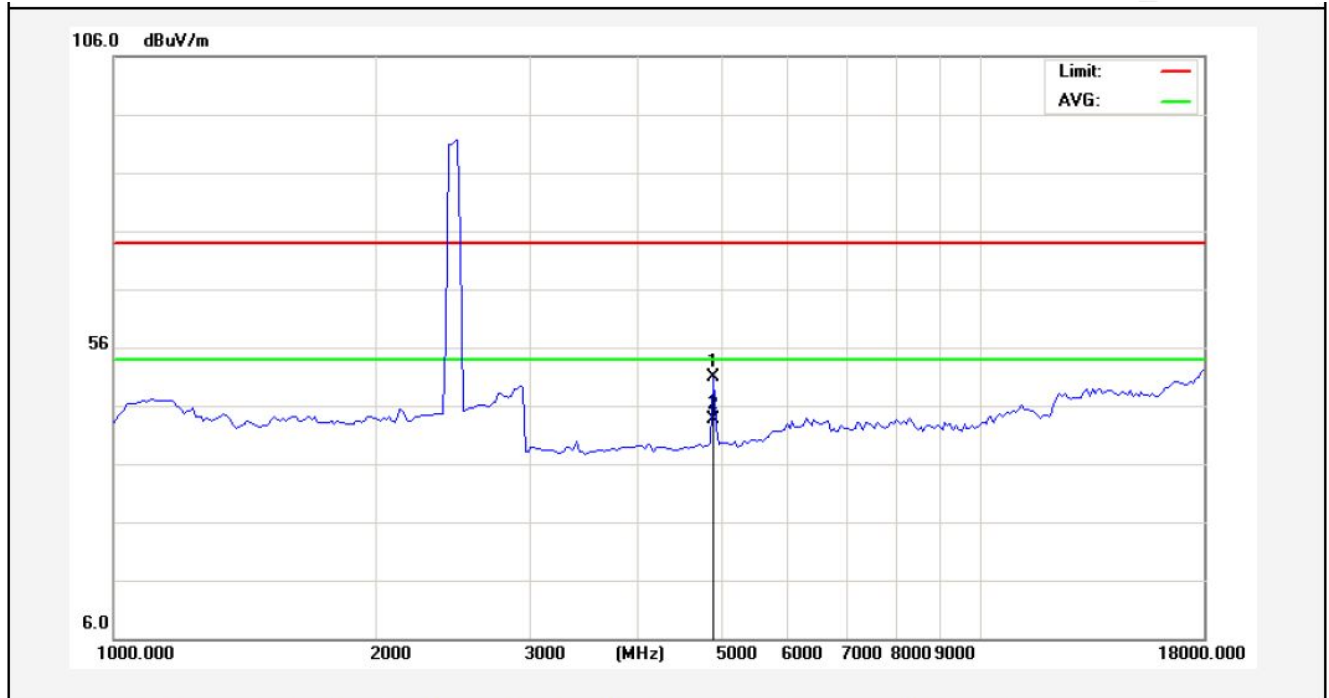

No.	Freq. (MHz)	Reading (dBuV/m)	Factor (dB/m)	Result (dBuV/m)	Limit (dBuV/)	Over Limit (dB)	Detector	Height (cm)	degree (deg)	Remark
1	4910.000	47.32	3.49	50.81	74.00	-23.19	peak			
2	4910.000	40.20	3.49	43.69	54.00	-10.31	AVG			

AM

Job No.:	011508174I	Polarization:	Horizontal
Standard:	(RE)FCC PART15 C _3m	Power Source:	AC 120V, 60Hz for adapter
Test item:	Radiation Test	Temp.(C)/Hum.(%RH):	24.3(C)/55%RH
Note:	Onboard Antenna 802.11b(2412MHz)	Distance:	3m

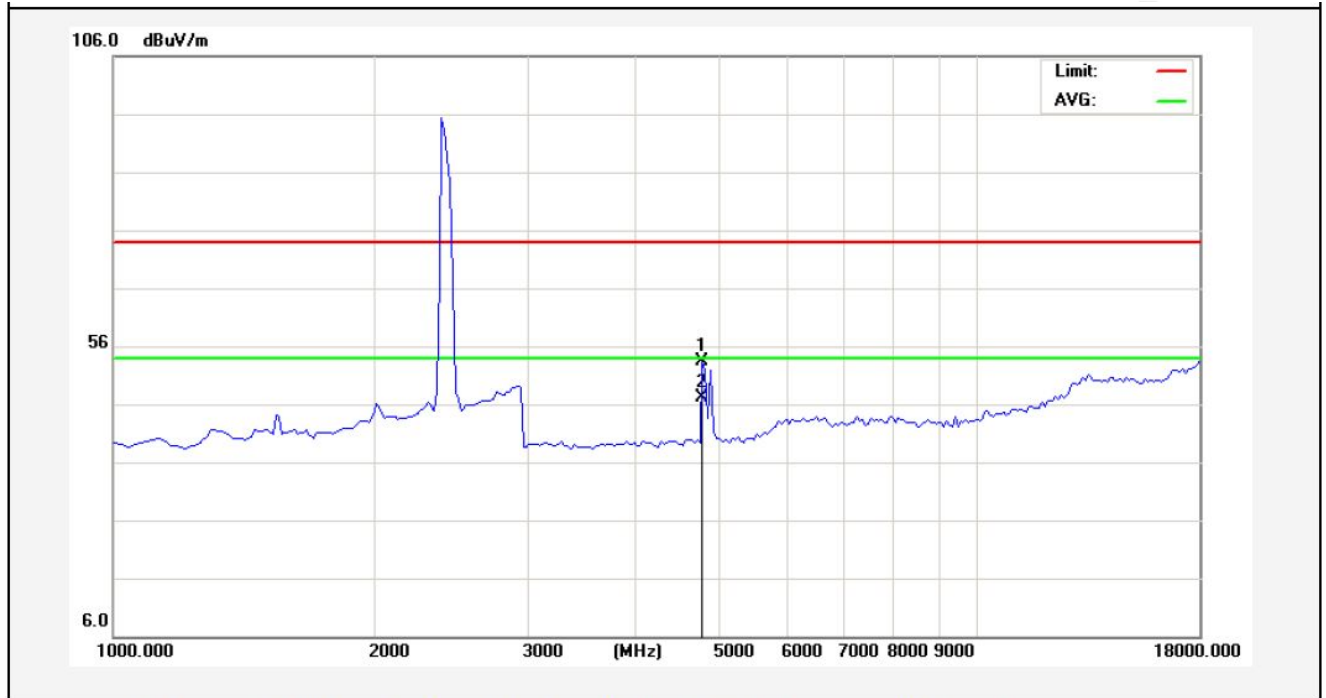

No.	Freq. (MHz)	Reading (dBuV/m)	Factor (dB/m)	Result (dBuV/m)	Limit (dBuV/)	Over Limit (dB)	Detector	Height (cm)	degree (deg)	Remark
1	4825.000	50.05	3.34	53.39	74.00	-20.61	peak			
2	4825.000	43.68	3.34	47.02	54.00	-6.98	AVG			

A.M.

Job No.:	011508174I	Polarization:	Vertical
Standard:	(RE)FCC PART15 C _3m	Power Source:	AC 120V, 60Hz for adapter
Test item:	Radiation Test	Temp.(C)/Hum.(%RH):	24.3(C)/55%RH
Note:	Onboard Antenna 802.11b(2412MHz)	Distance:	3m

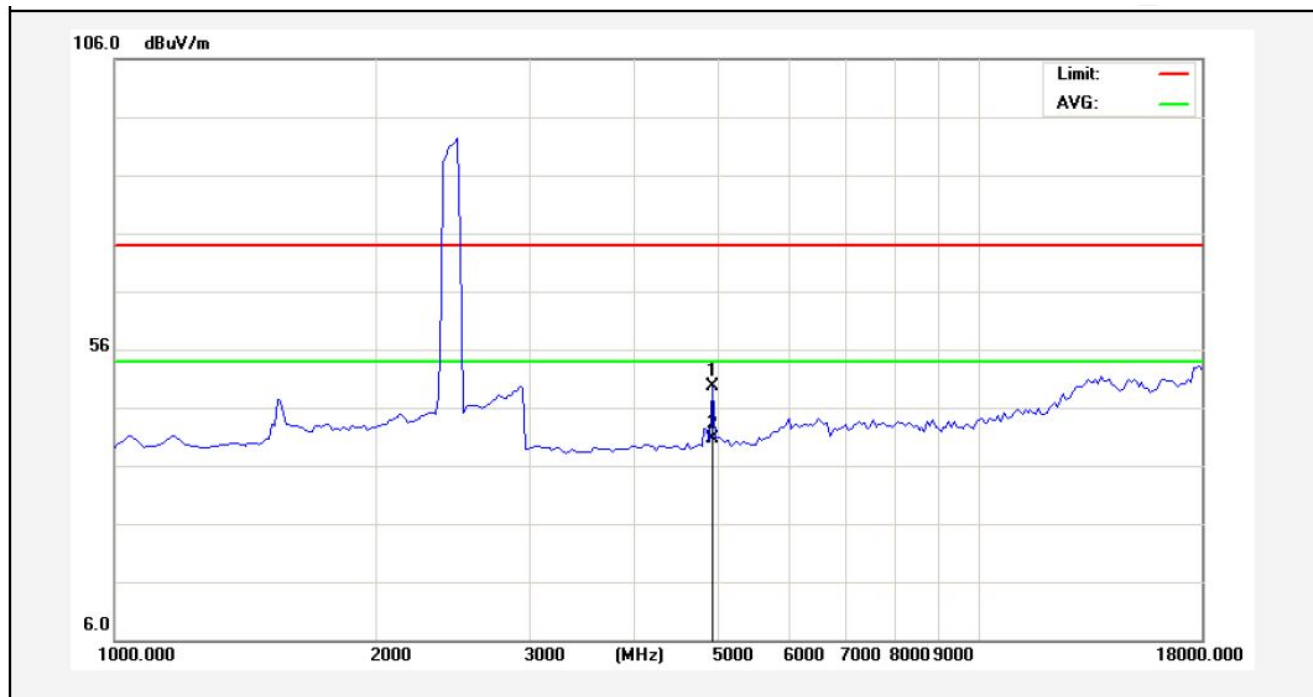

No.	Freq. (MHz)	Reading (dBuV/m)	Factor (dB/m)	Result (dBuV/m)	Limit (dBuV/)	Over Limit (dB)	Detector	Height (cm)	degree (deg)	Remark
1	4910.000	46.05	3.49	49.54	74.00	-24.46	peak			
2	4910.000	37.13	3.49	40.62	54.00	-13.38	AVG			

A.M.



Job No.:	011508174I	Polarization:	Horizontal
Standard:	(RE)FCC PART15 C _3m	Power Source:	AC 120V, 60Hz for adapter
Test item:	Radiation Test	Temp.(C)/Hum.(%RH):	24.3(C)/55%RH
Note:	Onboard Antenna 802.11b(2437MHz)	Distance:	3m

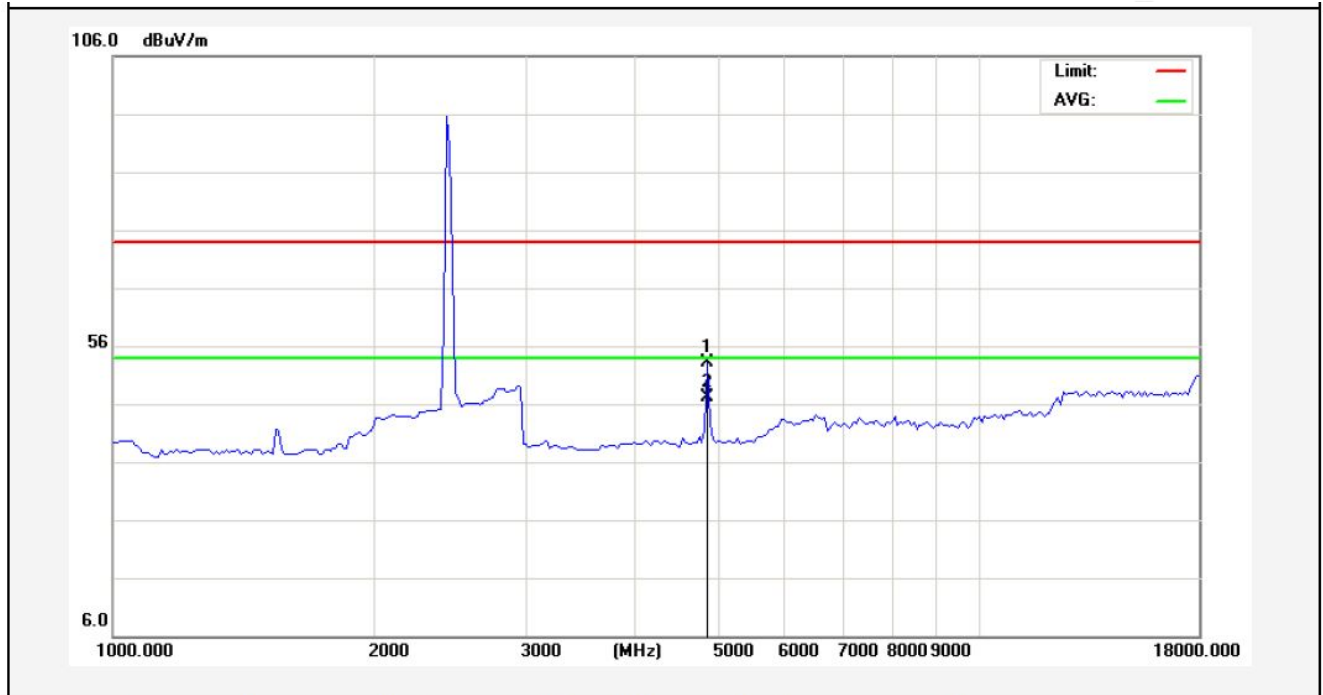

No.	Freq. (MHz)	Reading (dBuV/m)	Factor (dB/m)	Result (dBuV/m)	Limit (dBuV/)	Over Limit (dB)	Detector	Height (cm)	degree (deg)	Remark
1	4867.500	49.64	3.41	53.05	74.00	-20.95	peak			
2	4867.500	43.69	3.41	47.10	54.00	-6.90	AVG			

<b>Job No.:</b>	<b>011508174I</b>	<b>Polarization:</b>	<b>Vertical</b>
<b>Standard:</b>	<b>(RE)FCC PART15 C _3m</b>	<b>Power Source:</b>	<b>AC 120V, 60Hz for adapter</b>
<b>Test item:</b>	<b>Radiation Test</b>	<b>Temp.(C)/Hum.(%RH):</b>	<b>24.3(C)/55%RH</b>
<b>Note:</b>	<b>Onboard Antenna 802.11b(2437MHz)</b>	<b>Distance:</b>	<b>3m</b>

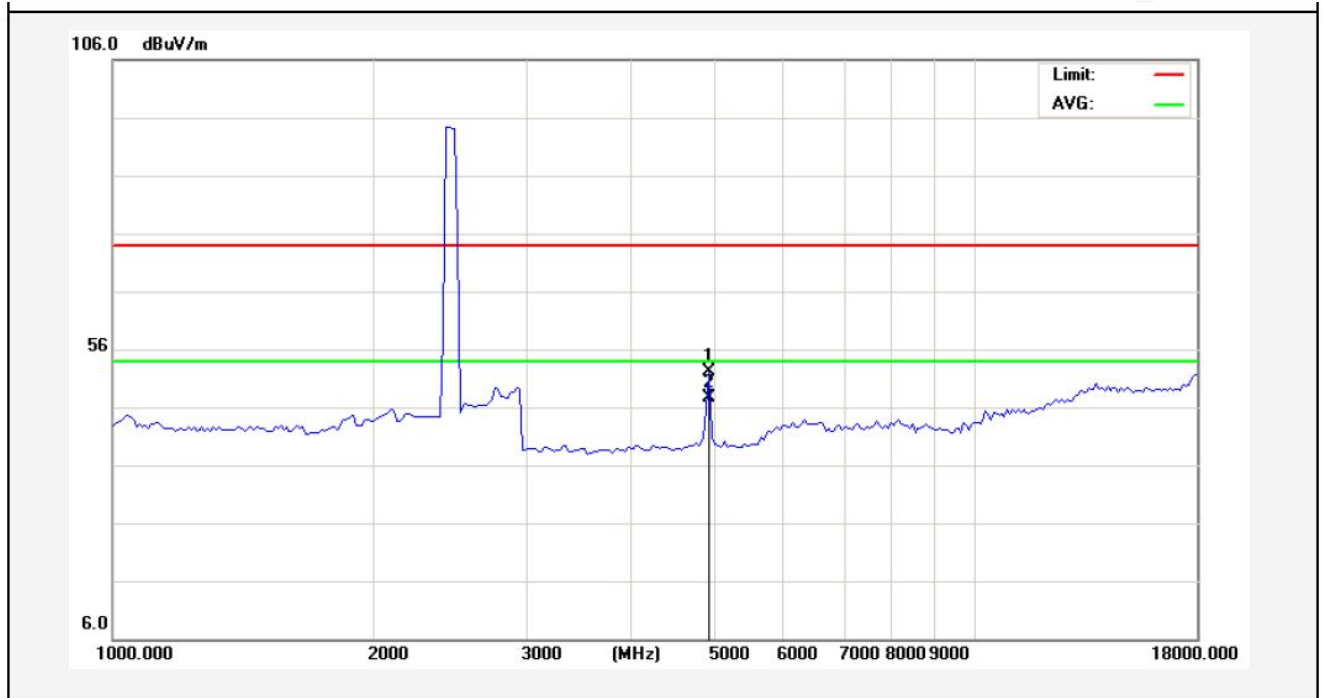

No.	Freq. (MHz)	Reading (dBuV/m)	Factor (dB/m)	Result (dBuV/m)	Limit (dBuV/)	Over Limit (dB)	Detector	Height (cm)	degree (deg)	Remark
1	4910.000	48.60	3.49	52.09	74.00	-21.91	peak			
2	4910.000	44.14	3.49	47.63	54.00	-6.37	AVG			

AM

Job No.:	011508174I	Polarization:	Horizontal
Standard:	(RE)FCC PART15 C_3m	Power Source:	AC 120V, 60Hz for adapter
Test item:	Radiation Test	Temp.(C)/Hum.(%RH):	24.3(C)/55%RH
Note:	Onboard Antenna 802.11b(2462MHz)	Distance:	3m

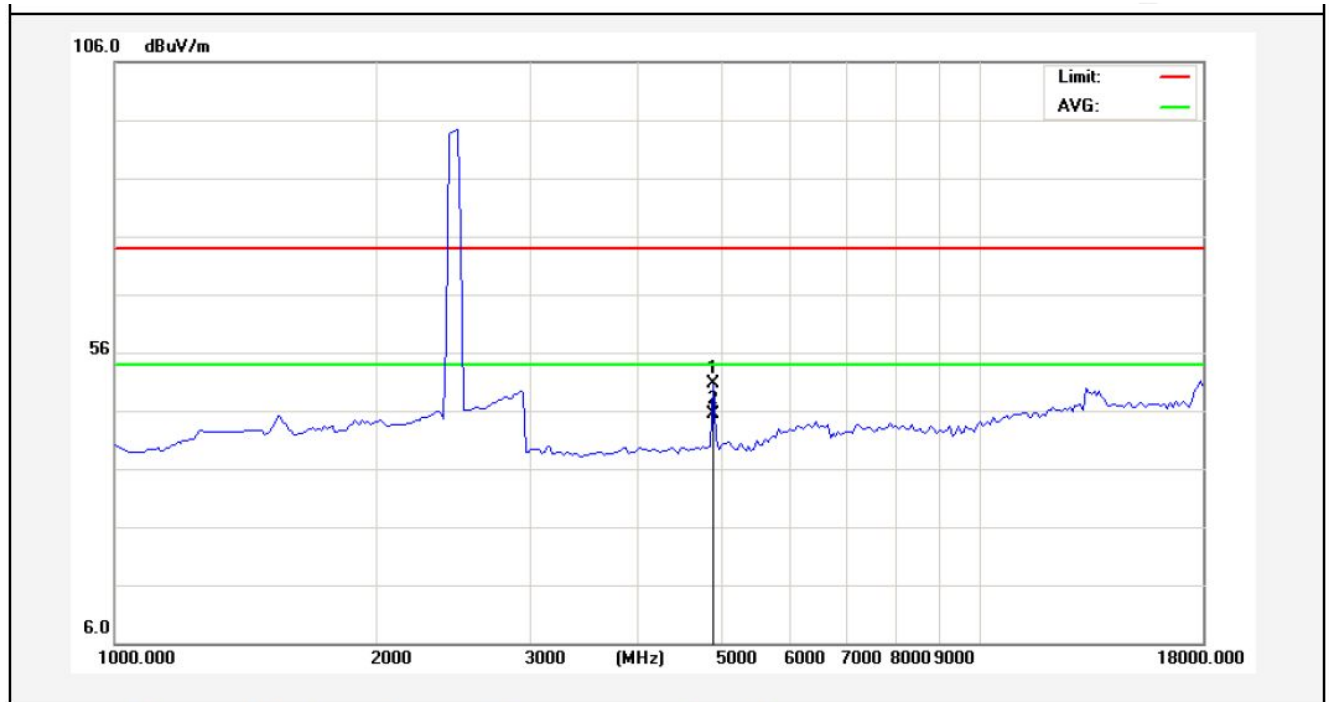

No.	Freq. (MHz)	Reading (dBuV/m)	Factor (dB/m)	Result (dBuV/m)	Limit (dBuV/)	Over Limit (dB)	Detector	Height (cm)	degree (deg)	Remark
1	4910.000	47.17	3.49	50.66	74.00	-23.34	peak			
2	4910.000	41.87	3.49	45.36	54.00	-8.64	AVG			

A.M.

<b>Job No.:</b>	<b>011508174I</b>	<b>Polarization:</b>	<b>Vertical</b>
<b>Standard:</b>	<b>(RE)FCC PART15 C _3m</b>	<b>Power Source:</b>	<b>AC 120V, 60Hz for adapter</b>
<b>Test item:</b>	<b>Radiation Test</b>	<b>Temp.(C)/Hum.(%RH):</b>	<b>24.3(C)/55%RH</b>
<b>Note:</b>	<b>Onboard Antenna 802.11b(2462MHz)</b>	<b>Distance:</b>	<b>3m</b>

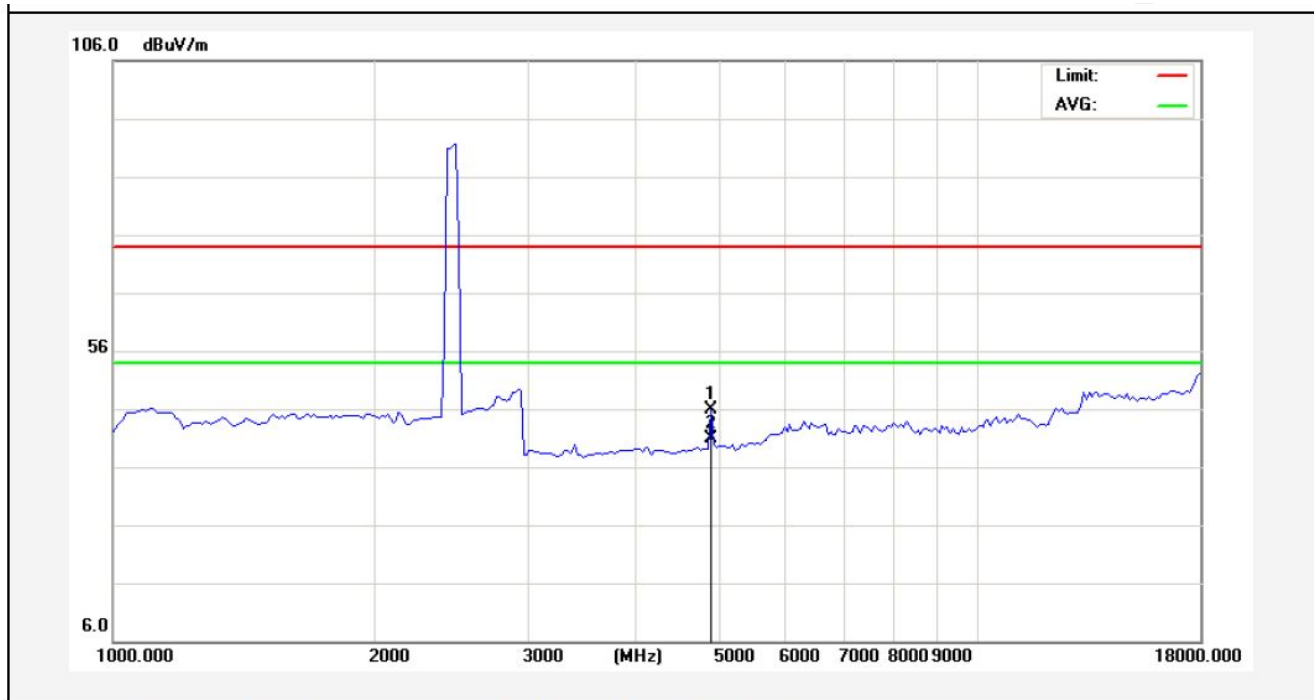

No.	Freq. (MHz)	Reading (dBuV/m)	Factor (dB/m)	Result (dBuV/m)	Limit (dBuV/)	Over Limit (dB)	Detector	Height (cm)	degree (deg)	Remark
1	4910.000	42.32	3.49	45.81	74.00	-28.19	peak			
2	4910.000	37.47	3.49	40.96	54.00	-13.04	AVG			

AM

## 5. ANTENNA APPLICATION

### 5.1. Antenna requirement

The EUT'S antenna is met the requirement of FCC part 15C section 15.203.

An intentional radiator shall be designed to ensure that no antenna other than that furnished by the responsible party shall be used with the device. The use of a permanently attached antenna or of an antenna that uses a unique coupling to the intentional radiator shall be considered sufficient to comply with the provisions of this section. The manufacturer may design the unit so that a broken antenna can be replaced by the user, but the use of a standard antenna jack or electrical connector is prohibited. This requirement does not apply to carrier current devices or to devices operated under the provisions of §15.211, §15.213, §15.217, §15.219, or §15.221. Further, this requirement does not apply to intentional radiators that must be professionally installed, such as perimeter protection systems and some field disturbance sensors, or to other intentional radiators which, in accordance with §15.31(d), must be measured at the installation site. However, the installer shall be responsible for ensuring that the proper antenna is employed so that the limits in this part are not exceeded.

### 5.2. Result

The EUT' s antenna used two antennas(external antenna/onboard antenna) which are permanently attached, The antenna's gain are 2.0dBi/0.5dBi and meets the requirement.

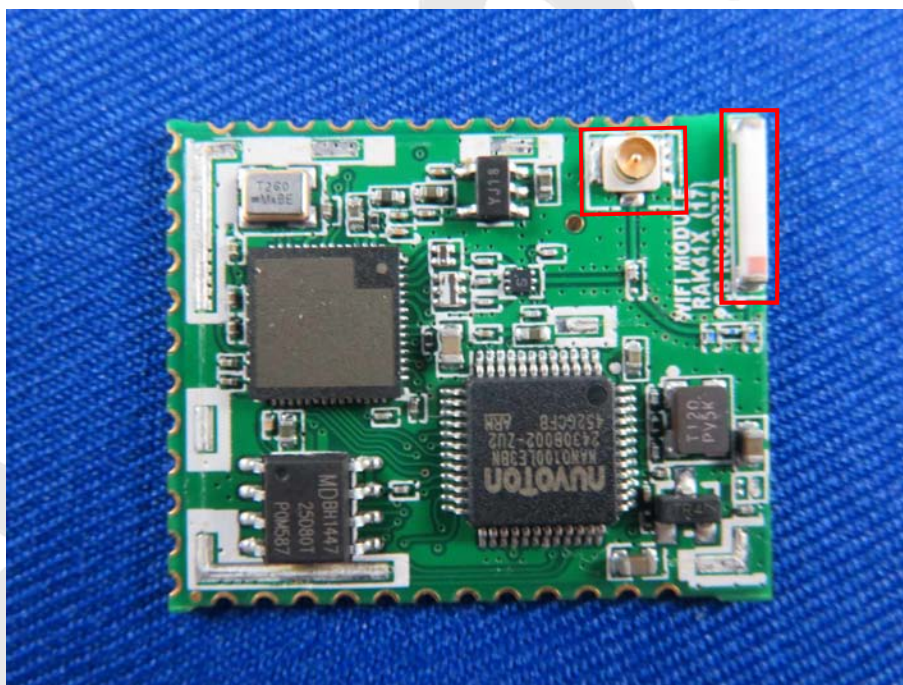



## 6. PHOTOGRAPH

### 6.1. Photo of Conducted Emission Measurement



### 6.2. Photo of Radiation Emission Test

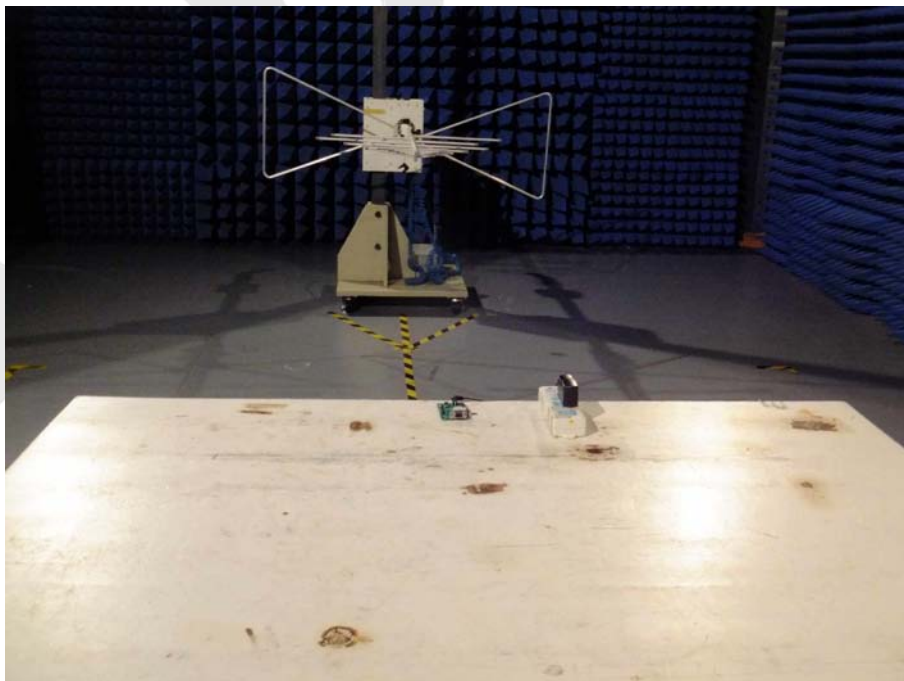





Anbotek

## APPENDIX I (EXTERNAL PHOTOS)

Figure 1  
The EUT-Front View

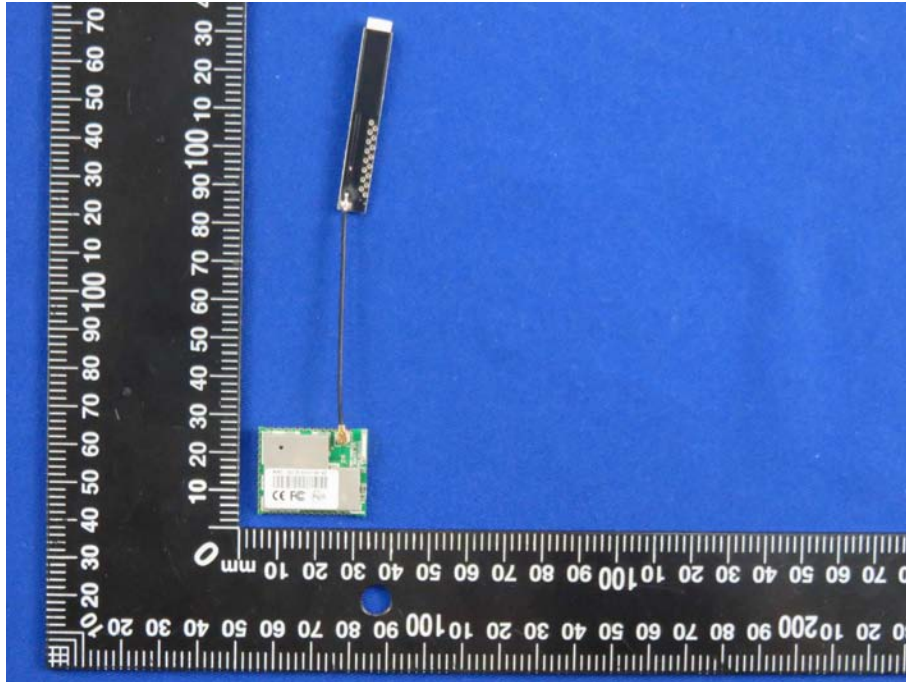

Figure 2  
The EUT-Front View

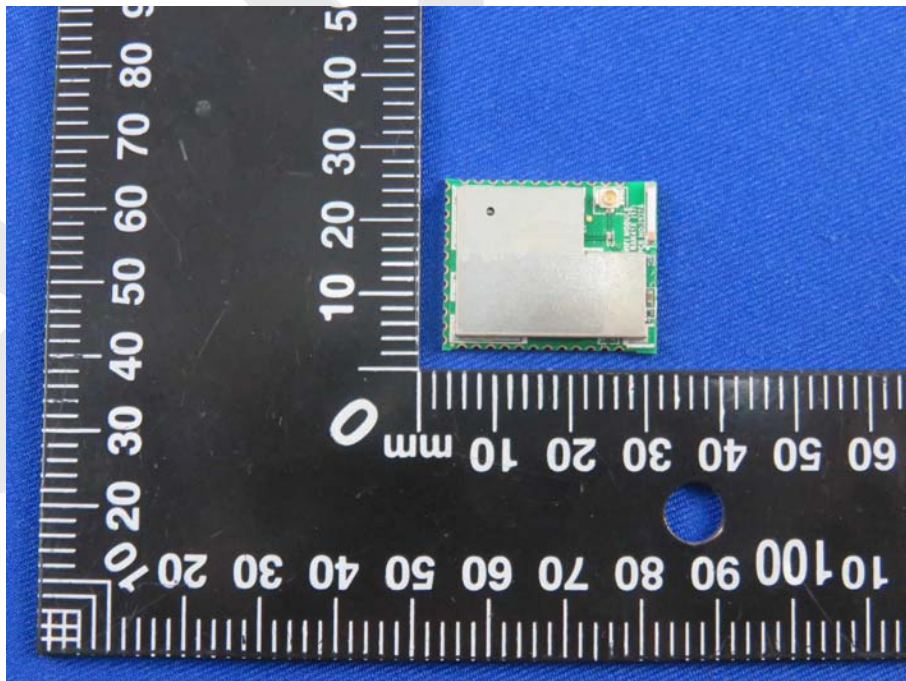
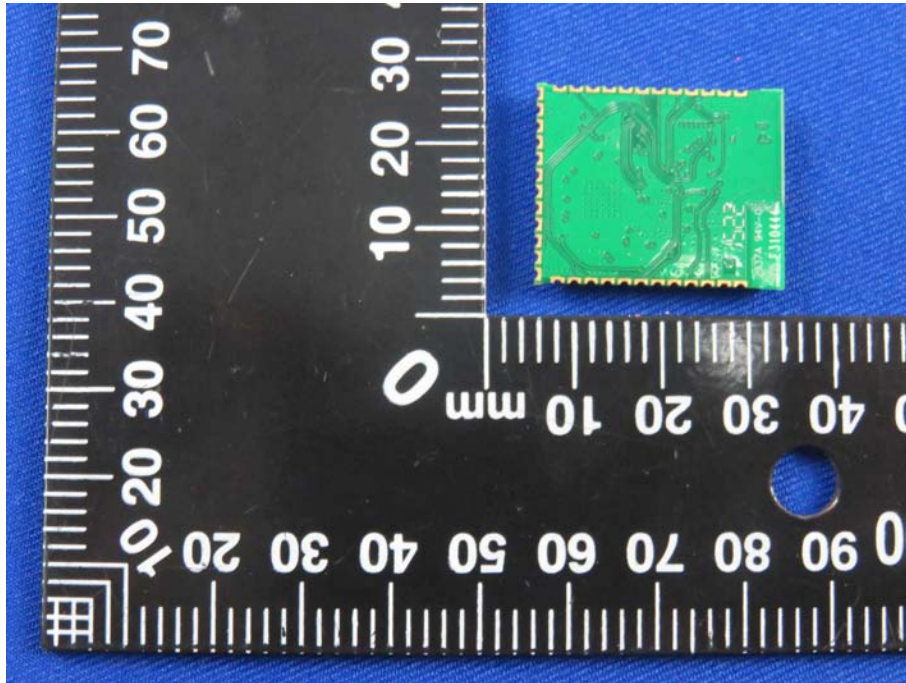

Figure 3  
The EUT-Back View





## APPENDIX II (INTERNAL PHOTOS)

Figure 4  
The EUT-Inside View

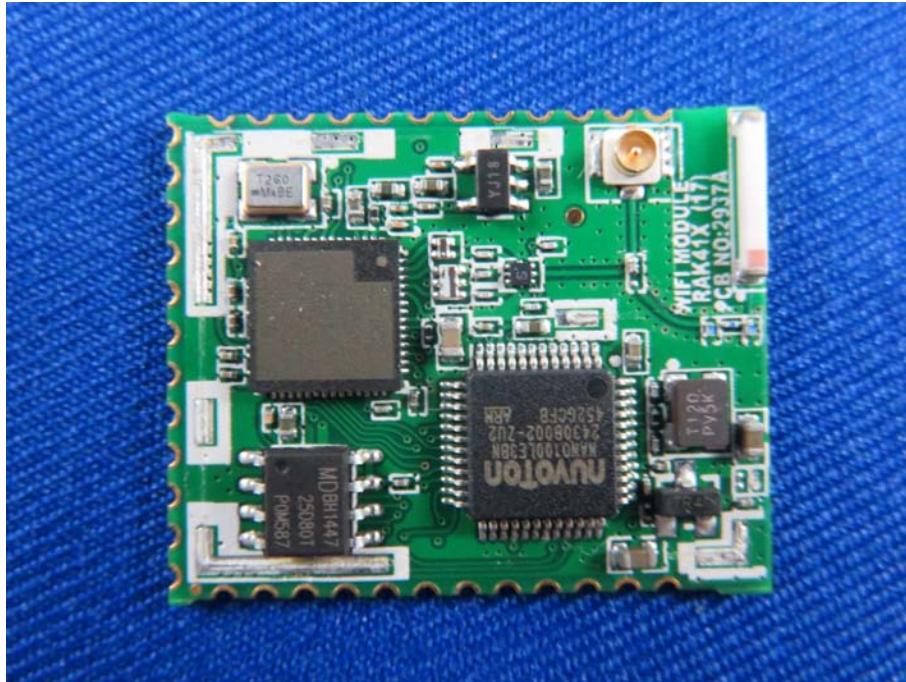

Figure 5  
The EUT-Inside View

