



APPLICATION SPECIFICATION

TITLE

WIFI 6E PCB CABLED BALANCED ANTENNA

TABLE OF CONTENTS

1.0 SCOPE

2.0 PRODUCT DESCRIPTION

3.0 APPLICABLE DOCUMENTS

4.0 ANTENNA PERFORMANCE

5.0 ASSEMBLY GUIDELINE

6.0 RF PERFORMANCE AS A FUNCTION OF IMPLEMENTATION

7.0 THE ANTENNA PERFORMANCE VARIATION WITH CABLE LENGTH

8.0 CHANGE HISTORY

Molex CVS Dabendorf GmbH
Maerkische Strasse 72, Zossen, 15806, Germany

REVISION: F	ECR/ECN INFORMATION: EC No: 641299 DATE: 2020/05/27	TITLE: WIFI 6E PCB Cabled Balanced Antenna Application Specification	SHEET No. 1 of 22
DOCUMENT NUMBER: AS-1461870100	CREATED / REVISED BY: Liu Hai 2020/05/27	CHECKED BY: Cheng Kang 2020/05/27	APPROVED BY: Andy Zhang 2020/05/27

WIFI 6E PCB CABLED BALANCED ANTENNA

1.0 SCOPE

This specification describes the antenna application and surrounding. The information in this document is for reference and benchmark purposes only. The user is responsible for validating antenna rf performance based on the user's actual implementation.

Antenna illustrations in this document are generic representations. They are not intended to be an image of any antenna listed in the scope.

2.0 PRODUCT DESCRIPTION

2.1 PRODUCT NAME AND SERIES NUMBER (S)

Product name: WIFI 6E PCB Cable Balanced Antenna

Series Number: 146187 Series

2.2 DESCRIPTION

Series 146187 is a balanced, dipole-type, high efficiency antenna for applications, including WiFi 6E, Bluetooth, Zigbee and others. This antenna is made from poly PCB material with small size.

2.3 PRODUCT STRUCTURE INFORMATION

Please refer to PS-1461870100 for full information.

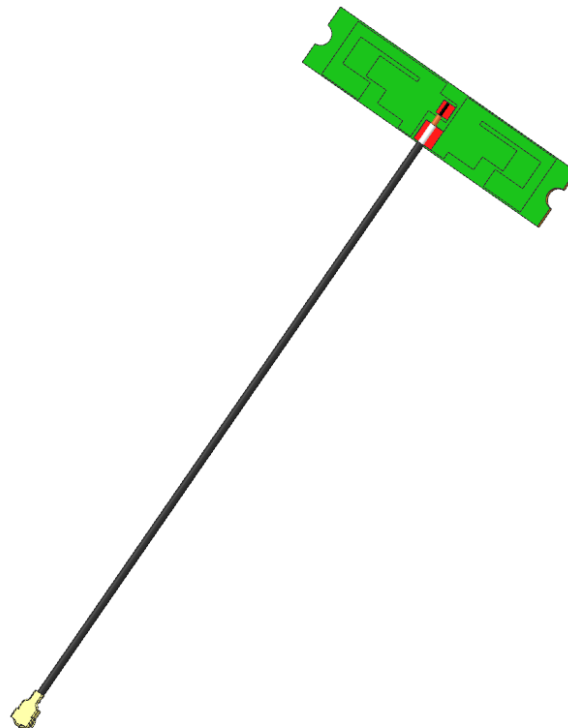

ANTENNA 3D VIEW

REVISION: F	ECR/ECN INFORMATION: EC No: 641299 DATE: 2020/05/27	TITLE: WIFI 6E PCB Cabled Balanced Antenna Application Specification	SHEET No. 2 of 22
DOCUMENT NUMBER: AS-1461870100	CREATED / REVISED BY: Liu Hai 2020/05/27	CHECKED BY: Cheng Kang 2020/05/27	APPROVED BY: Andy Zhang 2020/05/27

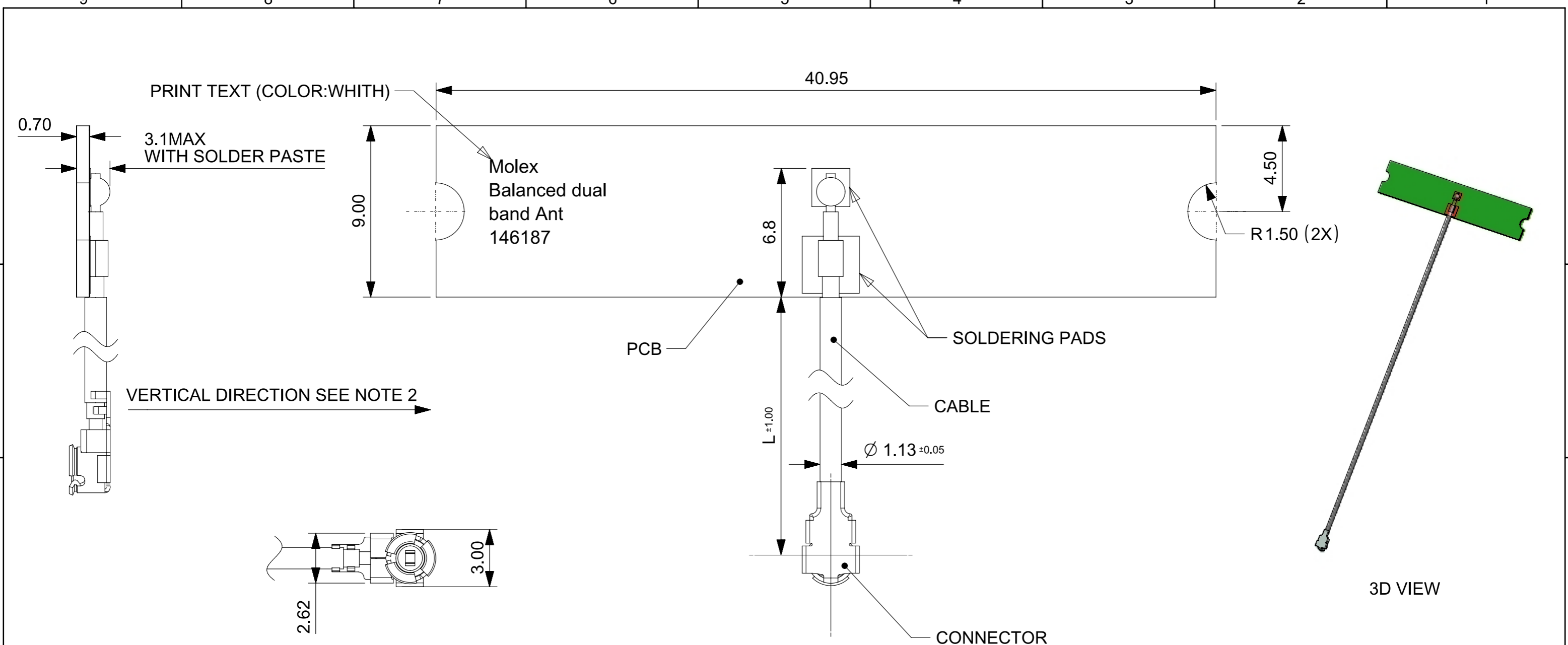

ITEM	MATERIAL NO.	CABLE LENGTH "L"
1	1461870050	43.3mm
2	1461870100	93.3mm
3	1461870150	143.3mm
4	1461870200	193.3mm
5	1461870250	243.3mm
6	1461870300	293.3mm

NOTE:
 1.MATERIAL:
 PCB 40.95mm*9mm THICKNESS 0.7mm
 PATTERN Cu: 18~20um
 CONNECTOR:OD1.13,2.5H UFL CONNECTOR(GOLD PLATED)
 2.CAN NOT LIFT UP CABLE IN VERTICAL DIRECTION
 3.APPLICATION SPEC REFER TO AS OF 1461870100
 4.PRODUCT SPEC REFER TO PS OF 1461870100
 5.PACKAGING SPEC REFER TO PK OF 1461870100

THIS DRAWING CONTAINS INFORMATION THAT IS PROPRIETARY TO MOLEX INCORPORATED AND SHOULD NOT BE USED WITHOUT WRITTEN PERMISSION

EC DESCRIPTION EC NO: 122478 DRWN: Kang Cheng CHK'D: Colin Xu APPR: Stary Song	27/09/17	27/09/17	27/09/17	QUALITY SYMBOLS $\nabla = 0$ $\nabla = 0$ $\nabla = 0$	GENERAL TOLERANCES (UNLESS SPECIFIED) ANGULAR TOL $\pm 0.5^\circ$ 4 PLACES \pm 3 PLACES ± 0.05 2 PLACES ± 0.15 1 PLACE ± 0.2 0 PLACES ± 0.5	DIMENSION UNITS	SCALE			
						mm	4:1			
						DRWN BY	DATE		Kang Cheng	2017/09/27
						CHK'D BY	DATE		Colin Xu	2017/09/27
						APPR BY	DATE		Stary Song	2017/09/27
D	REV				DRAFT WHERE APPLICABLE MUST REMAIN WITHIN DIMENSIONS	DRAWING SIZE	THIRD ANGLE PROJECTION	PRODUCT DESIGN DRAWING SERIES: 146187 MATERIAL NUMBER: See Table CUSTOMER: GENERAL MARKET DOCUMENT NUMBER: 1461870050 DOC TYPE: PSD DOC PART: SD SHEET NUMBER: 1 OF 1		

3.0 APPLICABLE DOCUMENTS

DOCUMENT	NUMBER	DESCRIPTION
Sale Drawing (SD)	SD-1461870050	Mechanical Dimension of the product
Product Specification (PS)	PS-1461870100	Product Specification
Packing Drawing (PK)	PK-1461870100	Product packaging specifications

4.0 ANTENNA PERFORMANCE

4.1 RF TEST CONDITIONS

All measurements are done of the antenna in free space with VNA Agilent E5071C and Over-The-Air (OTA) chamber. All measurements in this document are done with the part no.1461870100 with a cable length of 100mm.

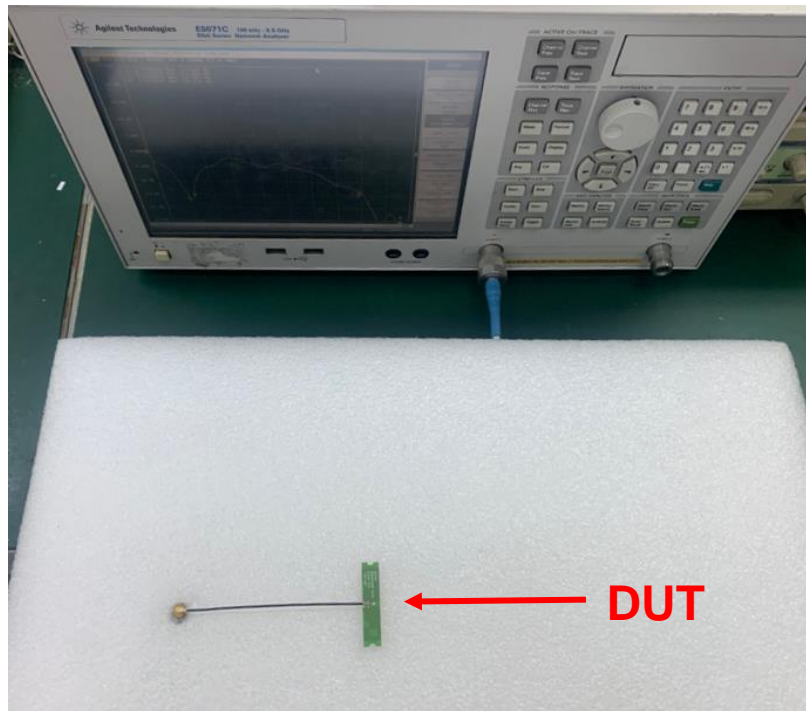

FIGURE4.1.1 ANTENNA IN FREE SPACE WITH VNA AGILENT E5071C

REVISION: F	ECR/ECN INFORMATION: EC No: 641299 DATE: 2020/05/27	TITLE: WIFI 6E PCB Cabled Balanced Antenna Application Specification	SHEET No. 4 of 22
DOCUMENT NUMBER: AS-1461870100	CREATED / REVISED BY: Liu Hai 2020/05/27	CHECKED BY: Cheng Kang 2020/05/27	APPROVED BY: Andy Zhang 2020/05/27



FIGURE4.1.2 ANTENNA IN FREE SPACE WITH OTA CHAMBER

DESCRIPTION	EQUIPMENT	REQUIREMENT		
		2.4-2.5GHz	5.15-5.85GHz	5.925-7.125GHz
Frequency Range	VNA E5071C	2.4-2.5GHz	5.15-5.85GHz	5.925-7.125GHz
Return Loss	VNA E5071C	<- 10dB	<- 10dB	<- 5dB
Peak Gain (Max)	OTA Chamber	3.20dBi	4.25dBi	4.2dBi
Average Total Efficiency	OTA Chamber	>80%	>80%	>70%
Polarization	OTA Chamber	Linear		
Input Impedance	VNA E5071C	50 ohms		

Note that the above antenna performance is measured with just the antenna in a free-space condition. When implement into the system, the frequency resonant might be off-tune due to the loading of surrounding components especially metal plane. This off-tune can be compensated through matching. Although module manufacturers specify a peak gain limit, it is based on free-space conditions. The peak gain will be degraded by 1 to 2dBi in the actual implementation as the radiation pattern will change due to the surround components. As such, during selection of antenna, you can select one with high peak gain to compensate for the loss. Molex can offer assistant to choose the best location and best tuning in-order to meet this peak gain requirement.

REVISION: F	ECR/ECN INFORMATION: EC No: 641299 DATE: 2020/05/27	TITLE: WIFI 6E PCB Cabled Balanced Antenna Application Specification	SHEET No. 5 of 22
DOCUMENT NUMBER: AS-1461870100	CREATED / REVISED BY: Liu Hai 2020/05/27	CHECKED BY: Cheng Kang 2020/05/27	APPROVED BY: Andy Zhang 2020/05/27

4.3 RETURN LOSS PLOT

All measurements in this document are done with a cable length of 100mm.

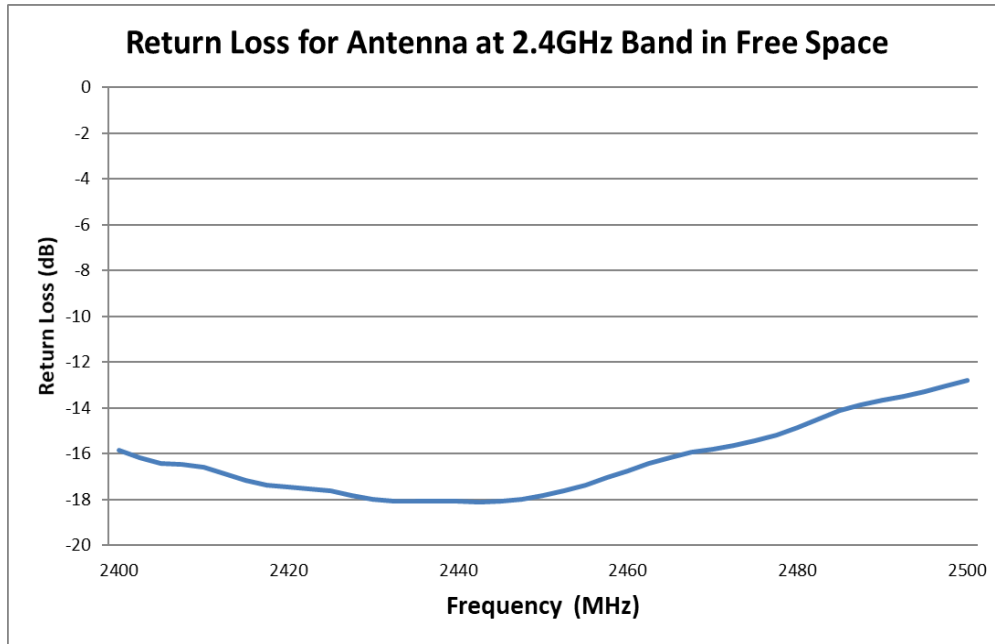

FIGURE 4.3.1 RETURN LOSS OF ANTENNA AT 2.4GHZ BAND IN FREE SPACE

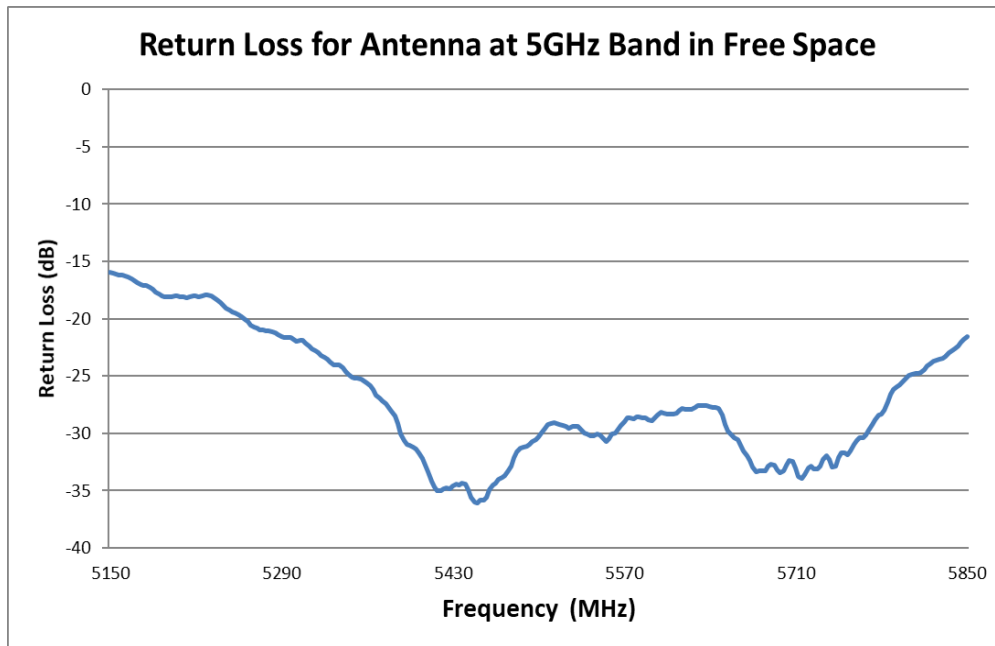

FIGURE 4.3.2 RETURN LOSS OF ANTENNA AT 5GHZ BAND IN FREE SPACE

REVISION: F	ECR/ECN INFORMATION: EC No: 641299 DATE: 2020/05/27	TITLE: WIFI 6E PCB Cabled Balanced Antenna Application Specification	SHEET No. 6 of 22
DOCUMENT NUMBER: AS-1461870100	CREATED / REVISED BY: Liu Hai 2020/05/27	CHECKED BY: Cheng Kang 2020/05/27	APPROVED BY: Andy Zhang 2020/05/27

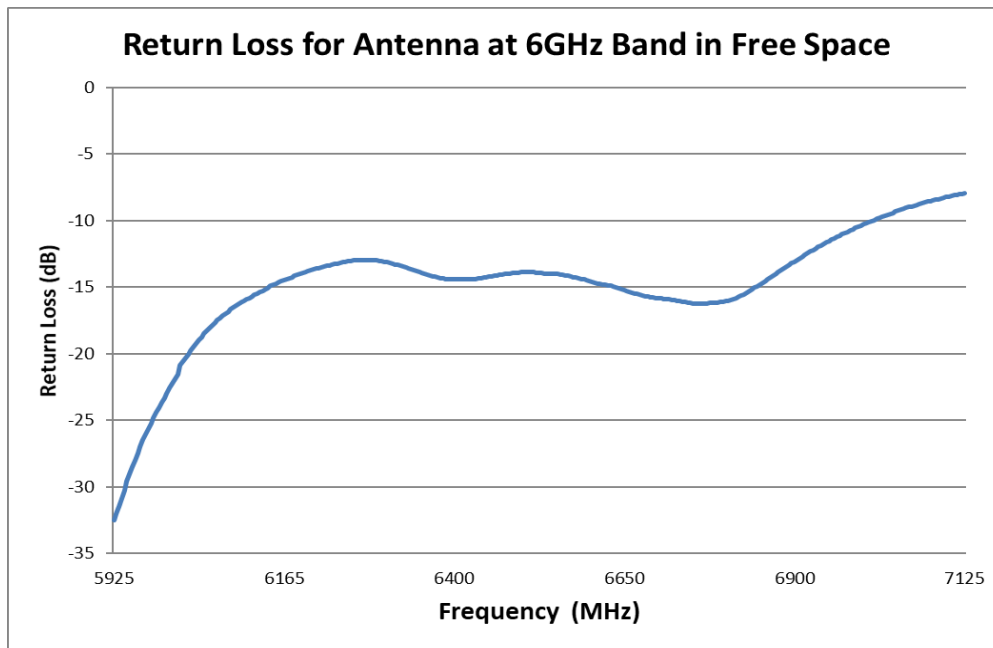

FIGURE 4.3.3 RETURN LOSS OF ANTENNA AT 6GHZ BAND IN FREE SPACE

4.4 EFFICIENCY PLOT

All measurements in this document are done with a cable length of 100mm.

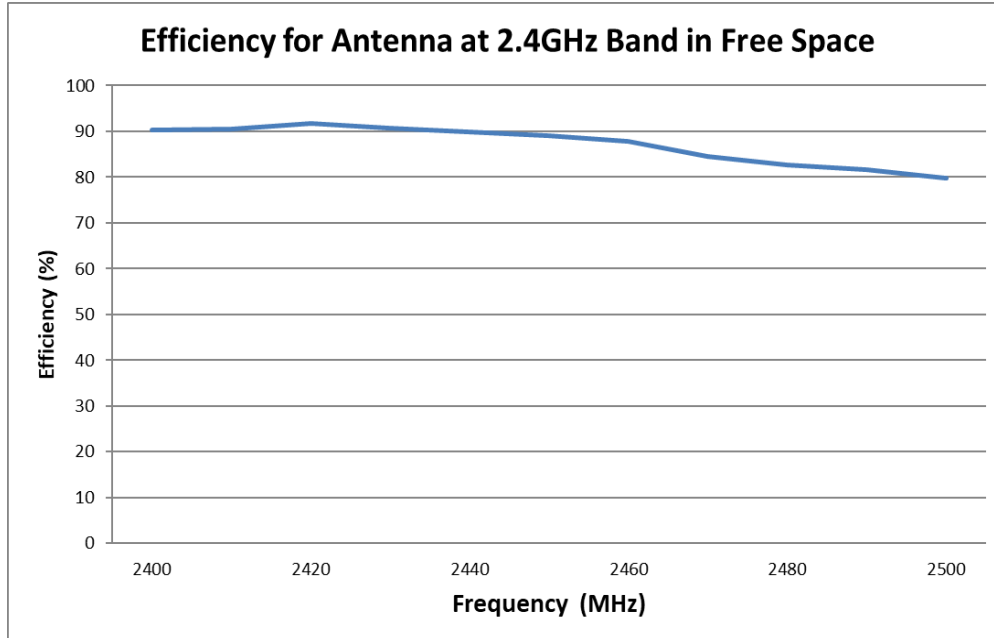

FIGURE 4.4.1 EFFICIENCY OF ANTENNA AT 2.4GHZ BAND IN FREE SPACE

REVISION: F	ECR/ECN INFORMATION: EC No: 641299 DATE: 2020/05/27	TITLE: WIFI 6E PCB Cabled Balanced Antenna Application Specification	SHEET No. 7 of 22
DOCUMENT NUMBER: AS-1461870100	CREATED / REVISED BY: Liu Hai 2020/05/27	CHECKED BY: Cheng Kang 2020/05/27	APPROVED BY: Andy Zhang 2020/05/27

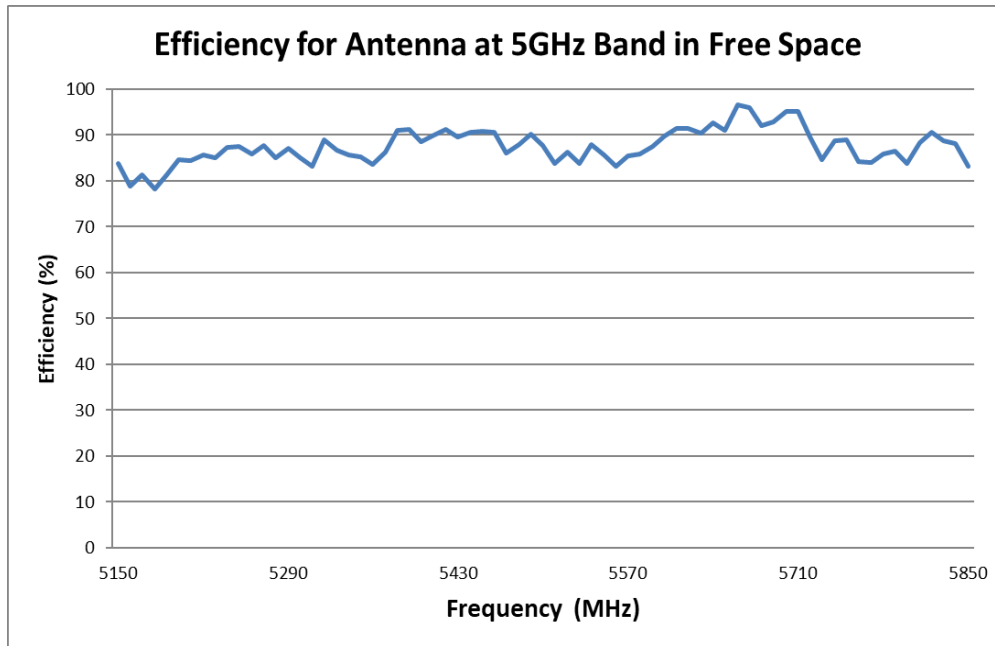

FIGURE 4.4.2 EFFICIENCY OF ANTENNA AT 5GHZ BAND IN FREE SPACE

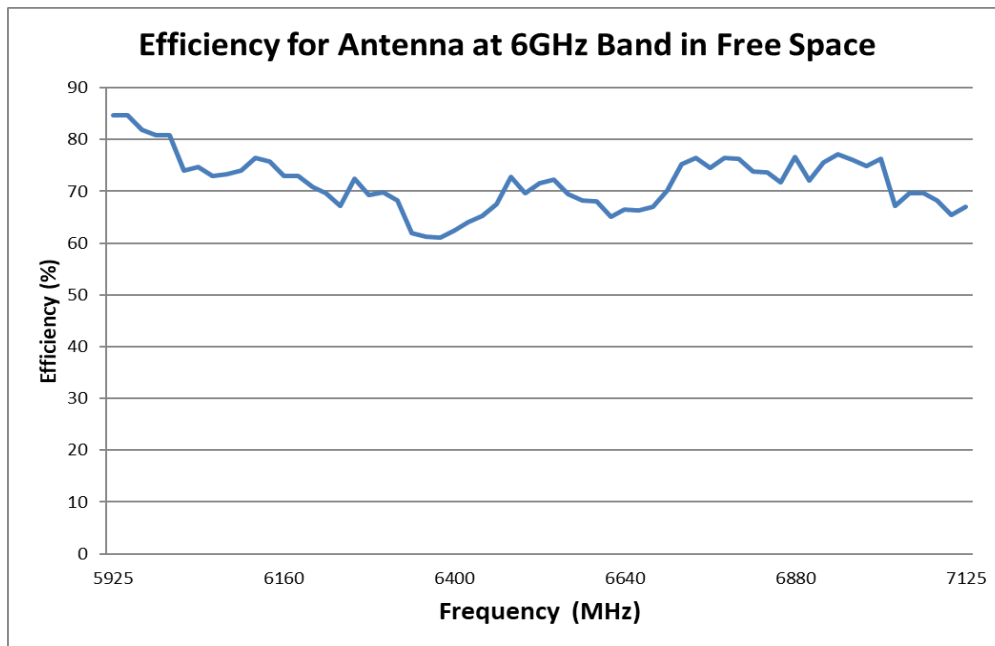

FIGURE 4.4.3 EFFICIENCY OF ANTENNA AT 6GHZ BAND IN FREE SPACE

REVISION: F	ECR/ECN INFORMATION: EC No: 641299 DATE: 2020/05/27	TITLE: WIFI 6E PCB Cabled Balanced Antenna Application Specification	SHEET No. 8 of 22
DOCUMENT NUMBER: AS-1461870100	CREATED / REVISED BY: Liu Hai 2020/05/27	CHECKED BY: Cheng Kang 2020/05/27	APPROVED BY: Andy Zhang 2020/05/27

4.5 RADIATION PATTERN

All measurements in this document are done with a cable length of 100mm.

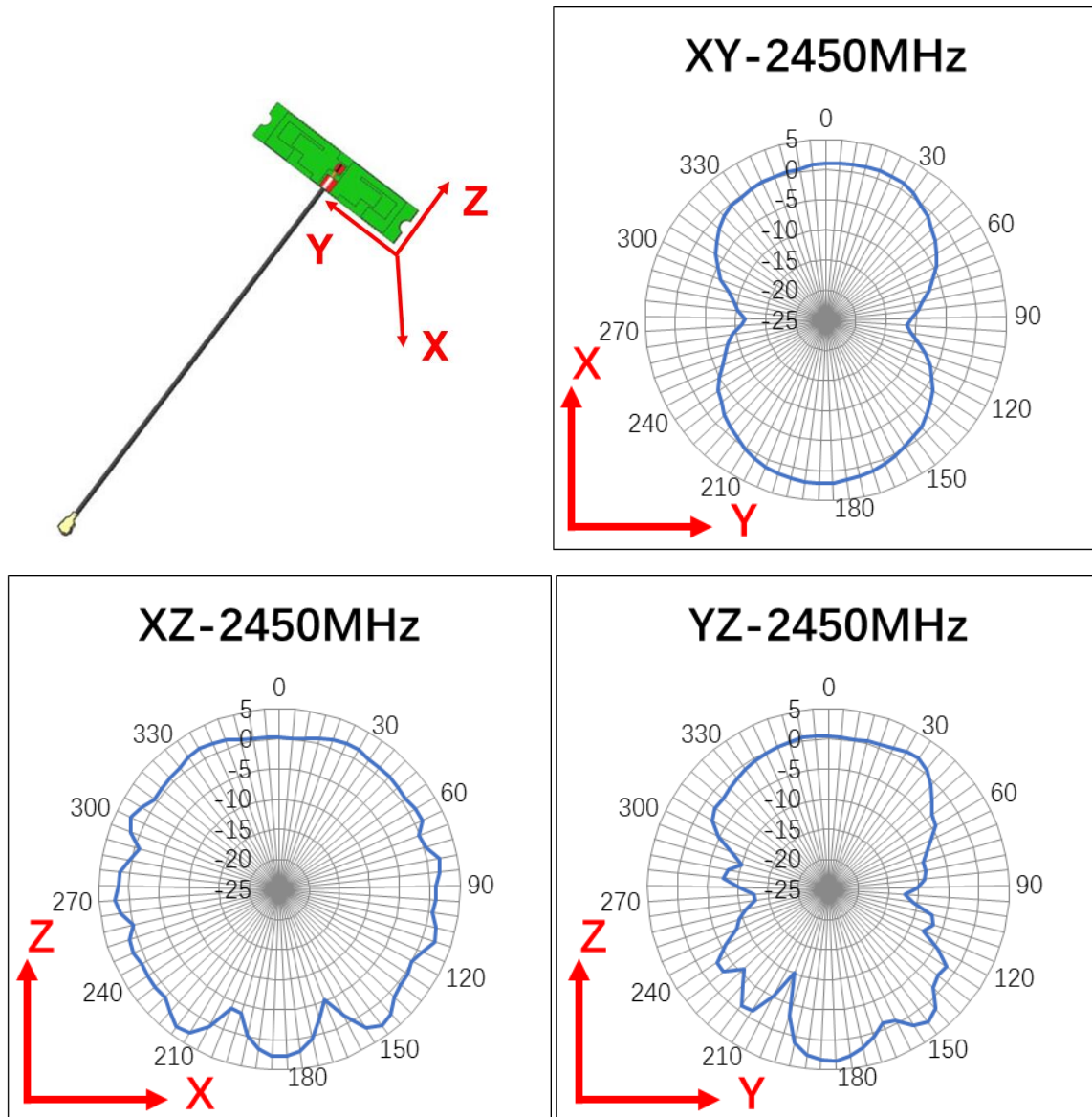

FIGURE 4.5.1 2D RADIATION PATTERN OF ANTENNA AT 2450MHZ IN FREE SPACE

REVISION: F	ECR/ECN INFORMATION: EC No: 641299 DATE: 2020/05/27	TITLE: WIFI 6E PCB Cabled Balanced Antenna Application Specification	SHEET No. 9 of 22
DOCUMENT NUMBER: AS-1461870100	CREATED / REVISED BY: Liu Hai 2020/05/27	CHECKED BY: Cheng Kang 2020/05/27	APPROVED BY: Andy Zhang 2020/05/27

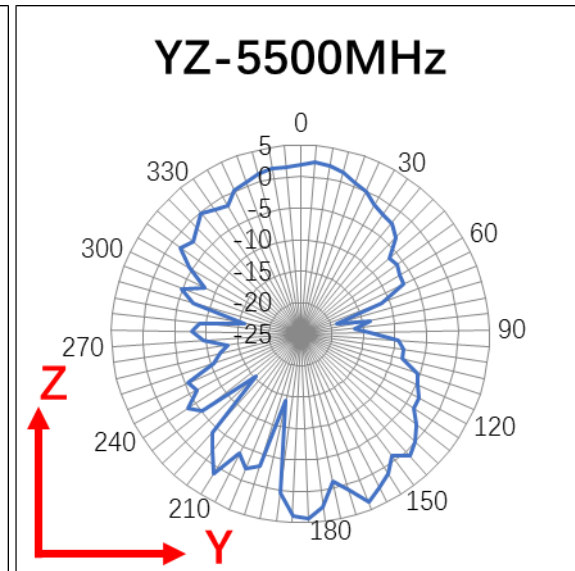
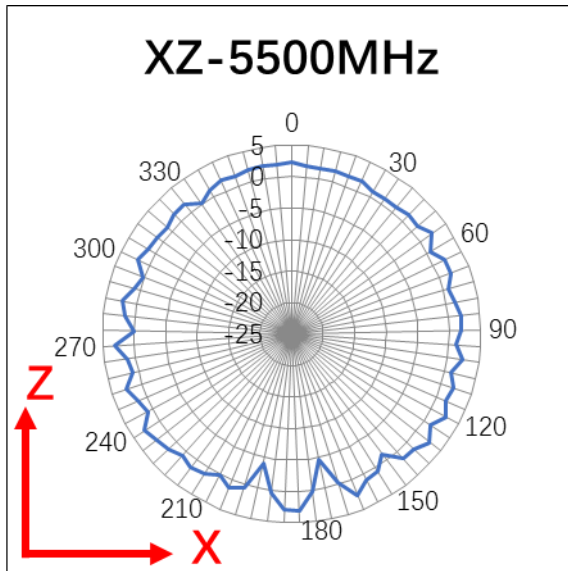
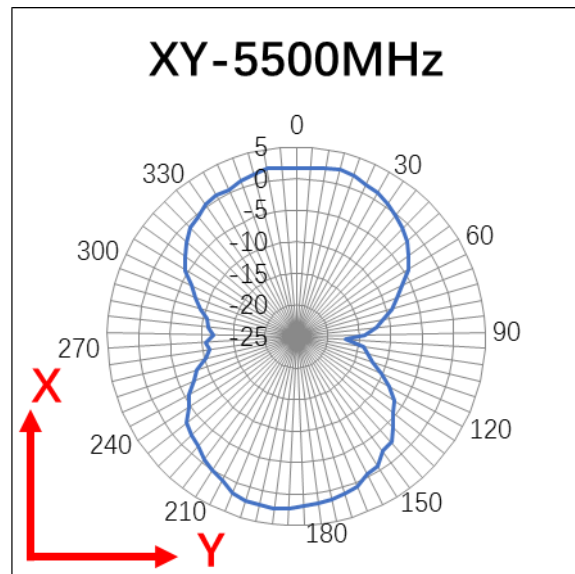
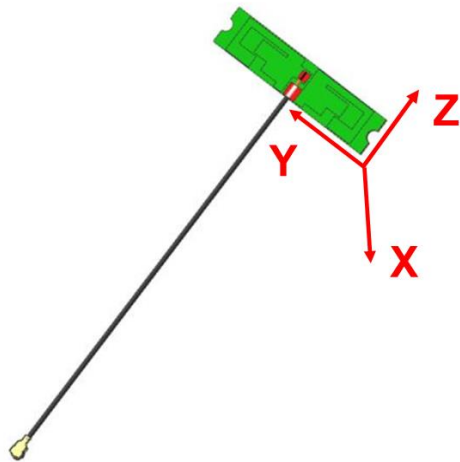

FIGURE 4.5.2 2D RADIATION PATTERN OF ANTENNA AT 5500MHZ IN FREE SPACE

REVISION: F	ECR/ECN INFORMATION: EC No: 641299 DATE: 2020/05/27	TITLE: WIFI 6E PCB Cabled Balanced Antenna Application Specification	SHEET No. 10 of 22
DOCUMENT NUMBER: AS-1461870100	CREATED / REVISED BY: Liu Hai 2020/05/27	CHECKED BY: Cheng Kang 2020/05/27	APPROVED BY: Andy Zhang 2020/05/27

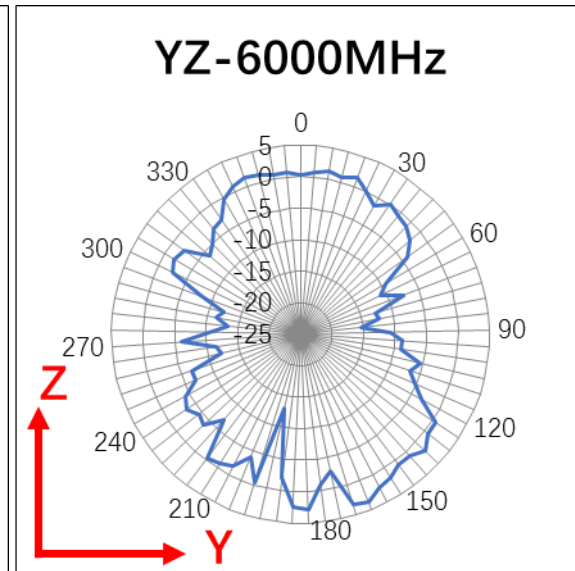
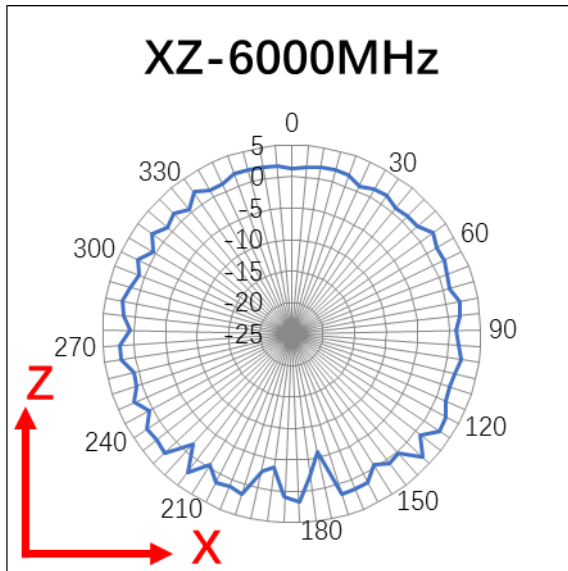
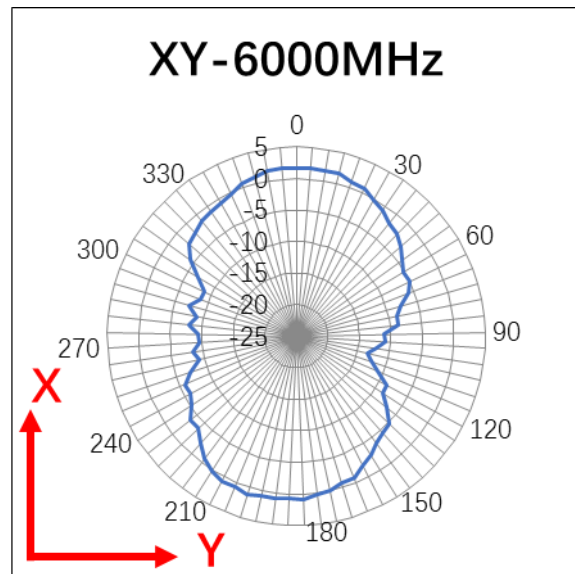
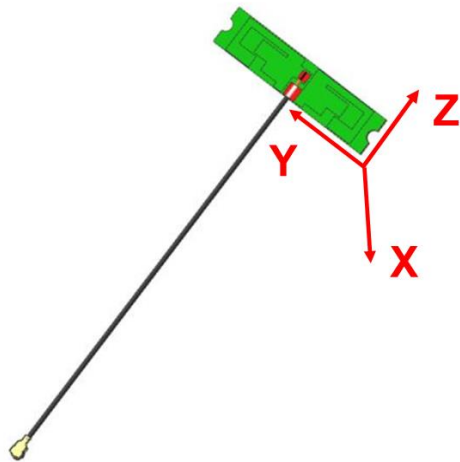

FIGURE 4.5.3 2D RADIATION PATTERN OF ANTENNA AT 6000MHZ IN FREE SPACE

REVISION: F	ECR/ECN INFORMATION: EC No: 641299 DATE: 2020/05/27	TITLE: WIFI 6E PCB Cabled Balanced Antenna Application Specification	SHEET No. 11 of 22
DOCUMENT NUMBER: AS-1461870100	CREATED / REVISED BY: Liu Hai 2020/05/27	CHECKED BY: Cheng Kang 2020/05/27	APPROVED BY: Andy Zhang 2020/05/27

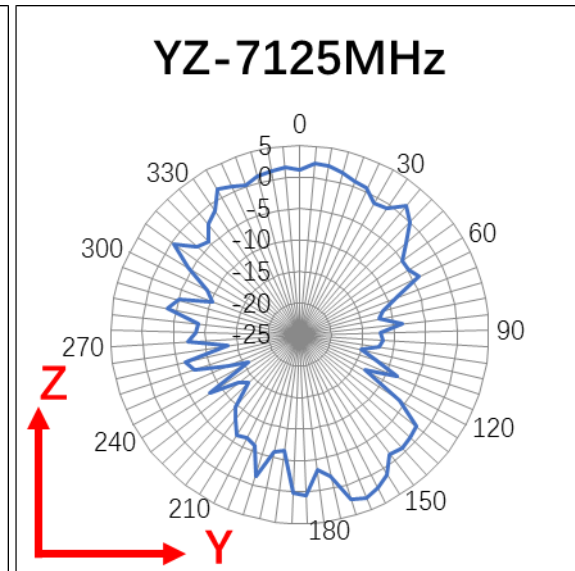
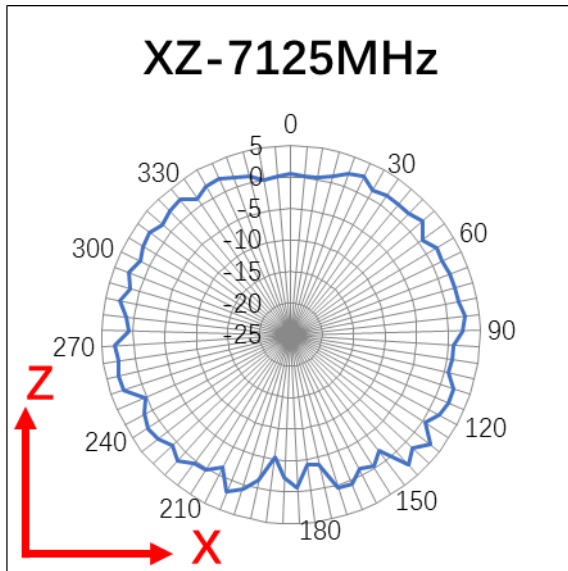
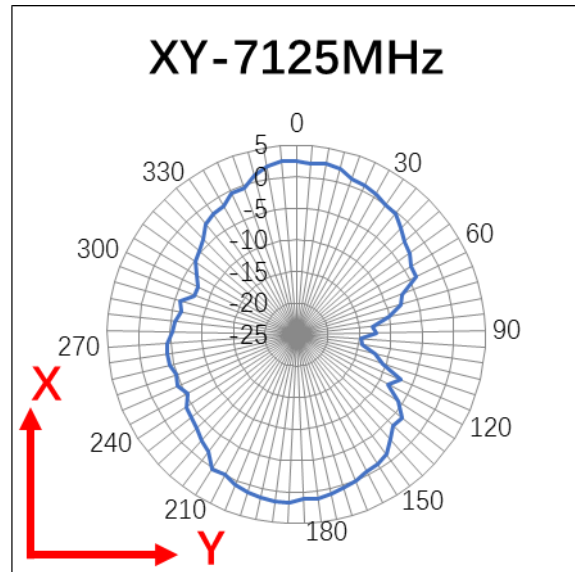
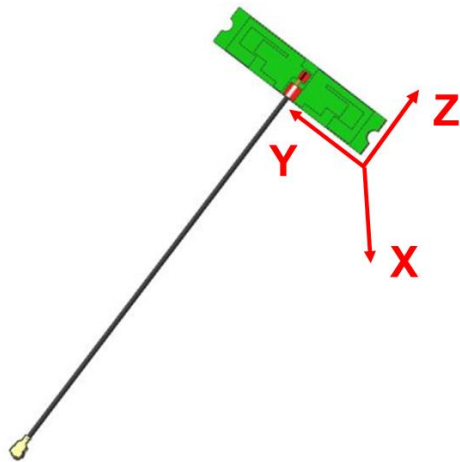

FIGURE 4.5.4 2D RADIATION PATTERN OF ANTENNA AT 7125HZ IN FREE SPACE

REVISION: F	ECR/ECN INFORMATION: EC No: 641299 DATE: 2020/05/27	TITLE: WIFI 6E PCB Cabled Balanced Antenna Application Specification	SHEET No. 12 of 22
DOCUMENT NUMBER: AS-1461870100	CREATED / REVISED BY: Liu Hai 2020/05/27	CHECKED BY: Cheng Kang 2020/05/27	APPROVED BY: Andy Zhang 2020/05/27

5.0 ASSEMBLY GUIDELINE

During the assembly of the antenna in a device, the cable needs to be positioned away from the antenna as shown in Figure 5.1. The cable has to be away from the pattern at least 5mm as shown in Figure 5.2. The PCB has to be away from the housing height at least 5mm as shown in Figure 5.3. If customer would like to paste this product on a plastic cover, we suggest using flex version of this standard antenna, whose part number is 1461530100.

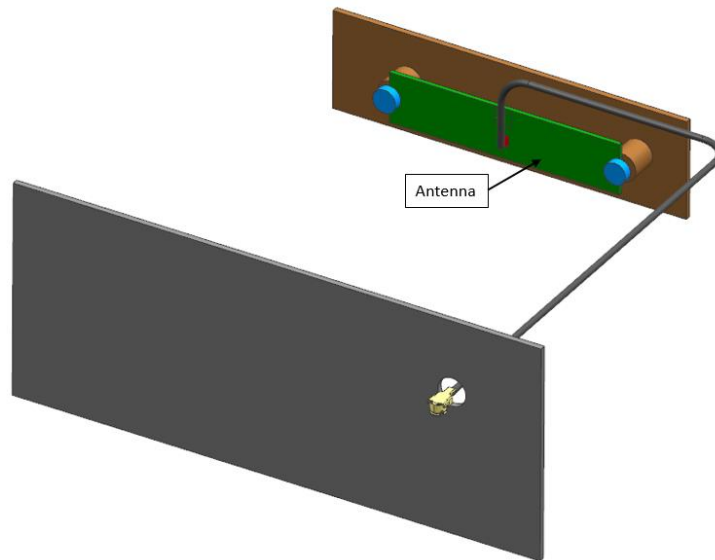

FIGURE 5.1 ASSEMBLY GUIDELINE

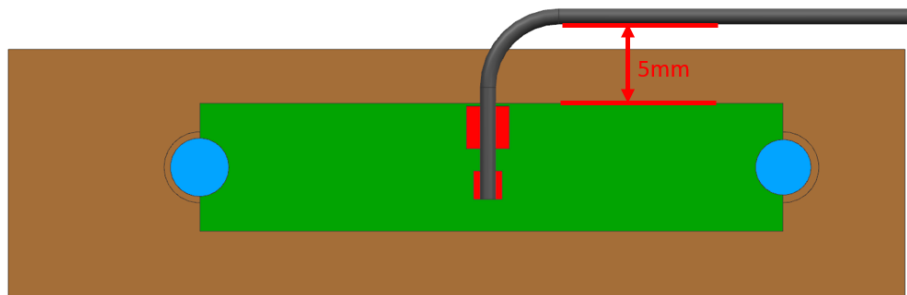

FIGURE 5.2 CABLE BENDING

REVISION: F	ECR/ECN INFORMATION: EC No: 641299 DATE: 2020/05/27	TITLE: WIFI 6E PCB Cabled Balanced Antenna Application Specification	SHEET No. 13 of 22
DOCUMENT NUMBER: AS-1461870100	CREATED / REVISED BY: Liu Hai 2020/05/27	CHECKED BY: Cheng Kang 2020/05/27	APPROVED BY: Andy Zhang 2020/05/27

The columnar material can be plastic with metal nut or pure plastic. However, pure metal for columnar is not recommended. During the assembly of the PCB, twist force must be less than 3kgf.

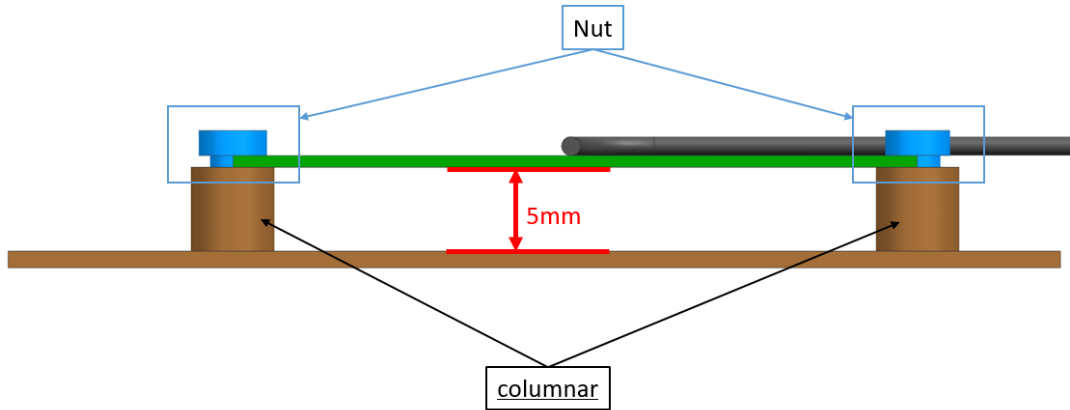

FIGURE 5.3 ANTENNA ASSEMBLY HEIGHT

REVISION: F	ECR/ECN INFORMATION: EC No: 641299 DATE: 2020/05/27	TITLE: WIFI 6E PCB Cabled Balanced Antenna Application Specification	SHEET No. 14 of 22
DOCUMENT NUMBER: AS-1461870100	CREATED / REVISED BY: Liu Hai 2020/05/27	CHECKED BY: Cheng Kang 2020/05/27	APPROVED BY: Andy Zhang 2020/05/27

6.0 RF PERFORMANCE AS A FUNCTION OF IMPLEMENTATION

6.1 ANTENNA RF PERFORMANCE AS A FUNCTION OF DIFFERENT LOCATIONS WITH PARALLEL PLANE GROUND

Four locations with parallel plane ground have been evaluated and these locations are shown in figure 6.1.1. The plane ground size is 90mm*90mm and we move the plane ground to four locations for each test. The antenna performance is better with larger distance between antenna and parallel plane ground. The minimum distance between antenna and plane ground is recommended to be 15mm to achieve acceptable RF performance.

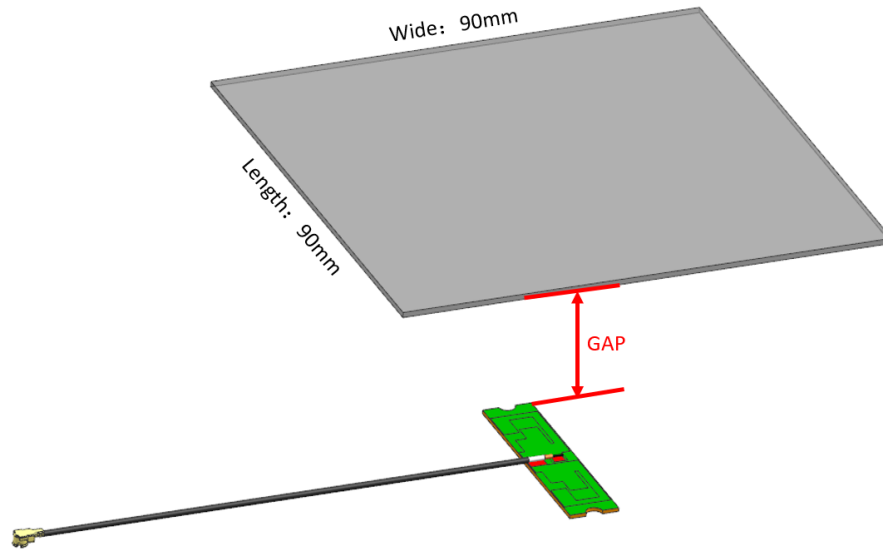

FIGURE 6.1.1 FOUR LOCATIONS WITH PARALLEL PLANE GROUND

Ground Size: 90mm*90mm;

- Location 1: Distance between antenna and plane (GAP) ground is about 5mm;
- Location 2: Distance between antenna and plane (GAP) ground is about 10mm;
- Location 3: Distance between antenna and plane (GAP) ground is about 15mm;
- Location 4: Distance between antenna and plane (GAP) ground is about 20mm.

REVISION: F	ECR/ECN INFORMATION: EC No: 641299 DATE: 2020/05/27	TITLE: WIFI 6E PCB Cabled Balanced Antenna Application Specification	SHEET No. 15 of 22
DOCUMENT NUMBER: AS-1461870100	CREATED / REVISED BY: Liu Hai 2020/05/27	CHECKED BY: Cheng Kang 2020/05/27	APPROVED BY: Andy Zhang 2020/05/27

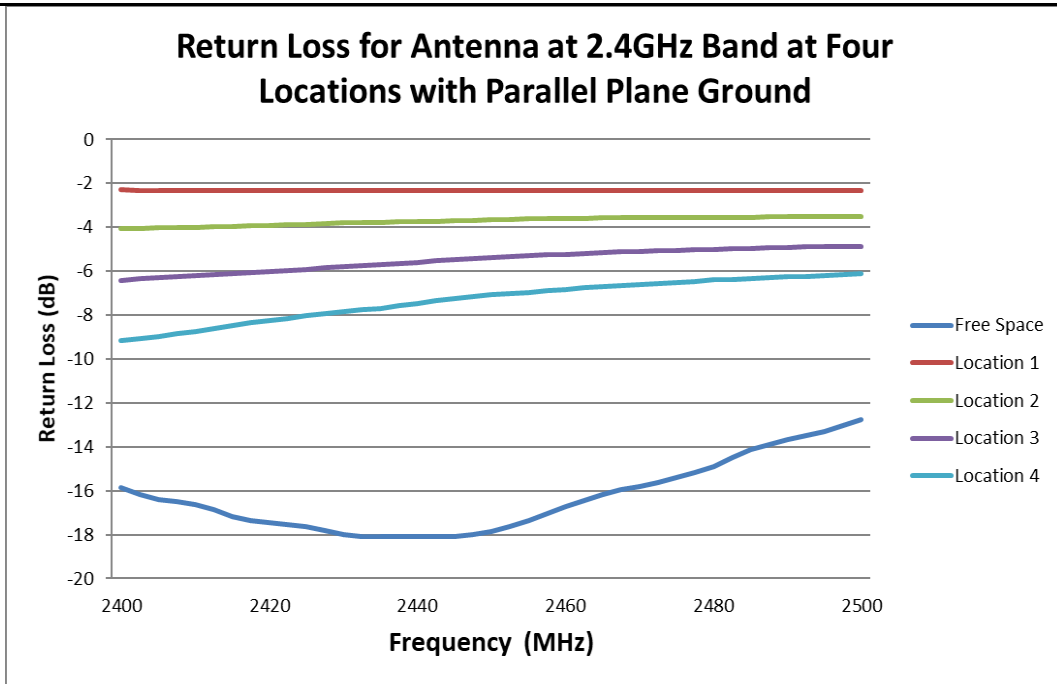

FIGURE 6.1.2 RETURN LOSS OF ANTENNA AT 2.4GHZ BAND AT FOUR LOCATIONS WITH PARALLEL PLANE GROUND

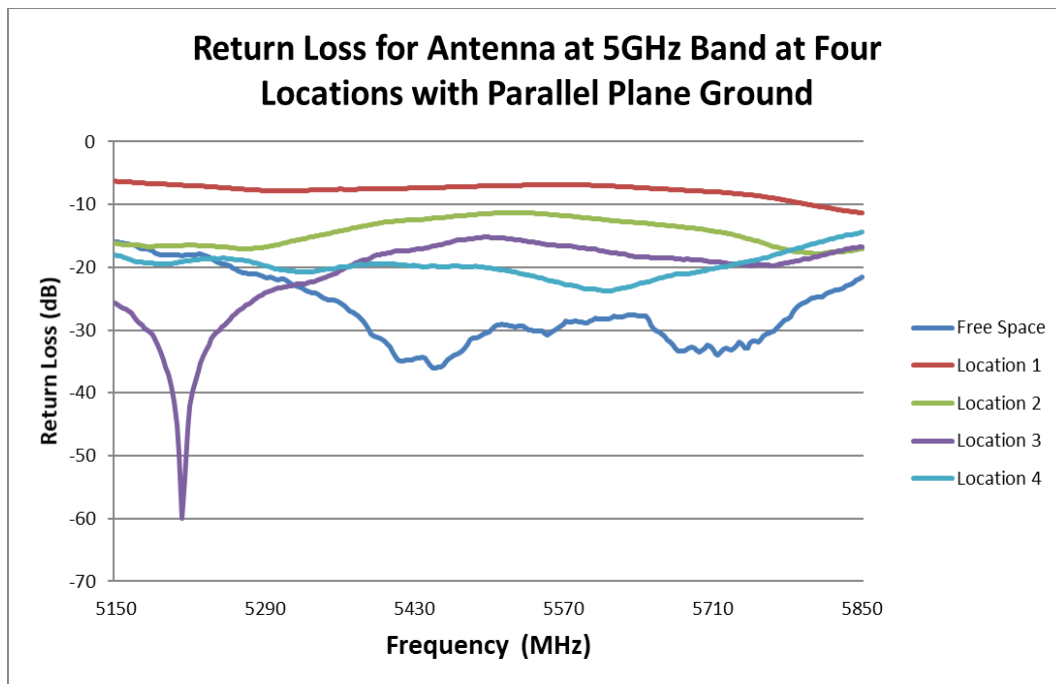

FIGURE 6.1.3 RETURN LOSS OF ANTENNA AT 5GHZ BAND AT FOUR LOCATIONS WITH PARALLEL PLANE GROUND

REVISION: F	ECR/ECN INFORMATION: EC No: 641299 DATE: 2020/05/27	TITLE: WIFI 6E PCB Cabled Balanced Antenna Application Specification	SHEET No. 16 of 22
DOCUMENT NUMBER: AS-1461870100	CREATED / REVISED BY: Liu Hai 2020/05/27	CHECKED BY: Cheng Kang 2020/05/27	APPROVED BY: Andy Zhang 2020/05/27

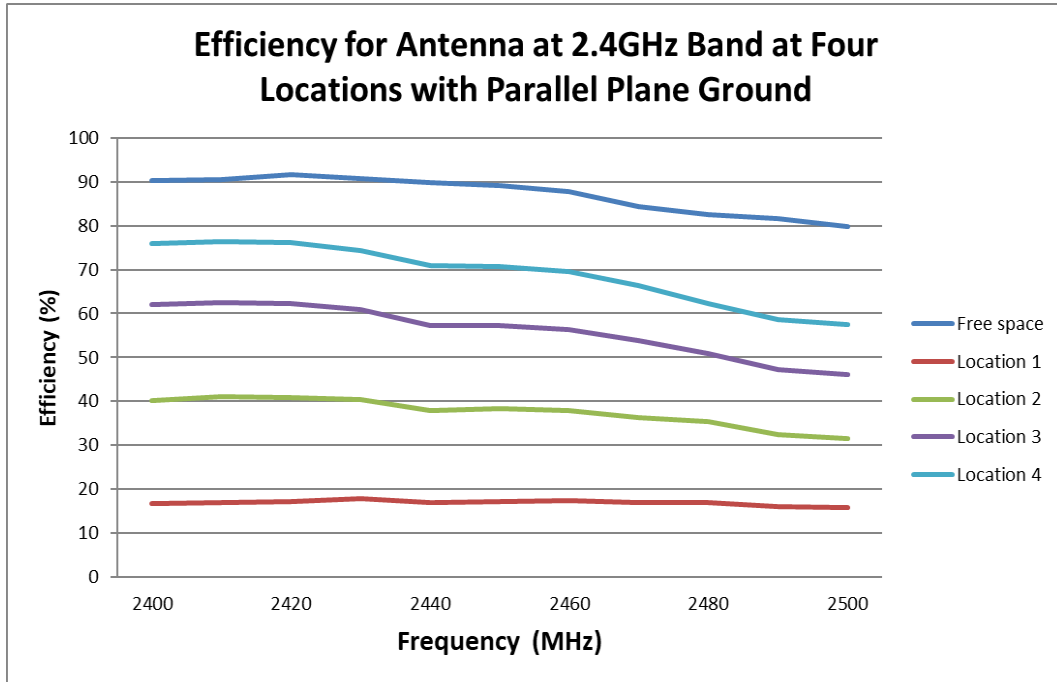

FIGURE 6.1.4 EFFICIENCY OF ANTENNA AT 2.4GHZ BAND AT FOUR LOCATIONS WITH PARALLEL PLANE GROUND

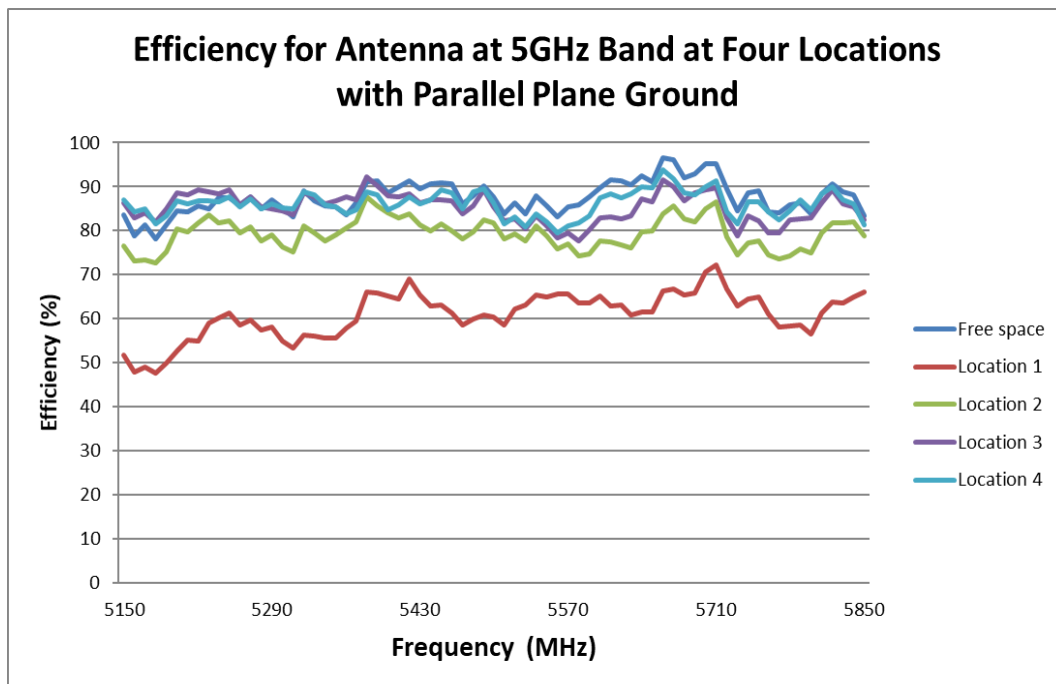

FIGURE 6.1.5 EFFICIENCY OF ANTENNA AT 5GHZ BAND AT FOUR LOCATIONS WITH PARALLEL PLANE GROUND

REVISION: F	ECR/ECN INFORMATION: EC No: 641299 DATE: 2020/05/27	TITLE: WIFI 6E PCB Cabled Balanced Antenna Application Specification	SHEET No. 17 of 22
DOCUMENT NUMBER: AS-1461870100	CREATED / REVISED BY: Liu Hai 2020/05/27	CHECKED BY: Cheng Kang 2020/05/27	APPROVED BY: Andy Zhang 2020/05/27

6.2 ANTENNA RF PERFORMANCE AS A FUNCTION OF DIFFERENT LOCATIONS WITH VERTICAL PLANE GROUND

Four locations with vertical plane ground have been evaluated and these locations are shown in figure 6.2.1. The plane ground size is 90mm*90mm and we move the plane ground to four locations for each test. The antenna performance is better with larger distance between antenna and vertical plane ground. The minimum distance between antenna and plane ground is recommended to be 5mm to achieve acceptable RF performance.

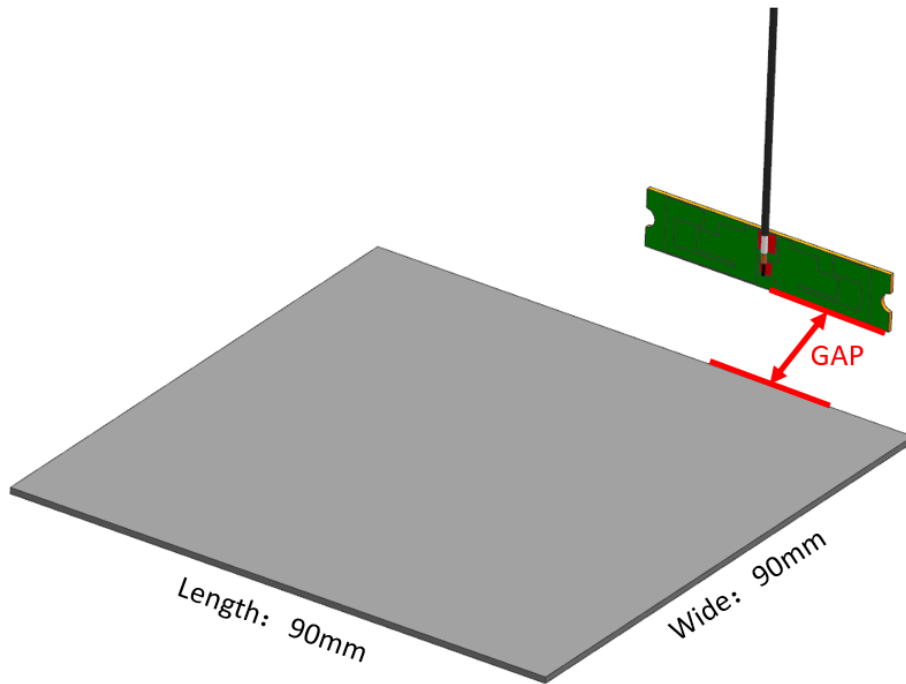

FIGURE 6.2.1 FOUR LOCATIONS WITH VERTICAL PLANE GROUND

Ground Size: 90mm*90mm;

- Location 1: Distance between antenna and plane (GAP) ground is about 5mm;
- Location 2: Distance between antenna and plane (GAP) ground is about 10mm;
- Location 3: Distance between antenna and plane (GAP) ground is about 15mm;
- Location 4: Distance between antenna and plane (GAP) ground is about 20mm.

REVISION: F	ECR/ECN INFORMATION: EC No: 641299 DATE: 2020/05/27	TITLE: WIFI 6E PCB Cabled Balanced Antenna Application Specification	SHEET No. 18 of 22
DOCUMENT NUMBER: AS-1461870100	CREATED / REVISED BY: Liu Hai 2020/05/27	CHECKED BY: Cheng Kang 2020/05/27	APPROVED BY: Andy Zhang 2020/05/27

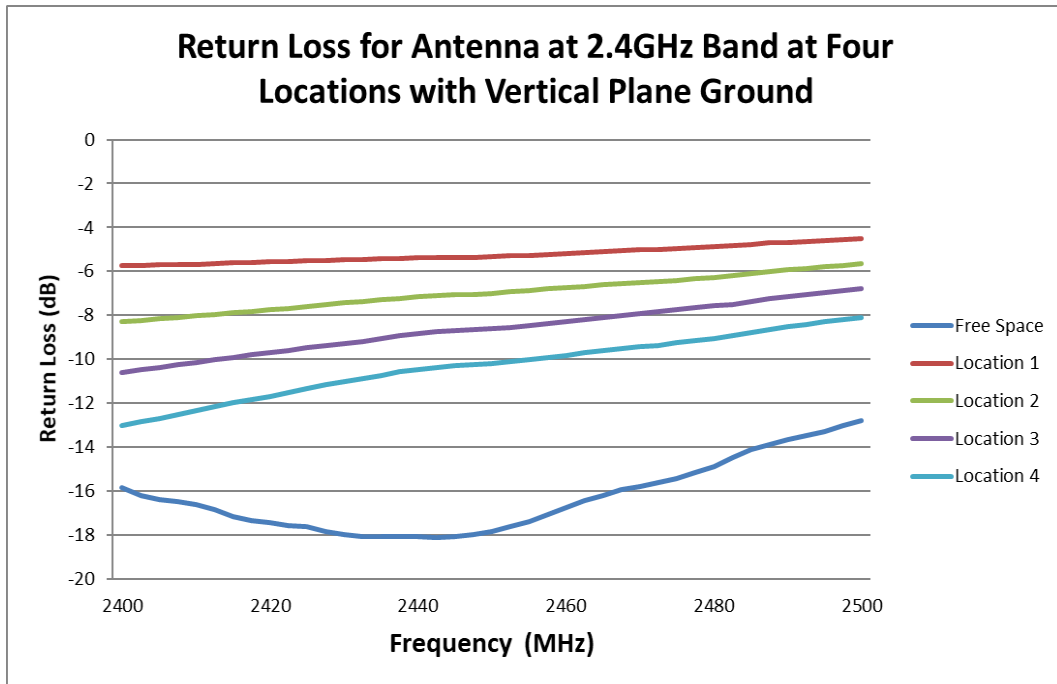

FIGURE 6.2.2 RETURN LOSS OF ANTENNA AT 2.4GHZ BAND AT FOUR LOCATIONS WITH VERTICAL PLANE GROUND

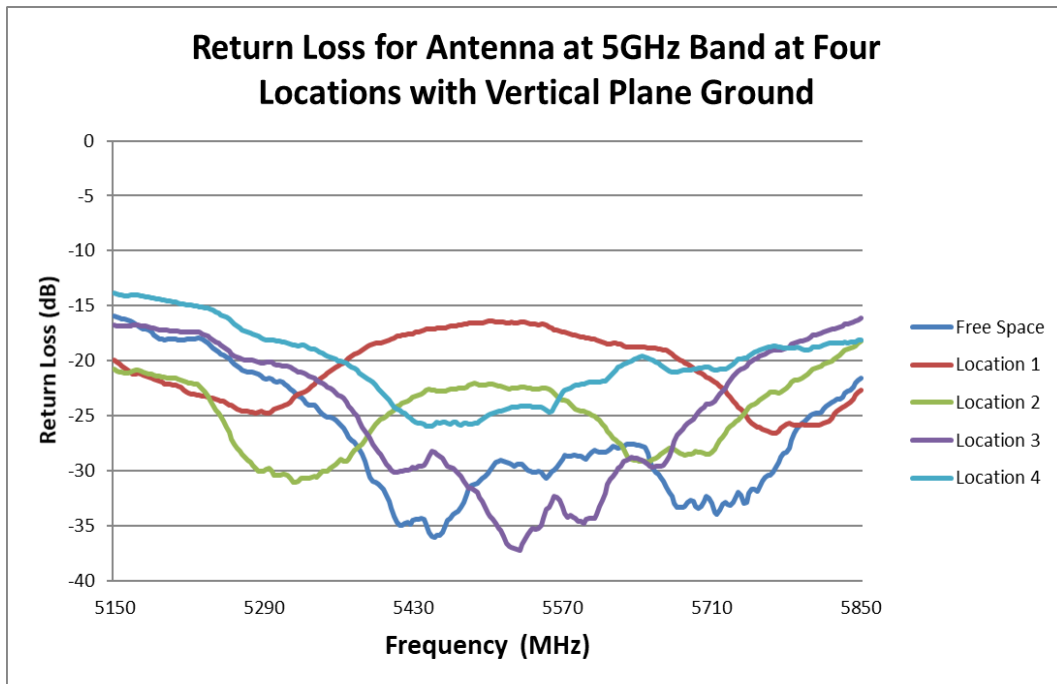

FIGURE 6.2.3 RETURN LOSS OF ANTENNA AT 5GHZ BAND AT FOUR LOCATIONS WITH VERTICAL PLANE GROUND

REVISION: F	ECR/ECN INFORMATION: EC No: 641299 DATE: 2020/05/27	TITLE: WIFI 6E PCB Cabled Balanced Antenna Application Specification	SHEET No. 19 of 22
DOCUMENT NUMBER: AS-1461870100	CREATED / REVISED BY: Liu Hai 2020/05/27	CHECKED BY: Cheng Kang 2020/05/27	APPROVED BY: Andy Zhang 2020/05/27

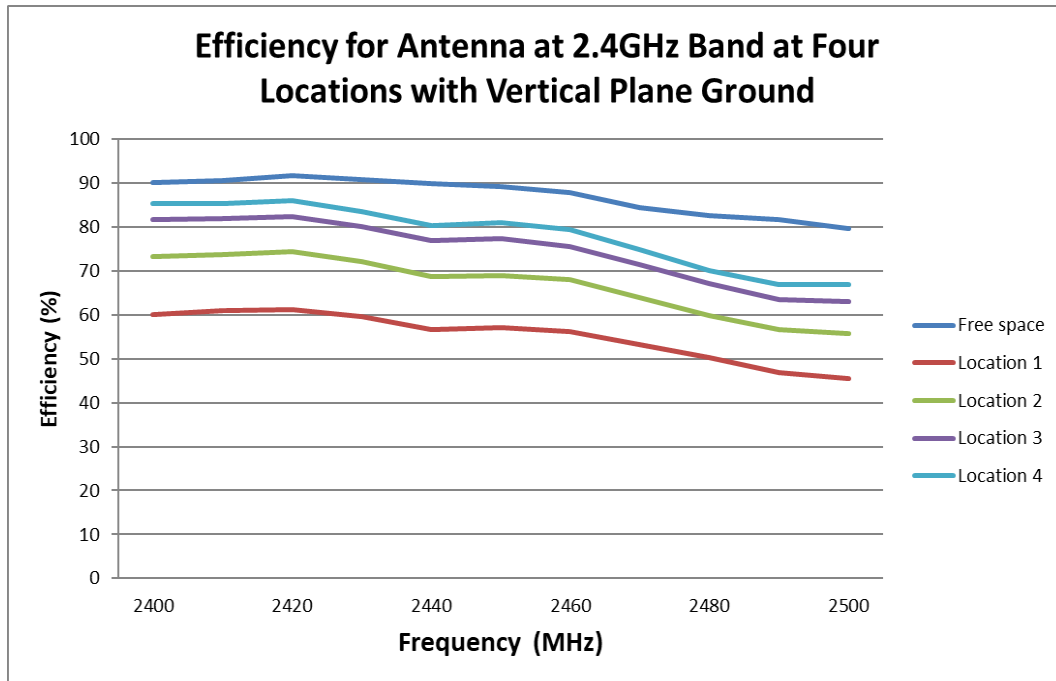

FIGURE 6.2.4 EFFICIENCY OF ANTENNA AT 2.4GHZ BAND AT FOUR LOCATIONS WITH VERTICAL PLANE GROUND

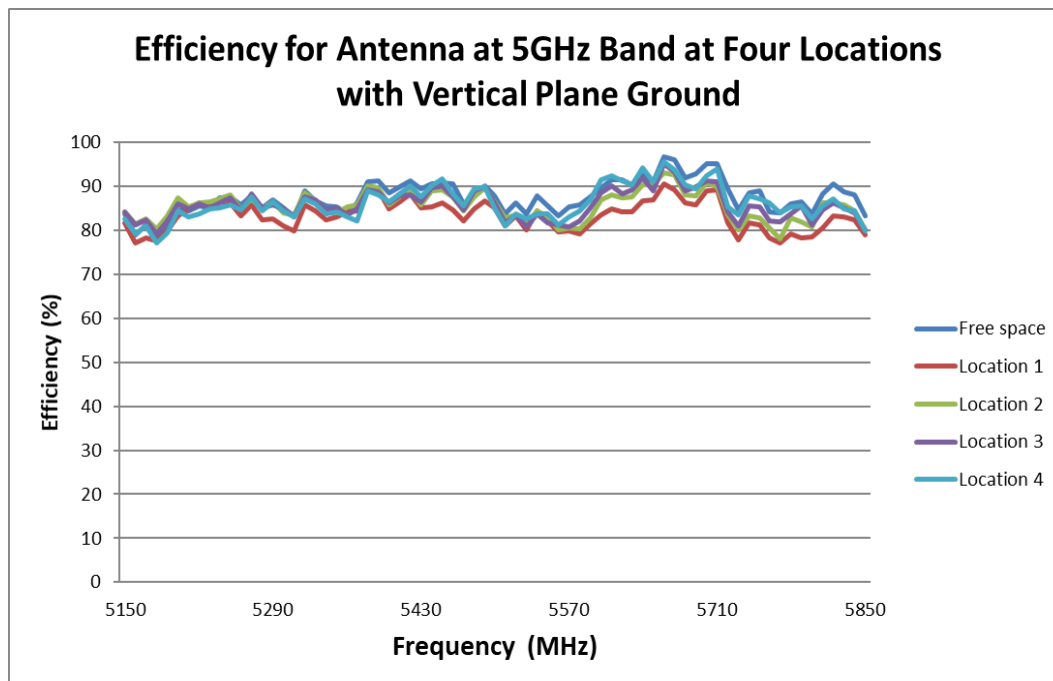

FIGURE 6.2.5 EFFICIENCY OF ANTENNA AT 5GHZ BAND AT FOUR LOCATIONS WITH VERTICAL PLANE GROUND

REVISION: F	ECR/ECN INFORMATION: EC No: 641299 DATE: 2020/05/27	TITLE: WIFI 6E PCB Cabled Balanced Antenna Application Specification	SHEET No. 20 of 22
DOCUMENT NUMBER: AS-1461870100	CREATED / REVISED BY: Liu Hai 2020/05/27	CHECKED BY: Cheng Kang 2020/05/27	APPROVED BY: Andy Zhang 2020/05/27



APPLICATION SPECIFICATION

7.0 THE ANTENNA PERFORMANCE VARIATION WITH CABLE LENGTH

7.0.1 CABLE LOSS

ITEM	DESCRIPTION	TEST CONDITION	REQUIREMENT		
7.0.1.1	Frequency Range	2 GHz~6GHz	2GHz~3GHz	5GHz~6GHz	6-7.125GHz
7.0.1.2	Attenuation	1m cable measured by VNA5071C	≤3.5dB/m	≤5.5dB/m	≤6.5dB/m

7.0.2 CABLE LENGTH AFFECT THE ANTENNA PERFORMANCE

Balance antenna resonance is insensitive by cable length, but the cable loss will affect the total efficiency. Refer to 7.0.1

7.0.3 FOR EXAMPLE

Base on the 100mm cable performance, we can mostly compute the 300mm cable's.

Frequency (MHz)	100mm cable		cable loss	300mm cable	
	Efficiency (dB)	Efficiency (%)		Efficiency (dB)	Efficiency (%)
	X		X-LOSS=Y	Y	
2400	-0.31	93.20	0.2m*3.5dB/m	-1.01	79.32
2420	-0.23	94.75		-0.93	80.65
2440	-0.32	92.93		-1.02	79.09
2460	-0.42	90.88		-1.12	77.35
2480	-0.72	84.64		-1.42	72.04
2500	-0.98	79.72		-1.98	63.32
5150	-0.77	83.70	0.2*5.5dB/m	-1.87	64.97
5200	-0.73	84.60		-1.83	65.67
5250	-0.58	87.57		-1.68	67.98
5300	-0.70	85.13		-1.80	66.08
5350	-0.69	85.32		-1.79	66.23
5400	-0.53	88.60		-1.63	68.78
5450	-0.41	90.90		-1.51	70.56
5500	-0.57	87.76		-1.67	68.12
5550	-0.67	85.61		-1.77	66.46
5600	-0.47	89.77		-1.57	69.69
5650	-0.41	91.02		-1.51	70.66
5700	-0.22	95.13		-1.32	73.85
5750	-0.51	88.95		-1.61	69.05
5800	-0.76	83.86		-1.86	65.10
5850	-0.80	83.26		-1.90	64.63

REVISION: F	ECR/ECN INFORMATION: EC No: 641299 DATE: 2020/05/27	TITLE: WIFI 6E PCB Cabled Balanced Antenna Application Specification	SHEET No. 21 of 22
DOCUMENT NUMBER: AS-1461870100	CREATED / REVISED BY: Liu Hai 2020/05/27	CHECKED BY: Cheng Kang 2020/05/27	APPROVED BY: Andy Zhang 2020/05/27



APPLICATION SPECIFICATION

Frequency (MHz)	100mm cable		cable loss	300mm cable	
	Efficiency (dB)	Efficiency (%)		Efficiency (dB)	Efficiency (%)
	X		X-LOSS=Y	Y	
6000	-1.34	73.38	0.2*6.5dB/m	-2.64	54.39
6100	-1.24	75.23		-2.54	55.77
6200	-1.44	71.76		-2.74	53.20
6300	-1.46	71.53		-2.76	53.02
6400	-1.66	62.29		-2.96	50.64
6500	-1.57	69.64		-2.87	51.63
6600	-1.66	67.31		-2.96	50.59
6700	-1.69	67.75		-2.99	50.22
6800	-1.15	76.75		-2.45	56.90
6900	-1.18	76.22		-2.48	56.50
7000	-1.03	78.80		-2.33	58.42
7100	-1.22	65.83		-2.52	56.03
7125	-1.34	73.40		-2.64	54.42

The data is just for your reference, all accurate performance should be according to the test results in the OTA chamber

8.0 CHANGE HISTORY

CHANGE HISTORY		
REV	DATA	DESCRIPTION
F	2020/05/27	Add 6-7.125GHz band

REVISION: F	ECR/ECN INFORMATION: EC No: 641299 DATE: 2020/05/27	TITLE: WIFI 6E PCB Cabled Balanced Antenna Application Specification	SHEET No. 22 of 22
DOCUMENT NUMBER: AS-1461870100	CREATED / REVISED BY: Liu Hai 2020/05/27	CHECKED BY: Cheng Kang 2020/05/27	APPROVED BY: Andy Zhang 2020/05/27