

## FCC Test Report

**Report No.:** RF200203E11-1

**FCC ID:** 2AF5PML2410

**Test Model:** ML2410

**Series Model:** ML2410XY  
( where both X and Y can be A, B, C, D or blank. )

**Received Date:** Feb. 03, 2020

**Test Date:** Feb. 19 to Mar. 05, 2020

**Issued Date:** Apr. 01, 2020

**Applicant:** MTRLC LLC

**Address:** 225 Franklin Street, 26th Floor, Boston, MA 02110 USA

**Issued By:** Bureau Veritas Consumer Products Services (H.K.) Ltd., Taoyuan Branch  
Hsin Chu Laboratory

**Lab Address:** E-2, No.1, Li Hsin 1st Road, Hsinchu Science Park, Hsinchu City 300,  
Taiwa.

**Test Location:** E-2, No.1, Li Hsin 1st Road, Hsinchu Science Park, Hsinchu City 300,  
Taiwan.

**FCC Registration /  
Designation Number:** 723255 / TW2022



This report is for your exclusive use. Any copying or replication of this report to or for any other person or entity, or use of our name or trademark, is permitted only with our prior written permission. This report sets forth our findings solely with respect to the test samples identified herein. The results set forth in this report are not indicative or representative of the quality or characteristics of the lot from which a test sample was taken or any similar or identical product specifically and expressly noted. Our report includes all of the tests requested by you and the results thereof based upon the information that you provided to us. You have 60 days from date of issuance of this report to notify us of any material error or omission caused by our negligence, provided, however, that such notice shall be in writing and shall specifically address the issue you wish to raise. A failure to raise such issue within the prescribed time shall constitute your unqualified acceptance of the completeness of this report, the tests conducted and the correctness of the report contents. Unless specific mention, the uncertainty of measurement has been explicitly taken into account to declare the compliance or non-compliance to the specification. The report must not be used by the client to claim product certification, approval, or endorsement by TAF or any government agencies.

## Table of Contents

<b>Release Control Record</b> .....	<b>4</b>
<b>1 Certificate of Conformity</b> .....	<b>5</b>
<b>2 Summary of Test Results</b> .....	<b>6</b>
2.1 Measurement Uncertainty .....	6
2.2 Modification Record .....	6
<b>3 General Information</b> .....	<b>7</b>
3.1 General Description of EUT .....	7
3.2 Description of Test Modes .....	10
3.2.1 Test Mode Applicability and Tested Channel Detail .....	11
3.3 Duty Cycle of Test Signal .....	13
3.4 Description of Support Units .....	14
3.4.1 Configuration of System under Test .....	15
3.5 General Description of Applied Standard and references .....	16
<b>4 Test Types and Results</b> .....	<b>17</b>
4.1 Radiated Emission and Bandedge Measurement.....	17
4.1.1 Limits of Radiated Emission and Bandedge Measurement .....	17
4.1.2 Test Instruments .....	18
4.1.3 Test Procedure .....	19
4.1.4 Deviation from Test Standard .....	20
4.1.5 Test Setup.....	20
4.1.6 EUT Operating Condition .....	21
4.1.7 Test Results .....	22
4.2 Conducted Emission Measurement .....	42
4.2.1 Limits of Conducted Emission Measurement .....	42
4.2.2 Test Instruments .....	42
4.2.3 Test Procedure .....	43
4.2.4 Deviation from Test Standard .....	43
4.2.5 Test Setup.....	43
4.2.6 EUT Operating Condition .....	43
4.2.7 Test Results .....	44
4.3 Transmit Power Measurement .....	46
4.3.1 Limits of Transmit Power Measurement .....	46
4.3.2 Test Setup.....	46
4.3.3 Test Instruments .....	46
4.3.4 Test Procedure .....	46
4.3.5 Deviation from Test Standard .....	46
4.3.6 EUT Operating Condition .....	46
4.3.7 Test Results .....	47
4.4 Occupied Bandwidth Measurement .....	49
4.4.1 Test Setup.....	49
4.4.2 Test Instruments .....	49
4.4.3 Test Procedure .....	49
4.4.4 Test Results .....	50
4.5 Peak Power Spectral Density Measurement .....	56
4.5.1 Limits of Peak Power Spectral Density Measurement .....	56
4.5.2 Test Setup.....	56
4.5.3 Test Instruments .....	56
4.5.4 Test Procedure .....	56
4.5.5 Deviation from Test Standard .....	57
4.5.6 EUT Operating Condition .....	57
4.5.7 Test Results .....	58
4.6 Frequency Stability Measurement .....	62
4.6.1 Limits of Frequency Stability Measurement .....	62

4.6.2	Test Setup.....	62
4.6.3	Test Instruments .....	62
4.6.4	Test Procedure .....	62
4.6.5	Deviation from Test Standard .....	62
4.6.6	EUT Operating Condition .....	62
4.6.7	Test Results .....	63
4.7	6dB Bandwidth Measurement.....	64
4.7.1	Limits of 6dB Bandwidth Measurement.....	64
4.7.2	Test Setup.....	64
4.7.3	Test Instruments .....	64
4.7.4	Test Procedure .....	64
4.7.5	Deviation from Test Standard .....	64
4.7.6	EUT Operating Condition .....	64
4.7.7	Test Results .....	65
<b>5</b>	<b>Pictures of Test Arrangements.....</b>	<b>67</b>
	<b>Annex A- Radiated Out of Band Emission (OOBE) Measurement (For U-NII-3 band).....</b>	<b>68</b>
	<b>Annex B- Band-edge measurement (For U-NII-1 band) .....</b>	<b>71</b>
	<b>Appendix – Information of the Testing Laboratories .....</b>	<b>75</b>

### Release Control Record

Issue No.	Description	Date Issued
RF200203E11-1	Original release.	Apr. 01, 2020

## 1 Certificate of Conformity

**Product:** AC1900 LTE Router  
**Brand:** Motorola  
**Test Model:** ML2410  
**Series Model:** ML2410XY  
(where both X and Y can be A, B, C, D or blank. )  
**Sample Status:** ENGINEERING SAMPLE  
**Applicant:** MTRLC LLC  
**Test Date:** Feb. 19 to Mar. 05, 2020  
**Standard:** 47 CFR FCC Part 15, Subpart E (Section 15.407)  
ANSI C63.10: 2013

The above equipment has been tested by **Bureau Veritas Consumer Products Services (H.K.) Ltd., Taoyuan Branch**, and found compliance with the requirement of the above standards. The test record, data evaluation & Equipment Under Test (EUT) configurations represented herein are true and accurate accounts of the measurements of the sample's EMC characteristics under the conditions specified in this report.

**Prepared by :** Joyce Kuo , **Date:** Apr. 01, 2020  
Joyce Kuo / Specialist

**Approved by :** Clark Lin , **Date:** Apr. 01, 2020  
Clark Lin / Technical Manager

## 2 Summary of Test Results

47 CFR FCC Part 15, Subpart E (Section 15.407)			
FCC Clause	Test Item	Result	Remarks
15.407(b)(6)	AC Power Conducted Emissions	Pass	Meet the requirement of limit. Minimum passing margin is -5.04dB at 20.26172MHz.
15.407(b) (1/2/3/4(i/ii)/6)	Radiated Emissions & Band Edge Measurement*	Pass	Meet the requirement of limit. Minimum passing margin is -0.1dB at 5150.00MHz.
15.407(a)(1/2/3)	Max Average Transmit Power	Pass	Meet the requirement of limit.
---	Occupied Bandwidth Measurement	-	Reference only.
15.407(a)(1/2/3)	Peak Power Spectral Density	Pass	Meet the requirement of limit.
15.407(e)	6dB bandwidth	Pass	Meet the requirement of limit. (U-NII-3 Band only)
15.407(g)	Frequency Stability	Pass	Meet the requirement of limit.
15.203	Antenna Requirement	Pass	Antenna connector is i-pex(MHF) not a standard connector.

\*For U-NII-3 band compliance with rule part 15.407(b)(4)(i), the OOB test plots were recorded in Annex A.

Note:

Determining compliance based on the results of the compliance measurement, not taking into account measurement instrumentation uncertainty.

### 2.1 Measurement Uncertainty

Where relevant, the following measurement uncertainty levels have been estimated for tests performed on the EUT as specified in CISPR 16-4-2:

Measurement	Frequency	Expanded Uncertainty (k=2) (±)
Conducted Emissions at mains ports	150kHz ~ 30MHz	1.8 dB
Radiated Emissions up to 1 GHz	9kHz ~ 30MHz	3.0 dB
	30MHz ~ 1GHz	5.1 dB
Radiated Emissions above 1 GHz	1GHz ~ 6GHz	5.1 dB
	6GHz ~ 18GHz	5.0 dB
	18GHz ~ 40GHz	5.2 dB

### 2.2 Modification Record

There were no modifications required for compliance.

### 3 General Information

#### 3.1 General Description of EUT

Product	AC1900 LTE Router
Brand	Motorola
Test Model	ML2410
Series Model	ML2410XY (where both X and Y can be A, B, C, D or blank. )
Status of EUT	ENGINEERING SAMPLE
Power Supply Rating	12Vdc from power adapter or 7.2Vdc from battery
Modulation Type	CCK, DQPSK, DBPSK for DSSS 64QAM, 16QAM, QPSK, BPSK for OFDM 256QAM for OFDM in 11ac mode and VHT20/40 in 2.4GHz
Modulation Technology	DSSS,OFDM
Transfer Rate	802.11b: up to 11 Mbps 802.11a/g: up to 54 Mbps 802.11n: up to 450 Mbps 802.11ac: up to 1300 Mbps
Operating Frequency	<b>2.4GHz:</b> 2.412 ~ 2.462GHz <b>5GHz:</b> 5.18 ~ 5.24GHz, 5.745 ~ 5.825GHz
Number of Channel	<b>2.4GHz:</b> 802.11b, 802.11g, 802.11n (HT20): 11 802.11n (HT40): 7 <b>5GHz:</b> 802.11a, 802.11n (HT20), 802.11ac (VHT20): 9 802.11n (HT40), 802.11ac (VHT40): 4 802.11ac (VHT80): 2
Output Power	<b>CDD Mode:</b> <b>2.412 ~ 2.462 GHz:</b> 938.289 mW <b>5.18 ~ 5.24GHz:</b> 807.114mW <b>5.745 ~ 5.825GHz:</b> 969.735mW <b>Beamforming Mode:</b> <b>2.412 ~ 2.462 GHz:</b> 499.446 mW <b>5.18 ~ 5.24GHz:</b> 465.097mW <b>5.745 ~ 5.825GHz:</b> 411.179mW
Antenna Type	Refer to Note
Antenna Connector	Refer to Note
Accessory Device	Adapter × 1, Battery x1
Cable Supplied	Ethernet cable x1 (Unshielded, 1.5m)

Note:

1. This report is record NII (U-NII-1 and U-NII-3) band test, DTS-WLAN band test is record in Report No.: RF200203E11 and NII (U-NII-2A and U-NII-2C) band test is record in Report No.: RF200203E11A-1.

2. The EUT contains certified WWAN module which FCC ID: XMR201808EC25AF (Brand: Quectel; Model: EC25-AF)
3. The EUT has below model names, which are identical to each other in all aspects except for the following table:

Brand	Model No.	Description
Motorola	ML2410	For marketing purposes of identical hardware.
	ML2410XY (where both X and Y can be A, B, C, D or blank)	

From the above models, model: **ML2410** was selected as representative model for the test and its data was recorded in this report.

4. The EUT has below radios as following table:

Radio 1	Radio 2	Radio 3
WLAN (2.4GHz)	WLAN (5GHz)	WWAN

5. Simultaneously transmission condition.

Condition	Technology
1	WWAN + WLAN (2.4GHz) + WLAN (5GHz)
2	WWAN + WLAN (2.4GHz)
3	WWAN + WLAN (5GHz)
4	WLAN (2.4GHz) + WLAN (5GHz)

Note: The emission of the simultaneous operation has been evaluated and no non-compliance was found.

6. The EUT must be supplied with a power and the following different models could be chosen:

Adapter			
No	Brand	Model No.	Spec.
1	T&W ELECTRONICS	S36B52-120A300-04	Input: 100-240V, 1A, 50-60Hz Output: 12V, 3A DC output cable (Unshielded, 1.5 m)
2	HON-KWANG ELECTRIC CO., LTD.	HK-BE-120A300-US (HKSC-190178)	Input: 100-240V, 1A, 50-60Hz Output: 12V, 3A DC output cable (Unshielded, 1.5 m)
3	HON-KWANG ELECTRIC CO., LTD.	HK-BE-120A300-US (HKSC-190147)	Input: 100-240V, 1A, 50-60Hz Output: 12V, 3A DC output cable (Unshielded, 1.5 m)
Battery			
No	Brand	Model No.	Spec.
1	Getac Technolog(Kunshan) Co.,LTD	BP-15033-22/2150 S	7.2V 4.3Ah 30.96Wh

Note:

- The adapter 3 is as same as adapter 2; except for DC plug is different.
- From the above adapters, the AC Power Conducted Emissions test worst case was found in **Adapter No.: 1**. Therefore only the test data of the mode was recorded in this report.
- From the above adapters and battery, the Radiated Emissions test worst case was found in **Adapter No.: 1**. Therefore only the test data of the mode was recorded in this report.



7. The antennas provided to the EUT, please refer to the following table:

WLAN Antenna							
Ant. No.	RF Chain No.	Brand	Ant. Net Gain	Frequency Range (GHz)	Antenna Type	Connector Type	Cable Length (mm)
1	WiFi Chain0	Airgain	4.3 dBi, 4.3 dBi, 5.5 dBi	2.4 to 2.49, 5.15 to 5.35, 5.47 to 5.85	PCB	i-pex(MHF)	140
2	WiFi Chain1	Airgain	3.2 dBi, 4.4 dBi, 4.1 dBi	2.4 to 2.49, 5.15 to 5.35, 5.47 to 5.85	PCB	i-pex(MHF)	170
3	WiFi Chain2	Airgain	4.6 dBi, 4.9 dBi, 5.4 dBi	2.4 to 2.49, 5.15 to 5.35, 5.47 to 5.85	PCB	i-pex(MHF)	100
WWAN Antenna							
Ant. No.	RF Chain No.	Brand	Ant. Net Gain	Frequency Range (MHz)	Antenna Type	Connector Type	Cable Length (mm)
1	LTE MAIN	Cortec	1.08 dBi 3.19 dBi	617 ~ 894 1710 ~ 2200	Dipole	SMA	280
2	LTE AUX	Cortec	1.08 dBi 3.19 dBi	617 ~ 894 1710 ~ 2200	Dipole	SMA	200

8. The EUT incorporates a MIMO function.

2.4GHz Band		
MODULATION MODE	TX & RX CONFIGURATION	
802.11b	3TX	3RX
802.11g	3TX	3RX
802.11n (HT20)	3TX	3RX
802.11n (HT40)	3TX	3RX
VHT20	3TX	3RX
VHT40	3TX	3RX
5GHz Band		
MODULATION MODE	TX & RX CONFIGURATION	
802.11a	3TX	3RX
802.11n (HT20)	3TX	3RX
802.11n (HT40)	3TX	3RX
802.11ac (VHT20)	3TX	3RX
802.11ac (VHT40)	3TX	3RX
802.11ac (VHT80)	3TX	3RX

Note:

- All of modulation mode support beamforming function except 802.11a/b/g modulation mode.
- The EUT support Beamforming and non-beamforming mode, therefore both mode were investigated and the worst case scenario was identified. The worst case data were presented in test report.
- The modulation and bandwidth are similar for 802.11n mode for 20MHz (40MHz) and 802.11ac mode for 20MHz (40MHz), the manufacturer will control the power for 802.11n mode is the same as the 802.11ac or more lower than it and investigated worst case to representative mode in test report. (Final test mode refer to section 3.2.1)

9. The above EUT information is declared by manufacturer and for more detailed features description, please refers to the manufacturer's specifications or user's manual.

### 3.2 Description of Test Modes

#### FOR 5180 ~ 5240MHz

4 channels are provided for 802.11a, 802.11n (HT20), 802.11ac (VHT20):

Channel	Frequency	Channel	Frequency
36	5180 MHz	44	5220 MHz
40	5200 MHz	48	5240 MHz

2 channels are provided for 802.11n (HT40), 802.11ac (VHT40):

Channel	Frequency	Channel	Frequency
38	5190 MHz	46	5230 MHz

1 channel is provided for 802.11ac (VHT80):

Channel	Frequency
42	5210 MHz

#### FOR 5745 ~ 5825MHz:

5 channels are provided for 802.11a, 802.11n (HT20), 802.11ac (VHT20):

Channel	Frequency	Channel	Frequency
149	5745 MHz	161	5805 MHz
153	5765 MHz	165	5825 MHz
157	5785 MHz		

2 channels are provided for 802.11n (HT40), 802.11ac (VHT40):

Channel	Frequency	Channel	Frequency
151	5755 MHz	159	5795 MHz

1 channel is provided for 802.11ac (VHT80):

Channel	Frequency
155	5775 MHz

### 3.2.1 Test Mode Applicability and Tested Channel Detail

EUT Configure Mode	Applicable To				Description
	RE $\geq$ 1G	RE<1G	PLC	APCM	
-	√	√	√	√	-

Where **RE $\geq$ 1G**: Radiated Emission above 1GHz  
**RE<1G**: Radiated Emission below 1GHz  
**PLC**: Power Line Conducted Emission  
**APCM**: Antenna Port Conducted Measurement

#### **Radiated Emission Test (Above 1GHz):**

- Pre-Scan has been conducted to determine the worst-case mode from all possible combinations between available modulations, data rates and antenna ports (if EUT with antenna diversity architecture).
- Following channel(s) was (were) selected for the final test as listed below.

CDD Mode						
Mode	FREQ. Band (MHz)	Available Channel	Tested Channel	Modulation Technology	Modulation Type	Data Rate (Mbps)
802.11a	5180-5240	36 to 48	36, 40, 48	OFDM	BPSK	6
802.11ac (VHT20)		36 to 48	36, 40, 48	OFDM	BPSK	6.5
802.11ac (VHT40)		38 to 46	38, 46	OFDM	BPSK	13.5
802.11ac (VHT80)		42	42	OFDM	BPSK	29.3
802.11a	5745-5825	149 to 165	149, 157, 165	OFDM	BPSK	6
802.11ac (VHT20)		149 to 165	149, 157, 165	OFDM	BPSK	6.5
802.11ac (VHT40)		151 to 159	151, 159	OFDM	BPSK	13.5
802.11ac (VHT80)		155	155	OFDM	BPSK	29.3

#### **Radiated Emission Test (Below 1GHz):**

- Pre-Scan has been conducted to determine the worst-case mode from all possible combinations between available modulations, data rates and antenna ports (if EUT with antenna diversity architecture).
- Following channel(s) was (were) selected for the final test as listed below.

CDD Mode						
Mode	FREQ. Band (MHz)	Available Channel	Tested Channel	Modulation Technology	Modulation Type	Data Rate (Mbps)
802.11a	5180-5240 5745-5825	36 to 48 149 to 165	165	OFDM	BPSK	6

### Power Line Conducted Emission Test:

- Pre-Scan has been conducted to determine the worst-case mode from all possible combinations between available modulations, data rates and antenna ports (if EUT with antenna diversity architecture).
- Following channel(s) was (were) selected for the final test as listed below.

CDD Mode						
Mode	FREQ. Band (MHz)	Available Channel	Tested Channel	Modulation Technology	Modulation Type	Data Rate (Mbps)
802.11a	5180-5240 5745-5825	36 to 48 149 to 165	165	OFDM	BPSK	6

### Antenna Port Conducted Measurement:

- This item includes all test value of each mode, but only includes spectrum plot of worst value of each mode.
- Pre-Scan has been conducted to determine the worst-case mode from all possible combinations between available modulations, data rates and antenna ports (if EUT with antenna diversity architecture).
- Following channel(s) was (were) selected for the final test as listed below.

CDD Mode						
Mode	FREQ. Band (MHz)	Available Channel	Tested Channel	Modulation Technology	Modulation Type	Data Rate (Mbps)
802.11a	5180-5240	36 to 48	36, 40, 48	OFDM	BPSK	6
802.11ac (VHT20)		36 to 48	36, 40, 48	OFDM	BPSK	6.5
802.11ac (VHT40)		38 to 46	38, 46	OFDM	BPSK	13.5
802.11ac (VHT80)		42	42	OFDM	BPSK	29.3
802.11a	5745-5825	149 to 165	149, 157, 165	OFDM	BPSK	6
802.11ac (VHT20)		149 to 165	149, 157, 165	OFDM	BPSK	6.5
802.11ac (VHT40)		151 to 159	151, 159	OFDM	BPSK	13.5
802.11ac (VHT80)		155	155	OFDM	BPSK	29.3
Beamforming Mode (output power only)						
Mode	FREQ. Band (MHz)	Available Channel	Tested Channel	Modulation Technology	Modulation Type	Data Rate (Mbps)
802.11ac (VHT20)	5180-5240	36 to 48	36, 40, 48	OFDM	BPSK	6.5
802.11ac (VHT40)		38 to 46	38, 46	OFDM	BPSK	13.5
802.11ac (VHT80)		42	42	OFDM	BPSK	29.3
802.11ac (VHT20)	5745-5825	149 to 165	149, 157, 165	OFDM	BPSK	6.5
802.11ac (VHT40)		151 to 159	151, 159	OFDM	BPSK	13.5
802.11ac (VHT80)		155	155	OFDM	BPSK	29.3

### Test Condition:

Applicable To	Environmental Conditions	Input Power	Tested By
RE $\geq$ 1G	23deg. C, 67%RH	120Vac, 60Hz	Ryan Du
RE $<$ 1G	23deg. C, 63%RH	120Vac, 60Hz	Kevin Ko
PLC	25deg. C, 75%RH	120Vac, 60Hz	Kevin Ko
APCM	25deg. C, 60%RH	120Vac, 60Hz	Anderson Chen

### 3.3 Duty Cycle of Test Signal

If duty cycle of test signal is < 98%, duty factor shall be considered.

**802.11a:** Duty cycle = 1.395 ms/1.458 ms = 0.957, Duty factor = 10 \* log (1/Duty cycle) = 0.19

**802.11ac (VHT20):** Duty cycle = 1.314 ms/1.378 ms = 0.954, Duty factor = 10 \* log (1/Duty cycle) = 0.21

**802.11ac (VHT40):** Duty cycle = 0.655 ms/0.718 ms = 0.912, Duty factor = 10 \* log (1/Duty cycle) = 0.40

**802.11ac (VHT80):** Duty cycle = 0.323 ms/0.385 ms = 0.76, Duty factor = 10 \* log (1/Duty cycle) = 0.76

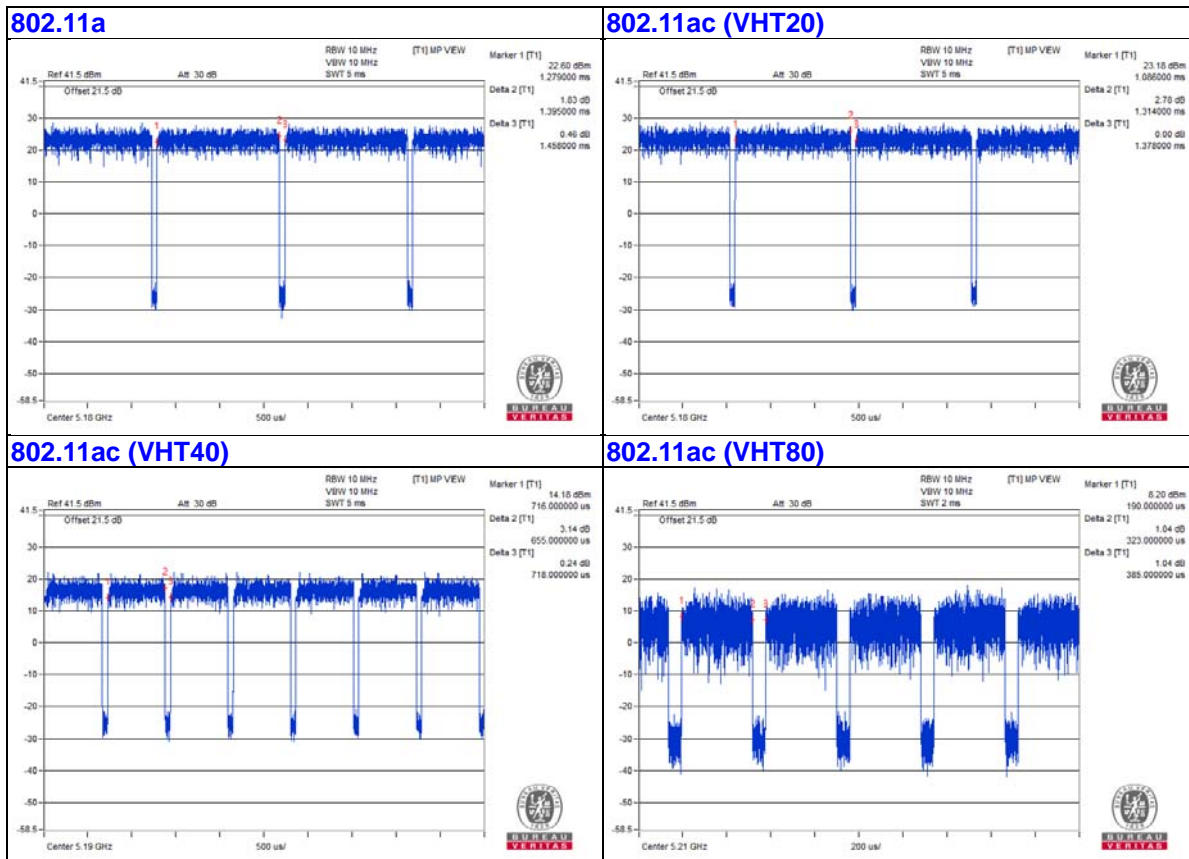

### 3.4 Description of Support Units

The EUT has been tested as an independent unit together with other necessary accessories or support units. The following support units or accessories were used to form a representative test configuration during the tests.

ID	Product	Brand	Model No.	Serial No.	FCC ID	Remarks
A.	Laptop	DELL	E5430	HYV4VY1	FCC DoC	Provided by Lab
B.	Laptop	SONY	SVS151A12P	275548477001150	NA	Provided by Lab
C.	Laptop	DELL	E5430	4N1SKV1	FCC DoC	Provided by Lab
D.	USB Dongle	Sandisk	128G	NA	NA	Provided by Lab
E.	SIM Card	Anritsu	NA	NA	NA	Provided by Lab

Note:

1. All power cords of the above support units are non-shielded (1.8m).

ID	Descriptions	Qty.	Length (m)	Shielding (Yes/No)	Cores (Qty.)	Remarks
1.	DC Cable	1	1.5	No	0	Supplied by client
2.	RJ-45 Cable	1	1.5	No	0	Supplied by client
3.	RJ-45 Cable	1	10	No	0	Provided by Lab
4.	RJ-45 Cable	1	10	No	0	Provided by Lab
5.	RJ-45 Cable	1	10	No	0	Provided by Lab

### 3.4.1 Configuration of System under Test

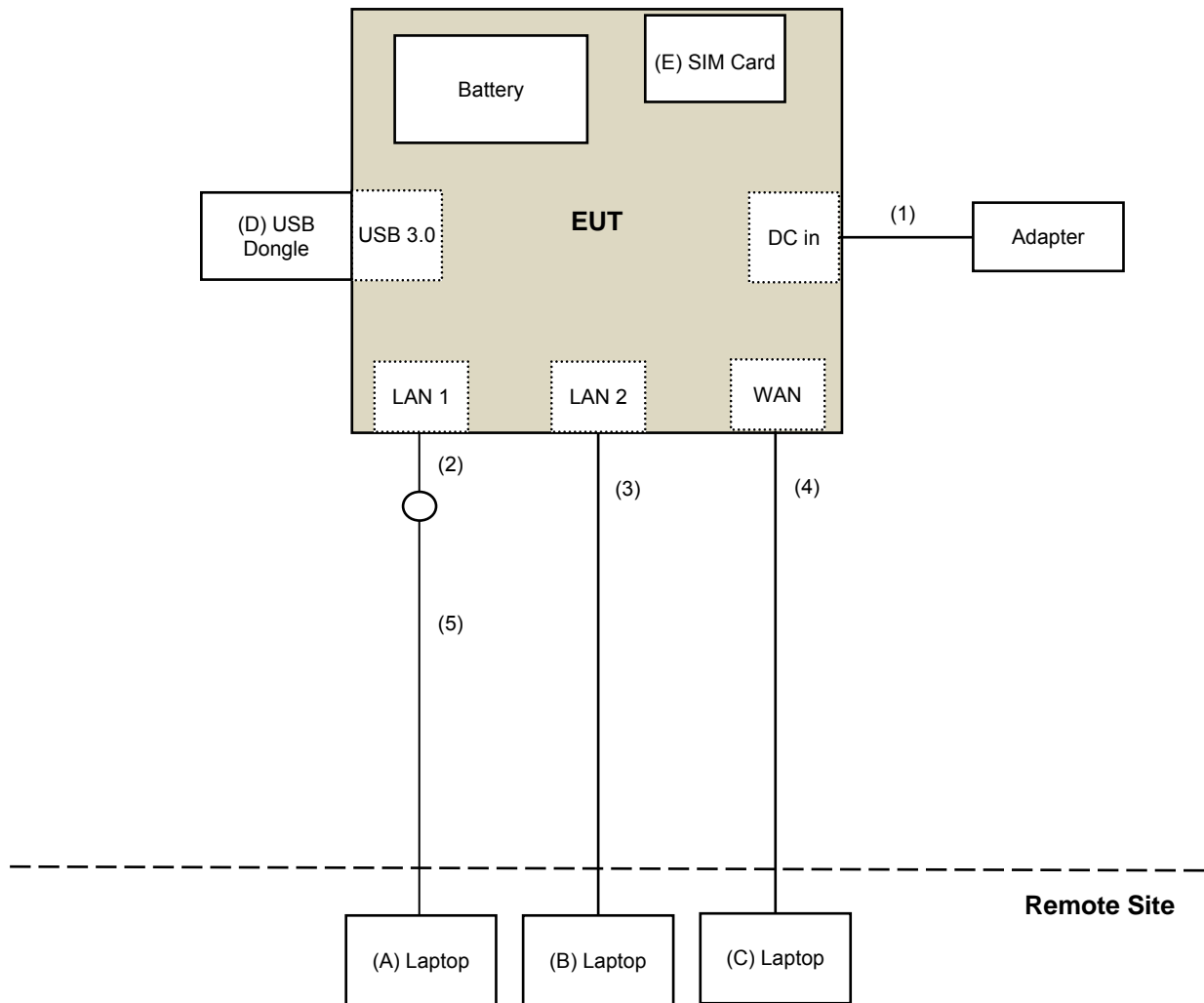

### **3.5 General Description of Applied Standard and references**

The EUT is a RF Product. According to the specifications of the manufacturer, it must comply with the requirements of the following standards and references:

**Test Standard:**

**FCC Part 15, Subpart E (15.407)**  
**ANSI C63.10-2013**

All test items have been performed and recorded as per the above standards.

**References Test Guidance:**

**KDB 789033 D02 General UNII Test Procedure New Rules v02r01**  
**KDB 662911 D01 Multiple Transmitter Output v02r01**

All test items have been performed as a reference to the above KDB test guidance.



## 4 Test Types and Results

### 4.1 Radiated Emission and Bandedge Measurement

#### 4.1.1 Limits of Radiated Emission and Bandedge Measurement

Radiated emissions which fall in the restricted bands must comply with the radiated emission limits specified as below table.

Frequencies (MHz)	Field Strength (microvolts/meter)	Measurement Distance (meters)
0.009 ~ 0.490	2400/F(kHz)	300
0.490 ~ 1.705	24000/F(kHz)	30
1.705 ~ 30.0	30	30
30 ~ 88	100	3
88 ~ 216	150	3
216 ~ 960	200	3
Above 960	500	3

#### NOTE:

1. The lower limit shall apply at the transition frequencies.
2. Emission level (dBuV/m) = 20 log Emission level (uV/m).
3. For frequencies above 1000MHz, the field strength limits are based on average detector, however, the peak field strength of any emission shall not exceed the maximum permitted average limits, specified above by more than 20dB under any condition of modulation.

Limits of unwanted emission out of the restricted bands

Applicable To		Limit	
789033 D02 General UNII Test Procedure New Rules v02r01		Field Strength at 3m	
		PK:74 (dBuV/m)	AV:54 (dBuV/m)
Frequency Band	Applicable To	EIRP Limit	Equivalent Field Strength at 3m
5150~5250 MHz	15.407(b)(1)	PK:-27 (dBm/MHz)	PK:68.2(dBuV/m)
5250~5350 MHz	15.407(b)(2)		
5470~5725 MHz	15.407(b)(3)		
5725~5850 MHz	15.407(b)(4)(i)	PK:-27 (dBm/MHz) <sup>*1</sup> PK:10 (dBm/MHz) <sup>*2</sup> PK:15.6 (dBm/MHz) <sup>*3</sup> PK:27 (dBm/MHz) <sup>*4</sup>	PK: 68.2(dBuV/m) <sup>*1</sup> PK:105.2 (dBuV/m) <sup>*2</sup> PK: 110.8(dBuV/m) <sup>*3</sup> PK:122.2 (dBuV/m) <sup>*4</sup>
*1 beyond 75 MHz or more above of the band edge.		*2 below the band edge increasing linearly to 10 dBm/MHz at 25 MHz above.	
*3 below the band edge increasing linearly to a level of 15.6 dBm/MHz at 5 MHz above.		*4 from 5 MHz above or below the band edge increasing linearly to a level of 27 dBm/MHz at the band edge.	

#### Note:

The following formula is used to convert the equipment isotropic radiated power (eirp) to field strength:

$$E = \frac{1000000\sqrt{30P}}{3} \mu\text{V/m, where P is the eirp (Watts).}$$

## 4.1.2 Test Instruments

Description & Manufacturer	Model no.	Serial No.	Calibrated DATE	Calibrated Until
Test Receiver Keysight	N9038A	MY54450088	July 03, 2019	July 02, 2020
Pre-Amplifier EMCI	EMC001340	980142	May 30, 2019	May 29, 2020
Loop Antenna Electro-Metrics	EM-6879	269	Sep. 16, 2019	Sep. 15, 2020
RF Cable	NA	LOOPCAB-001	Jan. 08, 2020	Jan. 07, 2021
RF Cable	NA	LOOPCAB-002	Jan. 08, 2020	Jan. 07, 2021
Pre-Amplifier Mini-Circuits	ZFL-1000VH2B	AMP-ZFL-05	Apr. 30, 2019	Apr. 29, 2020
Trilog Broadband Antenna SCHWARZBECK	VULB 9168	9168-361	Nov. 11, 2019	Nov. 10, 2020
RF Cable	8D	966-3-1	Mar. 18, 2019	Mar. 17, 2020
RF Cable	8D	966-3-2	Mar. 18, 2019	Mar. 17, 2020
RF Cable	8D	966-3-3	Mar. 18, 2019	Mar. 17, 2020
Fixed attenuator Mini-Circuits	UNAT-5+	PAD-3m-3-01	Sep. 26, 2019	Sep. 25, 2020
Horn_Antenna SCHWARZBECK	BBHA9120-D	9120D-406	Nov. 24, 2019	Nov. 23, 2020
Pre-Amplifier EMCI	EMC12630SE	980384	Jan. 15, 2020	Jan. 14, 2021
RF Cable	EMC104-SM-SM-1200	160922	Jan. 15, 2020	Jan. 14, 2021
RF Cable	EMC104-SM-SM-2000	180601	June 10, 2019	June 09, 2020
RF Cable	EMC104-SM-SM-6000	180602	June 10, 2019	June 09, 2020
Spectrum Analyzer Keysight	N9030A	MY54490679	July 17, 2019	July 16, 2020
Pre-Amplifier EMCI	EMC184045SE	980387	Jan. 15, 2020	Jan. 14, 2021
Horn_Antenna SCHWARZBECK	BBHA 9170	BBHA9170519	Nov. 24, 2019	Nov. 23, 2020
RF Cable	EMC102-KM-KM-1200	160924	Jan. 15, 2020	Jan. 14, 2021
RF Cable	EMC102-KM-KM-4500	181205	Aug. 26, 2019	Aug. 25, 2020
Software	ADT_Radiated_V8.7.08	NA	NA	NA
Antenna Tower & Turn Table Max-Full	MF-7802	MF780208406	NA	NA
Boresight Antenna Fixture	FBA-01	FBA-SIP01	NA	NA
Spectrum Analyzer R&S	FSV40	100964	June 04, 2019	June 03, 2020
Power meter Anritsu	ML2495A	1014008	May 13, 2019	May 12, 2020
Power sensor Anritsu	MA2411B	0917122	May 13, 2019	May 12, 2020
Fixed Attenuator Mini-Circuits	MDCS18N-10	MDCS18N-10-01	Apr. 15, 2019	Apr. 14, 2020

AC Power Source Extech Electronics	6205	1440452	NA	NA
Temperature & Humidity Chamber Giant Force	GTH-150-40-SP-AR	MAA0812-008	Jan. 16, 2020	Jan. 15, 2021
True RMS Clamp Meter FLUKE	325	31130711WS	May 21, 2019	May 20, 2020

**Note:**

1. The calibration interval of the above test instruments is 12 months and the calibrations are traceable to NML/ROC and NIST/USA.
2. The test was performed in 966 Chamber No. 3.
3. Loop antenna was used for all emissions below 30 MHz.
4. Tested Date: Feb. 19 ot Mar. 05, 2020

4.1.3 Test Procedure

**For Radiated emission below 30MHz**

- a. The EUT was placed on the top of a rotating table 0.8 meters above the ground at a 3 meter chamber room. The table was rotated 360 degrees to determine the position of the highest radiation.
- b. The EUT was set 3 meters away from the interference-receiving antenna, which was mounted on the top of a variable-height antenna tower.
- c. Parallel, perpendicular, and ground-parallel orientations of the antenna are set to make the measurement.
- d. For each suspected emission, the EUT was arranged to its worst case and the rotatable table was turned from 0 degrees to 360 degrees to find the maximum reading.
- e. The test-receiver system was set to Quasi-Peak Detect Function and Specified Bandwidth with Maximum Hold Mode.

**Note:**

1. The resolution bandwidth and video bandwidth of test receiver/spectrum analyzer is 9kHz at frequency below 30MHz.

**For Radiated emission above 30MHz**

- a. The EUT was placed on the top of a rotating table 0.8 meters (for 30MHz ~ 1GHz) / 1.5 meters (for above 1GHz) above the ground at 3 meter chamber room for test. The table was rotated 360 degrees to determine the position of the highest radiation.
- b. The EUT was set 3 meters away from the interference-receiving antenna, which was mounted on the top of a variable-height antenna tower.
- c. The height of antenna is varied from one meter to four meters above the ground to determine the maximum value of the field strength. Both horizontal and vertical polarizations of the antenna are set to make the measurement.
- d. For each suspected emission, the EUT was arranged to its worst case and then the antenna was tuned to heights from 1 meter to 4 meters and the rotatable table was turned from 0 degrees to 360 degrees to find the maximum reading.
- e. The test-receiver system was set to quasi-peak detect function and specified bandwidth with maximum hold mode when the test frequency is below 1 GHz.
- f. The test-receiver system was set to peak and average detects function and specified bandwidth with maximum hold mode when the test frequency is above 1 GHz. If the peak reading value also meets average limit, measurement with the average detector is unnecessary.

**Note:**

1. The resolution bandwidth and video bandwidth of test receiver/spectrum analyzer is 120kHz for Quasi-peak detection (QP) at frequency below 1GHz.
2. The resolution bandwidth of test receiver/spectrum analyzer is 1 MHz and the video bandwidth is 3 MHz for Peak detection (PK) at frequency above 1GHz.
3. The resolution bandwidth of test receiver/spectrum analyzer is 1MHz and the video bandwidth is  $\geq 1/T$  (Duty cycle  $< 98\%$ ) or 10Hz (Duty cycle  $\geq 98\%$ ) for Average detection (AV) at frequency above 1GHz.
4. All modes of operation were investigated and the worst-case emissions are reported.

4.1.4 Deviation from Test Standard

No deviation.

4.1.5 Test Setup

**For Radiated emission below 30MHz**

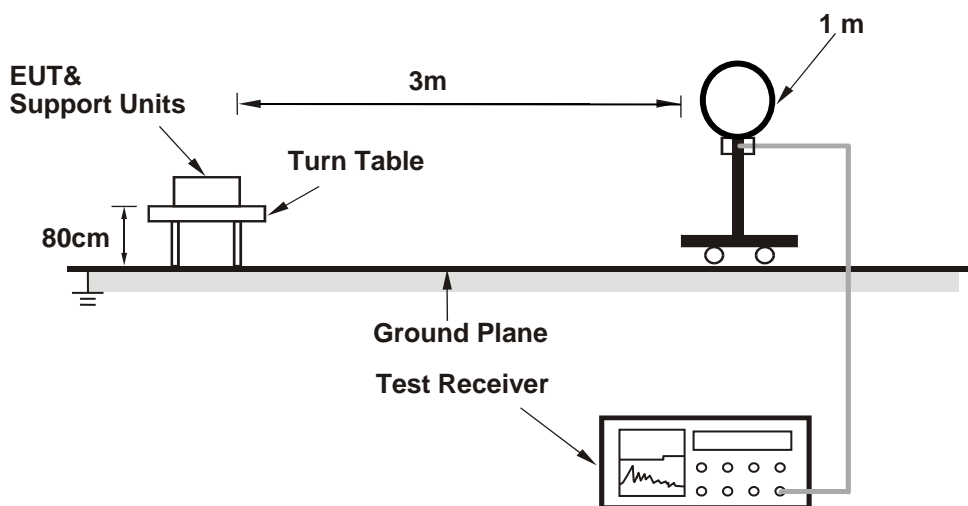

**For Radiated emission 30MHz to 1GHz**

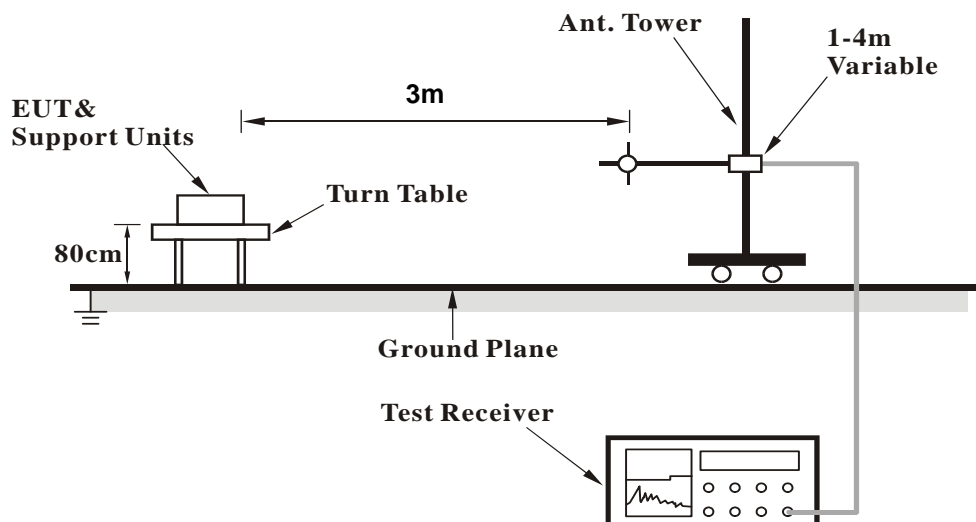

**For Radiated emission above 1GHz**

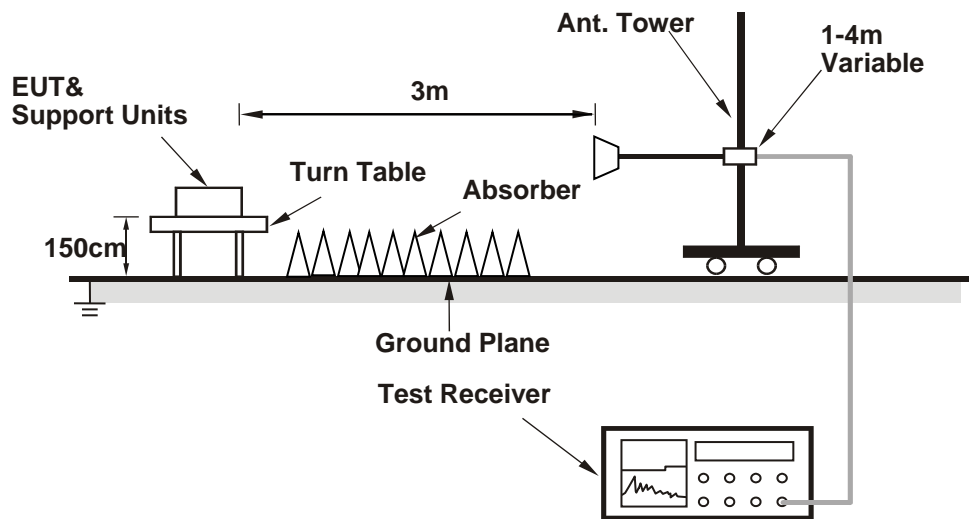

For the actual test configuration, please refer to the attached file (Test Setup Photo).

#### 4.1.6 EUT Operating Condition

- a. Connected the EUT with the Laptop Computer which is placed on remote site.
- b. Controlling software (package\_Ulv2.05\_DLLv4.08\_20190312) has been activated to set the EUT under transmission condition continuously at specific channel frequency.

## 4.1.7 Test Results

## Above 1GHz Data:

## 802.11a

<b>CHANNEL</b>	TX Channel 36	<b>DETECTOR FUNCTION</b>	Peak (PK)
<b>FREQUENCY RANGE</b>	1GHz ~ 40GHz		Average (AV)

ANTENNA POLARITY & TEST DISTANCE: HORIZONTAL AT 3 M								
NO.	FREQ. (MHz)	EMISSION LEVEL (dBuV/m)	LIMIT (dBuV/m)	MARGIN (dB)	ANTENNA HEIGHT (m)	TABLE ANGLE (Degree)	RAW VALUE (dBuV)	CORRECTION FACTOR (dB/m)
1	5150.00	65.4 PK	74.0	-8.6	1.00 H	190	62.4	3.0
2	5150.00	53.2 AV	54.0	-0.8	1.00 H	190	50.2	3.0
3	*5180.00	119.7 PK			1.00 H	190	116.8	2.9
4	*5180.00	110.8 AV			1.00 H	190	107.9	2.9
5	#10360.00	52.1 PK	68.2	-16.1	1.47 H	329	40.1	12.0
6	15540.00	46.5 PK	74.0	-27.5	1.53 H	163	33.5	13.0
7	15540.00	33.7 AV	54.0	-20.3	1.53 H	163	20.7	13.0
ANTENNA POLARITY & TEST DISTANCE: VERTICAL AT 3 M								
NO.	FREQ. (MHz)	EMISSION LEVEL (dBuV/m)	LIMIT (dBuV/m)	MARGIN (dB)	ANTENNA HEIGHT (m)	TABLE ANGLE (Degree)	RAW VALUE (dBuV)	CORRECTION FACTOR (dB/m)
1	5150.00	70.4 PK	74.0	-3.6	2.49 V	141	67.4	3.0
2	<b>5150.00</b>	<b>53.9 AV</b>	<b>54.0</b>	<b>-0.1</b>	<b>2.49 V</b>	<b>141</b>	<b>50.9</b>	<b>3.0</b>
3	*5180.00	122.5 PK			2.49 V	141	119.6	2.9
4	*5180.00	113.9 AV			2.49 V	141	111.0	2.9
5	#10360.00	53.4 PK	68.2	-14.8	3.89 V	262	41.4	12.0
6	15540.00	43.9 PK	74.0	-30.1	1.56 V	55	30.9	13.0
7	15540.00	33.5 AV	54.0	-20.5	1.56 V	55	20.5	13.0

## REMARKS:

1. Emission Level(dBuV/m) = Raw Value(dBuV) + Correction Factor(dB/m)
2. Correction Factor(dB/m) = Antenna Factor(dB/m) + Cable Factor(dB) – Pre-Amplifier Factor(dB)
3. Margin value = Emission Level – Limit value
4. The other emission levels were very low against the limit.
5. " \* ": Fundamental frequency.
6. " # ": The radiated frequency is out of the restricted band.

<b>CHANNEL</b>	TX Channel 40	<b>DETECTOR FUNCTION</b>	Peak (PK)
<b>FREQUENCY RANGE</b>	1GHz ~ 40GHz		Average (AV)

**ANTENNA POLARITY & TEST DISTANCE: HORIZONTAL AT 3 M**

NO.	FREQ. (MHz)	EMISSION LEVEL (dBuV/m)	LIMIT (dBuV/m)	MARGIN (dB)	ANTENNA HEIGHT (m)	TABLE ANGLE (Degree)	RAW VALUE (dBuV)	CORRECTION FACTOR (dB/m)
1	5150.00	64.8 PK	74.0	-9.2	1.01 H	183	61.8	3.0
2	5150.00	52.6 AV	54.0	-1.4	1.01 H	183	49.6	3.0
3	*5200.00	121.8 PK			1.01 H	183	119.0	2.8
4	*5200.00	113.0 AV			1.01 H	183	110.2	2.8
5	#10400.00	52.7 PK	68.2	-15.5	1.47 H	327	40.6	12.1
6	15600.00	48.2 PK	74.0	-25.8	1.51 H	153	35.3	12.9
7	15600.00	35.8 AV	54.0	-18.2	1.51 H	153	22.9	12.9

**ANTENNA POLARITY & TEST DISTANCE: VERTICAL AT 3 M**

NO.	FREQ. (MHz)	EMISSION LEVEL (dBuV/m)	LIMIT (dBuV/m)	MARGIN (dB)	ANTENNA HEIGHT (m)	TABLE ANGLE (Degree)	RAW VALUE (dBuV)	CORRECTION FACTOR (dB/m)
1	5150.00	66.6 PK	74.0	-7.4	2.47 V	142	63.6	3.0
2	5150.00	53.7 AV	54.0	-0.3	2.47 V	142	50.7	3.0
3	*5200.00	125.4 PK			2.47 V	142	122.6	2.8
4	*5200.00	116.7 AV			2.47 V	142	113.9	2.8
5	#10400.00	53.4 PK	68.2	-14.8	3.90 V	268	41.3	12.1
6	15600.00	45.4 PK	74.0	-28.6	1.56 V	45	32.5	12.9
7	15600.00	35.0 AV	54.0	-19.0	1.56 V	45	22.1	12.9

**REMARKS:**

1. Emission Level(dBuV/m) = Raw Value(dBuV) + Correction Factor(dB/m)
2. Correction Factor(dB/m) = Antenna Factor(dB/m) + Cable Factor(dB) – Pre-Amplifier Factor(dB)
3. Margin value = Emission Level – Limit value
4. The other emission levels were very low against the limit.
5. " \* ": Fundamental frequency.
6. " # ": The radiated frequency is out of the restricted band.

<b>CHANNEL</b>	TX Channel 48	<b>DETECTOR FUNCTION</b>	Peak (PK)
<b>FREQUENCY RANGE</b>	1GHz ~ 40GHz		Average (AV)

**ANTENNA POLARITY & TEST DISTANCE: HORIZONTAL AT 3 M**

NO.	FREQ. (MHz)	EMISSION LEVEL (dBuV/m)	LIMIT (dBuV/m)	MARGIN (dB)	ANTENNA HEIGHT (m)	TABLE ANGLE (Degree)	RAW VALUE (dBuV)	CORRECTION FACTOR (dB/m)
1	5150.00	62.5 PK	74.0	-11.5	1.00 H	189	59.5	3.0
2	5150.00	48.9 AV	54.0	-5.1	1.00 H	189	45.9	3.0
3	*5240.00	121.8 PK			1.00 H	189	119.2	2.6
4	*5240.00	112.9 AV			1.00 H	189	110.3	2.6
5	5350.00	59.5 PK	74.0	-14.5	1.00 H	189	56.9	2.6
6	5350.00	47.0 AV	54.0	-7.0	1.00 H	189	44.4	2.6
7	#10480.00	52.2 PK	68.2	-16.0	1.44 H	340	39.7	12.5
8	15720.00	48.2 PK	74.0	-25.8	1.51 H	164	36.0	12.2
9	15720.00	36.1 AV	54.0	-17.9	1.51 H	164	23.9	12.2

**ANTENNA POLARITY & TEST DISTANCE: VERTICAL AT 3 M**

NO.	FREQ. (MHz)	EMISSION LEVEL (dBuV/m)	LIMIT (dBuV/m)	MARGIN (dB)	ANTENNA HEIGHT (m)	TABLE ANGLE (Degree)	RAW VALUE (dBuV)	CORRECTION FACTOR (dB/m)
1	5150.00	60.0 PK	74.0	-14.0	2.47 V	132	57.0	3.0
2	5150.00	49.0 AV	54.0	-5.0	2.47 V	132	46.0	3.0
3	*5240.00	125.8 PK			2.47 V	132	123.2	2.6
4	*5240.00	116.5 AV			2.47 V	132	113.9	2.6
5	5350.00	59.3 PK	74.0	-14.7	2.47 V	132	56.7	2.6
6	5350.00	47.9 AV	54.0	-6.1	2.47 V	132	45.3	2.6
7	#10480.00	53.6 PK	68.2	-14.6	3.90 V	268	41.1	12.5
8	15720.00	44.8 PK	74.0	-29.2	1.61 V	55	32.6	12.2
9	15720.00	34.6 AV	54.0	-19.4	1.61 V	55	22.4	12.2

**REMARKS:**

1. Emission Level(dBuV/m) = Raw Value(dBuV) + Correction Factor(dB/m)
2. Correction Factor(dB/m) = Antenna Factor(dB/m) + Cable Factor(dB) – Pre-Amplifier Factor(dB)
3. Margin value = Emission Level – Limit value
4. The other emission levels were very low against the limit.
5. " \* ": Fundamental frequency.
6. " # ": The radiated frequency is out of the restricted band.



<b>CHANNEL</b>	TX Channel 149	<b>DETECTOR FUNCTION</b>	Peak (PK)
<b>FREQUENCY RANGE</b>	1GHz ~ 40GHz		Average (AV)

**ANTENNA POLARITY & TEST DISTANCE: HORIZONTAL AT 3 M**

NO.	FREQ. (MHz)	EMISSION LEVEL (dBuV/m)	LIMIT (dBuV/m)	MARGIN (dB)	ANTENNA HEIGHT (m)	TABLE ANGLE (Degree)	RAW VALUE (dBuV)	CORRECTION FACTOR (dB/m)
1	#5624.21	62.1 PK	68.2	-6.1	1.19 H	184	58.3	3.8
2	*5745.00	124.4 PK			1.19 H	184	121.1	3.3
3	*5745.00	114.8 AV			1.19 H	184	111.5	3.3
4	#5939.83	52.1 PK	68.2	-16.1	1.19 H	184	47.4	4.7
5	11490.00	52.8 PK	74.0	-21.2	1.47 H	329	40.2	12.6
6	11490.00	40.6 AV	54.0	-13.4	1.47 H	329	28.0	12.6
7	#17235.00	48.8 PK	68.2	-19.4	1.45 H	166	32.0	16.8

**ANTENNA POLARITY & TEST DISTANCE: VERTICAL AT 3 M**

NO.	FREQ. (MHz)	EMISSION LEVEL (dBuV/m)	LIMIT (dBuV/m)	MARGIN (dB)	ANTENNA HEIGHT (m)	TABLE ANGLE (Degree)	RAW VALUE (dBuV)	CORRECTION FACTOR (dB/m)
1	#5623.23	62.0 PK	68.2	-6.2	2.53 V	116	58.2	3.8
2	*5745.00	126.0 PK			2.53 V	116	122.7	3.3
3	*5745.00	117.1 AV			2.53 V	116	113.8	3.3
4	#5983.96	55.4 PK	68.2	-12.8	2.53 V	116	50.6	4.8
5	11490.00	53.1 PK	74.0	-20.9	3.90 V	273	40.5	12.6
6	11490.00	40.7 AV	54.0	-13.3	3.90 V	273	28.1	12.6
7	#17235.00	45.2 PK	68.2	-23.0	1.61 V	41	28.4	16.8

**REMARKS:**

1. Emission Level(dBuV/m) = Raw Value(dBuV) + Correction Factor(dB/m)
2. Correction Factor(dB/m) = Antenna Factor(dB/m) + Cable Factor(dB) – Pre-Amplifier Factor(dB)
3. Margin value = Emission Level – Limit value
4. The other emission levels were very low against the limit.
5. " \* ": Fundamental frequency.
6. " # ": The radiated frequency is out of the restricted band.

<b>CHANNEL</b>	TX Channel 157	<b>DETECTOR FUNCTION</b>	Peak (PK)
<b>FREQUENCY RANGE</b>	1GHz ~ 40GHz		Average (AV)

**ANTENNA POLARITY & TEST DISTANCE: HORIZONTAL AT 3 M**

NO.	FREQ. (MHz)	EMISSION LEVEL (dBuV/m)	LIMIT (dBuV/m)	MARGIN (dB)	ANTENNA HEIGHT (m)	TABLE ANGLE (Degree)	RAW VALUE (dBuV)	CORRECTION FACTOR (dB/m)
1	#5640.35	60.8 PK	68.2	-7.4	1.07 H	180	56.9	3.9
2	*5785.00	121.2 PK			1.07 H	180	117.8	3.4
3	*5785.00	112.4 AV			1.07 H	180	109.0	3.4
4	#6003.72	53.7 PK	68.2	-14.5	1.07 H	180	48.9	4.8
5	11570.00	52.8 PK	74.0	-21.2	1.43 H	327	40.6	12.2
6	11570.00	40.6 AV	54.0	-13.4	1.43 H	327	28.4	12.2
7	#17355.00	48.6 PK	68.2	-19.6	1.52 H	152	32.0	16.6

**ANTENNA POLARITY & TEST DISTANCE: VERTICAL AT 3 M**

NO.	FREQ. (MHz)	EMISSION LEVEL (dBuV/m)	LIMIT (dBuV/m)	MARGIN (dB)	ANTENNA HEIGHT (m)	TABLE ANGLE (Degree)	RAW VALUE (dBuV)	CORRECTION FACTOR (dB/m)
1	#5627.26	63.3 PK	68.2	-4.9	2.53 V	114	59.5	3.8
2	*5785.00	126.4 PK			2.53 V	114	123.0	3.4
3	*5785.00	117.3 AV			2.53 V	114	113.9	3.4
4	#5943.63	56.3 PK	68.2	-11.9	2.53 V	114	51.7	4.6
5	11570.00	52.5 PK	74.0	-21.5	3.89 V	273	40.3	12.2
6	11570.00	40.2 AV	54.0	-13.8	3.89 V	273	28.0	12.2
7	#17355.00	45.4 PK	68.2	-22.8	1.49 V	46	28.8	16.6

**REMARKS:**

1. Emission Level(dBuV/m) = Raw Value(dBuV) + Correction Factor(dB/m)
2. Correction Factor(dB/m) = Antenna Factor(dB/m) + Cable Factor(dB) – Pre-Amplifier Factor(dB)
3. Margin value = Emission Level – Limit value
4. The other emission levels were very low against the limit.
5. " \* ": Fundamental frequency.
6. " # ": The radiated frequency is out of the restricted band.

<b>CHANNEL</b>	TX Channel 165	<b>DETECTOR FUNCTION</b>	Peak (PK)
<b>FREQUENCY RANGE</b>	1GHz ~ 40GHz		Average (AV)

**ANTENNA POLARITY & TEST DISTANCE: HORIZONTAL AT 3 M**

NO.	FREQ. (MHz)	EMISSION LEVEL (dBuV/m)	LIMIT (dBuV/m)	MARGIN (dB)	ANTENNA HEIGHT (m)	TABLE ANGLE (Degree)	RAW VALUE (dBuV)	CORRECTION FACTOR (dB/m)
1	#5636.07	59.6 PK	68.2	-8.6	1.50 H	175	55.8	3.8
2	*5825.00	122.6 PK			1.50 H	175	119.0	3.6
3	*5825.00	114.0 AV			1.50 H	175	110.4	3.6
4	#5930.89	54.6 PK	68.2	-13.6	1.50 H	175	50.1	4.5
5	11650.00	52.1 PK	74.0	-21.9	1.46 H	313	39.7	12.4
6	11650.00	40.0 AV	54.0	-14.0	1.46 H	313	27.6	12.4
7	#17475.00	48.6 PK	68.2	-19.6	1.49 H	162	31.6	17.0

**ANTENNA POLARITY & TEST DISTANCE: VERTICAL AT 3 M**

NO.	FREQ. (MHz)	EMISSION LEVEL (dBuV/m)	LIMIT (dBuV/m)	MARGIN (dB)	ANTENNA HEIGHT (m)	TABLE ANGLE (Degree)	RAW VALUE (dBuV)	CORRECTION FACTOR (dB/m)
1	#5631.25	60.6 PK	68.2	-7.6	2.51 V	112	56.8	3.8
2	*5825.00	126.3 PK			2.50 V	116	122.7	3.6
3	*5825.00	117.2 AV			2.50 V	116	113.6	3.6
4	#5937.58	56.7 PK	68.2	-11.5	2.51 V	112	52.0	4.7
5	11650.00	53.7 PK	74.0	-20.3	3.93 V	279	41.3	12.4
6	11650.00	41.2 AV	54.0	-12.8	3.93 V	279	28.8	12.4
7	#17475.00	45.1 PK	68.2	-23.1	1.51 V	42	28.1	17.0

**REMARKS:**

1. Emission Level(dBuV/m) = Raw Value(dBuV) + Correction Factor(dB/m)
2. Correction Factor(dB/m) = Antenna Factor(dB/m) + Cable Factor(dB) – Pre-Amplifier Factor(dB)
3. Margin value = Emission Level – Limit value
4. The other emission levels were very low against the limit.
5. " \* ": Fundamental frequency.
6. " # ": The radiated frequency is out of the restricted band.

**802.11ac (VHT20)**

<b>CHANNEL</b>	TX Channel 36	<b>DETECTOR FUNCTION</b>	Peak (PK)
<b>FREQUENCY RANGE</b>	1GHz ~ 40GHz		Average (AV)

**ANTENNA POLARITY & TEST DISTANCE: HORIZONTAL AT 3 M**

NO.	FREQ. (MHz)	EMISSION LEVEL (dBuV/m)	LIMIT (dBuV/m)	MARGIN (dB)	ANTENNA HEIGHT (m)	TABLE ANGLE (Degree)	RAW VALUE (dBuV)	CORRECTION FACTOR (dB/m)
1	5150.00	66.1 PK	74.0	-7.9	1.48 H	163	63.1	3.0
2	5150.00	52.6 AV	54.0	-1.4	1.48 H	163	49.6	3.0
3	*5180.00	117.0 PK			1.48 H	163	114.1	2.9
4	*5180.00	107.9 AV			1.48 H	163	105.0	2.9
5	#10360.00	51.6 PK	68.2	-16.6	1.43 H	305	39.6	12.0
6	15540.00	48.5 PK	74.0	-25.5	1.50 H	173	35.5	13.0
7	15540.00	35.7 AV	54.0	-18.3	1.50 H	173	22.7	13.0

**ANTENNA POLARITY & TEST DISTANCE: VERTICAL AT 3 M**

NO.	FREQ. (MHz)	EMISSION LEVEL (dBuV/m)	LIMIT (dBuV/m)	MARGIN (dB)	ANTENNA HEIGHT (m)	TABLE ANGLE (Degree)	RAW VALUE (dBuV)	CORRECTION FACTOR (dB/m)
1	5150.00	68.3 PK	74.0	-5.7	1.30 V	157	65.3	3.0
2	5150.00	53.6 AV	54.0	-0.4	1.30 V	157	50.6	3.0
3	*5180.00	120.1 PK			1.30 V	157	117.2	2.9
4	*5180.00	111.2 AV			1.30 V	157	108.3	2.9
5	#10360.00	53.5 PK	68.2	-14.7	3.87 V	265	41.5	12.0
6	15540.00	45.3 PK	74.0	-28.7	1.55 V	27	32.3	13.0
7	15540.00	34.8 AV	54.0	-19.2	1.55 V	27	21.8	13.0

**REMARKS:**

- Emission Level(dBuV/m) = Raw Value(dBuV) + Correction Factor(dB/m)
- Correction Factor(dB/m) = Antenna Factor(dB/m) + Cable Factor(dB) – Pre-Amplifier Factor(dB)
- Margin value = Emission Level – Limit value
- The other emission levels were very low against the limit.
- " \* ": Fundamental frequency.
- " # ": The radiated frequency is out of the restricted band.

<b>CHANNEL</b>	TX Channel 40	<b>DETECTOR FUNCTION</b>	Peak (PK)
<b>FREQUENCY RANGE</b>	1GHz ~ 40GHz		Average (AV)

**ANTENNA POLARITY & TEST DISTANCE: HORIZONTAL AT 3 M**

NO.	FREQ. (MHz)	EMISSION LEVEL (dBuV/m)	LIMIT (dBuV/m)	MARGIN (dB)	ANTENNA HEIGHT (m)	TABLE ANGLE (Degree)	RAW VALUE (dBuV)	CORRECTION FACTOR (dB/m)
1	5150.00	65.3 PK	74.0	-8.7	1.49 H	186	62.3	3.0
2	5150.00	50.8 AV	54.0	-3.2	1.49 H	186	47.8	3.0
3	*5200.00	112.9 PK			1.49 H	186	110.1	2.8
4	*5200.00	103.5 AV			1.49 H	186	100.7	2.8
5	#10400.00	51.8 PK	68.2	-16.4	1.42 H	315	39.7	12.1
6	15600.00	48.0 PK	74.0	-26.0	1.53 H	163	35.1	12.9
7	15600.00	35.4 AV	54.0	-18.6	1.53 H	163	22.5	12.9

**ANTENNA POLARITY & TEST DISTANCE: VERTICAL AT 3 M**

NO.	FREQ. (MHz)	EMISSION LEVEL (dBuV/m)	LIMIT (dBuV/m)	MARGIN (dB)	ANTENNA HEIGHT (m)	TABLE ANGLE (Degree)	RAW VALUE (dBuV)	CORRECTION FACTOR (dB/m)
1	5150.00	67.6 PK	74.0	-6.4	1.27 V	163	64.6	3.0
<b>2</b>	<b>5150.00</b>	<b>53.9 AV</b>	<b>54.0</b>	<b>-0.1</b>	<b>1.27 V</b>	<b>163</b>	<b>50.9</b>	<b>3.0</b>
3	*5200.00	124.1 PK			1.27 V	163	121.3	2.8
4	*5200.00	115.1 AV			1.27 V	163	112.3	2.8
5	#10400.00	53.5 PK	68.2	-14.7	3.88 V	283	41.4	12.1
6	15600.00	44.6 PK	74.0	-29.4	1.49 V	47	31.7	12.9
7	15600.00	34.2 AV	54.0	-19.8	1.49 V	47	21.3	12.9

**REMARKS:**

- Emission Level(dBuV/m) = Raw Value(dBuV) + Correction Factor(dB/m)
- Correction Factor(dB/m) = Antenna Factor(dB/m) + Cable Factor(dB) – Pre-Amplifier Factor(dB)
- Margin value = Emission Level – Limit value
- The other emission levels were very low against the limit.
- " \* ": Fundamental frequency.
- " # ": The radiated frequency is out of the restricted band.

<b>CHANNEL</b>	TX Channel 48	<b>DETECTOR FUNCTION</b>	Peak (PK)
<b>FREQUENCY RANGE</b>	1GHz ~ 40GHz		Average (AV)

**ANTENNA POLARITY & TEST DISTANCE: HORIZONTAL AT 3 M**

NO.	FREQ. (MHz)	EMISSION LEVEL (dBuV/m)	LIMIT (dBuV/m)	MARGIN (dB)	ANTENNA HEIGHT (m)	TABLE ANGLE (Degree)	RAW VALUE (dBuV)	CORRECTION FACTOR (dB/m)
1	5150.00	60.4 PK	74.0	-13.6	1.52 H	173	57.4	3.0
2	5150.00	52.6 AV	54.0	-1.4	1.52 H	173	49.6	3.0
3	*5240.00	113.5 PK			1.52 H	173	110.9	2.6
4	*5240.00	103.8 AV			1.52 H	173	101.2	2.6
5	5350.00	57.3 PK	74.0	-16.7	1.52 H	173	54.7	2.6
6	5350.00	47.5 AV	54.0	-6.5	1.52 H	173	44.9	2.6
7	#10480.00	52.6 PK	68.2	-15.6	1.46 H	315	40.1	12.5
8	15720.00	48.1 PK	74.0	-25.9	1.52 H	174	35.9	12.2
9	15720.00	35.6 AV	54.0	-18.4	1.52 H	174	23.4	12.2

**ANTENNA POLARITY & TEST DISTANCE: VERTICAL AT 3 M**

NO.	FREQ. (MHz)	EMISSION LEVEL (dBuV/m)	LIMIT (dBuV/m)	MARGIN (dB)	ANTENNA HEIGHT (m)	TABLE ANGLE (Degree)	RAW VALUE (dBuV)	CORRECTION FACTOR (dB/m)
1	5150.00	61.4 PK	74.0	-12.6	1.98 V	132	58.4	3.0
2	5150.00	49.2 AV	54.0	-4.8	1.98 V	132	46.2	3.0
3	*5240.00	124.2 PK			1.98 V	132	121.6	2.6
4	*5240.00	115.3 AV			1.98 V	132	112.7	2.6
5	5350.00	59.5 PK	74.0	-14.5	1.98 V	132	56.9	2.6
6	5350.00	48.3 AV	54.0	-5.7	1.98 V	132	45.7	2.6
7	#10480.00	53.6 PK	68.2	-14.6	3.96 V	269	41.1	12.5
8	15720.00	45.2 PK	74.0	-28.8	1.55 V	42	33.0	12.2
9	15720.00	35.0 AV	54.0	-19.0	1.55 V	42	22.8	12.2

**REMARKS:**

1. Emission Level(dBuV/m) = Raw Value(dBuV) + Correction Factor(dB/m)
2. Correction Factor(dB/m) = Antenna Factor(dB/m) + Cable Factor(dB) – Pre-Amplifier Factor(dB)
3. Margin value = Emission Level – Limit value
4. The other emission levels were very low against the limit.
5. " \* ": Fundamental frequency.
6. " # ": The radiated frequency is out of the restricted band.

<b>CHANNEL</b>	TX Channel 149	<b>DETECTOR FUNCTION</b>	Peak (PK)
<b>FREQUENCY RANGE</b>	1GHz ~ 40GHz		Average (AV)

**ANTENNA POLARITY & TEST DISTANCE: HORIZONTAL AT 3 M**

NO.	FREQ. (MHz)	EMISSION LEVEL (dBuV/m)	LIMIT (dBuV/m)	MARGIN (dB)	ANTENNA HEIGHT (m)	TABLE ANGLE (Degree)	RAW VALUE (dBuV)	CORRECTION FACTOR (dB/m)
1	#5574.50	61.7 PK	68.2	-6.5	1.49 H	172	57.9	3.8
2	*5745.00	121.4 PK			1.49 H	172	118.1	3.3
3	*5745.00	112.5 AV			1.49 H	172	109.2	3.3
4	#5934.92	52.5 PK	68.2	-15.7	1.49 H	172	48.0	4.5
5	11490.00	51.9 PK	74.0	-22.1	1.43 H	320	39.3	12.6
6	11490.00	39.8 AV	54.0	-14.2	1.43 H	320	27.2	12.6
7	#17235.00	48.6 PK	68.2	-19.6	1.51 H	153	31.8	16.8

**ANTENNA POLARITY & TEST DISTANCE: VERTICAL AT 3 M**

NO.	FREQ. (MHz)	EMISSION LEVEL (dBuV/m)	LIMIT (dBuV/m)	MARGIN (dB)	ANTENNA HEIGHT (m)	TABLE ANGLE (Degree)	RAW VALUE (dBuV)	CORRECTION FACTOR (dB/m)
1	#5639.81	64.1 PK	68.2	-4.1	2.56 V	112	60.3	3.8
2	*5745.00	126.6 PK			2.56 V	112	123.3	3.3
3	*5745.00	117.7 AV			2.56 V	112	114.4	3.3
4	#5932.22	55.7 PK	68.2	-12.5	2.56 V	112	51.2	4.5
5	11490.00	53.5 PK	74.0	-20.5	3.92 V	282	40.9	12.6
6	11490.00	41.2 AV	54.0	-12.8	3.92 V	282	28.6	12.6
7	#17235.00	44.9 PK	68.2	-23.3	1.45 V	47	28.1	16.8

**REMARKS:**

1. Emission Level(dBuV/m) = Raw Value(dBuV) + Correction Factor(dB/m)
2. Correction Factor(dB/m) = Antenna Factor(dB/m) + Cable Factor(dB) – Pre-Amplifier Factor(dB)
3. Margin value = Emission Level – Limit value
4. The other emission levels were very low against the limit.
5. " \* ": Fundamental frequency.
6. " # ": The radiated frequency is out of the restricted band.

<b>CHANNEL</b>	TX Channel 157	<b>DETECTOR FUNCTION</b>	Peak (PK)
<b>FREQUENCY RANGE</b>	1GHz ~ 40GHz		Average (AV)

**ANTENNA POLARITY & TEST DISTANCE: HORIZONTAL AT 3 M**

NO.	FREQ. (MHz)	EMISSION LEVEL (dBuV/m)	LIMIT (dBuV/m)	MARGIN (dB)	ANTENNA HEIGHT (m)	TABLE ANGLE (Degree)	RAW VALUE (dBuV)	CORRECTION FACTOR (dB/m)
1	#5627.06	59.3 PK	68.2	-8.9	1.52 H	175	55.5	3.8
2	*5785.00	121.4 PK			1.52 H	175	118.0	3.4
3	*5785.00	112.6 AV			1.52 H	175	109.2	3.4
4	#5931.47	53.3 PK	68.2	-14.9	1.52 H	175	48.8	4.5
5	11570.00	52.7 PK	74.0	-21.3	1.45 H	320	40.5	12.2
6	11570.00	40.4 AV	54.0	-13.6	1.45 H	320	28.2	12.2
7	#17355.00	48.4 PK	68.2	-19.8	1.44 H	169	31.8	16.6

**ANTENNA POLARITY & TEST DISTANCE: VERTICAL AT 3 M**

NO.	FREQ. (MHz)	EMISSION LEVEL (dBuV/m)	LIMIT (dBuV/m)	MARGIN (dB)	ANTENNA HEIGHT (m)	TABLE ANGLE (Degree)	RAW VALUE (dBuV)	CORRECTION FACTOR (dB/m)
1	#5624.49	63.6 PK	68.2	-4.6	2.58 V	112	59.8	3.8
2	*5785.00	126.1 PK			2.58 V	112	122.7	3.4
3	*5785.00	117.2 AV			2.58 V	112	113.8	3.4
4	#5959.73	55.4 PK	68.2	-12.8	2.58 V	112	50.8	4.6
5	11570.00	54.3 PK	74.0	-19.7	3.97 V	281	42.1	12.2
6	11570.00	41.7 AV	54.0	-12.3	3.97 V	281	29.5	12.2
7	#17355.00	45.0 PK	68.2	-23.2	1.56 V	49	28.4	16.6

**REMARKS:**

1. Emission Level(dBuV/m) = Raw Value(dBuV) + Correction Factor(dB/m)
2. Correction Factor(dB/m) = Antenna Factor(dB/m) + Cable Factor(dB) – Pre-Amplifier Factor(dB)
3. Margin value = Emission Level – Limit value
4. The other emission levels were very low against the limit.
5. " \* ": Fundamental frequency.
6. " # ": The radiated frequency is out of the restricted band.



<b>CHANNEL</b>	TX Channel 165	<b>DETECTOR FUNCTION</b>	Peak (PK)
<b>FREQUENCY RANGE</b>	1GHz ~ 40GHz		Average (AV)

**ANTENNA POLARITY & TEST DISTANCE: HORIZONTAL AT 3 M**

NO.	FREQ. (MHz)	EMISSION LEVEL (dBuV/m)	LIMIT (dBuV/m)	MARGIN (dB)	ANTENNA HEIGHT (m)	TABLE ANGLE (Degree)	RAW VALUE (dBuV)	CORRECTION FACTOR (dB/m)
1	#5628.08	59.6 PK	68.2	-8.6	1.51 H	171	55.8	3.8
2	*5825.00	122.1 PK			1.51 H	171	118.5	3.6
3	*5825.00	113.6 AV			1.51 H	171	110.0	3.6
4	#5936.40	53.8 PK	68.2	-14.4	1.51 H	171	49.1	4.7
5	11650.00	52.5 PK	74.0	-21.5	1.45 H	297	40.1	12.4
6	11650.00	40.4 AV	54.0	-13.6	1.45 H	297	28.0	12.4
7	#17475.00	48.6 PK	68.2	-19.6	1.44 H	160	31.6	17.0

**ANTENNA POLARITY & TEST DISTANCE: VERTICAL AT 3 M**

NO.	FREQ. (MHz)	EMISSION LEVEL (dBuV/m)	LIMIT (dBuV/m)	MARGIN (dB)	ANTENNA HEIGHT (m)	TABLE ANGLE (Degree)	RAW VALUE (dBuV)	CORRECTION FACTOR (dB/m)
1	#5625.99	60.8 PK	68.2	-7.4	2.71 V	115	57.0	3.8
2	*5825.00	126.8 PK			2.71 V	114	123.2	3.6
3	*5825.00	117.6 AV			2.71 V	114	114.0	3.6
4	#5932.94	57.6 PK	68.2	-10.6	2.71 V	115	53.1	4.5
5	11650.00	53.8 PK	74.0	-20.2	3.96 V	275	41.4	12.4
6	11650.00	41.6 AV	54.0	-12.4	3.96 V	275	29.2	12.4
7	#17475.00	45.3 PK	68.2	-22.9	1.49 V	45	28.3	17.0

**REMARKS:**

1. Emission Level(dBuV/m) = Raw Value(dBuV) + Correction Factor(dB/m)
2. Correction Factor(dB/m) = Antenna Factor(dB/m) + Cable Factor(dB) – Pre-Amplifier Factor(dB)
3. Margin value = Emission Level – Limit value
4. The other emission levels were very low against the limit.
5. " \* ": Fundamental frequency.
6. " # ": The radiated frequency is out of the restricted band.

**802.11ac (VHT40)**

<b>CHANNEL</b>	TX Channel 38	<b>DETECTOR FUNCTION</b>	Peak (PK)
<b>FREQUENCY RANGE</b>	1GHz ~ 40GHz		Average (AV)

**ANTENNA POLARITY & TEST DISTANCE: HORIZONTAL AT 3 M**

NO.	FREQ. (MHz)	EMISSION LEVEL (dBuV/m)	LIMIT (dBuV/m)	MARGIN (dB)	ANTENNA HEIGHT (m)	TABLE ANGLE (Degree)	RAW VALUE (dBuV)	CORRECTION FACTOR (dB/m)
1	5150.00	63.4 PK	74.0	-10.6	1.55 H	190	60.4	3.0
2	5150.00	51.1 AV	54.0	-2.9	1.55 H	190	48.1	3.0
3	*5190.00	111.6 PK			1.55 H	190	108.7	2.9
4	*5190.00	103.8 AV			1.55 H	190	100.9	2.9
5	#10380.00	52.3 PK	68.2	-15.9	1.42 H	314	40.1	12.2
6	15570.00	48.6 PK	74.0	-25.4	1.43 H	162	35.6	13.0
7	15570.00	35.8 AV	54.0	-18.2	1.43 H	162	22.8	13.0

**ANTENNA POLARITY & TEST DISTANCE: VERTICAL AT 3 M**

NO.	FREQ. (MHz)	EMISSION LEVEL (dBuV/m)	LIMIT (dBuV/m)	MARGIN (dB)	ANTENNA HEIGHT (m)	TABLE ANGLE (Degree)	RAW VALUE (dBuV)	CORRECTION FACTOR (dB/m)
1	5150.00	65.1 PK	74.0	-8.9	1.86 V	183	62.1	3.0
2	5150.00	53.6 AV	54.0	-0.4	1.86 V	183	50.6	3.0
3	*5190.00	113.7 PK			1.86 V	183	110.8	2.9
4	*5190.00	106.2 AV			1.86 V	183	103.3	2.9
5	#10380.00	53.9 PK	68.2	-14.3	3.90 V	278	41.7	12.2
6	15570.00	45.6 PK	74.0	-28.4	1.51 V	54	32.6	13.0
7	15570.00	35.2 AV	54.0	-18.8	1.51 V	54	22.2	13.0

**REMARKS:**

1. Emission Level(dBuV/m) = Raw Value(dBuV) + Correction Factor(dB/m)
2. Correction Factor(dB/m) = Antenna Factor(dB/m) + Cable Factor(dB) – Pre-Amplifier Factor(dB)
3. Margin value = Emission Level – Limit value
4. The other emission levels were very low against the limit.
5. " \* ": Fundamental frequency.
6. " # ": The radiated frequency is out of the restricted band.

<b>CHANNEL</b>	TX Channel 46	<b>DETECTOR FUNCTION</b>	Peak (PK)
<b>FREQUENCY RANGE</b>	1GHz ~ 40GHz		Average (AV)

**ANTENNA POLARITY & TEST DISTANCE: HORIZONTAL AT 3 M**

NO.	FREQ. (MHz)	EMISSION LEVEL (dBuV/m)	LIMIT (dBuV/m)	MARGIN (dB)	ANTENNA HEIGHT (m)	TABLE ANGLE (Degree)	RAW VALUE (dBuV)	CORRECTION FACTOR (dB/m)
1	5150.00	64.8 PK	74.0	-9.2	1.57 H	173	61.8	3.0
2	5150.00	53.0 AV	54.0	-1.0	1.57 H	173	50.0	3.0
3	*5230.00	117.2 PK			1.57 H	173	114.6	2.6
4	*5230.00	109.7 AV			1.57 H	173	107.1	2.6
5	5350.00	59.1 PK	74.0	-14.9	1.57 H	173	56.5	2.6
6	5350.00	49.1 AV	54.0	-4.9	1.57 H	173	46.5	2.6
7	#10460.00	52.2 PK	68.2	-16.0	1.51 H	305	39.8	12.4
8	15690.00	49.0 PK	74.0	-25.0	1.53 H	161	36.6	12.4
9	15690.00	36.2 AV	54.0	-17.8	1.53 H	161	23.8	12.4

**ANTENNA POLARITY & TEST DISTANCE: VERTICAL AT 3 M**

NO.	FREQ. (MHz)	EMISSION LEVEL (dBuV/m)	LIMIT (dBuV/m)	MARGIN (dB)	ANTENNA HEIGHT (m)	TABLE ANGLE (Degree)	RAW VALUE (dBuV)	CORRECTION FACTOR (dB/m)
1	5150.00	67.3 PK	74.0	-6.7	1.82 V	130	64.3	3.0
2	5150.00	53.8 AV	54.0	-0.2	1.82 V	130	50.8	3.0
3	*5230.00	119.4 PK			1.82 V	130	116.8	2.6
4	*5230.00	112.0 AV			1.82 V	130	109.4	2.6
5	5350.00	60.4 PK	74.0	-13.6	1.82 V	130	57.8	2.6
6	5350.00	48.8 AV	54.0	-5.2	1.82 V	130	46.2	2.6
7	#10460.00	53.7 PK	68.2	-14.5	3.88 V	284	41.3	12.4
8	15690.00	45.3 PK	74.0	-28.7	1.46 V	29	32.9	12.4
9	15690.00	34.8 AV	54.0	-19.2	1.46 V	29	22.4	12.4

**REMARKS:**

1. Emission Level(dBuV/m) = Raw Value(dBuV) + Correction Factor(dB/m)
2. Correction Factor(dB/m) = Antenna Factor(dB/m) + Cable Factor(dB) – Pre-Amplifier Factor(dB)
3. Margin value = Emission Level – Limit value
4. The other emission levels were very low against the limit.
5. " \* ": Fundamental frequency.
6. " # ": The radiated frequency is out of the restricted band.

<b>CHANNEL</b>	TX Channel 151	<b>DETECTOR FUNCTION</b>	Peak (PK)
<b>FREQUENCY RANGE</b>	1GHz ~ 40GHz		Average (AV)

**ANTENNA POLARITY & TEST DISTANCE: HORIZONTAL AT 3 M**

NO.	FREQ. (MHz)	EMISSION LEVEL (dBuV/m)	LIMIT (dBuV/m)	MARGIN (dB)	ANTENNA HEIGHT (m)	TABLE ANGLE (Degree)	RAW VALUE (dBuV)	CORRECTION FACTOR (dB/m)
1	#5640.56	62.5 PK	68.2	-5.7	1.54 H	179	58.6	3.9
2	*5755.00	119.4 PK			1.54 H	179	116.1	3.3
3	*5755.00	110.4 AV			1.54 H	179	107.1	3.3
4	#5948.32	53.0 PK	68.2	-15.2	1.54 H	179	48.4	4.6
5	11510.00	52.5 PK	74.0	-21.5	1.49 H	325	40.0	12.5
6	11510.00	40.2 AV	54.0	-13.8	1.49 H	325	27.7	12.5
7	#17265.00	48.7 PK	68.2	-19.5	1.46 H	146	32.1	16.6

**ANTENNA POLARITY & TEST DISTANCE: VERTICAL AT 3 M**

NO.	FREQ. (MHz)	EMISSION LEVEL (dBuV/m)	LIMIT (dBuV/m)	MARGIN (dB)	ANTENNA HEIGHT (m)	TABLE ANGLE (Degree)	RAW VALUE (dBuV)	CORRECTION FACTOR (dB/m)
1	#5641.13	65.2 PK	68.2	-3.0	1.70 V	110	61.3	3.9
2	*5755.00	119.9 PK			1.70 V	110	116.6	3.3
3	*5755.00	112.3 AV			1.70 V	110	109.0	3.3
4	#5931.78	55.4 PK	68.2	-12.8	1.70 V	110	50.9	4.5
5	11510.00	54.1 PK	74.0	-19.9	3.92 V	293	41.6	12.5
6	11510.00	41.5 AV	54.0	-12.5	3.92 V	293	29.0	12.5
7	#17265.00	44.8 PK	68.2	-23.4	1.53 V	50	28.2	16.6

**REMARKS:**

1. Emission Level(dBuV/m) = Raw Value(dBuV) + Correction Factor(dB/m)
2. Correction Factor(dB/m) = Antenna Factor(dB/m) + Cable Factor(dB) – Pre-Amplifier Factor(dB)
3. Margin value = Emission Level – Limit value
4. The other emission levels were very low against the limit.
5. " \* ": Fundamental frequency.
6. " # ": The radiated frequency is out of the restricted band.

<b>CHANNEL</b>	TX Channel 159	<b>DETECTOR FUNCTION</b>	Peak (PK)
<b>FREQUENCY RANGE</b>	1GHz ~ 40GHz		Average (AV)

**ANTENNA POLARITY & TEST DISTANCE: HORIZONTAL AT 3 M**

NO.	FREQ. (MHz)	EMISSION LEVEL (dBuV/m)	LIMIT (dBuV/m)	MARGIN (dB)	ANTENNA HEIGHT (m)	TABLE ANGLE (Degree)	RAW VALUE (dBuV)	CORRECTION FACTOR (dB/m)
1	#5625.19	60.5 PK	68.2	-7.7	1.49 H	180	56.7	3.8
2	*5795.00	119.0 PK			1.49 H	180	115.5	3.5
3	*5795.00	110.1 AV			1.49 H	180	106.6	3.5
4	#5929.22	55.9 PK	68.2	-12.3	1.49 H	180	51.4	4.5
5	11590.00	52.8 PK	74.0	-21.2	1.49 H	319	40.5	12.3
6	11590.00	40.4 AV	54.0	-13.6	1.49 H	319	28.1	12.3
7	#17385.00	48.2 PK	68.2	-20.0	1.46 H	164	31.7	16.5

**ANTENNA POLARITY & TEST DISTANCE: VERTICAL AT 3 M**

NO.	FREQ. (MHz)	EMISSION LEVEL (dBuV/m)	LIMIT (dBuV/m)	MARGIN (dB)	ANTENNA HEIGHT (m)	TABLE ANGLE (Degree)	RAW VALUE (dBuV)	CORRECTION FACTOR (dB/m)
1	#5645.38	62.2 PK	68.2	-6.0	1.88 V	123	58.3	3.9
2	*5795.00	121.7 PK			1.88 V	123	118.2	3.5
3	*5795.00	114.1 AV			1.88 V	123	110.6	3.5
4	#5928.11	61.9 PK	68.2	-6.3	1.88 V	123	57.4	4.5
5	11590.00	53.7 PK	74.0	-20.3	3.89 V	293	41.4	12.3
6	11590.00	41.4 AV	54.0	-12.6	3.89 V	293	29.1	12.3
7	#17385.00	45.1 PK	68.2	-23.1	1.50 V	52	28.6	16.5

**REMARKS:**

1. Emission Level(dBuV/m) = Raw Value(dBuV) + Correction Factor(dB/m)
2. Correction Factor(dB/m) = Antenna Factor(dB/m) + Cable Factor(dB) – Pre-Amplifier Factor(dB)
3. Margin value = Emission Level – Limit value
4. The other emission levels were very low against the limit.
5. " \* ": Fundamental frequency.
6. " # ": The radiated frequency is out of the restricted band.

**802.11ac (VHT80)**

<b>CHANNEL</b>	TX Channel 42	<b>DETECTOR FUNCTION</b>	Peak (PK)
<b>FREQUENCY RANGE</b>	1GHz ~ 40GHz		Average (AV)

**ANTENNA POLARITY & TEST DISTANCE: HORIZONTAL AT 3 M**

NO.	FREQ. (MHz)	EMISSION LEVEL (dBuV/m)	LIMIT (dBuV/m)	MARGIN (dB)	ANTENNA HEIGHT (m)	TABLE ANGLE (Degree)	RAW VALUE (dBuV)	CORRECTION FACTOR (dB/m)
1	5150.00	61.0 PK	74.0	-13.0	1.49 H	163	58.0	3.0
2	5150.00	50.3 AV	54.0	-3.7	1.49 H	163	47.3	3.0
3	*5210.00	105.9 PK			1.49 H	163	103.2	2.7
4	*5210.00	97.8 AV			1.49 H	163	95.1	2.7
5	5350.00	55.7 PK	74.0	-18.3	1.49 H	163	53.1	2.6
6	5350.00	46.1 AV	54.0	-7.9	1.49 H	163	43.5	2.6
7	#10420.00	51.9 PK	68.2	-16.3	1.48 H	305	39.6	12.3
8	15630.00	48.1 PK	74.0	-25.9	1.51 H	162	35.4	12.7
9	15630.00	35.5 AV	54.0	-18.5	1.51 H	162	22.8	12.7

**ANTENNA POLARITY & TEST DISTANCE: VERTICAL AT 3 M**

NO.	FREQ. (MHz)	EMISSION LEVEL (dBuV/m)	LIMIT (dBuV/m)	MARGIN (dB)	ANTENNA HEIGHT (m)	TABLE ANGLE (Degree)	RAW VALUE (dBuV)	CORRECTION FACTOR (dB/m)
1	5150.00	63.6 PK	74.0	-10.4	2.15 V	183	59.9	3.7
2	5150.00	53.7 AV	54.0	-0.3	2.15 V	183	50.0	3.7
3	*5210.00	110.0 PK			2.15 V	183	106.4	3.6
4	*5210.00	102.1 AV			2.15 V	183	98.5	3.6
5	5350.00	57.7 PK	74.0	-16.3	2.15 V	183	54.3	3.4
6	5350.00	47.2 AV	54.0	-6.8	2.15 V	183	43.8	3.4
7	#10420.00	54.0 PK	68.2	-14.2	3.94 V	282	41.2	12.8
8	15630.00	45.0 PK	74.0	-29.0	1.56 V	32	31.3	13.7
9	15630.00	34.5 AV	54.0	-19.5	1.56 V	32	20.8	13.7

**REMARKS:**

- Emission Level(dBuV/m) = Raw Value(dBuV) + Correction Factor(dB/m)
- Correction Factor(dB/m) = Antenna Factor(dB/m) + Cable Factor(dB) – Pre-Amplifier Factor(dB)
- Margin value = Emission Level – Limit value
- The other emission levels were very low against the limit.
- " \* ": Fundamental frequency.
- " # ": The radiated frequency is out of the restricted band.

<b>CHANNEL</b>	TX Channel 155	<b>DETECTOR FUNCTION</b>	Peak (PK)
<b>FREQUENCY RANGE</b>	1GHz ~ 40GHz		Average (AV)

**ANTENNA POLARITY & TEST DISTANCE: HORIZONTAL AT 3 M**

NO.	FREQ. (MHz)	EMISSION LEVEL (dBuV/m)	LIMIT (dBuV/m)	MARGIN (dB)	ANTENNA HEIGHT (m)	TABLE ANGLE (Degree)	RAW VALUE (dBuV)	CORRECTION FACTOR (dB/m)
1	#5624.04	61.6 PK	68.2	-6.6	1.50 H	170	57.8	3.8
2	*5775.00	112.6 PK			1.50 H	170	109.2	3.4
3	*5775.00	103.4 AV			1.50 H	170	100.0	3.4
4	#5927.26	58.3 PK	68.2	-9.9	1.50 H	170	53.8	4.5
5	11550.00	52.4 PK	74.0	-21.6	1.40 H	304	40.0	12.4
6	11550.00	40.3 AV	54.0	-13.7	1.40 H	304	27.9	12.4
7	#17325.00	48.5 PK	68.2	-19.7	1.54 H	178	31.8	16.7

**ANTENNA POLARITY & TEST DISTANCE: VERTICAL AT 3 M**

NO.	FREQ. (MHz)	EMISSION LEVEL (dBuV/m)	LIMIT (dBuV/m)	MARGIN (dB)	ANTENNA HEIGHT (m)	TABLE ANGLE (Degree)	RAW VALUE (dBuV)	CORRECTION FACTOR (dB/m)
1	#5639.51	67.2 PK	68.2	-1.0	2.34 V	127	63.4	3.8
2	*5775.00	116.0 PK			2.34 V	127	112.6	3.4
3	*5775.00	108.2 AV			2.34 V	127	104.8	3.4
4	#5933.91	63.6 PK	68.2	-4.6	2.34 V	127	59.1	4.5
5	11550.00	53.8 PK	74.0	-20.2	3.95 V	279	41.4	12.4
6	11550.00	41.4 AV	54.0	-12.6	3.95 V	279	29.0	12.4
7	#17325.00	45.1 PK	68.2	-23.1	1.52 V	45	28.4	16.7

**REMARKS:**

- Emission Level(dBuV/m) = Raw Value(dBuV) + Correction Factor(dB/m)
- Correction Factor(dB/m) = Antenna Factor(dB/m) + Cable Factor(dB) – Pre-Amplifier Factor(dB)
- Margin value = Emission Level – Limit value
- The other emission levels were very low against the limit.
- " \* ": Fundamental frequency.
- " # ": The radiated frequency is out of the restricted band.

Below 1GHz Data:

802.11a

<b>CHANNEL</b>	TX Channel 165	<b>DETECTOR FUNCTION</b>	Quasi-Peak (QP)
<b>FREQUENCY RANGE</b>	9kHz ~ 1GHz		

**ANTENNA POLARITY & TEST DISTANCE: HORIZONTAL AT 3 M**

NO.	FREQ. (MHz)	EMISSION LEVEL (dBuV/m)	LIMIT (dBuV/m)	MARGIN (dB)	ANTENNA HEIGHT (m)	TABLE ANGLE (Degree)	RAW VALUE (dBuV)	CORRECTION FACTOR (dB/m)
1	30.00	31.8 QP	40.0	-8.2	1.00 H	170	40.4	-8.6
2	92.44	31.6 QP	43.5	-11.9	2.00 H	112	44.7	-13.1
3	166.70	36.6 QP	43.5	-6.9	1.50 H	99	44.1	-7.5
4	218.16	34.8 QP	46.0	-11.2	1.50 H	285	44.8	-10.0
5	306.86	30.7 QP	46.0	-15.3	1.00 H	229	36.8	-6.1
6	542.50	36.8 QP	46.0	-9.2	1.50 H	48	37.6	-0.8

**REMARKS:**

1. Emission Level(dBuV/m) = Raw Value(dBuV) + Correction Factor(dB/m)
2. Correction Factor(dB/m) = Antenna Factor(dB/m) + Cable Factor(dB) – Pre-Amplifier Factor(dB)
3. Margin value = Emission Level – Limit value
4. The other emission levels were very low against the limit of frequency range 30MHz~1000MHz.
5. The emission levels were very low against the limit of frequency range 9kHz~30MHz: the amplitude of spurious emissions attenuated more than 20 dB below the permissible value to be report.

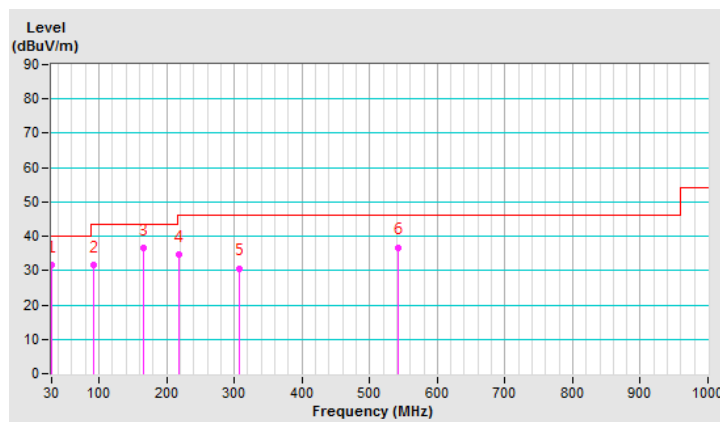



<b>CHANNEL</b>	TX Channel 165	<b>DETECTOR FUNCTION</b>	Quasi-Peak (QP)
<b>FREQUENCY RANGE</b>	9kHz ~ 1GHz		

ANTENNA POLARITY & TEST DISTANCE: VERTICAL AT 3 M								
NO.	FREQ. (MHz)	EMISSION LEVEL (dBuV/m)	LIMIT (dBuV/m)	MARGIN (dB)	ANTENNA HEIGHT (m)	TABLE ANGLE (Degree)	RAW VALUE (dBuV)	CORRECTION FACTOR (dB/m)
1	44.89	36.4 QP	40.0	-3.6	1.00 V	2	44.2	-7.8
2	89.24	33.0 QP	43.5	-10.5	1.50 V	312	46.4	-13.4
3	197.11	32.0 QP	43.5	-11.5	1.00 V	25	42.3	-10.3
4	351.75	31.9 QP	46.0	-14.1	1.50 V	360	36.9	-5.0
5	399.42	30.8 QP	46.0	-15.2	1.50 V	230	34.9	-4.1
6	560.01	36.7 QP	46.0	-9.3	1.00 V	225	36.9	-0.2

**REMARKS:**

1. Emission Level(dBuV/m) = Raw Value(dBuV) + Correction Factor(dB/m)
2. Correction Factor(dB/m) = Antenna Factor(dB/m) + Cable Factor(dB) – Pre-Amplifier Factor(dB)
3. Margin value = Emission Level – Limit value
4. The other emission levels were very low against the limit of frequency range 30MHz~1000MHz.
5. The emission levels were very low against the limit of frequency range 9kHz~30MHz: the amplitude of spurious emissions attenuated more than 20 dB below the permissible value to be report.

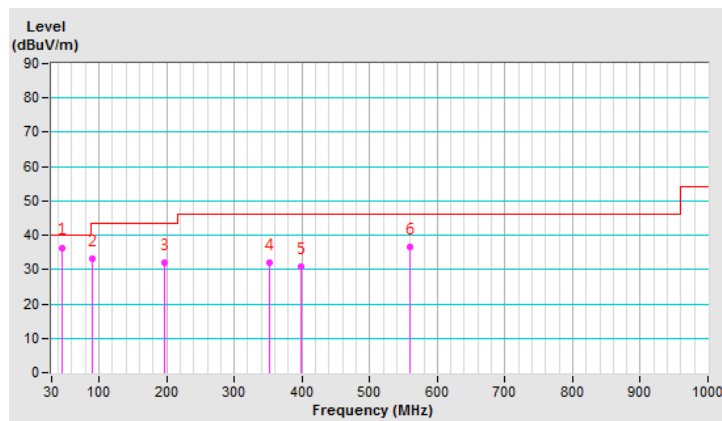

## 4.2 Conducted Emission Measurement

### 4.2.1 Limits of Conducted Emission Measurement

Frequency (MHz)	Conducted Limit (dBuV)	
	Quasi-peak	Average
0.15 - 0.5	66 - 56	56 - 46
0.50 - 5.0	56	46
5.0 - 30.0	60	50

Note: 1. The lower limit shall apply at the transition frequencies.

2. The limit decreases in line with the logarithm of the frequency in the range of 0.15 to 0.50MHz.

### 4.2.2 Test Instruments

DESCRIPTION & MANUFACTURER	MODEL NO.	SERIAL NO.	CALIBRATED DATE	CALIBRATED UNTIL
Test Receiver R&S	ESCS 30	847124/029	Oct. 23, 2019	Oct. 22, 2020
Line-Impedance Stabilization Network (for EUT) R&S	ESH3-Z5	848773/004	Oct. 23, 2019	Oct. 22, 2020
Line-Impedance Stabilization Network (for Peripheral) R&S	ESH3-Z5	835239/001	Mar. 17, 2019	Mar. 16, 2020
50 ohms Terminator	50	3	Oct. 23, 2019	Oct. 22, 2020
RF Cable	5D-FB	COCCAB-001	Sep. 27, 2019	Sep. 26, 2020
Fixed attenuator EMCI	STI02-2200-10	003	Mar. 14, 2019	Mar. 13, 2020
Software BVADT	BVADT_Cond_ V7.3.7.4	NA	NA	NA

**Note:**

1. The calibration interval of the above test instruments are 12 months and the calibrations are traceable to NML/ROC and NIST/USA.
2. The test was performed in Conduction 1.
- 3 Tested Date: Mar. 03, 2020

#### 4.2.3 Test Procedure

- The EUT was placed 0.4 meters from the conducting wall of the shielded room with EUT being connected to the power mains through a line impedance stabilization network (LISN). Other support units were connected to the power mains through another LISN. The two LISNs provide 50 ohm/ 50uH of coupling impedance for the measuring instrument.
- Both lines of the power mains connected to the EUT were checked for maximum conducted interference.
- The frequency range from 150kHz to 30MHz was searched. Emission levels under (Limit - 20dB) was not recorded.

**NOTE:** All modes of operation were investigated and the worst-case emissions are reported.

#### 4.2.4 Deviation from Test Standard

No deviation.

#### 4.2.5 Test Setup

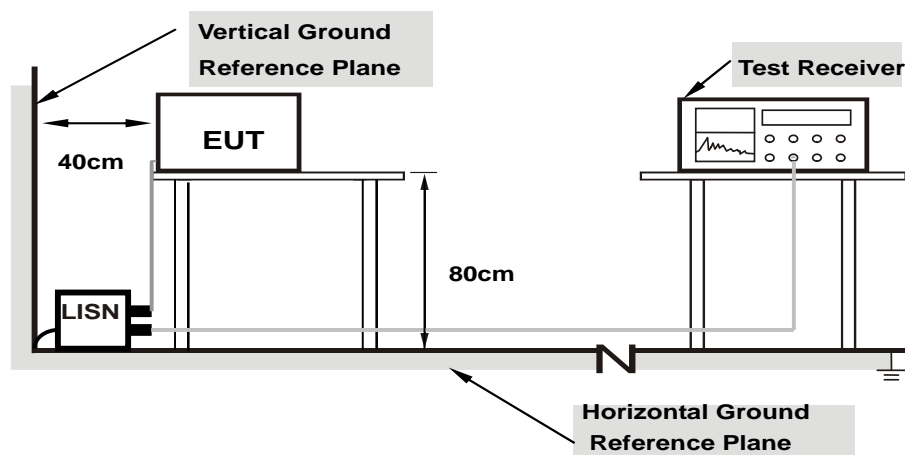

**Note: 1.Support units were connected to second LISN.**

For the actual test configuration, please refer to the attached file (Test Setup Photo).

#### 4.2.6 EUT Operating Condition

Same as 4.1.6.

#### 4.2.7 Test Results

Phase	Line (L)	Detector Function	Quasi-Peak (QP) / Average (AV)
-------	----------	-------------------	--------------------------------

No	Freq. [MHz]	Corr.	Reading Value		Emission Level		Limit		Margin	
		Factor (dB)	[dB (uV)]		[dB (uV)]		[dB (uV)]		(dB)	
			Q.P.	AV.	Q.P.	AV.	Q.P.	AV.	Q.P.	AV.
1	13.92578	10.94	28.83	22.81	39.77	33.75	60.00	50.00	-20.23	-16.25
2	15.49219	11.05	31.41	25.48	42.46	36.53	60.00	50.00	-17.54	-13.47
3	16.98047	11.16	33.85	28.08	45.01	39.24	60.00	50.00	-14.99	-10.76
4	19.08594	11.31	36.96	31.54	48.27	42.85	60.00	50.00	-11.73	-7.15
5	21.13672	11.41	35.71	30.43	47.12	41.84	60.00	50.00	-12.88	-8.16
6	23.50781	11.50	32.01	25.84	43.51	37.34	60.00	50.00	-16.49	-12.66

#### Remarks:

1. Q.P. and AV. are abbreviations of quasi-peak and average individually.
2. The emission levels of other frequencies were very low against the limit.
3. Margin value = Emission level – Limit value
4. Correction factor = Insertion loss + Cable loss
5. Emission Level = Correction Factor + Reading Value

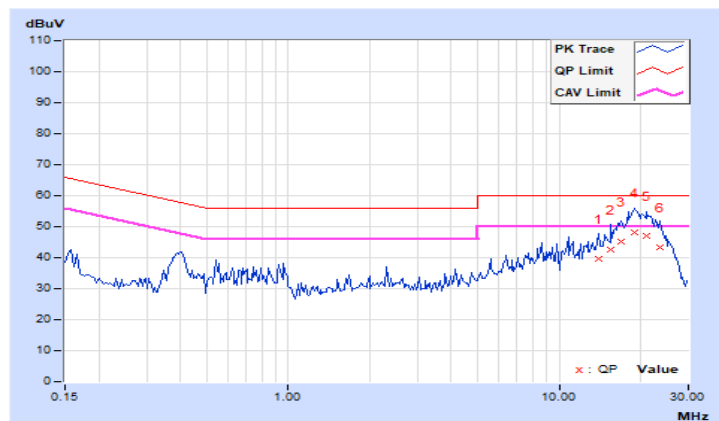

Phase	Neutral (N)	Detector Function	Quasi-Peak (QP) / Average (AV)
-------	-------------	-------------------	--------------------------------

No	Freq. [MHz]	Corr. Factor	Reading Value [dB (uV)]		Emission Level [dB (uV)]		Limit [dB (uV)]		Margin (dB)	
		(dB)	Q.P.	AV.	Q.P.	AV.	Q.P.	AV.	Q.P.	AV.
	1	14.75000	10.84	31.32	25.25	42.16	36.09	60.00	50.00	-17.84
2	16.96484	10.95	35.87	30.38	46.82	41.33	60.00	50.00	-13.18	-8.67
3	19.12500	11.06	39.00	33.61	50.06	44.67	60.00	50.00	-9.94	-5.33
<b>4</b>	<b>20.26172</b>	<b>11.12</b>	<b>39.02</b>	<b>33.84</b>	<b>50.14</b>	<b>44.96</b>	<b>60.00</b>	<b>50.00</b>	<b>-9.86</b>	<b>-5.04</b>
5	21.84375	11.15	36.78	31.16	47.93	42.31	60.00	50.00	-12.07	-7.69
6	24.10547	11.21	33.21	27.17	44.42	38.38	60.00	50.00	-15.58	-11.62

#### Remarks:

1. Q.P. and AV. are abbreviations of quasi-peak and average individually.
2. The emission levels of other frequencies were very low against the limit.
3. Margin value = Emission level – Limit value
4. Correction factor = Insertion loss + Cable loss
5. Emission Level = Correction Factor + Reading Value

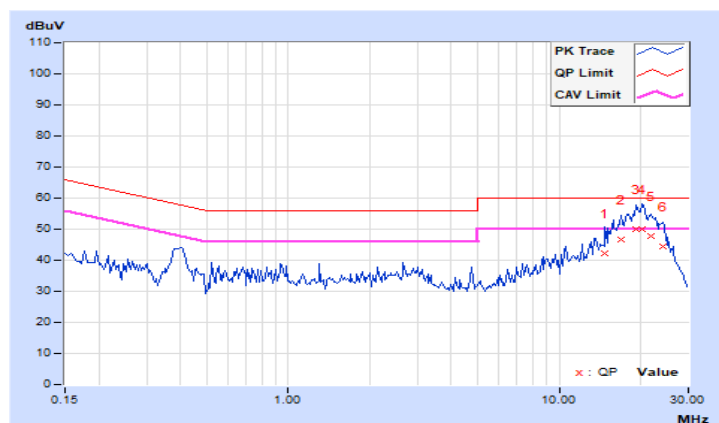

### 4.3 Transmit Power Measurement

#### 4.3.1 Limits of Transmit Power Measurement

Operation Band	EUT Category		Limit
U-NII-1		Outdoor Access Point	1 Watt (30 dBm) (Max. e.i.r.p $\leq$ 125mW(21 dBm) at any elevation angle above 30 degrees as measured from the horizon)
		Fixed point-to-point Access Point	1 Watt (30 dBm)
	√	Indoor Access Point	1 Watt (30 dBm)
		Client device	250mW (24 dBm)
U-NII-2A			250mW (24 dBm) or 11 dBm+10 log B*
U-NII-2C			250mW (24 dBm) or 11 dBm+10 log B*
U-NII-3	√		1 Watt (30 dBm)

\*B is the 26 dB emission bandwidth in megahertz

Per KDB 662911 Method of conducted output power measurement on IEEE 802.11 devices,

Array Gain = 0 dB (i.e., no array gain) for  $N_{ANT} \leq 4$ ;

Array Gain = 0 dB (i.e., no array gain) for channel widths  $\geq 40$  MHz for any  $N_{ANT}$ ;

Array Gain =  $5 \log(N_{ANT}/N_{SS})$  dB or 3 dB, whichever is less for 20-MHz channel widths with  $N_{ANT} \geq 5$ .

For power measurements on all other devices: Array Gain =  $10 \log(N_{ANT}/N_{SS})$  dB.

#### 4.3.2 Test Setup

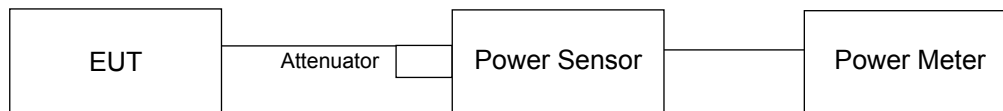

#### 4.3.3 Test Instruments

Refer to section 4.1.2 to get information of above instrument.

#### 4.3.4 Test Procedure

Method PM is used to perform output power measurement, trigger and gating function of wide band power meter is enabled to measure max output power of TX on burst. Duty factor is not added to measured value.

#### 4.3.5 Deviation from Test Standard

No deviation.

#### 4.3.6 EUT Operating Condition

The software provided by client to enable the EUT under transmission condition continuously at lowest, middle and highest channel frequencies individually.

#### 4.3.7 Test Results

##### CDD Mode

##### 802.11a

Chan.	Chan. Freq. (MHz)	Maximum Conducted Power (dBm)			Total Power (mW)	Total Power (dBm)	Limit (dBm)	Pass / Fail
		Chain 0	Chain 1	Chain 2				
36	5180	21.97	21.12	22.09	448.626	26.52	30.00	Pass
40	5200	22.05	21.24	22.19	458.947	26.62	30.00	Pass
48	5240	21.19	21.65	22.53	456.801	26.60	30.00	Pass
149	5745	25.13	24.13	25.71	957.05	29.81	30.00	Pass
157	5785	25.04	24.03	25.82	954.028	29.80	30.00	Pass
165	5825	25.58	24.51	25.13	969.735	29.87	30.00	Pass

##### 802.11ac (VHT20)

Chan.	Chan. Freq. (MHz)	Maximum Conducted Power (dBm)			Total Power (mW)	Total Power (dBm)	Limit (dBm)	Pass / Fail
		Chain 0	Chain 1	Chain 2				
36	5180	21.77	21.16	22.19	446.508	26.50	30.00	Pass
40	5200	21.87	21.23	22.29	455.989	26.59	30.00	Pass
48	5240	21.23	21.76	22.61	465.097	26.68	30.00	Pass
149	5745	25.19	24.05	25.77	962.039	29.83	30.00	Pass
157	5785	25.16	23.94	25.86	961.316	29.83	30.00	Pass
165	5825	25.46	24.63	24.98	956.738	29.81	30.00	Pass

##### 802.11ac (VHT40)

Chan.	Chan. Freq. (MHz)	Maximum Conducted Power (dBm)			Total Power (mW)	Total Power (dBm)	Limit (dBm)	Pass / Fail
		Chain 0	Chain 1	Chain 2				
38	5190	17.65	17.22	18.13	175.946	22.45	30.00	Pass
46	5230	23.76	23.88	25.12	807.114	29.07	30.00	Pass
151	5755	25.32	24.04	25.56	953.67	29.79	30.00	Pass
159	5795	25.17	24.19	25.63	956.868	29.81	30.00	Pass

##### 802.11ac (VHT80)

Chan.	Chan. Freq. (MHz)	Maximum Conducted Power (dBm)			Total Power (mW)	Total Power (dBm)	Limit (dBm)	Pass / Fail
		Chain 0	Chain 1	Chain 2				
42	5210	16.23	16.03	16.49	126.628	21.03	30.00	Pass
155	5775	22.63	22.63	23.01	566.449	27.53	30.00	Pass

## Beamforming Mode

### 802.11ac (VHT20)

Chan.	Chan. Freq. (MHz)	Maximum Conducted Power (dBm)			Total Power (mW)	Total Power (dBm)	Limit (dBm)	Pass / Fail
		Chain 0	Chain 1	Chain 2				
36	5180	21.77	21.16	22.19	446.508	26.50	26.69	Pass
40	5200	21.87	21.23	22.29	455.989	26.59	26.69	Pass
48	5240	21.23	21.76	22.61	465.097	26.68	26.69	Pass
149	5745	21.46	20.11	22.27	411.179	26.14	26.21	Pass
157	5785	21.53	20.03	22.18	408.122	26.11	26.21	Pass
165	5825	21.79	20.87	21.33	409.019	26.12	26.21	Pass

- Note: 1. For U-NII-1: The directional gain =  $10 \log[(10^{G0/20} + 10^{G1/20} + 10^{G2/20})^2 / 3] = 9.31\text{dBi} > 6\text{dBi}$ , so the power limit shall be reduced to  $30-(9.31-6) = 26.69\text{dBm}$ .
2. For U-NII-3: The directional gain =  $10 \log[(10^{G0/20} + 10^{G1/20} + 10^{G2/20})^2 / 3] = 9.79\text{dBi} > 6\text{dBi}$ , so the power limit shall be reduced to  $30-(9.79-6) = 26.21\text{dBm}$ .

### 802.11ac (VHT40)

Chan.	Chan. Freq. (MHz)	Maximum Conducted Power (dBm)			Total Power (mW)	Total Power (dBm)	Limit (dBm)	Pass / Fail
		Chain 0	Chain 1	Chain 2				
38	5190	17.65	17.22	18.13	175.946	22.45	26.69	Pass
46	5230	21.03	21.54	22.71	455.964	26.59	26.69	Pass
151	5755	21.38	20.19	22.08	403.312	26.06	26.21	Pass
159	5795	21.27	20.33	21.89	396.388	25.98	26.21	Pass

- Note: 1. For U-NII-1: The directional gain =  $10 \log[(10^{G0/20} + 10^{G1/20} + 10^{G2/20})^2 / 3] = 9.31\text{dBi} > 6\text{dBi}$ , so the power limit shall be reduced to  $30-(9.31-6) = 26.69\text{dBm}$ .
2. For U-NII-3: The directional gain =  $10 \log[(10^{G0/20} + 10^{G1/20} + 10^{G2/20})^2 / 3] = 9.79\text{dBi} > 6\text{dBi}$ , so the power limit shall be reduced to  $30-(9.79-6) = 26.21\text{dBm}$ .

### 802.11ac (VHT80)

Chan.	Chan. Freq. (MHz)	Maximum Conducted Power (dBm)			Total Power (mW)	Total Power (dBm)	Limit (dBm)	Pass / Fail
		Chain 0	Chain 1	Chain 2				
42	5210	16.23	16.03	16.49	126.628	21.03	26.69	Pass
155	5775	21.18	21.06	21.64	404.745	26.07	26.21	Pass

- Note: 1. For U-NII-1: The directional gain =  $10 \log[(10^{G0/20} + 10^{G1/20} + 10^{G2/20})^2 / 3] = 9.31\text{dBi} > 6\text{dBi}$ , so the power limit shall be reduced to  $30-(9.31-6) = 26.69\text{dBm}$ .
2. For U-NII-3: The directional gain =  $10 \log[(10^{G0/20} + 10^{G1/20} + 10^{G2/20})^2 / 3] = 9.79\text{dBi} > 6\text{dBi}$ , so the power limit shall be reduced to  $30-(9.79-6) = 26.21\text{dBm}$ .



## 4.4 Occupied Bandwidth Measurement

### 4.4.1 Test Setup

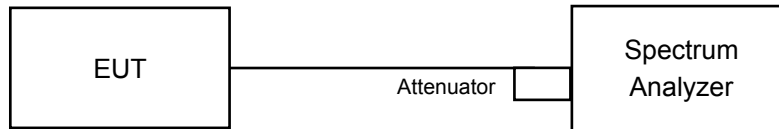

### 4.4.2 Test Instruments

Refer to section 4.1.2 to get information of above instrument.

### 4.4.3 Test Procedure

The transmitter output was connected to the spectrum analyzer through an attenuator. The bandwidth of the fundamental frequency was measured by spectrum analyzer with resolution bandwidth in the range of 1% to 5% of the anticipated emission bandwidth, and a video bandwidth at least 3x the resolution bandwidth and set the detector to SAMPLE. The width of a frequency band such that, below the lower and above the upper frequency limits, the mean powers emitted are each equal to a specified percentage 0.5% of the total mean power of a given emission.

#### 4.4.4 Test Results

##### 802.11a

Channel	Channel Frequency (MHz)	Occupied Bandwidth (MHz)		
		Chain 0	Chain 1	Chain 2
36	5180	16.56	16.56	16.44
40	5200	16.56	16.56	16.56
48	5240	16.56	16.44	16.56
149	5745	16.8	16.68	16.8
157	5785	16.8	16.44	16.8
165	5825	17.04	16.68	16.68

##### 802.11ac (VHT20)

Channel	Channel Frequency (MHz)	Occupied Bandwidth (MHz)		
		Chain 0	Chain 1	Chain 2
36	5180	17.64	17.64	17.52
40	5200	17.76	17.4	17.52
48	5240	17.64	17.64	17.52
149	5745	17.76	17.64	17.76
157	5785	17.88	17.64	17.76
165	5825	18.12	17.64	17.88

##### 802.11ac (VHT40)

Channel	Channel Frequency (MHz)	Occupied Bandwidth (MHz)		
		Chain 0	Chain 1	Chain 2
38	5190	36.24	36.24	36.48
46	5230	36.24	36.72	36.72
151	5755	36.48	36.72	36.24
159	5795	36.72	36	36.48

##### 802.11ac (VHT80)

Channel	Channel Frequency (MHz)	Occupied Bandwidth (MHz)		
		Chain 0	Chain 1	Chain 2
42	5210	75.36	75.36	75.36
155	5775	75.84	75.36	75.84

Spectrum Plot of Max. Value

802.11a\_Chain 0 / CH165

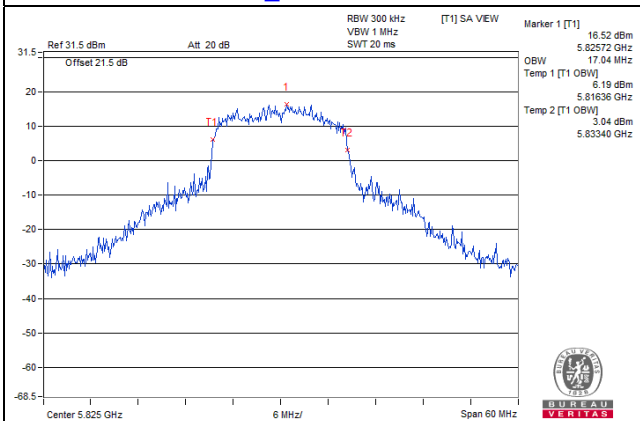

802.11ac (VHT20)\_Chain 0 / CH165

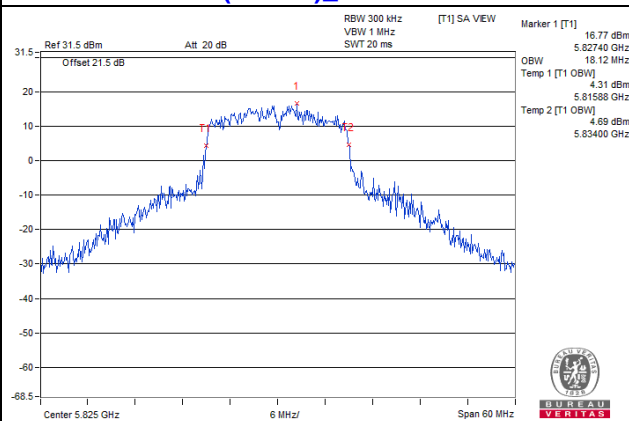

802.11ac (VHT40)\_Chain 0 / CH159

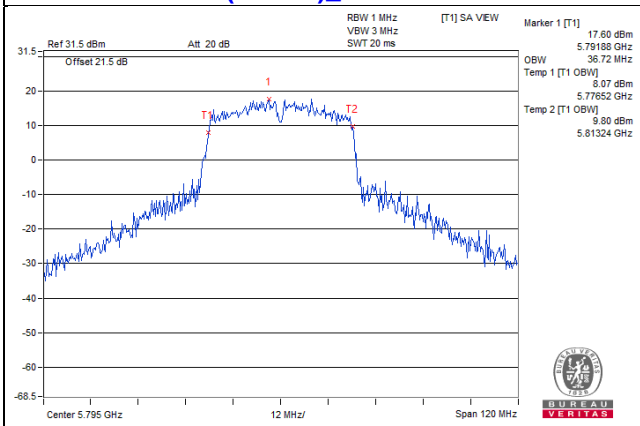

802.11ac (VHT80)\_Chain 0 / CH155

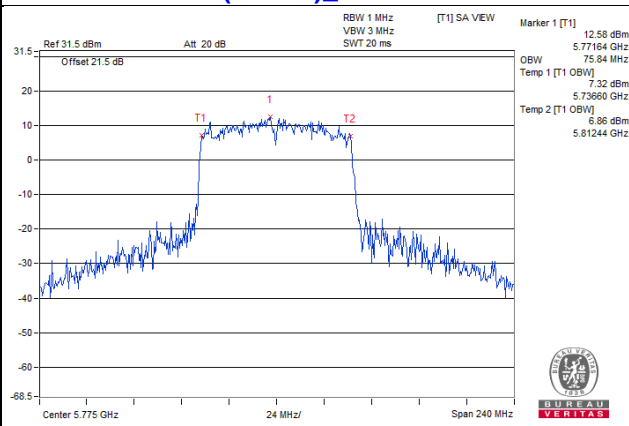

**Spectrum Plot for near by DFS band  
(DFS is required, if 99% OCP straddle into U-NII-2A band)**

**802.11a\_Chain 0 / CH48**

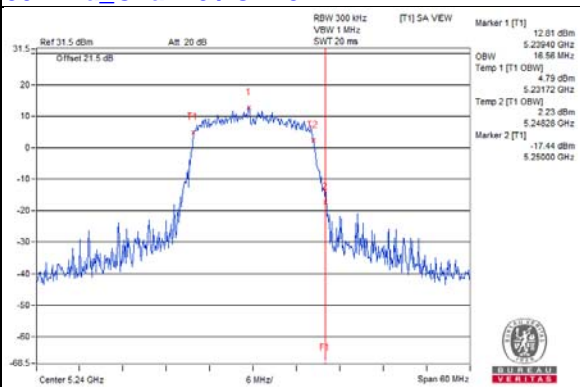

**802.11a\_Chain 1 / CH48**

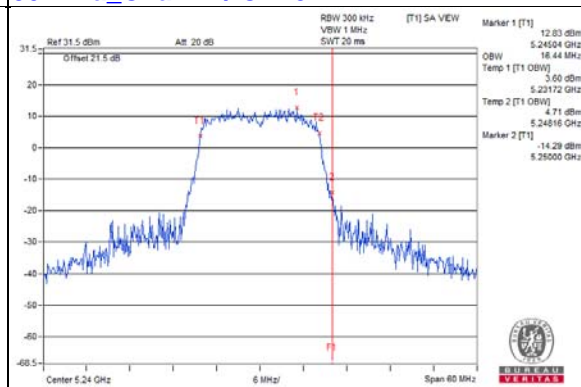

**802.11a\_Chain 2 / CH48**

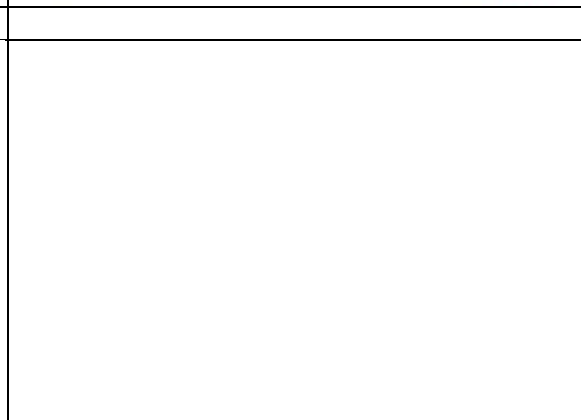
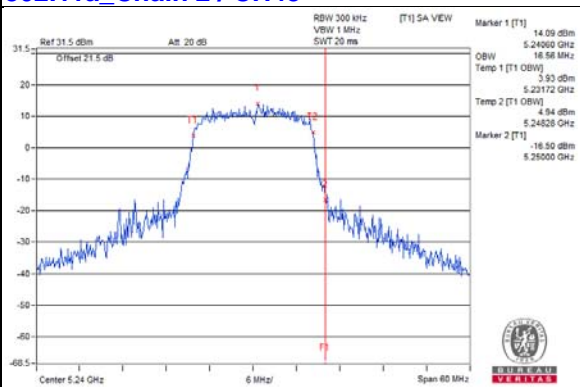

**802.11ac (VHT20)\_Chain 0 / CH48**

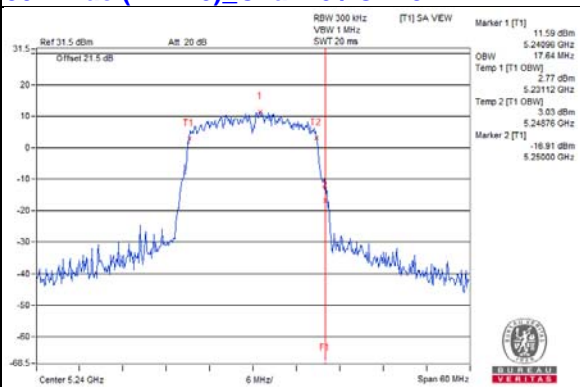

**802.11ac (VHT20)\_Chain 1 / CH48**

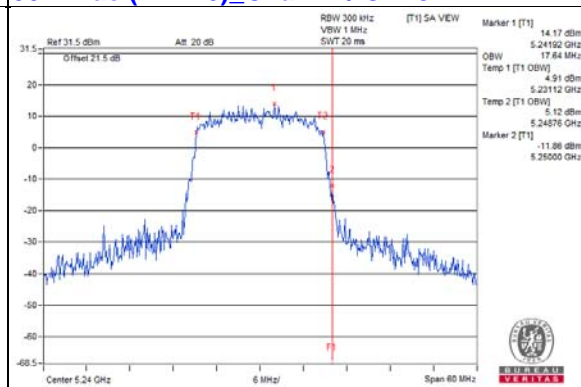

**802.11ac (VHT20)\_Chain 2 / CH48**

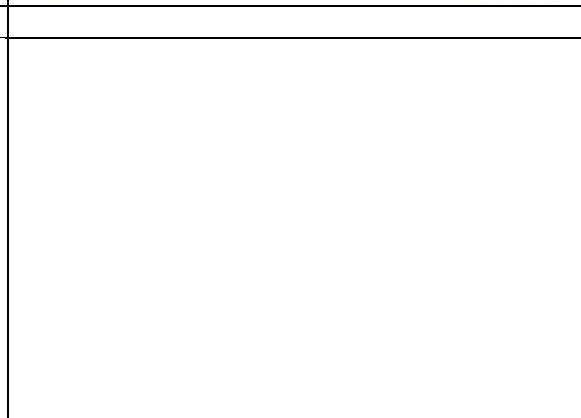
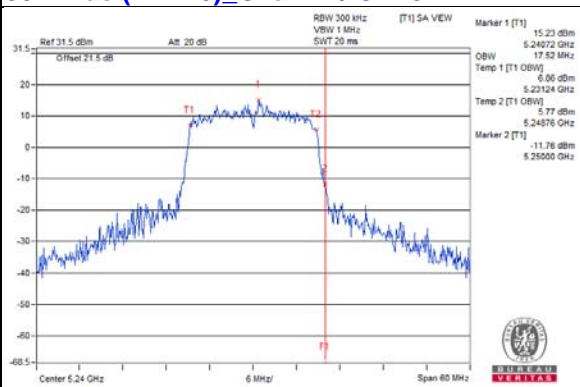

Spectrum Plot for near by DFS band  
(DFS is required, if 99% OCP straddle into U-NII-2A band)

802.11ac (VHT40) Chain 0 / CH46

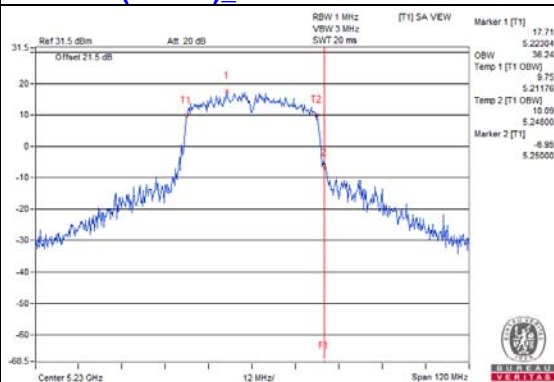

802.11ac (VHT40) Chain 1 / CH46

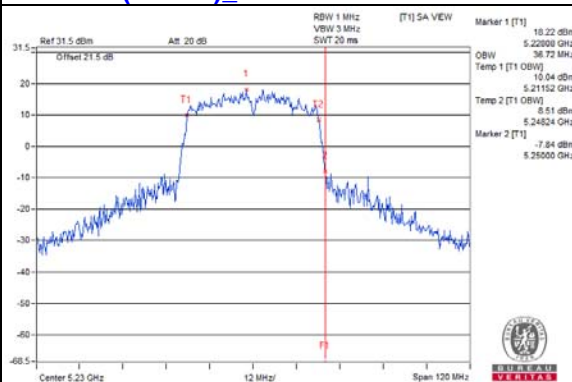

802.11ac (VHT40) Chain 2 / CH46

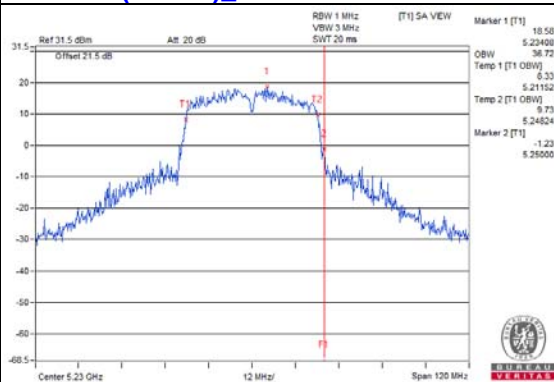

802.11ac (VHT80) Chain 0 / CH42

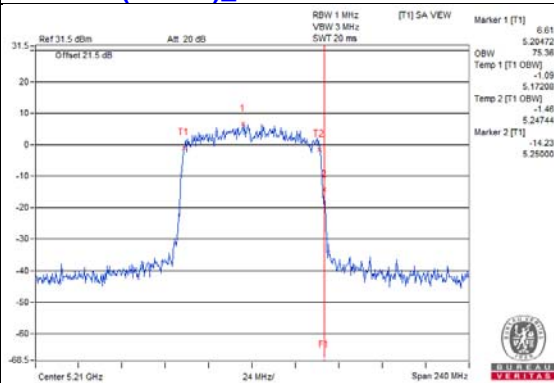

802.11ac (VHT80) Chain 1 / CH42

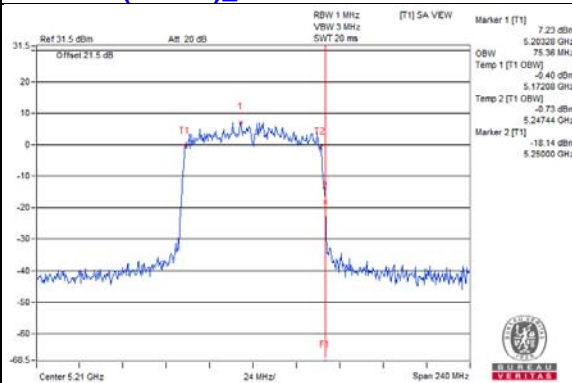

802.11ac (VHT80) Chain 2 / CH42

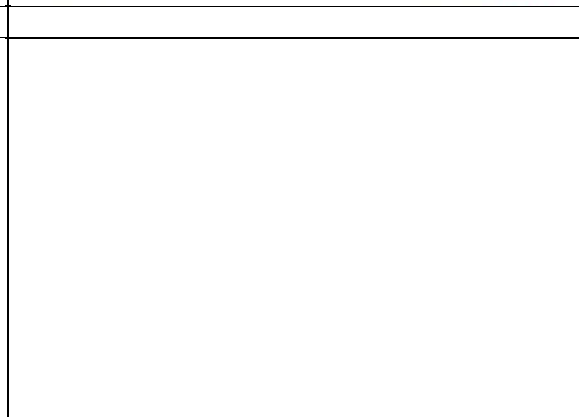
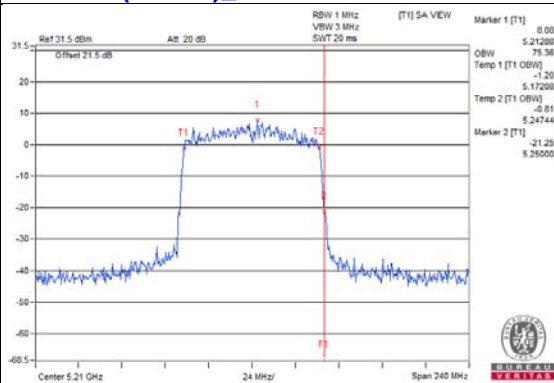

**Spectrum Plot for near by DFS band  
(DFS is required, if 99% OCP straddle into U-NII-2C band)**

**802.11a\_Chain 0 / CH149**

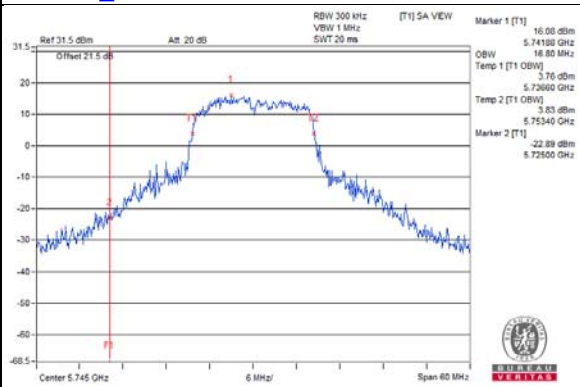

**802.11a\_Chain 1 / CH149**

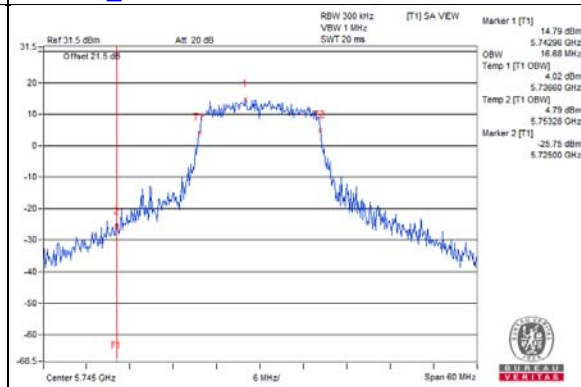

**802.11a\_Chain 2 / CH149**

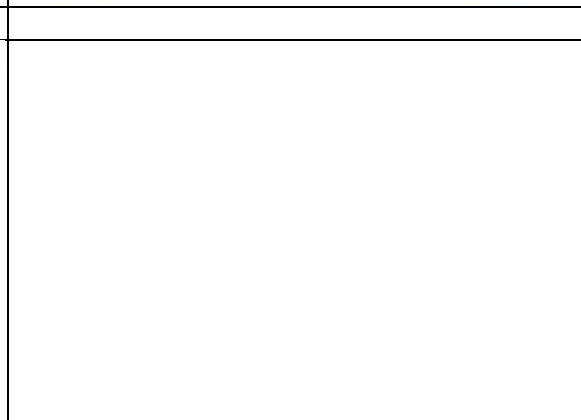
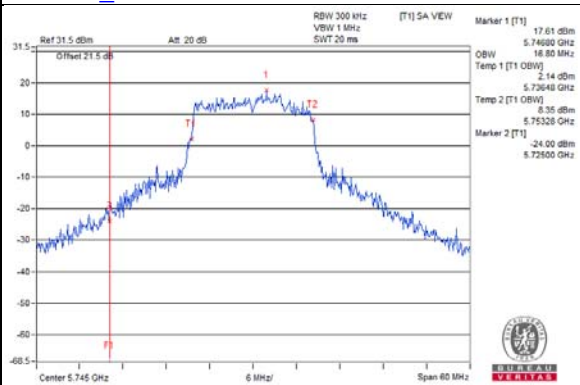

**802.11ac (VHT20)\_Chain 0 / CH149**

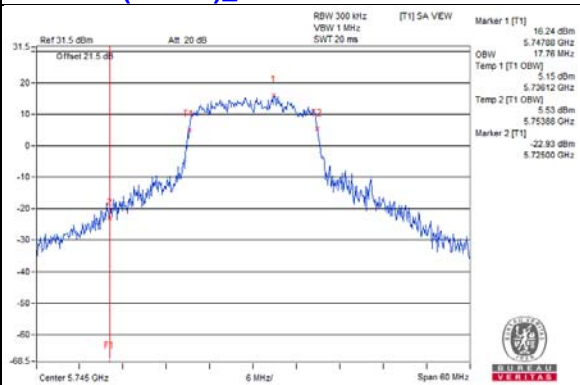

**802.11ac (VHT20)\_Chain 1 / CH149**

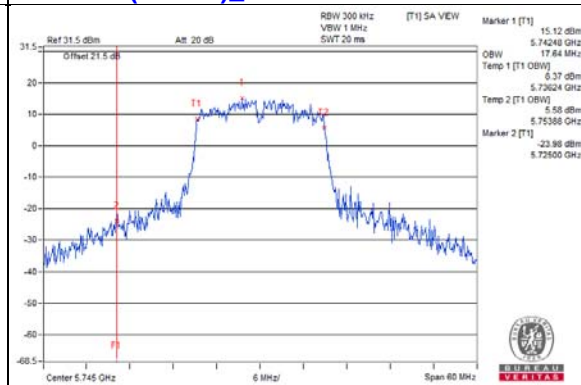

**802.11ac (VHT20)\_Chain 2 / CH149**

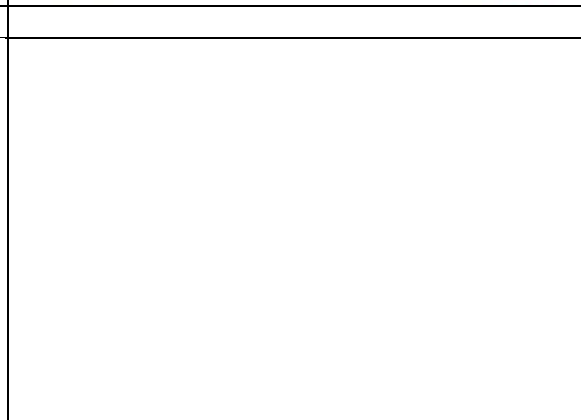
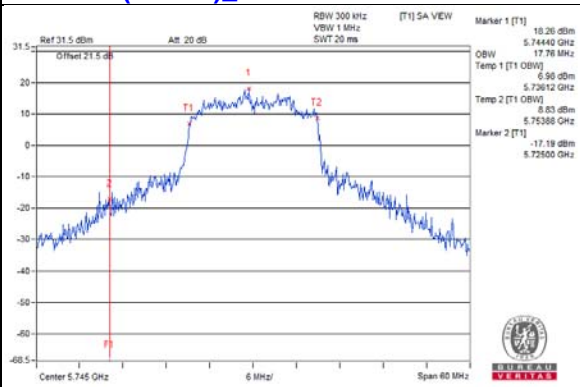

**Spectrum Plot for near by DFS band  
(DFS is required, if 99% OCP straddle into U-NII-2C band)**

**802.11ac (VHT40) Chain 0 / CH151**

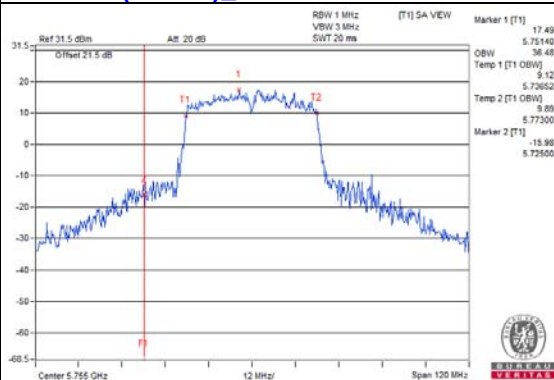

**802.11ac (VHT40) Chain 1 / CH151**

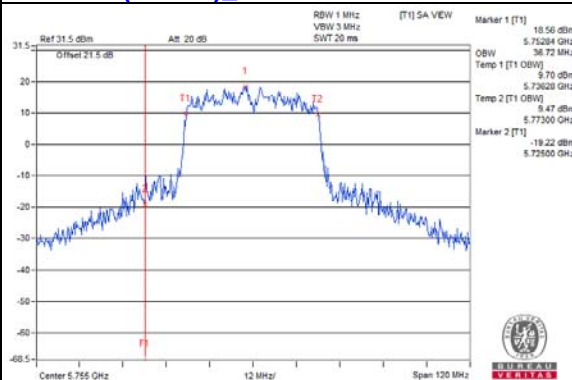

**802.11ac (VHT40) Chain 2 / CH151**

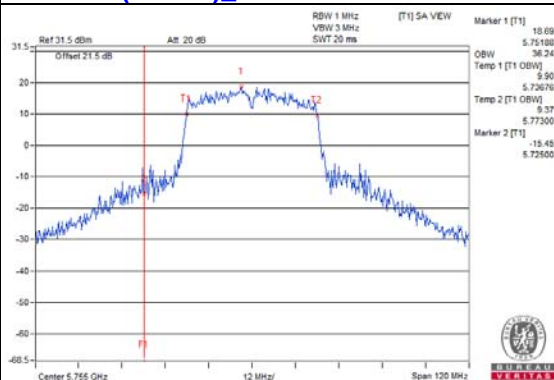

**802.11ac (VHT80) Chain 0 / CH155**

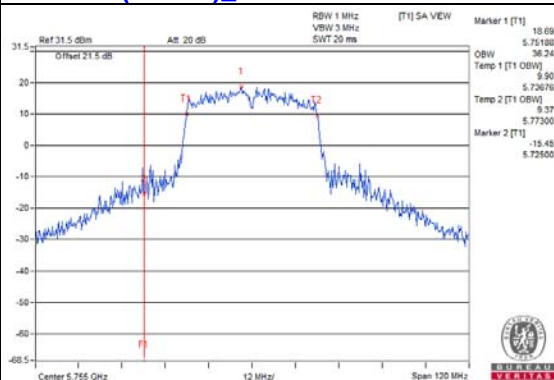

**802.11ac (VHT80) Chain 1 / CH155**

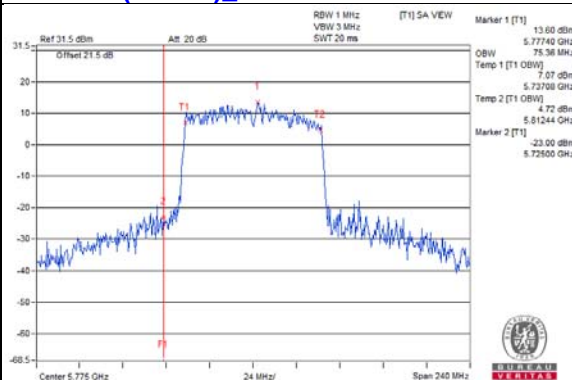

**802.11ac (VHT80) Chain 2 / CH155**

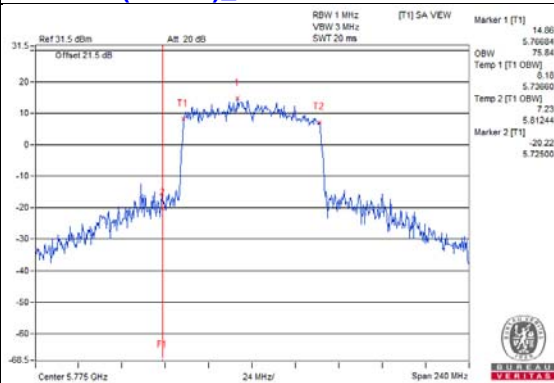

**802.11ac (VHT80) Chain 2 / CH155**

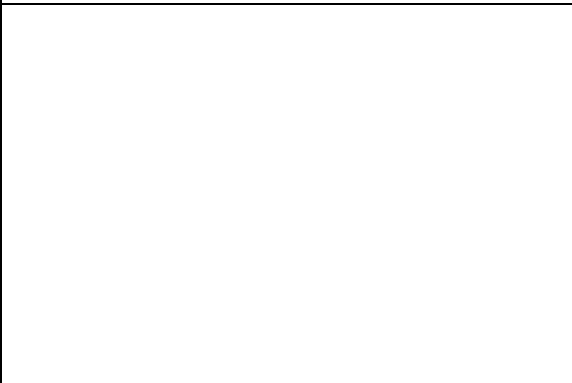

## 4.5 Peak Power Spectral Density Measurement

### 4.5.1 Limits of Peak Power Spectral Density Measurement

Operation Band	EUT Category		Limit
U-NII-1		Outdoor Access Point	17dBm/ MHz
		Fixed point-to-point Access Point	
	√	Indoor Access Point	
		Client device	11dBm/ MHz
U-NII-2A			11dBm/ MHz
U-NII-2C			11dBm/ MHz
U-NII-3		√	30dBm/ 500kHz

### 4.5.2 Test Setup

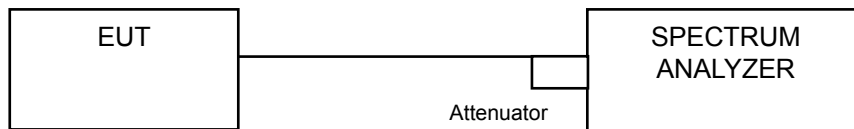

### 4.5.3 Test Instruments

Refer to section 4.1.2 to get information of above instrument.

### 4.5.4 Test Procedure

#### For U-NII-1:

Using method SA-2

1. Set span to encompass the entire emission bandwidth (EBW) of the signal.
2. Set RBW = 1 MHz, Set VBW ≥ 3 MHz, Detector = RMS
3. Sweep time = auto, trigger set to "free run".
4. Trace average at least 100 traces in power averaging mode.
5. Record the max value and add 10 log (1/duty cycle)

#### For U-NII-3:

1. Set span to encompass the entire emission bandwidth (EBW) of the signal.
2. Set RBW = 300 kHz, Set VBW ≥ 1 MHz, Detector = RMS
3. Use the peak marker function to determine the maximum power level in any 300 kHz band segment within the fundamental EBW.
4. Scale the observed power level to an equivalent value in 500 kHz by adjusting (reducing) the measured power by a bandwidth correction factor (BWCF) where  $BWCF = 10\log(500\text{ kHz}/300\text{ kHz})$
5. Sweep time = auto, trigger set to "free run".
6. Trace average at least 100 traces in power averaging mode.
7. Record the max value and add 10 log (1/duty cycle)



#### 4.5.5 Deviation from Test Standard

No deviation.

#### 4.5.6 EUT Operating Condition

Same as Item 4.3.6.

#### 4.5.7 Test Results

##### For U-NII-1:

##### 802.11a

Chan.	Chan. Freq. (MHz)	PSD w/o Duty Factor (dBm/MHz)			Duty Factor (dB)	Total PSD (dBm/MHz)	Max. PSD Limit (dBm/MHz)	Pass / Fail
		Chain0	Chain1	Chain2				
36	5180	8.46	8.40	9.07	0.19	13.62	13.69	PASS
40	5200	8.44	8.55	8.57	0.19	13.48	13.69	PASS
48	5240	7.29	8.41	9.62	0.19	13.51	13.69	PASS

- Note: 1. Method a) of power density measurement of KDB 662911 is using for calculating total power density. Total power density is summing entire spectra across corresponding frequency bins on the various outputs by computer.
2. The directional gain =  $10 \log[(10^{G0/20} + 10^{G1/20} + 10^{G2/20})^2 / 3] = 9.31\text{dBi} > 6\text{dBi}$ , so the power density limit shall be reduced to  $17-(9.31-6)=13.69\text{dBm}$ .
3. Refer to section 3.3 for duty cycle spectrum plot.

##### 802.11ac (VHT20)

Chan.	Chan. Freq. (MHz)	PSD w/o Duty Factor (dBm/MHz)			Duty Factor (dB)	Total PSD (dBm/MHz)	Max. PSD Limit (dBm/MHz)	Pass / Fail
		Chain0	Chain1	Chain2				
36	5180	8.67	8.38	8.39	0.21	13.46	13.69	PASS
40	5200	9.19	7.69	9.03	0.21	13.67	13.69	PASS
48	5240	7.38	7.55	9.08	0.21	13.05	13.69	PASS

- Note: 1. Method a) of power density measurement of KDB 662911 is using for calculating total power density. Total power density is summing entire spectra across corresponding frequency bins on the various outputs by computer.
2. The directional gain =  $10 \log[(10^{G0/20} + 10^{G1/20} + 10^{G2/20})^2 / 3] = 9.31\text{dBi} > 6\text{dBi}$ , so the power density limit shall be reduced to  $17-(9.31-6)=13.69\text{dBm}$ .
3. Refer to section 3.3 for duty cycle spectrum plot.

##### 802.11ac (VHT40)

Chan.	Chan. Freq. (MHz)	PSD w/o Duty Factor (dBm/MHz)			Duty Factor (dB)	Total PSD (dBm/MHz)	Max. PSD Limit (dBm/MHz)	Pass / Fail
		Chain0	Chain1	Chain2				
38	5190	0.53	-0.16	2.41	0.40	6.24	13.69	PASS
46	5230	6.93	8.40	7.18	0.40	12.72	13.69	PASS

- Note: 1. Method a) of power density measurement of KDB 662911 is using for calculating total power density. Total power density is summing entire spectra across corresponding frequency bins on the various outputs by computer.
2. The directional gain =  $10 \log[(10^{G0/20} + 10^{G1/20} + 10^{G2/20})^2 / 3] = 9.31\text{dBi} > 6\text{dBi}$ , so the power density limit shall be reduced to  $17-(9.31-6)=13.69\text{dBm}$ .
3. Refer to section 3.3 for duty cycle spectrum plot.

### 802.11ac (VHT80)

Chan.	Chan. Freq. (MHz)	PSD w/o Duty Factor (dBm/MHz)			Duty Factor (dB)	Total PSD (dBm/MHz)	Max. PSD Limit (dBm/MHz)	Pass / Fail
		Chain0	Chain1	Chain2				
42	5210	-5.21	-5.09	-3.15	0.76	1.15	13.69	PASS

- Note:
- Method a) of power density measurement of KDB 662911 is using for calculating total power density. Total power density is summing entire spectra across corresponding frequency bins on the various outputs by computer.
  - The directional gain =  $10 \log[(10^{G0/20} + 10^{G1/20} + 10^{G2/20})^2 / 3] = 9.31 \text{dBi} > 6 \text{dBi}$ , so the power density limit shall be reduced to  $17 - (9.31 - 6) = 13.69 \text{dBm}$ .
  - Refer to section 3.3 for duty cycle spectrum plot.

#### Spectrum Plot of Worst Value

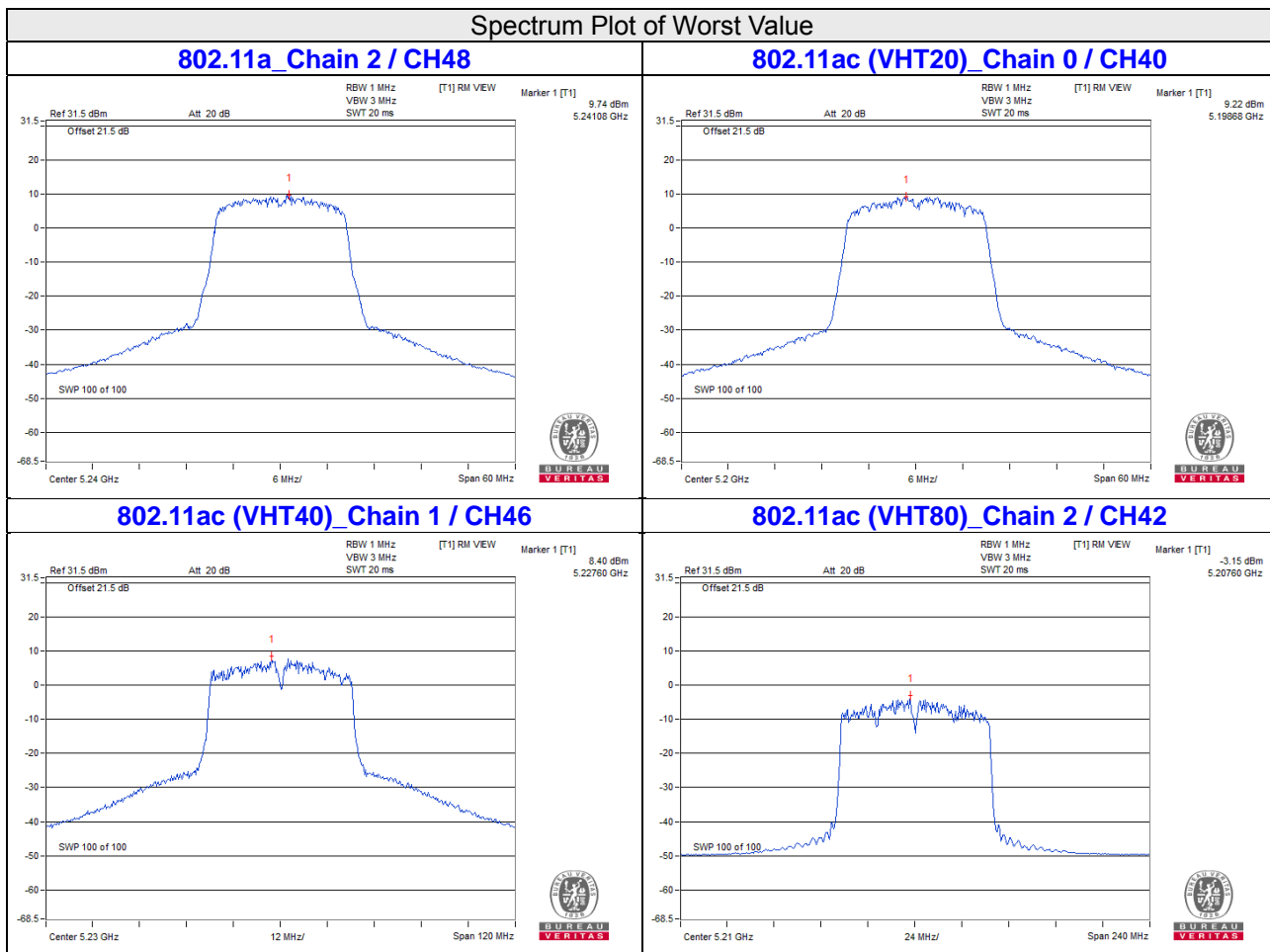

**For U-NII-3:**
**802.11a**

Chan.	Chan. Freq. (MHz)	PSD w/o Duty Factor (dBm/300kHz)			Duty Factor (dB)	Total PSD (mW/300kHz)	Total PSD (dBm/300kHz)	Total PSD (dBm/500kHz)	PSD Limit (dBm/500kHz)	Pass / Fail
		Chain0	Chain1	Chain2						
149	5745	4.84	3.40	5.41	0.19	9.099	9.59	11.81	26.21	PASS
157	5785	4.22	5.58	4.96	0.19	9.817	9.92	12.14	26.21	PASS
165	5825	4.99	3.47	4.73	0.19	8.73	9.41	11.63	26.21	PASS

- Note: 1. Method b) Measure and sum spectral maxima across the outputs of KDB 662911 is using for calculating total power density.
2. The directional gain =  $10 \log[(10^{G0/20} + 10^{G1/20} + 10^{G2/20})^2 / 3] = 9.79\text{dBi} > 6\text{dBi}$ , so the power density limit shall be reduced to  $30-(9.79-6)=26.21\text{dBm}$ .
3. Refer to section 3.3 for duty cycle spectrum plot.

**802.11ac (VHT20)**

Chan.	Chan. Freq. (MHz)	PSD w/o Duty Factor (dBm/300kHz)			Duty Factor (dB)	Total PSD (mW/300kHz)	Total PSD (dBm/300kHz)	Total PSD (dBm/500kHz)	PSD Limit (dBm/500kHz)	Pass / Fail
		Chain0	Chain1	Chain2						
149	5745	4.21	3.53	5.64	0.21	8.974	9.53	11.75	26.21	PASS
157	5785	3.94	3.54	4.45	0.21	7.889	8.97	11.19	26.21	PASS
165	5825	4.22	3.27	3.58	0.21	7.396	8.69	10.91	26.21	PASS

- Note: 1. Method b) Measure and sum spectral maxima across the outputs of KDB 662911 is using for calculating total power density.
2. The directional gain =  $10 \log[(10^{G0/20} + 10^{G1/20} + 10^{G2/20})^2 / 3] = 9.79\text{dBi} > 6\text{dBi}$ , so the power density limit shall be reduced to  $30-(9.79-6)=26.21\text{dBm}$ .
3. Refer to section 3.3 for duty cycle spectrum plot.

**802.11ac (VHT40)**

Chan.	Chan. Freq. (MHz)	PSD w/o Duty Factor (dBm/300kHz)			Duty Factor (dB)	Total PSD (mW/300kHz)	Total PSD (dBm/300kHz)	Total PSD (dBm/500kHz)	PSD Limit (dBm/500kHz)	Pass / Fail
		Chain0	Chain1	Chain2						
151	5755	0.15	0.98	0.65	0.40	3.784	5.78	8.00	26.21	PASS
159	5795	-0.33	-0.72	0.59	0.40	3.1989	5.05	7.27	26.21	PASS

- Note: 1. Method b) Measure and sum spectral maxima across the outputs of KDB 662911 is using for calculating total power density.
2. The directional gain =  $10 \log[(10^{G0/20} + 10^{G1/20} + 10^{G2/20})^2 / 3] = 9.79\text{dBi} > 6\text{dBi}$ , so the power density limit shall be reduced to  $30-(9.79-6)=26.21\text{dBm}$ .
3. Refer to section 3.3 for duty cycle spectrum plot.

### 802.11ac (VHT80)

Chan.	Chan. Freq. (MHz)	PSD w/o Duty Factor (dBm/300kHz)			Duty Factor (dB)	Total PSD (mW/300kHz)	Total PSD (dBm/300kHz)	Total PSD (dBm/500kHz)	PSD Limit (dBm/500kHz)	Pass / Fail
		Chain0	Chain1	Chain2						
155	5775	-5.26	-4.61	-4.27	0.76	1.2134	0.84	3.06	26.21	PASS

- Note: 1. Method b) Measure and sum spectral maxima across the outputs of KDB 662911 is using for calculating total power density.  
 2. The directional gain =  $10 \log[(10^{G0/20} + 10^{G1/20} + 10^{G2/20})^2 / 3]$  = 9.79dBi > 6dBi, so the power density limit shall be reduced to 30-(9.79-6)=26.21dBm.  
 3. Refer to section 3.3 for duty cycle spectrum plot.

#### Spectrum Plot of Worst Value

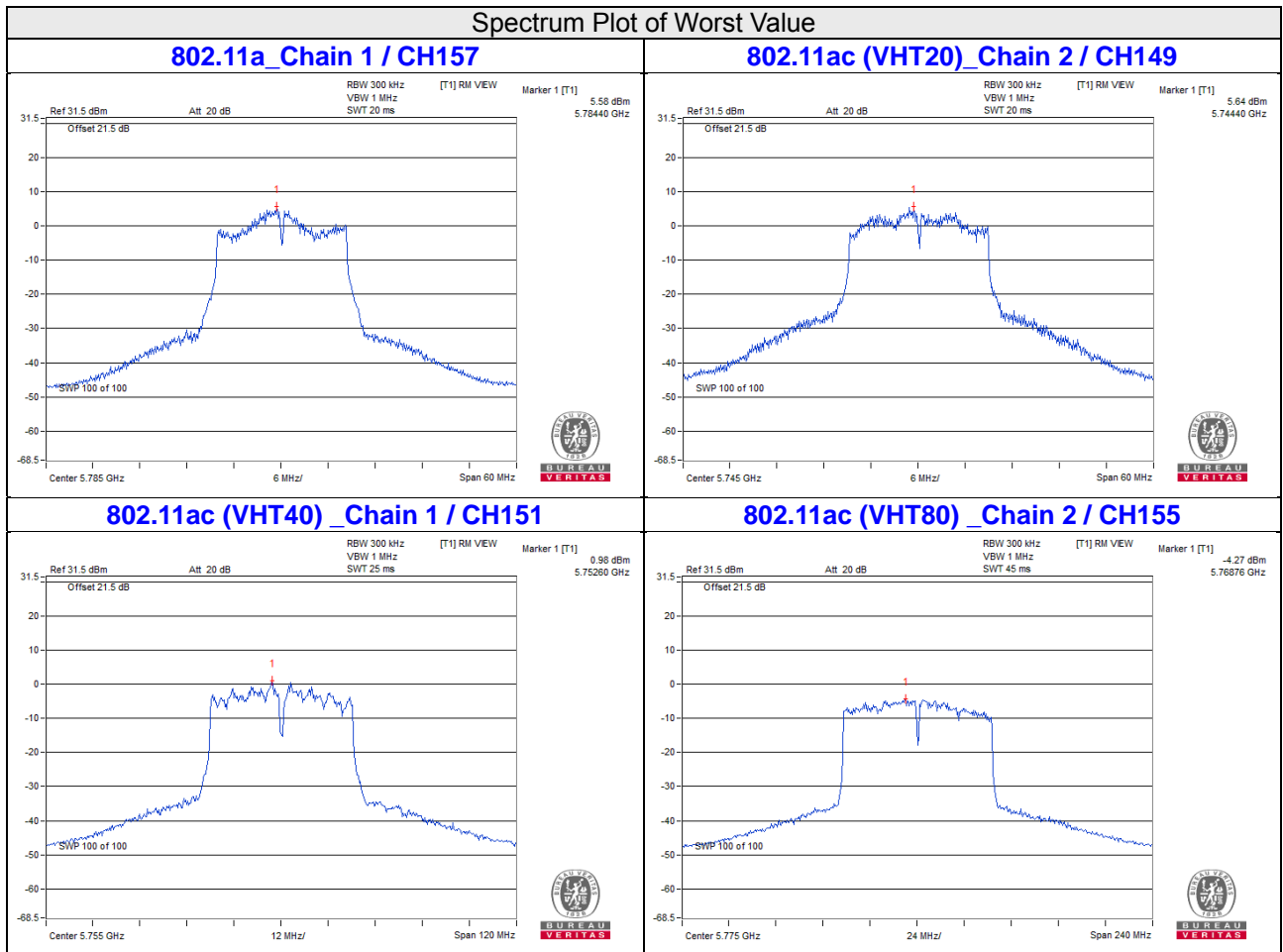

## 4.6 Frequency Stability Measurement

### 4.6.1 Limits of Frequency Stability Measurement

The frequency of the carrier signal shall be maintained within band of operation

### 4.6.2 Test Setup

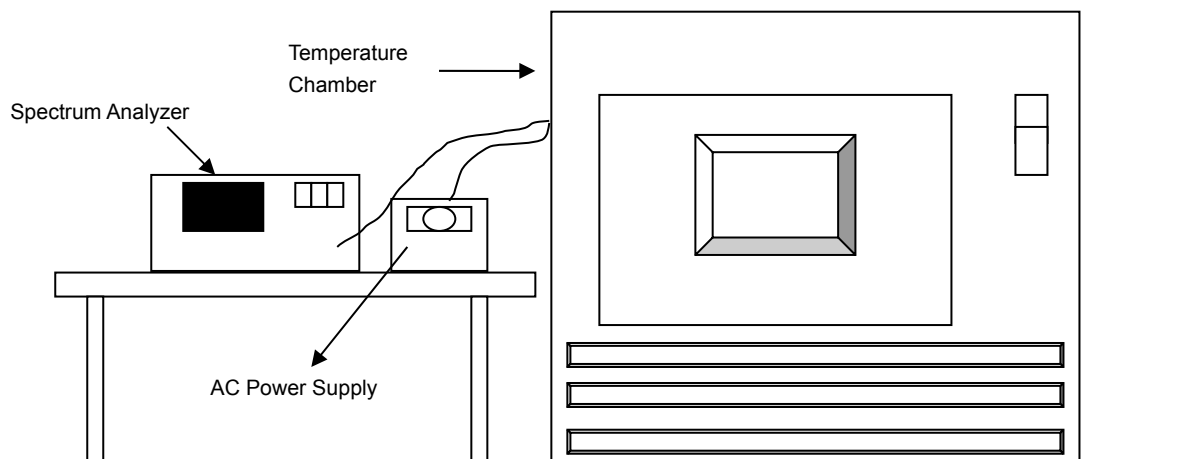

### 4.6.3 Test Instruments

Refer to section 4.1.2 to get information of above instrument.

### 4.6.4 Test Procedure

- The EUT was placed inside the environmental test chamber and powered by nominal AC voltage.
- Turn the EUT on and couple its output to a spectrum analyzer.
- Turn the EUT off and set the chamber to the highest temperature specified.
- Allow sufficient time (approximately 30 min) for the temperature of the chamber to stabilize, turn the EUT on and measure the operating frequency after 2, 5, and 10 Minutes.
- Repeat step (d) with the temperature chamber set to the next desired temperature until measurements down to the lowest specified temperature have been completed.
- The test chamber was allowed to stabilize at +20 degree C for a minimum of 30 Minutes. The supply voltage was then adjusted on the EUT from 85% to 115% and the frequency record.

### 4.6.5 Deviation from Test Standard

No deviation.

### 4.6.6 EUT Operating Condition

Set the EUT transmit at un-modulation mode to test frequency stability.

## 4.6.7 Test Results

Frequency Stability Versus Temp.									
Operating Frequency: 5180 MHz									
TEMP. (°C)	Power Supply (Vac)	0 Minute		2 Minutes		5 Minutes		10 Minutes	
		Measured Frequency (MHz)	Pass/Fail	Measured Frequency (MHz)	Pass/Fail	Measured Frequency (MHz)	Pass/Fail	Measured Frequency (MHz)	Pass/Fail
40	120	5179.9792	PASS	5179.982	PASS	5179.983	PASS	5179.9816	PASS
30	120	5179.986	PASS	5179.9859	PASS	5179.9886	PASS	5179.9881	PASS
20	120	5180.0137	PASS	5180.0185	PASS	5180.0183	PASS	5180.0139	PASS
10	120	5180.0222	PASS	5180.0239	PASS	5180.0249	PASS	5180.0219	PASS
0	120	5180.0037	PASS	5180.0035	PASS	5180.0008	PASS	5180.0019	PASS

Frequency Stability Versus Voltage									
Operating Frequency: 5180 MHz									
TEMP. (°C)	Power Supply (Vac)	0 Minute		2 Minutes		5 Minutes		10 Minutes	
		Measured Frequency (MHz)	Pass/Fail	Measured Frequency (MHz)	Pass/Fail	Measured Frequency (MHz)	Pass/Fail	Measured Frequency (MHz)	Pass/Fail
20	138	5180.0141	PASS	5180.018	PASS	5180.0189	PASS	5180.0147	PASS
	120	5180.0137	PASS	5180.0185	PASS	5180.0183	PASS	5180.0139	PASS
	102	5180.0135	PASS	5180.0187	PASS	5180.0184	PASS	5180.0145	PASS

## 4.7 6dB Bandwidth Measurement

### 4.7.1 Limits of 6dB Bandwidth Measurement

The minimum of 6dB Bandwidth Measurement is 0.5MHz.

### 4.7.2 Test Setup

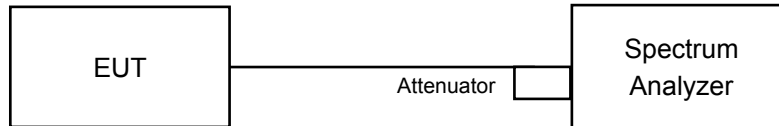

### 4.7.3 Test Instruments

Refer to section 4.1.2 to get information of above instrument.

### 4.7.4 Test Procedure

#### MEASUREMENT PROCEDURE REF

- Set resolution bandwidth (RBW) = 100kHz
- Set the video bandwidth (VBW)  $\geq 3 \times$  RBW, Detector = Peak.
- Trace mode = max hold.
- Sweep = auto couple.
- Measure the maximum width of the emission that is constrained by the frequencies associated with the two amplitude points (upper and lower) that are attenuated by 6 dB relative to the maximum level measured in the fundamental emission.

### 4.7.5 Deviation from Test Standard

No deviation.

### 4.7.6 EUT Operating Condition

The software provided by client to enable the EUT under transmission condition continuously at lowest, middle and highest channel frequencies individually.



#### 4.7.7 Test Results

##### 802.11a

Channel	Frequency (MHz)	6dB Bandwidth (MHz)			Minimum Limit (MHz)	Pass / Fail
		Chain 0	Chain 1	Chain 2		
149	5745	15.16	15.22	15.71	0.5	Pass
157	5785	15.2	15.16	15.15	0.5	Pass
165	5825	15.16	15.5	15.3	0.5	Pass

##### 802.11ac (VHT20)

Channel	Frequency (MHz)	6dB Bandwidth (MHz)			Minimum Limit (MHz)	Pass / Fail
		Chain 0	Chain 1	Chain 2		
149	5745	15.15	16.35	15.19	0.5	Pass
157	5785	15.14	16.93	15.16	0.5	Pass
165	5825	15.19	16.35	15.73	0.5	Pass

##### 802.11ac (VHT40)

Channel	Frequency (MHz)	6dB Bandwidth (MHz)			Minimum Limit (MHz)	Pass / Fail
		Chain 0	Chain 1	Chain 2		
151	5755	35.18	35.76	35.15	0.5	Pass
159	5795	35.17	35.18	35.16	0.5	Pass

##### 802.11ac (VHT80)

Channel	Frequency (MHz)	6dB Bandwidth (MHz)			Minimum Limit (MHz)	Pass / Fail
		Chain 0	Chain 1	Chain 2		
155	5775	75.49	71.78	71.66	0.5	Pass

Spectrum Plot of Worst Value

802.11a\_Chain 2 / CH157

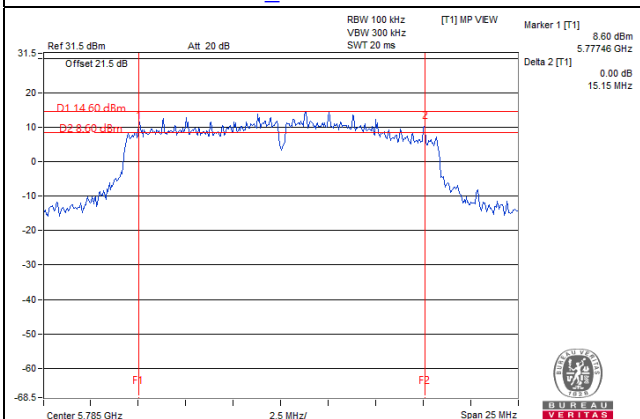

802.11ac (VHT20)\_Chain 0 / CH157

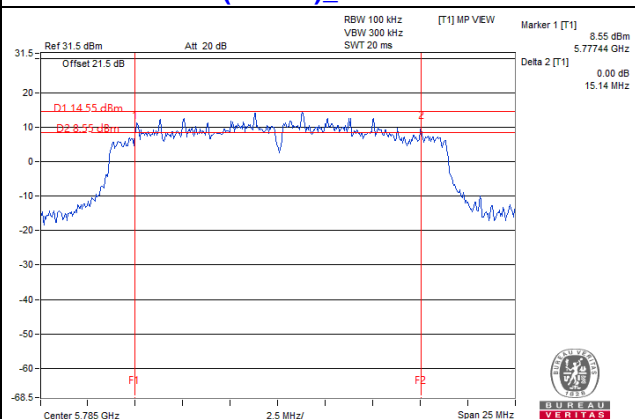

802.11ac (VHT40)\_Chain 2 / CH151

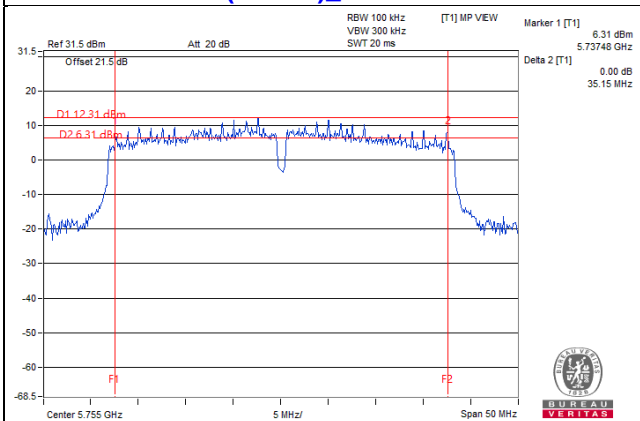

802.11ac (VHT80)\_Chain 2 / CH155

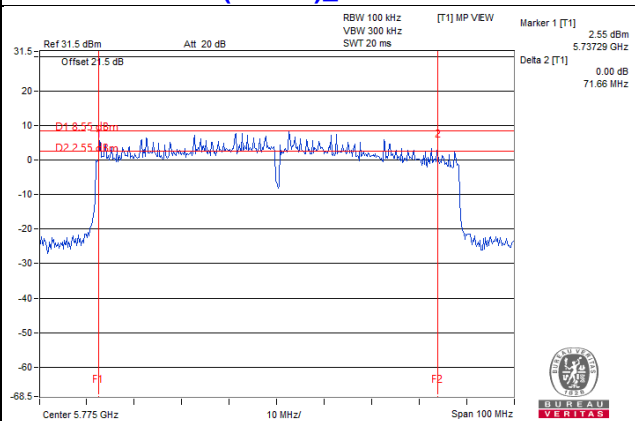

## 5 Pictures of Test Arrangements

Please refer to the attached file (Test Setup Photo).

### Annex A- Radiated Out of Band Emission (OOBE) Measurement (For U-NII-3 band)

802.11a

**CH 149 5745 MHz**

**Horizontal**

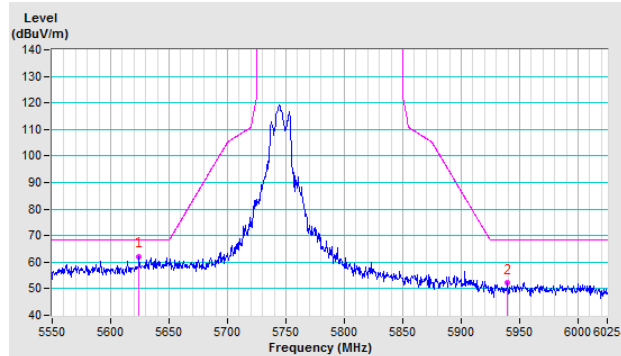

**Vertical**

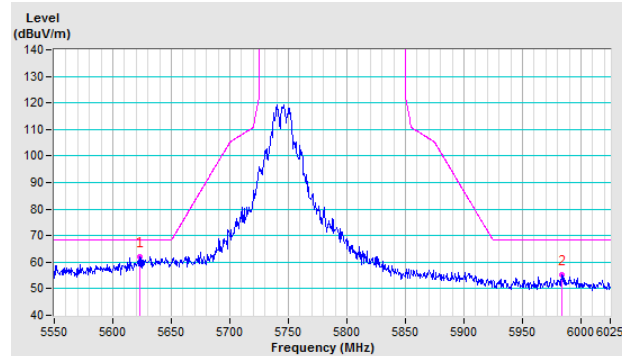

**CH 157 5785 MHz**

**Horizontal**

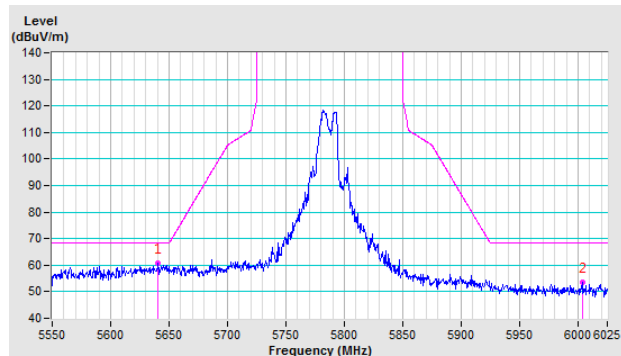

**Vertical**

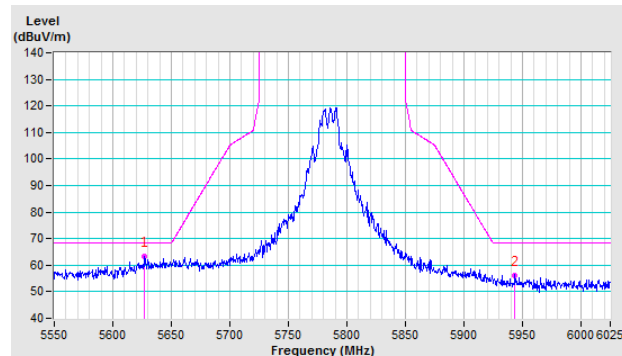

**CH 165 5825 MHz**

**Horizontal**

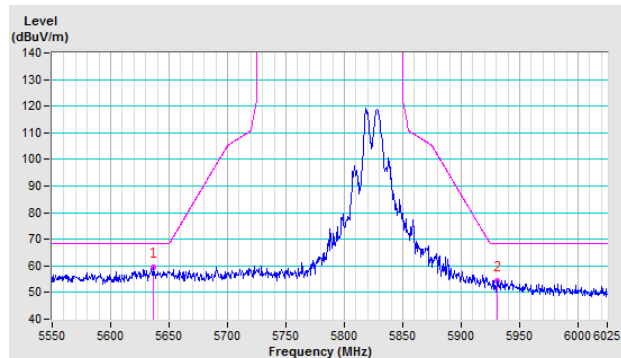

**Vertical**

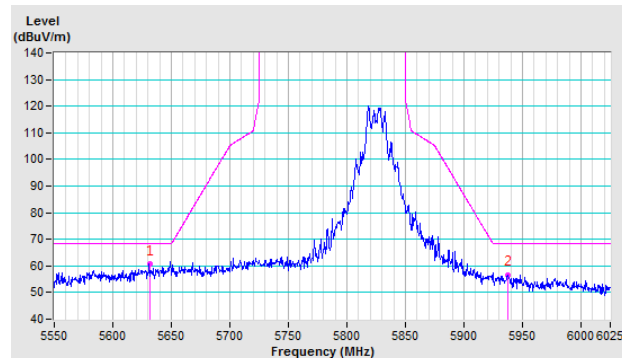

### 802.11ac (VHT20)

**CH 149 5745 MHz**

**Horizontal**

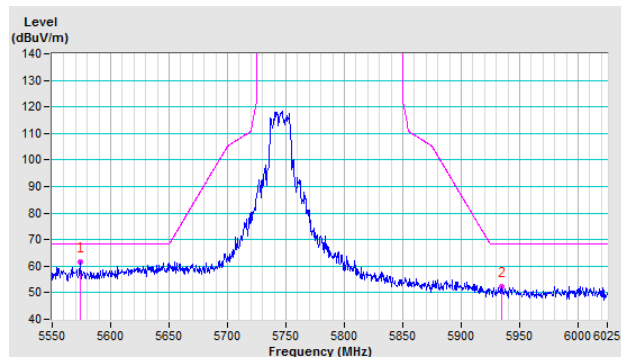

**Vertical**

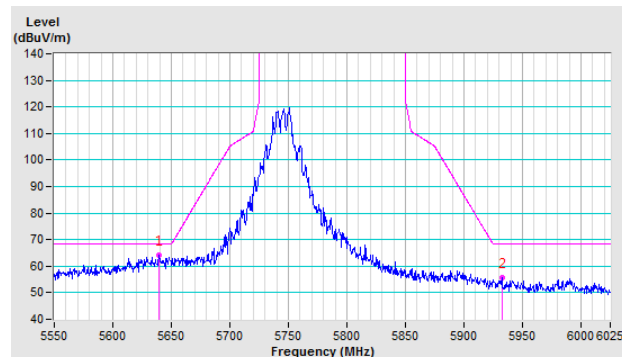

**CH 157 5785 MHz**

**Horizontal**

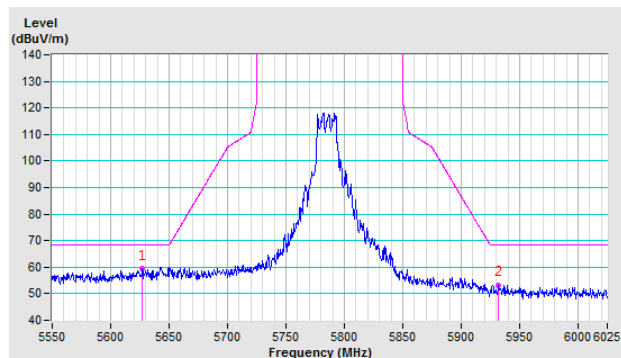

**Vertical**

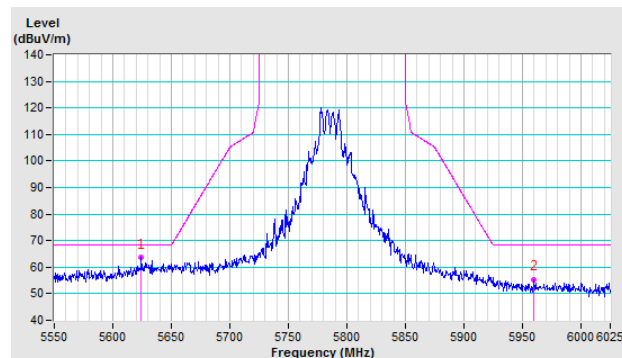

**CH 165 5825 MHz**

**Horizontal**

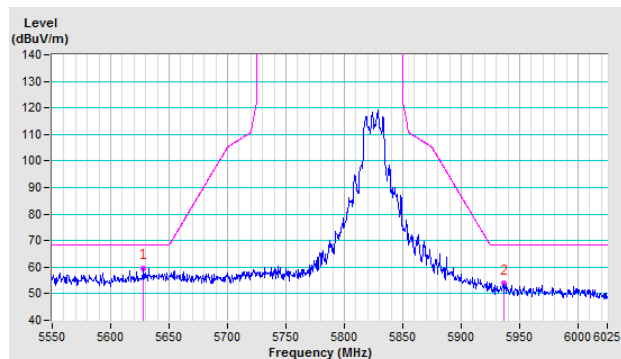

**Vertical**

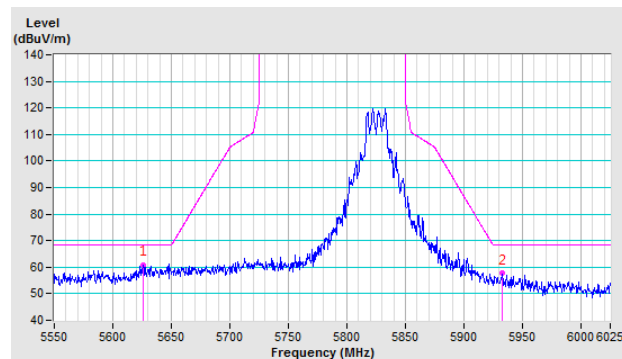

### 802.11ac (VHT40)

CH 151 5755 MHz

Horizontal

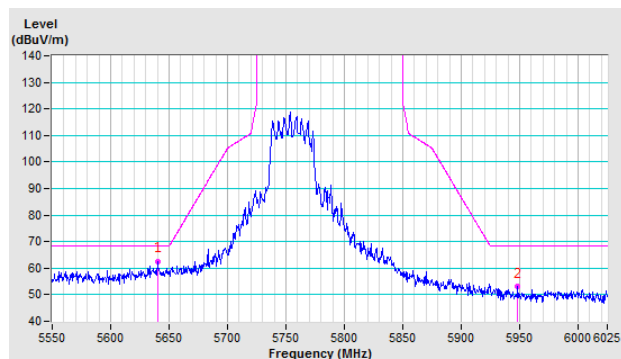

Vertical

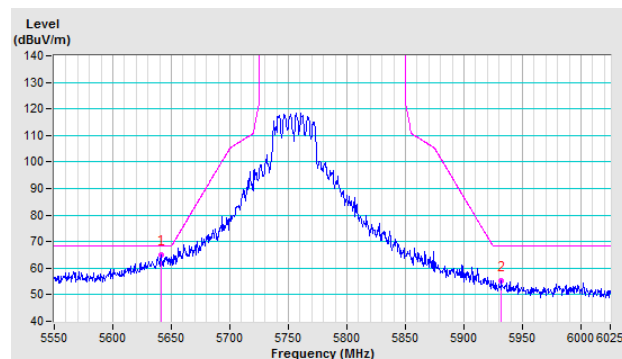

CH 159 5795 MHz

Horizontal

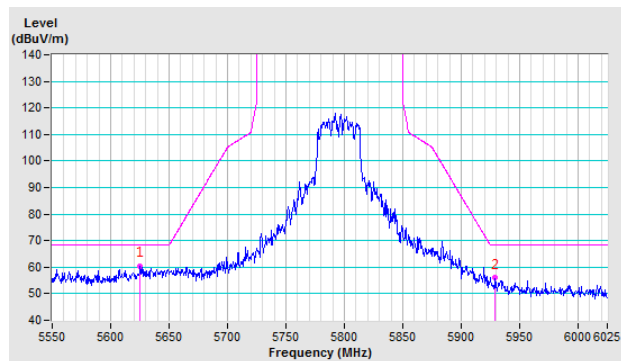

Vertical

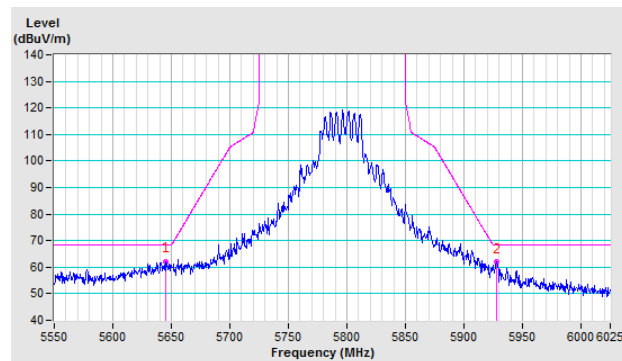

### 802.11ac (VHT80)

CH 155 5775 MHz

Horizontal

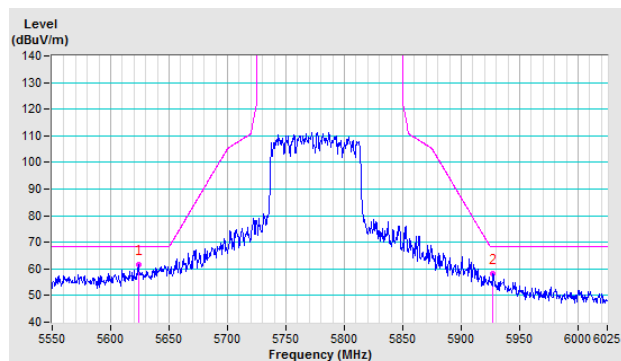

Vertical

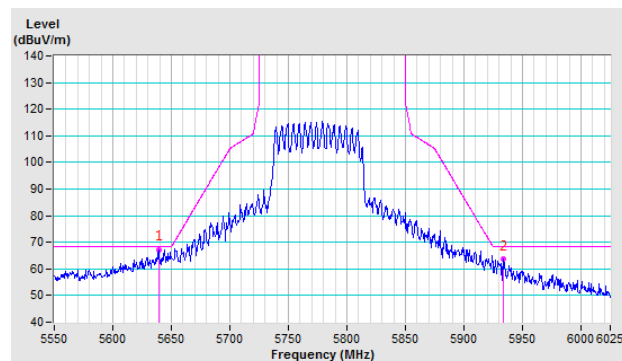

# Annex B- Band-edge measurement (For U-NII-1 band)

## 802.11a

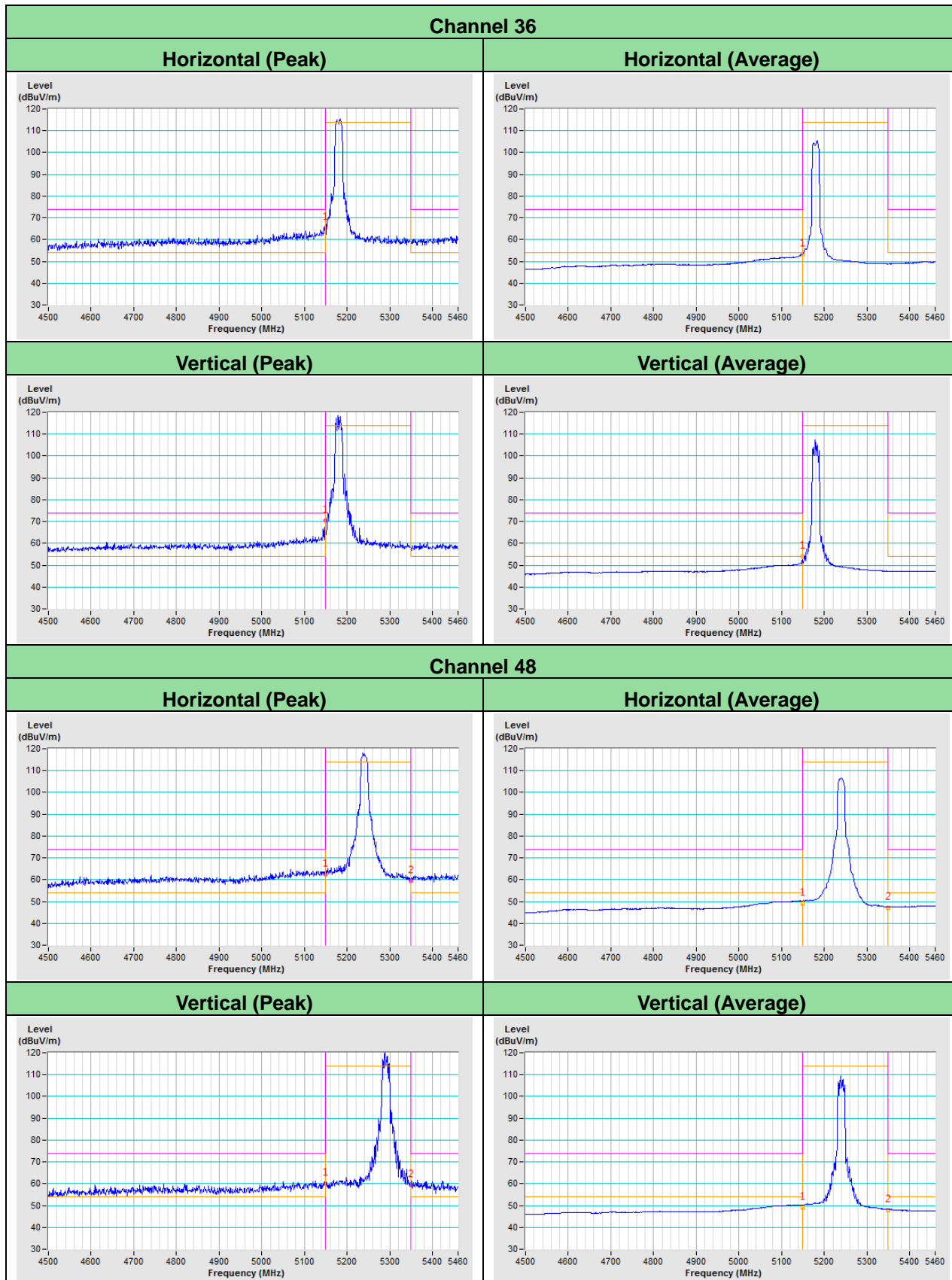

802.11ac (VHT20)

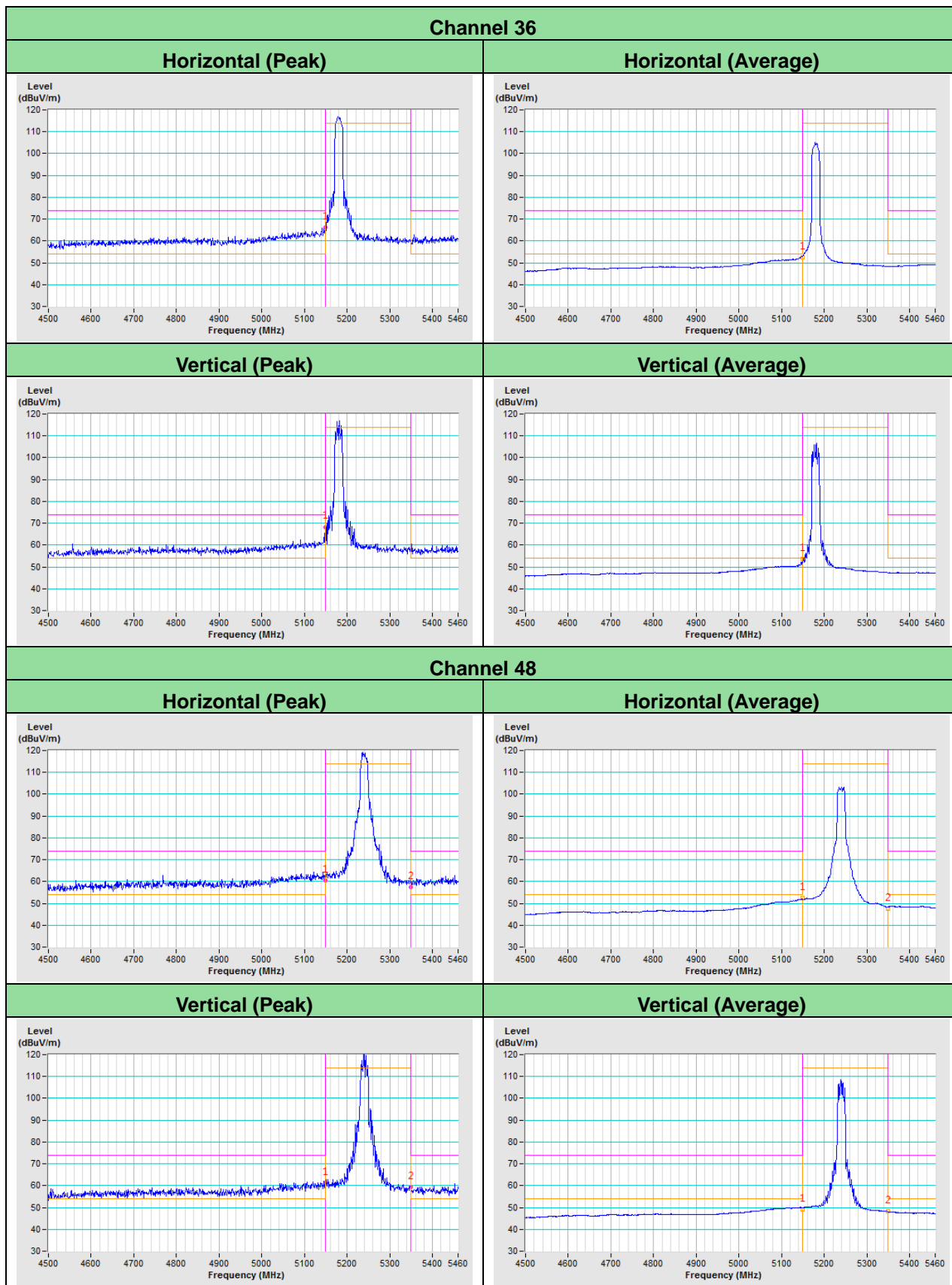



802.11ac (VHT40)

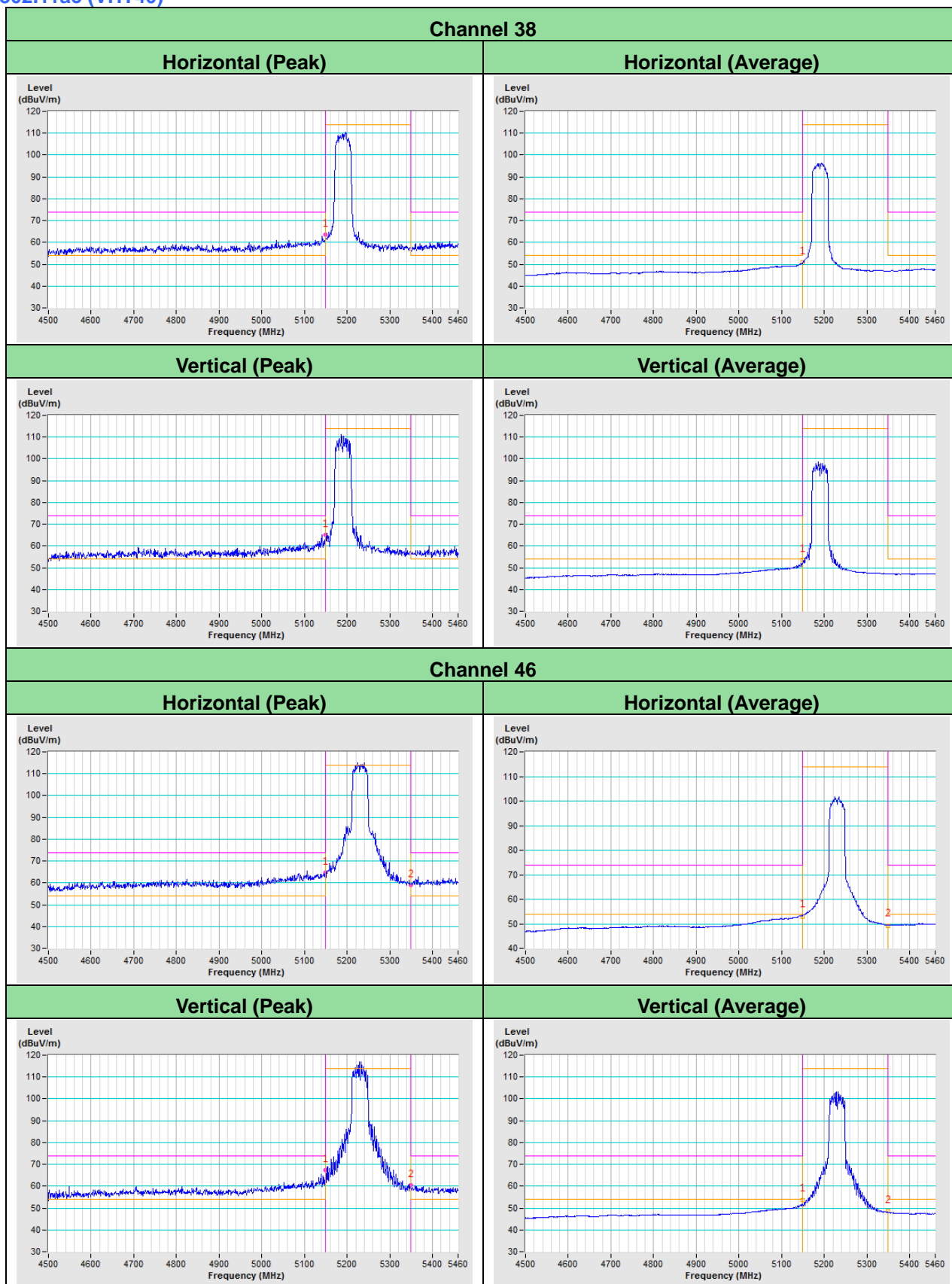

802.11ac (VHT80)

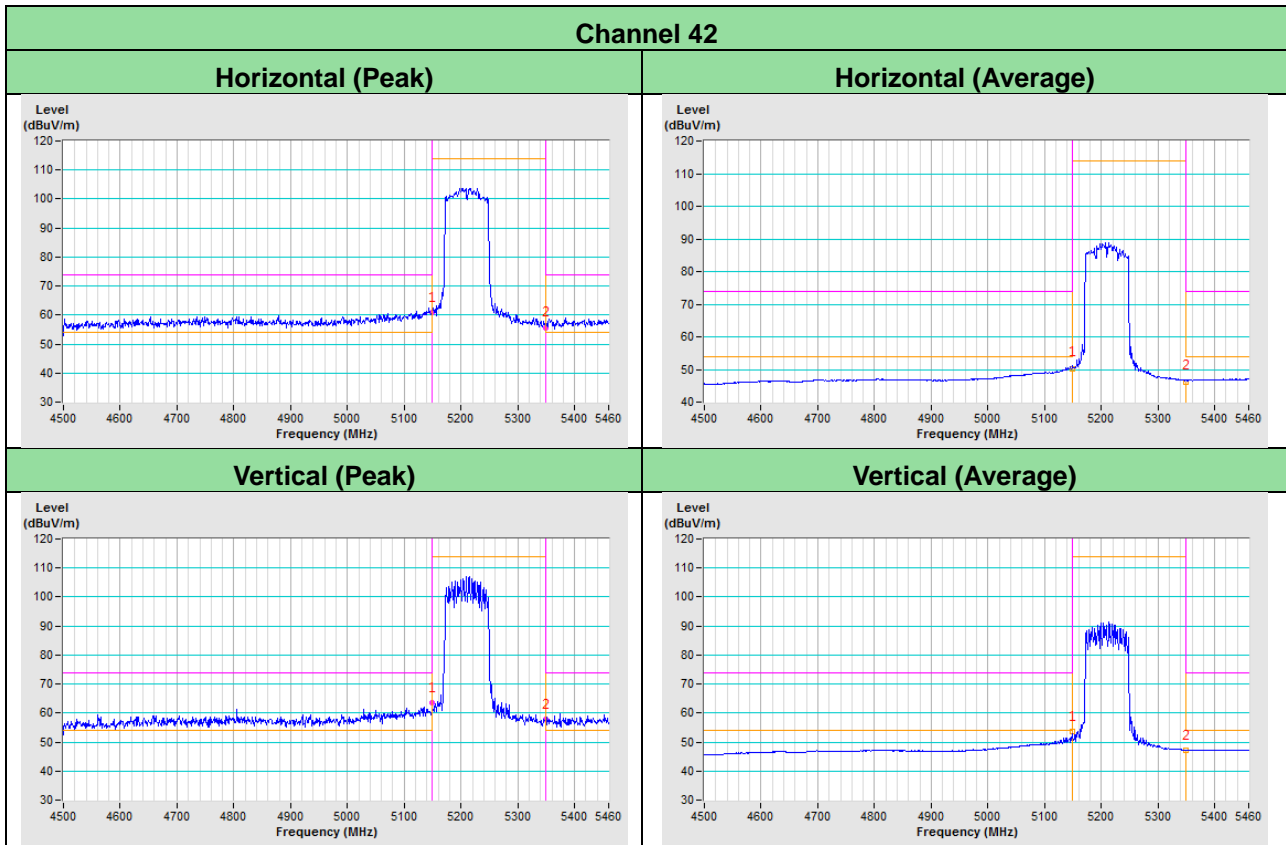

## Appendix – Information of the Testing Laboratories

We, Bureau Veritas Consumer Products Services (H.K.) Ltd., Taoyuan Branch, were founded in 1988 to provide our best service in EMC, Radio, Telecom and Safety consultation. Our laboratories are FCC recognized accredited test firms and accredited according to ISO/IEC 17025.

If you have any comments, please feel free to contact us at the following:

**Lin Kou EMC/RF Lab**

Tel: 886-2-26052180

Fax: 886-2-26051924

**Hsin Chu EMC/RF/Telecom Lab**

Tel: 886-3-6668565

Fax: 886-3-6668323

**Hwa Ya EMC/RF/Safety Lab**

Tel: 886-3-3183232

Fax: 886-3-3270892

**Email:** [service.adt@tw.bureauveritas.com](mailto:service.adt@tw.bureauveritas.com)

**Web Site:** [www.bureauveritas-adt.com](http://www.bureauveritas-adt.com)

The address and road map of all our labs can be found in our web site also.

--- END ---