



## FCC 47 CFR PART 15 SUBPART C

for

**VDSL2/ADSL2+ Modem plus AC1600 Router**

**Model: MD1600, MD1600XY (where X can be A, B, C, D or blank,  
and Y can be A, B, C, D, or blank)**

**Brand: Motorola**

**Test Report Number:**

**C170824Z02-RP1-1**

**Issued Date: October 18, 2017**

Issued for

**MTRLC LLC**

**PO Box 121147 Boston, MA 02112-1147, United States**

Issued by:

**Compliance Certification Services (Shenzhen) Inc.**

No.10-1 Mingkeda Logistics park, No.18, Huanguan South Rd.,  
Guan Lan Town, Baoan District, Shenzhen, China

TEL: 86-755-28055000

FAX: 86-755-28055221

E-Mail: [service@ccssz.com](mailto:service@ccssz.com)



Certificate Number: 2861.01

**Note:** This report shall not be reproduced except in full, without the written approval of Compliance Certification Services (Shenzhen) Inc. This document may be altered or revised by Compliance Certification Services (Shenzhen) Inc. personnel only, and shall be noted in the revision section of the document. The client should not use it to claim product endorsement by TAF, A2LA, NVLAP, NIST or any government agencies. The test results in the report only apply to the tested sample.



Revision History

Rev.	Issue Date	Revisions	Effect Page	Revised By
00	October 18, 2017	Initial Issue	ALL	Sinphy Xie



**TABLE OF CONTENTS**

**1 TEST CERTIFICATION.....4**

**2 TEST RESULT SUMMARY.....5**

**3 EUT DESCRIPTION .....6**

**4 TEST METHODOLOGY .....7**

    4.1. DESCRIPTION OF TEST MODES .....7

**5 SETUP OF EQUIPMENT UNDER TEST.....8**

    5.1. DESCRIPTION OF SUPPORT UNITS.....8

    5.2. CONFIGURATION OF SYSTEM UNDER TEST .....8

**6 FACILITIES AND ACCREDITATIONS .....9**

    6.1. FACILITIES .....9

    6.2. ACCREDITATIONS .....9

    6.3. MEASUREMENT UNCERTAINTY.....9

**7 FCC PART 15.247 REQUIREMENTS..... 10**

    7.1. POWER LINE CONDUCTED EMISSIONS MEASUREMENT ..... 10

    7.2. SPURIOUS EMISSIONS MEASUREMENT..... 17

    7.3. 6dB BANDWIDTH MEASUREMENT ..... 71

    7.4. ANTENNA GAIN ..... 85

    7.5. PEAK OUTPUT POWER ..... 87

    7.6. BAND EDGES MEASUREMENT..... 90

    7.7. PEAK POWER SPECTRAL DENSITY MEASUREMENT..... 116



# 1 TEST CERTIFICATION

<b>Product</b>	VDSL2/ADSL2+ Modem plus AC1600 Router
<b>Model</b>	MD1600, MD1600XY (where X can be A, B, C, D or blank, and Y can be A, B, C, D, or blank)
<b>Brand</b>	Motorola
<b>Tested</b>	August 24~October 16, 2017
<b>Applicant</b>	<b>MTRLC LLC</b> PO Box 121147 Boston, MA 02112-1147, United States
<b>Manufacturer</b>	<b>MTRLC LLC</b> PO Box 121147 Boston, MA 02112-1147, United States

APPLICABLE STANDARDS			
Standard	Test Type	Standard	Test Type
15.207(a)	Power Line Conducted Emissions	15.247(d) 15.209(a)	<ul style="list-style-type: none"> <li>● Spurious Emissions</li> <li>● Conducted Measurement</li> <li>● Radiated Emissions</li> </ul>
15.247(a)(2)	6dB Bandwidth Measurement	15.247(b)(3) 15.247(b)(4)	Peak Power Measurement
15.247(d)	Band Edges Measurement	15.247(e)	Peak Power Spectral Density

## We hereby certify that:

The above equipment was tested by Compliance Certification Services (Shenzhen) Inc. The test data, data evaluation, test procedures, and equipment configurations shown in this report were made in accordance with the procedures given in **ANSI C63.10: 2013** and the energy emitted by the sample EUT tested as described in this report is in compliance with the requirements of FCC Rules Part 15.207, 15.209, 15.247. The test results of this report relate only to the tested sample EUT identified in this report.

**Approved by:**

**Reviewed by:**

**Sunday Hu**  
Supervisor of EMC Dept.  
Compliance Certification Services (Shenzhen) Inc.

**Ruby Zhang**  
Supervisor of Report Dept.  
Compliance Certification Services (Shenzhen) Inc.



## 2 TEST RESULT SUMMARY

APPLICABLE STANDARDS			
Standard	Test Type	Result	Remark
15.247(a)(2)	6dB Bandwidth Measurement	Pass	Meet the requirement of limit.
15.247(b)(3) 15.247(b)(4)	Peak Power Measurement	Pass	Meet the requirement of limit.
15.247(d)	Band Edges Measurement	Pass	Meet the requirement of limit.
15.247(e)	Peak Power Spectral Density	Pass	Meet the requirement of limit.
15.247(d) 15.209(a)	<ul style="list-style-type: none"><li>● Spurious Emissions</li><li>● Conducted Measurement</li><li>● Radiated Emissions</li></ul>	Pass	Meet the requirement of limit.
15.207(a)	Power line Conducted Emissions	Pass	Meet the requirement of limit.

- Note:
1. The statements of test result on the above are decided by the request of test standard only; the measurement uncertainties are not factored into this compliance determination.
  2. The information of measurement uncertainty is available upon the customer's request.



### 3 EUT DESCRIPTION

<b>Product</b>	VDSL2/ADSL2+ Modem plus AC1600 Router
<b>Model Number</b>	MD1600, MD1600XY (where X can be A, B, C, D or blank, and Y can be A, B, C, D, or blank)
<b>Brand</b>	Motorola
<b>Model Discrepancy</b>	The optional suffixes X and Y are to be used for identical hardware models that differ for marketing purposes only.
<b>Identify Number</b>	C170824Z02-RP1-1
<b>Received Date</b>	August 24, 2017
<b>Power Supply</b>	DC12V supplied by the adapter
<b>Adapter Manufacturer /Model No.</b>	Shenzhen Gongjin Electronics Co.,Ltd. S24B72-120A200-C4 INPUT: AC100-240V~50/60Hz Max 0.8A OUTPUT: 12V, 2A DC Cable: Unshielded, 1.50m
<b>Transmit Power</b>	IEEE 802.11b mode: 20.71dBm (Antenna 0) IEEE 802.11b mode: 23.29dBm (Antenna 1) IEEE 802.11g mode: 21.43dBm (Antenna 0) IEEE 802.11g mode: 21.58dBm (Antenna 1) IEEE 802.11n HT20 MHz mode: 21.86dBm(Combine with Antenna 0 and Antenna 1) IEEE 802.11n HT40 MHz mode: 19.04dBm(Combine with Antenna 0 and Antenna 1)
<b>Modulation Technique</b>	IEEE 802.11b mode: DSSS(CCK,QPSK, BPSK) IEEE 802.11g mode: OFDM (BPSK/QPSK/16QAM/64QAM) IEEE 802.11n HT20 MHz mode: OFDM (BPSK/QPSK/16QAM/64QAM) IEEE 802.11n HT40 MHz mode: OFDM (BPSK/QPSK/16QAM/64QAM)
<b>Transmit Data Rate</b>	IEEE 802.11b: 11Mbps(CCK) with fall back rates of 5.5/2/1Mbps IEEE 802.11g: 54Mbps with fall back rates of 48/36/24/18/12/9 /6Mbps IEEE 802.11n HT20: 130Mbps with fall back rates of 130/117/104/ 78/52/39/26/13Mbps IEEE 802.11n HT40: 270Mbps with fall back rates of 270/243/216/ 162/108/81/54/27Mbps
<b>Number of Channels</b>	IEEE 802.11b mode: 11 Channels IEEE 802.11g mode: 11 Channels IEEE 802.11n HT20 MHz mode: 11 Channels IEEE 802.11n HT40 MHz mode: 7 Channels
<b>Antenna Specification</b>	PCB Antenna with 2dBi gain (Max)
<b>Channels Spacing</b>	IEEE 802.11b/g ,802.11n HT20/HT40 : 5MHz
<b>Temperature Range</b>	0°C ~ +40°C
<b>Hardware Version</b>	V1
<b>Software Version</b>	VDSL-BCM016-0003-MT-R6B005-ZM

- Note:**
1. The sample selected for test was engineering sample that approximated to production product and was provided by manufacturer.
  2. This submittal(s) (test report) is intended for FCC ID: **2AF5PMD1600** filing to comply with Section 15.207, 15.209 and 15.247 of the FCC Part 15, Subpart C Rules.



## 4 TEST METHODOLOGY

### 4.1. DESCRIPTION OF TEST MODES

The EUT has been tested under operating condition.

Use MTool to control the EUT for staying in continuous transmitting and receiving mode.

Test Item	Test mode	Worse mode
Conducted Emission	<b>Mode 1:</b> 1000Mbps 20% (AC120V/60Hz)	<input checked="" type="checkbox"/>
	<b>Mode 2:</b> 1000Mbps 20%(AC240V/50Hz)	<input checked="" type="checkbox"/>
Radiated Emission	<b>Mode 1:</b> Continuously Transmitting	<input checked="" type="checkbox"/>

After verification, all tests were carried out with the worst case test modes as shown below except radiated spurious emission below 1GHz, which worst case was in normal link mode only, and power line conducted emission below 30MHz, which worst case was in normal link mode.

IEEE802.11b mode: Channel Low (2412MHz), Channel Mid (2437MHz) and Channel High (2462MHz) with 1Mbps data rate were chosen for full testing.

IEEE802.11g mode: Channel Low (2412MHz), Channel Mid (2437MHz) and Channel High (2462MHz) with 6Mbps data rate were chosen for full testing.

IEEE 802.11n HT20 MHz mode: Channel Low (2412MHz), Channel Mid (2437MHz) and Channel High (2462MHz) with 13Mbps data rate were chosen for full testing.

IEEE 802.11n HT40 MHz mode: Channel Low (2422MHz), Channel Mid (2437MHz) and Channel High (2452MHz) with 27Mbps data rate were chosen for full testing.



## 5 SETUP OF EQUIPMENT UNDER TEST

### 5.1. DESCRIPTION OF SUPPORT UNITS

The EUT has been tested as an independent unit together with other necessary accessories or support units. The following support units or accessories were used to form a representative test configuration during the tests.

No.	Equipment	Model No.	Serial No.	FCC ID	Brand	Data Cable	Power Cord
1	Notebook 1#	Thinkpad	N/A	DoC	LENOVO	Unshielded 8.00m (RJ45 Cable)	Unshielded 1.80m (AC Cable) Shielded 1.70m (DC Cable)
2	Notebook 2#	Z8B	NXVAECN01145 1058AE7600	DoC	Acer	Unshielded 8.00m (RJ45 Cable)	Unshielded 1.80m (AC Cable) Unshielded 1.50m (DC Cable)
3	HDD	33015	WDBACY3201A BK-PESN	DoC	WD	Unshielded 0.50m (USB Cable)	N/A
4	Phone	N/A	N/A	DoC	CHINO	Unshielded 1.20m (RJ11 Cable)	N/A

**Note:**

Grounding was established in accordance with the manufacturer's requirements and conditions for the intended use.

### 5.2. CONFIGURATION OF SYSTEM UNDER TEST

See test photographs attached in Appendix II for the actual connections between EUT and support equipment.





## 6 FACILITIES AND ACCREDITATIONS

### 6.1. FACILITIES

All measurement facilities used to collect the measurement data are located at **No.10-1 Mingkeda Logistics park, No.18, Huanguan South Rd., Guan Lan Town, Baoan District, Shenzhen, China**

The sites are constructed in conformance with the requirements of ANSI C63.10, ANSI C63.7 and CISPR Publication 22. All receiving equipment conforms to CISPR Publication 16-1, "Radio Interference Measuring Apparatus and Measurement Methods."

### 6.2. ACCREDITATIONS

Our laboratories are accredited and approved by the following accreditation body according to ISO/IEC 17025.

<b>USA</b>	<b>A2LA</b>
<b>China</b>	<b>CNAS</b>

The measuring facility of laboratories has been authorized or registered by the following approval agencies.

<b>USA</b>	<b>FCC</b>
<b>Japan</b>	<b>VCCI (C-4815,R-4320,T-2317, G-10624)</b>
<b>Canada</b>	<b>INDUSTRY CANADA</b>

Copies of granted accreditation certificates are available for downloading from our web site, <http://www.ccssz.com>

### 6.3. MEASUREMENT UNCERTAINTY

Where relevant, the following measurement uncertainty levels have been estimated for tests performed on the EUT as specified in CISPR 16-4-2:

Parameter	Uncertainty
Radiated Emission, 30 to 200 MHz Test Site : 966(2)	+/-3.6880dB
Radiated Emission, 200 to 1000 MHz Test Site : 966(2)	+/-3.6695dB
Radiated Emission, 1 to 8 GHz	+/-5.1782dB
Radiated Emission, 8 to 18 GHz	+/-5.2173dB
Conducted Emissions	+/-3.6836dB
Band Width	178kHz
Peak Output Power MU	+/-1.906dB
Band Edge MU	+/-0.182dB
Channel Separation MU	416.178Hz
Duty Cycle MU	0.054ms
Frequency Stability MU	226Hz

This uncertainty represents an expanded uncertainty expressed at approximately the 95% confidence level using a coverage factor of k=2.

The measured result is above (below) the specification limit by a margin less than the measurement uncertainty; it is therefore not possible to state compliance based on the 95% level of confidence. However, the result indicates that compliance (non-compliance) is more probable than non-compliance) with the specification limit.



## 7 FCC PART 15.247 REQUIREMENTS

### 7.1. POWER LINE CONDUCTED EMISSIONS MEASUREMENT

#### 7.1.1. LIMITS OF CONDUCTED EMISSIONS MEASUREMENT

According to §15.207(a), except as shown in paragraphs (b) and (c) of this section, for an intentional radiator that is designed to be connected to the public utility (AC) power line, the radio frequency voltage that is conducted back onto the AC power line on any frequency or frequencies within the band 150 kHz to 30 MHz shall not exceed the limits in the following table, as measured using a 50  $\mu$ H/50 ohms line impedance stabilization network (LISN). Compliance with the provisions of this paragraph shall be based on the measurement of the radio frequency voltage between each power line and ground at the power terminal. The lower limit applies at the boundary between the frequency ranges.

Frequency Range (MHz)	Limits (dB $\mu$ V)	
	Quasi-peak	Average
0.15 to 0.50	66 to 56*	56 to 46*
0.50 to 5	56	46
5 to 30	60	50

**NOTE:**

- (1) The lower limit shall apply at the transition frequencies.
- (2) The limit decreases in line with the logarithm of the frequency in the range of 0.15 to 0.50 MHz.
- (3) All emanations from a class A/B digital device or system, including any network of conductors and apparatus connected thereto, shall not exceed the level of field strengths specified above.

#### 7.1.2. TEST INSTRUMENTS

Conducted Emission Test Site					
Name of Equipment	Manufacturer	Model Number	Serial Number	Last Calibration	Due Calibration
EMI TEST RECEIVER	ROHDE&SCHWARZ	ESCI	100783	02/21/2017	02/20/2018
LISN(EUT)	ROHDE&SCHWARZ	ENV216	101543-WX	02/21/2017	02/20/2018
LISN	EMCO	3825/2	8901-1459	02/21/2017	02/20/2018
Temp. / Humidity Meter	VICTOR	HTC-1	N/A	02/21/2017	02/20/2018
Test S/W	FARAD	EZ-EMC/ CCS-3A1-CE			

- NOTE:** 1. The calibration interval of the above test instruments is 12 months and the calibrations are traceable to NML/ROC and NIST/USA.  
2. N.C.R = No Calibration Request.



### 7.1.3. TEST PROCEDURES (please refer to measurement standard)

- The EUT and Support equipment, if needed, was placed on a non-conducted table, which is 0.8m above the ground plane and 0.4m away from the conducted wall.
- The test equipment EUT installed received AC main power, through a Line Impedance Stabilization Network (LISN), which supplied power source and was grounded to the ground plane. All support equipment power received from a second LISN. The two LISNs provide 50 ohm/ 50uH of coupling impedance for the measuring instrument.
- The EUT test program was started. Emissions were measured on each current carrying line of the EUT using an EMI Test Receiver connected to the LISN powering the EUT.
- The frequency range from 150 kHz to 30 MHz was searched. The test data of the worst-case condition(s) was recorded. Emission levels under limit 20dB were not recorded.



### 7.1.4. TEST SETUP

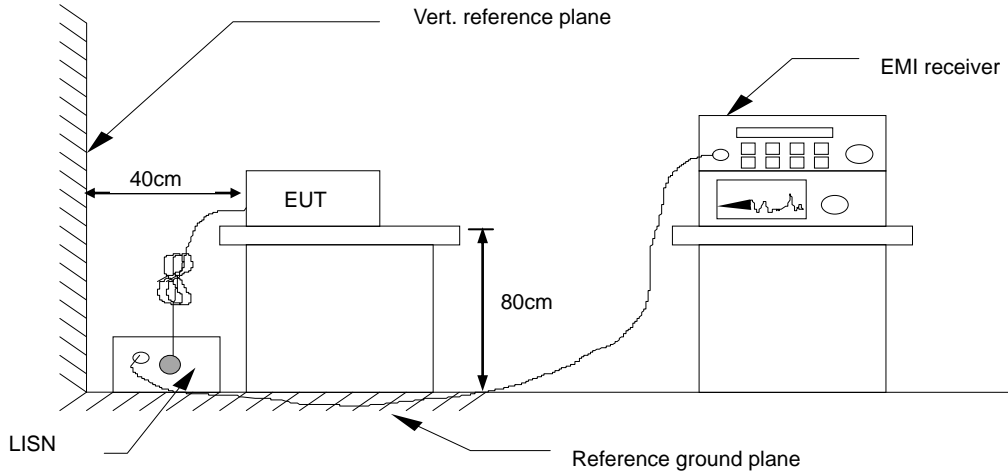

For the actual test configuration, please refer to the related item - Photographs of the Test Configuration.

### 7.1.5. DATA SAMPLE

Frequency (MHz)	QuasiPeak Reading (dBuV)	Average Reading (dBuV)	Correction Factor (dB)	QuasiPeak Result (dBuV)	Average Result (dBuV)	QuasiPeak Limit (dBuV)	Average Limit (dBuV)	QuasiPeak Margin (dB)	Average Margin (dB)	Remark (Pass/Fail)
XXX.XXXX	32.69	25.65	11.52	44.21	37.17	65.78	55.79	-21.57	-18.62	Pass

- Factor = Insertion loss of LISN + Cable Loss
- Result = Quasi-peak Reading/ Average Reading + Factor
- Limit = Limit stated in standard
- Margin = Result (dBuV) – Limit (dBuV)



7.1.6. TEST RESULTS

<b>Model No.</b>	MD1600XY	<b>RBW,VBW</b>	9 kHz
<b>Environmental Conditions</b>	22°C, 45% RH	<b>Test Mode</b>	Mode 1
<b>Tested by</b>	Mimi Qiu	<b>Line</b>	L1
<b>Test Date</b>	August 25, 2017	<b>Test Voltage</b>	AC120V/60Hz

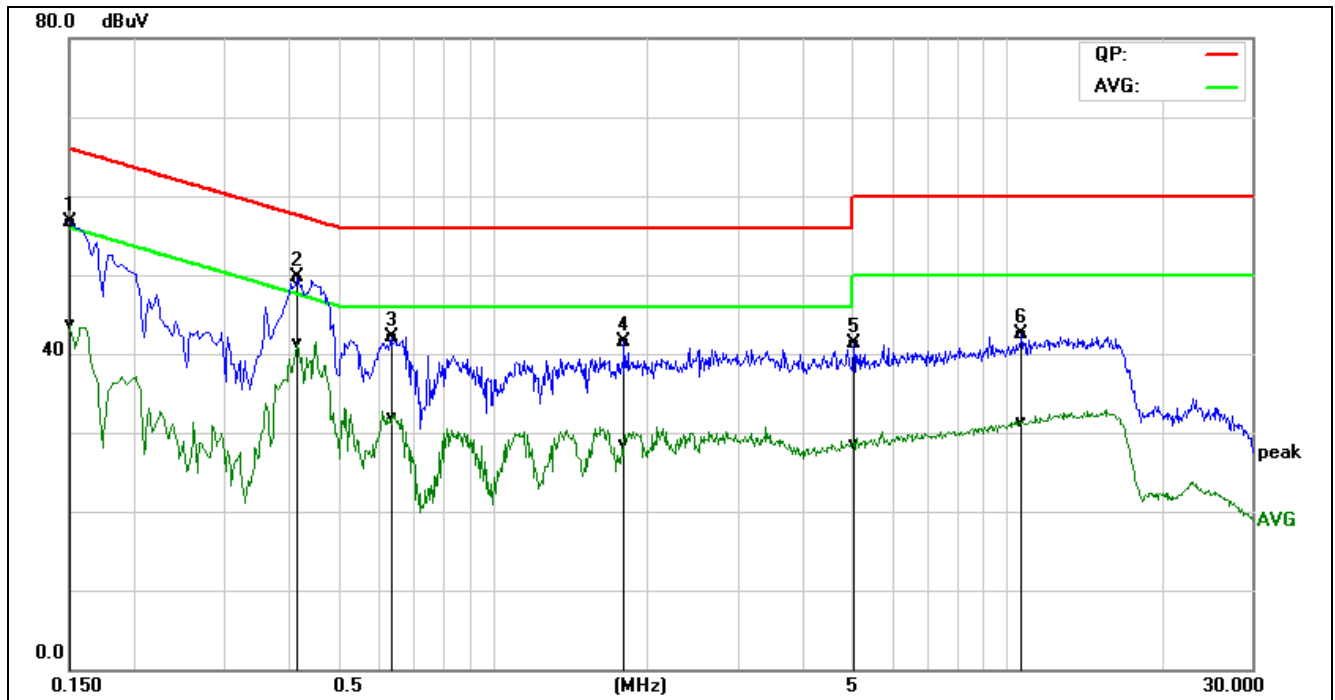

Frequency (MHz)	QuasiPeak Reading (dBuV)	Average Reading (dBuV)	Correction Factor (dB)	QuasiPeak Result (dBuV)	Average Result (dBuV)	QuasiPeak Limit (dBuV)	Average Limit (dBuV)	QuasiPeak Margin (dB)	Average Margin (dB)	Remark (Pass/Fail)	Line (L1/L2)
0.1516	37.13	23.99	19.62	56.75	43.61	65.91	55.91	-9.16	-12.30	Pass	L1
0.4180	30.04	21.74	19.56	49.60	41.30	57.49	47.49	-7.89	-6.19	Pass	L1
0.6340	22.54	12.33	19.58	42.12	31.91	56.00	46.00	-13.88	-14.09	Pass	L1
1.8060	21.76	8.75	19.69	41.45	28.44	56.00	46.00	-14.55	-17.56	Pass	L1
5.0500	21.66	8.87	19.73	41.39	28.60	60.00	50.00	-18.61	-21.40	Pass	L1
10.6980	22.30	11.16	20.13	42.43	31.29	60.00	50.00	-17.57	-18.71	Pass	L1

REMARKS: L1 = Line One (Live Line)



<b>Model No.</b>	MD1600XY	<b>RBW,VBW</b>	9 kHz
<b>Environmental Conditions</b>	22°C, 45% RH	<b>Test Mode</b>	Mode 1
<b>Tested by</b>	Mimi Qiu	<b>Line</b>	L2
<b>Test Date</b>	August 25, 2017	<b>Test Voltage</b>	AC120V/60Hz

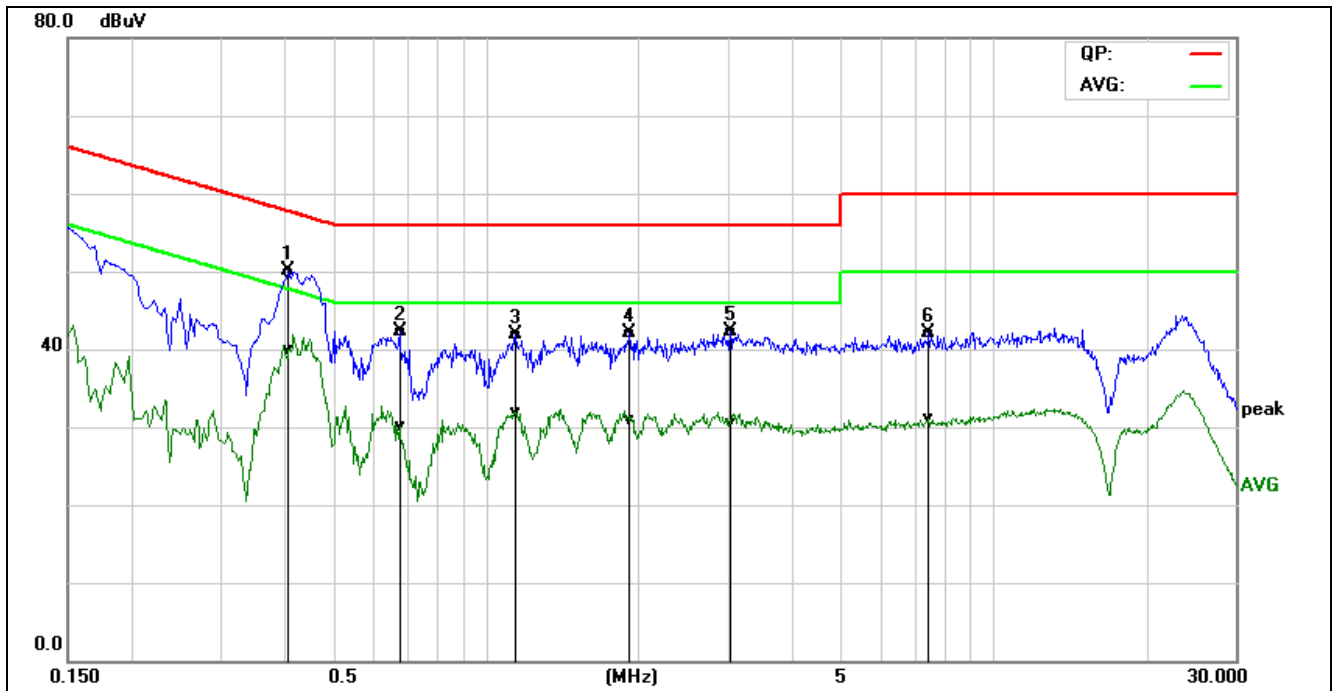

Frequency (MHz)	QuasiPeak Reading (dBuV)	Average Reading (dBuV)	Correction Factor (dB)	QuasiPeak Result (dBuV)	Average Result (dBuV)	QuasiPeak Limit (dBuV)	Average Limit (dBuV)	QuasiPeak Margin (dB)	Average Margin (dB)	Remark (Pass/Fail)	Line (L1/L2)
0.4100	30.47	20.38	19.53	50.00	39.91	57.65	47.65	-7.65	-7.74	Pass	L2
0.6780	22.69	10.49	19.60	42.29	30.09	56.00	46.00	-13.71	-15.91	Pass	L2
1.1460	22.34	12.33	19.57	41.91	31.90	56.00	46.00	-14.09	-14.10	Pass	L2
1.9220	22.35	11.15	19.70	42.05	30.85	56.00	46.00	-13.95	-15.15	Pass	L2
3.0300	22.55	10.77	19.75	42.30	30.52	56.00	46.00	-13.70	-15.48	Pass	L2
7.4540	22.23	11.15	19.88	42.11	31.03	60.00	50.00	-17.89	-18.97	Pass	L2

**REMARKS:** L2 = Line Two (Neutral Line)



<b>Model No.</b>	MD1600XY	<b>RBW,VBW</b>	9 kHz
<b>Environmental Conditions</b>	22°C, 45% RH	<b>Test Mode</b>	Mode 2
<b>Tested by</b>	Darry Wu	<b>Line</b>	L1
<b>Test Date</b>	August 25, 2017	<b>Test Voltage</b>	AC240V/50Hz

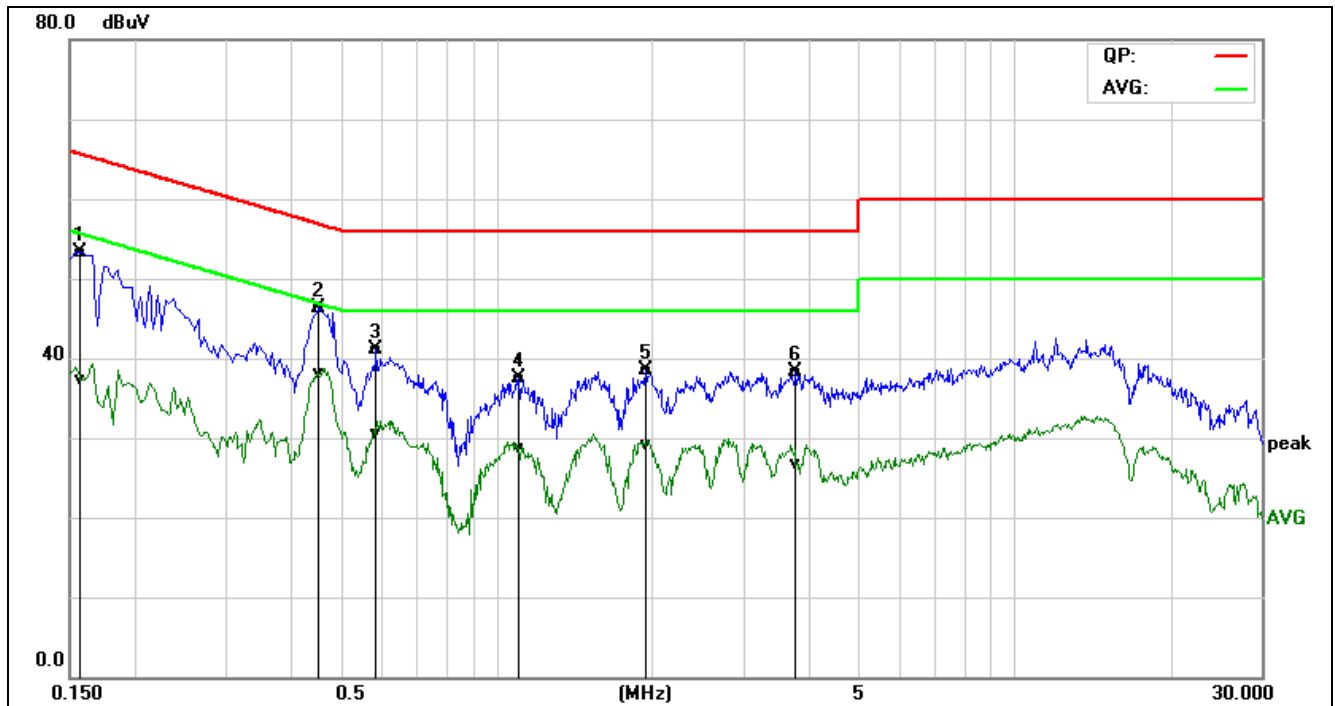

Frequency (MHz)	QuasiPeak Reading (dBuV)	Average Reading (dBuV)	Correction Factor (dB)	QuasiPeak Result (dBuV)	Average Result (dBuV)	QuasiPeak Limit (dBuV)	Average Limit (dBuV)	QuasiPeak Margin (dB)	Average Margin (dB)	Remark (Pass/Fail)	Line (L1/L2)
0.1580	33.77	17.68	19.62	53.39	37.30	65.56	55.57	-12.17	-18.27	Pass	L1
0.4540	26.80	18.55	19.55	46.35	38.10	56.80	46.80	-10.45	-8.70	Pass	L1
0.5860	21.58	11.01	19.56	41.14	30.57	56.00	46.00	-14.86	-15.43	Pass	L1
1.1060	17.98	9.06	19.57	37.55	28.63	56.00	46.00	-18.45	-17.37	Pass	L1
1.9460	18.70	9.33	19.71	38.41	29.04	56.00	46.00	-17.59	-16.96	Pass	L1
3.7940	18.58	6.98	19.73	38.31	26.71	56.00	46.00	-17.69	-19.29	Pass	L1

REMARKS: L1 = Line One (Live Line)



<b>Model No.</b>	MD1600XY	<b>RBW,VBW</b>	9 kHz
<b>Environmental Conditions</b>	22°C, 45% RH	<b>Test Mode</b>	Mode 2
<b>Tested by</b>	Darry Wu	<b>Line</b>	L2
<b>Test Date</b>	August 25, 2017	<b>Test Voltage</b>	AC240V/50Hz

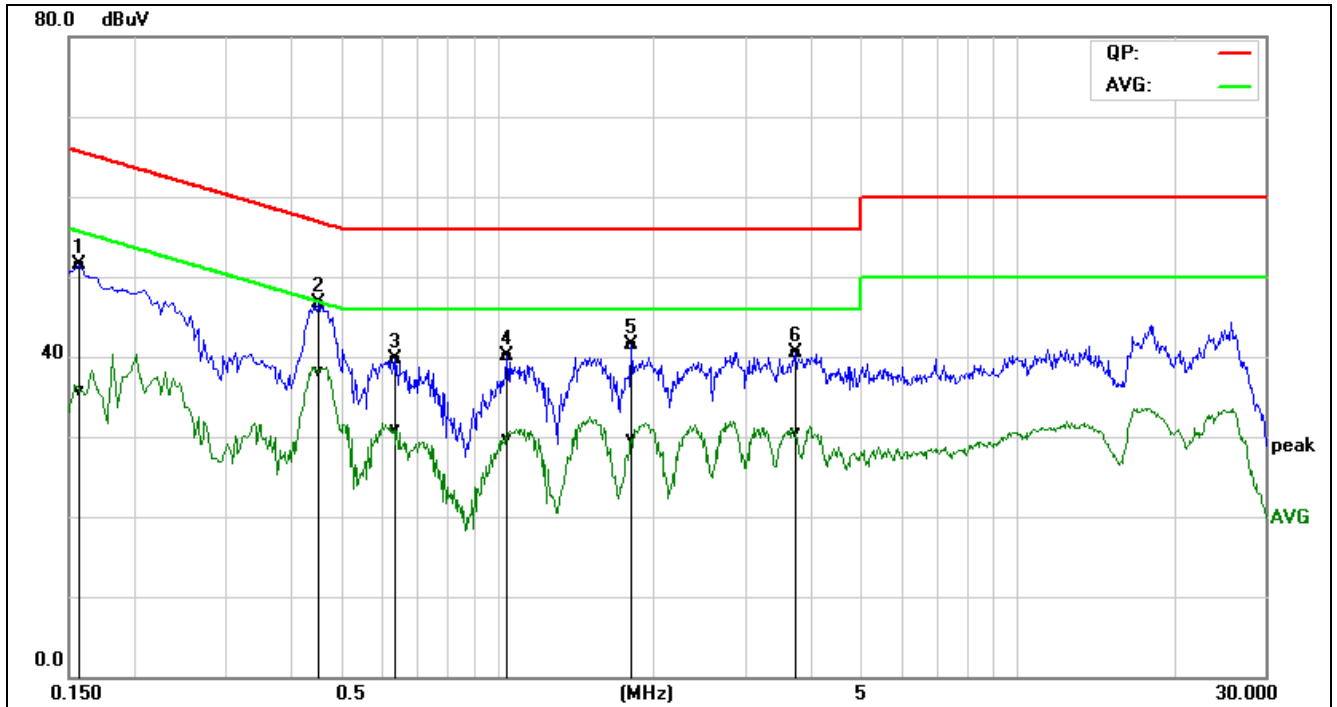

Frequency (MHz)	QuasiPeak Reading (dBuV)	Average Reading (dBuV)	Correction Factor (dB)	QuasiPeak Result (dBuV)	Average Result (dBuV)	QuasiPeak Limit (dBuV)	Average Limit (dBuV)	QuasiPeak Margin (dB)	Average Margin (dB)	Remark (Pass/Fail)	Line (L1/L2)
0.1580	32.03	16.21	19.52	51.55	35.73	65.56	55.57	-14.01	-19.84	Pass	L2
0.4540	27.09	18.65	19.53	46.62	38.18	56.80	46.80	-10.18	-8.62	Pass	L2
0.6340	20.09	11.25	19.58	39.67	30.83	56.00	46.00	-16.33	-15.17	Pass	L2
1.0460	20.49	10.23	19.55	40.04	29.78	56.00	46.00	-15.96	-16.22	Pass	L2
1.8100	21.72	10.05	19.69	41.41	29.74	56.00	46.00	-14.59	-16.26	Pass	L2
3.7460	20.78	10.75	19.79	40.57	30.54	56.00	46.00	-15.43	-15.46	Pass	L2

**REMARKS:** L2 = Line Two (Neutral Line)





## 7.2. SPURIOUS EMISSIONS MEASUREMENT

### 7.2.1. CONDUCTED EMISSIONS MEASUREMENT

#### 7.2.1.1. LIMITS OF CONDUCTED EMISSIONS MEASUREMENT

§15.247(d) specifies that in any 100 kHz bandwidth outside of the authorized frequency band, the power shall be attenuated according to the following conditions:

If the peak output power procedure is used to measure the fundamental emission power to demonstrate compliance to 15.247(b)(3) requirements, then the peak conducted output power measured within any 100 kHz outside the authorized frequency band shall be attenuated by at least 20 dB relative to the maximum measured in-band peak PSD level.

If the average output power procedure is used to measure the fundamental emission power to demonstrate compliance to 15.247(b) (3) requirements, then the power in any 100 kHz outside of the authorized frequency band shall be attenuated by at least 30 dB relative to the maximum measured in-band average PSD level.

In addition, radiated emissions which fall in the restricted bands, as defined in §15.205(a), must also comply with the radiated emission limits specified in 15.209(a) (see Section 15.205(c)).

#### 7.2.1.2. TEST INSTRUMENTS

Name of Equipment	Manufacturer	Model	Serial Number	Last Calibration	Due Calibration
Spectrum Analyzer	Agilent	N9010A	MY55370330	02/21/2017	02/20/2018

#### 7.2.1.3. TEST PROCEDURE (please refer to measurement standard)

Conducted RF measurements of the transmitter output were made to confirm that the EUT antenna port conducted emissions meet the specified limit and to identify any spurious signals that require further investigation or measurements on the radiated emissions site.

The transmitter output is connected to the spectrum analyzer. The resolution bandwidth is set to 100 kHz. The video bandwidth is set to 300 kHz.

Measurements are made over the 9 kHz to 26GHz range with the transmitter set to the lowest, middle, and highest channels. No emission found between lowest internal used/generated frequency to 10MHz, it is only recorded 10MHz to 26GHz.



7.2.1.4. TEST RESULTS

Test Plot

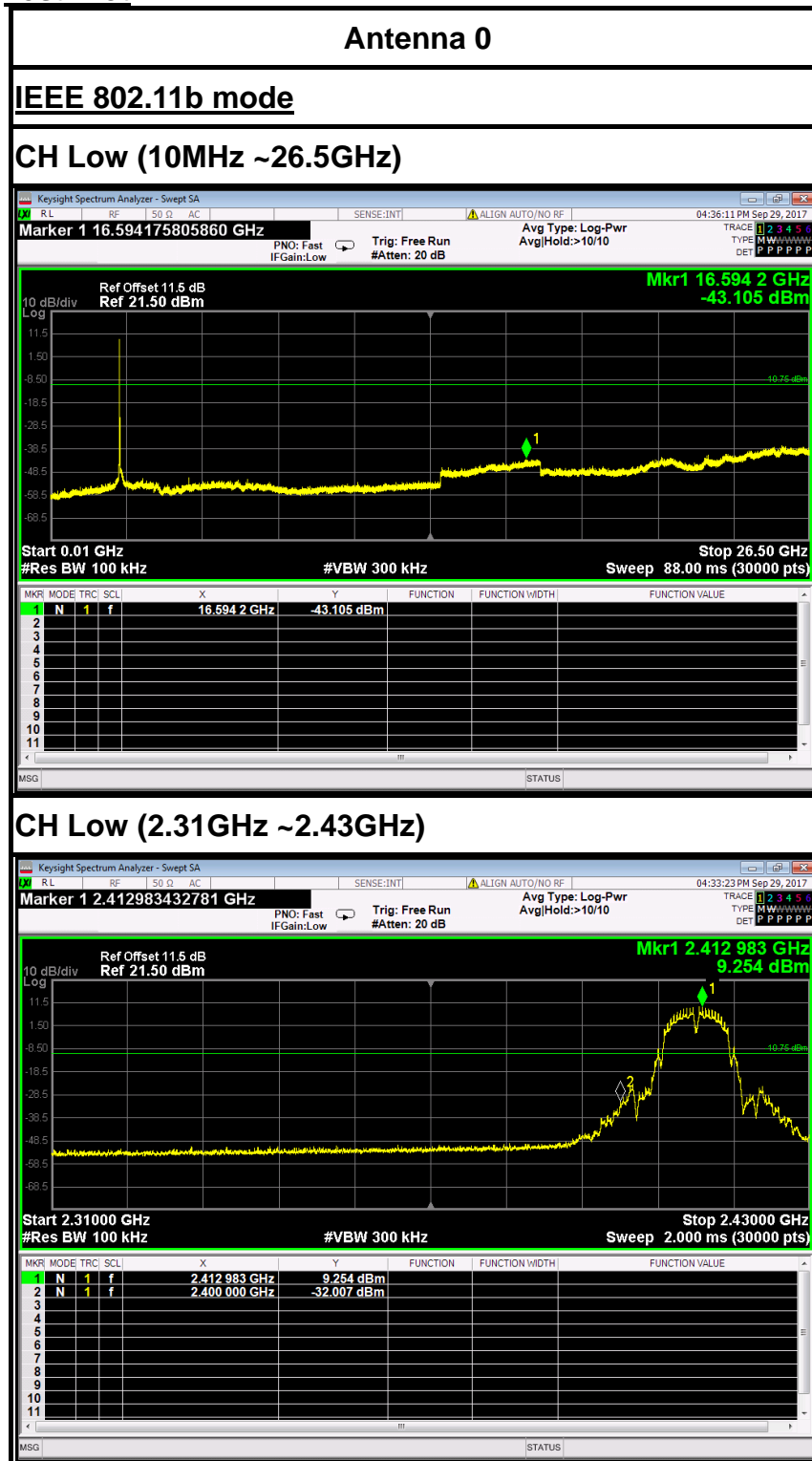

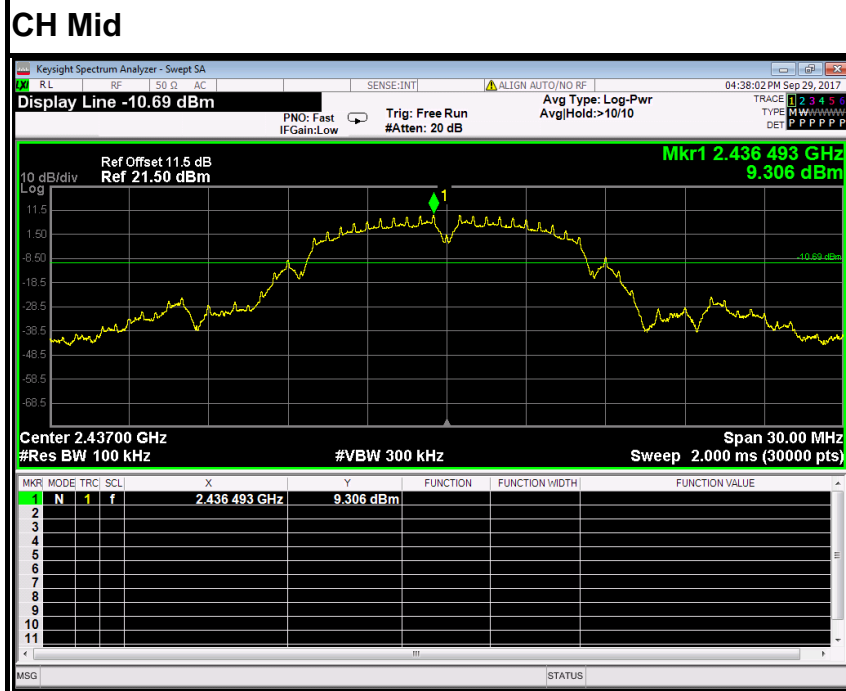
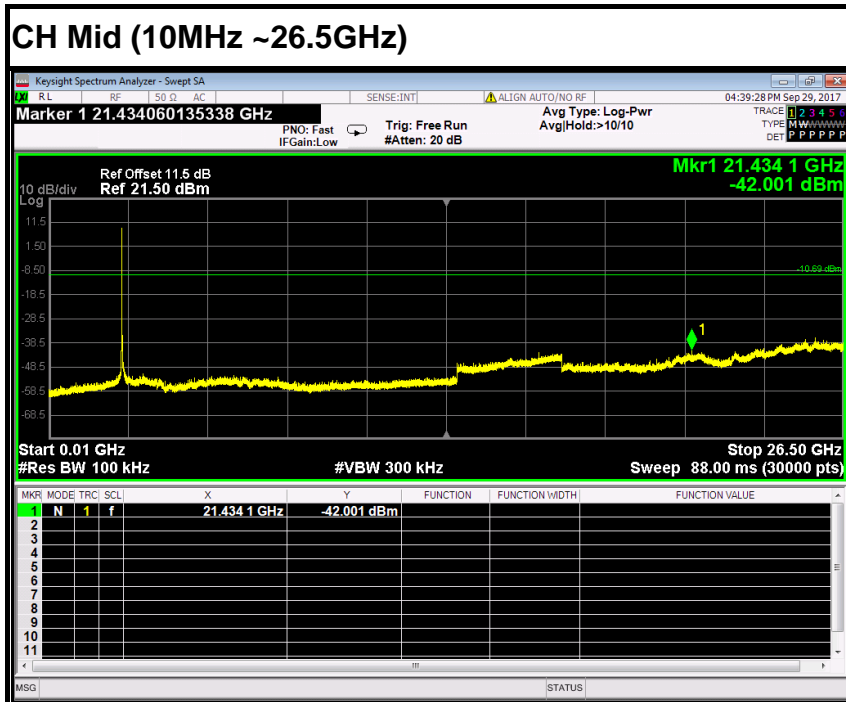

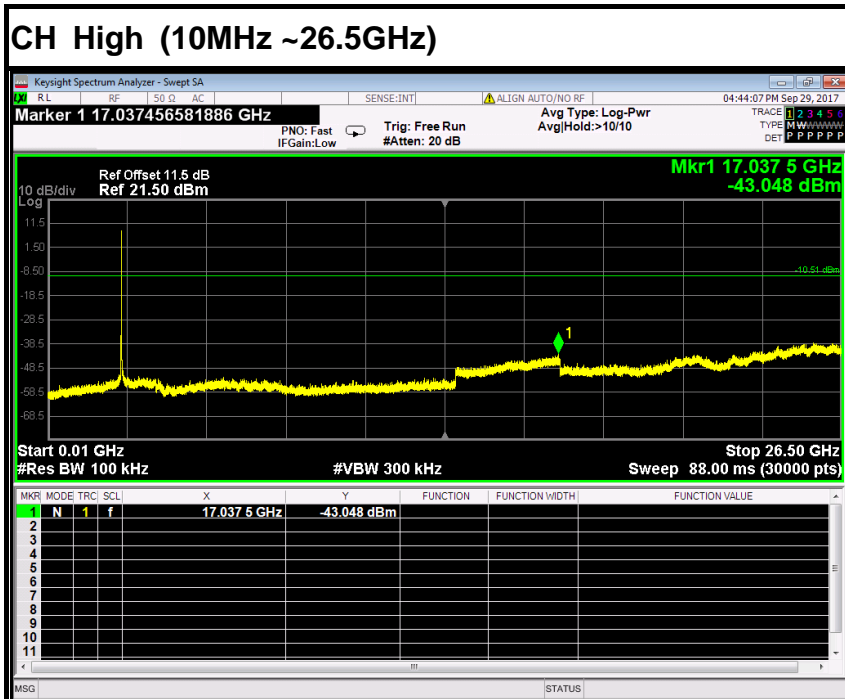

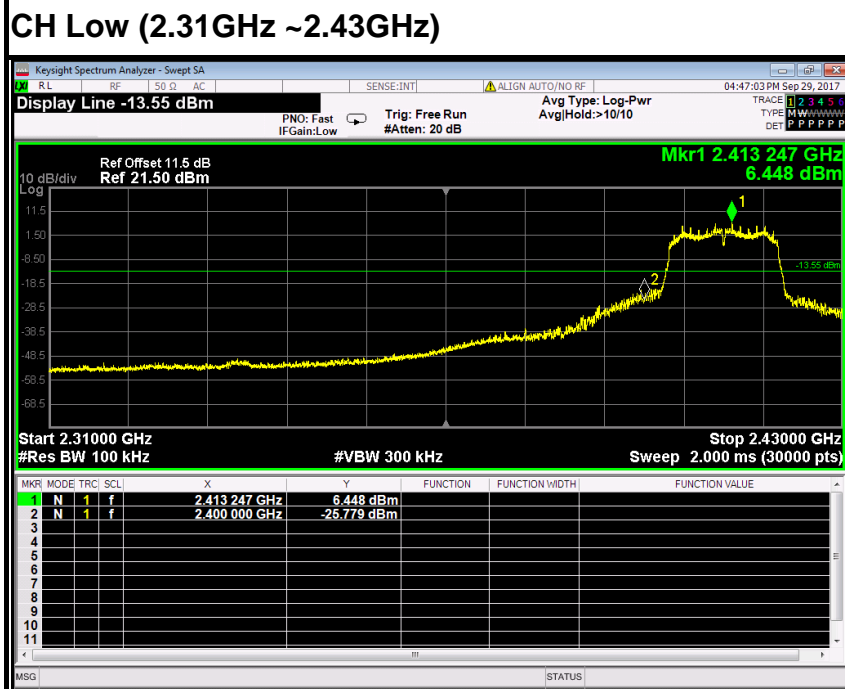
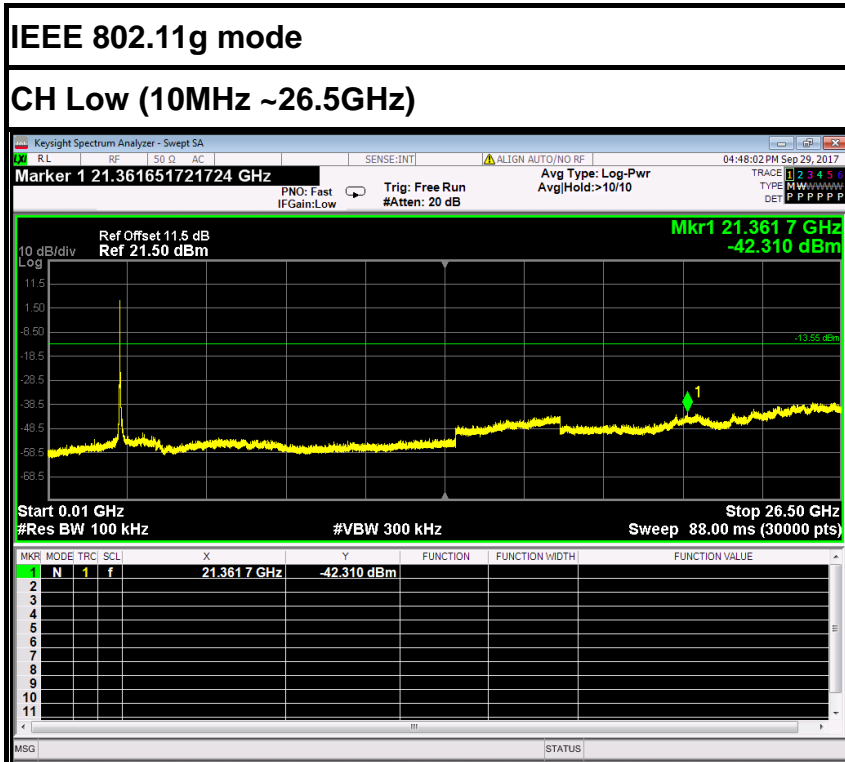

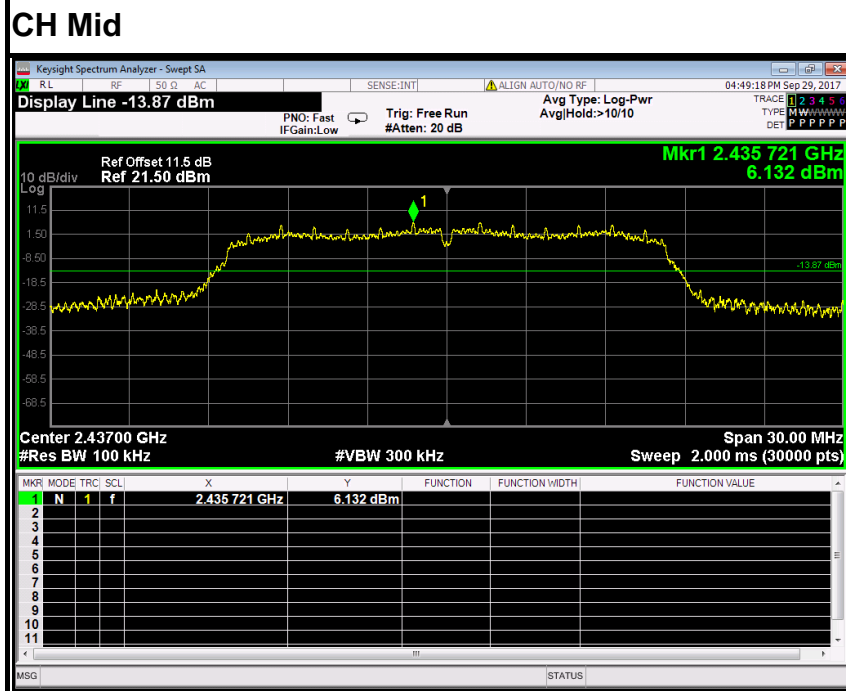
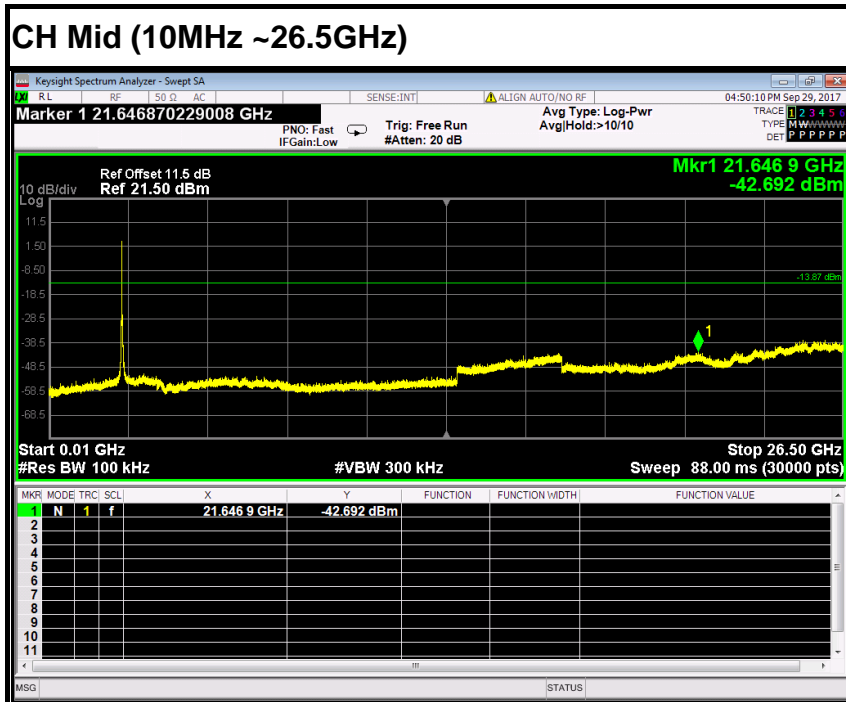

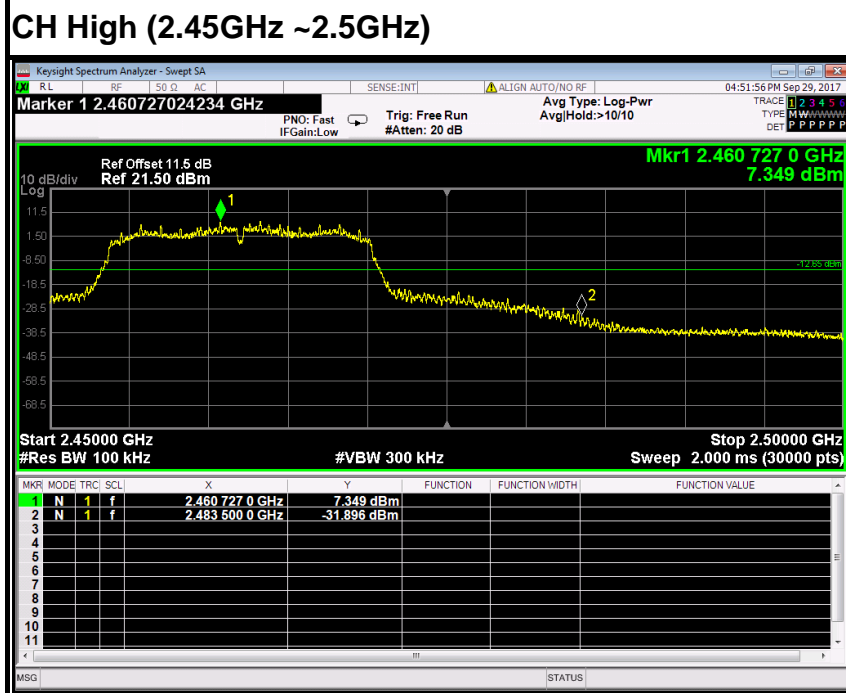
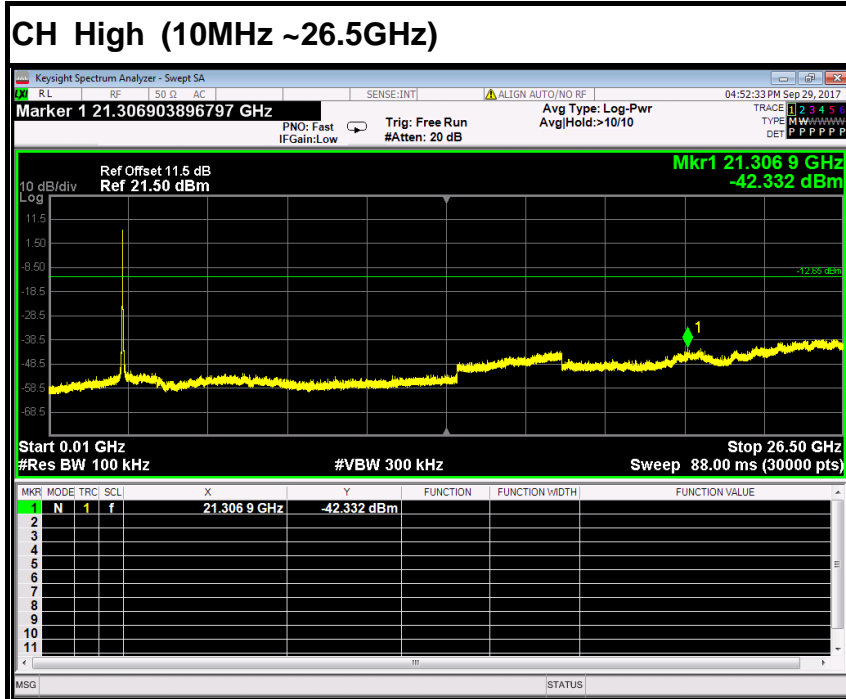

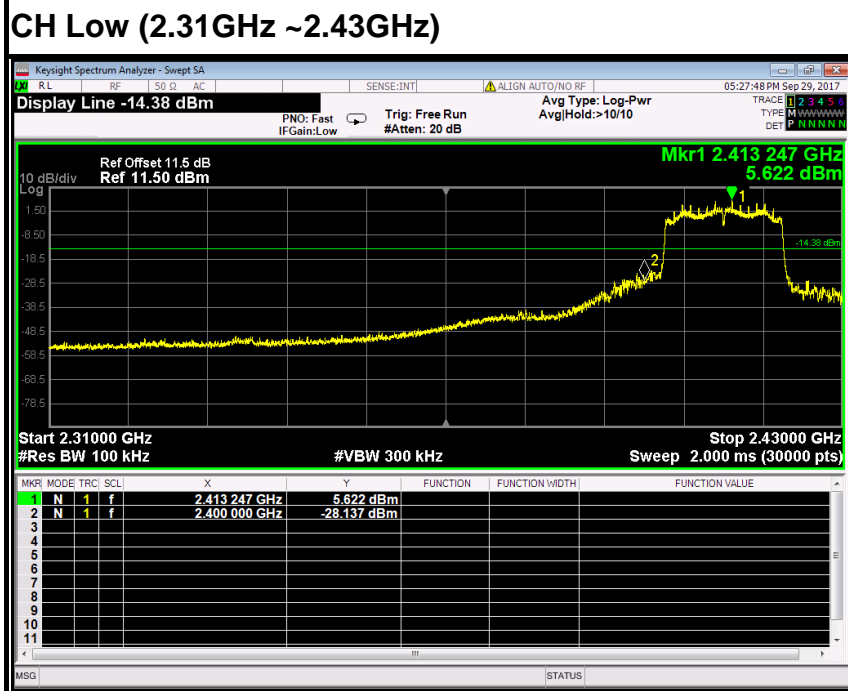
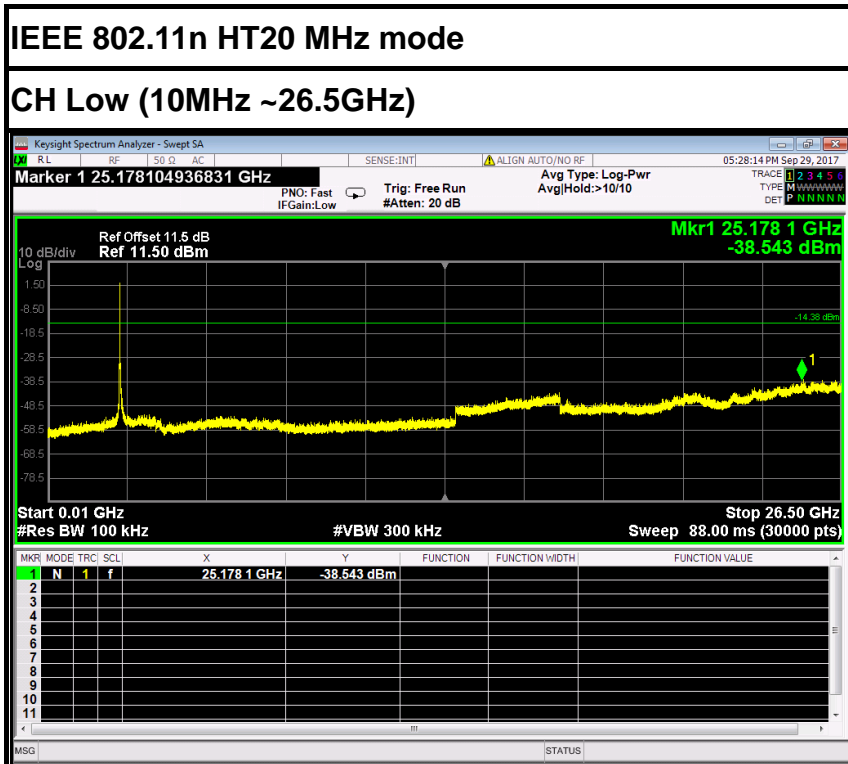



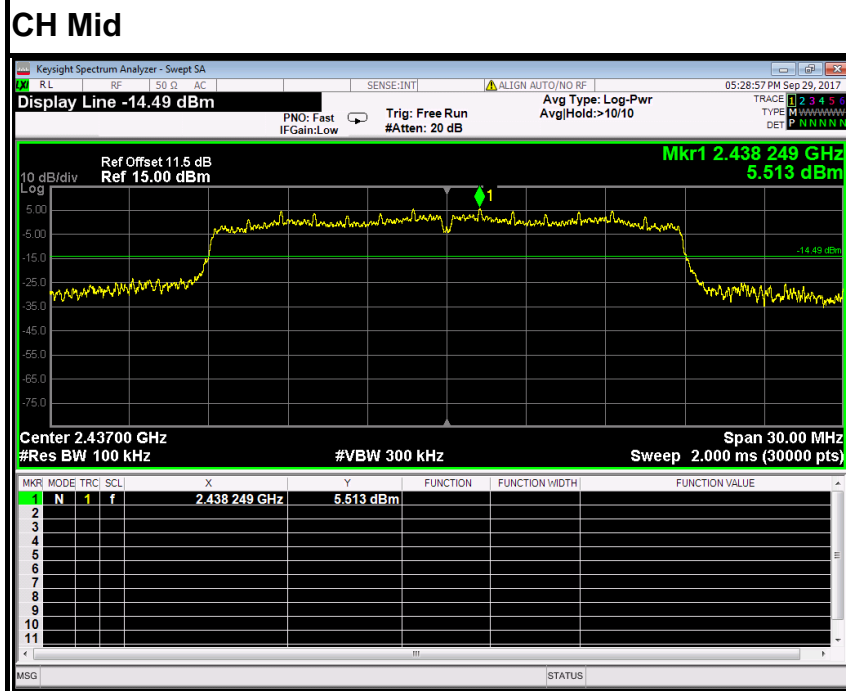
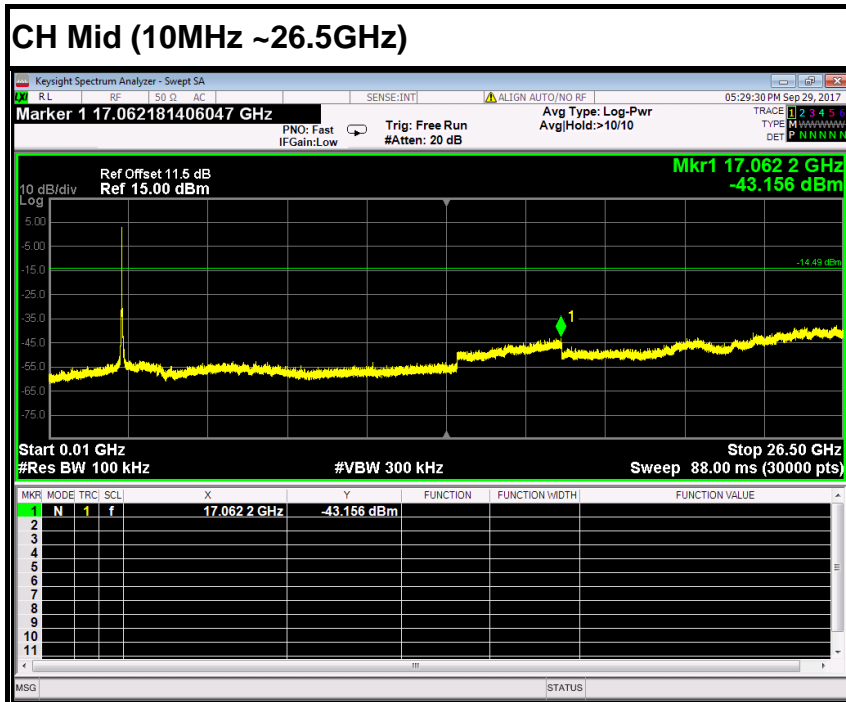

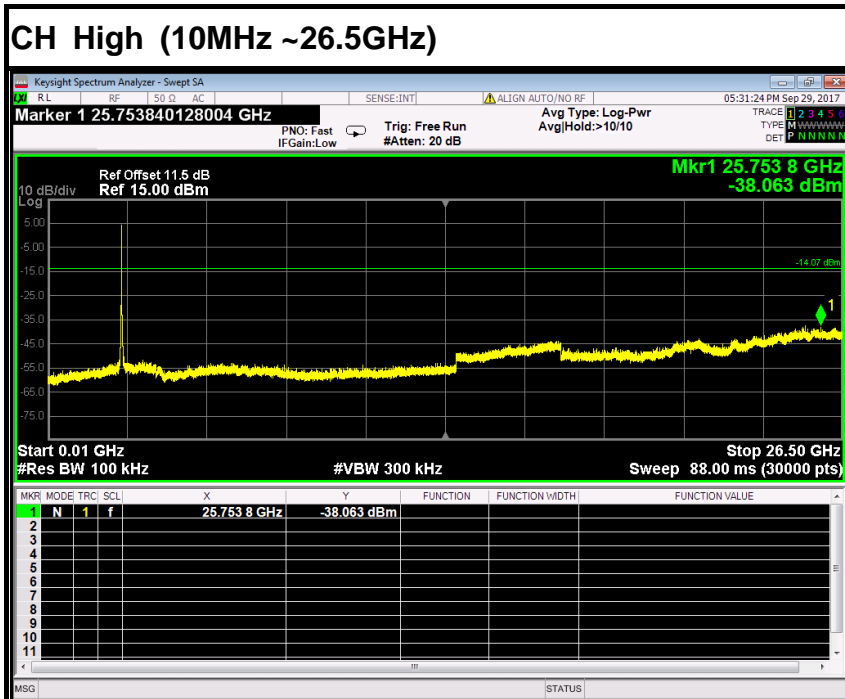

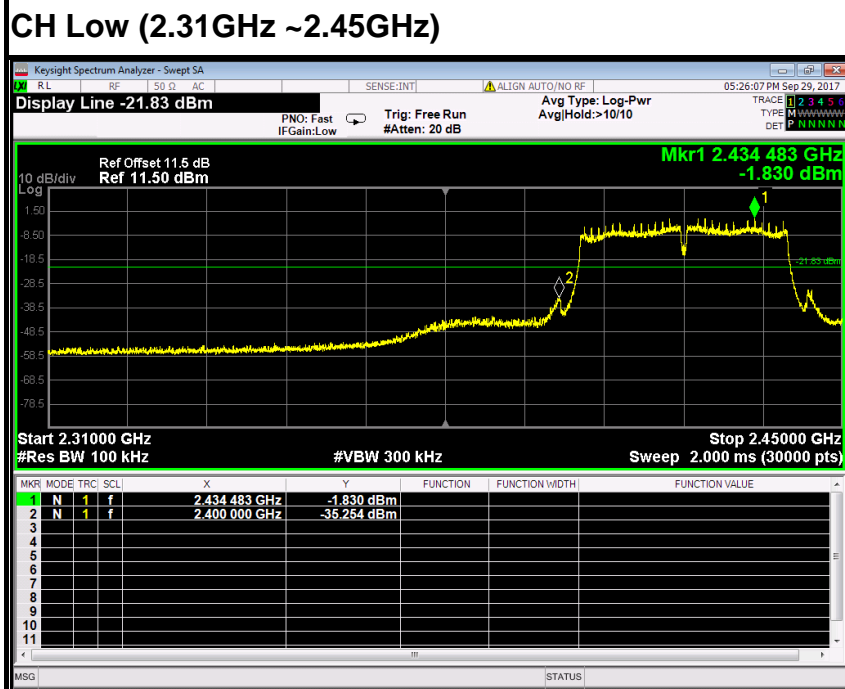
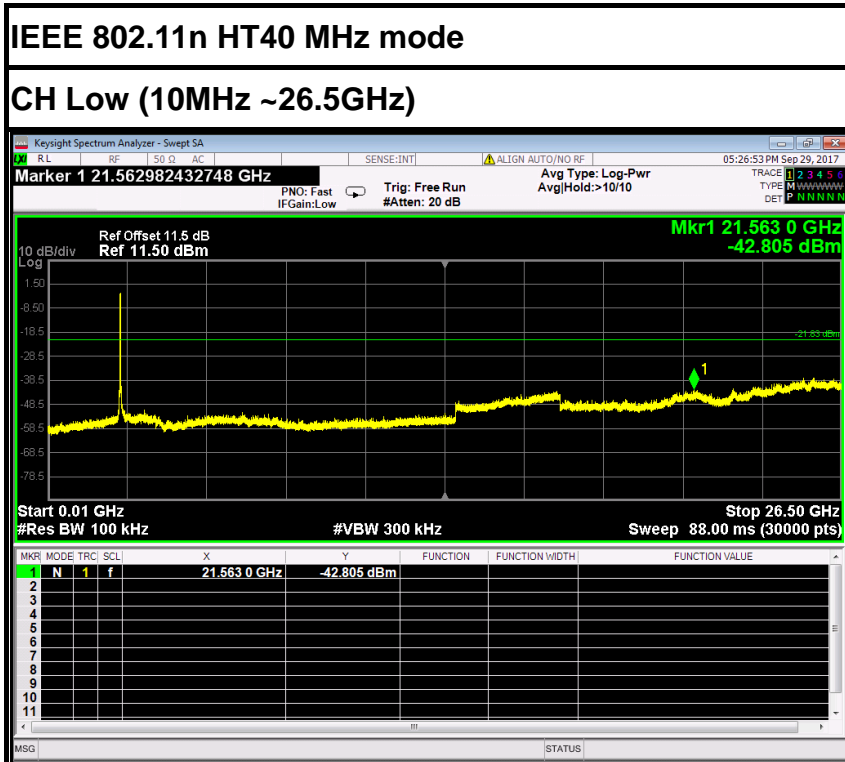

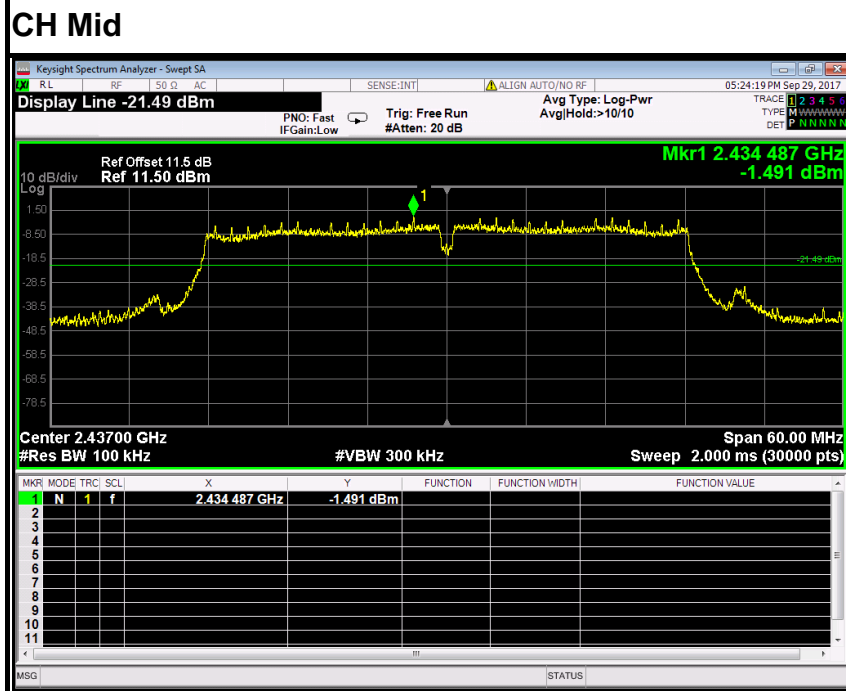
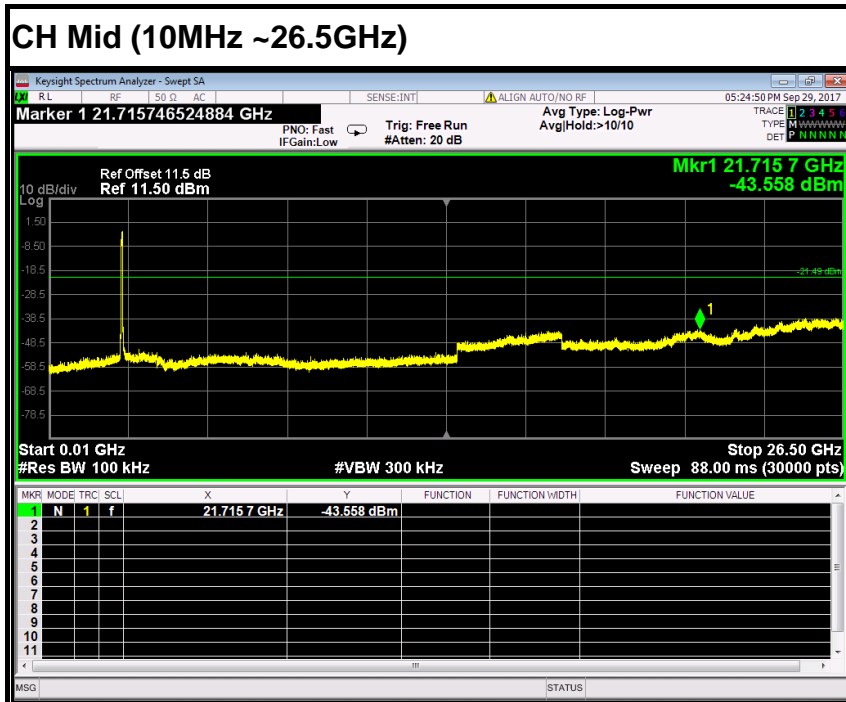

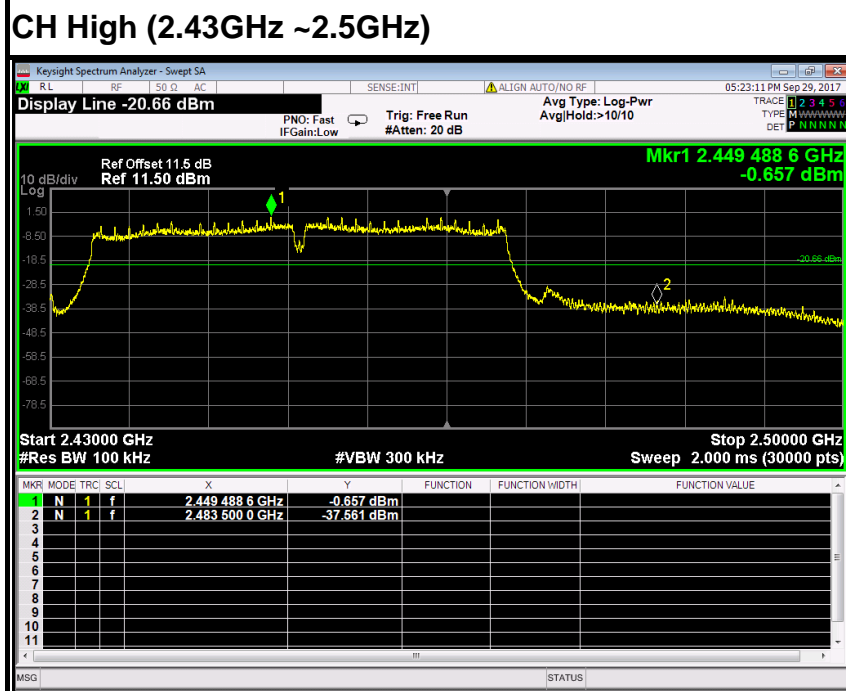
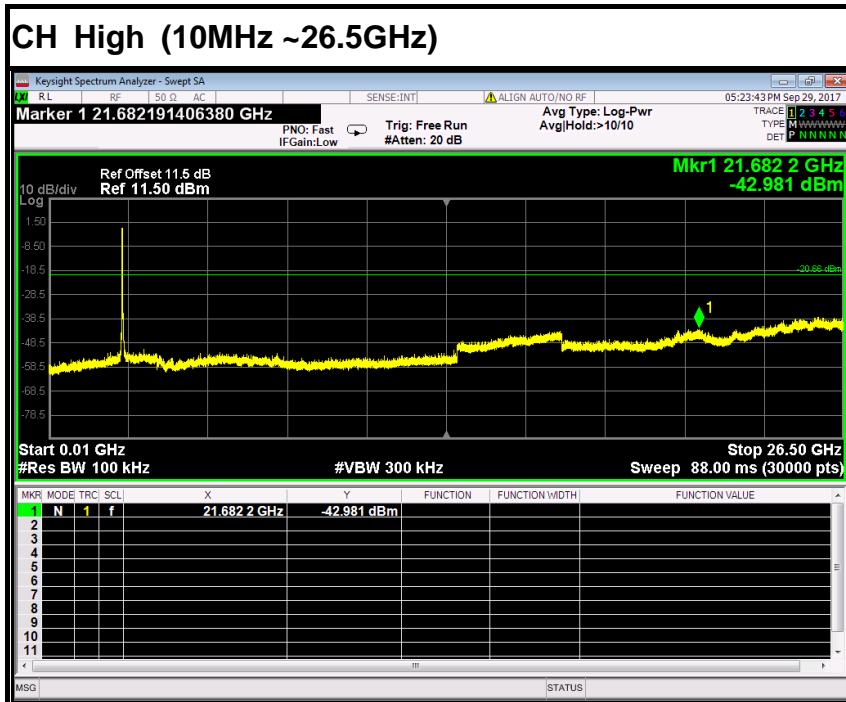

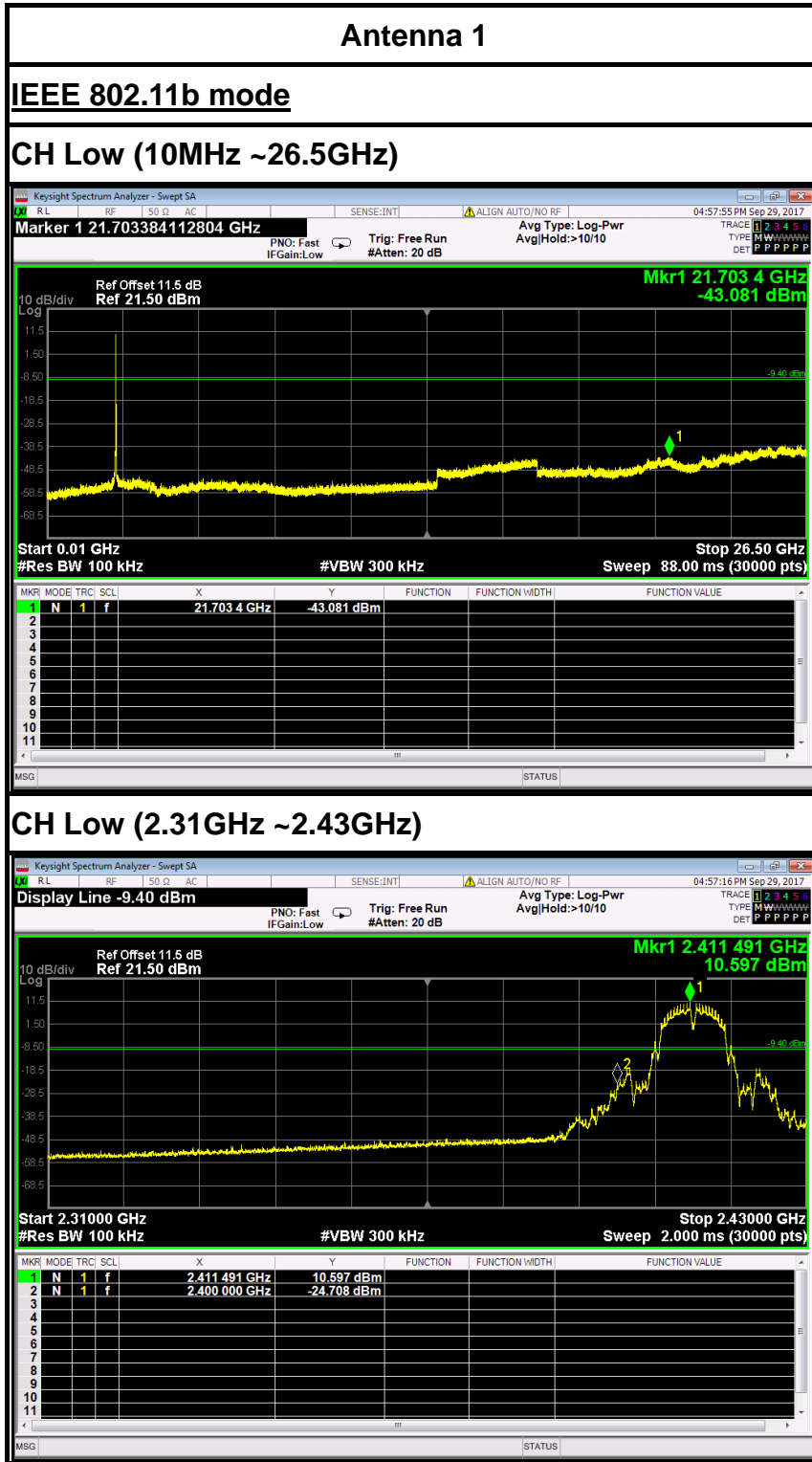

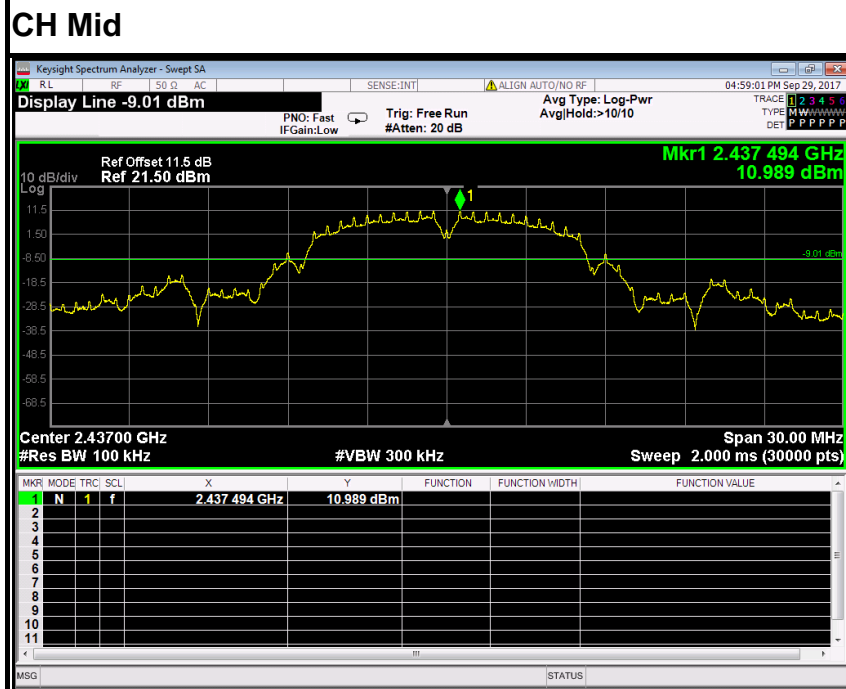
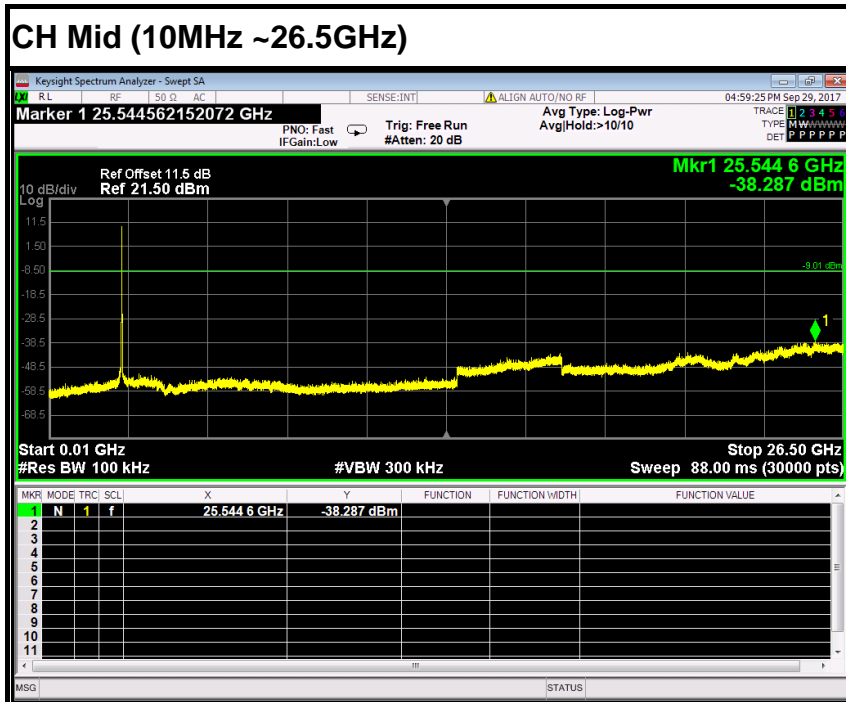

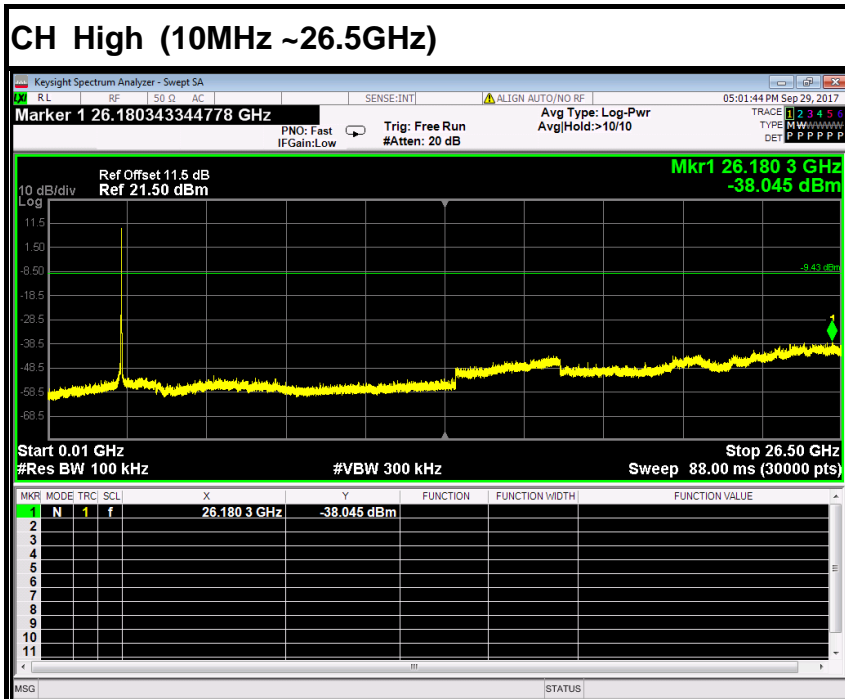



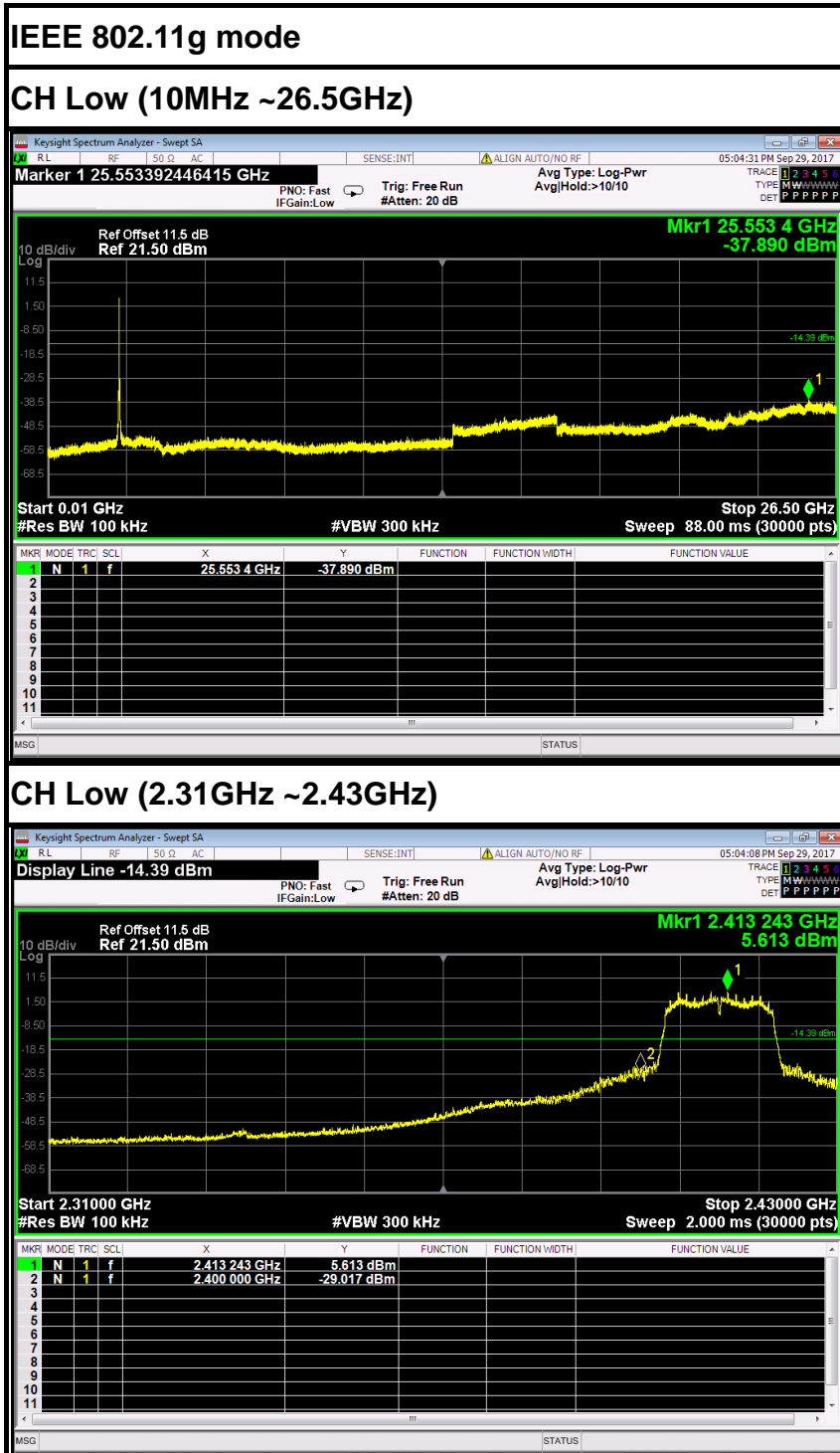

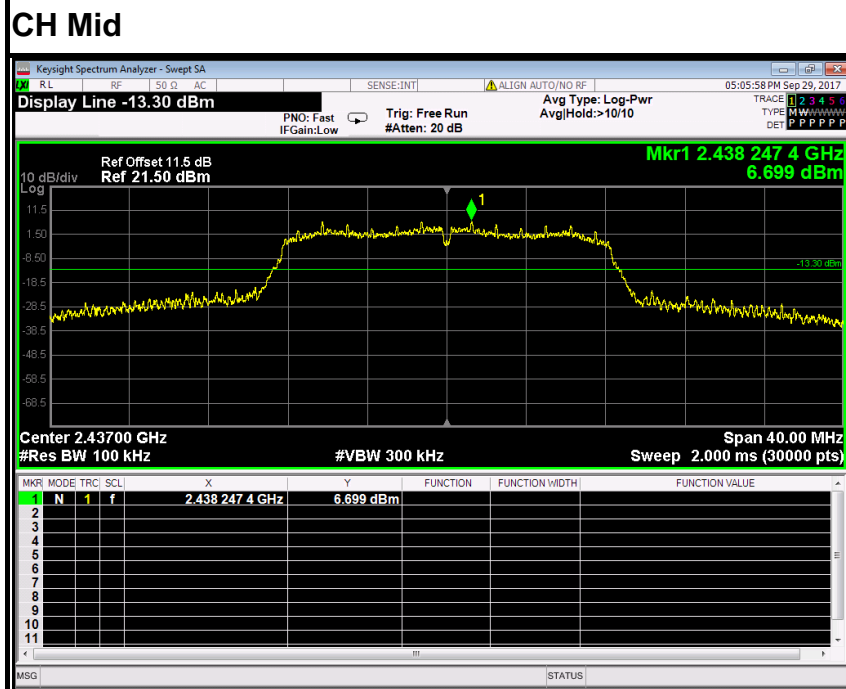
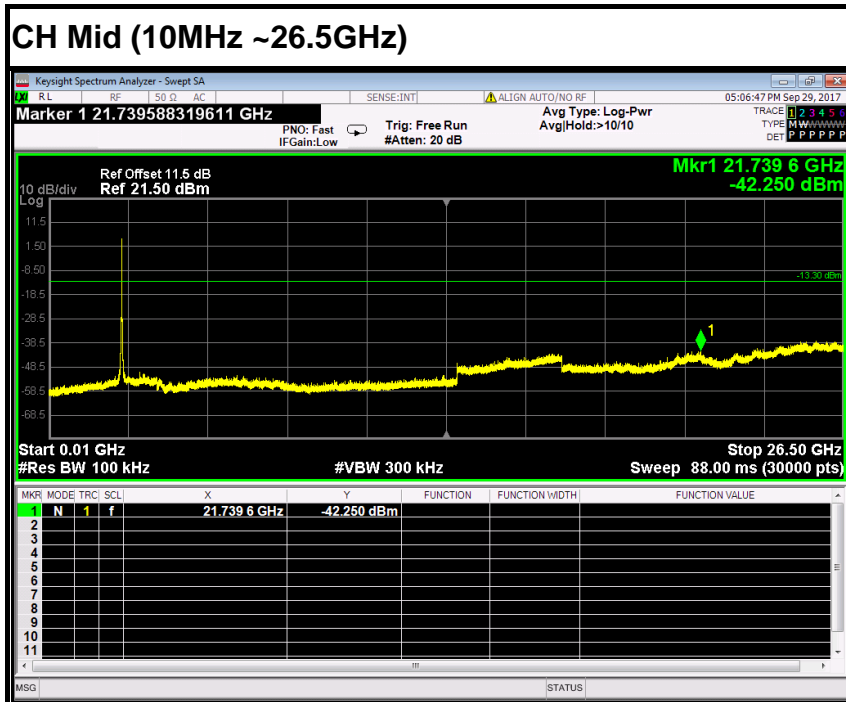

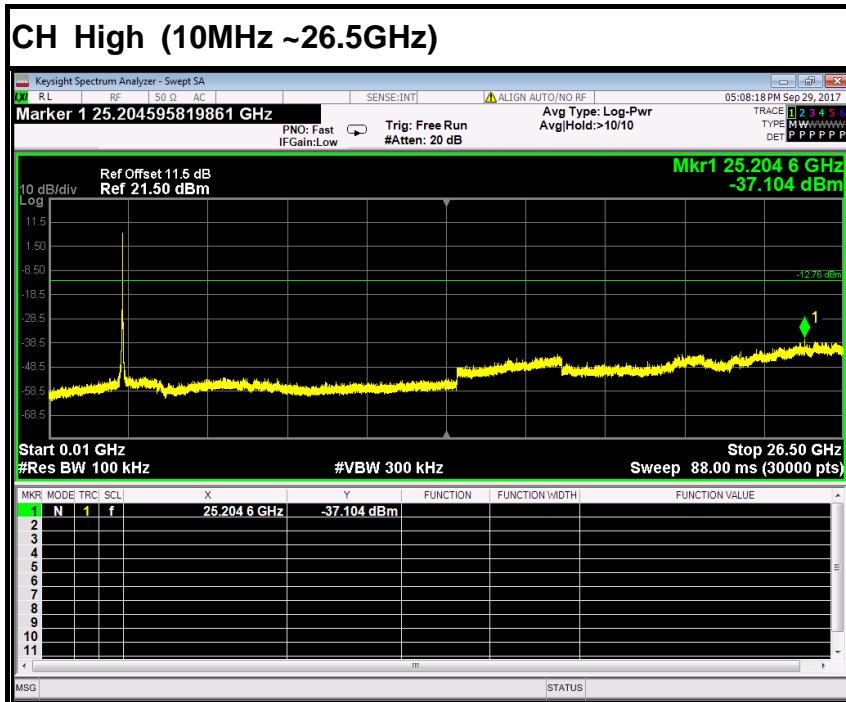

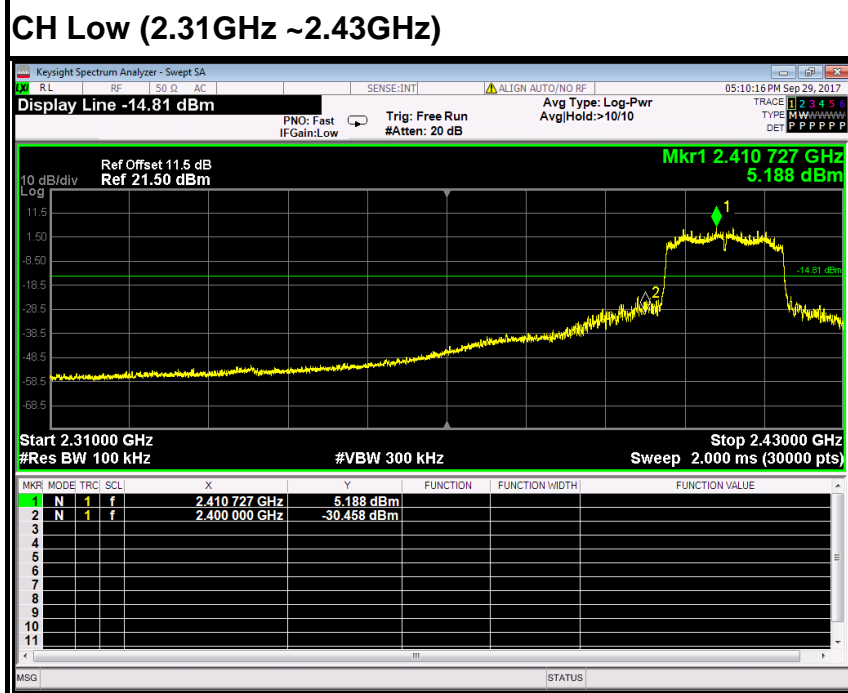
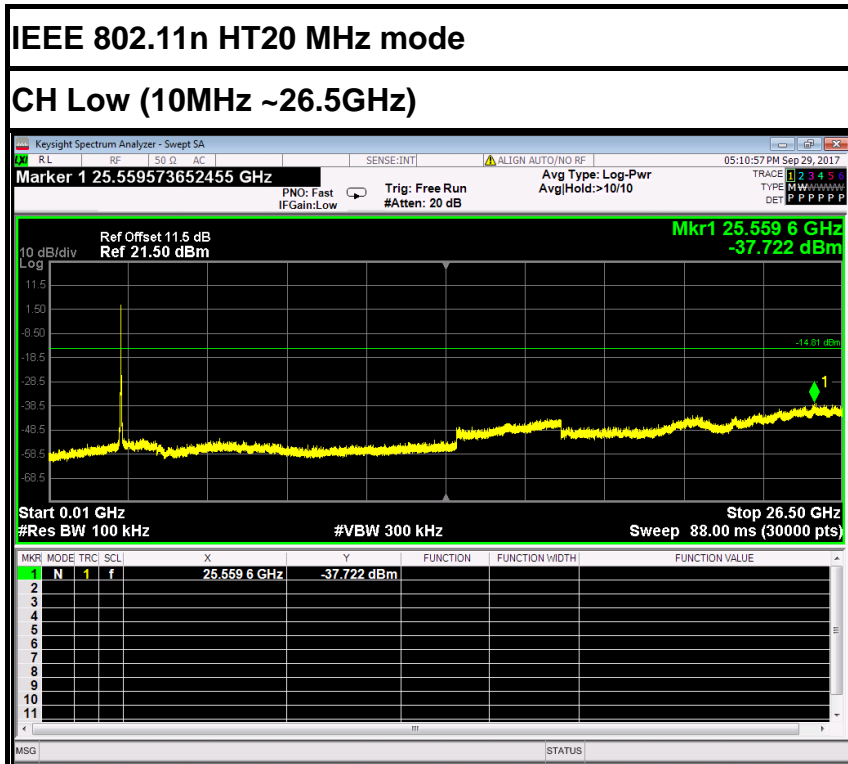

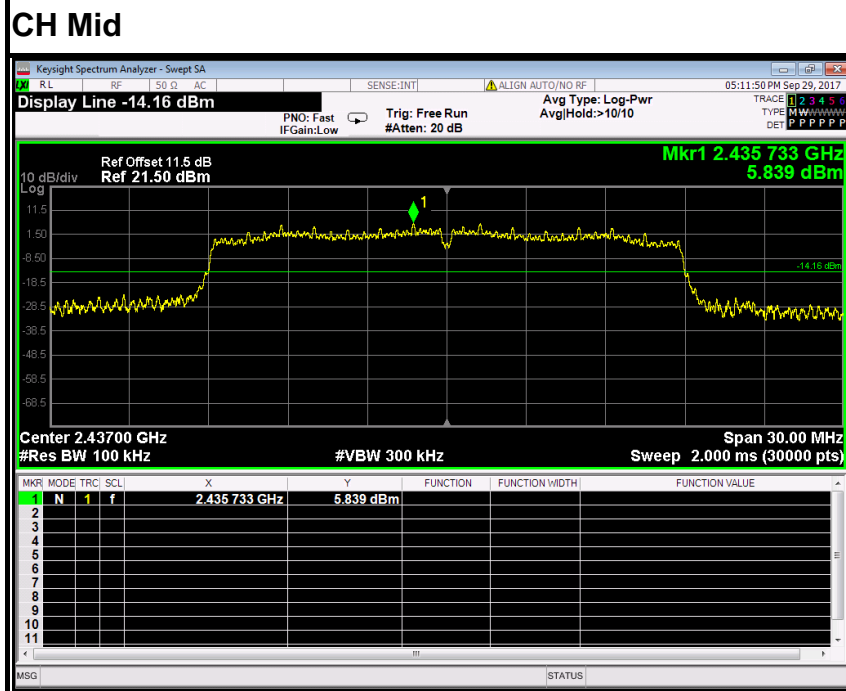
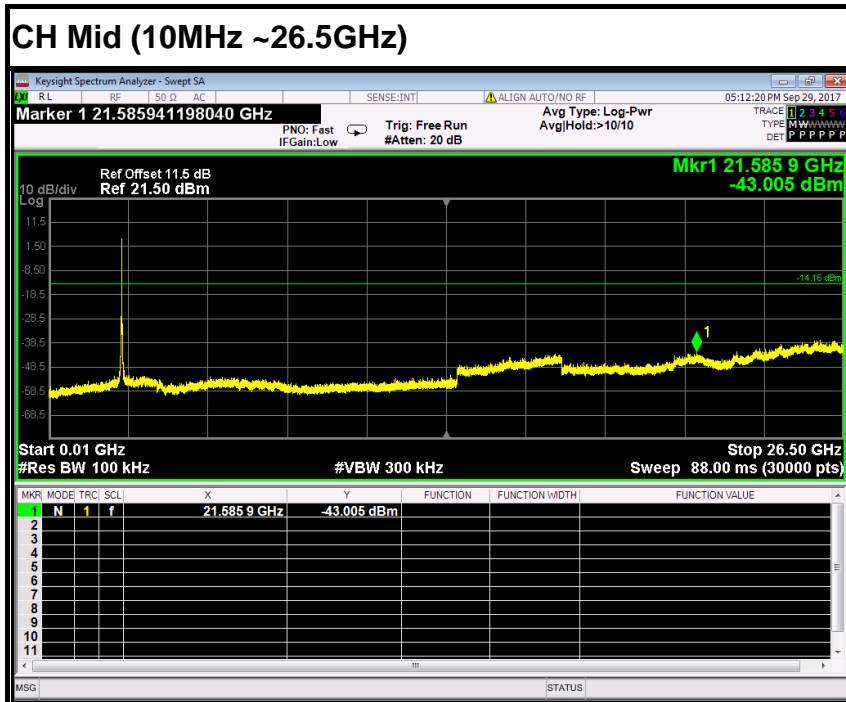

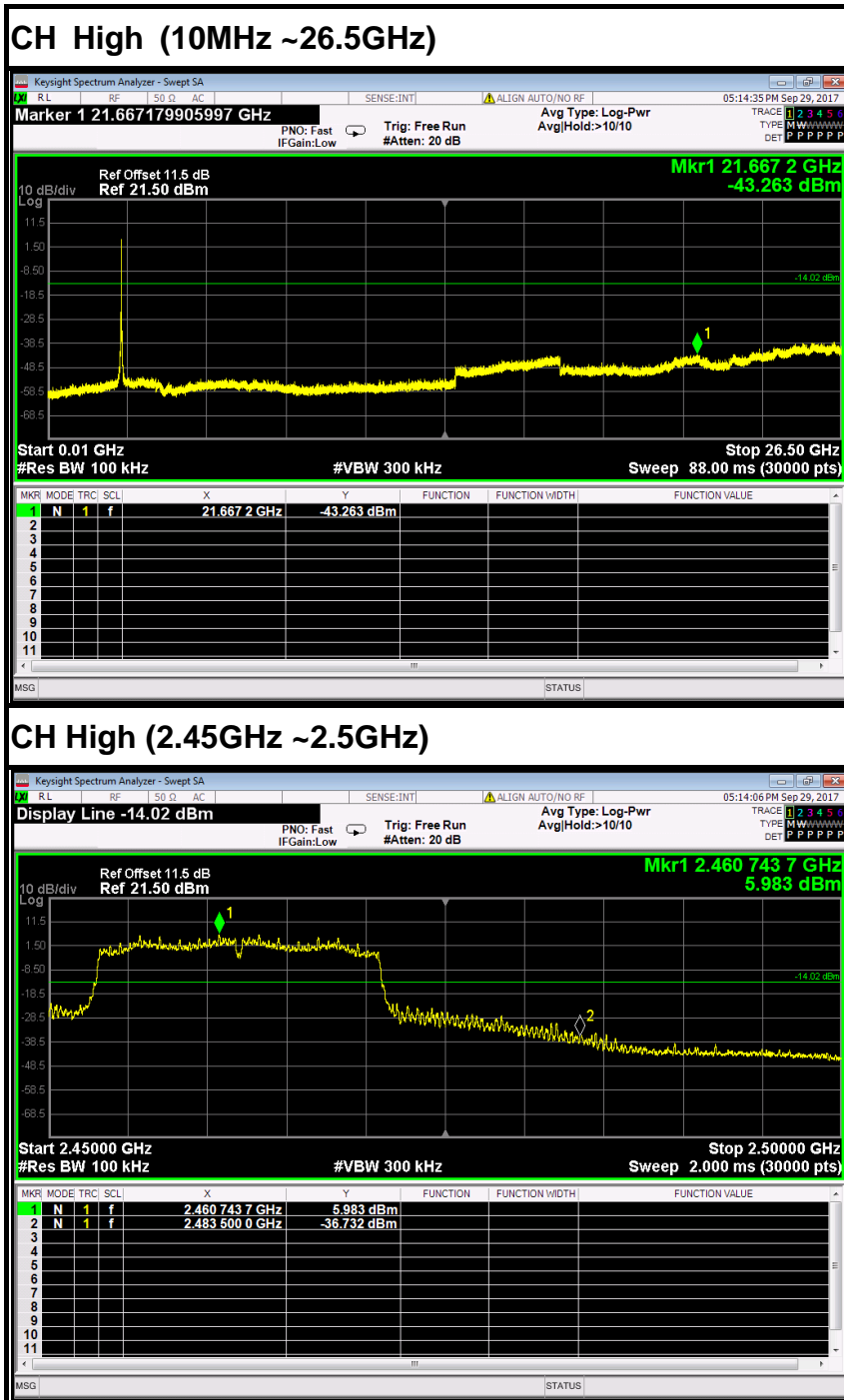

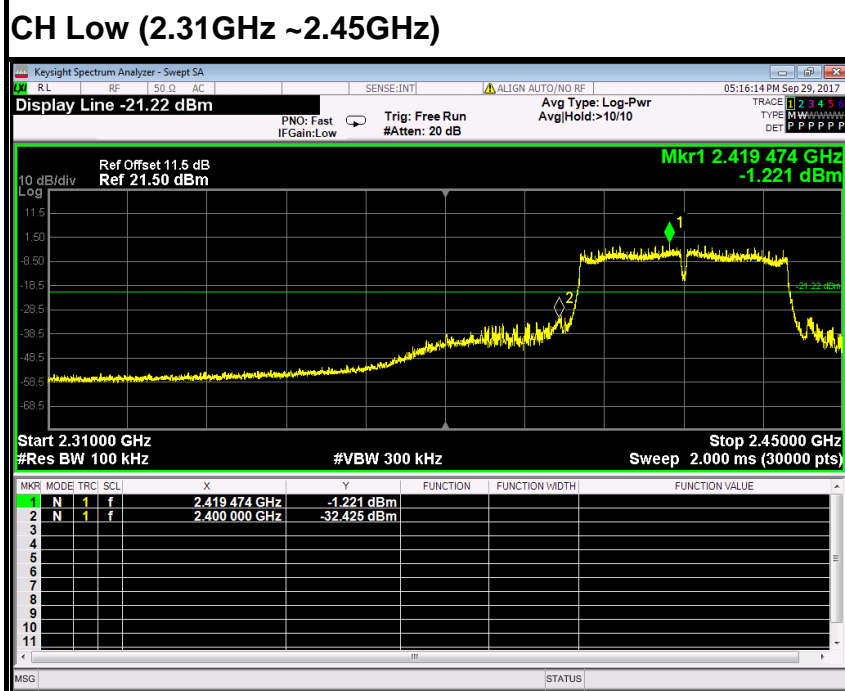
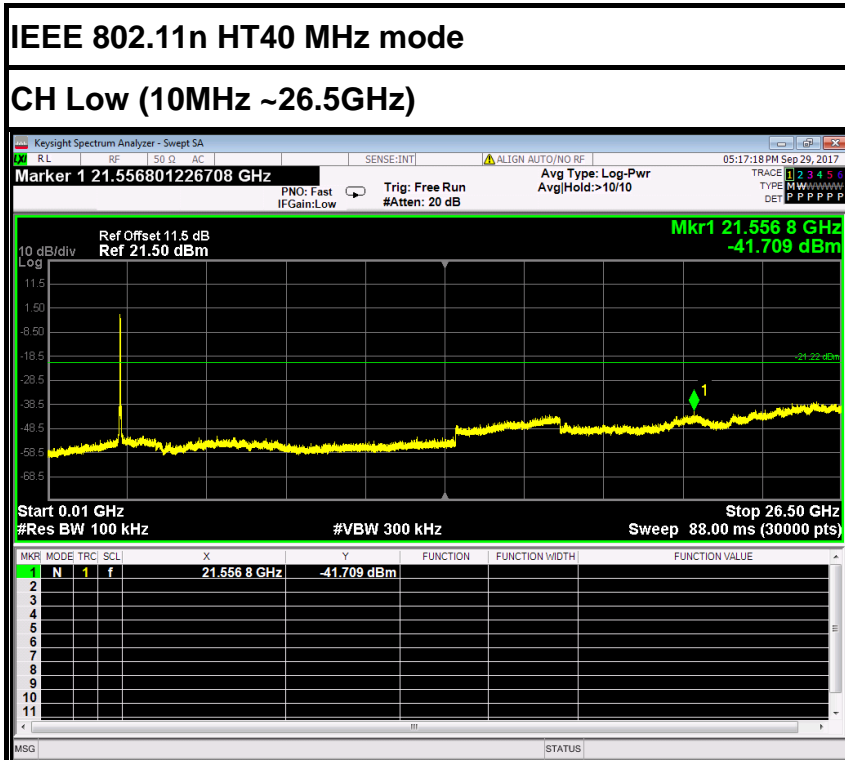

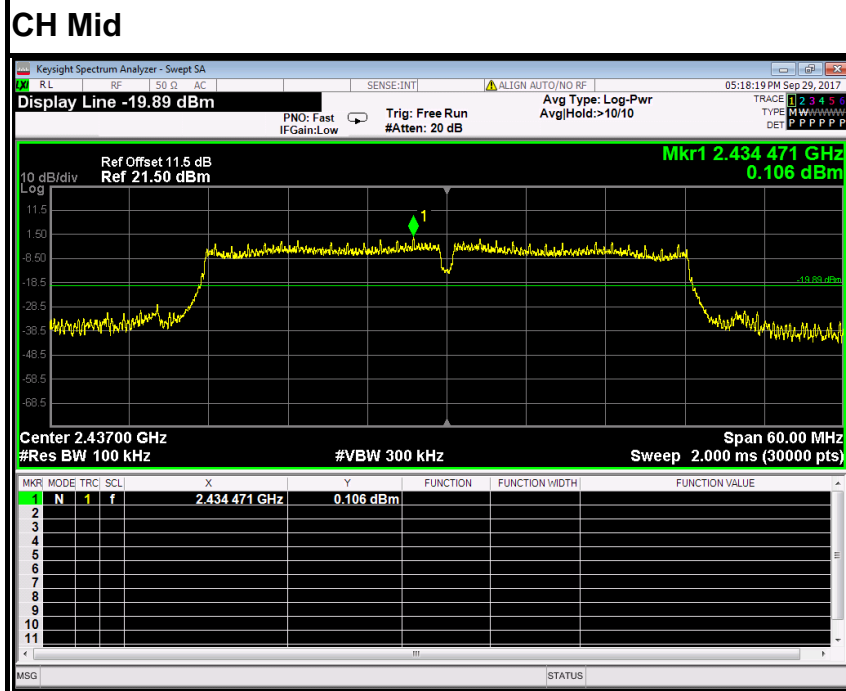
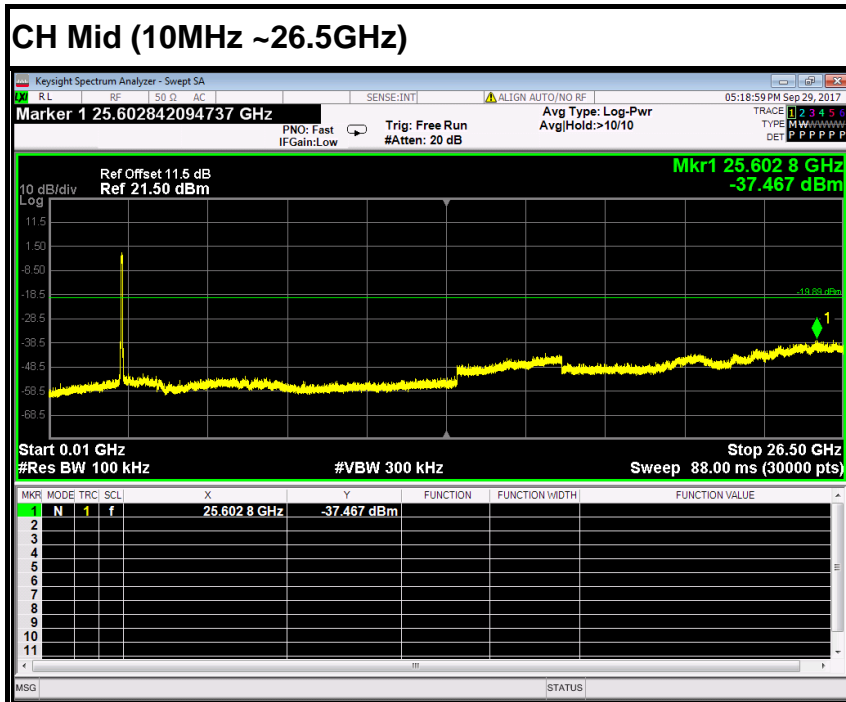



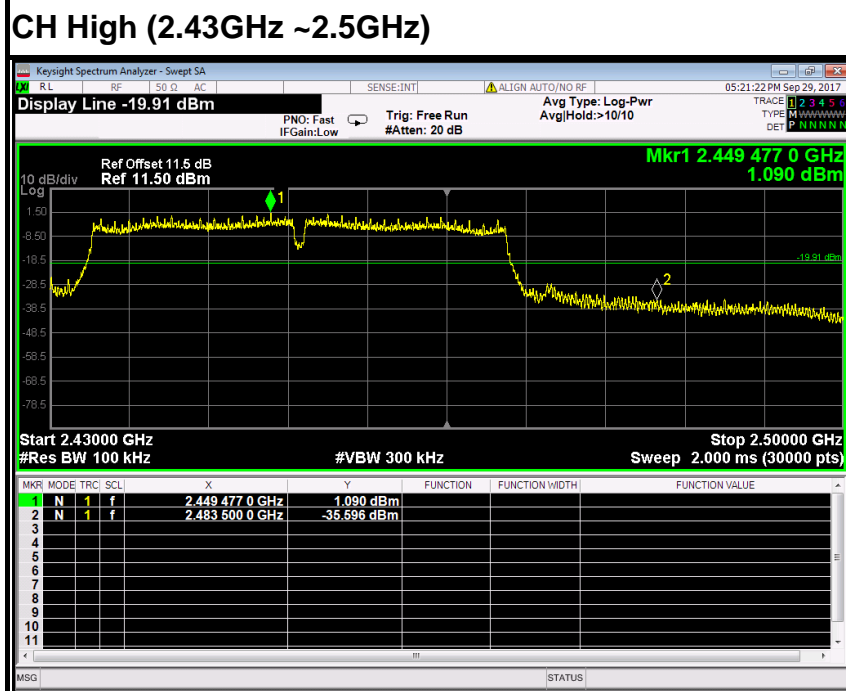
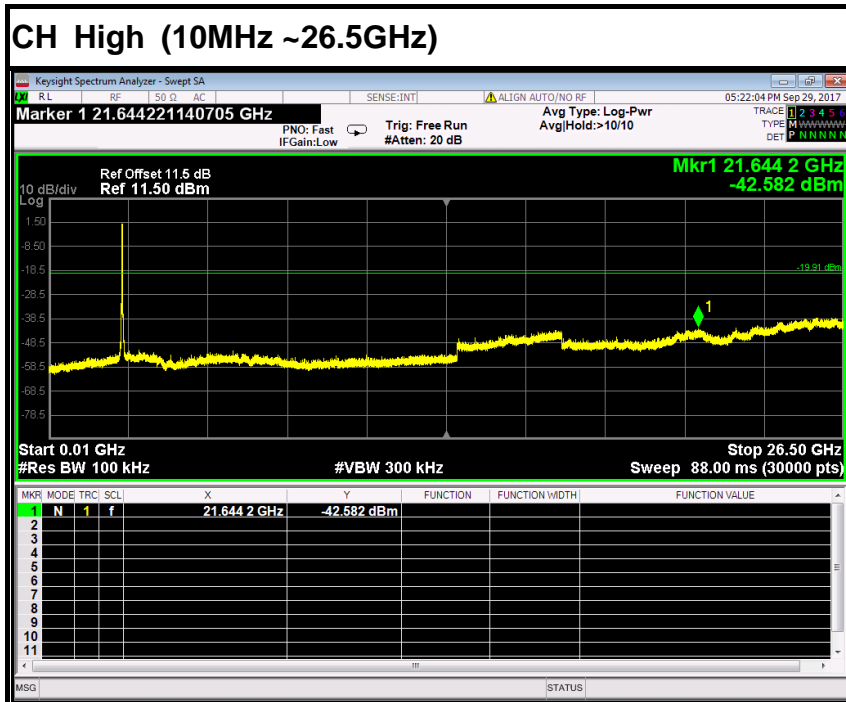



## 7.2.2. RADIATED EMISSIONS MEASUREMENT

### 7.2.2.1. LIMITS OF RADIATED EMISSIONS MEASUREMENT

According to §15.209(a), except as provided elsewhere in this Subpart, the emissions from an intentional radiator shall not exceed the field strength levels specified in the following table:

Frequency (MHz)	Field Strength (mV/m)	Measurement Distance (m)
0.009-0.490	2400/F(kHz)	300
0.490-1.705	24000/F(kHz)	30
1.705-30.0	30	30
30-88	100*	3
88-216	150*	3
216-960	200*	3
Above 960	500	3

**Remark:** Except as provided in paragraph (g), fundamental emissions from intentional radiators operating under this Section shall not be located in the frequency bands 54-72 MHz, 76-88 MHz, 174-216 MHz or 470-806 MHz. However, operation within these frequency bands is permitted under other sections of this Part, e.g., Sections 15.231 and 15.241.

1. In the emission table above, the tighter limit applies at the band edges.

Frequency (MHz)	Field Strength ( $\mu\text{V}/\text{m}$ at 3-meter)	Field Strength ( $\text{dB}\mu\text{V}/\text{m}$ at 3-meter)
30-88	100	40
88-216	150	43.5
216-960	200	46
Above 960	500	54

**NOTE:** (1) The lower limit shall apply at the transition frequencies.  
(2) Emission level ( $\text{dB}\mu\text{V}/\text{m}$ ) =  $20 \log$  Emission level ( $\mu\text{V}/\text{m}$ ).



7.2.2.2. TEST INSTRUMENTS

Radiated Emission Test Site 966 (2)					
Name of Equipment	Manufacturer	Model Number	Serial Number	Last Calibration	Due Calibration
PSA Series Spectrum Analyzer	Agilent	N9010A	MY52221469	02/21/2017	02/20/2018
EMI TEST RECEIVER	ROHDE&SCHWARZ	ESCI	100783	02/21/2017	02/20/2018
Amplifier	EMEC	EM330	060661	03/18/2017	03/17/2018
High Noise Amplifier	Agilent	8449B	3008A01838	02/21/2017	02/20/2018
Loop Antenna	COM-POWER	AL-130	121044	09/25/2017	09/24/2018
Bilog Antenna	SCHAFFNER	CBL6143	5082	02/21/2017	02/20/2018
Horn Antenna	SCHWARZBECK	BBHA9120	D286	02/27/2017	02/27/2018
Board-Band Horn Antenna	Schwarzbeck	BBHA 9170	9170-497	02/27/2017	02/27/2018
Turn Table	N/A	N/A	N/A	N.C.R	N.C.R
Antenna Tower	SUNOL	TLT2	N/A	N.C.R	N.C.R
Controller	Sunol Sciences	SC104V	022310-1	N.C.R	N.C.R
Controller	CT	N/A	N/A	N.C.R	N.C.R
Temp. / Humidity Meter	Anymetre	JR913	N/A	02/21/2017	02/20/2018
Test S/W	FARAD	LZ-RF / CCS-SZ-3A2			

- NOTE:** 1. The calibration interval of the above test instruments is 12 months and the calibrations are traceable to NML/ROC and NIST/USA.  
 2. The FCC Site Registration number is 101879.  
 3. N.C.R = No Calibration Required.



### 7.2.2.3. Measuring Instruments and Setting

The following table is the setting of spectrum analyzer and receiver.

Spectrum Parameter	Setting
Attenuation	Auto
Start Frequency	1000 MHz
Stop Frequency	10th carrier harmonic
RB / VB (Emission in restricted band)	1MHz / 1MHz for Peak, 1 MHz / 1/T for Average
RB / VB (Emission in non-restricted band)	1MHz / 1MHz for Peak, 1 MHz / 1/T for Average

Receiver Parameter	Setting
Attenuation	Auto
Start ~ Stop Frequency	9kHz~150kHz / RB 200Hz for QP/AVG
Start ~ Stop Frequency	150kHz~30MHz / RB 9kHz for QP/AVG
Start ~ Stop Frequency	30MHz~1000MHz / RB 100kHz for QP

### 7.2.2.4. TEST PROCEDURE (please refer to measurement standard)

#### 1) Sequence of testing 9 kHz to 30 MHz

##### Setup:

- The equipment was set up to simulate a typical usage like described in the user manual or described by manufacturer.
- If the EUT is a tabletop system, a rotatable table with 0.8 m height is used.
- If the EUT is a floor standing device, it is placed on the ground.
- Auxiliary equipment and cables were positioned to simulate normal operation conditions.
- The AC power port of the EUT (if available) is connected to a power outlet below the turntable.
- The measurement distance is 3 meter.
- The EUT was set into operation.

##### Pre measurement:

- The turntable rotates from 0° to 315° using 45° steps.
- The antenna height is 0.8 meter.
- At each turntable position the analyzer sweeps with peak detection to find the maximum of all emissions



**Final measurement:**

--- Identified emissions during the pre measurement the software maximizes by rotating the turntable position (0° to 360°) and by rotating the elevation axes (0° to 360°).

--- The final measurement will be done in the position (turntable and elevation) causing the highest emissions with QPK detector.

--- The final levels, frequency, measuring time, bandwidth, turntable position, correction factor, margin to the limit and limit will be recorded. Also a plot with the graph of the pre measurement and the limit will be stored.

**2) Sequence of testing 30 MHz to 1 GHz**

**Setup:**

--- The equipment was set up to simulate a typical usage like described in the user manual or described by manufacturer.

--- If the EUT is a tabletop system, a table with 0.8 m height is used, which is placed on the ground plane.

--- If the EUT is a floor standing device, it is placed on the ground plane with insulation between both.

--- Auxiliary equipment and cables were positioned to simulate normal operation conditions

--- The AC power port of the EUT (if available) is connected to a power outlet below the turntable.

--- The measurement distance is 3 meter.

--- The EUT was set into operation.

**Pre measurement:**

--- The turntable rotates from 0° to 315° using 45° steps.

--- The antenna is polarized vertical and horizontal.

--- The antenna height changes from 1 to 3 meter.

--- At each turntable position, antenna polarization and height the analyzer sweeps three times in peak to find the maximum of all emissions.



**Final measurement:**

- The final measurement will be performed with minimum the six highest peaks.
- According to the maximum antenna and turntable positions of premeasurement the software maximize the peaks by changing turntable position ( $\pm 45^\circ$ ) and antenna movement between 1 and 4 meter.
- The final measurement will be done with QP detector with an EMI receiver.
- The final levels, frequency, measuring time, bandwidth, antenna height, antenna polarization, turntable angle, correction factor, margin to the limit and limit will be recorded. Also a plot with the graph of the premeasurement with marked maximum final measurements and the limit will be stored.

**3) Sequence of testing 1 GHz to 18 GHz**

**Setup:**

- The equipment was set up to simulate a typical usage like described in the user manual or described by manufacturer.
- If the EUT is a tabletop system, a rotatable table with 1.5 m height is used.
- If the EUT is a floor standing device, it is placed on the ground plane with insulation between both.
- Auxiliary equipment and cables were positioned to simulate normal operation conditions
- The AC power port of the EUT (if available) is connected to a power outlet below the turntable.
- The measurement distance is 3 meter.
- The EUT was set into operation.

**Pre measurement:**

- The turntable rotates from  $0^\circ$  to  $315^\circ$  using  $45^\circ$  steps.
- The antenna is polarized vertical and horizontal.
- The antenna height scan range is 1 meter to 2.5 meter.
- At each turntable position and antenna polarization the analyzer sweeps with peak detection to find the maximum of all emissions.



**Final measurement:**

- The final measurement will be performed with minimum the six highest peaks.
- According to the maximum antenna and turntable positions of premeasurement the software maximize the peaks by changing turntable position ( $\pm 45^\circ$ ) and antenna movement between 1 and 4 meter. This procedure is repeated for both antenna polarizations.
- The final measurement will be done in the position (turntable, EUT-table and antenna polarization) causing the highest emissions with Peak and Average detector.
- The final levels, frequency, measuring time, bandwidth, turntable position, EUT-table position, antenna polarization, correction factor, margin to the limit and limit will be recorded. Also a plot with the graph of the pre measurement with marked maximum final measurements and the limit will be stored.

**4) Sequence of testing above 18 GHz**

**Setup:**

- The equipment was set up to simulate a typical usage like described in the user manual or described by manufacturer.
- If the EUT is a tabletop system, a rotatable table with 1.5 m height is used.
- If the EUT is a floor standing device, it is placed on the ground plane with insulation between both.
- Auxiliary equipment and cables were positioned to simulate normal operation conditions
- The AC power port of the EUT (if available) is connected to a power outlet below the turntable.
- The measurement distance is 1 meter.
- The EUT was set into operation.

**Pre measurement:**

- The antenna is moved spherical over the EUT in different polarisations of the antenna.

**Final measurement:**

- The final measurement will be performed at the position and antenna orientation for all detected emissions that were found during the premeasurements with Peak and Average detector.
- The final levels, frequency, measuring time, bandwidth, correction factor, margin to the limit and limit will be recorded. Also a plot with the graph of the premeasurement and the limit will be stored.

### 7.2.2.5. TEST SETUP

#### Below 30MHz

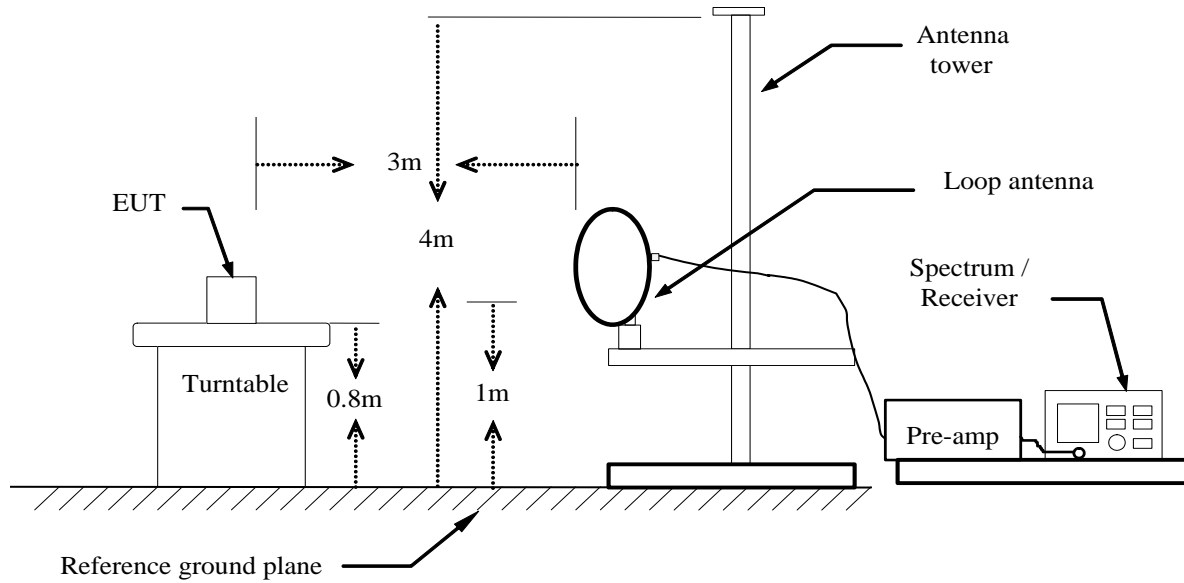

#### Below 1 GHz

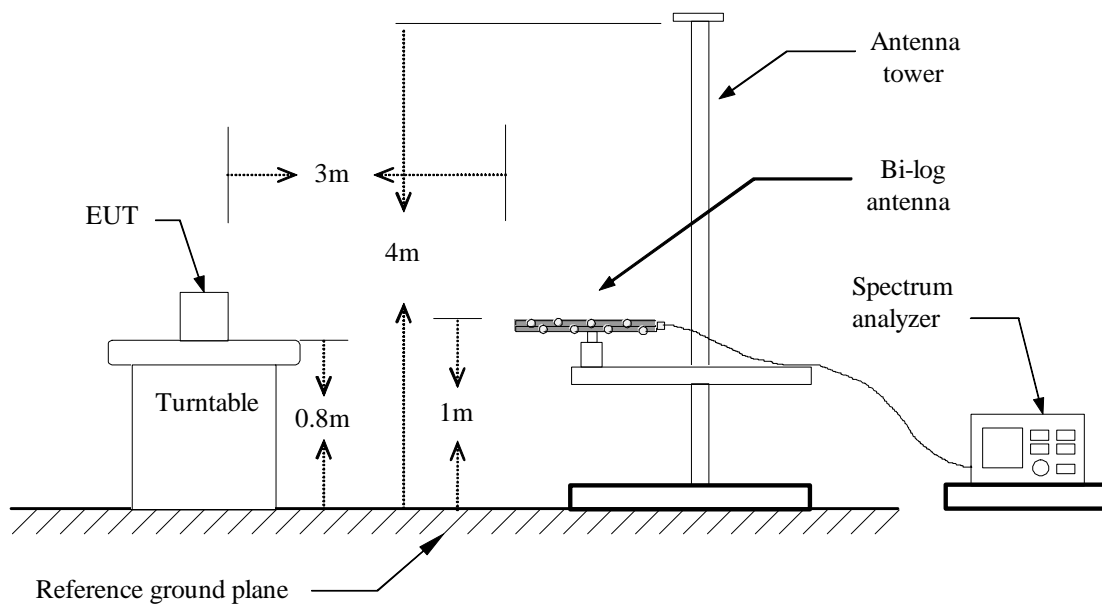





**Above 1 GHz**

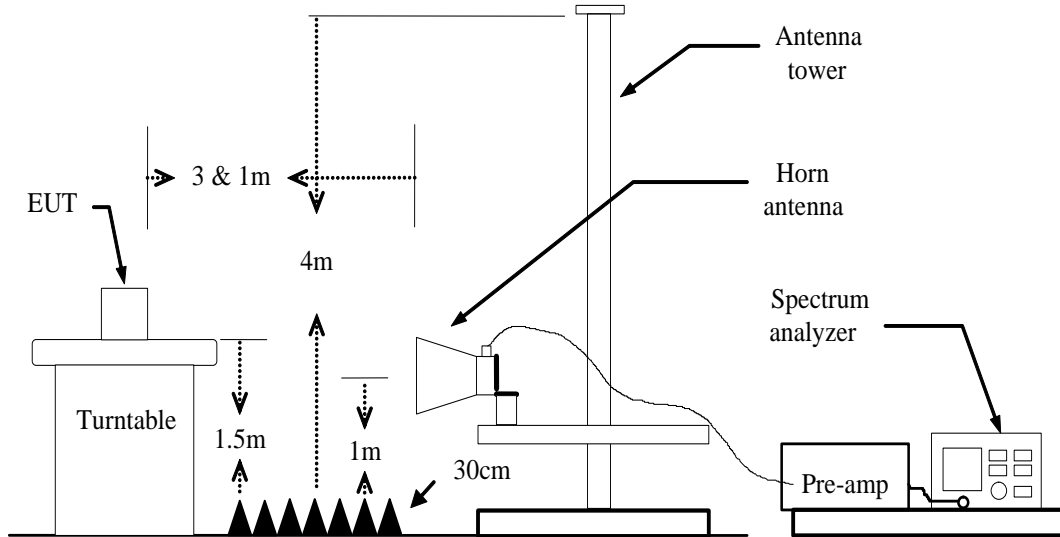

For the actual test configuration, please refer to the related item – Photographs of the Test Configuration.



7.2.2.6. DATA SAPLE

Below 1GHz

Frequency (MHz)	Reading (dBuV)	Correct Factor (dB/m)	Result (dBuV/m)	Limit (dBuV/m)	Margin (dB)	Antenna Pole (V/H)	Remark
XXXX	36.37	-12.20	24.17	40.00	-15.83	V	QP

Frequency (MHz) = Emission frequency in MHz  
 Reading (dBuV) = Uncorrected Analyzer / Receiver reading  
 Correct Factor (dB/m) = Antenna factor + Cable loss – Amplifier gain  
 Result (dBuV/m) = Reading (dBuV) + Corr. Factor (dB/m)  
 Limit (dBuV/m) = Limit stated in standard  
 Margin (dB) = Result (dBuV/m) – Limit (dBuV/m)  
 Q.P. = Quasi-peak Reading

Above 1GHz

Frequency (MHz)	Reading (dBuV)	Correction Factor (dB/m)	Result (dBuV/m)	Limit (dBuV/m)	Margin (dB)	Antenna Pole (V/H)	Remark
XXXX	62.09	-11.42	50.67	74.00	-23.33	V	Peak
XXXX	49.78	-11.42	38.36	54.00	-15.64	V	AVG

Frequency (MHz) = Emission frequency in MHz  
 Reading (dBuV) = Uncorrected Analyzer / Receiver reading  
 Correction Factor (dB/m) = Antenna factor + Cable loss – Amplifier gain  
 Result (dBuV/m) = Reading (dBuV) + Corr. Factor (dB/m)  
 Limit (dBuV/m) = Limit stated in standard  
 Margin (dB) = Result (dBuV/m) – Limit (dBuV/m)  
 Peak = Peak Reading  
 AVG = Average Reading

**Calculation Formula**

Margin (dB) = Result (dBuV/m) – Limits (dBuV/m)  
 Result (dBuV/m) = Reading (dBuV) + Correction Factor

**7.2.2.7. TEST RESULTS****Below 1 GHz****Test Mode:** TX / IEEE 802.11b(CH Low)**Tested by:** Darry Wu**Ambient temperature:** 24°C **Relative humidity:** 52% RH **Date:** October 13, 2017

Frequency (MHz)	Reading (dBuV)	Correction Factor (dB/m)	Result (dBuV/m)	Limit (dBuV/m)	Margin (dB)	Antenna Pole (V/H)	Remark
34.8500	40.03	-14.50	25.53	40.00	-14.47	V	QP
94.9900	53.46	-24.21	29.25	43.50	-14.25	V	QP
250.1900	46.85	-21.06	25.79	46.00	-20.21	V	QP
500.4500	39.12	-14.35	24.77	46.00	-21.23	V	QP
624.6100	39.67	-12.73	26.94	46.00	-19.06	V	QP
874.8700	36.65	-10.14	26.51	46.00	-19.49	V	QP
38.7300	41.64	-15.79	25.85	40.00	-14.15	H	QP
134.7600	44.74	-20.99	23.75	43.50	-19.75	H	QP
276.3800	43.04	-20.43	22.61	46.00	-23.39	H	QP
307.4200	43.98	-19.28	24.70	46.00	-21.30	H	QP
872.9300	36.59	-10.20	26.39	46.00	-19.61	H	QP
941.8000	43.37	-9.80	33.57	46.00	-12.43	H	QP

*Pre-scan all mode and recorded the worst case results in this report (802.11b (Low Mid))*

**Remark:**

- No emission found between lowest internal used/generated frequency to 30MHz (9kHz~30MHz)
- Radiated emissions measured in frequency range from 9kHz to 1GHz were made with an instrument using Quasi-peak detector mode.
- Data of measurement within this frequency range shown " --- " in the table above means the reading of emissions are attenuated more than 20dB below the permissible limits or the field strength is too small to be measured.
- The IF bandwidth of Receiver between 30MHz to 1GHz was 120kHz.
- |                        |  |
|------------------------|--|
| Frequency (MHz)        | = Emission frequency in MHz                    |
| Reading (dBuV/m)       | = Receiver reading                             |
| Correction Factor (dB) | = Antenna factor + Cable loss – Amplifier gain |
| Limit (dBuV/m)         | = Limit stated in standard                     |
| Margin (dB)            | = Measured (dBuV/m) – Limits (dBuV/m)          |
| Antenna Pole (H/V)     | = Current carrying line of reading             |



### Vertical

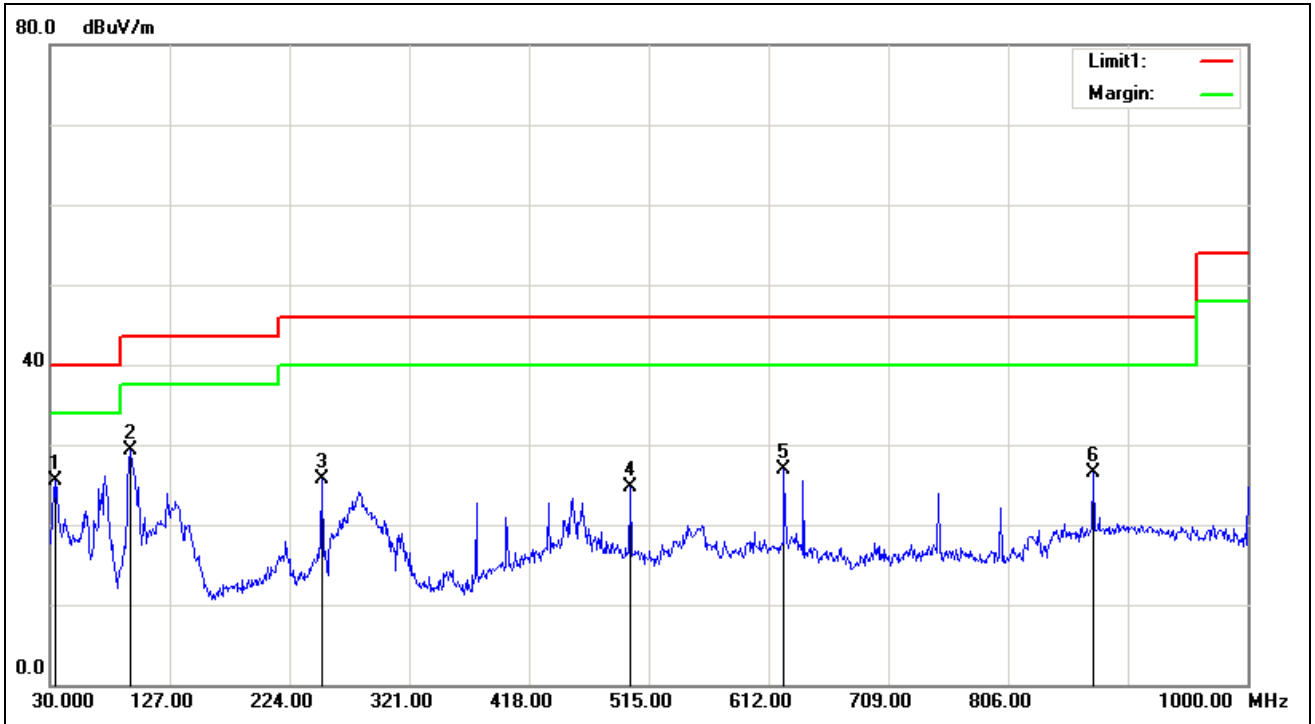

### Horizontal

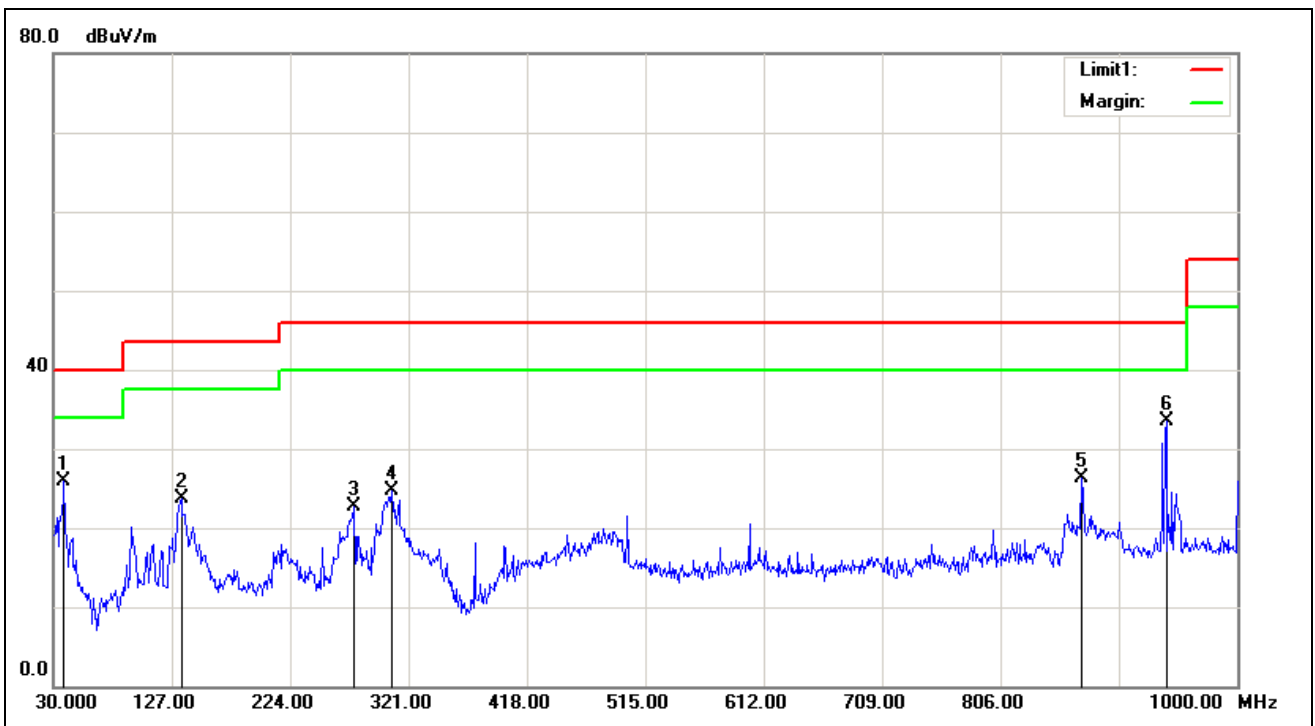

**Above 1 GHz****Antenna 0****Test Mode:** TX / IEEE 802.11b(CH Low)**Tested by:** Darry Wu**Ambient temperature:** 24°C **Relative humidity:** 52% RH**Date:** September 26, 2017

Frequency (MHz)	Reading (dBuV)	Correction Factor (dB/m)	Result (dBuV/m)	Limit (dBuV/m)	Margin (dB)	Antenna Pole (V/H)	Remark
1747.000	47.53	-6.38	41.15	74.00	-32.85	V	peak
2503.000	46.39	-2.25	44.14	74.00	-29.86	V	peak
3196.000	47.69	-1.03	46.66	74.00	-27.34	V	peak
4402.000	42.79	3.01	45.80	74.00	-28.20	V	peak
4825.000	50.15	4.41	54.56	74.00	-19.44	V	peak
4825.000	47.22	4.41	51.63	54.00	-2.37	V	AVG
5833.000	40.93	6.01	46.94	74.00	-27.06	V	peak
1765.000	48.12	-6.35	41.77	74.00	-32.23	H	Peak
2485.000	46.35	-2.34	44.01	74.00	-29.99	H	Peak
3196.000	45.98	-1.03	44.95	74.00	-29.05	H	Peak
4366.000	43.33	2.88	46.21	74.00	-27.79	H	peak
4825.000	48.95	4.41	53.36	74.00	-20.64	H	peak
4825.000	46.76	4.41	51.17	54.00	-2.83	H	AVG
6013.000	41.63	6.10	47.73	74.00	-26.27	H	Peak

**Remark:**

1. Measuring frequencies from 1 GHz to the 10th harmonic of highest fundamental frequency.
2. Radiated emissions measured in frequency above 1000MHz were made with an instrument using peak/average detector mode.
3. Average test would be performed if the peak result were greater than the average limit or as required by the applicant.
4. Data of measurement within this frequency range shown " --- " in the table above means the reading of emissions are attenuated more than 20dB below the permissible limits or the field strength is too small to be measured.
5. Measurements above show only up to 6 maximum emissions noted, or would be lesser, with " N/A " remark, if no specific emissions from the EUT are recorded (ie: margin>20dB from the applicable limit) and considered that's already beyond the background noise floor.
6. Margin (dB) = Remark result (dBuV/m) – Average limit (dBuV/m).



**Test Mode:** TX / IEEE 802.11b (CH Mid)

**Tested by:** Darry Wu

**Ambient temperature:** 24°C **Relative humidity:** 52% RH

**Date:** September 26, 2017

Frequency (MHz)	Reading (dBuV)	Correction Factor (dB/m)	Result (dBuV/m)	Limit (dBuV/m)	Margin (dB)	Antenna Pole (V/H)	Remark
1765.000	46.65	-6.35	40.30	74.00	-33.70	V	Peak
2629.000	45.42	-2.03	43.39	74.00	-30.61	V	Peak
3196.000	47.37	-1.03	46.34	74.00	-27.66	V	Peak
3817.000	43.99	0.82	44.81	74.00	-29.19	V	Peak
4870.000	46.58	4.56	51.14	74.00	-22.86	V	Peak
6454.000	40.80	6.82	47.62	74.00	-26.38	V	Peak
1765.000	46.69	-6.35	40.34	74.00	-33.66	H	Peak
2233.000	45.78	-3.72	42.06	74.00	-31.94	H	Peak
3196.000	45.74	-1.03	44.71	74.00	-29.29	H	Peak
4015.000	43.00	1.64	44.64	74.00	-29.36	H	Peak
4870.000	48.30	4.56	52.86	74.00	-21.14	H	Peak
4870.000	48.30	4.56	52.86	54.00	-1.14	H	AVG
5437.000	41.74	5.76	47.50	74.00	-26.50	H	Peak

**Remark:**

1. Measuring frequencies from 1 GHz to the 10th harmonic of highest fundamental frequency.
2. Radiated emissions measured in frequency above 1000MHz were made with an instrument using peak/average detector mode.
3. Average test would be performed if the peak result were greater than the average limit or as required by the applicant.
4. Data of measurement within this frequency range shown " --- " in the table above means the reading of emissions are attenuated more than 20dB below the permissible limits or the field strength is too small to be measured.
5. Measurements above show only up to 6 maximum emissions noted, or would be lesser, with " N/A " remark, if no specific emissions from the EUT are recorded (ie: margin>20dB from the applicable limit) and considered that's already beyond the background noise floor.
6. Margin (dB) = Remark result (dBuV/m) – Average limit (dBuV/m).



Test Mode: TX / IEEE 802.11b (CH High)

Tested by: Darry Wu

Ambient temperature: 24°C Relative humidity: 52% RH Date: September 26, 2017

Frequency (MHz)	Reading (dBuV)	Correction Factor (dB/m)	Result (dBuV/m)	Limit (dBuV/m)	Margin (dB)	Antenna Pole (V/H)	Remark
1747.000	47.63	-6.38	41.25	74.00	-32.75	V	Peak
3196.000	47.06	-1.03	46.03	74.00	-27.97	V	Peak
3997.000	44.39	1.58	45.97	74.00	-28.03	V	Peak
4924.000	44.68	4.73	49.41	74.00	-24.59	V	Peak
6040.000	42.12	6.14	48.26	74.00	-25.74	V	Peak
6814.000	42.23	7.40	49.63	74.00	-24.37	V	Peak
1747.000	47.84	-6.38	41.46	74.00	-32.54	H	Peak
2530.000	45.64	-2.21	43.43	74.00	-30.57	H	Peak
3196.000	44.47	-1.03	43.44	74.00	-30.56	H	Peak
3997.000	43.97	1.58	45.55	74.00	-28.45	H	Peak
4924.000	47.11	4.73	51.84	74.00	-22.16	H	Peak
5977.000	41.29	6.07	47.36	74.00	-26.64	H	Peak

**Remark:**

1. Measuring frequencies from 1 GHz to the 10th harmonic of highest fundamental frequency.
2. Radiated emissions measured in frequency above 1000MHz were made with an instrument using peak/average detector mode.
3. Average test would be performed if the peak result were greater than the average limit or as required by the applicant.
4. Data of measurement within this frequency range shown " --- " in the table above means the reading of emissions are attenuated more than 20dB below the permissible limits or the field strength is too small to be measured.
5. Measurements above show only up to 6 maximum emissions noted, or would be lesser, with " N/A " remark, if no specific emissions from the EUT are recorded (ie: margin>20dB from the applicable limit) and considered that's already beyond the background noise floor.
6. Margin (dB) = Remark result (dBuV/m) – Average limit (dBuV/m).

**Antenna 1****Test Mode:** TX / IEEE 802.11b(CH Low)**Tested by:** Darry Wu**Ambient temperature:** 24°C **Relative humidity:** 52% RH **Date:** September 26, 2017

Frequency (MHz)	Reading (dBuV)	Correction Factor (dB/m)	Result (dBuV/m)	Limit (dBuV/m)	Margin (dB)	Antenna Pole (V/H)	Remark
2152.000	48.18	-4.17	44.01	74.00	-29.99	V	peak
3196.000	46.58	-1.03	45.55	74.00	-28.45	V	peak
4168.000	42.49	2.18	44.67	74.00	-29.33	V	peak
4825.000	50.60	4.41	55.01	74.00	-18.99	V	peak
4825.000	45.27	4.41	49.68	54.00	-4.32	V	AVG
5860.000	41.54	6.02	47.56	74.00	-26.44	V	peak
6418.000	41.15	6.76	47.91	74.00	-26.09	V	peak
1765.000	46.97	-6.35	40.62	74.00	-33.38	H	Peak
2602.000	46.47	-2.08	44.39	74.00	-29.61	H	Peak
3196.000	44.95	-1.03	43.92	74.00	-30.08	H	Peak
3997.000	42.76	1.58	44.34	74.00	-29.66	H	peak
4825.000	49.93	4.41	54.34	74.00	-19.66	H	peak
4825.000	47.47	4.41	51.88	54.00	-2.12	H	AVG
6067.000	40.91	6.19	47.10	74.00	-26.90	H	peak

**Remark:**

1. Measuring frequencies from 1 GHz to the 10th harmonic of highest fundamental frequency.
2. Radiated emissions measured in frequency above 1000MHz were made with an instrument using peak/average detector mode.
3. Average test would be performed if the peak result were greater than the average limit or as required by the applicant.
4. Data of measurement within this frequency range shown " --- " in the table above means the reading of emissions are attenuated more than 20dB below the permissible limits or the field strength is too small to be measured.
5. Measurements above show only up to 6 maximum emissions noted, or would be lesser, with " N/A " remark, if no specific emissions from the EUT are recorded (ie: margin>20dB from the applicable limit) and considered that's already beyond the background noise floor.
6. Margin (dB) = Remark result (dBuV/m) – Average limit (dBuV/m).





Test Mode: TX / IEEE 802.11b (CH Mid)

Tested by: Darry Wu

Ambient temperature: 24°C Relative humidity: 52% RH Date: September 26, 2017

Frequency (MHz)	Reading (dBuV)	Correction Factor (dB/m)	Result (dBuV/m)	Limit (dBuV/m)	Margin (dB)	Antenna Pole (V/H)	Remark
1756.000	47.68	-6.36	41.32	74.00	-32.68	V	Peak
2656.000	45.82	-1.98	43.84	74.00	-30.16	V	Peak
3196.000	46.81	-1.03	45.78	74.00	-28.22	V	Peak
3808.000	43.68	0.78	44.46	74.00	-29.54	V	Peak
4870.000	48.40	4.56	52.96	74.00	-21.04	V	Peak
5878.000	41.37	6.03	47.40	74.00	-26.60	V	Peak
1765.000	48.03	-6.35	41.68	74.00	-32.32	H	Peak
2638.000	45.79	-2.01	43.78	74.00	-30.22	H	Peak
3664.000	44.03	0.17	44.20	74.00	-29.80	H	Peak
4870.000	48.57	4.56	53.13	74.00	-20.87	H	Peak
5680.000	41.15	5.95	47.10	74.00	-26.90	H	Peak
6328.000	41.88	6.61	48.49	74.00	-25.51	H	Peak

**Remark:**

1. Measuring frequencies from 1 GHz to the 10th harmonic of highest fundamental frequency.
2. Radiated emissions measured in frequency above 1000MHz were made with an instrument using peak/average detector mode.
3. Average test would be performed if the peak result were greater than the average limit or as required by the applicant.
4. Data of measurement within this frequency range shown " --- " in the table above means the reading of emissions are attenuated more than 20dB below the permissible limits or the field strength is too small to be measured.
5. Measurements above show only up to 6 maximum emissions noted, or would be lesser, with " N/A " remark, if no specific emissions from the EUT are recorded (ie: margin>20dB from the applicable limit) and considered that's already beyond the background noise floor.
6. Margin (dB) = Remark result (dBuV/m) – Average limit (dBuV/m).



Test Mode: TX / IEEE 802.11b (CH High)

Tested by: Darry Wu

Ambient temperature: 24°C Relative humidity: 52% RH Date: September 26, 2017

Frequency (MHz)	Reading (dBuV)	Correction Factor (dB/m)	Result (dBuV/m)	Limit (dBuV/m)	Margin (dB)	Antenna Pole (V/H)	Remark
1765.000	49.88	-6.35	43.53	74.00	-30.47	V	Peak
3205.000	48.08	-1.02	47.06	74.00	-26.94	V	Peak
3934.000	42.68	1.31	43.99	74.00	-30.01	V	Peak
4924.000	49.03	4.73	53.76	74.00	-20.24	V	Peak
4924.000	47.19	4.73	51.92	54.00	-2.08	V	AVG
6022.000	41.50	6.12	47.62	74.00	-26.38	V	Peak
7381.000	44.40	8.44	52.84	74.00	-21.16	V	Peak
2161.000	45.93	-4.12	41.81	74.00	-32.19	H	Peak
2845.000	44.81	-1.64	43.17	74.00	-30.83	H	Peak
4321.000	42.69	2.72	45.41	74.00	-28.59	H	Peak
4924.000	50.46	4.73	55.19	74.00	-18.81	H	Peak
4924.000	47.30	4.73	52.03	54.00	-1.97	H	AVG
6238.000	41.38	6.47	47.85	74.00	-26.15	H	Peak
7381.000	44.87	8.44	53.31	74.00	-20.69	H	Peak

**Remark:**

1. Measuring frequencies from 1 GHz to the 10th harmonic of highest fundamental frequency.
2. Radiated emissions measured in frequency above 1000MHz were made with an instrument using peak/average detector mode.
3. Average test would be performed if the peak result were greater than the average limit or as required by the applicant.
4. Data of measurement within this frequency range shown “ --- ” in the table above means the reading of emissions are attenuated more than 20dB below the permissible limits or the field strength is too small to be measured.
5. Measurements above show only up to 6 maximum emissions noted, or would be lesser, with “ N/A ” remark, if no specific emissions from the EUT are recorded (ie: margin>20dB from the applicable limit) and considered that's already beyond the background noise floor.
6. Margin (dB) = Remark result (dBuV/m) – Average limit (dBuV/m).



**Antenna 0**

**Test Mode:** TX / IEEE 802.11g(CH Low)

**Tested by:** Darry Wu

**Ambient temperature:** 24°C **Relative humidity:** 52% RH **Date:** September 26, 2017

Frequency (MHz)	Reading (dBuV)	Correction Factor (dB/m)	Result (dBuV/m)	Limit (dBuV/m)	Margin (dB)	Antenna Pole (V/H)	Remark
1756.000	48.26	-6.36	41.90	74.00	-32.10	V	Peak
3196.000	46.78	-1.03	45.75	74.00	-28.25	V	Peak
4024.000	42.76	1.67	44.43	74.00	-29.57	V	Peak
4825.000	57.78	4.41	62.19	74.00	-11.81	V	Peak
4825.000	44.99	4.41	49.40	54.00	-4.60	V	AVG
6022.000	41.32	6.12	47.44	74.00	-26.56	V	Peak
7228.000	45.31	8.14	53.45	74.00	-20.55	V	Peak
7228.000	32.89	8.14	41.03	54.00	-12.97	V	AVG
1747.000	47.73	-6.38	41.35	74.00	-32.65	H	Peak
2548.000	45.68	-2.17	43.51	74.00	-30.49	H	Peak
3781.000	43.26	0.67	43.93	74.00	-30.07	H	Peak
4825.000	56.65	4.41	61.06	74.00	-12.94	H	Peak
4825.000	46.93	4.41	51.34	54.00	-2.66	H	AVG
6112.000	41.23	6.26	47.49	74.00	-26.51	H	Peak
7237.000	44.21	8.16	52.37	74.00	-21.63	H	Peak

**Remark:**

1. Measuring frequencies from 1 GHz to the 10th harmonic of highest fundamental frequency.
2. Radiated emissions measured in frequency above 1000MHz were made with an instrument using peak/average detector mode.
3. Average test would be performed if the peak result were greater than the average limit or as required by the applicant.
4. Data of measurement within this frequency range shown " --- " in the table above means the reading of emissions are attenuated more than 20dB below the permissible limits or the field strength is too small to be measured.
5. Measurements above show only up to 6 maximum emissions noted, or would be lesser, with " N/A " remark, if no specific emissions from the EUT are recorded (ie: margin>20dB from the applicable limit) and considered that's already beyond the background noise floor.
6. Margin (dB) = Remark result (dBuV/m) – Average limit (dBuV/m).



Test Mode: TX / IEEE 802.11g (CH Mid)

Tested by: Darry Wu

Ambient temperature: 24°C Relative humidity: 52% RH Date: September 26, 2017

Frequency (MHz)	Reading (dBuV)	Correction Factor (dB/m)	Result (dBuV/m)	Limit (dBuV/m)	Margin (dB)	Antenna Pole (V/H)	Remark
1765.000	48.13	-6.35	41.78	74.00	-32.22	V	Peak
2638.000	46.70	-2.01	44.69	74.00	-29.31	V	Peak
3196.000	47.19	-1.03	46.16	74.00	-27.84	V	Peak
4339.000	42.87	2.78	45.65	74.00	-28.35	V	Peak
4870.000	52.68	4.56	57.24	74.00	-16.76	V	Peak
4870.000	44.79	4.56	49.35	54.00	-4.65	V	AVG
7318.000	43.38	8.32	51.70	74.00	-22.30	V	Peak
1756.000	47.27	-6.36	40.91	74.00	-33.09	H	Peak
2656.000	45.90	-1.98	43.92	74.00	-30.08	H	Peak
3673.000	43.53	0.21	43.74	74.00	-30.26	H	Peak
4879.000	53.70	4.59	58.29	74.00	-15.71	H	Peak
4879.000	44.29	4.59	48.88	54.00	-5.12	H	AVG
6256.000	41.46	6.49	47.95	74.00	-26.05	H	Peak
7318.000	42.00	8.32	50.32	74.00	-23.68	H	Peak

**Remark:**

1. Measuring frequencies from 1 GHz to the 10th harmonic of highest fundamental frequency.
2. Radiated emissions measured in frequency above 1000MHz were made with an instrument using peak/average detector mode.
3. Average test would be performed if the peak result were greater than the average limit or as required by the applicant.
4. Data of measurement within this frequency range shown " --- " in the table above means the reading of emissions are attenuated more than 20dB below the permissible limits or the field strength is too small to be measured.
5. Measurements above show only up to 6 maximum emissions noted, or would be lesser, with " N/A " remark, if no specific emissions from the EUT are recorded (ie: margin>20dB from the applicable limit) and considered that's already beyond the background noise floor.
6. Margin (dB) = Remark result (dBuV/m) – Average limit (dBuV/m).



Test Mode: TX / IEEE 802.11g (CH High)

Tested by: Darry Wu

Ambient temperature: 24°C Relative humidity: 52% RH Date: September 26, 2017

Frequency (MHz)	Reading (dBuV)	Correction Factor (dB/m)	Result (dBuV/m)	Limit (dBuV/m)	Margin (dB)	Antenna Pole (V/H)	Remark
1756.000	48.06	-6.36	41.70	74.00	-32.30	V	Peak
2530.000	46.66	-2.21	44.45	74.00	-29.55	V	Peak
3196.000	47.66	-1.03	46.63	74.00	-27.37	V	Peak
3997.000	44.06	1.58	45.64	74.00	-28.36	V	Peak
4924.000	50.36	4.73	55.09	74.00	-18.91	V	Peak
4924.000	41.26	4.73	45.99	54.00	-8.01	V	AVG
5464.000	42.14	5.81	47.95	74.00	-26.05	V	Peak
1756.000	51.48	-6.36	45.12	74.00	-28.88	H	Peak
2647.000	45.77	-2.00	43.77	74.00	-30.23	H	Peak
3997.000	42.84	1.58	44.42	74.00	-29.58	H	Peak
4924.000	52.17	4.73	56.90	74.00	-17.10	H	Peak
4924.000	42.62	4.73	47.35	54.00	-6.65	H	AVG
6121.000	41.10	6.28	47.38	74.00	-26.62	H	Peak
7381.000	42.60	8.44	51.04	74.00	-22.96	H	Peak

**Remark:**

1. Measuring frequencies from 1 GHz to the 10th harmonic of highest fundamental frequency.
2. Radiated emissions measured in frequency above 1000MHz were made with an instrument using peak/average detector mode.
3. Average test would be performed if the peak result were greater than the average limit or as required by the applicant.
4. Data of measurement within this frequency range shown “ --- ” in the table above means the reading of emissions are attenuated more than 20dB below the permissible limits or the field strength is too small to be measured.
5. Measurements above show only up to 6 maximum emissions noted, or would be lesser, with “ N/A ” remark, if no specific emissions from the EUT are recorded (ie: margin>20dB from the applicable limit) and considered that's already beyond the background noise floor.
6. Margin (dB) = Remark result (dBuV/m) – Average limit (dBuV/m).



**Antenna 1**

**Test Mode:** TX / IEEE 802.11g(CH Low)

**Tested by:** Darry Wu

**Ambient temperature:** 24°C **Relative humidity:** 52% RH **Date:** September 26, 2017

Frequency (MHz)	Reading (dBuV)	Correction Factor (dB/m)	Result (dBuV/m)	Limit (dBuV/m)	Margin (dB)	Antenna Pole (V/H)	Remark
2089.000	45.82	-4.51	41.31	74.00	-32.69	V	Peak
2512.000	46.11	-2.24	43.87	74.00	-30.13	V	Peak
3196.000	47.25	-1.03	46.22	74.00	-27.78	V	Peak
4132.000	42.38	2.05	44.43	74.00	-29.57	V	Peak
4825.000	51.84	4.41	56.25	74.00	-17.75	V	Peak
4825.000	45.81	4.41	50.22	54.00	-3.78	V	AVG
5941.000	42.29	6.06	48.35	74.00	-25.65	V	Peak
1747.000	47.79	-6.38	41.41	74.00	-32.59	H	Peak
3214.000	45.40	-1.00	44.40	74.00	-29.60	H	Peak
4285.000	49.39	2.59	51.98	74.00	-22.02	H	Peak
4825.000	53.55	4.41	57.96	74.00	-16.04	H	Peak
4825.000	47.04	4.41	51.45	54.00	-2.55	H	AVG
6553.000	41.79	6.98	48.77	74.00	-25.23	H	Peak
7228.000	44.65	8.14	52.79	74.00	-21.21	H	Peak

**Remark:**

1. Measuring frequencies from 1 GHz to the 10th harmonic of highest fundamental frequency.
2. Radiated emissions measured in frequency above 1000MHz were made with an instrument using peak/average detector mode.
3. Average test would be performed if the peak result were greater than the average limit or as required by the applicant.
4. Data of measurement within this frequency range shown “ --- ” in the table above means the reading of emissions are attenuated more than 20dB below the permissible limits or the field strength is too small to be measured.
5. Measurements above show only up to 6 maximum emissions noted, or would be lesser, with “ N/A ” remark, if no specific emissions from the EUT are recorded (ie: margin>20dB from the applicable limit) and considered that's already beyond the background noise floor.
6. Margin (dB) = Remark result (dBuV/m) – Average limit (dBuV/m).



Test Mode: TX / IEEE 802.11g (CH Mid)

Tested by: Darry Wu

Ambient temperature: 24°C Relative humidity: 52% RH Date: September 26, 2017

Frequency (MHz)	Reading (dBuV)	Correction Factor (dB/m)	Result (dBuV/m)	Limit (dBuV/m)	Margin (dB)	Antenna Pole (V/H)	Remark
2242.000	46.29	-3.67	42.62	74.00	-31.38	V	Peak
3196.000	48.16	-1.03	47.13	74.00	-26.87	V	Peak
4114.000	43.15	1.99	45.14	74.00	-28.86	V	Peak
4870.000	50.75	4.56	55.31	74.00	-18.69	V	Peak
4870.000	39.49	4.56	44.05	54.00	-9.95	V	AVG
6067.000	41.86	6.19	48.05	74.00	-25.95	V	Peak
7309.000	45.71	8.30	54.01	74.00	-19.99	V	Peak
7309.000	30.69	8.30	38.99	54.00	-15.01	V	AVG
1765.000	48.79	-6.35	42.44	74.00	-31.56	H	Peak
2440.000	47.40	-2.59	44.81	74.00	-29.19	H	Peak
3979.000	43.31	1.50	44.81	74.00	-29.19	H	Peak
4879.000	53.57	4.59	58.16	74.00	-15.84	H	Peak
4879.000	44.07	4.59	48.66	54.00	-5.34	H	AVG
6067.000	41.84	6.19	48.03	74.00	-25.97	H	Peak
7300.000	45.64	8.29	53.93	74.00	-20.07	H	Peak
7300.000	32.83	8.29	41.12	54.00	-12.88	H	AVG

**Remark:**

1. Measuring frequencies from 1 GHz to the 10th harmonic of highest fundamental frequency.
2. Radiated emissions measured in frequency above 1000MHz were made with an instrument using peak/average detector mode.
3. Average test would be performed if the peak result were greater than the average limit or as required by the applicant.
4. Data of measurement within this frequency range shown " --- " in the table above means the reading of emissions are attenuated more than 20dB below the permissible limits or the field strength is too small to be measured.
5. Measurements above show only up to 6 maximum emissions noted, or would be lesser, with " N/A " remark, if no specific emissions from the EUT are recorded (ie: margin>20dB from the applicable limit) and considered that's already beyond the background noise floor.
6. Margin (dB) = Remark result (dBuV/m) – Average limit (dBuV/m).



**Test Mode:** TX / IEEE 802.11g (CH High)

**Tested by:** Darry Wu

**Ambient temperature:** 24°C **Relative humidity:** 52% RH **Date:** September 26, 2017

Frequency (MHz)	Reading (dBuV)	Correction Factor (dB/m)	Result (dBuV/m)	Limit (dBuV/m)	Margin (dB)	Antenna Pole (V/H)	Remark
1900.000	45.66	-5.63	40.03	74.00	-33.97	V	Peak
2458.000	48.51	-2.49	46.02	74.00	-27.98	V	Peak
3196.000	46.69	-1.03	45.66	74.00	-28.34	V	Peak
4924.000	49.38	4.73	54.11	74.00	-19.89	V	Peak
4924.000	43.92	4.73	48.65	54.00	-5.35	V	AVG
6328.000	41.56	6.61	48.17	74.00	-25.83	V	Peak
7390.000	47.09	8.46	55.55	74.00	-18.45	V	Peak
7390.000	34.77	8.46	43.23	54.00	-10.77	V	AVG
2242.000	45.88	-3.67	42.21	74.00	-31.79	H	Peak
2629.000	45.81	-2.03	43.78	74.00	-30.22	H	Peak
4051.000	42.83	1.77	44.60	74.00	-29.40	H	Peak
4924.000	53.94	4.73	58.67	74.00	-15.33	H	Peak
4924.000	44.83	4.73	49.56	54.00	-4.44	H	AVG
6139.000	40.99	6.31	47.30	74.00	-26.70	H	Peak
7390.000	45.76	8.46	54.22	74.00	-19.78	H	Peak
7390.000	36.77	8.46	45.23	54.00	-8.77	H	AVG

**Remark:**

1. Measuring frequencies from 1 GHz to the 10th harmonic of highest fundamental frequency.
2. Radiated emissions measured in frequency above 1000MHz were made with an instrument using peak/average detector mode.
3. Average test would be performed if the peak result were greater than the average limit or as required by the applicant.
4. Data of measurement within this frequency range shown " --- " in the table above means the reading of emissions are attenuated more than 20dB below the permissible limits or the field strength is too small to be measured.
5. Measurements above show only up to 6 maximum emissions noted, or would be lesser, with " N/A " remark, if no specific emissions from the EUT are recorded (ie: margin>20dB from the applicable limit) and considered that's already beyond the background noise floor.
6. Margin (dB) = Remark result (dBuV/m) – Average limit (dBuV/m).





**Combine with Antenna 0 and Antenna 1**

**Test Mode:** TX / IEEE 802.11n HT20 MHz (CH Low)

**Tested by:** Darry Wu

**Ambient temperature:** 24°C **Relative humidity:** 52% RH **Date:** September 26, 2017

Frequency (MHz)	Reading (dBuV)	Correction Factor (dB/m)	Result (dBuV/m)	Limit (dBuV/m)	Margin (dB)	Antenna Pole (V/H)	Remark
1765.000	55.87	-6.35	49.52	74.00	-24.48	V	Peak
3214.000	45.22	-1.00	44.22	74.00	-29.78	V	Peak
3934.000	42.60	1.31	43.91	74.00	-30.09	V	Peak
4825.000	57.11	4.41	61.52	74.00	-12.48	V	Peak
4825.000	45.24	4.41	49.65	54.00	-4.35	V	AVG
5878.000	41.48	6.03	47.51	74.00	-26.49	V	Peak
7237.000	44.75	8.16	52.91	74.00	-21.09	V	Peak
2629.000	45.76	-2.03	43.73	74.00	-30.27	H	Peak
3214.000	45.85	-1.00	44.85	74.00	-29.15	H	Peak
4132.000	42.29	2.05	44.34	74.00	-29.66	H	Peak
4816.000	54.85	4.38	59.23	74.00	-14.77	H	Peak
4816.000	46.87	4.38	51.25	54.00	-2.75	H	AVG
5887.000	42.43	6.03	48.46	74.00	-25.54	H	Peak
7228.000	46.39	8.14	54.53	74.00	-19.47	H	Peak
7228.000	44.53	8.14	52.67	54.00	-1.33	H	AVG

**Remark:**

1. Measuring frequencies from 1 GHz to the 10th harmonic of highest fundamental frequency.
2. Radiated emissions measured in frequency above 1000MHz were made with an instrument using peak/average detector mode.
3. Average test would be performed if the peak result were greater than the average limit or as required by the applicant.
4. Data of measurement within this frequency range shown " --- " in the table above means the reading of emissions are attenuated more than 20dB below the permissible limits or the field strength is too small to be measured.
5. Measurements above show only up to 6 maximum emissions noted, or would be lesser, with " N/A " remark, if no specific emissions from the EUT are recorded (ie: margin>20dB from the applicable limit) and considered that's already beyond the background noise floor.
6. Margin (dB) = Remark result (dBuV/m) – Average limit (dBuV/m).