



**Shenzhen GTI Technology Co., Ltd.**

1-2/F., Building 2, Jiaquan Building, Guanlan High-Tech Park, Shenzhen, Guangdong, China  
Tel : +86-755-27521059  
Fax: +86-755-27521011

# TEST REPORT

**Product Name** ..... : Sport Bluetooth Earphone

**Trademark** ..... : PISEN

**Model/Type reference** ..... : BHD1

**Listed Model(s)** ..... : /

**FCC ID** ..... : 2AF56-BHD1

**Test Standards** ..... : FCC Part 15.247: Operation within the bands 902-928 MHz, 2400-2483.5 MHz and 5725-5850 MHz

**Report No** ..... : GTI20180268F

**Applicant** ..... : GuangDong Pisen Electronics Co.,LTD.  
NO.9,QINFU 1ST.STREET JINTANG INDUSTRY ZONE

**Address of Applicant**..... : LIUYUE, HENGGANG TOWN, LONGGANG DISTRICT,  
SHENZHEN

**Date of Receipt** ..... : Mar. 3, 2018

**Date of Test Date**..... : Mar. 4, 2018 –Mar. 12, 2018

**Data of Issue.** ..... : Mar.14, 2018

<b>Test result</b>	<b>Pass *</b>
--------------------	---------------

\* In the configuration tested, the EUT complied with the standards specified above

Shenzhen General Testing & Inspection Technology Co., Ltd.

1-2/F., Building 2, Jiaquan Building, Guanlan High-Tech Park, Shenzhen, Guangdong, China  
Tel.: (86)755-27521059 Fax.: (86)755-27521011 Http://www.sz-ctc.org.cn



For anti-fake verification, please visit the official website of Certification and Accreditation Administration of the People's Republic of China : [yz.cncaic.cn](http://yz.cncaic.cn)

GENERAL DESCRIPTION OF EUT	
Equipment:	SPORT BLUETOOTH EARPHONE
Model Name:	BHD1
Listed Model(s):	/
Manufacturer:	GuangDong Pisen Electronics Co.,LTD
Manufacturer Address:	NO.9,QINFU 1ST.STREET JINTANG INDUSTRY ZONE LIUYUE, HENGGANG TOWN, LONGGANG DISTRICT, SHENZHEN
Power Source:	DC 3.70V 50mAh from battery
Adapter:	/

Compiled By:



---

(Torny Fang)

Reviewed By:



---

(Totti Zhao)

Approved By:



---

(Walter Chen)

This test report may be duplicated completely for legal use with the approval of the applicant. It should not be reproduced except in full, without the written approval of our laboratory. The client should not use it to claim product endorsement by GTI. The test results in the report only apply to the tested sample. The test report shall be invalid without all the signatures of testing engineers, reviewer and approver. Any objections must be raised to GTI within 15 days since the date when the report is received. It will not be taken into consideration beyond this limit.

## Table of Contents

## Page

1.1.	TEST REPORT .....	1
<b>2.</b>	<b>SUMMARY.....</b>	<b>4</b>
2.1.	TEST STANDARDS.....	4
2.2.	TEST DESCRIPTION.....	4
2.3.	TEST FACILITY .....	5
2.4.	MEASUREMENT UNCERTAINTY .....	5
<b>3.</b>	<b>GENERAL INFORMATION .....</b>	<b>7</b>
3.1.	ENVIRONMENTAL CONDITIONS .....	7
3.2.	GENERAL DESCRIPTION OF EUT .....	7
3.3.	DESCRIPTION OF TEST MODES .....	8
3.4.	MEASUREMENT INSTRUMENTS LIST .....	8
<b>4.</b>	<b>TEST CONDITIONS AND RESULTS .....</b>	<b>10</b>
4.1.	CONDUCTED EMISSION MEASUREMENT.....	10
4.2.	RADIATED EMISSION .....	14
4.3.	MAXIMUM PEAK OUTPUT POWER .....	19
4.4.	20dB BANDWIDTH.....	22
4.5.	BAND EDGE .....	27
4.6.	FREQUENCY SEPARATION .....	32
4.7.	NUMBER OF HOPPING FREQUENCY.....	34
4.8.	TIME OF OCCUPANCY (DWELL TIME).....	36
4.9.	PSEUDORANDOM FREQUENCY HOPPING SEQUENCE.....	38
4.10.	ANTENNA REQUIREMENT.....	39
<b>5.</b>	<b>EUT TEST PHOTO .....</b>	<b>40</b>
<b>6.</b>	<b>PHOTOGRAPHS OF EUT CONSTRUCTIONAL .....</b>	<b>42</b>

# 1. SUMMARY

## 1.1. Test Standards

The tests were performed according to following standards:

**FCC Rules Part 15.247:** Frequency Hopping, Direct Spread Spectrum and Hybrid Systems that are in operation within the bands of 902-928 MHz, 2400-2483.5 MHz, and 5725-5850 MHz

**ANSI C63.10-2013:** American National Standard for Testing Unlicensed Wireless Devices

## 1.2. Test Description

FCC PART 15 15.247		
FCC Part 15.207	AC Power Conducted Emission	PASS
FCC Part 15.247(a)(1)(i)	20dB Bandwidth	PASS
FCC Part 15.247(d)	Spurious RF Conducted Emission	N/A
FCC Part 15.247(b)	Maximum Peak Output Power	PASS
FCC Part 15.247(b)	Pseudorandom Frequency Hopping Sequence	PASS
FCC Part 15.247(a)(1)(iii)	Number of hopping frequency& Time of Occupancy	PASS
FCC Part 15.247(a)(1)	Frequency Separation	PASS
FCC Part 15.205/15.209	Radiated Emissions	PASS
FCC Part 15.247(d)	Band Edge Compliance of RF Emission	PASS
FCC Part 15.203/15.247 (b)	Antenna Requirement	PASS

Remark: The measurement uncertainty is not included in the test result.

## 1.3. Test Facility

### 1.3.1 Address of the test laboratory

**Shenzhen General Testing & Inspection Technology Co., Ltd.**

Add: 1-2/F., Building 2, Jiaquan Building, Guanlan High-Tech Park, Shenzhen, Guangdong, China

### 1.3.2 Laboratory accreditation

The test facility is recognized, certified, or accredited by the following organizations:

#### IC Registration No.: 9783A

The 3m alternate test site of Shenzhen GTI Technology Co., Ltd. EMC Laboratory has been registered by Certification and Engineer Bureau of Industry Canada for the performance of with Registration NO.: 9783A on Jan, 2016.

#### FCC-Registration No.: 951311

Shenzhen GTI Technology Co., Ltd. EMC Laboratory has been registered and fully described in a report filed with the (FCC) Federal Communications Commission. The acceptance letter from the FCC is maintained in our files. Registration 951311, Aug 26, 2017

## 1.4. Measurement Uncertainty

The data and results referenced in this document are true and accurate. The reader is cautioned that there may be errors within the calibration limits of the equipment and facilities. The measurement uncertainty was calculated for all measurements listed in this test report acc. to CISPR 16 - 4 Specification for radio disturbance and immunity measuring apparatus and methods – Part 4: Uncertainty in EMC Measurements and is documented in the Shenzhen General Testing & Inspection Technology Co., Ltd quality system acc. to DIN EN ISO/IEC 17025. Furthermore, component and process variability of devices similar to that tested may result in additional deviation. The manufacturer has the sole responsibility of continued compliance of the device.

Hereafter the best measurement capability for General Testing & Inspection laboratory is reported:

Test Items	Measurement Uncertainty	Notes
Transmitter power conducted	0.57 dB	(1)
Transmitter power Radiated	2.20 dB	(1)
Conducted spurious emission 9KHz-40 GHz	1.60 dB	(1)
Radiated spurious emission 9KHz-40 GHz	2.20 dB	(1)
Conducted Emission 9KHz-30MHz	3.39 dB	(1)
Radiated Emission 30~1000MHz	4.24 dB	(1)
Radiated Emission 1~18GHz	5.16 dB	(1)
Radiated Emission 18-40GHz	5.54 dB	(1)
Occupied Bandwidth	-----	(1)

(1) This uncertainty represents an expanded uncertainty expressed at approximately the 95%

Shenzhen General Testing & Inspection Technology Co., Ltd.

1-2/F., Building 2, Jiaquan Building, Guanlan High-Tech Park, Shenzhen, Guangdong, China

Tel.: (86)755-27521059

Fax.: (86)755-27521011 Http://www.sz-ctc.org.cn



(2) confidence level using a coverage factor of  $k=1.96$ .



## 2. GENERAL INFORMATION

### 2.1. Environmental conditions

Temperature:	15~35°C
Relative Humidity:	30~75 %
Air Pressure:	950~1050mba

### 2.2. General Description of EUT

Product Name:	SPORT BLUETOOTH EARPHONE
Model/Type reference:	BHD1
Listed Model(s):	/
Power supply:	DC 3.70V from battery
External input power supply:	5VDC, 1000mA
Hardware version:	V1.0
Software version:	V1.1
<b>BT5.0+ EDR</b>	
Modulation:	GFSK, $\pi/4$ DQPSK, 8DPSK
Operation frequency:	2402MHz~2480MHz
Channel number:	79
Channel separation:	1MHz
Antenna type:	Ceramic Antenna
Antenna gain:	5.19dBi

Note: For a more detailed features description, please refer to the manufacturer's specifications or the User's Manual.

### 2.3. Description of Test Modes

The Applicant provides communication tools software (BK3256 RF Test v1.3) to control the EUT for staying in continuous transmitting (Duty Cycle more than 98%) and receiving mode for testing. There are 79 channels provided to the EUT. Channel 00/39/78 was selected to test. When the test, fully-charged battery is used

#### Operation Frequency :

Channel	Frequency (MHz)
<b>00</b>	<b>2402</b>
2	2403
:	:
38	2440
<b>39</b>	<b>2441</b>
40	2442
:	:
77	2479
<b>78</b>	<b>2480</b>

### 2.4. Measurement Instruments List

Maximum Peak Output Power / Band Edge Compliance of RF Emission / Spurious RF Conducted Emission /Hopping Require/ 20dB bandwidth					
Item	Test Equipment	Manufacturer	Model No.	Serial No.	Calibrated until
1	Spectrum Analyzer	Rohde & Schwarz	FSU	100105	Jan. 05,2019
2	RF Cable	Schwarzbeck	AH32D4	SF0150	Jan. 05,2019
3	Temporary Antenna connector	Schwarzbeck	SMA24D	ED1201	Jan. 05,2019

Note: The temporary antenna connector is soldered on the PCB board in order to perform conducted tests and this temporary antenna connector is listed in the equipment list.

Conducted Emission					
Item	Test Equipment	Manufacturer	Model No.	Serial No.	Calibrate until
1	LISN	R&S	ENV216	101112	Jan. 05,2019
2	LISN	R&S	ENV216	101113	Jan. 05,2019
3	EMI Test Receiver	R&S	ESCI	100920	Jan. 05,2019
4	Cable	Schwarzbeck	AK9515E	33156	Jan. 05,2019



Radiated Emission					
Item	Test Equipment	Manufacturer	Model No.	Serial No.	Calibrated until
1	EMI Test Receiver	R&S	ESCI	100967	Jan. 05,2019
2	High pass filter	micro-tranics	HPM50111	34202	Jan. 05,2019
3	Log-Bicon Antenna	Schwarzbeck	CBL6141A	4180	Jan. 05,2019
4	Ultra-Broadband Antenna	ShwarzBeck	BBHA9170	25841	Jan. 05,2019
5	Loop Antenna	LAPLAC	RF300	9138	Jan. 05,2019
6	Spectrum Analyzer	Rohde & Schwarz	FSU	100105	Jan. 05,2019
7	Horn Antenna	Schwarzbeck	BBHA 9120D	648	Jan. 05,2019
8	Pre-Amplifier	HP	8447D	1937A03050	Jan. 05,2019
9	Pre-Amplifier	EMCI	EMC05183 5	980075	Jan. 05,2019
10	Antenna Mast	UC	UC3000	N/A	N/A
11	Turn Table	UC	UC3000	N/A	N/A
12	Cable Below 1GHz	Schwarzbeck	AK9515E	33155	Jan. 05,2019
13	Cable Above 1GHz	Hubersuhner	SUCOFLEX1 02	DA1580	Jan. 05,2019

Note: 1. The Cal.Interval was one year.  
 2. The cable loss has calculated in test result which connection between each test instruments.

**Peripheral equipment list**

Name:	Model:	Serial	Manufacture	Remark
Notebook	Lenovo Erazer N410	/	Lenovo	Input:100-240V, 50/60Hz, 0.6A MAX Output:5V, 1A

### 3. TEST CONDITIONS AND RESULTS

#### 3.1. CONDUCTED EMISSION MEASUREMENT

##### Limit

POWER LINE CONDUCTED EMISSION

(Frequency Range 150KHz-30MHz)

FREQUENCY (MHz)	Class A (dBuV)		Class B (dBuV)	
	Quasi-peak	Average	Quasi-peak	Average
0.15 -0.5	79.00	66.00	66 - 56 *	56 - 46 *
0.50 -5.0	73.00	60.00	56.00	46.00
5.0 -30.0	73.00	60.00	60.00	50.00

Note:

- (1) The tighter limit applies at the band edges.
- (2) The limit of " \* " marked band means the limitation decreases linearly with the logarithm of the frequency in the range.

The following table is the setting of the receiver

Receiver Parameters	Setting
Attenuation	10 dB
Start Frequency	0.15 MHz
Stop Frequency	30 MHz
IF Bandwidth	9 kHz

##### Test Procedure

1. The EUT was placed 0.8 meters from the horizontal ground plane with EUT being connected to the power mains through a line impedance stabilization network (LISN). All other support equipments powered from additional LISN(s). The LISN provide 50 Ohm/ 50uH of coupling impedance for the measuring instrument.
2. Interconnecting cables that hang closer than 40 cm to the ground plane shall be folded back and forth in the center forming a bundle 30 to 40 cm long.
3. I/O cables that are not connected to a peripheral shall be bundled in the center. The end of the cable may be terminated, if required, using the correct terminating impedance. The overall length shall not exceed 1 m.Repeat above procedures until all frequency measurements have been completed.
4. LISN at least 80 cm from nearest part of EUT chassis.
5. For the actual test configuration, please refer to the related Item –EUT Test Photos.

##### Test Configuration

For the actual test configuration, please refer to the related Item –EUT Test Photos.

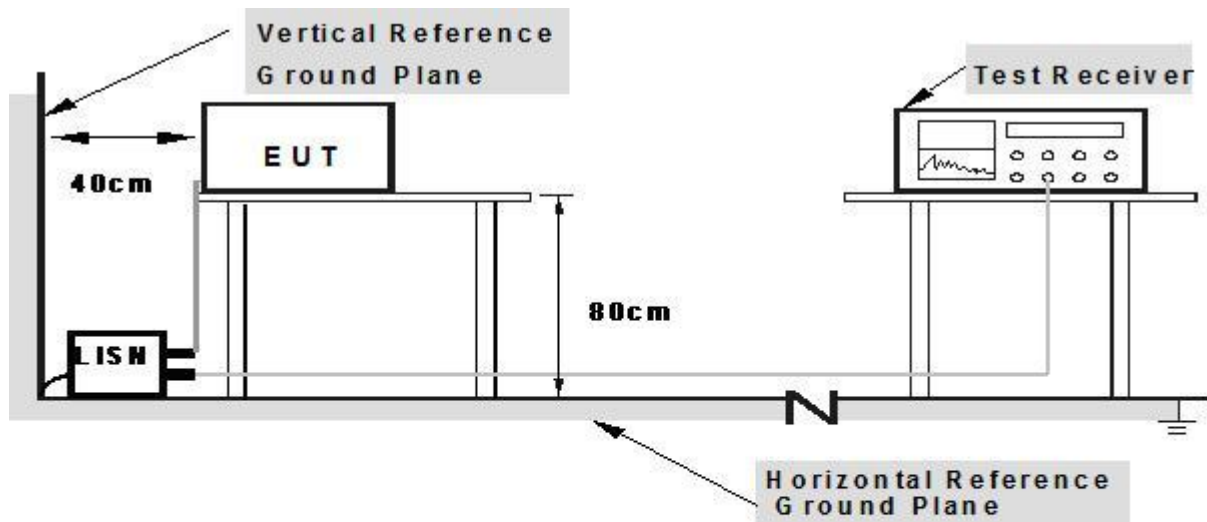

**Note: 1. Support units were connected to second LISN.**

**2. Both of LISNs (AMN) are 80 cm from EUT and at least 80 from other units and other metal planes**



**TEST RESULTS**

Note: We tested three channels for each mode and recorded worst case at low channel of GFSK Mode.

For Model: BHD1 Power:120VAC

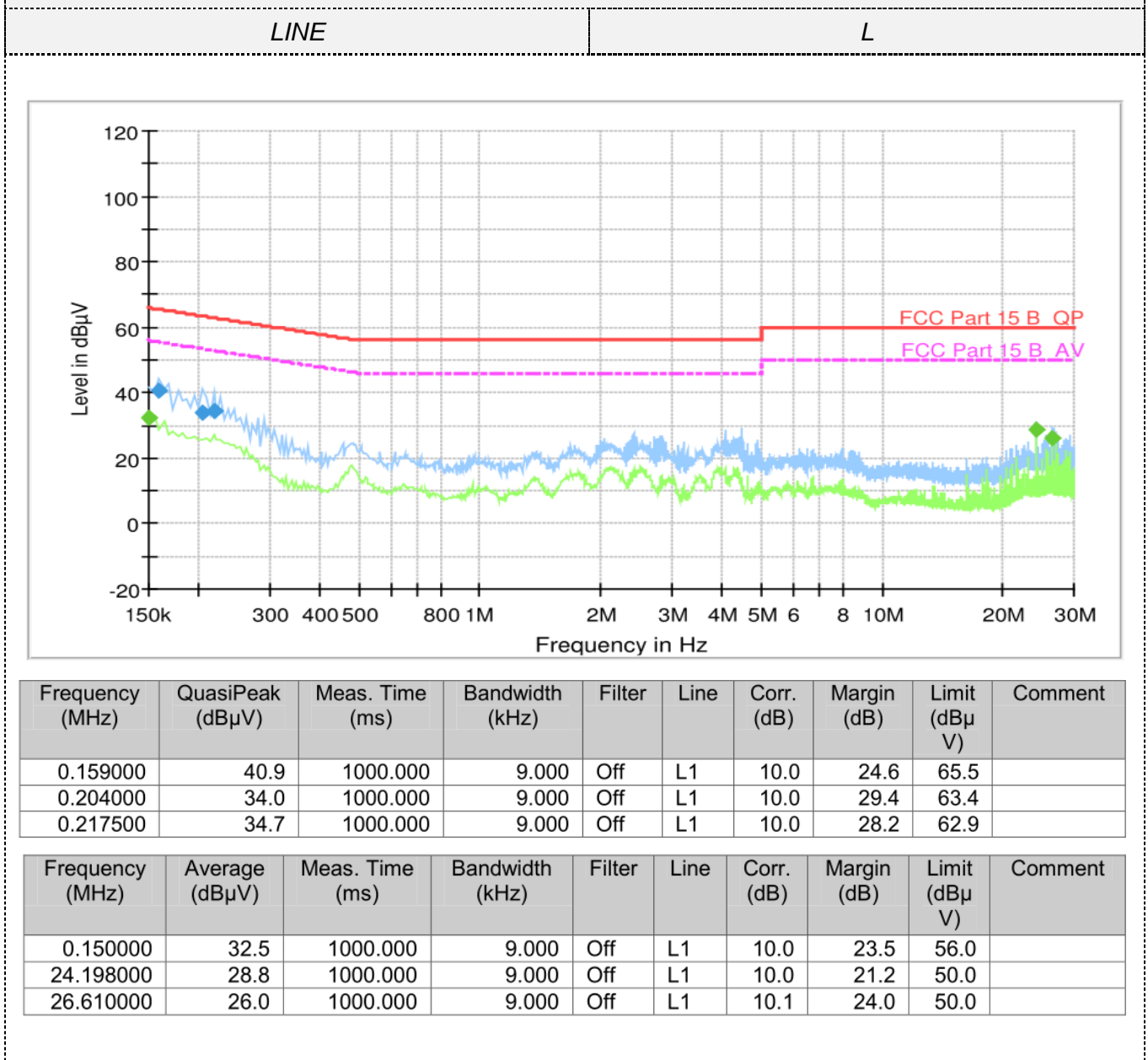

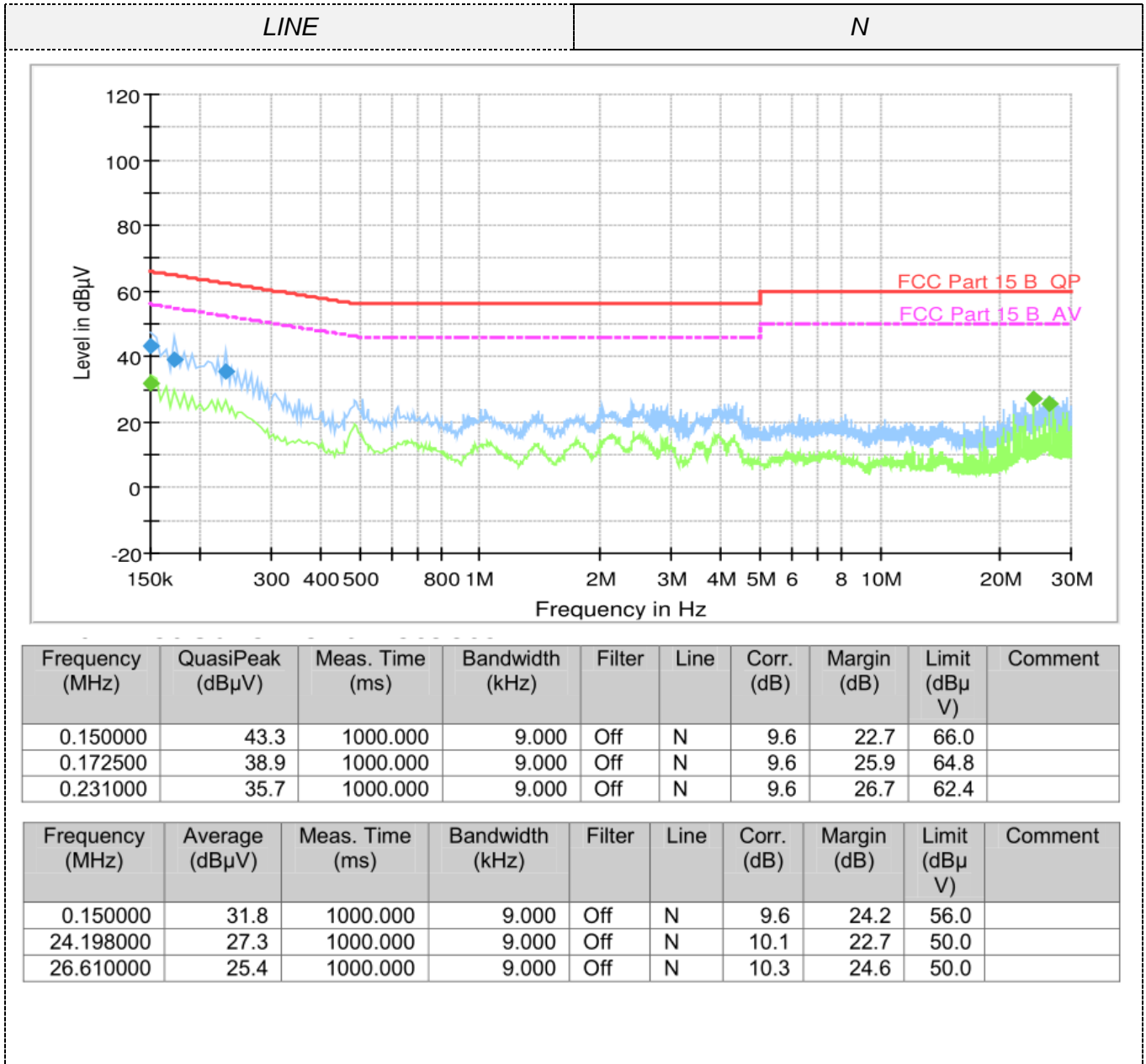



## 3.2. Radiated Emission

### Limit

For intentional device, according to § 15.209(a), the general requirement of field strength of radiated emission from intentional radiators at a distance of 3 meters shall not exceed the following table. According to § 15.247(d), in any 100kHz bandwidth outside the frequency band in which the EUT is operating, the radio frequency power that is produced by the intentional radiator shall be at least 20dB below that in the 100kHz bandwidth within the band that contains the highest level of desired power.

The frequency spectrum above 1 GHz for Transmitter was investigated. All emission not reported are much lower than the prescribed limits. Set the RBW=1MHz, VBW=3MHz for Peak Detector while the RBW=1MHz, VBW=10Hz for Average Detector, Readings are both peak and average values. The pre-test have done for the EUT in three axes and found the worst emission at position shown in test setup photos.

Frequency (MHz)	Distance (Meters)	Radiated (dBuV/m)	Radiated ( $\mu$ V/m)
0.009-0.49	3	$20\log(2400/F(\text{KHz}))+40\log(300/3)$	$2400/F(\text{KHz})$
0.49-1.705	3	$20\log(24000/F(\text{KHz}))+40\log(30/3)$	$24000/F(\text{KHz})$
1.705-30	3	$20\log(30)+40\log(30/3)$	30
30-88	3	40.0	100
88-216	3	43.5	150
216-960	3	46.0	200
Above 960	3	54.0	500

### Test Procedure

6. For below 1GHz test, The EUT was placed on a turn table which is 0.8m above ground plane; For Above 1GHz test, The EUT was placed on a turn table which is 1.5m above ground plane;
7. Maximum procedure was performed by raising the receiving antenna from 1m to 4m and rotating the turn table from 0° to 360° to acquire the highest emissions from EUT
8. And also, each emission was to be maximized by changing the polarization of receiving antenna both horizontal and vertical.
9. Repeat above procedures until all frequency measurements have been completed.

Note: For the radiated emission test above 1GHz:

Place the measurement antenna away from each area of the EUT determined to be a source of emissions at the specified measurement distance, while keeping the measurement antenna aimed at the source of emissions at each frequency of significant emissions, with polarization oriented for maximum response. The measurement antenna may have to be higher or lower than the EUT, depending on the radiation pattern of the emission and staying aimed at the emission source for receiving the maximum signal. The final measurement antenna elevation shall be that which maximizes the emissions. The measurement antenna elevation for maximum emissions shall be restricted to a range of heights of from 1 m to 4 m above the ground or reference ground plane.



### Field Strength Calculation

The field strength is calculated by adding the Antenna Factor and Cable Factor and subtracting the Amplifier Gain and Duty Cycle Correction Factor (if any) from the measured reading. The basic equation with a sample calculation is as follows:

$$FS = RA + AF + CL - AG$$

Where FS = Field Strength	CL = Cable Attenuation Factor (Cable Loss)
RA = Reading Amplitude	AG = Amplifier Gain
AF = Antenna Factor	

For example

Frequency (MHz)	FS (dBμV/m)	RA (dBμV/m)	AF (dB)	CL (dB)	AG (dB)	Transd (dB)
150.00	40	58.1	12.2	1.6	31.90	-18.1

$$\text{Transd} = \text{AF} + \text{CL} - \text{AG}$$

### Test Configuration

For the actual test configuration, please refer to the related Item –EUT Test Photos.

#### Frequency range 9 KHz – 30MHz

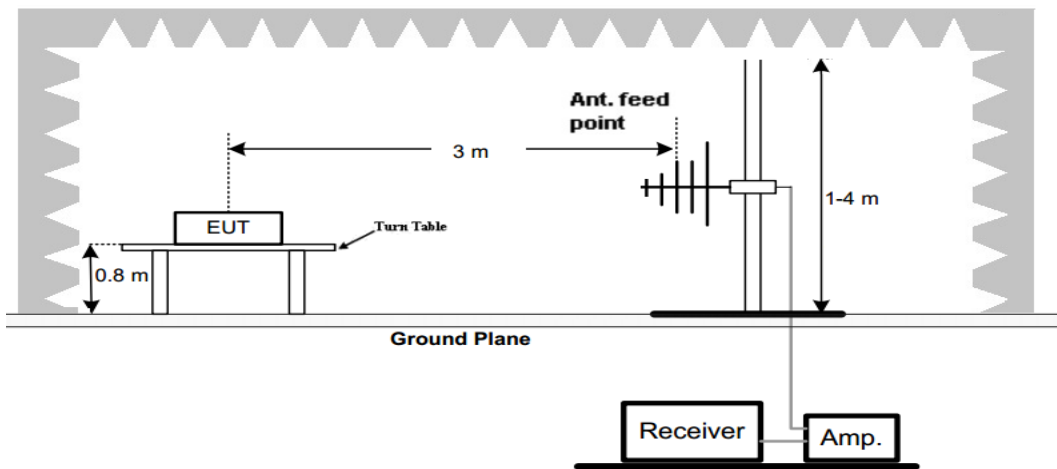
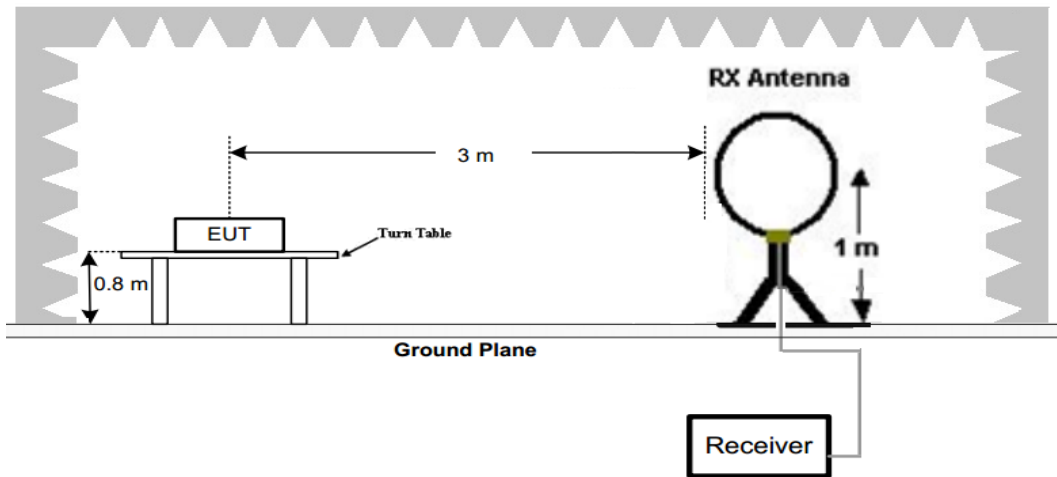

#### Frequency range 30MHz – 1000MHz

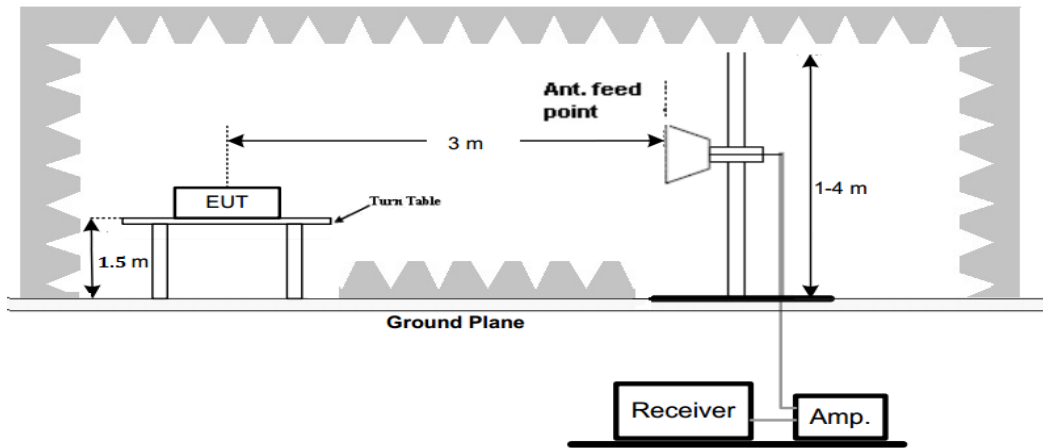

### Frequency range above 1GHz-25GHz

#### Test Results

Remark:

1. We measured Radiated Emission at GFSK,  $\pi/4$  DQPSK and 8DPSK mode from 9 KHz to 25GHz and recorded worst case at Low channel of GFSK mode below 1GHz.
2. By preliminary testing and verifying three axis (X, Y and Z) position of EUT transmitted status, it was found that "Z axis" position was the worst, and test data recorded in this report.



**For Model: BHD1**  
**For 9 KHz-30MHz**

The test results of 9kHz-30MHz is attenuated more than 20dB below the permissible limits, so the results don't record in the report.

**For 30MHz-1GHz**

**Horizontal**

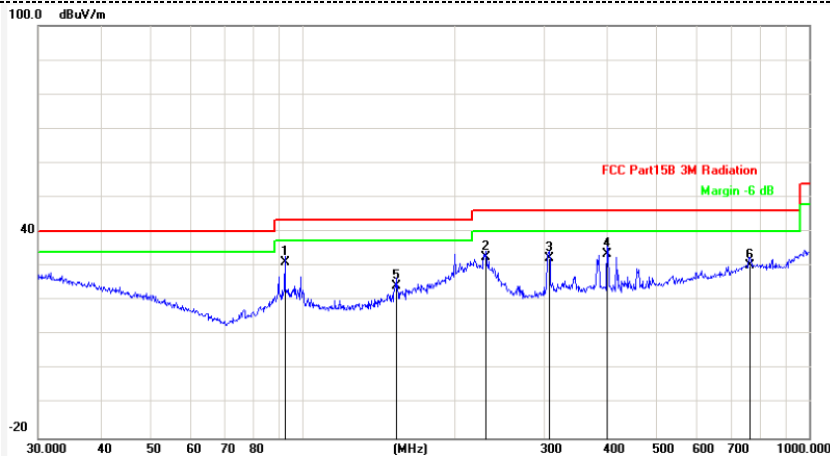

No.	Frequency (MHz)	Factor (dB/m)	Reading (dBuV)	Level (dBuV/m)	Limit (dBuV/m)	Margin (dB)	Detector	Height (cm)	Azimuth ( )	P/F	Remark
1	92.1386	-14.65	45.85	31.20	43.50	-12.30	QP			P	
2	230.0985	-12.66	45.26	32.60	46.00	-13.40	QP			P	
3	306.7536	-11.38	43.68	32.30	46.00	-13.70	QP			P	
4	399.0300	-8.51	42.11	33.60	46.00	-12.40	QP			P	
5	152.6639	-15.05	39.35	24.30	43.50	-19.20	QP			P	
6	763.3757	-1.68	31.88	30.20	46.00	-15.80	QP			P	

**Vertical**

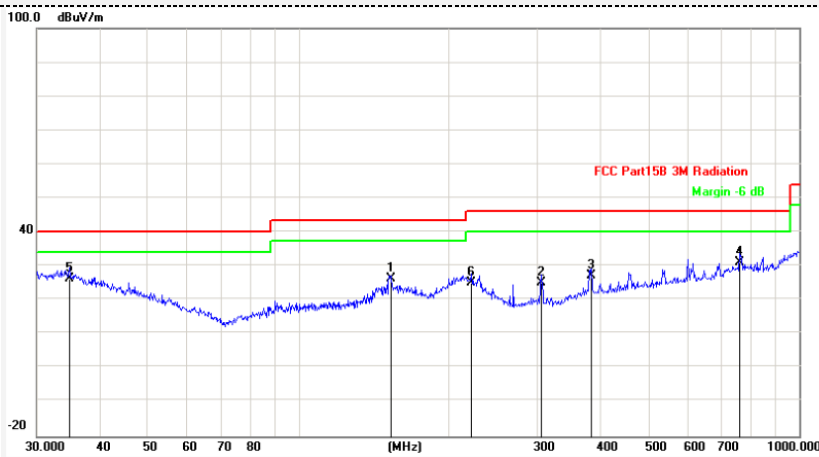

No.	Frequency (MHz)	Factor (dB/m)	Reading (dBuV)	Level (dBuV/m)	Limit (dBuV/m)	Margin (dB)	Detector	Height (cm)	Azimuth ( )	P/F	Remark
1	152.6639	-15.05	41.35	26.30	43.50	-17.20	QP			P	
2	305.6797	-11.41	36.61	25.20	46.00	-20.80	QP			P	
3	383.9318	-9.33	36.63	27.30	46.00	-18.70	QP			P	
4	760.7033	-1.72	32.82	31.10	46.00	-14.90	QP			P	
5	34.8821	-5.90	32.20	26.30	40.00	-13.70	QP			P	
6	221.3918	-12.37	37.57	25.20	46.00	-20.80	QP			P	

## REMARKS:

1. Emission level (dBuV/m) = Raw Value (dBuV) + Correction Factor (dB/m)
2. Correction Factor (dB/m) = Antenna Factor (dB/m) + Cable Factor (dB) - Pre-amplifier Factor
3. Margin value = Limit value - Emission level.
4. -- Mean the PK detector measured value is below average limit.
5. The other emission levels were very low against the limit.

**Above 1GHz emission please refer to C180313Z01-RP1 report**



### 3.3. Maximum Peak Output Power

#### Limit

The Maximum Peak Output Power Measurement is 30dBm.

#### Test Procedure

Remove the antenna from the EUT and then connect a low loss RF cable from the antenna port to the spectrum. Set the spectrum RBW: 3MHz; VBW: 10MHz; Detector: Peak; Span: 10MHz.

#### Test Configuration

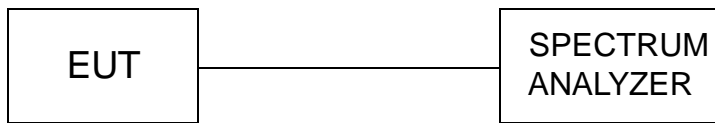

#### Test Results

Type	Channel	Output power (dBm)	Limit (dBm)	Result
GFSK	00	-2.34	30.00	Pass
	39	-0.59		
	78	0.30		
π/4DQPSK	00	-0.07	21.00	Pass
	39	0.81		
	78	1.20		
8DPSK	00	-0.07	21.00	Pass
	39	0.75		
	78	1.26		

Note: 1.The test results including the cable lose.

Test plot as follows:

### GFSK Modulation

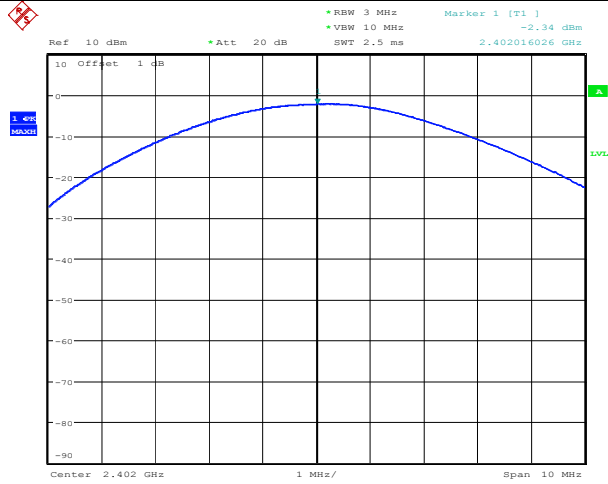

Date: 6.MAR.2018 11:09:57

### CH00

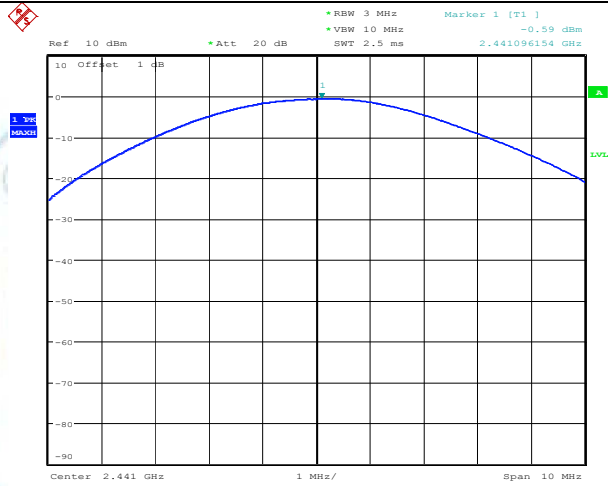

Date: 6.MAR.2018 11:10:26

### CH39

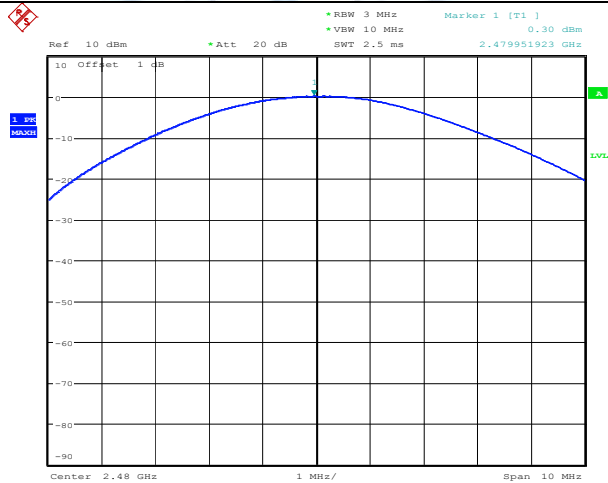

Date: 6.MAR.2018 11:11:21

### CH78

### $\pi/4$ DQPSK Modulation

Shenzhen General Testing & Inspection Technology Co., Ltd.

1-2/F., Building 2, Jiaquan Building, Guanlan High-Tech Park, Shenzhen, Guangdong, China

Tel.: (86)755-27521059

Fax.: (86)755-27521011

Http://www.sz-ctc.org.cn



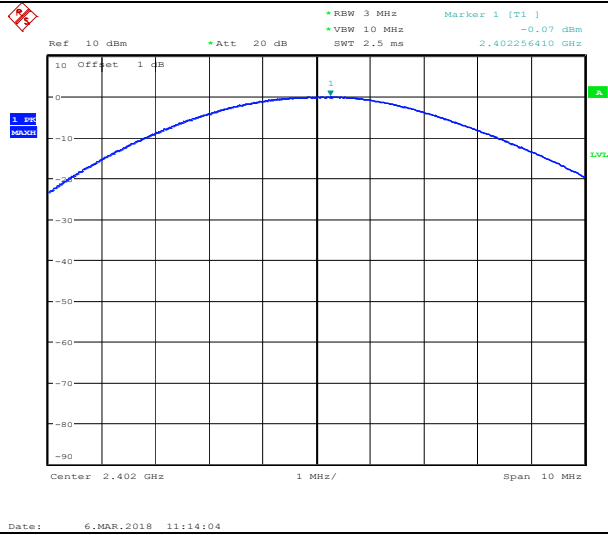

CH00

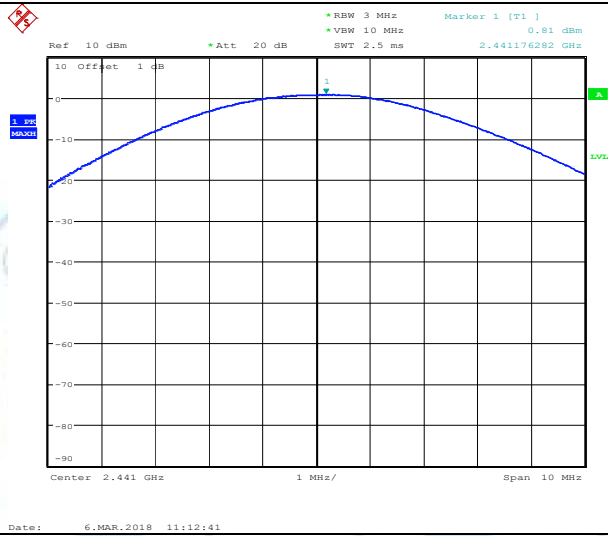

CH39

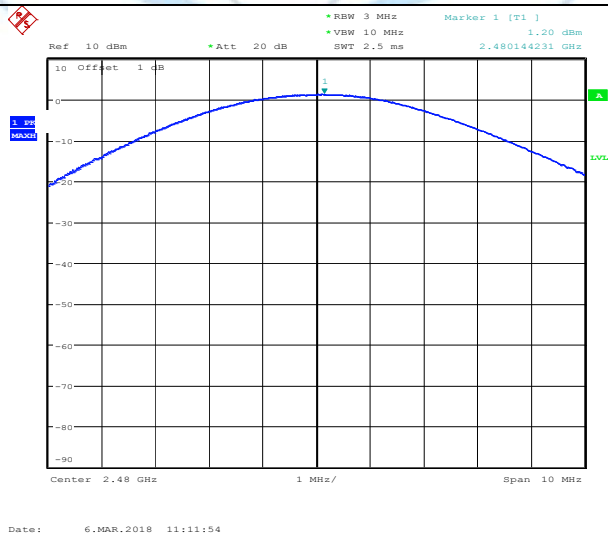

CH78

8DPSK Modulation

Shenzhen General Testing & Inspection Technology Co., Ltd.

1-2/F., Building 2, Jiaquan Building, Guanlan High-Tech Park, Shenzhen, Guangdong, China  
 Tel.: (86)755-27521059    Fax.: (86)755-27521011    Http://www.sz-ctc.org.cn



中国国家认证认可监督管理委员会  
 Certification and Accreditation Administration of the People's Republic of China

For anti-fake verification, please visit the official website of Certification and Accreditation Administration of the People's Republic of China : [yz.cncaic.cn](http://yz.cncaic.cn)

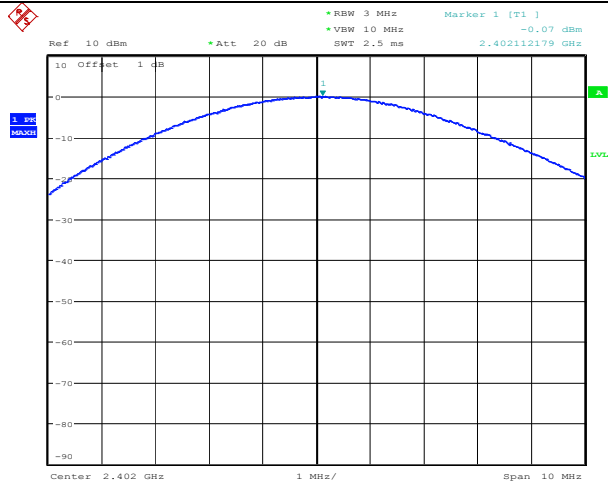

Date: 6.MAR.2018 11:14:36

CH00

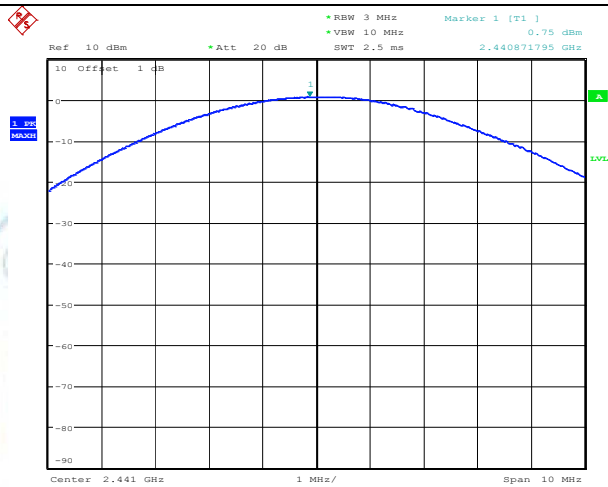

Date: 6.MAR.2018 11:15:07

CH39

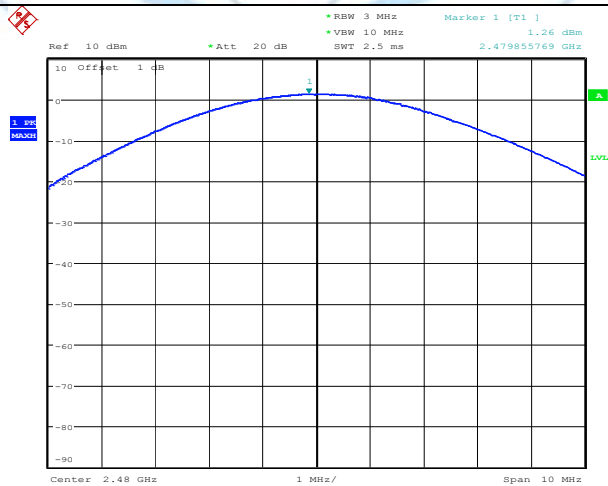

Date: 6.MAR.2018 11:15:46

CH78

### 3.4. 20dB Bandwidth

#### Limit

Shenzhen General Testing & Inspection Technology Co., Ltd.

1-2/F., Building 2, Jiaquan Building, Guanlan High-Tech Park, Shenzhen, Guangdong, China

Tel.: (86)755-27521059

Fax.: (86)755-27521011

Http://www.sz-ctc.org.cn



For anti-fake verification, please visit the official website of Certification and Accreditation Administration of the People's Republic of China : [yz.cncaic.cn](http://yz.cncaic.cn)

For frequency hopping systems operating in the 2400MHz-2483.5MHz no limit for 20dB bandwidth.

**Test Procedure**

The transmitter output was connected to the spectrum analyzer through a low loss RF cable. The bandwidth of the fundamental frequency was measured by spectrum analyzer with 30 KHz RBW and 100 KHz VBW.

The 20dB bandwidth is defined as the total spectrum the power of which is higher than peak power minus 20dB.

**Test Configuration**

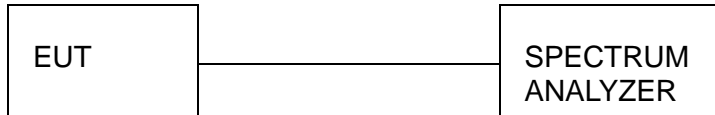

**Test Results**

Modulation	Channel	20dB bandwidth (MHz)	99% OBW(MHz)	Result
GFSK	CH00	0.822	0.889	Pass
	CH39	0.837	0.899	
	CH78	0.827	0.894	
π/4DQPSK	CH00	1.250	1.197	
	CH39	1.255	1.245	
	CH78	1.250	1.255	
8DPSK	CH00	1.231	1.192	
	CH39	1.226	1.221	
	CH78	1.240	1.231	

Test plot as follows:

### GFSK Modulation

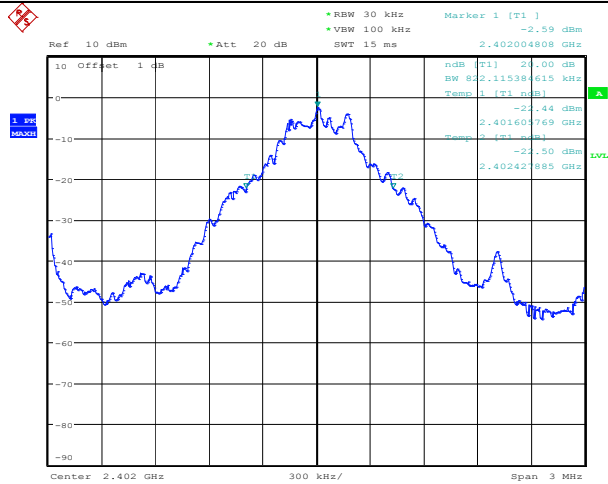

Date: 6.MAR.2018 11:28:30

### CH00

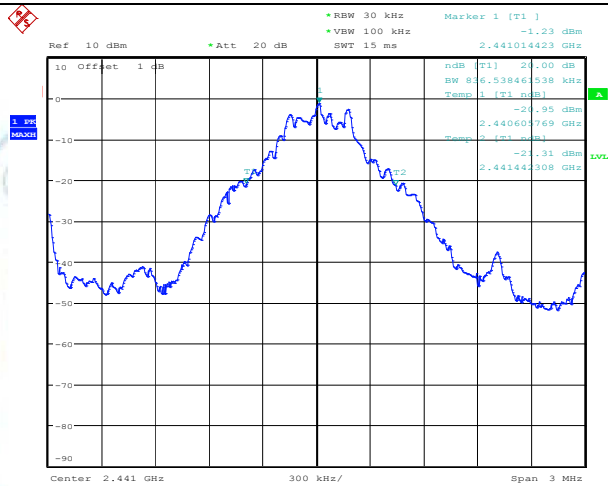

Date: 6.MAR.2018 11:27:45

### CH39

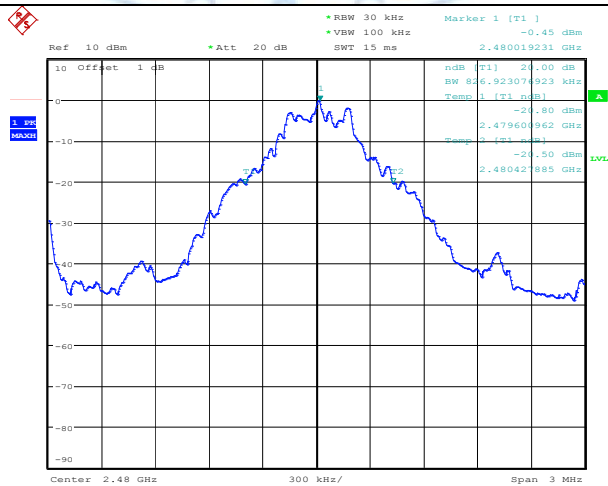

Date: 6.MAR.2018 11:27:02

### CH78

### $\pi/4$ DQPSK Modulation

Shenzhen General Testing & Inspection Technology Co., Ltd.

1-2/F., Building 2, Jiaquan Building, Guanlan High-Tech Park, Shenzhen, Guangdong, China  
 Tel.: (86)755-27521059 Fax.: (86)755-27521011 Http://www.sz-ctc.org.cn

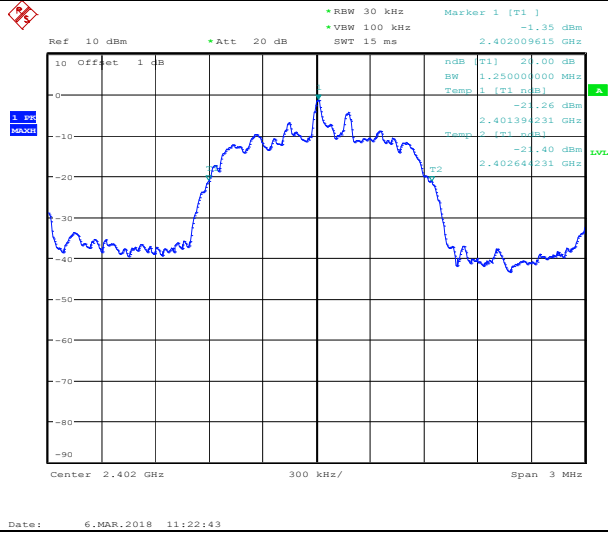

CH00

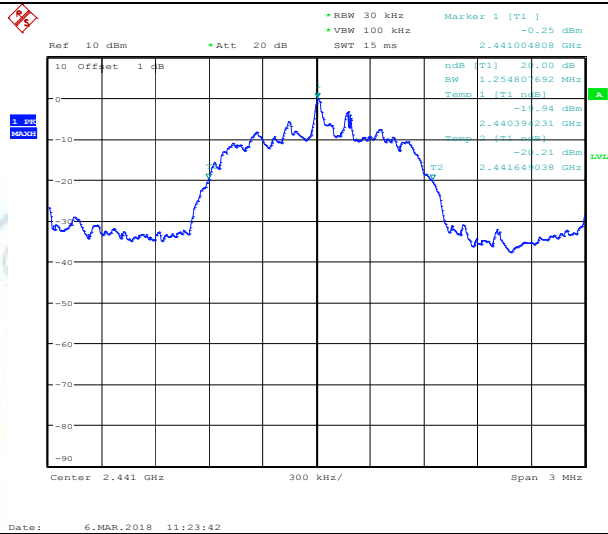

CH39

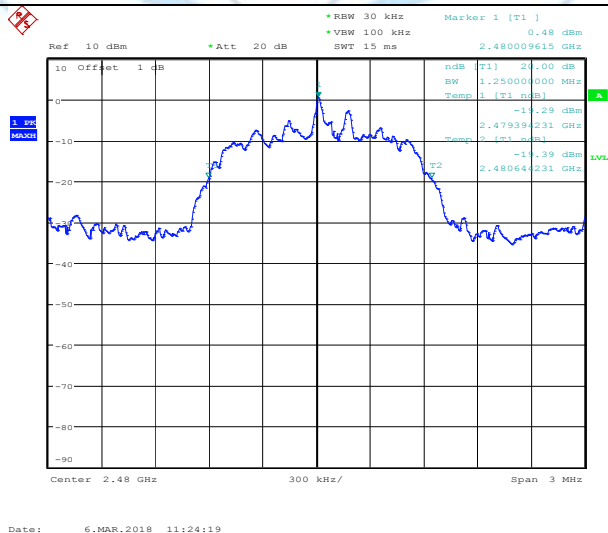

CH78

8DPSK Modulation

Shenzhen General Testing & Inspection Technology Co., Ltd.

1-2/F., Building 2, Jiaquan Building, Guanlan High-Tech Park, Shenzhen, Guangdong, China

Tel.: (86)755-27521059

Fax.: (86)755-27521011

Http://www.sz-ctc.org.cn



For anti-fake verification, please visit the official website of Certification and Accreditation Administration of the People's Republic of China : [yz.cncaic.cn](http://yz.cncaic.cn)

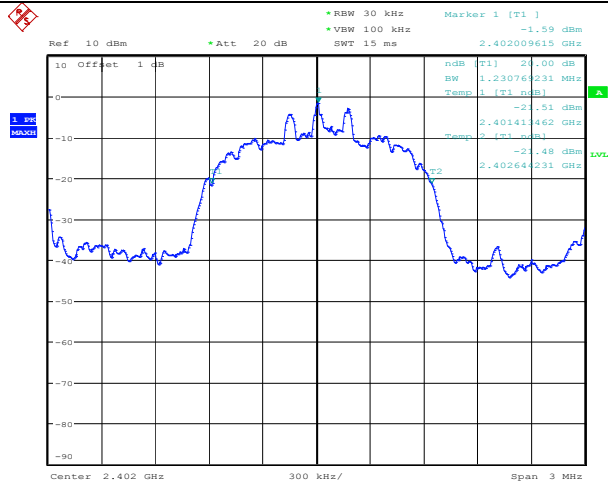

Date: 6.MAR.2018 11:21:25

CH00

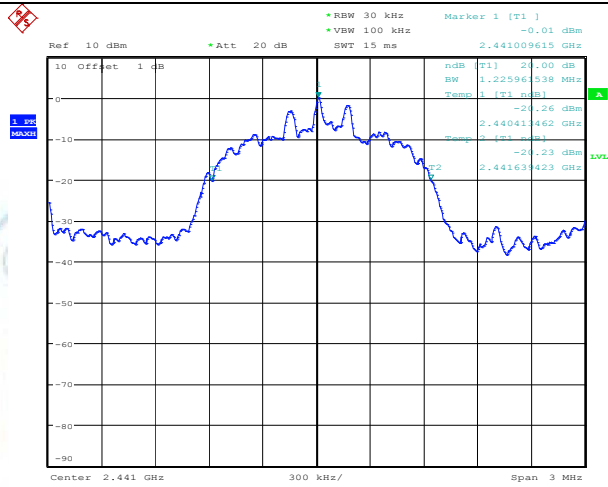

Date: 6.MAR.2018 11:20:35

CH39

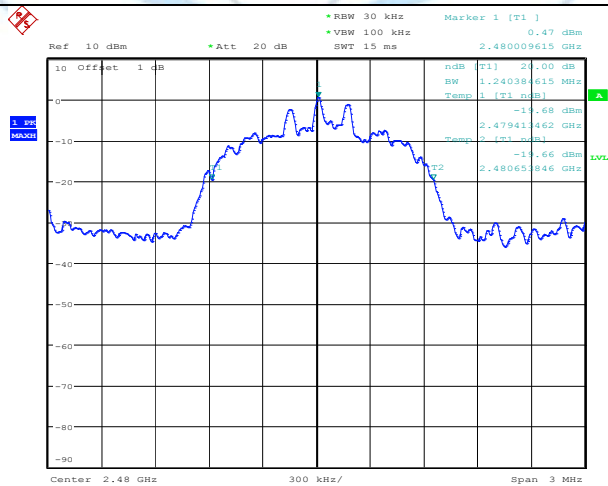

Date: 6.MAR.2018 11:19:19

CH78



### 3.5. Band Edge

#### Applicable Standard

In any 100 kHz bandwidth outside the frequency band in which the spread spectrum or digitally modulated intentional radiator is operating, the radio frequency power that is produced by the intentional radiator shall be at least 20 dB below that in the 100 kHz bandwidth within the band that contains the highest level of the desired power, based on either an RF conducted or a radiated measurement, provided the transmitter demonstrates compliance with the peak conducted power limits. If the transmitter complies with the conducted power limits based on the use of RMS averaging over a time interval, as permitted under paragraph (b)(3) of this section, the attenuation required under this paragraph shall be 30 dB instead of 20 dB. Attenuation below the general limits specified in §15.209(a) is not required. In addition, radiated emissions which fall in the restricted bands, as defined in §15.205(a), must also comply with the radiated emission limits specified in §15.209(a) (see §15.205(c)).

#### Test Procedure

##### **Test Procedure for conducted method**

1. Remove the antenna from the EUT and then connect to a low loss RF cable from the antenna port to a spectrum analyzer
2. Turn on the EUT and make it operate in transmitting mode. Then set it to Low Channel and High Channel within its operating range, and make sure the instrument is operated in its linear range.
3. Set spectrum analyzer RBW =100 kHz and VBW=300 kHz
4. Use spectrum analyzer Maxhold function to allow trace to fully stabilize
5. Marker the highest point which fall into restricted frequency bands
6. Repeat above procedures until all measured frequencies were complete.

##### **Test Procedure for radiated method**

1. The EUT was placed on the top of a rotating table 0.8 meters above the ground at a 3 meter anechoic chamber. The table was rotated 360 degrees to determine the position of the highest radiation.
2. The EUT was set 3 meters away from the interference receiving antenna, which was mounted on the top of a variable height antenna tower.
3. The antenna height is varied from one meter to four meters above the ground to determine the maximum value of the field strength. Both horizontal and vertical polarizations of the antenna are set to make the measurement.
4. For each suspected emission, the EUT was arranged to its worst case and then the antenna was tuned to heights from 1 meter to 4 meters and the rotatable table was turned from 0 degrees to 360 degrees to find the maximum reading.
5. The test-receiver system was set to Peak Detect Function and Specified Bandwidth with Maximum Hold Mode.
6. Place a marker at the end of the restricted band closest to the transmit frequency to show compliance. Also measure any emissions in the restricted bands. Save the spectrum analyzer plot. Repeat for each power and modulation for lowest and highest channel
7. Test the EUT in the lowest channel, the highest channel
8. The radiation measurements are performed in X, Y, Z axis positioning. And found the X axis positioning which it is worse case, only the test worst case mode is recorded in the report.
9. Repeat above procedures until all frequencies measured was complete.

#### **TEST RESULTS**

Remark: we measured all conditions (DH1, DH3, DH5) and recorded worst case at DH5

**A. Conducted Bandedge Measurement**

**GFSK**

Frequency (MHz)	Delta Peak to Band emission (dBc)	Hopping Mode	Limit (dBc)	Verdict
2399.935	-61.04	OFF	20	PASS
2387.096	-59.92	ON	20	PASS
2484.008	-50.19	OFF	20	PASS
2506.038	-51.41	ON	20	PASS

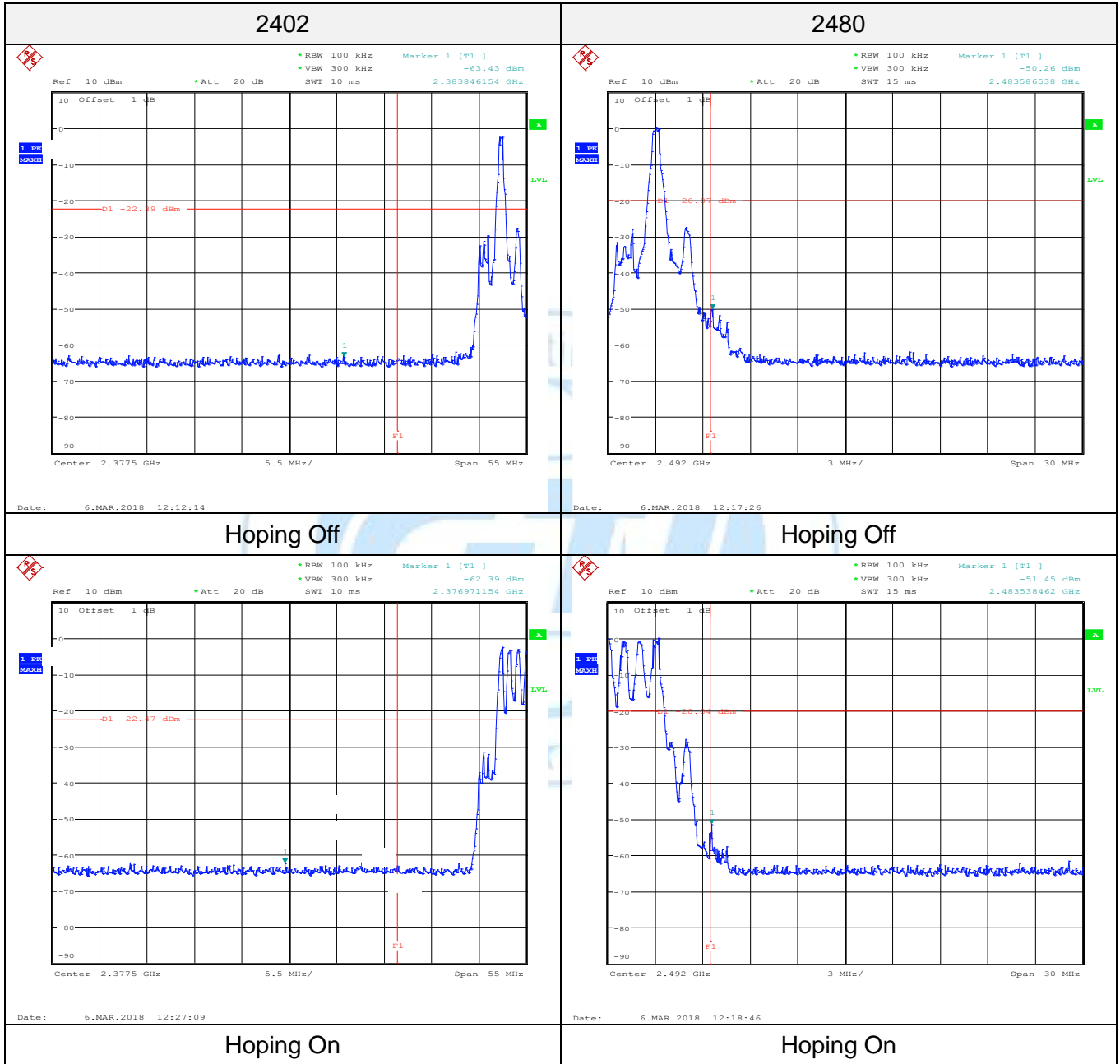

$\pi/4$ DQPSK

Frequency (MHz)	Delta Peak to Band emission (dBc)	Hopping Mode	Limit (dBc)	Verdict
2389.232	-61.31	OFF	20	PASS
2389.376	-58.34	ON	20	PASS
2484.968	-46.55	OFF	20	PASS
2484.656	-50.67	ON	20	PASS

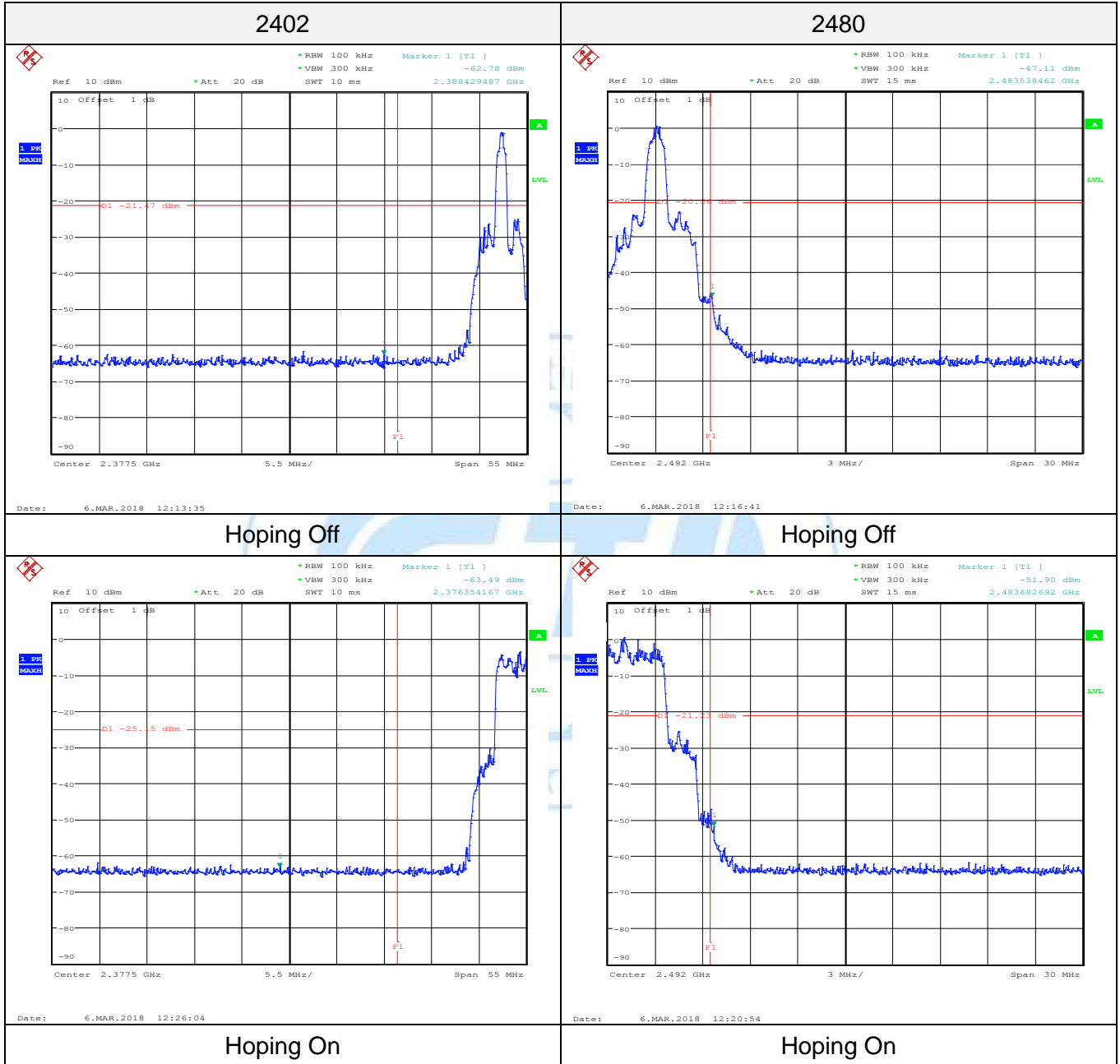

8DPSK

Frequency (MHz)	Delta Peak to Band emission (dBc)	Hopping Mode	Limit (dBc)	Verdict
2384.480	-60.33	OFF	20	PASS
2388.656	-61.25	ON	20	PASS
2483.528	-48.45	OFF	20	PASS
2483.600	-51.57	ON	20	PASS

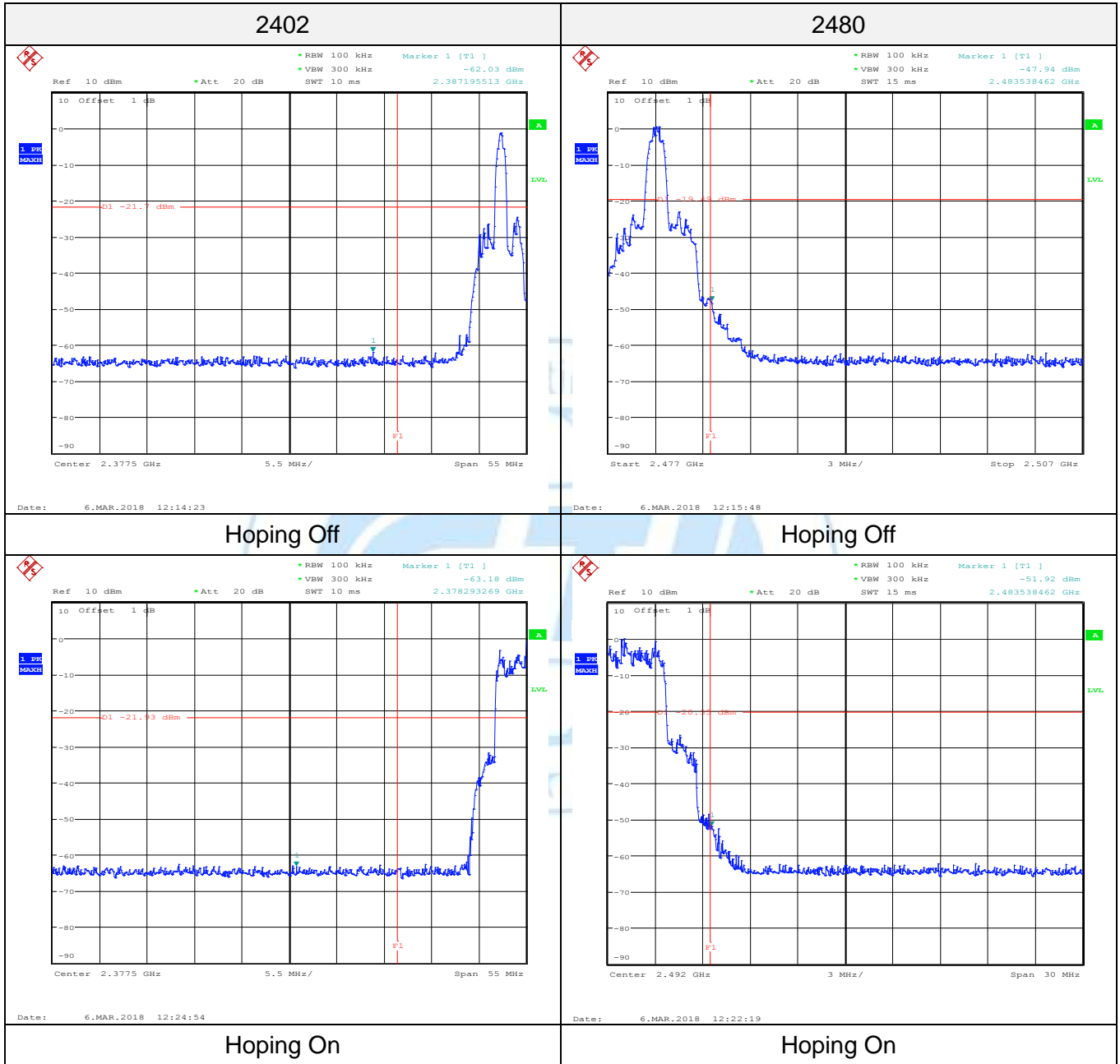

Shenzhen General Testing & Inspection Technology Co., Ltd.

1-2/F., Building 2, Jiaquan Building, Guanlan High-Tech Park, Shenzhen, Guangdong, China  
 Tel.: (86)755-27521059 Fax.: (86)755-27521011 Http://www.sz-ctc.org.cn



For anti-fake verification, please visit the official website of Certification and Accreditation Administration of the People's Republic of China : [yz.cncaic.cn](http://yz.cncaic.cn)

**A. Radiated measurements**  
For Model:BHD1

**GFSK**

2402MHz									
Polar	Frequency	Meter Reading	Pre-amplifier	Cable Loss	Antenna Factor	Emission Level	Limits	Margin	Detector
(H/V)	(MHz)	(dBuV)	(dB)	(dB)	(dB/m)	(dBuV/m)	(dBuV/m)	(dB)	Type
H	2390.00	43.96	36.12	3.32	27.5	38.66	74	-35.34	PK
H	2390.00	35.12	36.12	3.32	27.5	29.82	54	-24.18	AV
V	2390.00	45.23	36.12	3.32	27.5	39.93	74	-34.07	PK
V	2390.00	38.12	36.12	3.32	27.5	32.82	54	-21.18	AV
2480MHz									
Polar	Frequency	Meter Reading	Pre-amplifier	Cable Loss	Antenna Factor	Emission Level	Limits	Margin	Detector
(H/V)	(MHz)	(dBuV)	(dB)	(dB)	(dB/m)	(dBuV/m)	(dBuV/m)	(dB)	Type
H	2483.50	43.35	36.12	3.32	27.5	38.05	74	-35.95	PK
H	2483.50	36.78	36.12	3.32	27.5	31.48	54	-22.52	AV
V	2483.50	46.98	36.12	3.32	27.5	41.68	74	-32.32	PK
V	2483.50	37.43	36.12	3.32	27.5	32.13	54	-21.87	AV

**$\pi/4$ QPSK**

2402MHz									
Polar	Frequency	Meter Reading	Pre-amplifier	Cable Loss	Antenna Factor	Emission Level	Limits	Margin	Detector
(H/V)	(MHz)	(dBuV)	(dB)	(dB)	(dB/m)	(dBuV/m)	(dBuV/m)	(dB)	Type
H	2390.00	44.12	36.12	3.32	27.5	38.82	74	-35.18	PK
H	2390.00	35.76	36.12	3.32	27.5	30.46	54	-23.54	AV
V	2390.00	45.34	36.12	3.32	27.5	40.04	74	-33.96	PK
V	2390.00	36.98	36.12	3.32	27.5	31.68	54	-22.32	AV
2480MHz									
Polar	Frequency	Meter Reading	Pre-amplifier	Cable Loss	Antenna Factor	Emission Level	Limits	Margin	Detector
(H/V)	(MHz)	(dBuV)	(dB)	(dB)	(dB/m)	(dBuV/m)	(dBuV/m)	(dB)	Type
H	2483.50	43.54	36.12	3.32	27.5	38.24	74	-35.76	PK
H	2483.50	35.15	36.12	3.32	27.5	29.85	54	-24.15	AV
V	2483.50	44.34	36.12	3.32	27.5	39.04	74	-34.96	PK
V	2483.50	35.47	36.12	3.32	27.5	30.17	54	-23.83	AV

**8DPSK**

2402MHz									
Polar	Frequency	Meter Reading	Pre-amplifier	Cable Loss	Antenna Factor	Emission Level	Limits	Margin	Detector
(H/V)	(MHz)	(dBuV)	(dB)	(dB)	(dB/m)	(dBuV/m)	(dBuV/m)	(dB)	Type
H	2390.00	45.26	36.12	3.32	27.5	39.96	74	-34.04	PK
H	2390.00	37.12	36.12	3.32	27.5	31.82	54	-22.18	AV
V	2390.00	47.38	36.12	3.32	27.5	42.08	74	-31.92	PK
V	2390.00	39.56	36.12	3.32	27.5	34.26	54	-19.74	AV
2480MHz									
Polar	Frequency	Meter Reading	Pre-amplifier	Cable Loss	Antenna Factor	Emission Level	Limits	Margin	Detector
(H/V)	(MHz)	(dBuV)	(dB)	(dB)	(dB/m)	(dBuV/m)	(dBuV/m)	(dB)	Type
H	2483.50	44.32	36.12	3.32	27.5	39.02	74	-34.98	PK
H	2483.50	34.58	36.12	3.32	27.5	29.28	54	-24.72	AV
V	2483.50	45.23	36.12	3.32	27.5	39.93	74	-34.07	PK
V	2483.50	36.69	36.12	3.32	27.5	31.39	54	-22.61	AV

### 3.6. Frequency Separation

#### LIMIT

According to 15.247(a)(1), frequency hopping systems shall have hopping channel carrier frequencies separated by minimum of 25KHz or the  $2/3 * 20\text{dB}$  bandwidth of the hopping channel, whichever is greater.

#### TEST PROCEDURE

The transmitter output was connected to the spectrum analyzer through a low loss RF cable. The bandwidth of the fundamental frequency was measured by spectrum analyzer with 30 KHz RBW and 100KHz VBW.

#### TEST CONFIGURATION

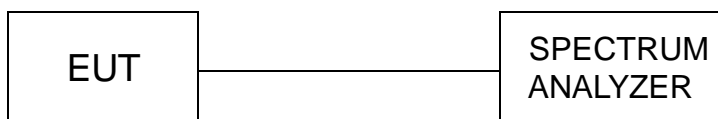

#### TEST RESULTS

Modulation	Channel	Channel Separation (MHz)	Limit(MHz)	Result
GFSK	CH00	1.000	25KHz or $2/3 * 20\text{dB}$ bandwidth	Pass
	CH01			
$\pi/4$ DQPSK	CH00	1.000	25KHz or $2/3 * 20\text{dB}$ bandwidth	Pass
	CH01			
8DPSK	CH00	1.010	25KHz or $2/3 * 20\text{dB}$ bandwidth	Pass
	CH01			

Note:

We have tested all mode at high, middle and low channel, and recorded worst case at middle

#### Test plot as follows:



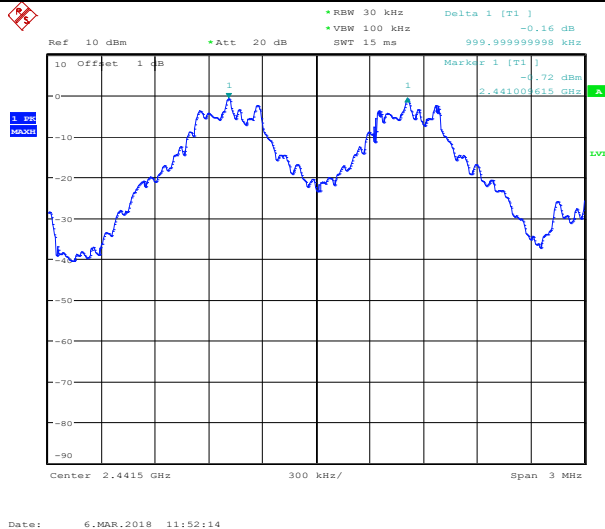

Date: 6.MAR.2018 11:52:14

GFSK

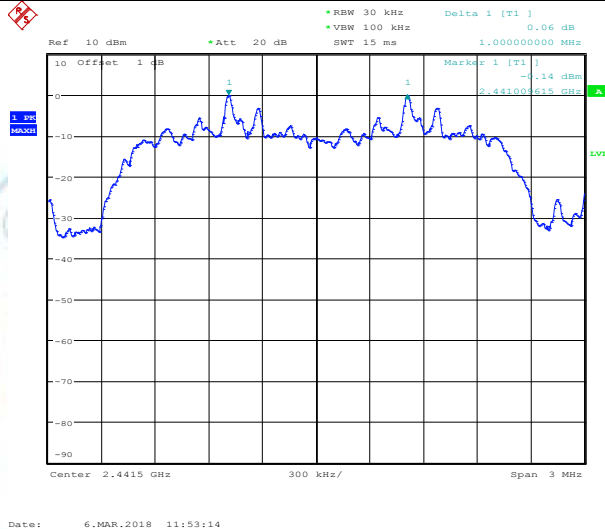

Date: 6.MAR.2018 11:53:14

$\pi/4$ DQPSK

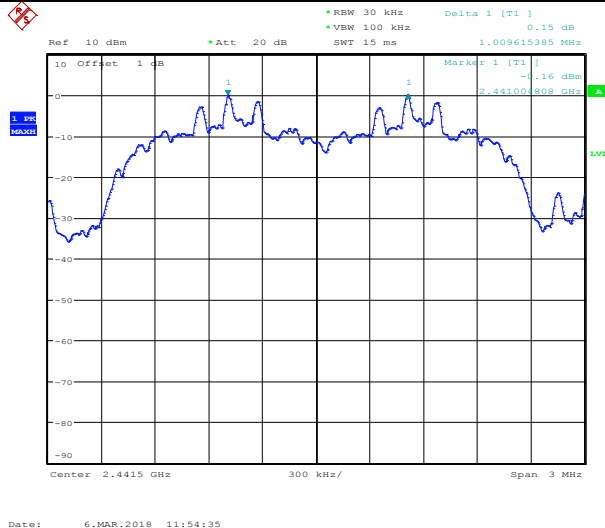

Date: 6.MAR.2018 11:54:35

8DPSK

### 3.7. Number of hopping frequency

#### Limit

Frequency hopping systems in the 2400–2483.5 MHz band shall use at least 15 channels.

#### Test Procedure

The transmitter output was connected to the spectrum analyzer through a low loss RF cable. Set spectrum analyzer start 2400MHz to 2483.5MHz with 100 KHz RBW and 300 KHz VBW.

#### Test Configuration

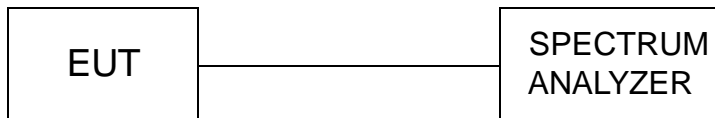

#### Test Results

Modulation	Number of Hopping Channel	Limit	Result
GFSK	79	≥15	Pass
$\pi/4$ DQPSK	79		
8DPSK	79		

#### Test plot as follows:



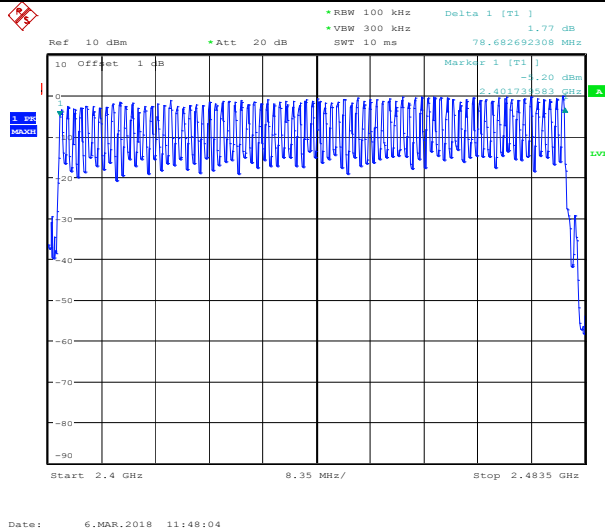

GFSK Modulation

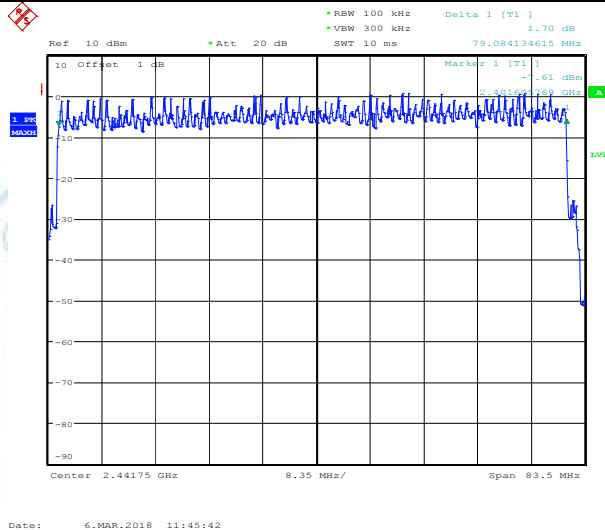

$\pi/4$ DQPSK Modulation

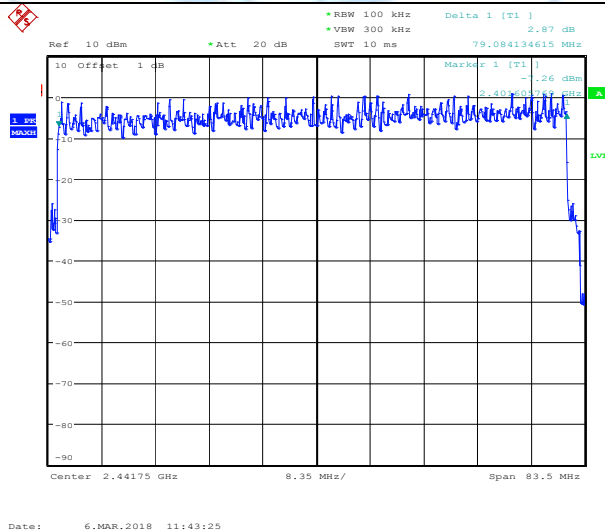

8DPSK Modulation

### 3.8. Time of Occupancy (Dwell Time)

#### Limit

The average time of occupancy on any channel shall not be greater than 0.4 seconds within a period of 0.4 seconds multiplied by the number of hopping channels employed.

#### Test Procedure

The transmitter output was connected to the spectrum analyzer through a low loss RF cable. Set center frequency of spectrum analyzer=operating frequency with 1MHz RBW and 3MHz VBW, Span 0Hz.

#### Test Configuration

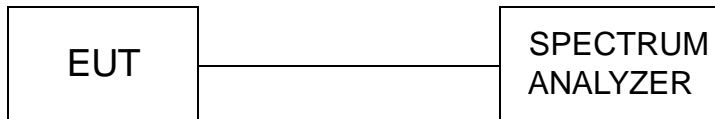

#### Test Results

Modulation	Packet	Dwell time (second)	Limit (second)	Result
GFSK	DH5	0.317	0.40	Pass
$\pi/4$ DQPSK	2DH5	0.316	0.40	Pass
8DPSK	3DH5	0.316	0.40	Pass

Note:

1. We have tested all mode at high,middle and low channel,and recoreded worst case at middle channel.
2. Dwell time=Pulse time (ms)  $\times$  (1600  $\div$  2  $\div$  79)  $\times$ 31.6 Second for DH1, 2-DH1, 3-DH1  
Dwell time=Pulse time (ms)  $\times$  (1600  $\div$  4  $\div$  79)  $\times$ 31.6 Second for DH3, 2-DH3, 3-DH3  
Dwell time=Pulse time (ms)  $\times$  (1600  $\div$  6  $\div$  79)  $\times$ 31.6 Second for DH5, 2-DH5, 3-DH5

#### Test plot as follows:

### GFSK Modulation

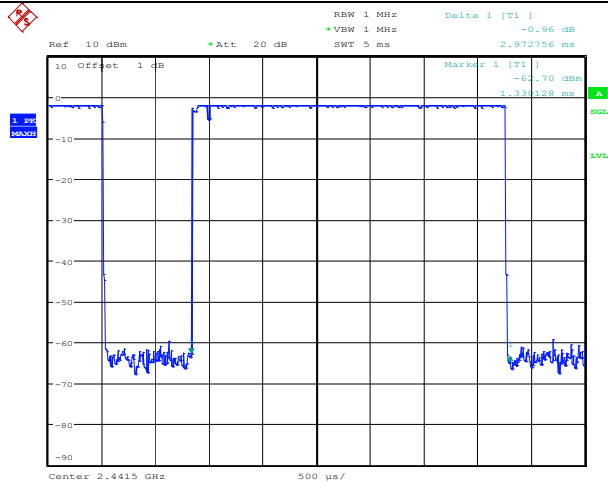

Date: 6.MAR.2018 12:02:34

### $\pi/4$ DQPSK Modulation

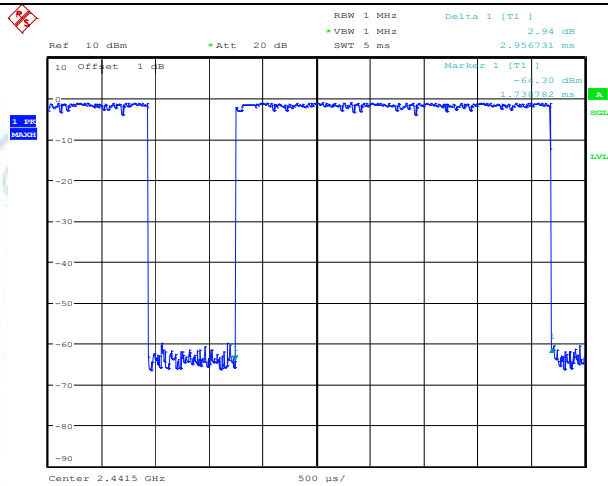

Date: 6.MAR.2018 12:01:26

### 8DPSK Modulation

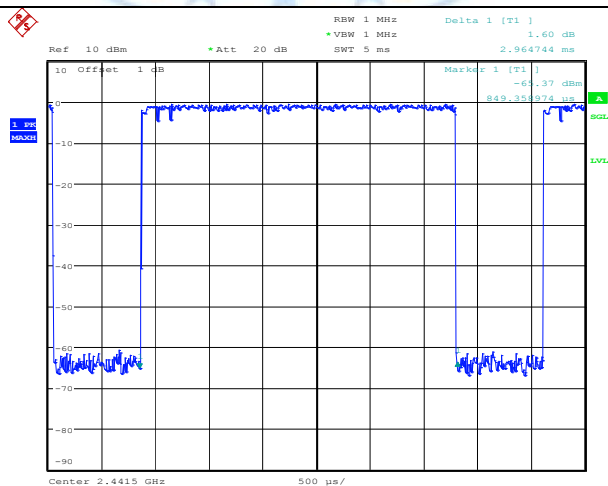

Date: 6.MAR.2018 12:00:13

Shenzhen General Testing & Inspection Technology Co., Ltd.

1-2/F., Building 2, Jiaquan Building, Guanlan High-Tech Park, Shenzhen, Guangdong, China

Tel.: (86)755-27521059

Fax.: (86)755-27521011 Http://www.sz-ctc.org.cn



For anti-fake verification, please visit the official website of Certification and Accreditation Administration of the People's Republic of China : [yz.cncaic.cn](http://yz.cncaic.cn)

### 3.9. Pseudorandom Frequency Hopping Sequence

#### TEST APPLICABLE

**For 47 CFR Part 15C section 15.247 (a) (1) requirement:**

Frequency hopping systems shall have hopping channel carrier frequencies separated by a minimum of 25 kHz or the 20 dB bandwidth of the hop-ping channel, whichever is greater. Alternatively, frequency hopping systems operating in the 2400–2483.5 MHz band may have hopping channel carrier frequencies that are separated by 25 kHz or two-thirds of the 20 dB bandwidth of the hopping channel, whichever is greater, provided the systems operate with an output power no greater than 125 mW. The system shall hop to channel frequencies that are selected at the system hopping rate from a pseudo randomly ordered list of hopping frequencies. Each frequency must be used equally on the average by each transmitter. The system receivers shall have input bandwidths that match the hop-ping channel bandwidths of their corresponding transmitters and shall shift frequencies in synchronization with the transmitted signals.

#### EUT Pseudorandom Frequency Hopping Sequence Requirement

The pseudorandom frequency hopping sequence may be generated in a nine-stage shift register whose 5<sup>th</sup> and 9<sup>th</sup> stage outputs are added in a modulo-two addition stage. And the result is fed back to the input of the first stage. The sequence begins with the first one of 9 consecutive ones, for example: the shift register is initialized with nine ones.

- Number of shift register stages:9
- Length of pseudo-random sequence:2<sup>9</sup>-1=511 bits
- Longest sequence of zeros:8(non-inverted signal)

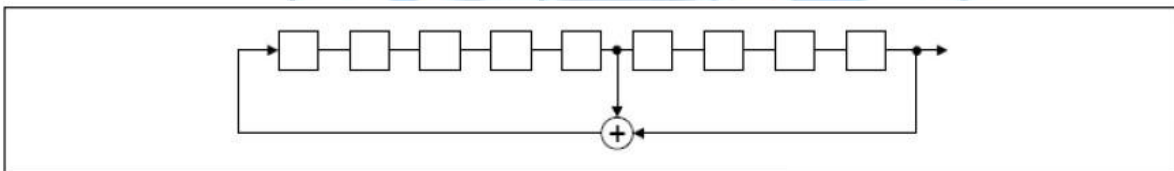

*Linear Feedback Shift Register for Generation of the PRBS sequence*

An example of pseudorandom frequency hopping sequence as follows:

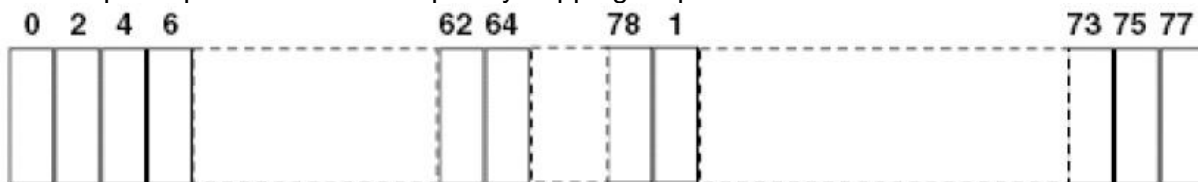

Each frequency used equally one the average by each transmitter.

The system receiver have input bandwidths that match the hopping channel bandwidths of their corresponding transmitter and shift frequencies in synchronization with the transmitted signals.



### 3.10. Antenna Requirement

#### Standard Applicable

For intentional device, according to FCC 47 CFR Section 15.203, an intentional radiator shall be designed to ensure that no antenna other than that furnished by the responsible party shall be used with the device.

And according to FCC 47 CFR Section 15.247 (c), if transmitting antennas of directional gain greater than 6dBi are used, the power shall be reduced by the amount in dB that the directional gain of the antenna exceeds 6dBi.

#### Result

The EUT's antenna used a Antenna, soldered on the PCB., The antenna's gain is 1.28 dBi. Complying with the standard requirement.

#### Test Result:

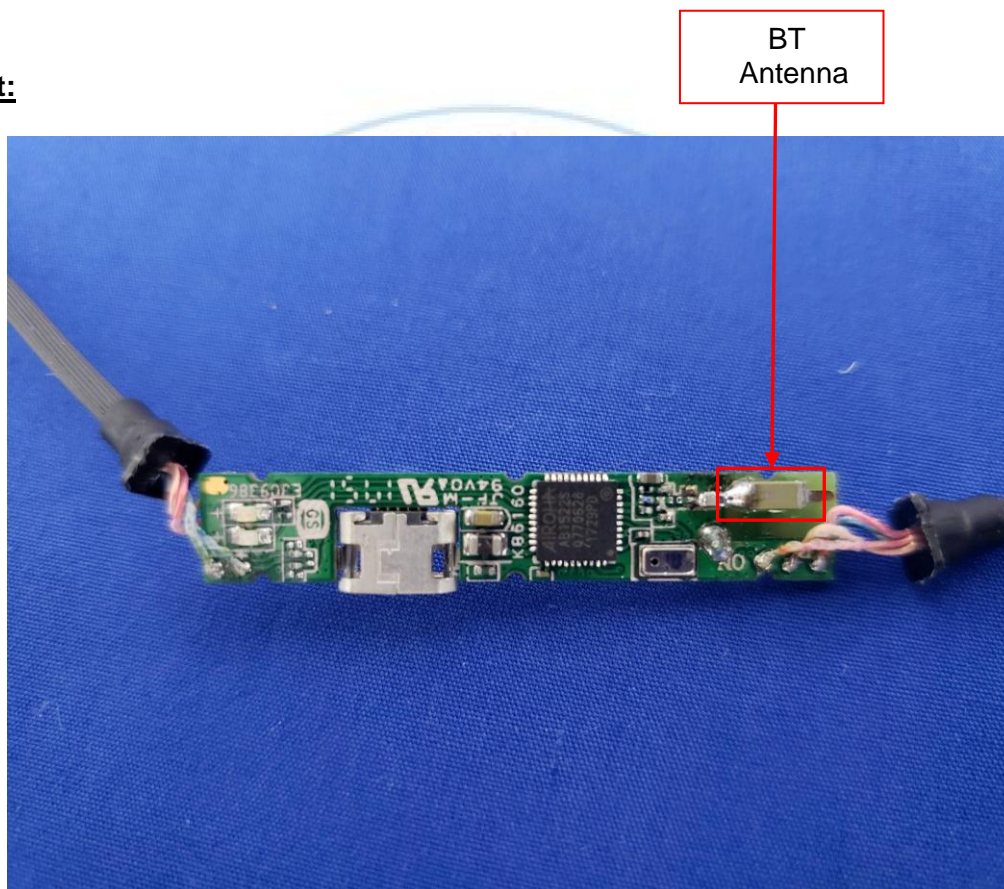

## 4. EUT TEST PHOTO

Radiated Emission (30MHz-1GHz)



Radiated Emission (1GHz-25GHz)



Conducted Emission



Shenzhen General Testing & Inspection Technology Co., Ltd.

1-2/F., Building 2, Jiaquan Building, Guanlan High-Tech Park, Shenzhen, Guangdong, China

Tel.: (86)755-27521059

Fax.: (86)755-27521011 Http://www.sz-ctc.org.cn



## 5. PHOTOGRAPHS OF EUT CONSTRUCTIONAL

External Photos of EUT Main Model

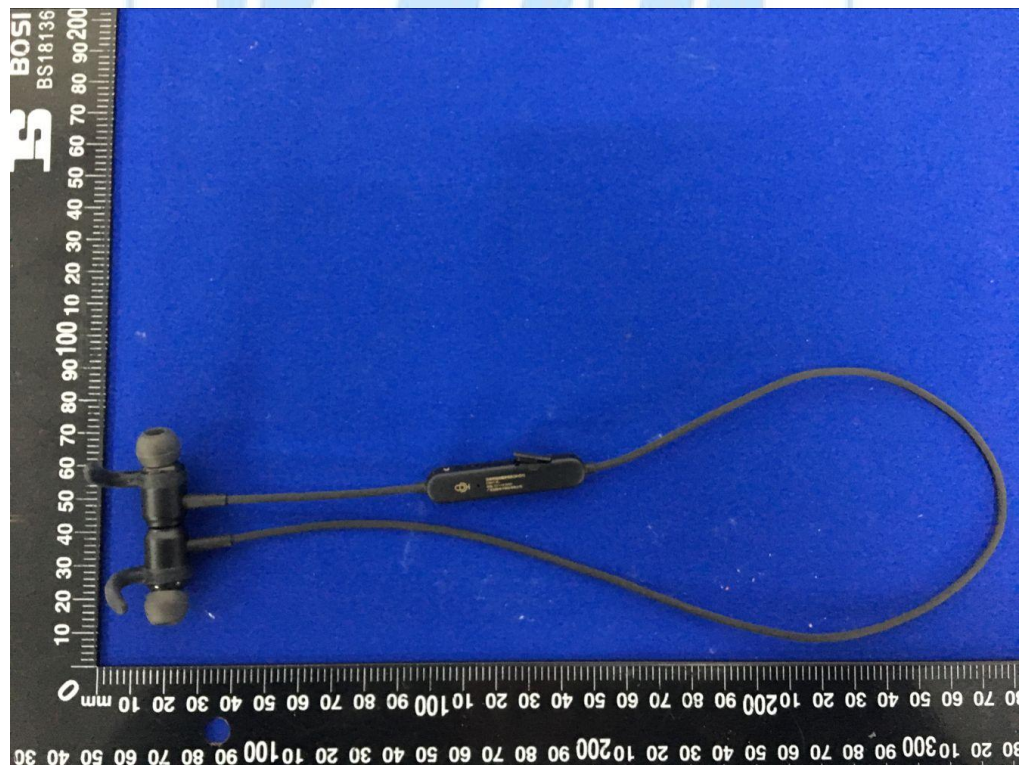



Shenzhen General Testing & Inspection Technology Co., Ltd.

1-2/F., Building 2, Jiaquan Building, Guanlan High-Tech Park, Shenzhen, Guangdong, China  
Tel.: (86)755-27521059

Fax.: (86)755-27521011 Http://www.sz-ctc.org.cn





Internal Photos of EUT

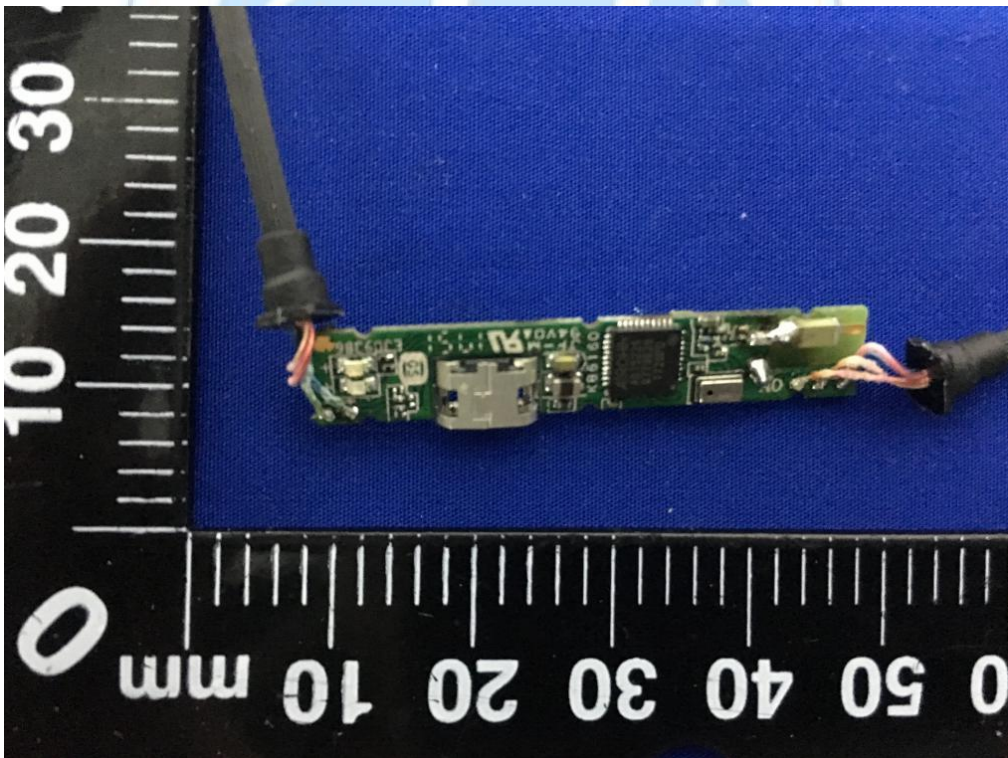



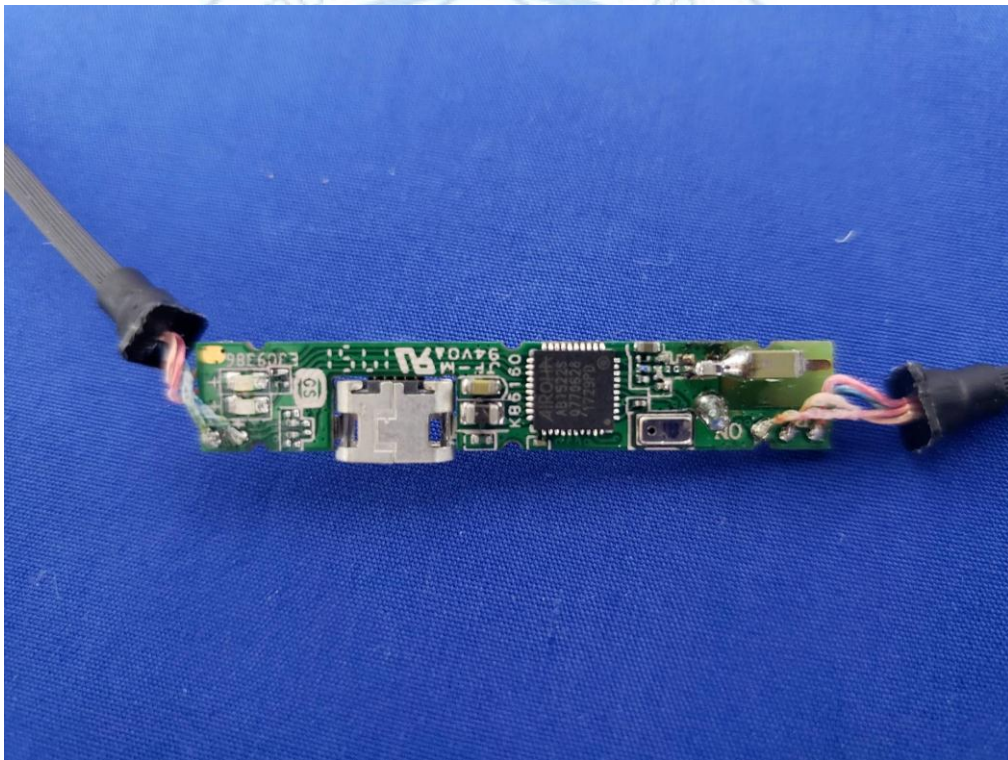
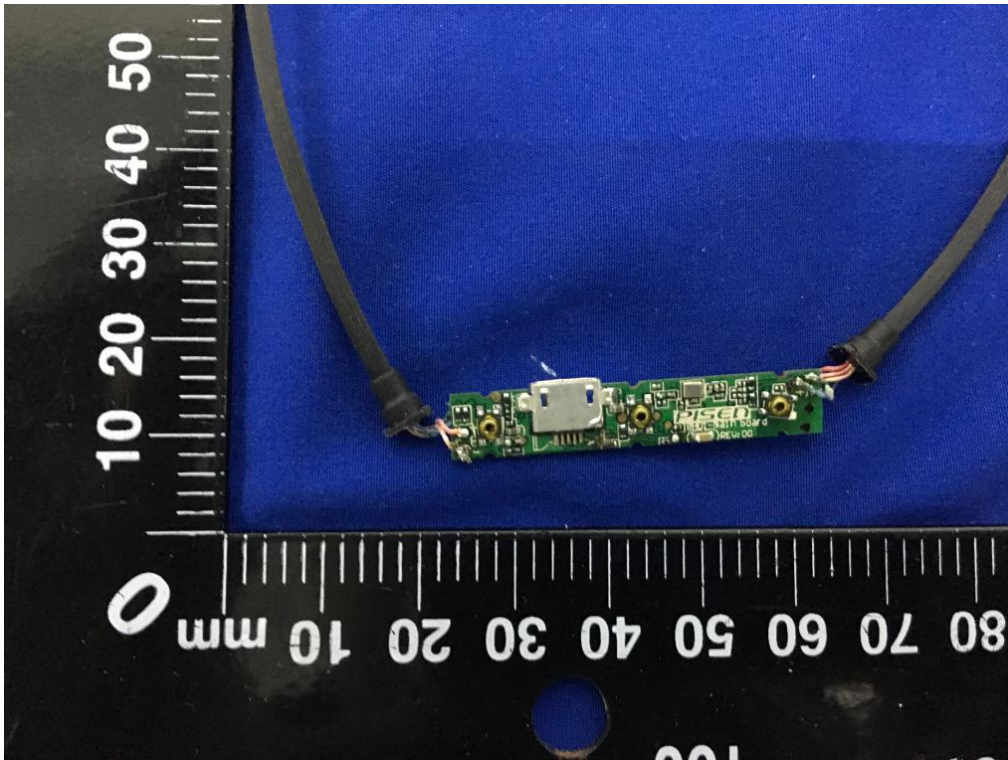

\*\*\*\*\*THE END\*\*\*\*\*