

# TEST REPORT

of

FCC Part 15 Subpart C §15.247

FCC ID: 2AF4X-VRPD2001

Equipment Under Test : VARRAM Pet MEAL-E  
Model Name : VRPD2001  
Variant Model Name(s) : -  
Applicant : VARRAM SYSTEM Co., Ltd.  
Manufacturer : VARRAM SYSTEM Co., Ltd.  
Date of Receipt : 2021.02.22  
Date of Test(s) : 2021.03.02 ~ 2021.04.20  
Date of Issue : 2021.04.21

In the configuration tested, the EUT complied with the standards specified above. This test report does not assure KOLAS accreditation.

- 1) The results of this test report are effective only to the items tested.
- 2) The SGS Korea is not responsible for the sampling, the results of this test report apply to the sample as received.
- 3) This test report cannot be reproduced, except in full, without prior written permission of the Company.

Tested by:

  
\_\_\_\_\_  
Nancy Park

Technical  
Manager:

  
\_\_\_\_\_  
Jinhyoung Cho

**SGS Korea Co., Ltd. Gunpo Laboratory**

# INDEX

## Table of Contents

1. General Information -----	3
2. Transmitter Radiated Spurious Emissions and Conducted Spurious Emission -----	9
3. 6 dB Bandwidth -----	35
4. Maximum Peak Conducted Output Power -----	40
5. Power Spectral Density -----	43
6. AC Power Line Conducted Emission -----	48
7. Antenna Requirement -----	52

## 1. General Information

### 1.1. Testing Laboratory

SGS Korea Co., Ltd. (Gunpo Laboratory)

- 10-2, LS-ro 182beon-gil, Gunpo-si, Gyeonggi-do, Korea, 15807
- 4, LS-ro 182beon-gil, Gunpo-si, Gyeonggi-do, Korea, 15807
- Designation number: KR0150

All SGS services are rendered in accordance with the applicable SGS conditions of service available on request and accessible at <http://www.sgs.com/en/Terms-and-Conditions.aspx>.

Phone No. : +82 31 688 0901

Fax No. : +82 31 688 0921

### 1.2. Details of Applicant

Applicant : VARRAM SYSTEM Co., Ltd.

Address : 57, Techno 11-ro, Yuseong-gu, Daejeon, South Korea, 34036

Contact Person : Jung, Ju-yong

Phone No. : +82 70 8797 8922

### 1.3. Details of Manufacturer

Company : Same as applicant

Address : Same as applicant

### 1.4. Description of EUT

<b>Kind of Product</b>	VARRAM Pet MEAL-E
<b>Model Name</b>	VRPD2001
<b>Power Supply</b>	AC 110 V (DC 4.5 V)
<b>Frequency Range</b>	2 412 MHz ~ 2 462 MHz (11b/g/n_HT20)
<b>Modulation Technique</b>	DSSS, OFDM
<b>Number of Channels</b>	11 channels (11b/g/n_HT20)
<b>Antenna Type</b>	FPC antenna
<b>Antenna Gain</b>	3 dBi
<b>H/W Version</b>	v1.51
<b>S/W Version</b>	v0D.0B

### 1.5. Test Equipment List

Equipment	Manufacturer	Model	S/N	Cal. Date	Cal. Interval	Cal. Due
Signal Generator	R&S	SMR40	100272	Jun. 18, 2020	Annual	Jun. 18, 2021
Signal Generator	R&S	SMBV100A	255834	Jun. 03, 2020	Annual	Jun. 03, 2021
Spectrum Analyzer	R&S	FSV30	103210	Dec. 07, 2020	Annual	Dec. 07, 2021
Spectrum Analyzer	Agilent	N9020A	MY53421758	Sep. 04, 2020	Annual	Sep. 04, 2021
Attenuator	AEROFLEX / INMET	40AH2W-10	40G-3	Jun. 16, 2020	Annual	Jun. 16, 2021
High Pass Filter	Wainwright Instrument GmbH	WHK3.0/18G-10SS	344	May 18, 2020	Annual	May 18, 2021
High Pass Filter	Wainwright Instrument GmbH	WHNX7.5/26.5G-6SS	15	Jun. 05, 2020	Annual	Jun. 05, 2021
Low Pass Filter	Mini-Circuits	NLP-1200+	V 9500401023-2	Jun. 01, 2020	Annual	Jun. 01, 2021
Power Sensor	R&S	NRP-Z81	100669	May 08, 2020	Annual	May 08, 2021
AC Power Supply	KIKUSUI	PCR 500M	QC002962	Nov. 26, 2020	Annual	Nov. 26, 2021
Preamplifier	H.P.	8447F	2944A03909	Aug. 06, 2020	Annual	Aug. 06, 2021
Signal Conditioning Unit	R&S	SCU-18	10117	Jun. 10, 2020	Annual	Jun. 10, 2021
Preamplifier	MITEQ Inc.	JS44-18004000-35-8P	1546891	May 08, 2020	Annual	May 08, 2021
Loop Antenna	Schwarzbeck Mess-Elektronik	FMZB 1519	1519-039	Aug. 22, 2019	Biennial	Aug. 22, 2021
Bilog Antenna	Schwarzbeck Mess-Elektronik	VULB 9163	01126	Dec. 22, 2020	Biennial	Dec. 22, 2022
Horn Antenna	R&S	HF906	100326	Feb. 04, 2021	Annual	Feb. 04, 2022
Horn Antenna	Schwarzbeck Mess-Elektronik	BBHA 9170	BBHA9170223	Sep. 16, 2020	Annual	Sep. 16, 2021
EMI Test Receiver	R&S	ESU	100109	Feb. 19, 2021	Annual	Feb. 19, 2022
Turn Table	Innco systems GmbH	DS 1200 S	N/A	N.C.R.	N/A	N.C.R.
Controller	Innco systems GmbH	CONTROLLER CO3000-4P	CO3000/963/38 330516/L	N.C.R.	N/A	N.C.R.
Antenna Mast	Innco systems GmbH	MA4640-XP-ET	MA4640/536/38 330516/L	N.C.R.	N/A	N.C.R.
Anechoic Chamber	SY Corporation	L x W x H (9.6 m x 6.4 m x 6.6 m)	N/A	N.C.R.	N/A	N.C.R.
Coaxial Cable	RFONE	MWX221-NMSNNMS (4 m)	J1023142	Dec. 01, 2020	Semi-annual	Jun. 01, 2021
Coaxial Cable	RFONE	SFX086-NMNM-10M (10 m)	20200324001	Dec. 01, 2020	Semi-annual	Jun. 01, 2021
Coaxial Cable	RFONE	PL360P-292M292M-1.5 M-A	20200324002	Feb. 19, 2021	Semi-annual	Aug. 19, 2021
Test Receiver	R&S	ESCI 7	100911	Feb. 19, 2021	Annual	Feb. 19, 2022
Two-Line V-Network	R&S	ENV216	100190	May 08, 2020	Annual	May 08, 2021
Shield Room	SY Corporation	L x W x H (6.5 m x 3.5 m x 3.5 m)	N/A	N.C.R.	N/A	N.C.R.

## 1.6. Summary of Test Results

The EUT has been tested according to the following specifications:

APPLIED STANDARD: FCC Part15 Subpart C		
Section	Test Item(s)	Result
15.205(a) 15.209 15.247(d)	Transmitter Radiated Spurious Emissions and Conducted Spurious Emission	Complied
15.247(a)(2)	6 dB Bandwidth	Complied
15.247(b)(3)	Maximum Peak Conducted Output Power	Complied
15.247(e)	Power Spectral Density	Complied
15.207	AC Power Line Conducted Emission	Complied

## 1.7. Test Procedure(s)

The measurement procedures described in the American National Standard of Procedure for Compliance Testing of unlicensed Wireless Devices (ANSI C63.10-2013) and the guidance provided in KDB 558074 D01 15.247 Meas Guidance v05r02 were used in the measurement of the DUT.

## 1.8. Sample Calculation

Where relevant, the following sample calculation is provided:

### 1.8.1. Conducted Test

Offset value (dB) = Attenuator (dB) + Cable loss (dB)

### 1.8.2. Radiation Test

Field strength level (dB $\mu$ V/m) = Measured level (dB $\mu$ V) + Antenna factor (dB) + Cable loss (dB) - Amplifier gain (dB) + Duty factor (dB)

### 1.9. Measurement Uncertainty

Where relevant, the following measurement uncertainty levels have been estimated for tests performed on the apparatus:

Parameter		Uncertainty
RF Output Power		± 0.36 dB
Occupied Bandwidth		± 13.12 kHz
Power Spectral Density		± 0.63 dB
Conducted Spurious Emission		± 0.63 dB
AC Conducted Emission		± 3.45 dB
Radiated Emission, 9 kHz to 30 MHz	H	± 3.66 dB
	V	± 3.66 dB
Radiated Emission, below 1 GHz	H	± 4.90 dB
	V	± 4.82 dB
Radiated Emission, above 1 GHz	H	± 3.62 dB
	V	± 3.64 dB

Uncertainty figures are valid to a confidence level of 95 %.

### 1.10. Test Report Revision

Revision	Report Number	Date of Issue	Description
0	F690501-RF-RTL001869	2021.04.21	Initial

### 1.11. Duty Cycle of EUT

Regarding to KDB 558074 D01 15.247 Meas Guidance v05r02, 6, the maximum duty cycles of all modes were investigated and set the spectrum analyzer as below;  
 Set RBW ≥ OBW if possible; otherwise, set RBW to the largest available value. Set detector = peak or average. The zero-span measurement method shall not be used unless both RBW and VBW are > 50/T and the number of sweep points across duration T exceeds 100.

Mode	Data Rate (Mbps)	Duty Cycle (%)	Correction Factor (dB)
11b	1	100	0
11g	6	100	0
11n_HT20	MCS0	100	0

**Remark;**

- As measured duty cycles of EUT, all of mode and data rate keeps constant period and are converted to log scale (power averaging) to compensate correction factor to result of average test items.
- Duty Cycle (%) = (Tx on time / Tx on + off time) x 100
- Correction Factor (dB) = 10 log (1 / Duty Cycle)

**- Test plots**

802.11b

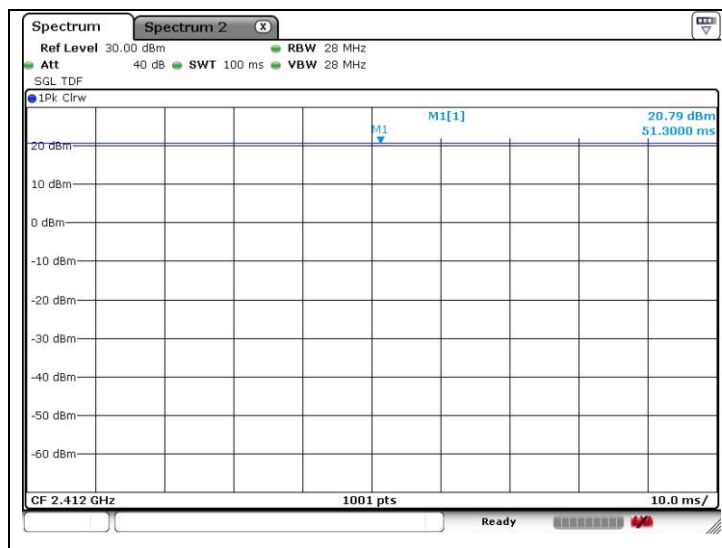

802.11g

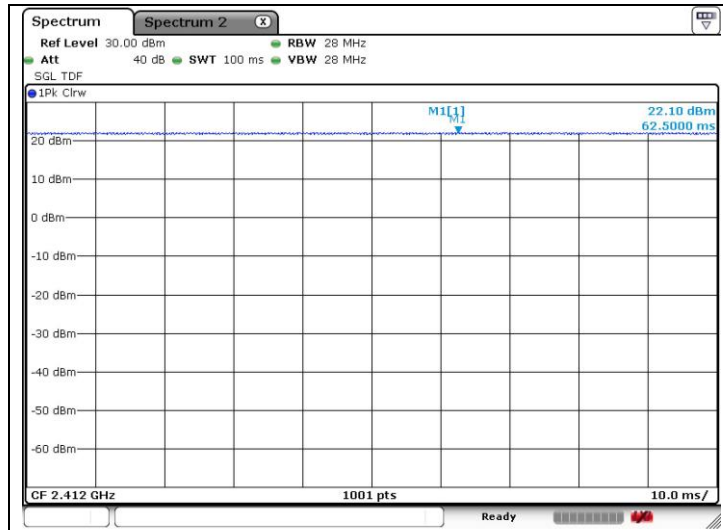

802.11n\_HT20

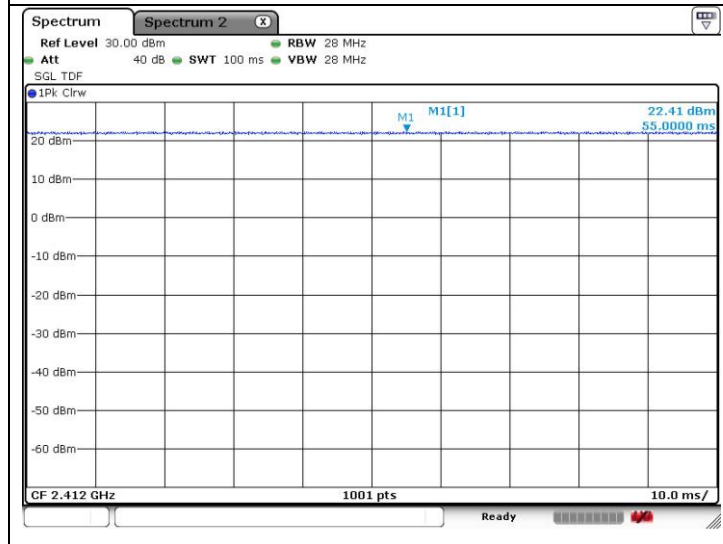



## 2. Transmitter Radiated Spurious Emissions and Conducted Spurious Emission

### 2.1. Test Setup

#### 2.1.1. Transmitter Radiated Spurious Emissions

The diagram below shows the test setup that is utilized to make the measurements for emission from 9 kHz to 30 MHz emissions.

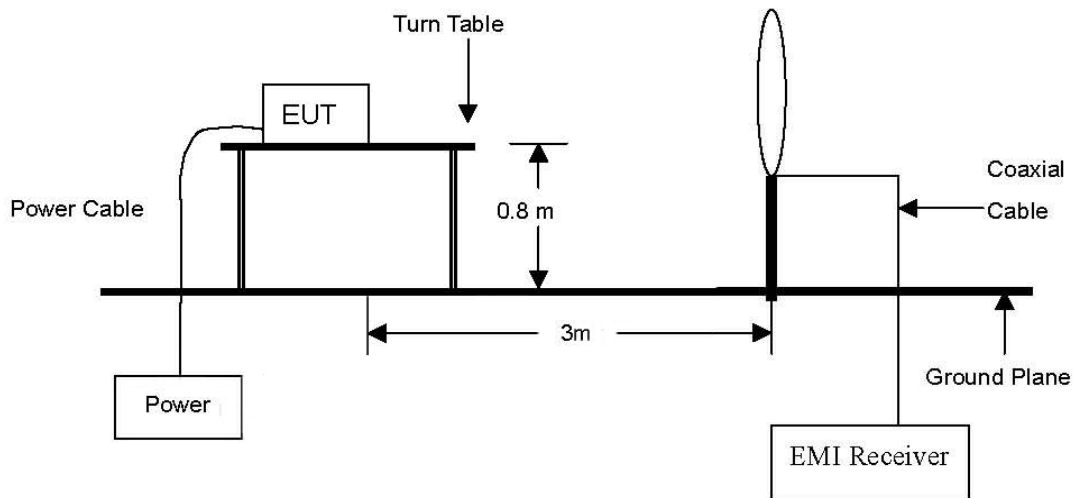

The diagram below shows the test setup that is utilized to make the measurements for emission from 30 MHz to 1 GHz emissions.

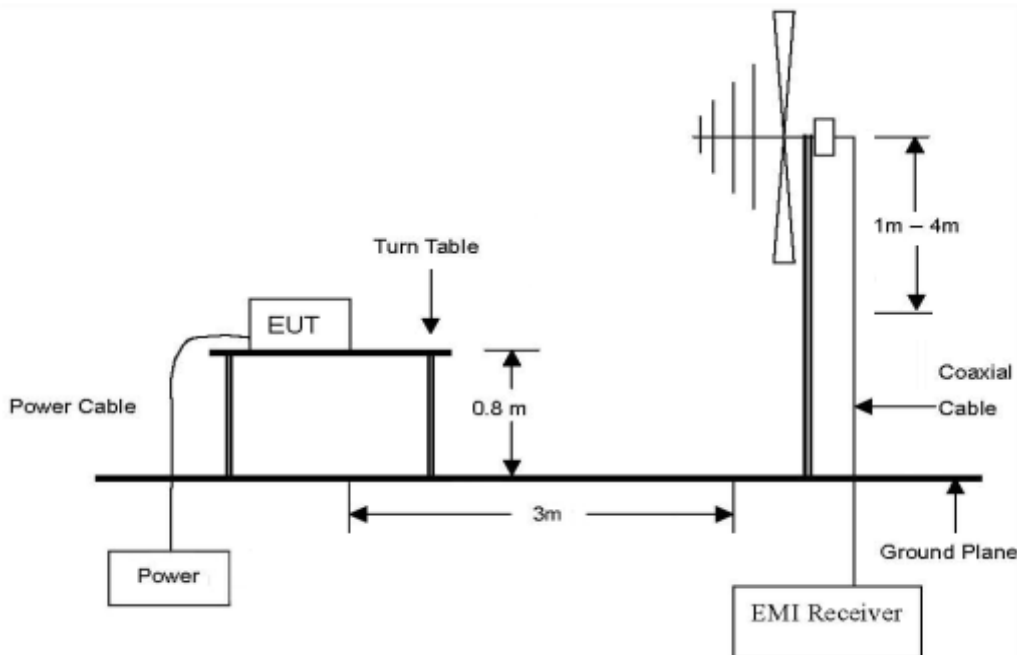

The diagram below shows the test setup that is utilized to make the measurements for emission. The spurious emissions were investigated from 1 GHz to the 10<sup>th</sup> harmonic of the highest fundamental frequency or 40 GHz, whichever is lower.

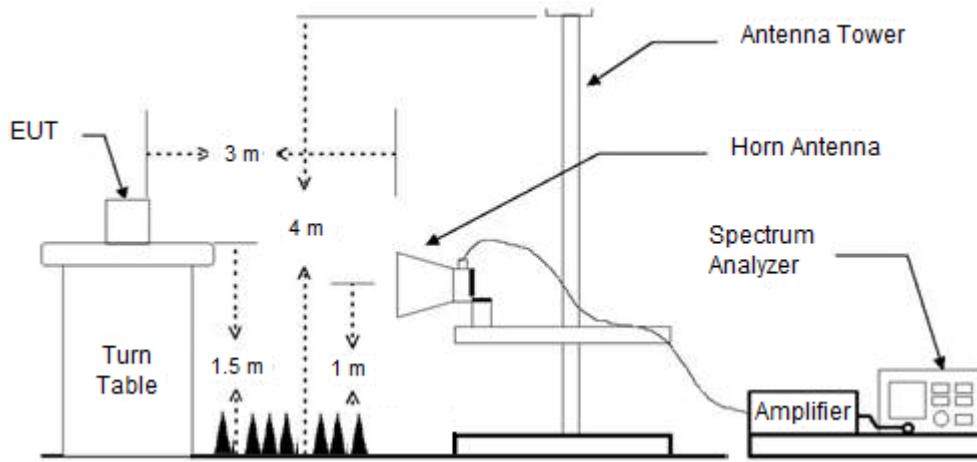

**2.1.2. Conducted Spurious Emission**



**2.2. Limit**

According to §15.247(d), in any 100 kHz bandwidth outside the frequency band in which the spread spectrum or digitally modulated intentional radiator is operating, the radio frequency power that is produced by the intentional radiator shall be at least 20 dB below that in the 100 kHz bandwidth within the band that contains the highest level of the desired power, based on either an RF conducted or a radiated measurement, provided the transmitter demonstrates compliance with the peak conducted power limits. If the transmitter complies with the conducted power limits based on the use of RMS averaging over a time interval, as permitted under paragraph (b)(3) of this section, the attenuation required under this paragraph shall be 30 dB instead of 20 dB. Attenuation below the general limits specified in §15.209(a) is not required. In addition, radiated emission which fall in the restricted bands, as defined in §15.205(a), must also comply with the radiated emission limits specified in §15.209(a) (see §15.205(c)).

According to §15.209(a), except as provided elsewhere in this subpart, the emissions from an intentional radiator shall not exceed the field strength levels specified in the following table:

Frequency (MHz)	Field Strength (µV/m)	Measurement Distance (Meters)
0.009-0.490	2 400/F(kHz)	300
0.490-1.705	24 000/F(kHz)	30
1.705-30.0	30	30
30-88	100**	3
88-216	150**	3
216-960	200**	3
Above 960	500	3

\*\* Except as provided in paragraph (g), fundamental emissions from intentional radiators operating under this section shall not be located in the frequency bands 54-72 MHz, 76-88 MHz, 174-216 MHz or 470-806 MHz. However, operation within these frequency bands is permitted under other sections of this part, e.g., §§15.231 and 15.241.

## 2.3. Test Procedures

Radiated emissions from the EUT were measured according to the dictates in section 11.11 & 11.12 of ANSI C63.10-2013.

### 2.3.1. Test Procedures for emission below 30 MHz

1. The EUT was placed on the top of a rotating table 0.8 meters above the ground at a 3 meter anechoic chamber test site. The table was rotated 360 degrees to determine the position of the highest radiation.
2. Then antenna is a loop antenna is fixed at one meter above the ground to determine the maximum value of the field strength. Both parallel and perpendicular of the antenna are set to make the measurement.
3. For each suspected emission, the EUT was arranged to its worst case and then the table was turned from 0 degrees to 360 degrees to find the maximum reading.
4. The test-receiver system was set to average or quasi peak detect function and Specified Bandwidth with Maximum Hold Mode.

### 2.3.2. Test Procedures for emission from above 30 MHz

1. The EUT was placed on the top of a rotating table 0.8 meters above the ground at a 3 meter anechoic chamber test site below 1 GHz and 1.5 meters above the ground at a 3 meter anechoic chamber test site above 1 GHz. The table was rotated 360 degrees to determine the position of the highest radiation.
2. During performing radiated emission below 1 GHz, the EUT was set 3 meters away from the interference receiving antenna, which was mounted on the top of a variable-height antenna tower. During performing radiated emission above 1 GHz, the EUT was set 3 meter away from the interference-receiving antenna.
3. The antenna is a bi-log antenna, a horn antenna and its height is varied from one meter to four meters above the ground to determine the maximum value of the field strength. Both horizontal and vertical polarizations of the antenna are set to make the measurement.
4. For each suspected emission, the EUT was arranged to its worst case and then the antenna was tuned to heights from 1 meter to 4 meters and the table was turned from 0 degrees to 360 degrees to find the maximum reading.
5. The test-receiver system was set to Peak Detect Function and Specified Bandwidth with Maximum Hold Mode.

**Note;**

All data rates and modes were investigated for radiated spurious emissions. Only the radiated emissions of the configuration that produced the worst case emissions are reported in this section.

1. Unwanted Emissions into Non-Restricted Frequency Bands

- The Reference Level Measurement refer to section 11.11.2

Set analyzer center frequency to DTS channel center frequency, SPAN  $\geq 1.5$  times the DTS bandwidth, the RBW = 100 kHz and VBW  $\geq 3 \times$  RBW, Detector = Peak, Sweep time = Auto couple, Trace = Max hold.

- Unwanted Emissions Level Measurement refer to section 11.11.3

Set the center frequency and span to encompass frequency range to be measured, the RBW = 100 kHz and VBW  $\geq 3 \times$  RBW, Detector = Peak, Sweep time = Auto couple, Trace = Max hold.

2. Unwanted Emissions into Restricted Frequency Bands

- Peak Power measurement procedure refer to section 11.12.2.4

Set RBW = as specified in Table 9, VBW  $\geq 3 \times$  RBW, Detector = Peak, Sweep time = auto, Trace = Max hold.

**Table 9 – RBW as a function of frequency**

Frequency	RBW
9 kHz to 150 kHz	200 Hz to 300 Hz
0.15 MHz to 30 MHz	9 kHz to 10 kHz
30 MHz to 1 000 MHz	100 kHz to 120 kHz
$> 1\ 000$ MHz	1 MHz

If the peak – detected amplitude can be shown to comply with the average limit, then it is not necessary to perform a separate average measurement.

- Average Power measurements procedure refer to section 11.12.2.5.2

The EUT shall be configured to operate at the maximum achievable duty cycle.

Measure the duty cycle D of the transmitter output signal as described in section 11.6.

Set RBW = 1 MHz, VBW  $\geq 3 \times$  RBW, Detector = RMS, if span / (# of points in sweep)  $\leq$  (RBW/2).

Satisfying this condition may require increasing the number of points in the sweep or reducing the span. If this condition cannot be satisfied then the detector mode shall be set to peak.

Averaging type = power (i.e., RMS).

As an alternative the detector and averaging type may be set for linear voltage averaging.

Some instruments require linear display mode in order to use linear voltage averaging. Log or dB averaging shall not be used. Sweep time = auto, Perform a trace average of at least 100 traces.

A correction factor shall be added to the measurement results prior to comparing to the emission limit in order to compute the emission level that would have been measured had the test been performed at 100 percent duty cycle. The correction factor is computed as follows:

- 1) If a specific emission is demonstrated to be continuous (D  $\geq 98$  %) rather than turning ON and OFF with the transmit cycle, then no duty cycle correction is required for that emission.

3. Definition of DUT Axis.

Definition of the test orthogonal plan for EUT was described in the test setup photo.

The test orthogonal plan of EUT is **Y – axis** during radiation test.

### 2.3.3. Test Procedures for Conducted Spurious Emissions

All data rates and modes were investigated for conducted spurious emissions.

Per the guidance of ANSI C63.10-2013, section 11.11.1 & 11.11.2 & 11.11.3, the reference level for out of band emissions is established from the plots of this section since the band edge emissions are measured with a RBW of 100 kHz. This reference level is then used as the limit in subsequent plots for out of band spurious emissions shown in section 2.4.3. The limit for out of band spurious emission at the band edge is 20 dB below the fundamental emission level measured in a 100 kHz bandwidth.

#### 1. Conducted Emissions at Band Edge

- The Measurement refer to section 11.11.3

Set the center frequency and span to encompass frequency range to be measured, the RBW = 100 kHz and VBW  $\geq 3 \times$  RBW, Detector = Peak, Sweep time = Auto couple, Trace mode = Max hold, The trace was allowed to stabilize.

#### 2. Conducted Spurious Emissions

- The Measurement refer to section 11.11.3

Start frequency was set to 9 kHz and stop frequency was set to 25 GHz (separated into two plots per channel), RBW = 1 MHz, VBW  $\geq 3 \times$  RBW, Detector = Peak, Sweep time = Auto couple, Trace = Max hold, The trace was allowed to stabilize.

#### 3. TDF function

- For plots showing conducted spurious emissions from 9 kHz to 25 GHz, all path loss of wide frequency range was investigated and compensated to spectrum analyzer as TDF function. So, the reading values shown in plots were final result.

## 2.4. Test Results

Ambient temperature : (23 ± 1) °C  
 Relative humidity : 47 % R.H.

### 2.4.1. Radiated Spurious Emission below 1 000 MHz

The frequency spectrum from 9 kHz to 1 000 MHz was investigated. All reading values are peak values.

Radiated Emissions			Ant	Correction Factors		Total	Limit	
Frequency (MHz)	Reading (dBμV)	Detect Mode	Pol.	AF (dB/m)	AMP + CL (dB)	Actual (dBμV/m)	Limit (dBμV/m)	Margin (dB)
33.84	48.30	Quasi-Peak	V	15.47	-27.35	36.42	40.00	3.58
38.24	45.90	Quasi-Peak	V	17.44	-27.32	36.02	40.00	3.98
57.89	44.10	Peak	V	18.72	-27.15	35.67	40.00	4.33
109.42	41.30	Peak	V	17.16	-26.62	31.84	43.50	11.66
220.28	44.60	Peak	V	16.92	-25.54	35.98	46.00	10.02
340.52	38.30	Peak	H	20.43	-25.16	33.57	46.00	12.43
Above 400.00	Not detected	-	-	-	-	-	-	-

#### Remark;

1. Spurious emissions for all channels were investigated and almost the same below 1 GHz.
2. Reported spurious emissions are in **11n HT20 / MCS0 / Middle channel** as worst case among other modes.
3. Radiated spurious emission measurement as below.  
 (Actual = Reading + AF + AMP + CL)
4. According to §15.31(o), emission levels are not report much lower than the limits by over 20 dB.

**- Test plots**

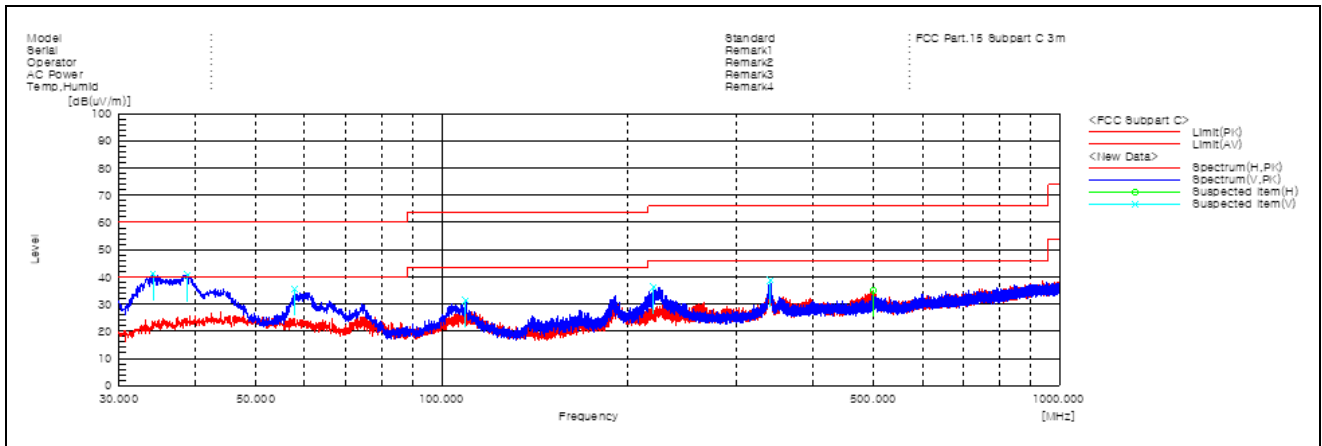
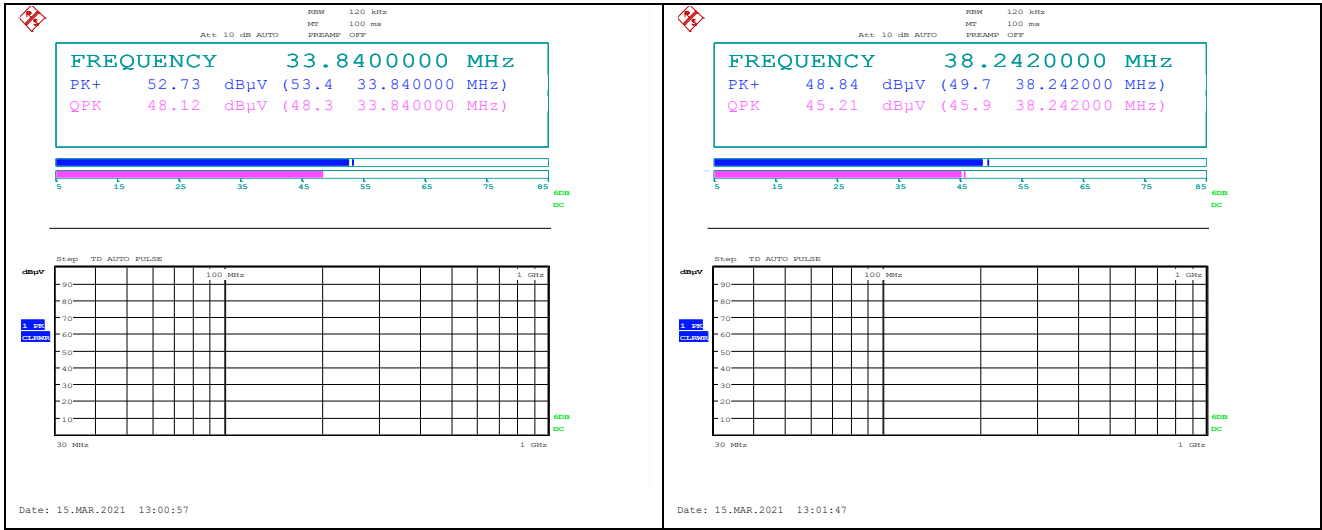



### 2.4.2. Radiated Spurious Emission above 1 000 MHz

The frequency spectrum above 1 000 MHz was investigated. All reading values are peak and average values.

#### DSSS: 802.11b (1 Mbps)

Low Channel (2 412 MHz)

Radiated Emissions			Ant.	Correction Factors			Total	Limit	
Frequency (MHz)	Reading (dB $\mu$ V)	Detect Mode	Pol.	AF (dB/m)	CL (dB)	DF (dB)	Actual (dB $\mu$ V/m)	Limit (dB $\mu$ V/m)	Margin (dB)
*2 310.00	21.76	Peak	V	28.00	6.06	-	55.82	74.00	18.18
*2 310.00	10.61	Average	V	28.00	6.06	-	44.67	54.00	9.33
*2 384.63	25.46	Peak	V	28.14	6.16	-	59.76	74.00	14.24
*2 385.67	14.12	Average	V	28.14	6.16	-	48.42	54.00	5.58
*2 390.00	23.50	Peak	V	28.16	6.14	-	57.80	74.00	16.20
*2 390.00	12.76	Average	V	28.16	6.14	-	47.06	54.00	6.94

Radiated Emissions			Ant.	Correction Factors			Total	Limit	
Frequency (MHz)	Reading (dB $\mu$ V)	Detect Mode	Pol.	AF (dB/m)	AMP+CL (dB)	DF (dB)	Actual (dB $\mu$ V/m)	Limit (dB $\mu$ V/m)	Margin (dB)
Above 1 000.00	Not detected	-	-	-	-	-	-	-	-

Middle Channel (2 437 MHz)

Radiated Emissions			Ant.	Correction Factors			Total	Limit	
Frequency (MHz)	Reading (dB $\mu$ V)	Detect Mode	Pol.	AF (dB/m)	AMP+CL (dB)	DF (dB)	Actual (dB $\mu$ V/m)	Limit (dB $\mu$ V/m)	Margin (dB)
Above 1 000.00	Not detected	-	-	-	-	-	-	-	-

High Channel (2 462 MHz)

Radiated Emissions			Ant.	Correction Factors			Total	Limit	
Frequency (MHz)	Reading (dB $\mu$ V)	Detect Mode	Pol.	AF (dB/m)	CL (dB)	DF (dB)	Actual (dB $\mu$ V/m)	Limit (dB $\mu$ V/m)	Margin (dB)
*2 483.50	24.83	Peak	V	28.33	6.21	-	59.37	74.00	14.63
*2 483.50	14.26	Average	V	28.33	6.21	-	48.80	54.00	5.20
*2 489.38	27.07	Peak	V	28.32	6.23	-	61.62	74.00	12.38
*2 487.73	16.01	Average	V	28.32	6.22	-	<b>50.55</b>	54.00	3.45
*2 500.00	23.17	Peak	V	28.30	6.27	-	57.74	74.00	16.26
*2 500.00	13.24	Average	V	28.30	6.27	-	47.81	54.00	6.19

Radiated Emissions			Ant.	Correction Factors			Total	Limit	
Frequency (MHz)	Reading (dB $\mu$ V)	Detect Mode	Pol.	AF (dB/m)	AMP+CL (dB)	DF (dB)	Actual (dB $\mu$ V/m)	Limit (dB $\mu$ V/m)	Margin (dB)
*4 923.88	56.77	Peak	H	33.20	-35.94	-	54.03	74.00	19.97
*4 923.48	49.05	Average	H	33.19	-35.93	-	46.31	54.00	7.69
Above 5 000.00	Not detected	-	-	-	-	-	-	-	-

**OFDM: 802.11g (6 Mbps)**

Low Channel (2 412 MHz)

Radiated Emissions			Ant.	Correction Factors			Total	Limit	
Frequency (MHz)	Reading (dB $\mu$ V)	Detect Mode	Pol.	AF (dB/m)	CL (dB)	DF (dB)	Actual (dB $\mu$ V/m)	Limit (dB $\mu$ V/m)	Margin (dB)
*2 310.00	21.00	Peak	V	28.00	6.06	-	55.06	74.00	18.94
*2 310.00	10.80	Average	V	28.00	6.06	-	44.86	54.00	9.14
*2 389.70	26.21	Peak	V	28.16	6.14	-	60.51	74.00	13.49
*2 389.70	15.08	Average	V	28.16	6.14	-	49.38	54.00	4.62
*2 390.00	26.26	Peak	V	28.16	6.14	-	60.56	74.00	13.44
*2 390.00	15.82	Average	V	28.16	6.14	-	50.12	54.00	3.88

Radiated Emissions			Ant.	Correction Factors			Total	Limit	
Frequency (MHz)	Reading (dB $\mu$ V)	Detect Mode	Pol.	AF (dB/m)	AMP+CL (dB)	DF (dB)	Actual (dB $\mu$ V/m)	Limit (dB $\mu$ V/m)	Margin (dB)
Above 1 000.00	Not detected	-	-	-	-	-	-	-	-

Middle Channel (2 437 MHz)

Radiated Emissions			Ant.	Correction Factors			Total	Limit	
Frequency (MHz)	Reading (dB $\mu$ V)	Detect Mode	Pol.	AF (dB/m)	AMP+CL (dB)	DF (dB)	Actual (dB $\mu$ V/m)	Limit (dB $\mu$ V/m)	Margin (dB)
Above 1 000.00	Not detected	-	-	-	-	-	-	-	-

High Channel (2 462 MHz)

Radiated Emissions			Ant.	Correction Factors			Total	Limit	
Frequency (MHz)	Reading (dB $\mu$ V)	Detect Mode	Pol.	AF (dB/m)	CL (dB)	DF (dB)	Actual (dB $\mu$ V/m)	Limit (dB $\mu$ V/m)	Margin (dB)
*2 483.50	27.93	Peak	V	28.33	6.21	-	62.47	74.00	11.53
*2 483.50	16.32	Average	V	28.33	6.21	-	<b>50.86</b>	54.00	3.14
*2 484.82	28.69	Peak	V	28.33	6.21	-	63.23	74.00	10.77
*2 483.61	16.25	Average	V	28.33	6.21	-	50.79	54.00	3.21
*2 500.00	22.01	Peak	V	28.30	6.27	-	56.58	74.00	17.42
*2 500.00	12.93	Average	V	28.30	6.27	-	47.50	54.00	6.50

Radiated Emissions			Ant.	Correction Factors			Total	Limit	
Frequency (MHz)	Reading (dB $\mu$ V)	Detect Mode	Pol.	AF (dB/m)	AMP+CL (dB)	DF (dB)	Actual (dB $\mu$ V/m)	Limit (dB $\mu$ V/m)	Margin (dB)
Above 1 000.00	Not detected	-	-	-	-	-	-	-	-

**OFDM: 802.11n\_HT20 (MCS0)**

Low Channel (2 412 MHz)

Radiated Emissions			Ant.	Correction Factors			Total	Limit	
Frequency (MHz)	Reading (dB $\mu$ V)	Detect Mode	Pol.	AF (dB/m)	CL (dB)	DF (dB)	Actual (dB $\mu$ V/m)	Limit (dB $\mu$ V/m)	Margin (dB)
*2 310.00	21.03	Peak	V	28.00	6.06	-	55.09	74.00	18.91
*2 310.00	10.65	Average	V	28.00	6.06	-	44.71	54.00	9.29
*2 389.70	27.82	Peak	V	28.16	6.14	-	62.12	74.00	11.88
*2 389.70	15.82	Average	V	28.16	6.14	-	50.12	54.00	3.88
*2 390.00	28.03	Peak	V	28.16	6.14	-	62.33	74.00	11.67
*2 390.00	15.72	Average	V	28.16	6.14	-	50.02	54.00	3.98

Radiated Emissions			Ant.	Correction Factors			Total	Limit	
Frequency (MHz)	Reading (dB $\mu$ V)	Detect Mode	Pol.	AF (dB/m)	AMP+CL (dB)	DF (dB)	Actual (dB $\mu$ V/m)	Limit (dB $\mu$ V/m)	Margin (dB)
Above 1 000.00	Not detected	-	-	-	-	-	-	-	-

Middle Channel (2 437 MHz)

Radiated Emissions			Ant.	Correction Factors			Total	Limit	
Frequency (MHz)	Reading (dB $\mu$ V)	Detect Mode	Pol.	AF (dB/m)	AMP+CL (dB)	DF (dB)	Actual (dB $\mu$ V/m)	Limit (dB $\mu$ V/m)	Margin (dB)
Above 1 000.00	Not detected	-	-	-	-	-	-	-	-

High Channel (2 462 MHz)

Radiated Emissions			Ant.	Correction Factors			Total	Limit	
Frequency (MHz)	Reading (dB $\mu$ V)	Detect Mode	Pol.	AF (dB/m)	CL (dB)	DF (dB)	Actual (dB $\mu$ V/m)	Limit (dB $\mu$ V/m)	Margin (dB)
*2 483.50	28.04	Peak	V	28.33	6.21	-	62.58	74.00	11.42
*2 483.50	16.15	Average	V	28.33	6.21	-	50.69	54.00	3.31
*2 483.72	28.76	Peak	V	28.33	6.21	-	63.30	74.00	10.70
*2 484.38	16.35	Average	V	28.33	6.21	-	<b>50.89</b>	54.00	3.11
*2 500.00	23.72	Peak	V	28.30	6.27	-	58.29	74.00	15.71
*2 500.00	12.26	Average	V	28.30	6.27	-	46.83	54.00	7.17

Radiated Emissions			Ant.	Correction Factors			Total	Limit	
Frequency (MHz)	Reading (dB $\mu$ V)	Detect Mode	Pol.	AF (dB/m)	AMP+CL (dB)	DF (dB)	Actual (dB $\mu$ V/m)	Limit (dB $\mu$ V/m)	Margin (dB)
Above 1 000.00	Not detected	-	-	-	-	-	-	-	-

**Remarks;**

1. “\*” means the restricted band.
2. Measuring frequencies from 1 GHz to the 10<sup>th</sup> harmonic of highest fundamental frequency.
3. Radiated emissions measured in frequency above 1 000 MHz were made with an instrument using peak/average detector mode.
4. Actual = Reading + AF + CL + (DF) or Reading + AF + AMP + CL + (DF).
5. According to § 15.31(o), emission levels are not reported much lower than the limits by over 20 dB.
6. The maximized peak measured value complies with the average limit, to perform an average measurement is unnecessary.

**- Test plots**

**DSSS: 802.11b (1 Mbps)**

Low channel band edge (Peak)

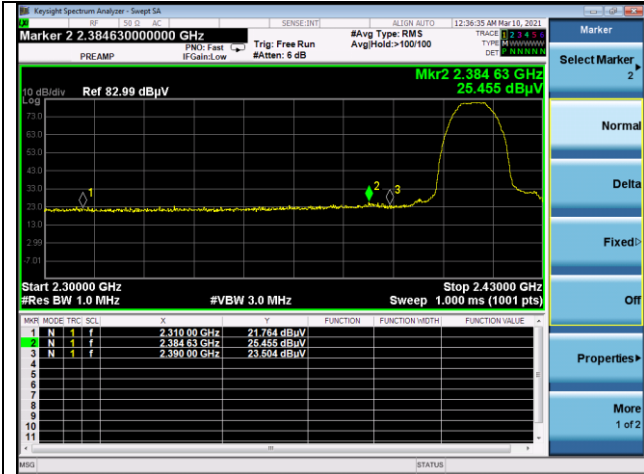

Low channel band edge (Average)

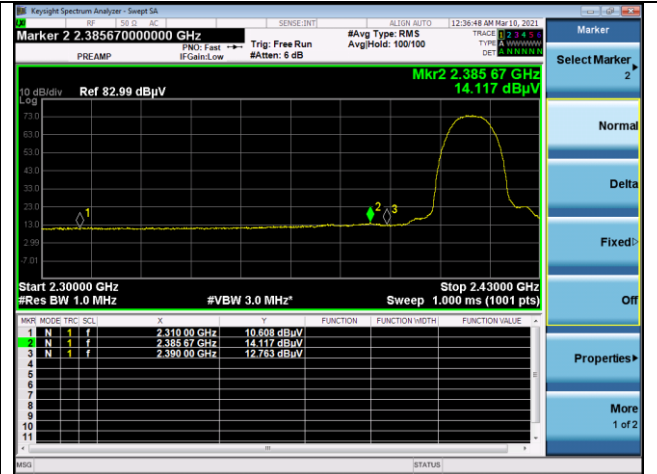

High channel band edge (Peak)



High channel band edge (Average)



High channel 2<sup>nd</sup> harmonic (Peak)



High channel 2<sup>nd</sup> harmonic (Average)



**OFDM: 802.11g (6 Mbps)**

Low channel band edge (Peak)

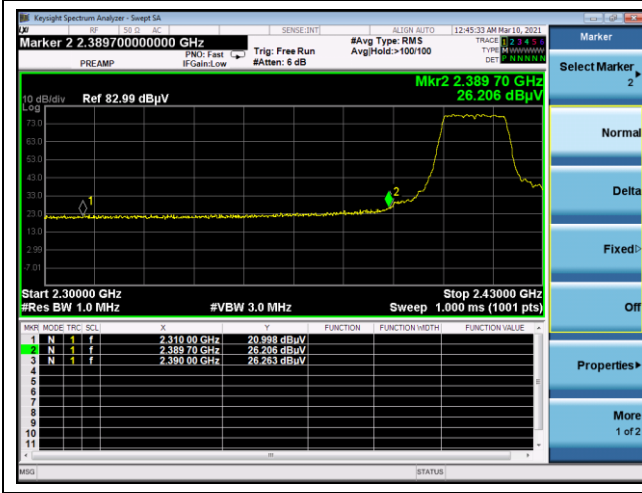

Low channel band edge (Average)

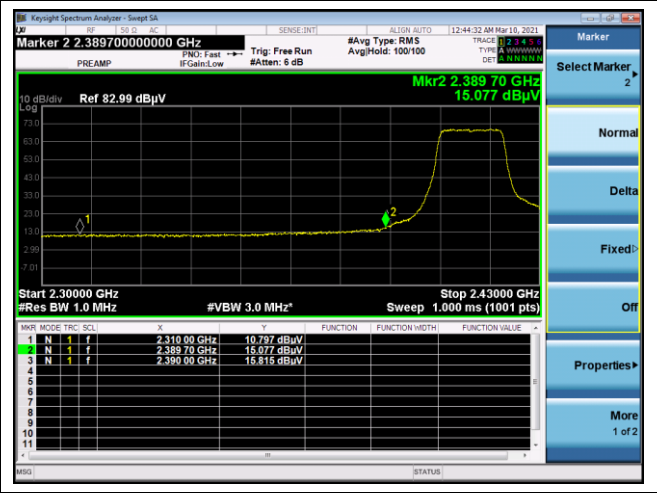

High channel band edge (Peak)

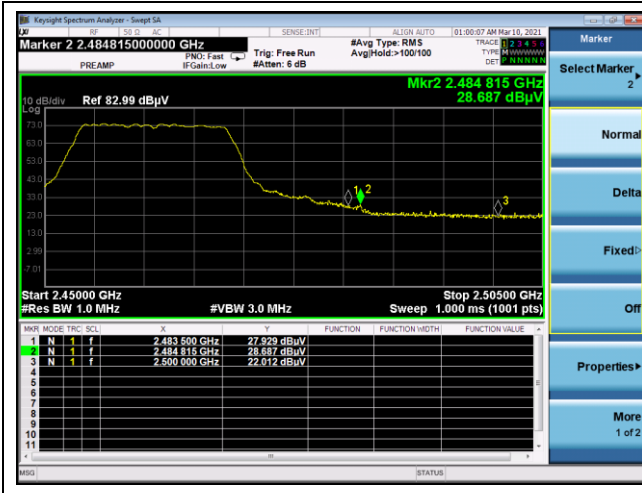

High channel band edge (Average)





**OFDM: 802.11n\_HT20 (MCS0)**

Low channel band edge (Peak)

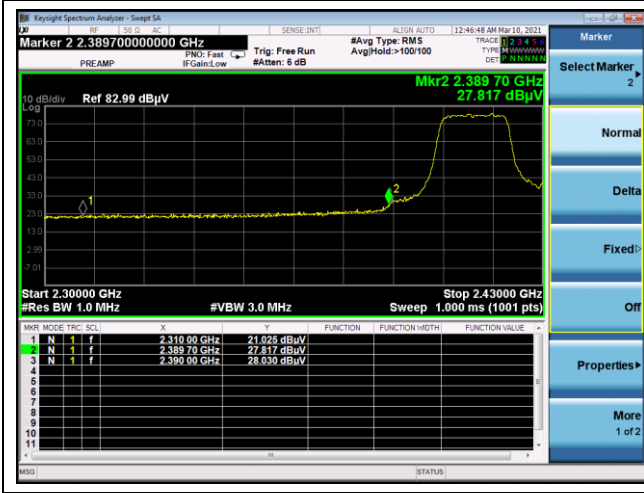

Low channel band edge (Average)



High channel band edge (Peak)

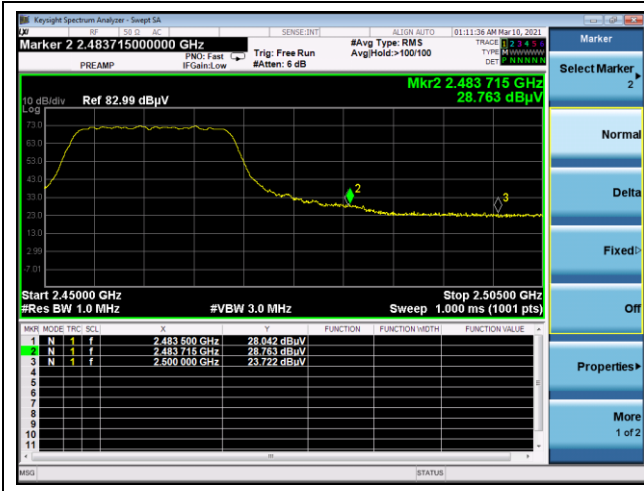

High channel band edge (Average)

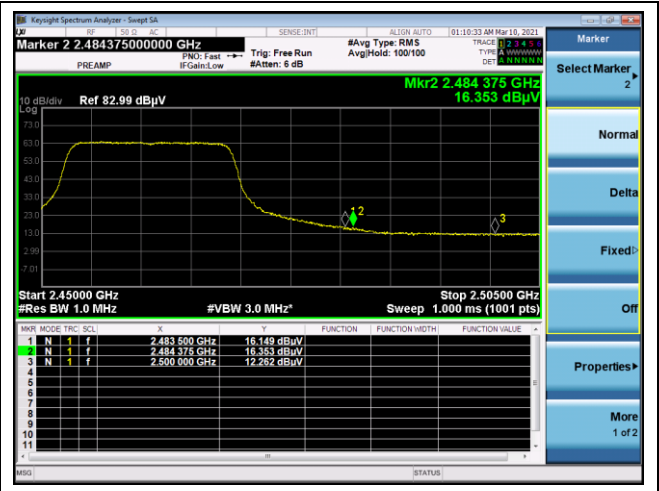

### 2.4.3. Plot of Conducted Spurious Emissions

**DSSS: 802.11b (1 Mbps)**  
 Low Channel

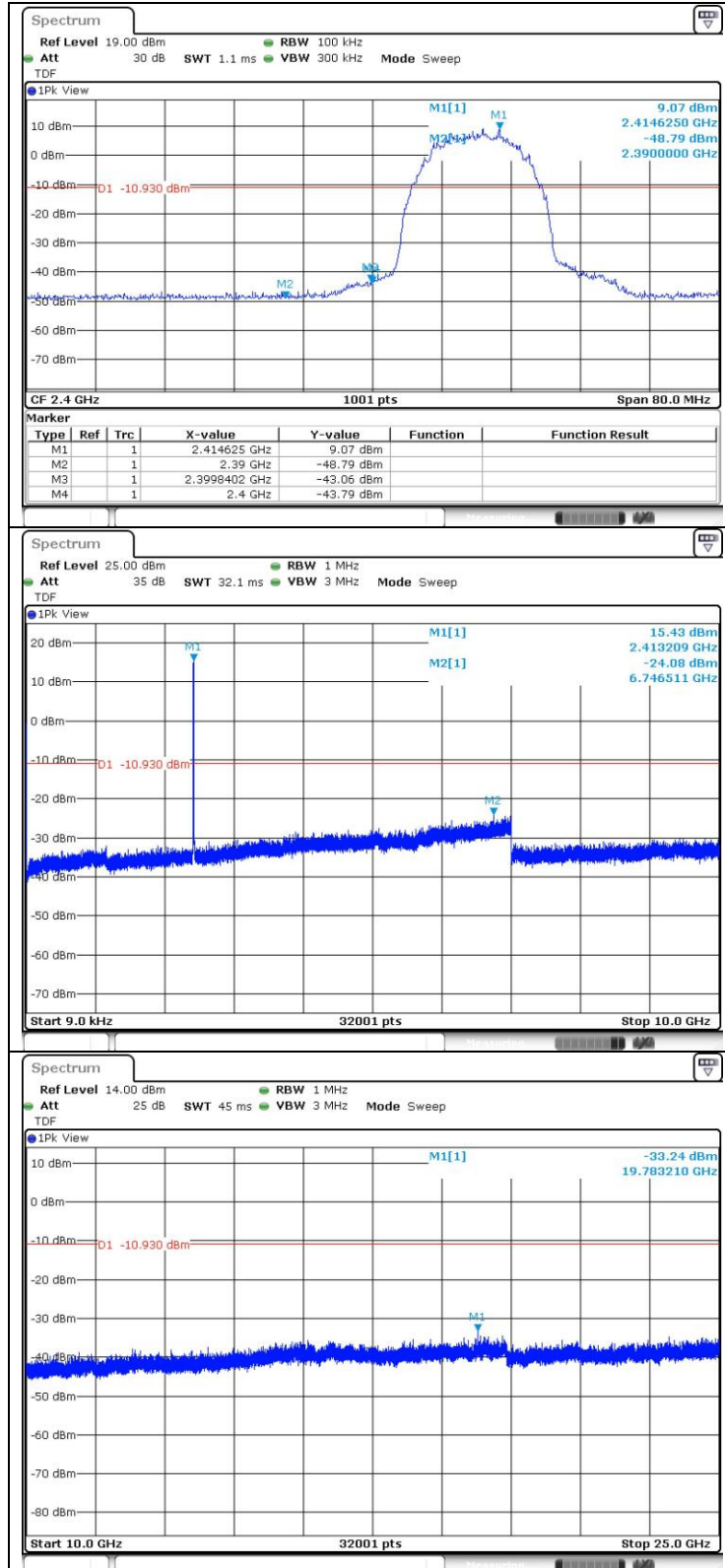

Middle Channel

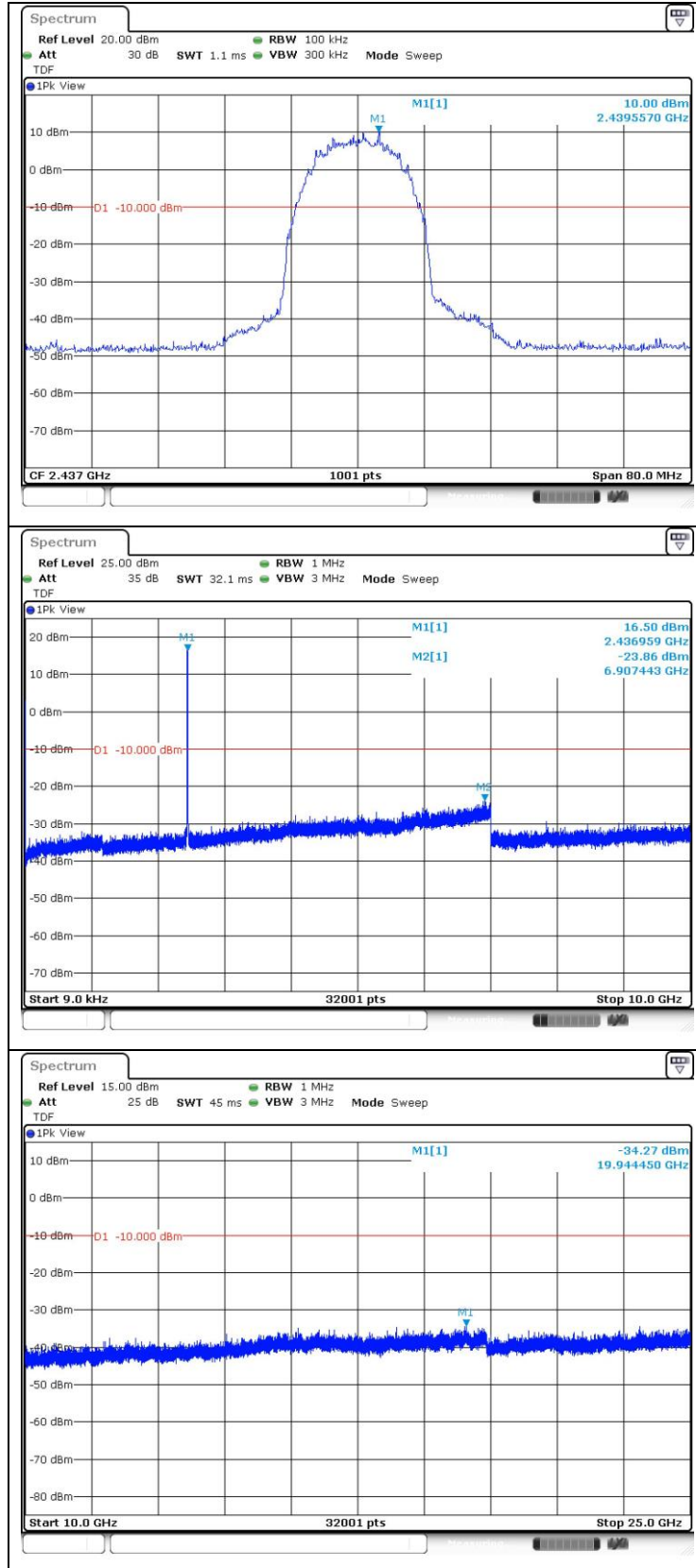

High Channel

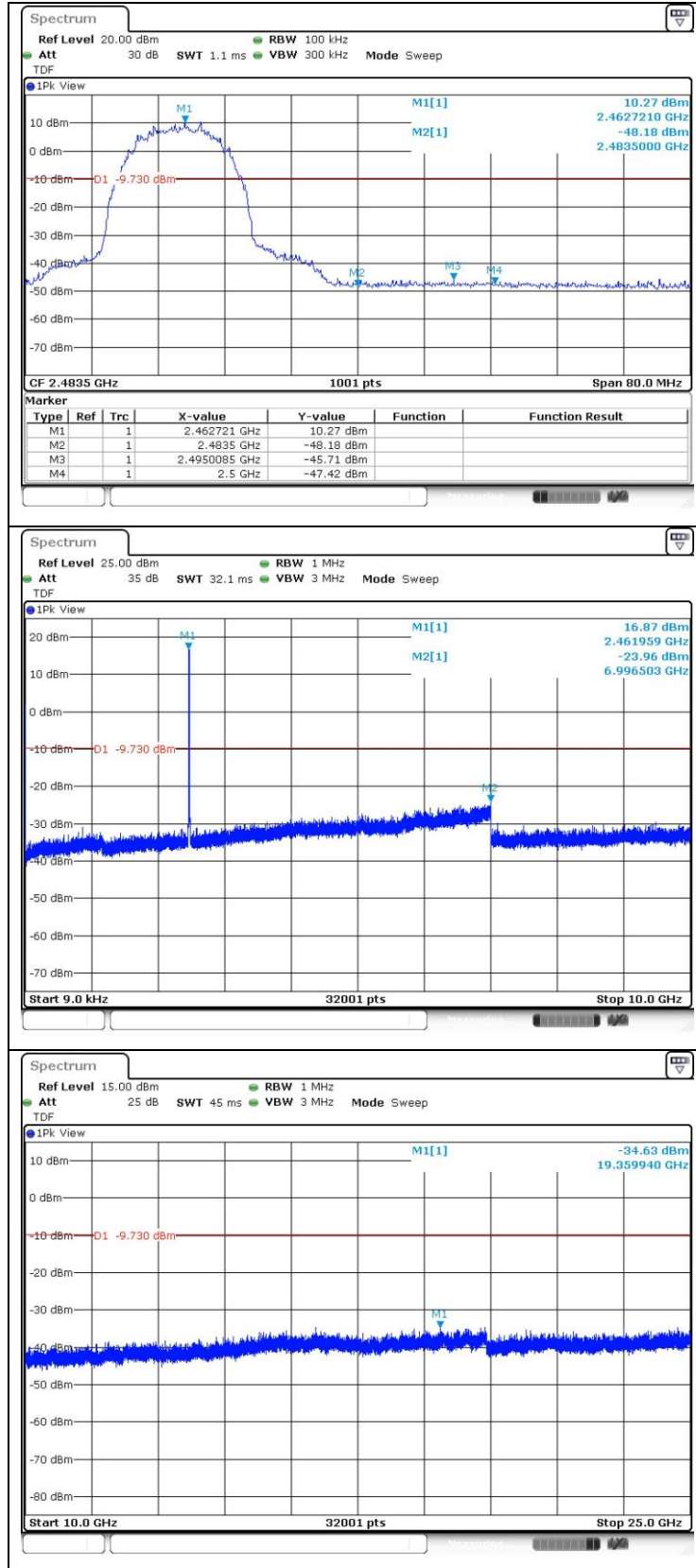

**OFDM: 802.11g (6 Mbps)**  
 Low Channel

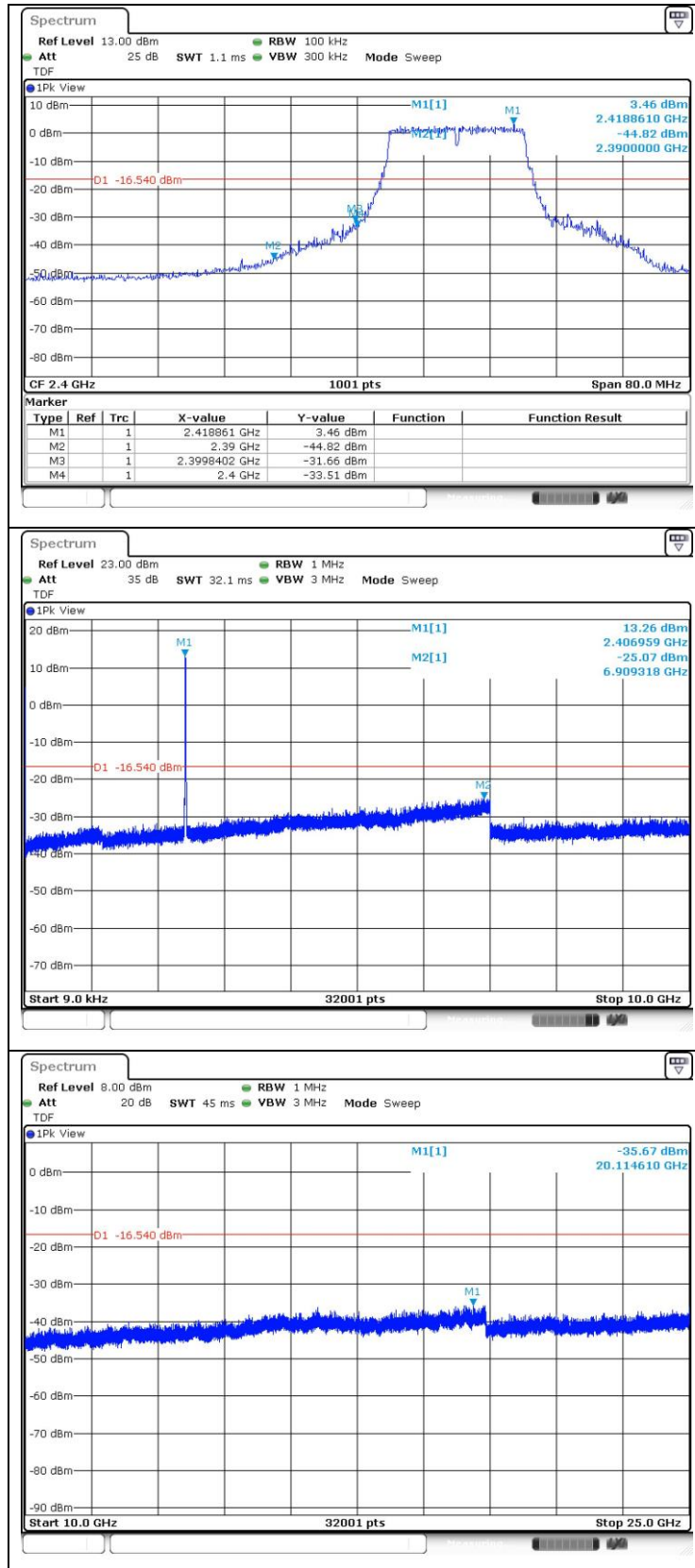

Middle Channel

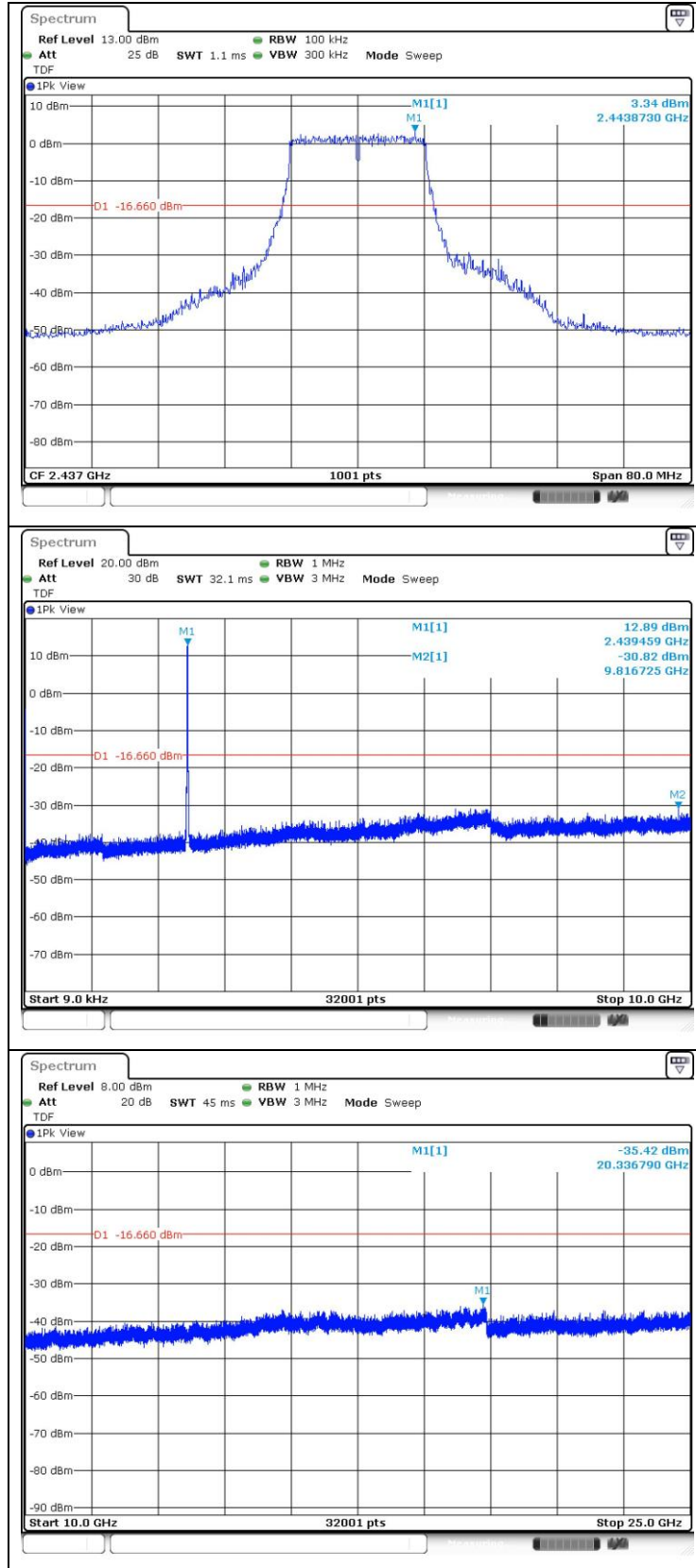

High Channel

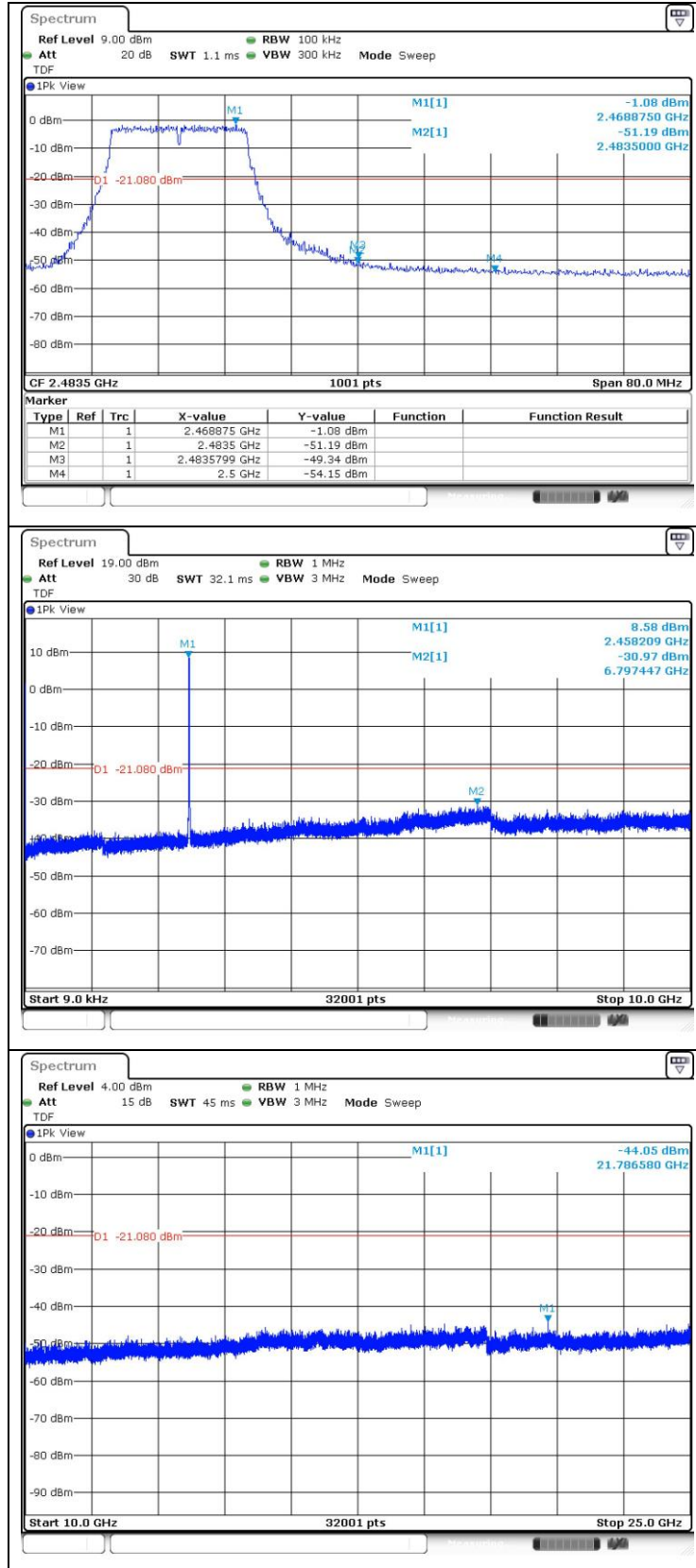



**OFDM: 802.11n\_HT20 (MCS0)**

Low Channel

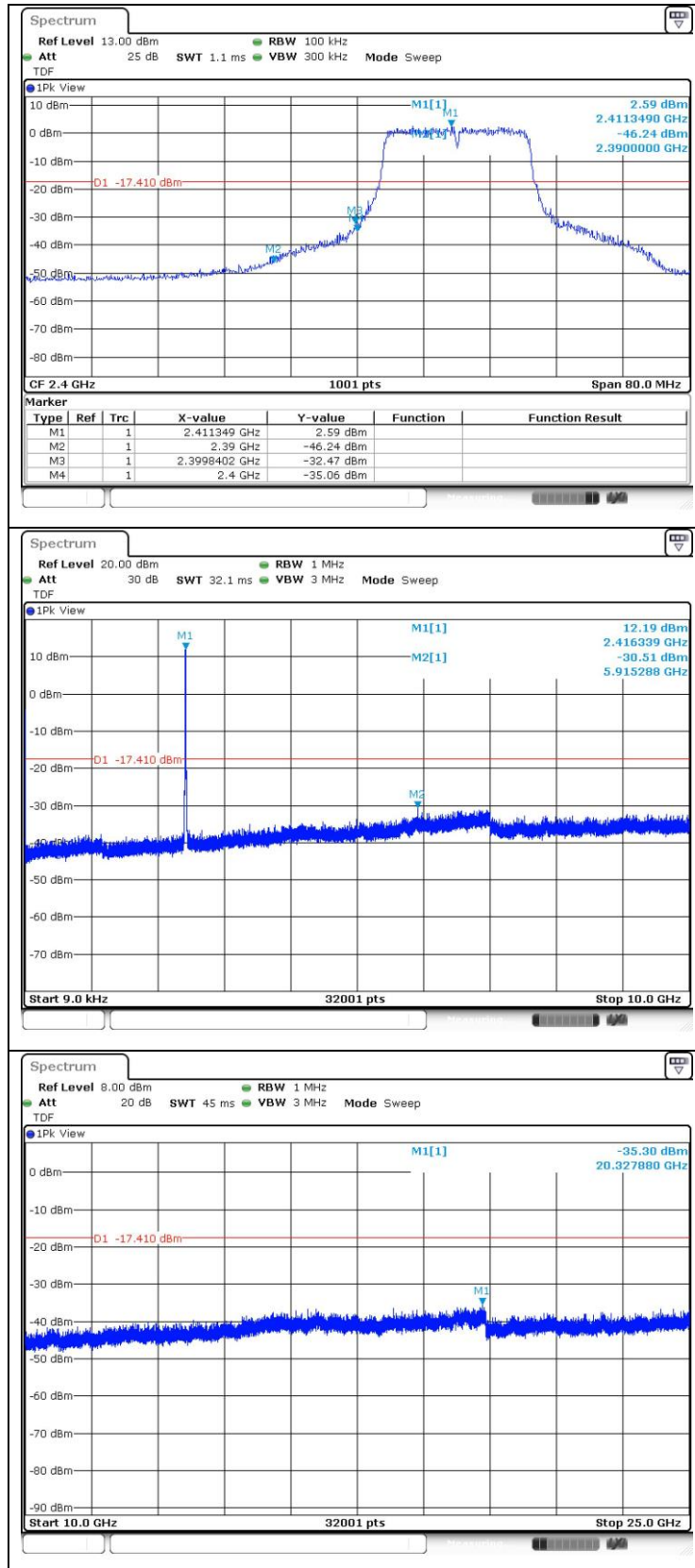



Middle Channel

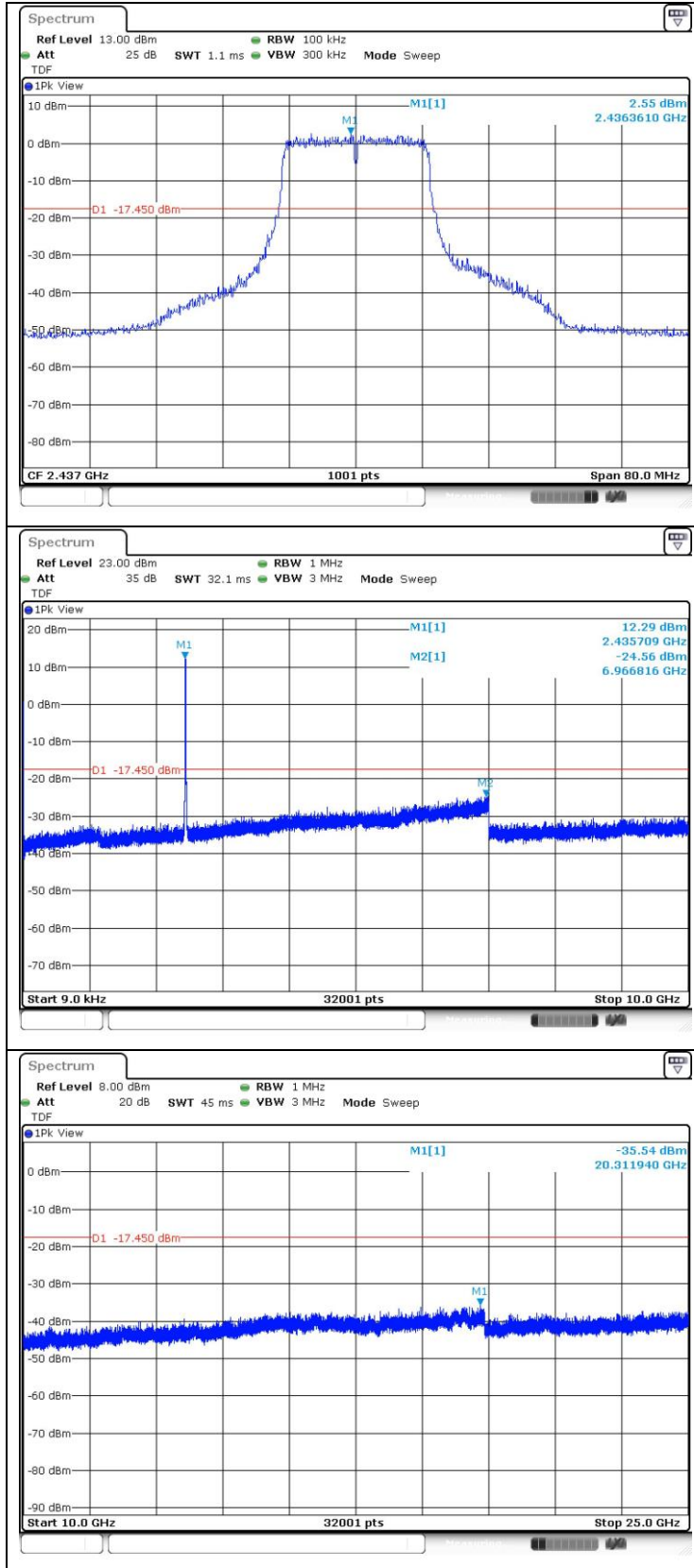

High Channel

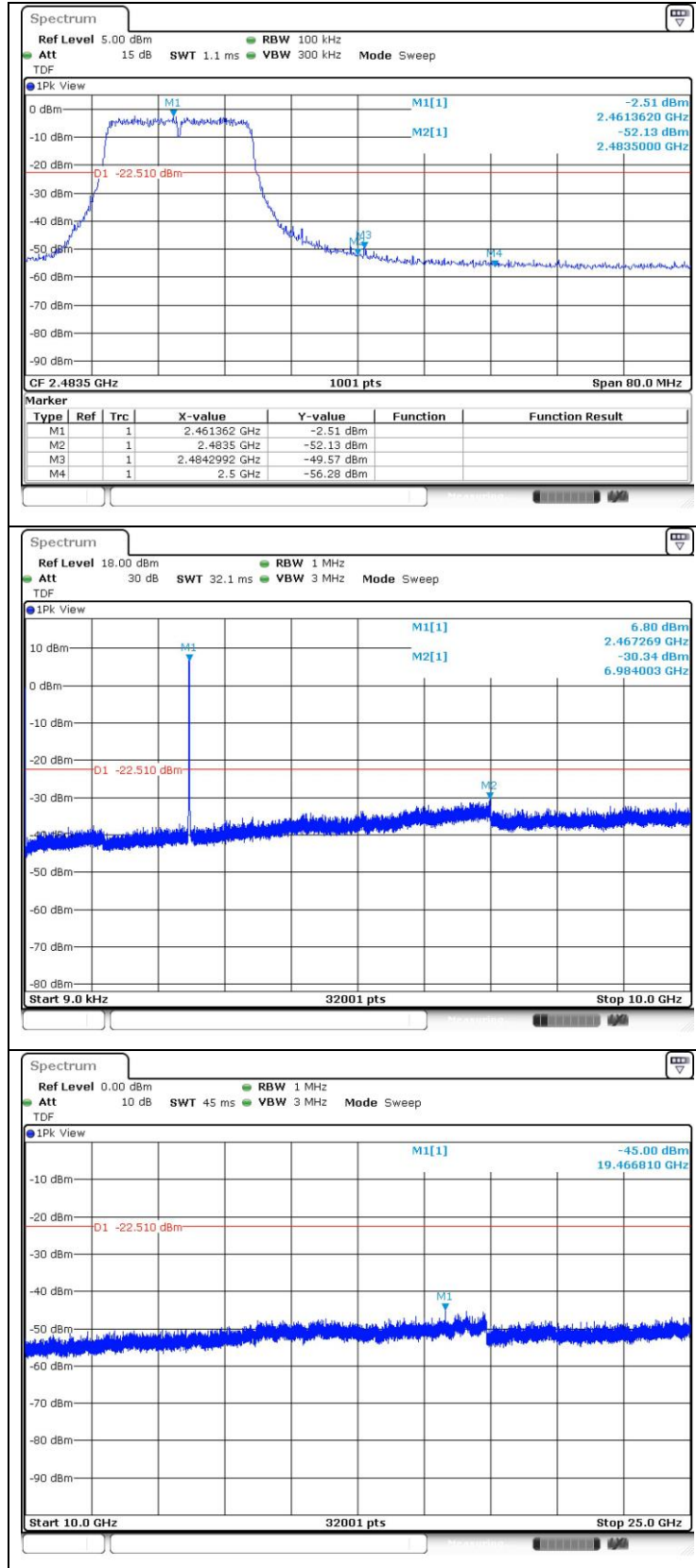

## 3. 6 dB Bandwidth

### 3.1. Test Setup



### 3.2. Limit

According to §15.247(a)(2), systems using digital modulation techniques may operate in the 902-928 MHz, 2 400-2 483.5 MHz, and 5 725-5 850 MHz bands. The minimum 6 dB bandwidth shall be at least 500 kHz.

### 3.3. Test Procedure

#### 6 dB Bandwidth

The test follows section 11.8 DTS bandwidth of ANSI C63.10-2013.  
Tests performed using section 11.8.1 Option 1.

- Option 1:

1. Set RBW to = 100 kHz.
2. Set the VBW  $\geq$  [3 x RBW].
3. Detector = peak.
4. Trace mode = max hold.
5. Sweep = auto couple.
6. Allow the trace to stabilize.
7. Measure the maximum width of the emission that is constrained by the frequencies associated with the two outermost amplitude points (upper and lower frequencies) that are attenuated by 6 dB relative to the maximum level measured in the fundamental emission.

### 3.4. Test Results

Ambient temperature : (23 ± 1) °C  
 Relative humidity : 47 % R.H.

Operation Mode	Data Rate (Mbps)	Channel	Frequency (MHz)	6 dB Bandwidth (MHz)	Minimum Limit (kHz)
DSSS (802.11b)	1	Low	2 412	9.670	500
		Middle	2 437	10.110	
		High	2 462	10.110	
OFDM (802.11g)	6	Low	2 412	16.504	
		Middle	2 437	16.504	
		High	2 462	16.504	
OFDM (802.11n_HT20)	MCS0	Low	2 412	17.423	
		Middle	2 437	17.662	
		High	2 462	17.423	

**- Test plots**

**DSSS: 802.11b**

Low Channel

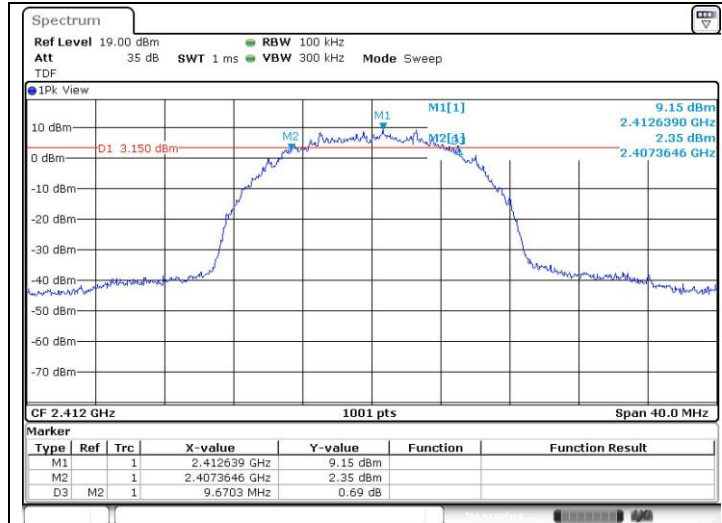

Middle Channel

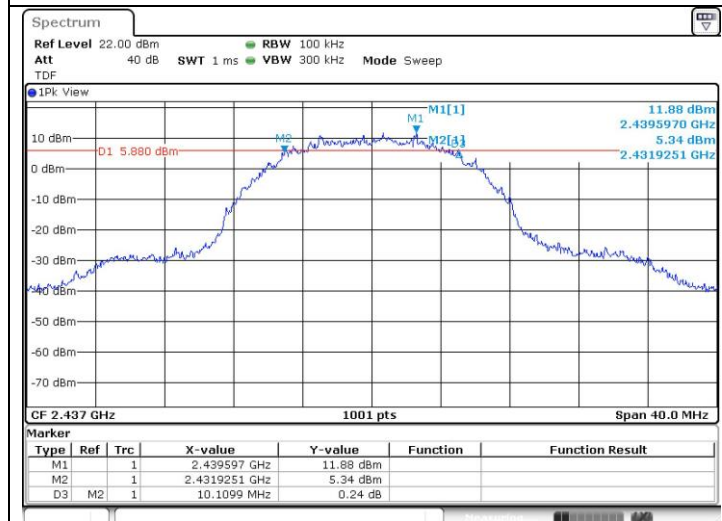

High Channel

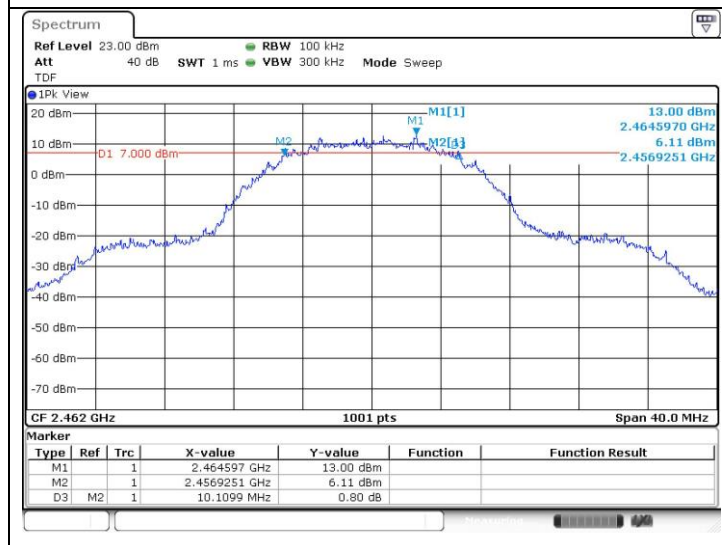

**OFDM: 802.11g**

Low Channel

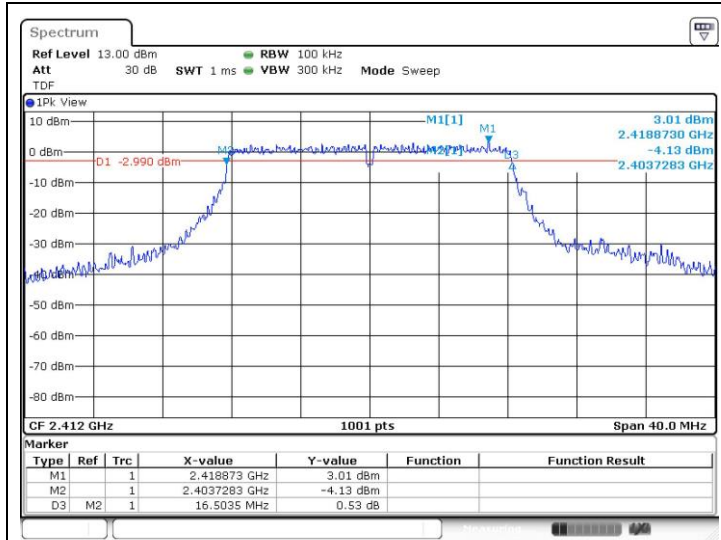

Middle Channel

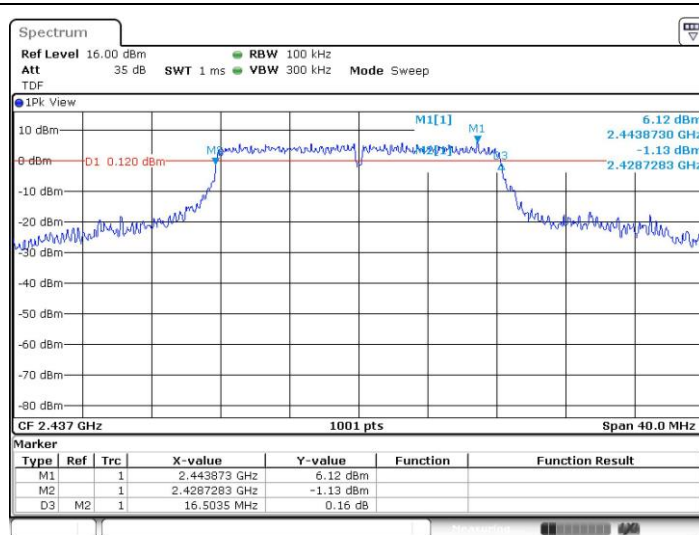

High Channel

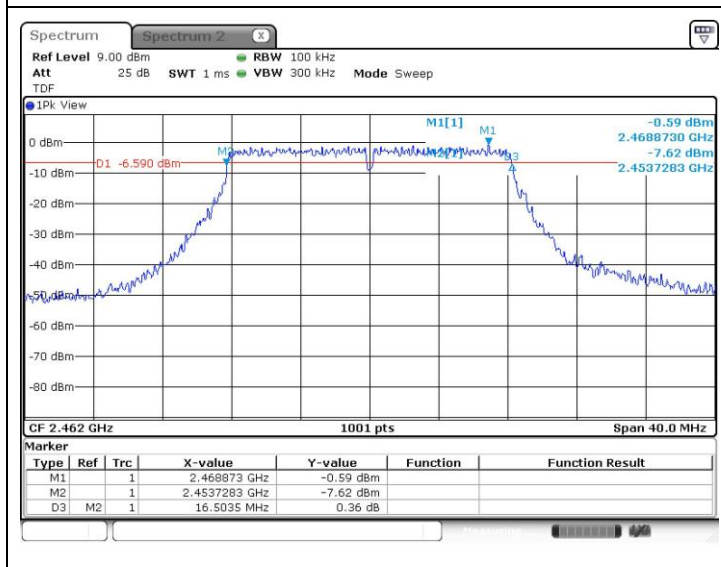

**OFDM: 802.11n\_HT20**

Low Channel

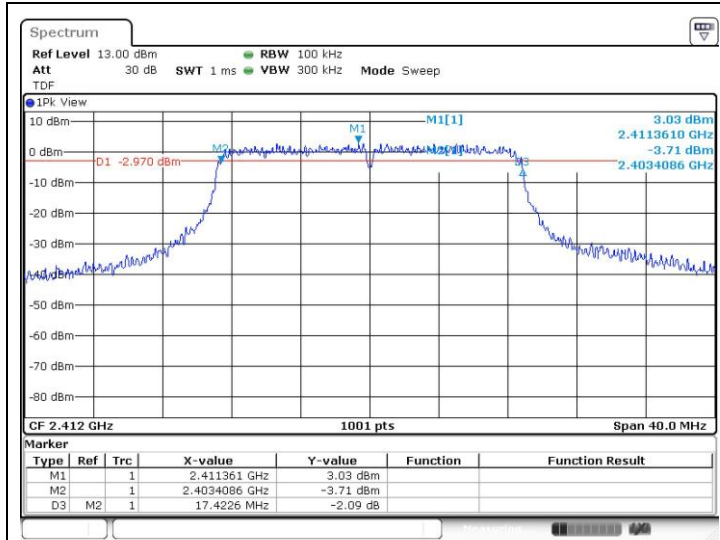

Middle Channel

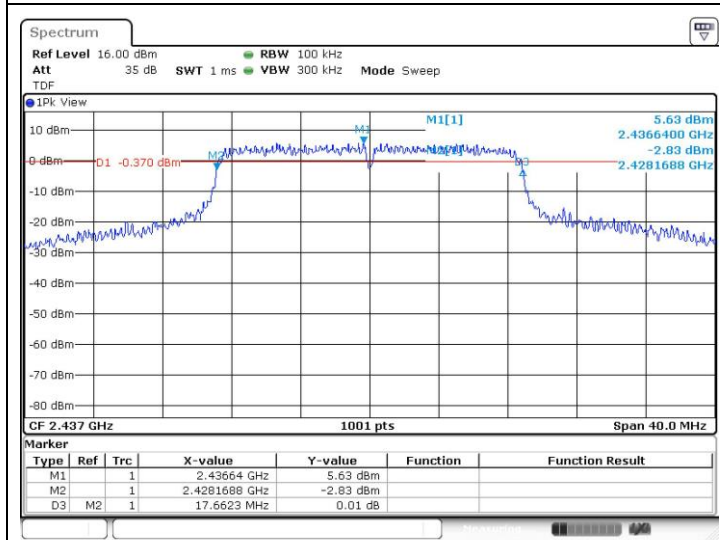

High Channel

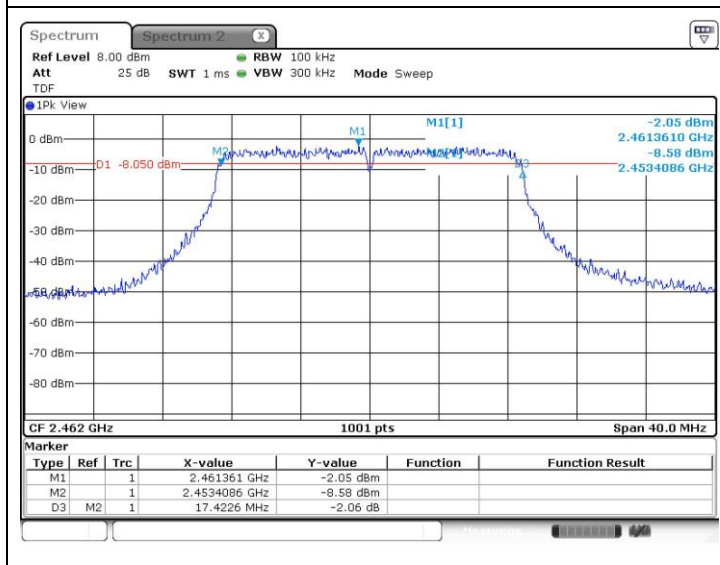

## 4. Maximum Peak Conducted Output Power

### 4.1. Test Setup

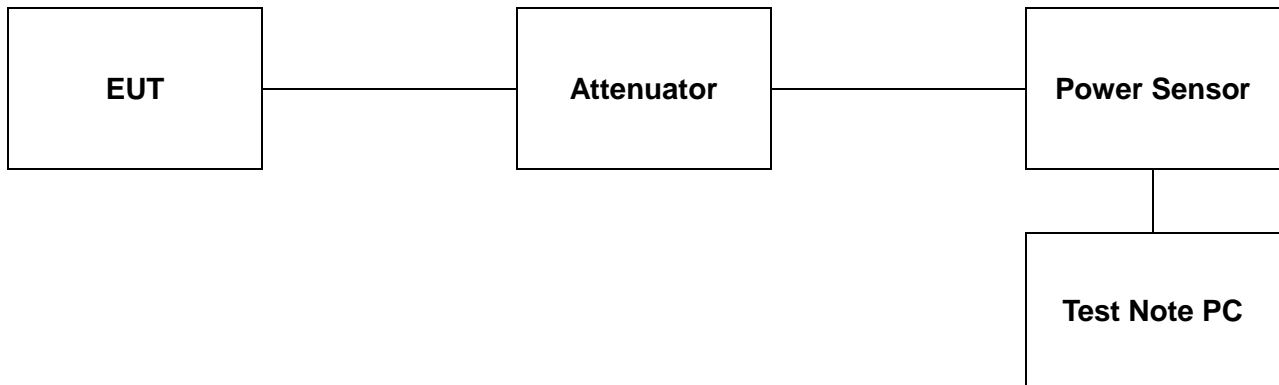

### 4.2. Limit

According to §15.247(b)(3), for systems using digital modulation in the 902-928 MHz, 2 400-2 483.5 MHz, and 5 725-5 850 MHz bands: 1 Watt. As an alternative to a peak power measurement, compliance with the one Watt limit can be based on a measurement of the maximum conducted output power. Maximum Conducted Output Power is defined as the total transmit power delivered to all antennas and antenna elements averaged across all symbols in the signaling alphabet when the transmitter is operating at its maximum power control level. Power must be summed across all antennas and antenna elements. The average must not include any time intervals during which the transmitter is off or is transmitting at a reduced power level. If multiple modes of operation are possible (e.g., alternative modulation methods), the maximum conducted output power is the highest total transmit power occurring in any mode.

According to §15.247(b)(4), the conducted output power limit specified in paragraph (b) of this section is based on the use of antennas with directional gains that do not exceed 6 dBi. Except as shown in paragraph (c) of this section, if transmitting antennas of directional gain greater than 6 dBi are used, the conducted output power from the intentional radiator shall be reduced below the stated values in paragraph (b)(1), (b)(2), and (b)(3) of this section, as appropriate, by the amount in dB that the directional gain of the antenna exceeds 6 dBi.



### 4.3. Test Procedure

The test follows section 11.9.1.3 of ANSI C63.10-2013.

#### **PKPM1 Peak-reading power meter method**

- The maximum peak conducted output power may be measured using a broadband peak RF power meter. The power meter shall have a video bandwidth that is greater than or equal to the DTS bandwidth and shall utilize a fast-responding diode detector.

The test follows section 11.9.2.3.2 of ANSI C63.10-2013.

#### **Method AVGPM-G (Measurement using a gated RF average-reading power meter)**

- Alternatively, measurements may be performed using a wideband gated RF power meter provided that the gate parameters are adjusted such that the power is measured only when the EUT is transmitting at its maximum power control level. Since this measurement is made only during the ON time of the transmitter, no duty cycle correction is required.

#### **Test program: (S/W name: R&S Power Viewer, Version: 3.2.0)**

1. Initially overall offset for attenuator and cable loss is measured per frequency.
2. Measured offset is inserted in test program in advance of measurement for output power.
3. Power for each frequency (channel) of device is investigated as final result.
4. Final result reported on this section from R&S power viewer program includes with several factors and test program shows only final result.

#### 4.4. Test Results

Ambient temperature : (23 ± 1) °C  
 Relative humidity : 47 % R.H.

Mode	Channel	Frequency (MHz)	Data Rate (Mbps)	Average Power Result (dB m)	Peak Power Result (dB m)	Limit (dB m)
DSSS (802.11b)	Low	2 412	1	17.57	20.53	30
	Middle	2 437		17.69	20.59	
	High	2 462		<b><u>17.89</u></b>	<b><u>20.76</u></b>	
OFDM (802.11g)	Low	2 412	6	16.35	21.81	
	Middle	2 437		<b><u>16.62</u></b>	<b><u>21.96</u></b>	
	High	2 462		12.17	18.32	
OFDM (802.11n_HT20)	Low	2 412	MCS0	16.17	22.15	
	Middle	2 437		<b><u>16.52</u></b>	<b><u>22.32</u></b>	
	High	2 462		10.78	17.62	

## 5. Power Spectral Density

### 5.1. Test Setup

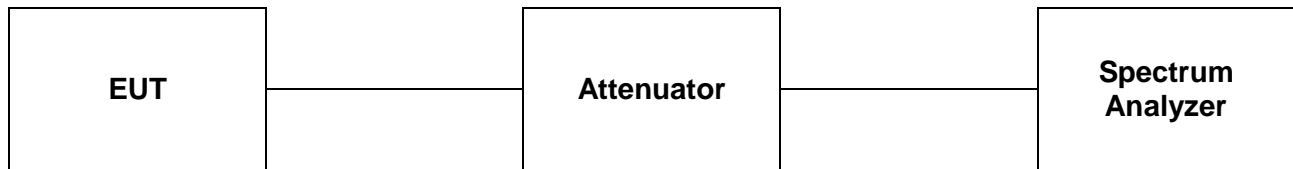

### 5.2. Limit

According to §15.247(e), for digitally modulated systems, the power spectral density conducted from the intentional radiator to the antenna shall not be greater than 8 dBm in any 3 kHz band during any time interval of continuous transmission. This power spectral density shall be determined in accordance with the provisions of paragraph (b) of this section. The same method of determining the conducted output power shall be used to determine the power spectral density.

### 5.3. Test Procedure

The measurements are recorded using the PKPSD measurement procedure in section 11.10.2 of ANSI C63.10-2013.

- This procedure shall be used if maximum peak conducted output power was used to demonstrate compliance, and is optional if the maximum conducted (average) output power was used to demonstrate compliance.

1. Set analyzer center frequency to DTS channel center frequency.
2. Set the span to 1.5 times the DTS bandwidth.
3. Set the RBW to  $3 \text{ kHz} \leq \text{RBW} \leq 100 \text{ kHz}$ .
4. Set the VBW  $\geq [3 \times \text{RBW}]$ .
5. Detector = peak.
6. Sweep time = auto couple.
7. Trace mode = max hold.
8. Allow trace to fully stabilize.
9. Use the peak marker function to determine the maximum amplitude level within the RBW.
10. If measured value exceeds requirement, then reduce RBW (but no less than 3 kHz) and repeat.

### 5.4. Test Results

Ambient temperature : (23 ± 1) °C  
 Relative humidity : 47 % R.H.

Operation Mode	Data Rate (Mbps)	Channel	Frequency (MHz)	Measured PSD (dB m/3 kHz)	Limit (dB m/3 kHz)
DSSS (802.11b)	1	Low	2 412	-6.59	8
		Middle	2 437	-6.54	
		High	2 462	-5.94	
OFDM (802.11g)	6	Low	2 412	-12.29	
		Middle	2 437	-11.84	
		High	2 462	-16.45	
OFDM (802.11n_HT20)	MCS0	Low	2 412	-11.74	
		Middle	2 437	-11.56	
		High	2 462	-17.08	

**- Test plots**

**DSSS: 802.11b**

Low Channel

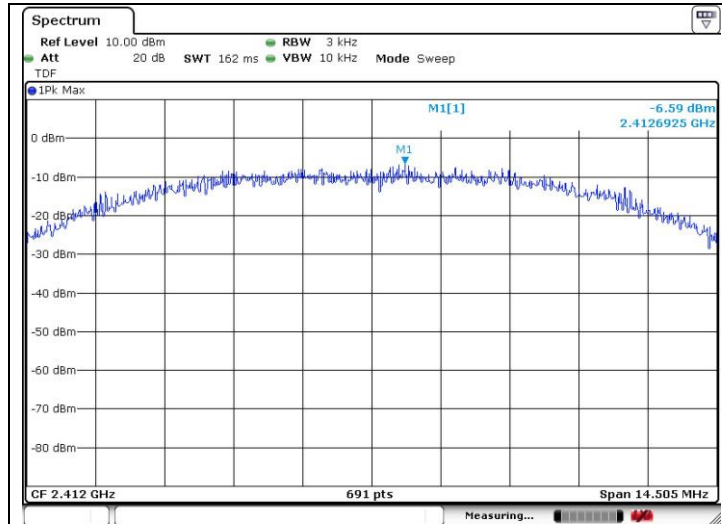

Middle Channel

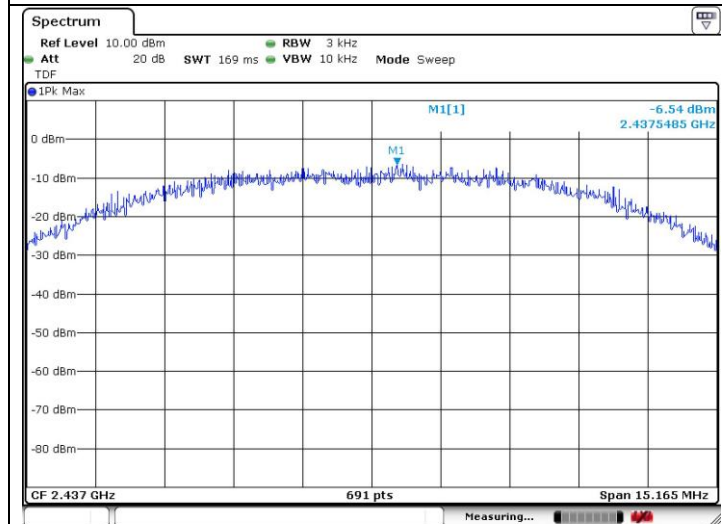

High Channel

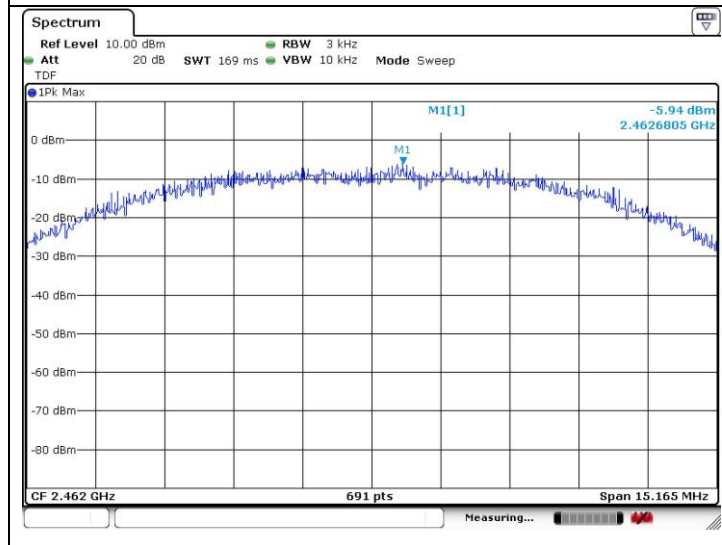

**OFDM: 802.11g**

Low Channel

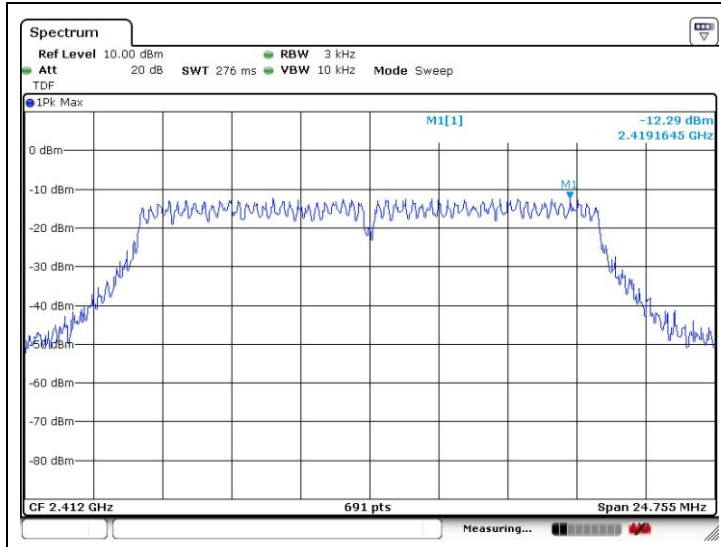

Middle Channel

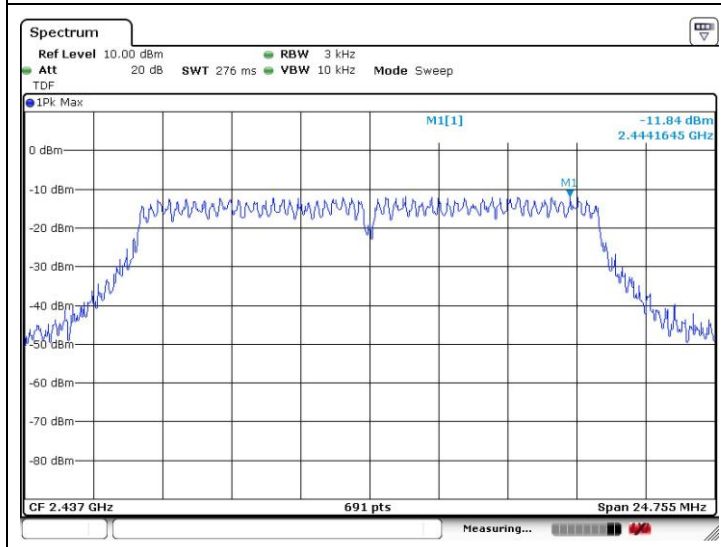

High Channel

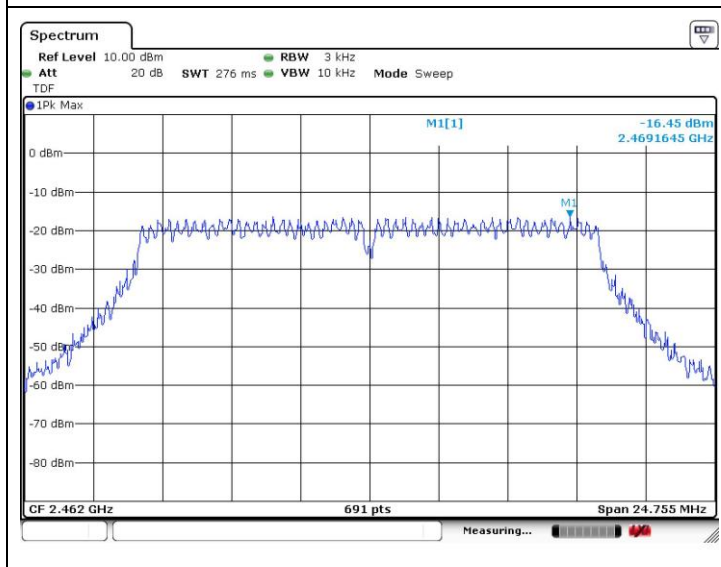

**OFDM: 802.11n\_HT20**

Low Channel

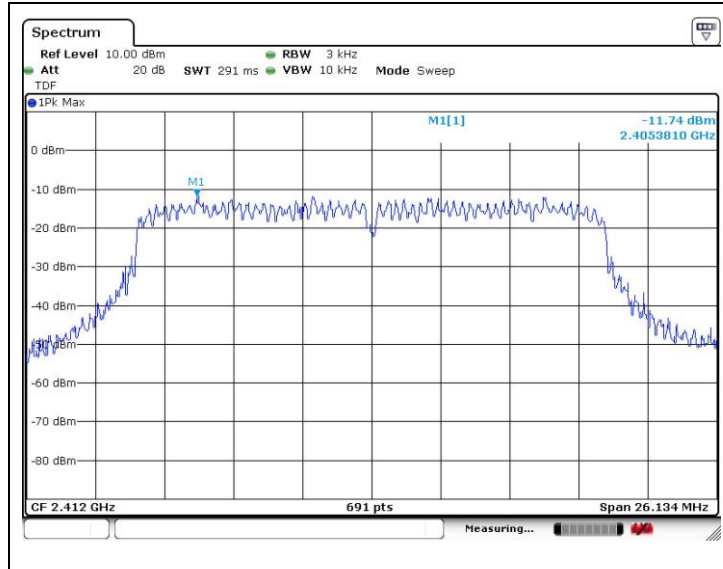

Middle Channel

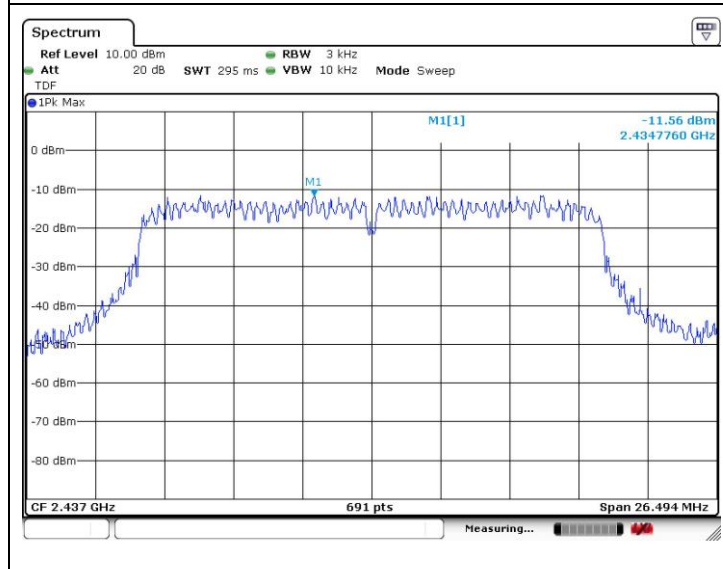

High Channel

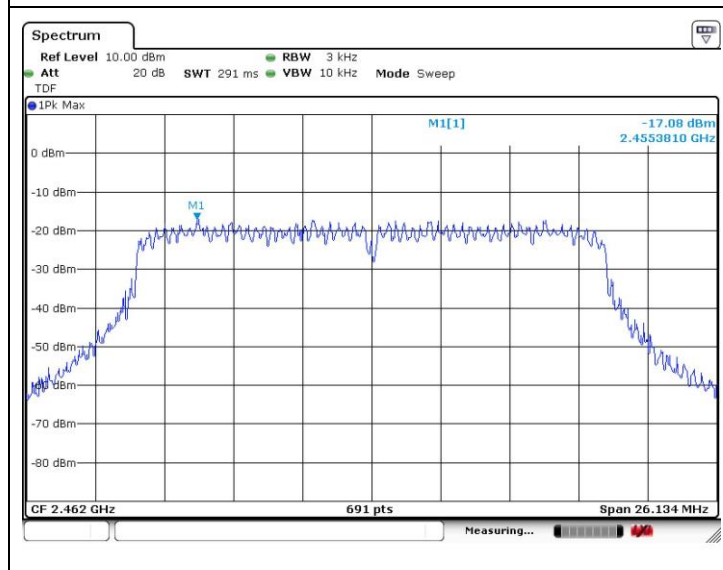

## 6. AC Power Line Conducted Emission

### 6.1. Test Setup

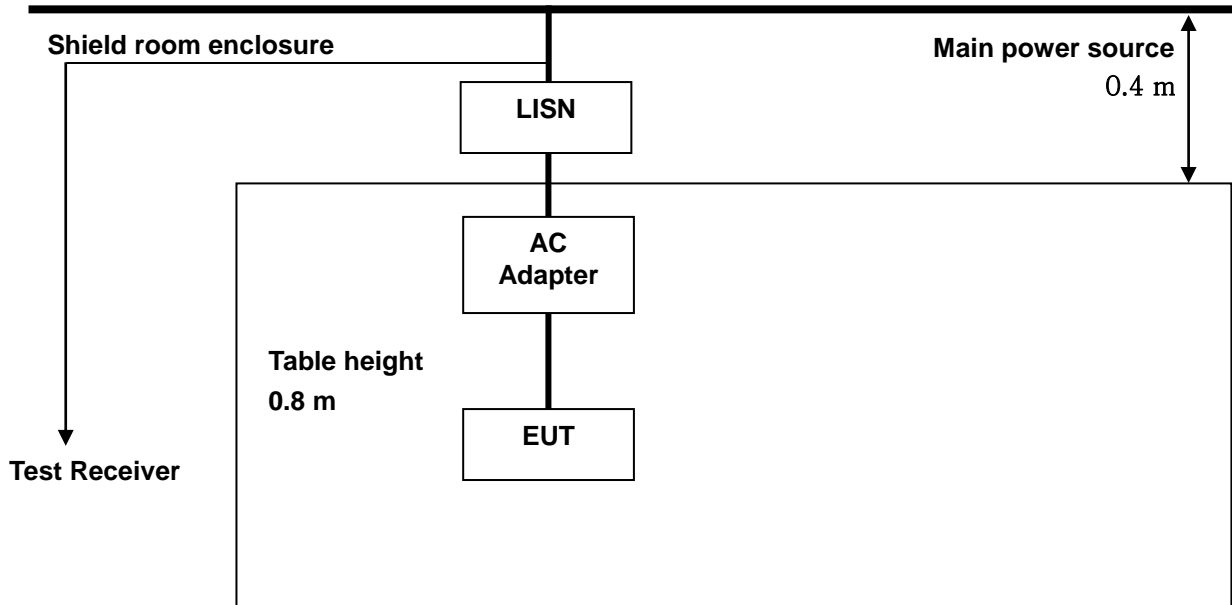

### 6.2. Limit

According to §15.207(a), for an intentional radiator that is designed to be connected to the public utility (AC) power line, the radio frequency voltage that is conducted back onto the AC power line on any frequency or frequencies, within the band 150 kHz to 30 MHz, shall not exceed the limits in the following table, as measured using a 50 µH /50 ohms line impedance stabilization network (LISN).

Compliance with the provision of this paragraph shall be based on the measurement of the radio frequency voltage between each power line and ground at the power terminal. The lower limit applies at the boundary between the frequency ranges.

Frequency of emission (MHz)	Conducted limit (dBµV)	
	Quasi-peak	Average
0.15-0.5	66 to 56*	56 to 46*
0.5-5	56	46
5-30	60	50

\* Decreases with the logarithm of the frequency.



### 6.3. Test Procedures

AC conducted emissions from the EUT were measured according to the dictates of ANSI C63.10-2013

1. The test procedure is performed in a 6.5 m × 3.5 m × 3.5 m (L × W × H) shielded room. The EUT along with its peripherals were placed on a 1.0 m (W) × 1.5 m (L) and 0.8 m in height wooden table and the EUT was adjusted to maintain a 0.4 meter space from a vertical reference plane.
2. The EUT was connected to power mains through a line impedance stabilization network (LISN) which provides 50 ohm coupling impedance for measuring instrument and the chassis ground was bounded to the horizontal ground plane of shielded room.
3. All peripherals were connected to the second LISN and the chassis ground also bounded to the horizontal ground plane of shielded room.
4. The excess power cable between the EUT and the LISN was bundled. The power cables of peripherals were unbundled. All connecting cables of EUT and peripherals were moved to find the maximum emission.

### 6.4. Test Results

The following table shows the highest levels of conducted emissions on both phase of Hot and Neutral line.

Ambient temperature : (23 ± 1) °C  
 Relative humidity : 47 % R.H.  
 Frequency range : 0.15 MHz - 30 MHz  
 Measured Bandwidth : 9 kHz

FREQ. (MHz)	LEVEL (dBμV)		LINE	LIMIT (dBμV)		MARGIN (dB)	
	Q-Peak	Average		Q-Peak	Average	Q-Peak	Average
0.25	40.60	32.30	N	61.76	51.76	21.16	19.46
0.40	49.10	41.10	N	57.85	47.85	8.75	6.75
0.51	44.00	35.70	N	56.00	46.00	12.00	10.30
1.43	41.30	33.10	N	56.00	46.00	14.70	12.90
1.66	40.50	30.20	N	56.00	46.00	15.50	15.80
2.43	40.20	32.30	N	56.00	46.00	15.80	13.70
0.23	37.60	28.10	H	62.45	52.45	24.85	24.35
0.40	45.00	37.20	H	57.85	47.85	12.85	10.65
0.46	42.00	34.30	H	56.69	46.69	14.69	12.39
0.86	36.80	27.60	H	56.00	46.00	19.20	18.40
1.46	38.50	30.10	H	56.00	46.00	17.50	15.90
2.41	36.90	29.10	H	56.00	46.00	19.10	16.90

**Remark;**

1. Line (H): Hot, Line (N): Neutral.
2. All data rates and modes of operation were investigated and the worst-case emissions were reported using **11n HT20 / MCS0 / Middle channel**.
3. The limit for Class B device(s) from 150 kHz to 30 MHz are specified in Section of the Title 47 CFR.
4. Traces shown in plot were made by using a peak detector and average detector.
5. Deviations to the Specifications: None.

**- Test plots**

Test mode: (Neutral)

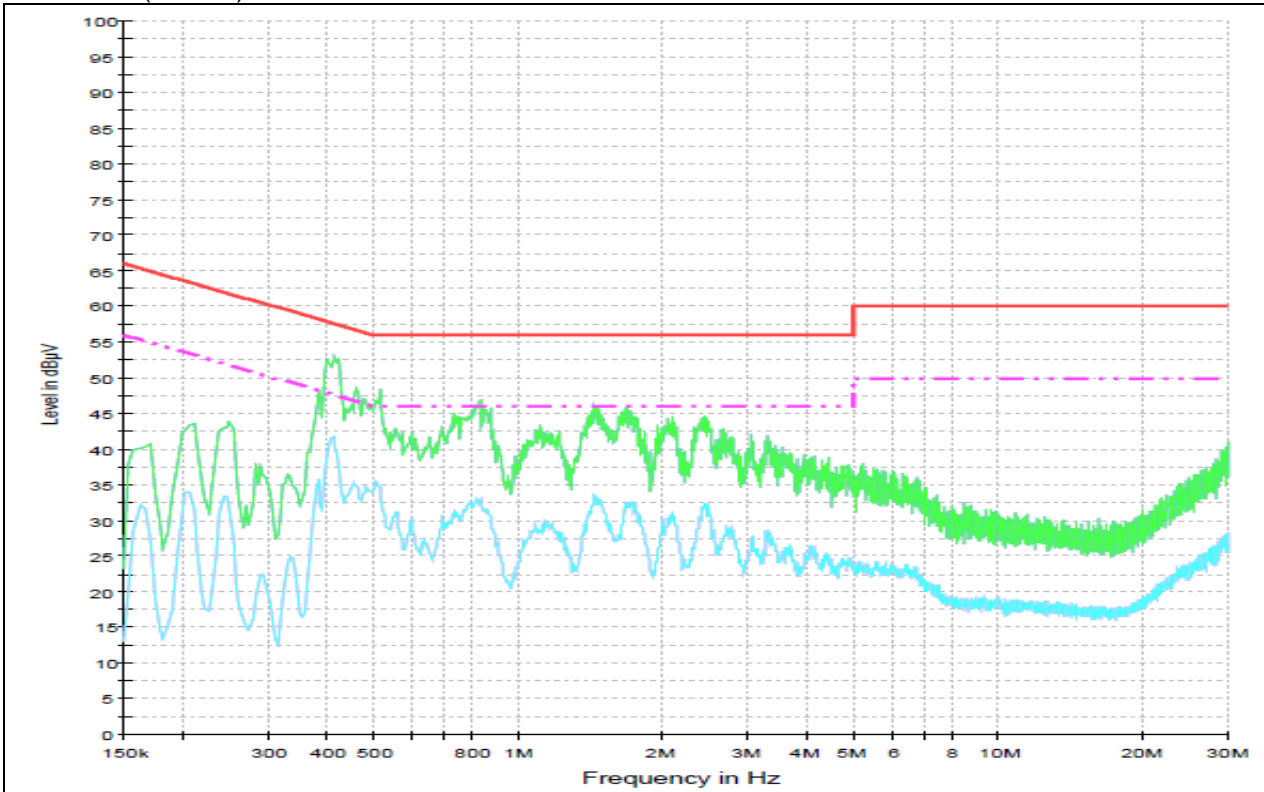

Test mode: (Hot)

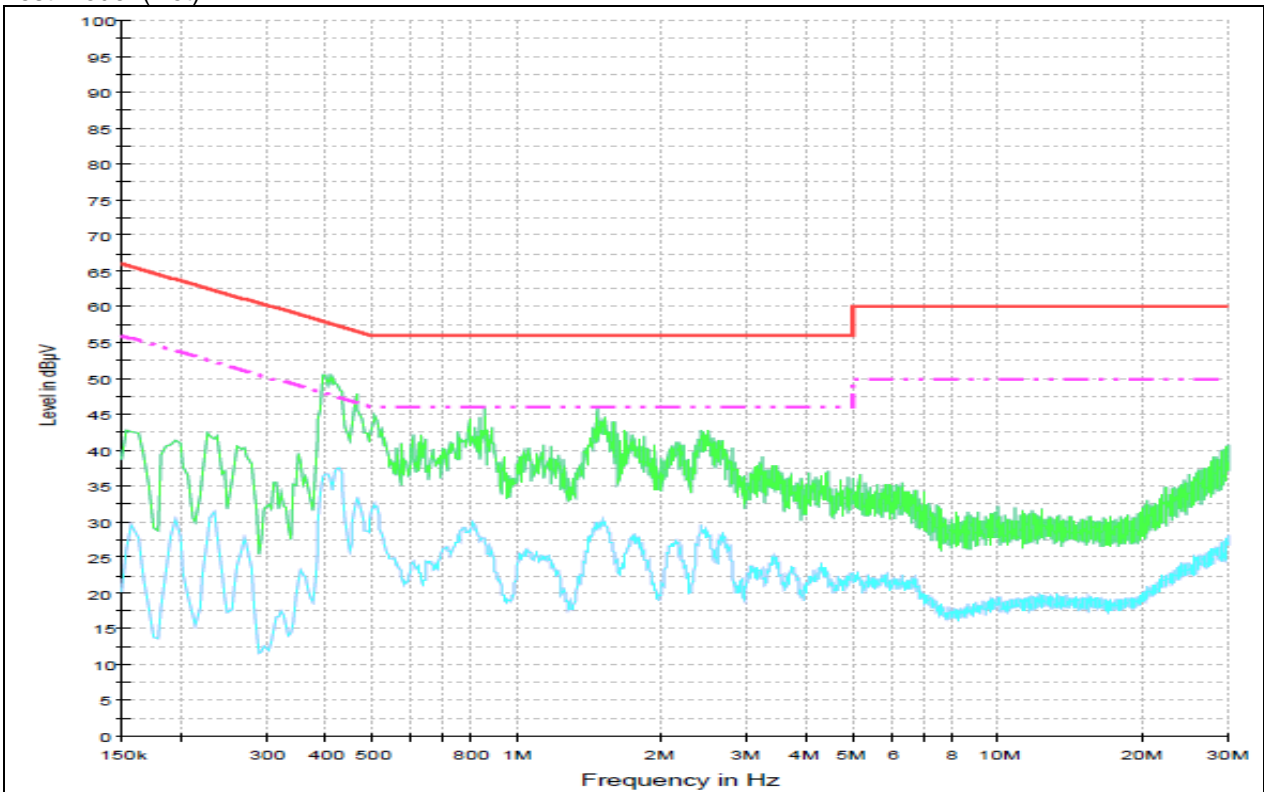

## 7. Antenna Requirement

### 7.1. Standard Applicable

For intentional device, according to FCC 47 CFR Section §15.203, an intentional radiator shall be designed to ensure that no antenna other than that furnished by the responsible party shall be used with the device. And according to FCC 47 CFR Section §15.247(b) if transmitting antennas of directional gain greater than 6 dB i are used, the power shall be reduced by the amount in dB that the gain of the antenna exceeds 6 dB i.

### 7.2. Antenna Connected Construction

Antenna used in this product is FPC antenna with gain of 3 dB i.