

# TEST REPORT

<p><b>DT&amp;C Co., Ltd.</b> 42, Yurim-ro, 154Beon-gil, Cheoin-gu, Yongin-si, Gyeonggi-do, Korea Tel : 031-321-2664, Fax : 031-321-1664</p>	<p>Report No : DRTFCC1511-0228(1) Pages:(1) / (80) page</p>	
<p>1. Customer</p> <ul style="list-style-type: none"><li>• Name : SNK Technologies Co.,Ltd.</li><li>• Address : 5, Ojeongongeoop-gil, Uiwang-si, Gyeonggi-do, Korea</li></ul> <p>2. Use of Report : FCC Original Grant</p> <p>3. Product Name (Model) : SNK STEREO HEADSET (SBH-H100, SBH-H100G2, SBH-H100S2, SBH-H100B2, SBH-H100P2, SBH-H100W2, SBH-H100U2, SBH-H100L2, SBH-H100R2)</p> <p>4. Date of Test : 2015-10-12 ~ 2015-10-19</p> <p>5. Test Method Used: FCC Part 15 Subpart C.247</p> <p>6. Testing Environment : See appended test report</p> <p>7. Test Result : <input checked="" type="checkbox"/> Pass <input type="checkbox"/> Fail</p> <p>The results shown in this test report refer only to the sample(s) tested unless otherwise stated. This Test Report cannot be reproduced, except in full.</p>		
Affirmation	Tested by Name : Chulmin Kim (Signature)	Technical Manager Name : GeunKi Son (Signature)
<p style="text-align: center;"><b>2015. 11. 13.</b> <b>DT&amp;C Co., Ltd.</b></p>		

## Test Report Version

Test Report No.	Date	Description
DRTFCC1511-0228	Nov. 02, 2015	Initial issue
DRTFCC1511-0228(1)	Nov. 13, 2015	Update add model name

# Table of Contents

- 1. General Information ..... 4
  - 1.1 Testing Laboratory .....4
  - 1.2 Details of Applicant .....4
  - 1.3 Description of EUT .....4
  - 1.4 Declaration by the applicant / manufacturer .....5
  - 1.5 Information about the FHSS characteristics .....5
  - 1.6 Test conditions .....5
  - 1.7 Test Equipment List.....6
  - 1.8 Summary of Test Results.....7
  - 1.9 Conclusion of worst-case and operation mode.....8
- 2. Maximum Peak Output Power Measurement ..... 9
  - 2.1 Test Setup .....9
  - 2.2 Limit.....9
  - 2.3 Test Procedure.....9
  - 2.4 Test Results .....10
- 3. 20 dB BW ..... 16
  - 3.1 Test Setup .....16
  - 3.2 Limit.....16
  - 3.3 Test Procedure.....16
  - 3.4 Test Results .....16
- 4. Carrier Frequency Separation ..... 22
  - 4.1 Test Setup .....22
  - 4.2 Limit.....22
  - 4.3 Procedure.....22
  - 4.4 Test Results .....22
- 5. Number of Hopping Frequencies ..... 27
  - 5.1 Test Setup .....27
  - 5.2 Limit.....27
  - 5.3 Procedure.....27
  - 5.4 Test Results .....27
- 6. Time of Occupancy (Dwell Time)..... 33
  - 6.1 Test Setup .....33
  - 6.2 Limit.....33
  - 6.3 Test Procedure.....33
  - 6.4 Test Results .....33
- 7. Transmitter Radiated Spurious Emissions and Conducted Spurious Emission ..... 38
  - 7.1 Test Setup .....38
  - 7.2 Limit.....38
  - 7.3. Test Procedures.....39
    - 7.3.1. Test Procedures for Radiated Spurious Emissions .....39
    - 7.3.2. Test Procedures for Conducted Spurious Emissions.....40
    - 7.3.3. Test Plot .....40
  - 7.4. Test Results .....41
    - 7.4.1. Radiated Emissions.....41
    - 7.4.2. Conducted Spurious Emissions .....44
- 8. Transmitter AC Power Line Conducted Emission ..... 68
  - 8.1 Test Setup .....68
  - 8.2 Limit.....68
  - 8.3 Test Procedures.....68
  - 8.4 Test Results .....68
- 9. Antenna Requirement..... 69
- 10. Occupied Bandwidth (99 %) ..... 70
  - 10.1 Test Setup .....70
  - 10.2 Limit.....70
  - 10.3 Test Procedure.....70
  - 10.4 Test Results .....70
- APPENDIX I..... 71
- APPENDIX II..... 72

## 1. General Information

### 1.1 Testing Laboratory

DT&C Co., Ltd.			
Standard	Site number	Address	
FCC	<input checked="" type="checkbox"/>	165783	42, Yurim-ro 154 beon-gil, Cheoin -gu, Yongin-si, Gyeonggi -do, South Korea 449-935
	<input type="checkbox"/>	804488	42, Yurim-ro 154 beon-gil, Cheoin -gu, Yongin-si, Gyeonggi -do, South Korea 449-935
	<input type="checkbox"/>	596748	42, Yurim-ro 154 beon-gil, Cheoin -gu, Yongin-si, Gyeonggi -do, South Korea 449-935
	<input type="checkbox"/>	678747	683-3, Yubang-dong, Cheoin-gu, Yongin-si, Kyeonggi-do, Korea, 449-080
IC	<input type="checkbox"/>	5740A-3	42, Yurim-ro 154 beon-gil, Cheoin -gu, Yongin-si, Gyeonggi -do, South Korea 449-935
	<input type="checkbox"/>	5740A-2	683-3, Yubang-dong, Cheoin-gu, Yongin-si, Kyeonggi-do, Korea, 449-080
<a href="http://www.dtnc.net">www.dtnc.net</a>			
Telephone	:	+ 82-31-321-2664	
FAX	:	+ 82-31-321-1664	

### 1.2 Details of Applicant

Applicant : SNK Technologies Co.,Ltd.  
 Address : 5, Ojeongongeoop-gil, Uiwang-si, Gyeonggi-do, Korea  
 Contact person : KIM, SEONG KI

### 1.3 Description of EUT

<b>EUT</b>	SNK STEREO HEADSET
<b>Model Name</b>	SBH-H100
<b>Add Model Name</b>	SBH-H100G2, SBH-H100S2, SBH-H100B2, SBH-H100P2, SBH-H100W2, SBH-H100U2, SBH-H100L2, SBH-H100R2
<b>Serial Number</b>	Identical prototype
<b>Hardware version</b>	1.0.0
<b>Software version</b>	1.0.0
<b>Power Supply</b>	DC 3.7 V
<b>Battery type</b>	Standard Battery: Lithium Ion Battery
<b>Frequency Range</b>	2402 MHz ~ 2480 MHz
<b>Modulation Technique</b>	GFSK, $\pi/4$ -DQPSK, 8DPSK
<b>Number of Channels</b>	79
<b>Antenna Type</b>	Internal Antenna
<b>Antenna Gain</b>	PK : 1.57 dBi

### 1.4 Declaration by the applicant / manufacturer

- The applicant declares that there is some difference between the models.  
For detailed information, please refer to the ID letter.

### 1.5 Information about the FHSS characteristics

- This Bluetooth module has been tested by a Bluetooth Qualification Lab, and we confirm the following :
  - A) The hopping sequence is pseudorandom
  - B) All channels are used equally on average
  - C) The receiver input bandwidth equals the transmit bandwidth
  - D) The receiver hops in sequence with the transmit signal
- 15.247(g) : In accordance with the Bluetooth Industry Standard, the system must be designed to comply with all of the regulations in Section 15.247 should the transmitter be presented with a continuous data (or information) stream.
- 15.247(h) : In accordance with the Bluetooth Industry Standard, the system does not coordinate its channels selection / hopping sequence with other frequency hopping systems for the express purpose of avoiding the simultaneous occupancy of individual hopping frequencies by multiple transmitters.
- 15.247(h) : The EUT employs Adaptive Frequency Hopping (AFH) which identifies sources of interference namely devices operating in 802.11 WLAN and excludes them from the list of available channels. The process of re-mapping reduces the number of test channels from 79 channels to a minimum number of 20 channels.

### 1.6 Test conditions

Ambient Condition	
▪ Temperature	+23 °C ~ +24 °C
▪ Relative Humidity	43 % ~ 46 %

## 1.7 Test Equipment List

Type	Manufacturer	Model	Cal.Date (yy/mm/dd)	Next.Cal.Date (yy/mm/dd)	S/N
MXA Signal Analyzer	Agilent Technologies	N9020A	15/09/09	16/09/09	MY46471248
Digital Multimeter	Agilent Technologies	34401A	15/01/06	16/01/06	US36099541
DC Power Supply	HP	66332A	15/01/22	16/01/22	US37471368
Vector Signal Generator	Rohde Schwarz	SMBV100A	15/01/06	16/01/06	255571
Signal Generator	Rohde Schwarz	SMF100A	15/06/29	16/06/29	102341
BlueTooth Tester	TESCOM	TC-3000B	15/01/06	16/01/06	3000B770243
Thermohygrometer	BODYCOM	BJ5478	15/05/08	16/05/08	120612-2
Low Noise Pre Amplifier	tsj	MLA-010K01-B01-27	15/04/09	16/04/09	1844538
PreAmplifier	Agilent Technologies	8449B	15/02/26	16/02/26	3008A00370
Loop Antenna	Schwarzbeck	FMZB1513	14/04/29	16/04/29	1513-128
Double-Ridged Guide Antenna	ETS	3117	14/05/12	16/05/12	140394
Horn Antenna	A.H.Systems Inc.	SAS-574	15/04/30	17/04/30	154
TRILOG Broadband Test-Antenna	Schwarzbeck	VULB 9160	14/04/30	16/04/30	3358
High-pass filter	Wainwright Instruments	WHKX3.0	15/01/06	16/01/06	12
EMI TEST RECEIVER	Rohde Schwarz	ESR7	14/10/21	15/10/21	101109
Power Meter & Wide Bandwidth Sensor	Anritsu	ML2496A/MA2411B	15/06/25	16/06/25	1338004/ 1306053

### 1.8 Summary of Test Results

FCC Part RSS Std.	Parameter	Limit (Using in 2400~ 2483.5 MHz)	Test Condition	Status Note 1
15.247(a) RSS-247(5.1)	Carrier Frequency Separation	>= 20 dB BW or >= Two thirds of the 20 dB BW, whichever is greater.	Conducted	C
	Number of Hopping Frequencies	>= 15 hops		C
	20 dB Bandwidth	None		C
	Dwell Time	=< 0.4 seconds		C
15.247(b) RSS-247(5.4)	Transmitter Output Power	<b>For FCC</b> =< 1 Watt , if CHs >= 75 Others =< 0.125 W <b>For IC</b> if CHs >= 75 =< 1 Watt For Conducted Power =< 4 Watt For e.i.r.p, Others =< 0.125 W For Conducted Power. =< 0.5 Watt For e.i.r.p		C
15.247(d) RSS-247(5.5)	Conducted Spurious Emissions	The radiated emission to any 100 kHz of out-band shall be at least 20 dB below the highest in-band spectral density.		C
RSS Gen(6.6)	Occupied Bandwidth (99 %)	RSS-Gen		C
15.205 & 209 RSS-247(5.5) RSS-Gen (8.9 & 8.10)	Radiated Spurious Emissions	FCC 15.209 Limits RSS-Gen 8.9	Radiated	C Note2
15.207 RSS-Gen(8.8)	AC Conducted Emissions	FCC 15.207 Limits	AC Line Conducted	NA Note3
15.203 RSS-Gen(6.7)	Antenna Requirements	FCC 15.203	-	C
<p>Note 1 : <b>C</b> = Comply    <b>NC</b> = Not Comply    <b>NT</b> = Not Tested    <b>NA</b> = Not Applicable</p> <p>Note 2 : This test item was performed in each axis and the worst case data was reported.</p> <p>Note 3 : This test is not applicable. Because the power of this device supplied from only battery.</p> <p>Note 4 : The sample was tested according to the following specifications : - ANSI C63.10-2013</p>				

## 1.9 Conclusion of worst-case and operation mode

The EUT has three type of modulation (GFSK,  $\pi/4$ DQPSK and 8DPSK).

Therefore all applicable requirements were tested with all the modulations.

The field strength of spurious emission was measured in three orthogonal EUT positions(X-axis, Y-axis and Z-axis).

Tested frequency information,

- Hopping Function : Enable

	TX Frequency (MHz)	RX Frequency (MHz)
<b>Hopping Band</b>	2402 ~ 2480	2402 ~ 2480

- Hopping Function : Disable

	TX Frequency (MHz)	RX Frequency (MHz)
<b>Lowest Channel</b>	2402	2402
<b>Middle Channel</b>	2441	2441
<b>Highest Channel</b>	2480	2480

## 2. Maximum Peak Output Power Measurement

### 2.1 Test Setup

Refer to the APPENDIX I.

### 2.2 Limit

#### ■ FCC Requirements

The maximum peak output power of the intentional radiator shall not exceed the following :

1. §15.247(a)(1), Frequency hopping systems shall have hopping channel carrier frequencies separated by a minimum of 25 kHz or the 20 dB bandwidth of the hopping channel, whichever is greater, provided the systems operate with an output power no greater than 125 mW.
2. §15.247(b)(1), For frequency hopping systems operating in the 2400 – 2483.5 MHz band employing at least 75 non-overlapping hopping channels, and all frequency hopping systems in the 5725 – 5805 MHz band : 1 Watt.

#### ■ IC Requirements

1. RSS-247(5.4), For FHSs operating in the band 2400 - 2483.5 MHz, the maximum peak conducted output power shall not exceed 1.0 W and the e.i.r.p. shall not exceed 4 W if the hopset uses 75 or more hopping channels the maximum peak conducted output power shall not exceed 0.125 W and the e.i.r.p. shall not exceed 0.5 W if the hopset uses less than 75 hopping channels

### 2.3 Test Procedure

1. The RF output power was measured with a spectrum analyzer connected to the RF Antenna connector (conducted measurement) while EUT was operating in transmit mode at the appropriate center frequency, A spectrum analyzer was used to record the shape of the transmit signal.
2. The bandwidth of the fundamental frequency was measured with the spectrum analyzer using ;  
Span = approximately 5 times of the 20 dB bandwidth, centered on a hopping channel  
RBW  $\geq$  20 dB BW  
VBW  $\geq$  RBW  
Sweep = auto  
Detector function = peak  
Trace = max hold

## 2.4 Test Results

Modulation	Tested Channel	Frame Average Output Power		Peak Output Power	
		dBm	mW	dBm	mW
<b><u>GFSK</u></b>	<b>Lowest</b>	-4.11	0.388	-1.21	0.757
	<b>Middle</b>	-2.80	0.525	<b>0.92</b>	<b>1.236</b>
	<b>Highest</b>	<b>-2.70</b>	<b>0.537</b>	0.57	1.140
<b><u><math>\pi/4</math>DQPSK</u></b>	<b>Lowest</b>	-7.67	0.171	-4.66	0.342
	<b>Middle</b>	-6.48	0.225	-3.37	0.460
	<b>Highest</b>	<b>-6.35</b>	<b>0.232</b>	<b>-3.04</b>	<b>0.497</b>
<b><u>8DPSK</u></b>	<b>Lowest</b>	-7.68	0.171	-4.31	0.371
	<b>Middle</b>	-6.44	0.227	-2.92	0.511
	<b>Highest</b>	<b>-6.33</b>	<b>0.233</b>	<b>-2.72</b>	<b>0.535</b>

Note 1 : Average output power was using the average power meter for reference only.

Note 2 : See next pages for actual measured spectrum plots.

### Peak Output Power

### Lowest Channel & Modulation : GFSK

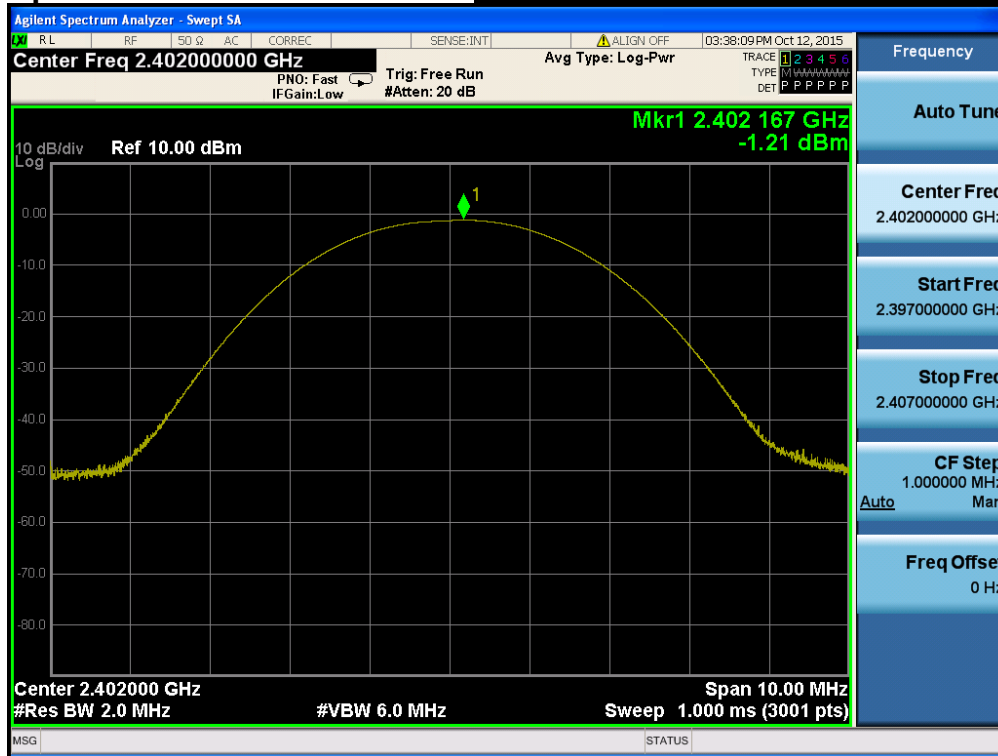

### Peak Output Power

### Middle Channel & Modulation : GFSK

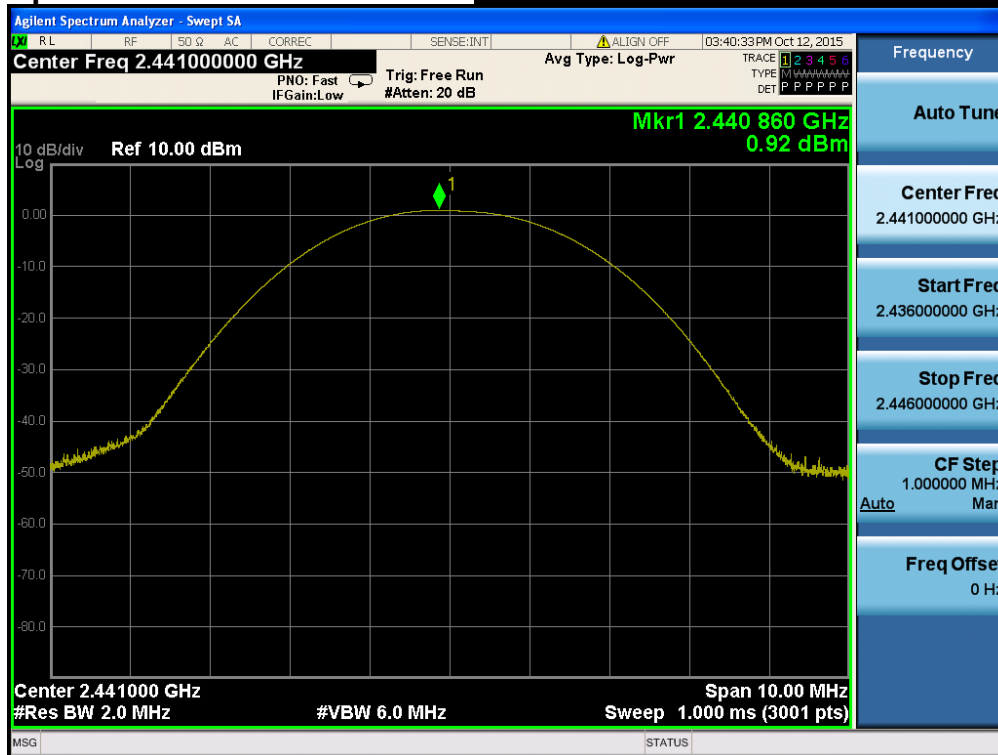

**Peak Output Power**

***Highest Channel & Modulation : GFSK***

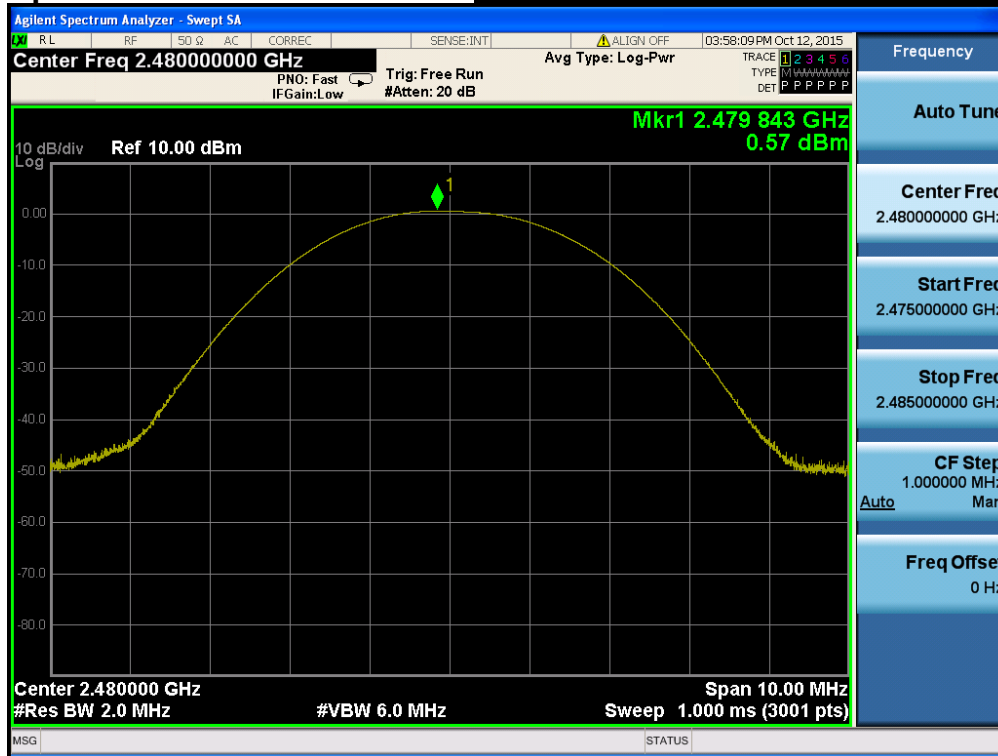

**Peak Output Power**

***Lowest Channel & Modulation :  $\pi/4$ DQPSK***

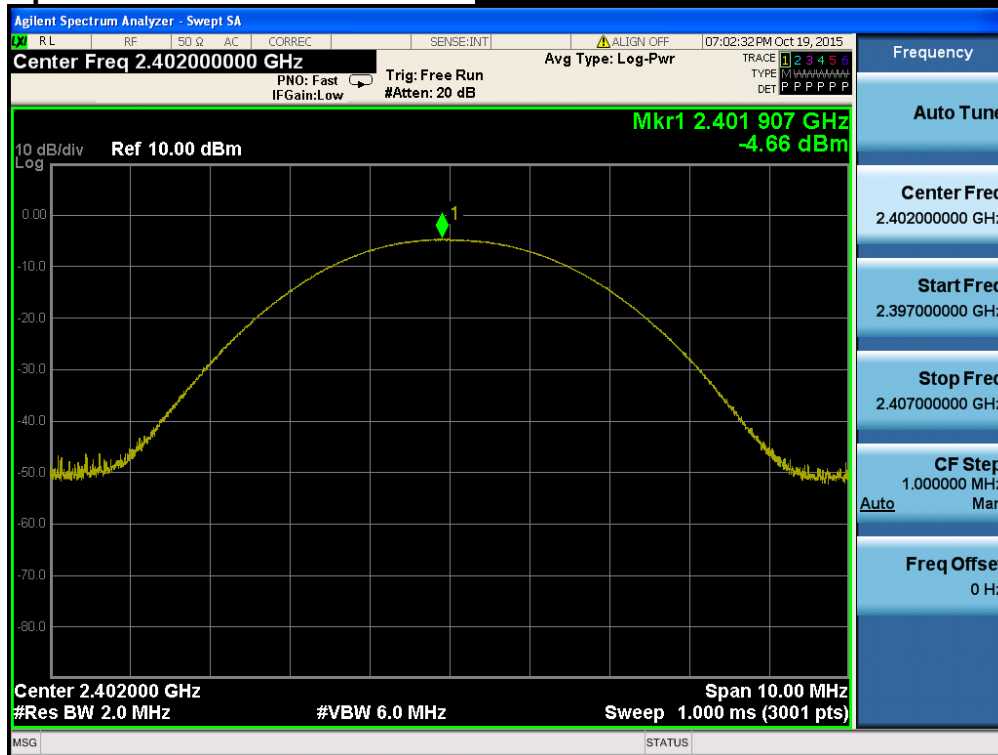

**Peak Output Power**

***Middle Channel & Modulation :  $\pi/4$ DQPSK***

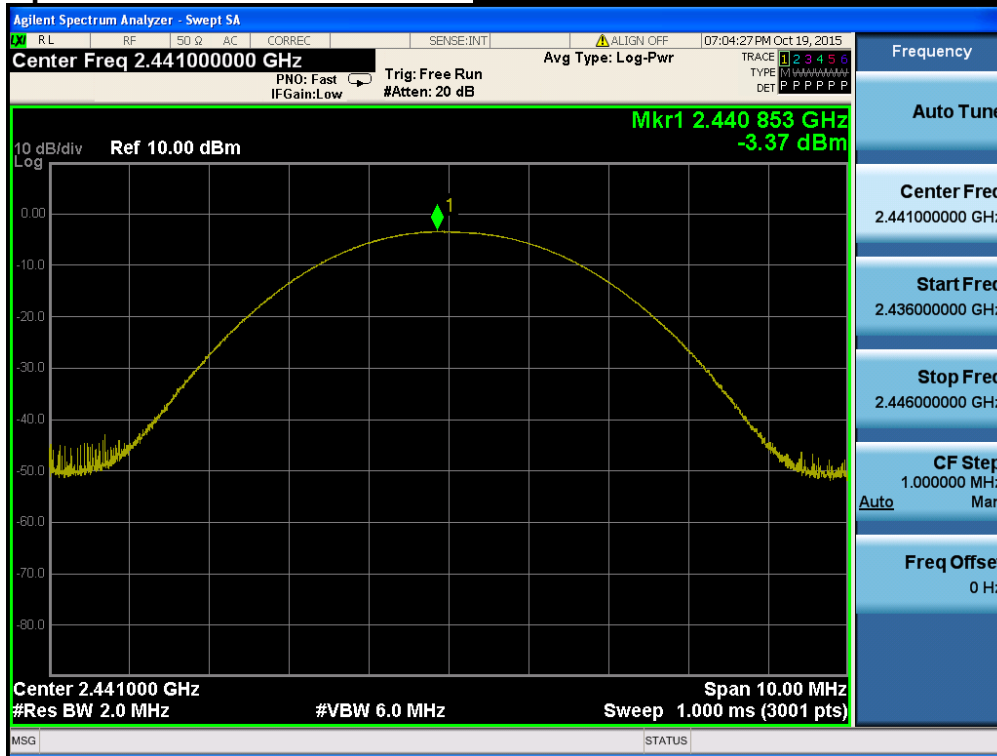

**Peak Output Power**

***Highest Channel & Modulation :  $\pi/4$ DQPSK***

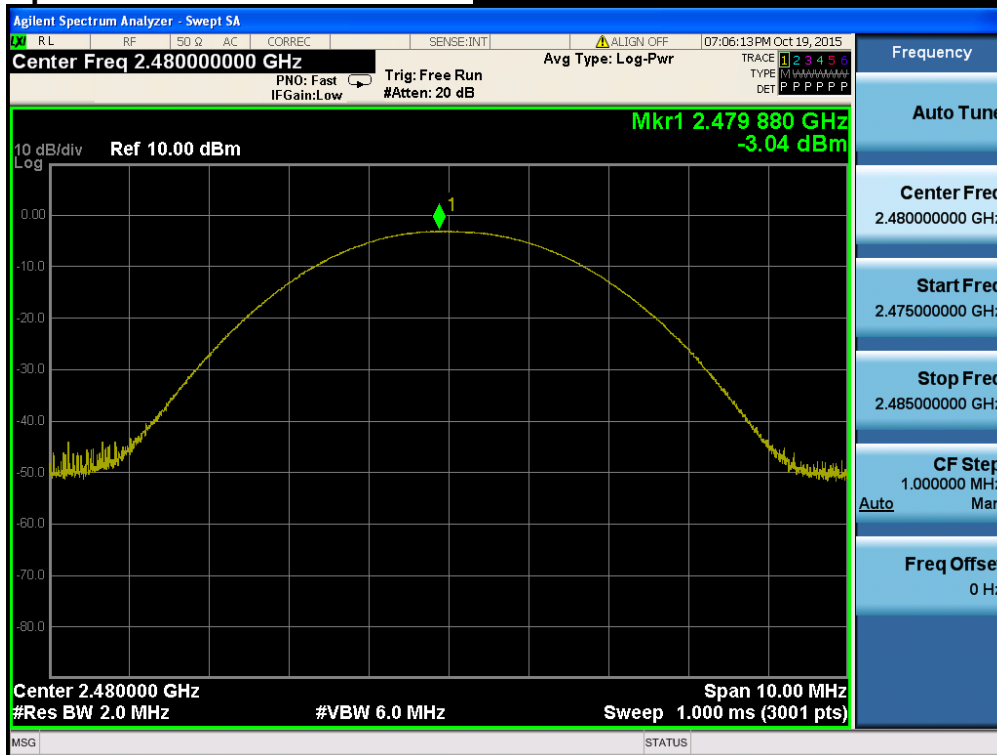

### Peak Output Power

### *Lowest Channel & Modulation : 8DPSK*

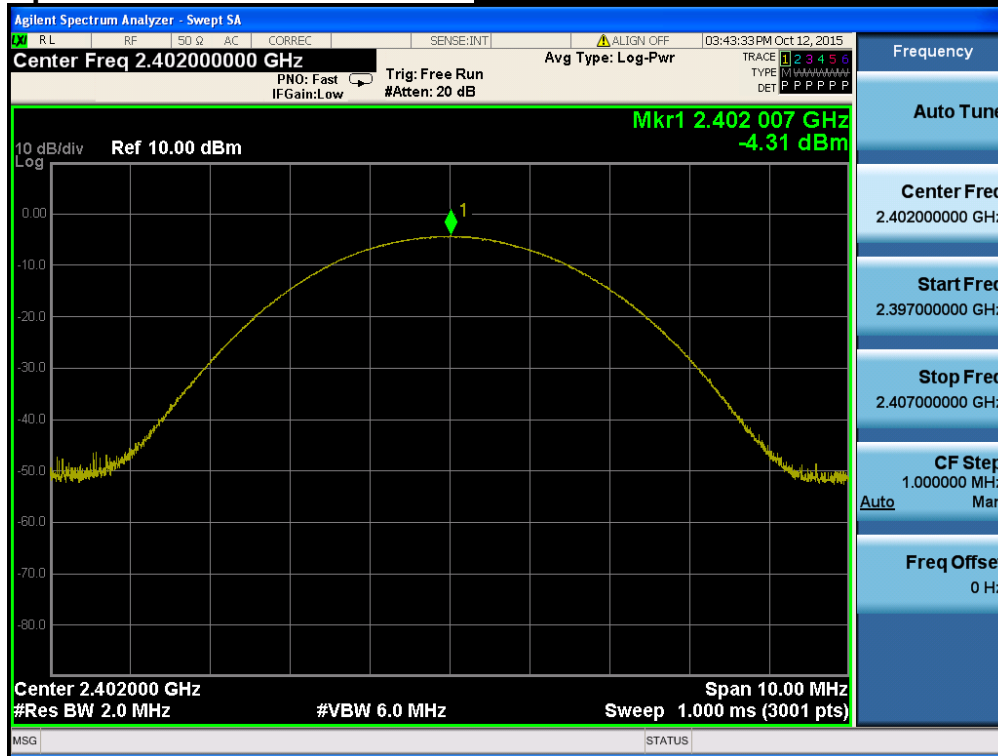

### Peak Output Power

### *Middle Channel & Modulation : 8DPSK*

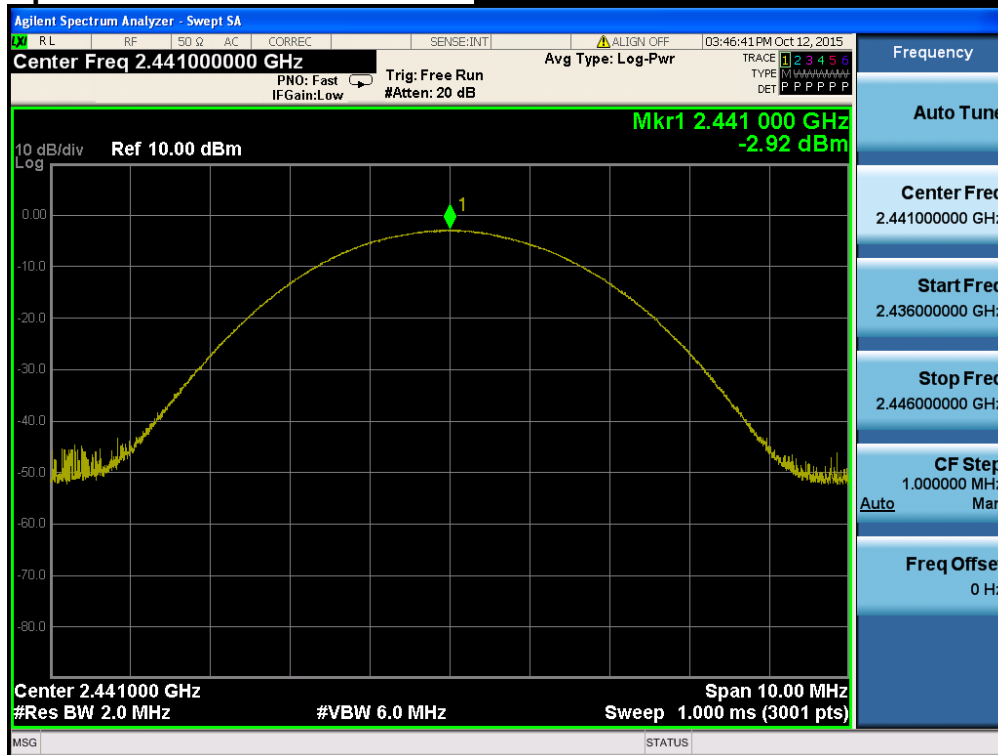

### Peak Output Power

### Highest Channel & Modulation : 8DPSK

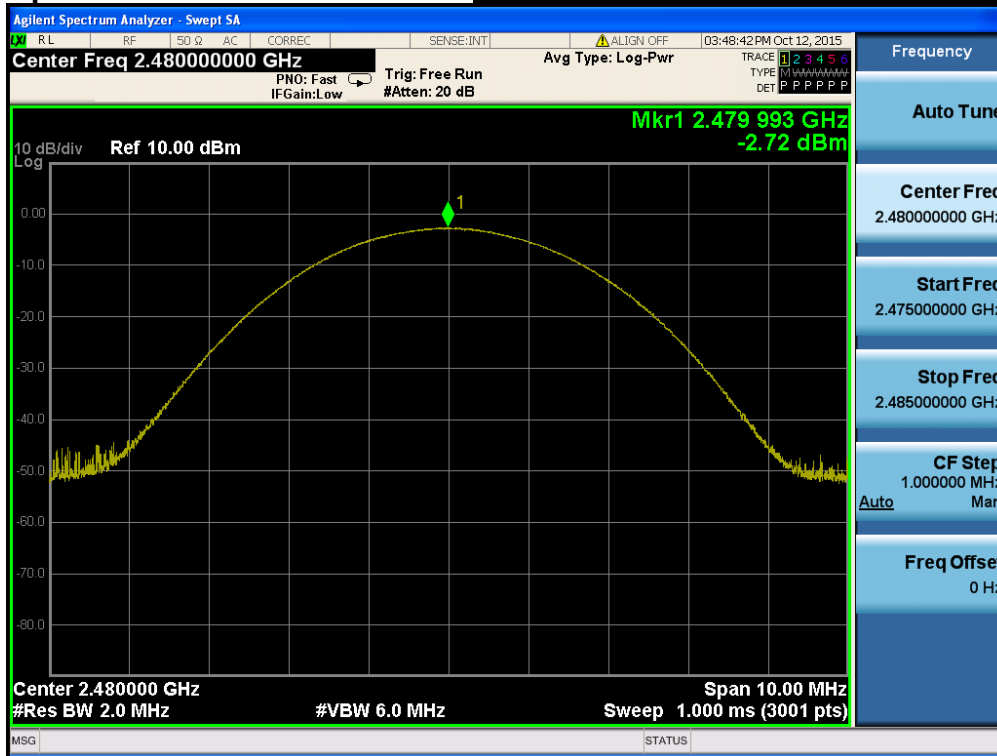

### 3. 20 dB BW

#### 3.1 Test Setup

Refer to the APPENDIX I.

#### 3.2 Limit

Limit : Not Applicable

#### 3.3 Test Procedure

1. The 20 dB bandwidth were measured with a spectrum analyzer connected to RF antenna Connector (conducted measurement) while EUT was operating in transmit mode. The analyzer center frequency was set to the EUT carrier frequency, using the analyzer.
2. The bandwidth of the fundamental frequency was measured with the spectrum analyzer using  $RBW \geq 1\%$  of the 20 dB bandwidth,  $VBW \geq RBW$ , Span = 3 MHz.

#### 3.4 Test Results

Modulation	Tested Channel	20 dB BW (MHz)
<b><u>GFSK</u></b>	Lowest	0.930
	Middle	0.890
	Highest	0.890
<b><u><math>\pi/4</math>DQPSK</u></b>	Lowest	1.320
	Middle	1.320
	Highest	1.270
<b><u>8DPSK</u></b>	Lowest	1.250
	Middle	1.250
	Highest	1.250

Note 1 : See next pages for actual measured spectrum plots.

20 dB Bandwidth

*Lowest Channel & Modulation : GFSK*

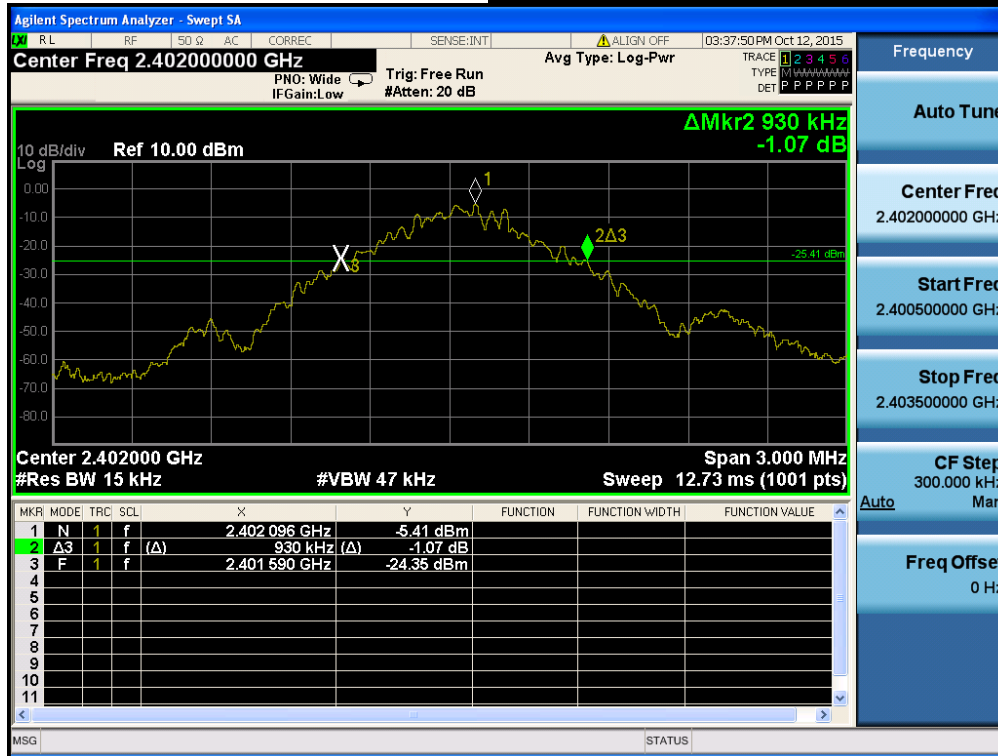

20 dB Bandwidth

*Middle Channel & Modulation : GFSK*

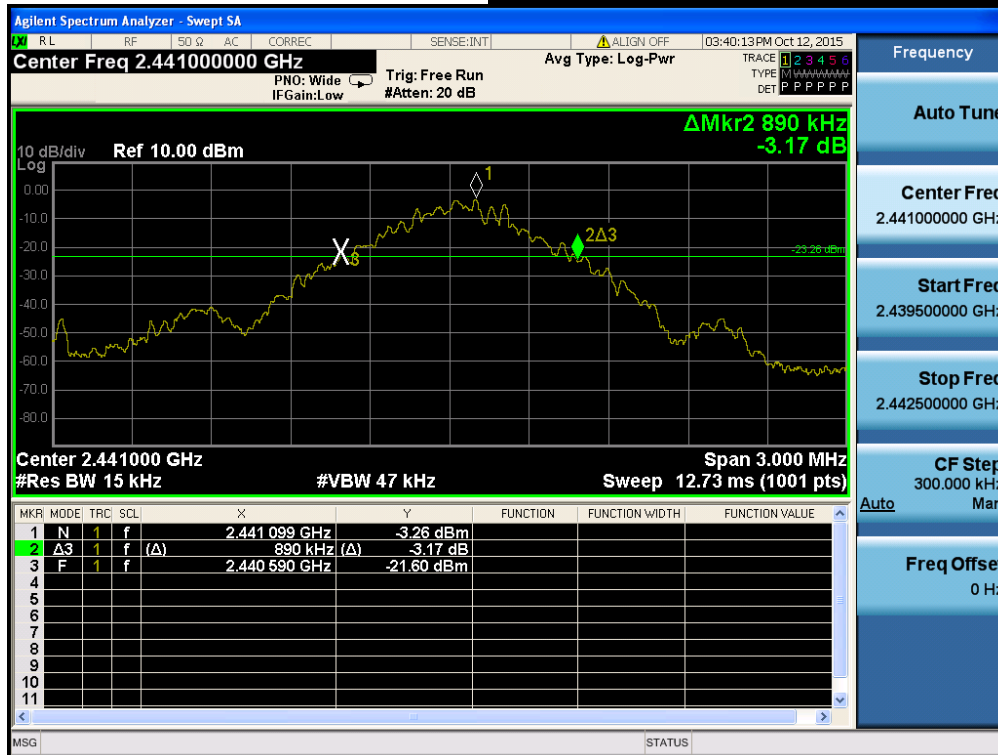

20 dB Bandwidth

*Highest Channel & Modulation : GFSK*



20 dB Bandwidth

*Lowest Channel & Modulation :  $\pi$ /4DQPSK*



20 dB Bandwidth

Middle Channel & Modulation :  $\pi/4$ DQPSK



20 dB Bandwidth

Highest Channel & Modulation :  $\pi/4$ DQPSK



20 dB Bandwidth

**Lowest Channel & Modulation : 8DPSK**



20 dB Bandwidth

**Middle Channel & Modulation : 8DPSK**



20 dB Bandwidth

**Highest Channel & Modulation : 8DPSK**



## 4. Carrier Frequency Separation

### 4.1 Test Setup

Refer to the APPENDIX I.

### 4.2 Limit

Limit :  $\geq 20$  dB BW or  $\geq$  Two-Thirds of the 20 dB BW

### 4.3 Procedure

The carrier frequency separation was measured with a spectrum analyzer connected to the antenna terminal, while EUT had its hopping function enabled.

After the trace being stable, the reading value between the peaks of the adjacent channels using the marker-delta function was recorded as the measurement results.

The spectrum analyzer is set to :

Span = wide enough to capture the peaks of two adjacent channels

RBW = Start with the RBW set to approximately 30% of the channel spacing; adjust as necessary to best identify the center of each individual channel.

VBW  $\geq$  RBW

Sweep = auto

Detector function = peak

Trace = max hold

### 4.4 Test Results

#### FH mode

Hopping Mode	Test Mode	Peak of center channel (MHz)	Peak of adjacent Channel (MHz)	Test Result (MHz)
Enable	GFSK	2441.033	2442.033	1.000
	$\pi/4$ -DQPSK	2440.052	2441.058	1.006
	8DPSK	2440.037	2441.043	1.006

#### AFH mode

Hopping Mode	Test Mode	Peak of center channel (MHz)	Peak of adjacent Channel (MHz)	Test Result (MHz)
Enable	GFSK	2410.034	2411.037	1.003
	$\pi/4$ -DQPSK	2410.043	2411.046	1.003
	8DPSK	2410.034	2411.034	1.000

Note 1 : See next pages for actual measured spectrum plots.

#### - Minimum Standard :

Frequency hopping systems shall have hopping channel carrier frequencies separated by a minimum of 25 kHz or the 20 dB bandwidth of the hopping channel, whichever is greater. Alternatively, frequency hopping systems operating in the 2400 - 2483.5 MHz band may have hopping channel carrier frequencies that are separated by 25 kHz or two-thirds of the 20 dB bandwidth of the hopping channel, whichever is greater, provided the systems operate with an output power no greater than 125 mW

**Carrier Frequency Separation (FH) *Hopping mode : Enable & GFSK***

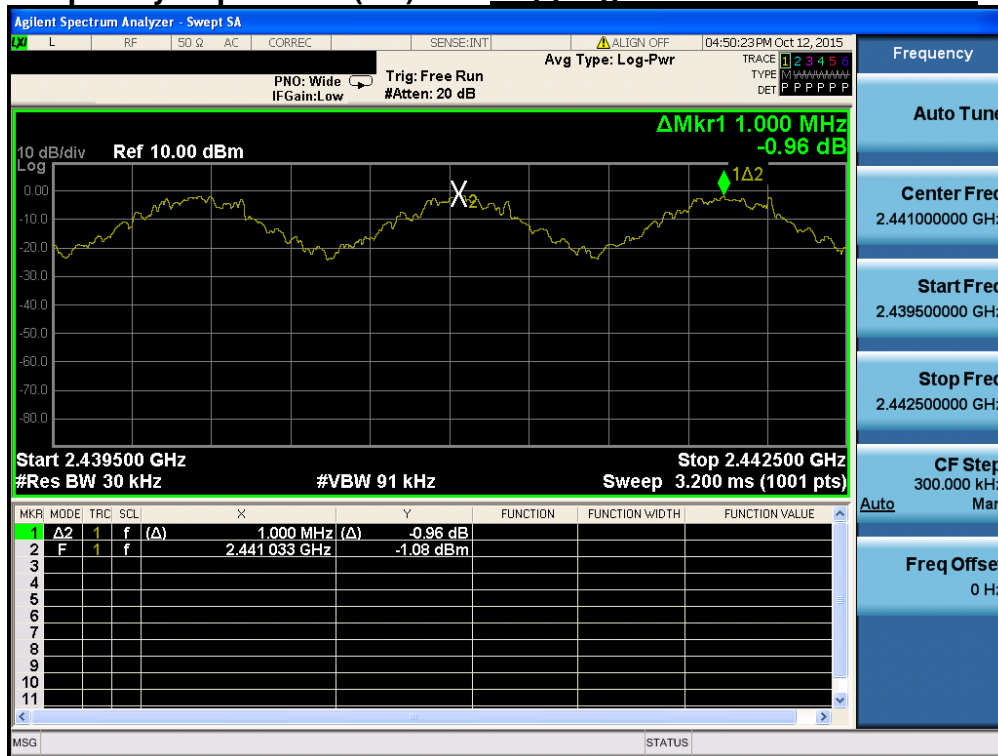

**Carrier Frequency Separation (FH) *Hopping mode : Enable &  $\pi/4$ -DQPSK***

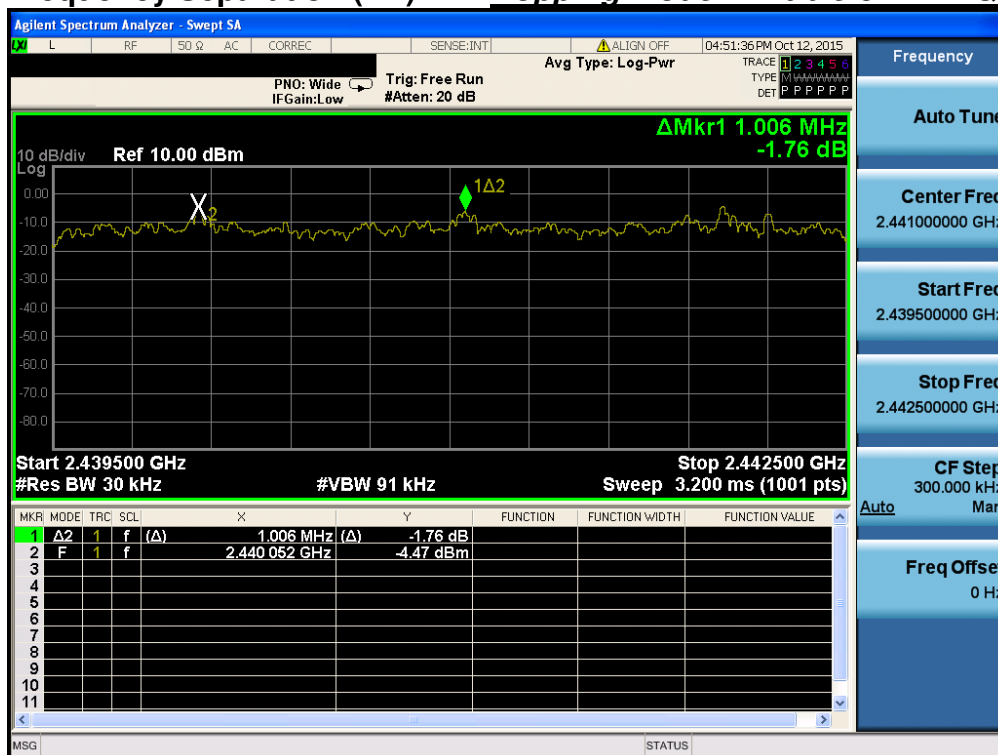

**Carrier Frequency Separation (FH) *Hopping mode : Enable & 8DPSK***

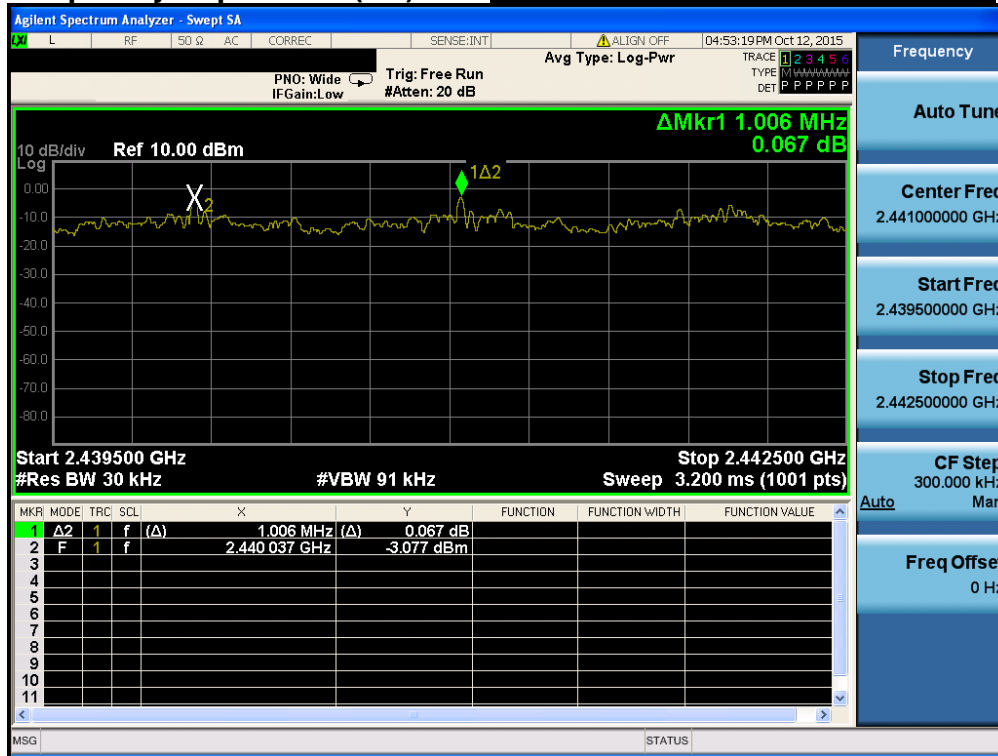

**Carrier Frequency Separation (AFH) *Hopping mode : Enable & GFSK***



**Carrier Frequency Separation (AFH) *Hopping mode : Enable & π/4-DQPSK***

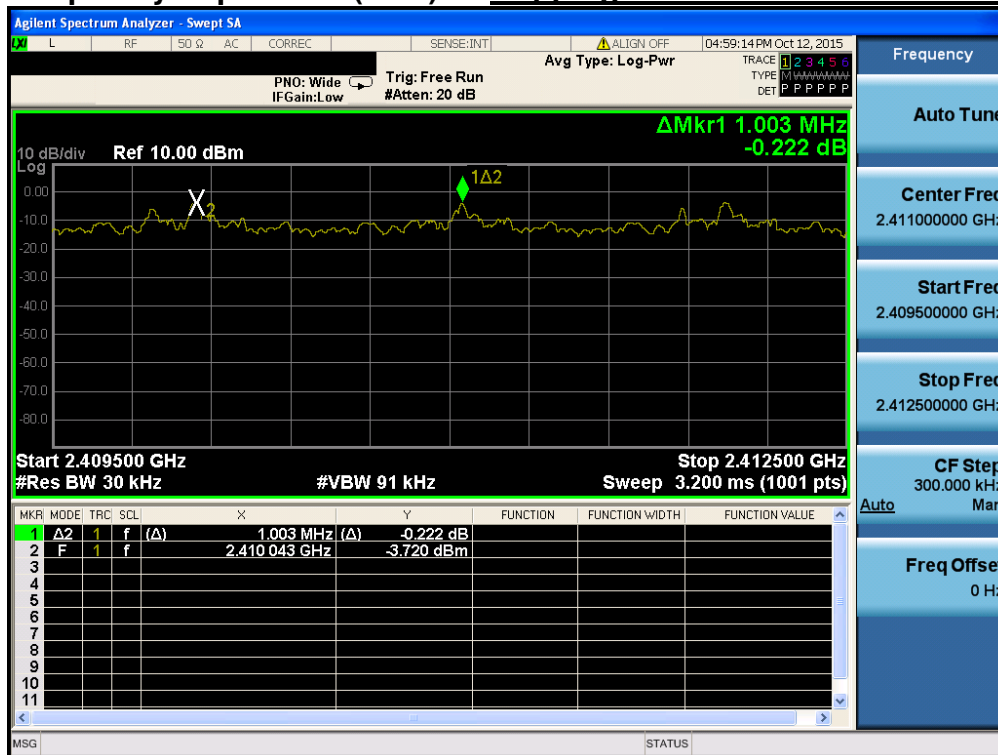

**Carrier Frequency Separation (AFH) *Hopping mode : Enable & 8DPSK***

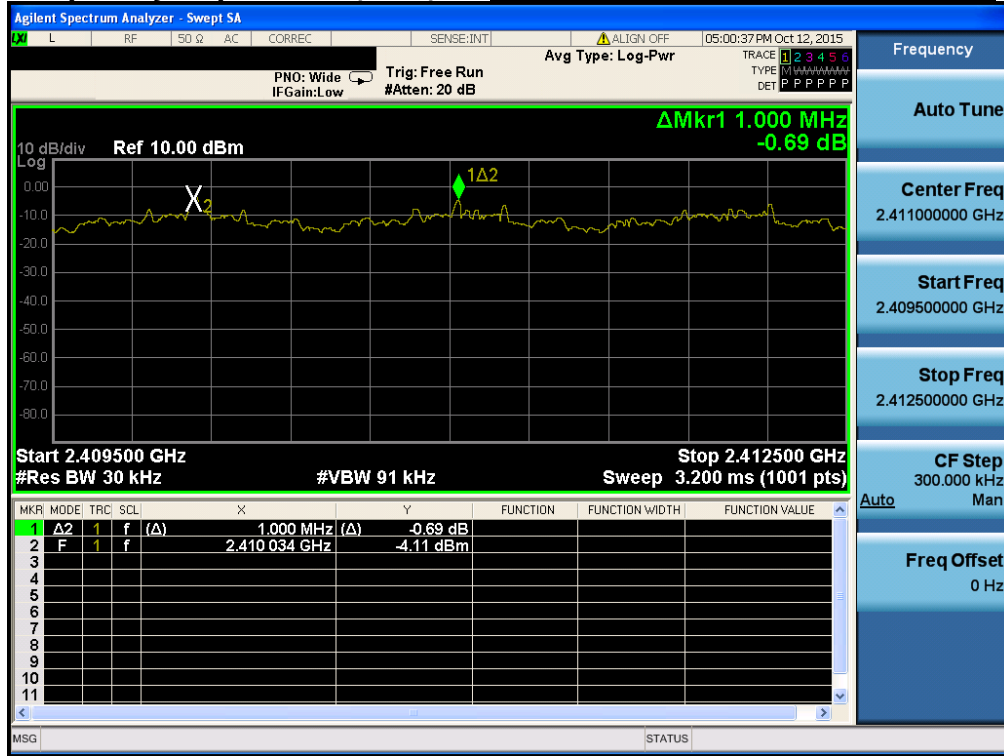

## 5. Number of Hopping Frequencies

### 5.1 Test Setup

Refer to the APPENDIX I.

### 5.2 Limit

Limit : >= 15 hops

### 5.3 Procedure

The number of hopping frequencies was measured with a spectrum analyzer connected to the antenna terminal, while EUT had its hopping function enabled.

To get higher resolution, two frequency ranges for FH mode within the 2400 ~ 2483.5 MHz were examined.

The spectrum analyzer is set to :

Span for FH mode = 50 MHz      Start Frequency = 2391.5 MHz,      Stop Frequency = 2441.5 MHz

Start Frequency = 2441.5 MHz,      Stop Frequency = 2491.5 MHz

Span for AFH mode = 30 MHz      Start Frequency = 2396.0 MHz,      Stop Frequency = 2426.0 MHz

RBW = To identify clearly the individual channels, set the RBW to less than 30% of the channel spacing or the 20 dB bandwidth, whichever is smaller.

VBW ≥ RBW      Sweep = auto

Detector function = peak      Trace = max hold

### 5.4 Test Results

#### FH mode

Hopping mode	Test mode	Test Result (Total Hops)
Enable	GFSK	79
	$\pi/4$ -DQPSK	79
	8DPSK	79

#### AFH mode

Hopping mode	Test mode	Test Result (Total Hops)
Enable	GFSK	20
	$\pi/4$ -DQPSK	20
	8DPSK	20

Note 1 : See next pages for actual measured spectrum plots.

#### - Minimum Standard :

At least 15 hops
------------------

**Number of Hopping Frequencies 1(FH) *Hopping mode : Enable & GFSK***

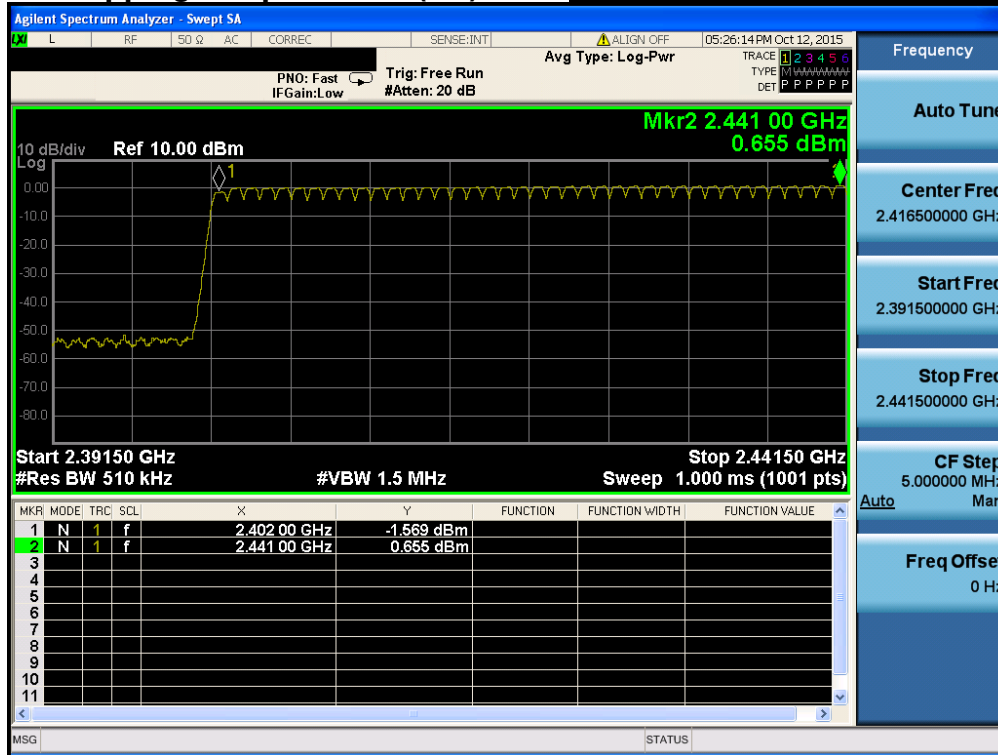

**Number of Hopping Frequencies 2(FH) *Hopping mode : Enable & GFSK***

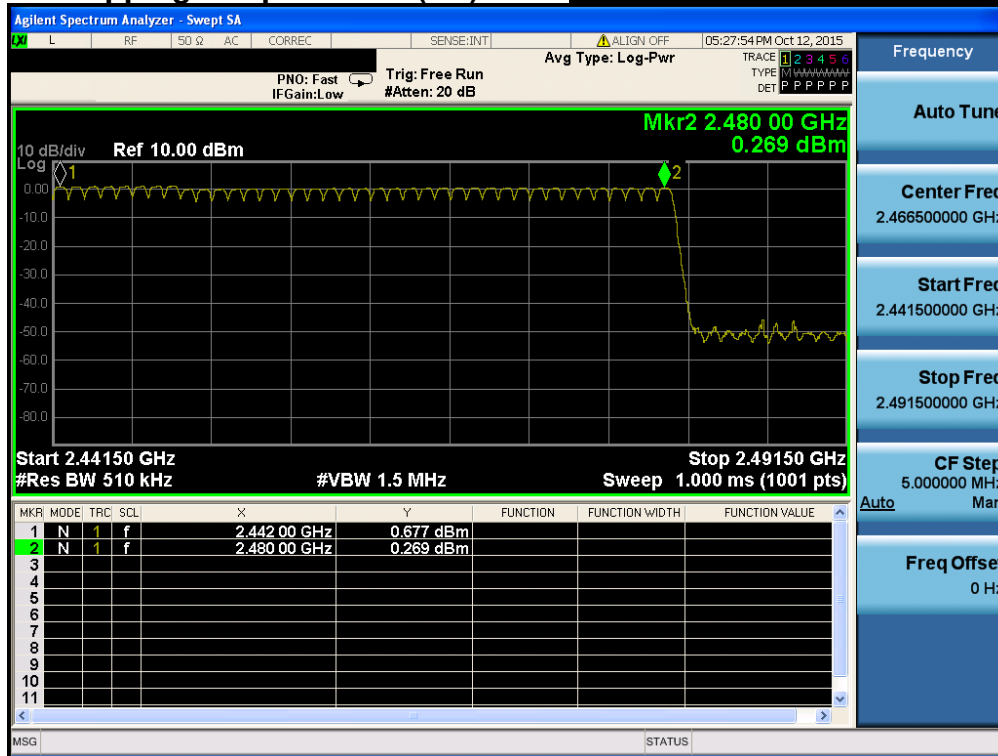

**Number of Hopping Frequencies 1(FH)      *Hopping mode : Enable &  $\pi/4$ -DQPSK***



**Number of Hopping Frequencies 2(FH)      *Hopping mode : Enable &  $\pi/4$ -DQPSK***

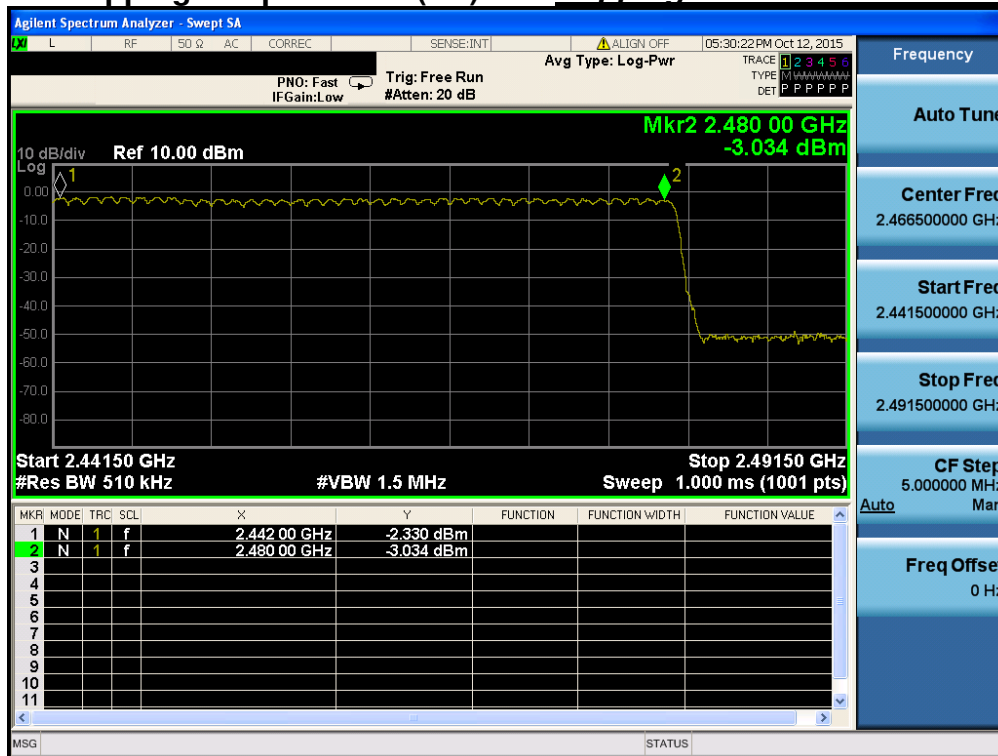

**Number of Hopping Frequencies 1(FH) *Hopping mode : Enable & 8DPSK***

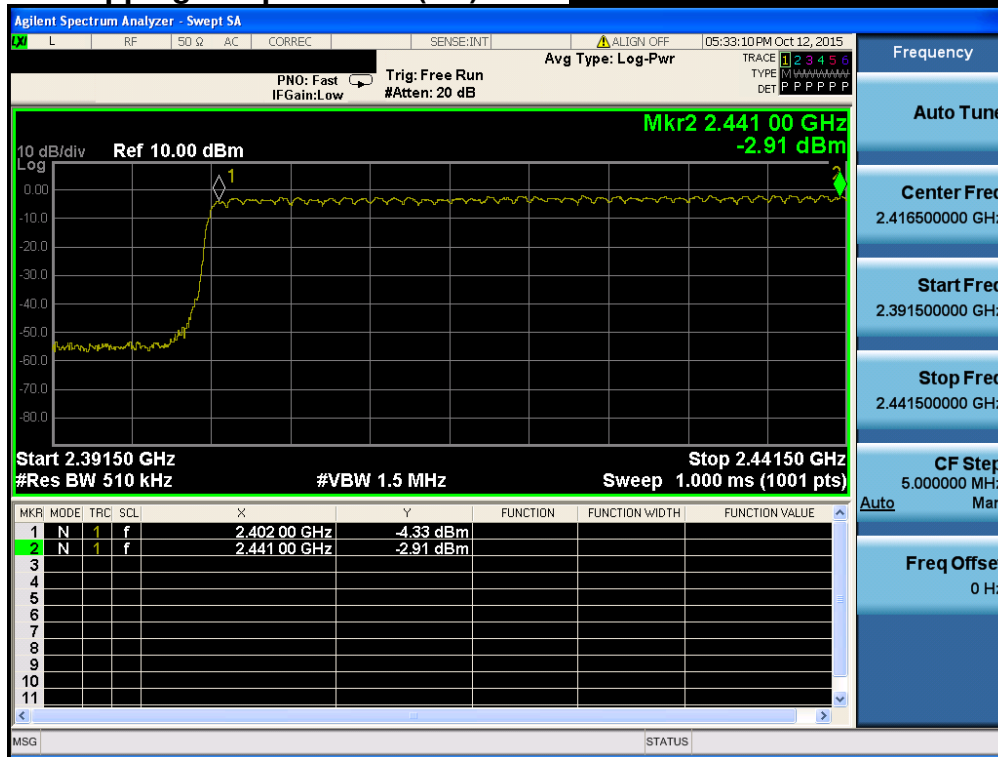

**Number of Hopping Frequencies 2(FH) *Hopping mode : Enable & 8DPSK***

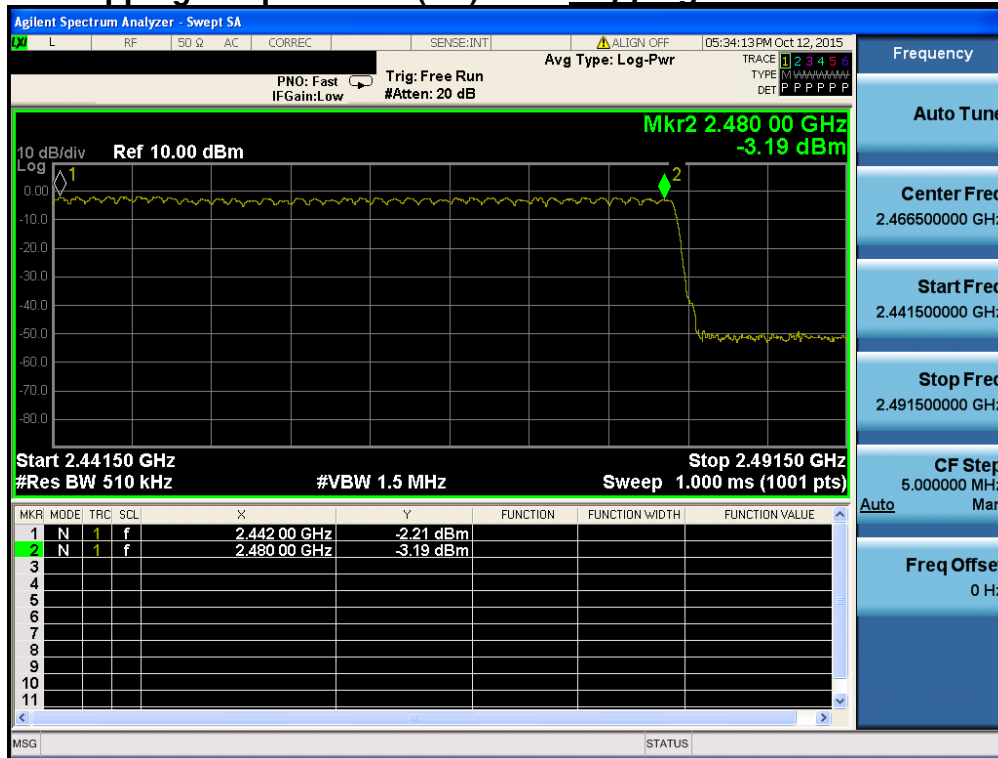

**Number of Hopping Frequencies 1(AFH) *Hopping mode : Enable & GFSK***

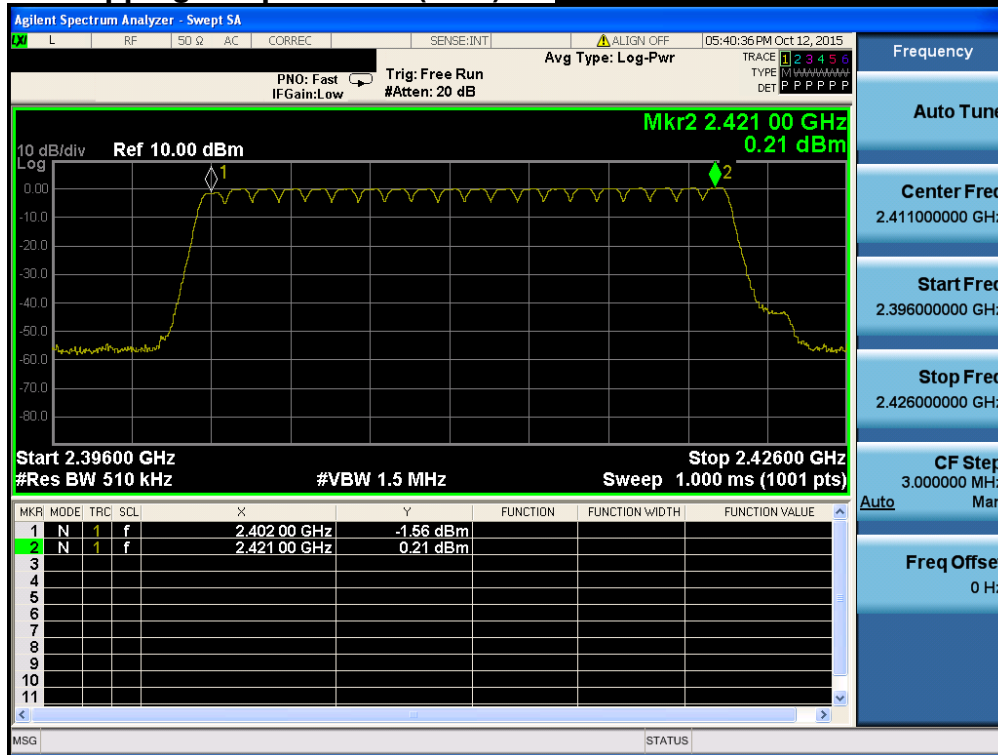

**Number of Hopping Frequencies 1(AFH) *Hopping mode : Enable & π/4-DQPSK***



**Number of Hopping Frequencies 1(AFH) *Hopping mode : Enable & 8DPSK***

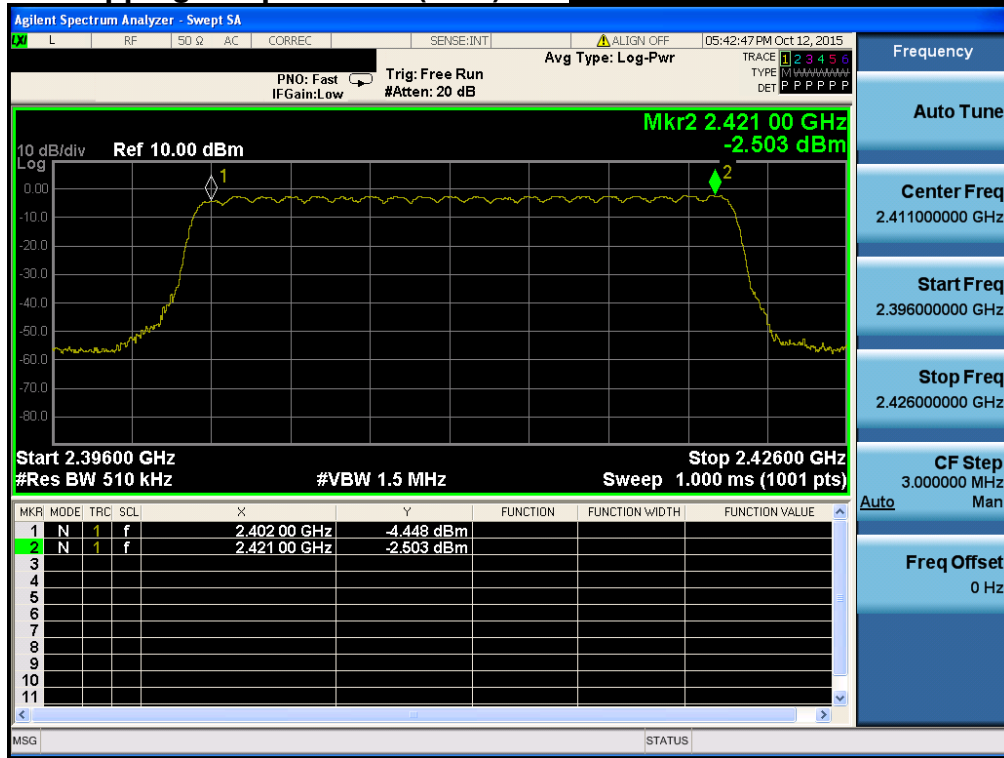

## 6. Time of Occupancy (Dwell Time)

### 6.1 Test Setup

Refer to the APPENDIX I.

### 6.2 Limit

The maximum permissible time of occupancy is 400 ms within a period of 400 ms multiplied by the number of hopping channels employed.

### 6.3 Test Procedure

The dwell time was measured with a spectrum analyzer connected to the antenna terminal, while EUT had its hopping function enabled.

The spectrum analyzer is set to :

Center frequency = 2441 MHz

Span = zero

RBW = 1 MHz (RBW shall be ≤ channel spacing and where possible RBW should be set >> 1 / T, where T is the expected dwell time per channel)

VBW ≥ RBW

Detector function = peak

Trace = max hold

### 6.4 Test Results

#### FH mode

Hopping mode	Packet Type	Number of hopping Channels	Burst On Time (ms)	Period (ms)	Test Result (sec)
Enable	DH 5	79	2.880	3.750	0.307
	2 DH 5	79	2.880	3.750	0.307
	3 DH 5	79	2.880	3.750	0.307

#### AFH mode

Hopping mode	Packet Type	Number of hopping Channels	Burst On Time (ms)	Period (ms)	Test Result (sec)
Enable	DH 5	20	2.880	3.750	0.154
	2 DH 5	20	2.880	3.750	0.154
	3 DH 5	20	2.880	3.750	0.154

Note 1 : Dwell Time = 0.4 × Hopping channel × Burst ON time × ((Hopping rate ÷ Time slots) ÷ Hopping channel)

- Time slots for DH5 = 6 slots (TX = 5 slot / RX = 1 slot)

- Hopping Rate = 1600 for FH mode & 800 for AFH mode

Note 2 : See next pages for actual measured spectrum plots.

Time of Occupancy (FH)

Hopping mode : Enable & GFSK

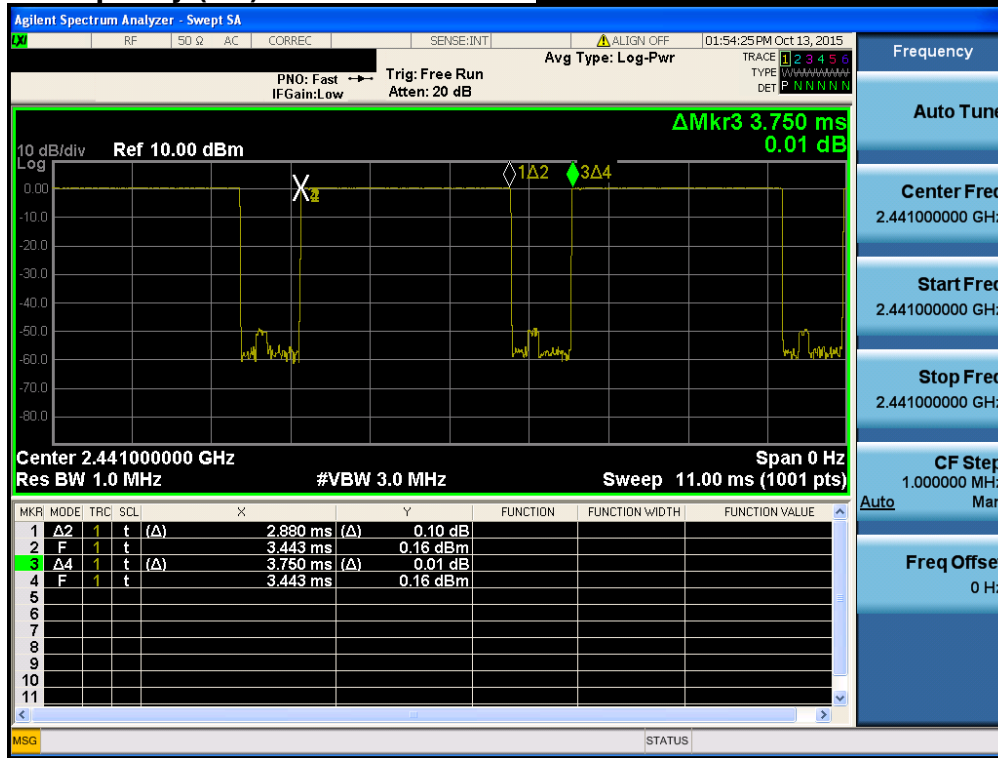

Time of Occupancy (FH)

Hopping mode : Enable & π/4-DQPSK

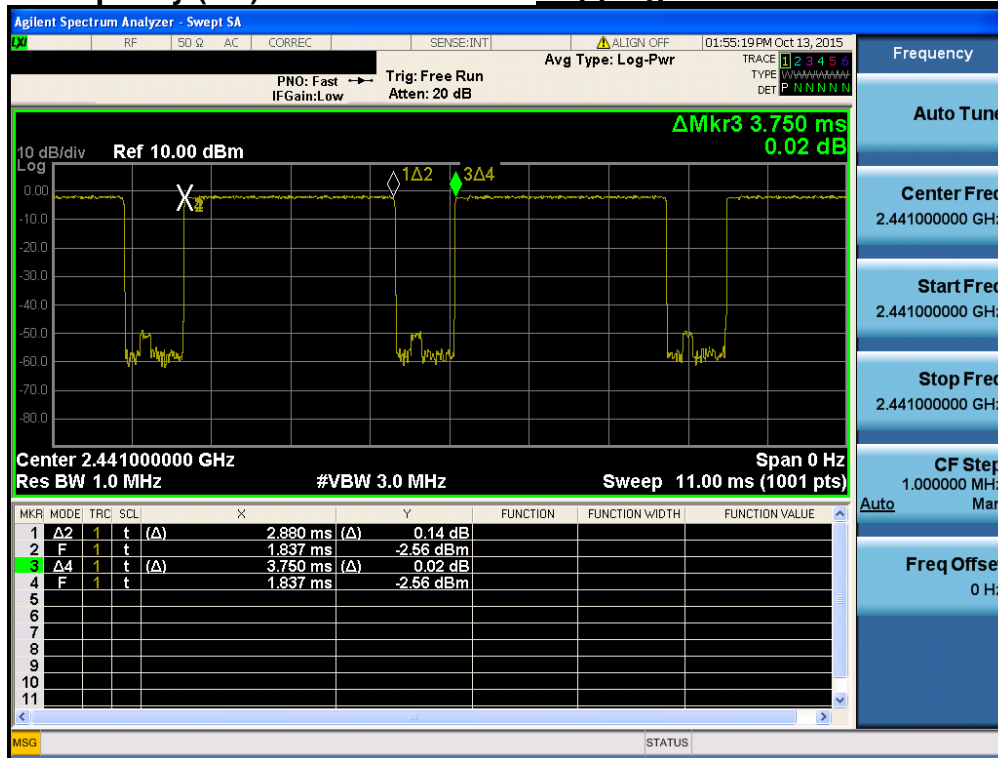

**Time of Occupancy (FH)**

***Hopping mode : Enable & 8DPSK***

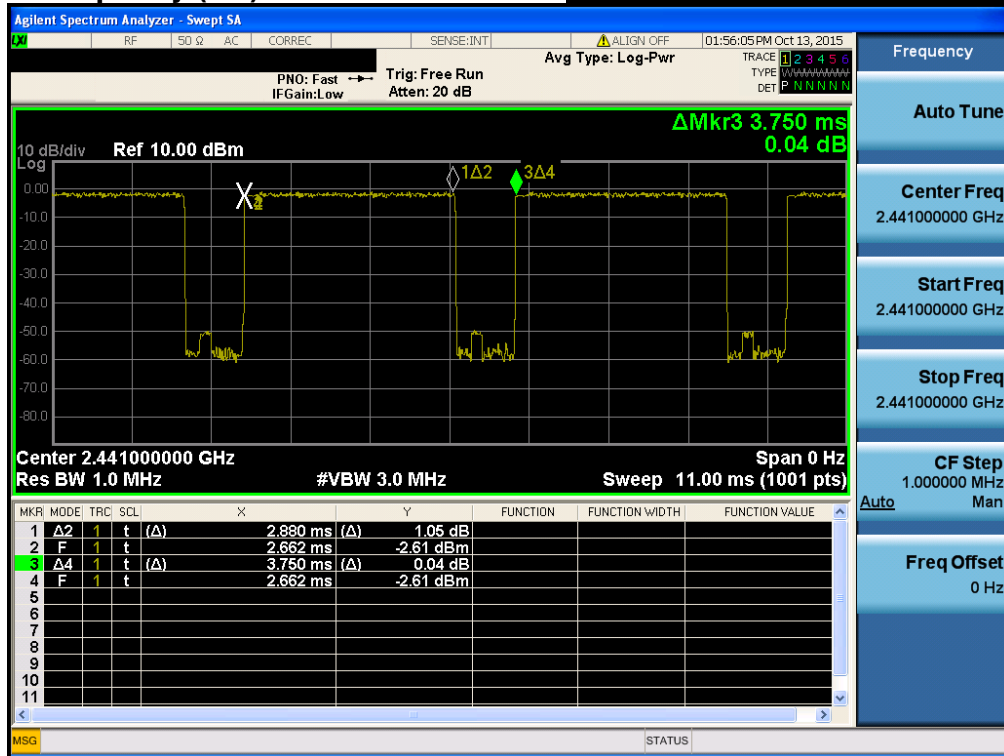

**Time of Occupancy (AFH)**

**Hopping mode : Enable & GFSK**

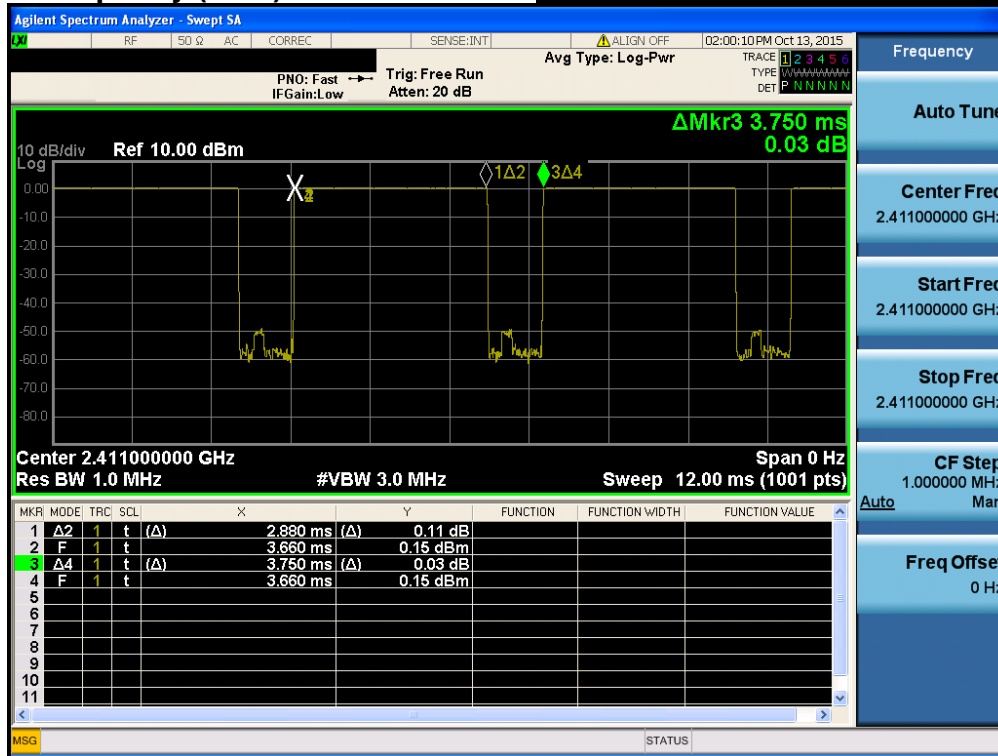

**Time of Occupancy (AFH)**

**Hopping mode : Enable & π/4-DQPSK**

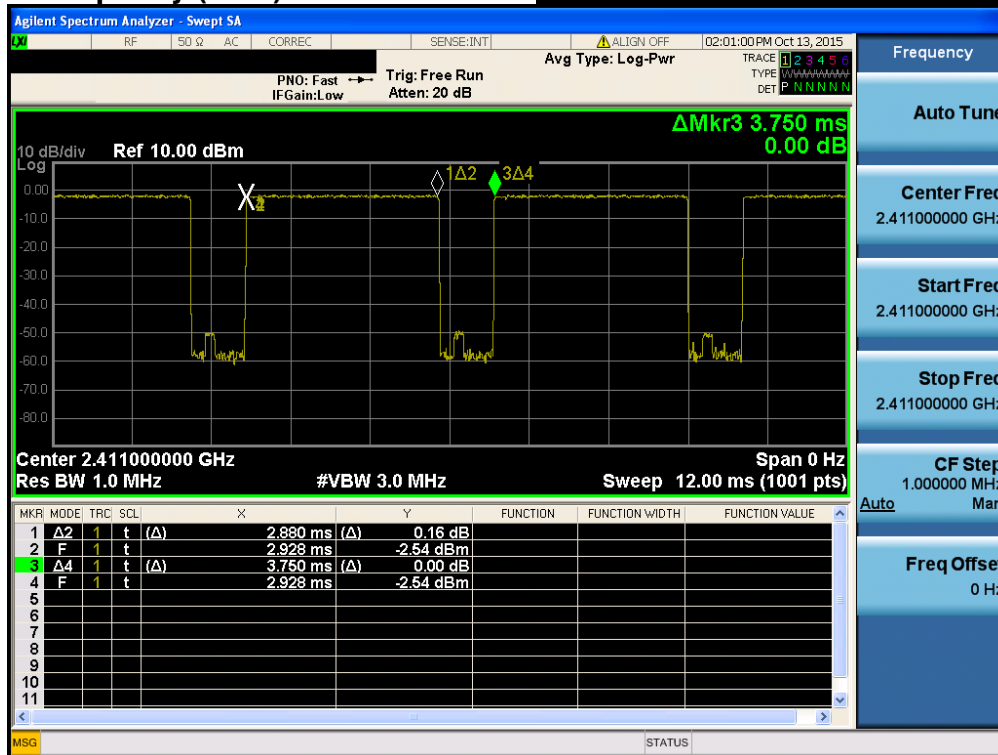

**Time of Occupancy (AFH)**

***Hopping mode : Enable & 8DPSK***

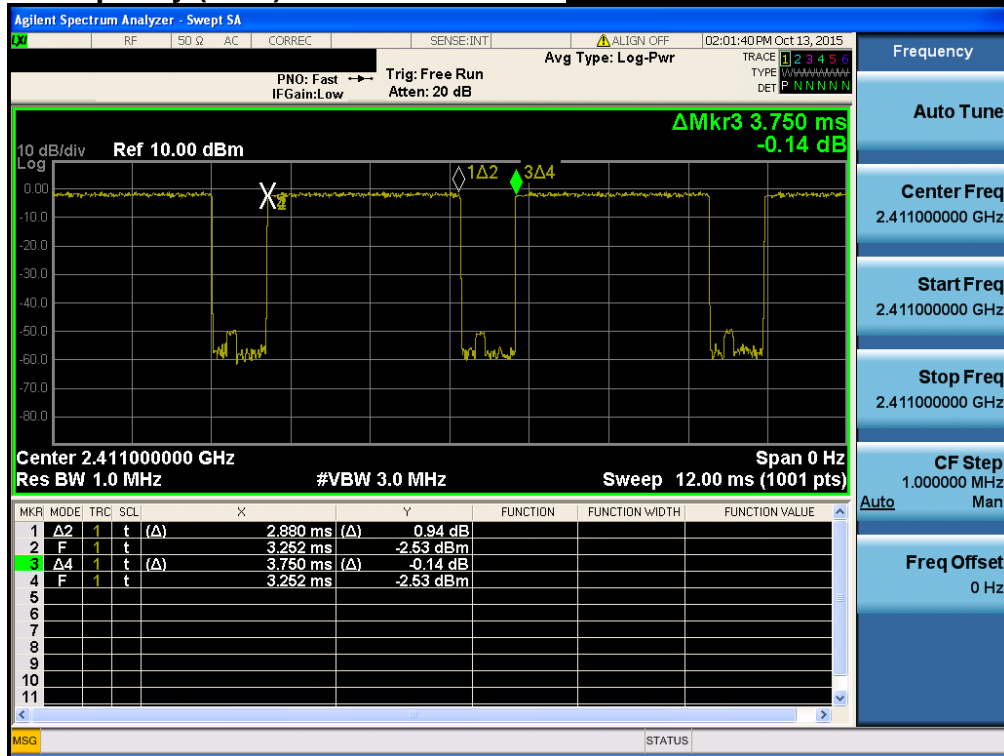

## 7. Transmitter Radiated Spurious Emissions and Conducted Spurious Emission

### 7.1 Test Setup

Refer to the APPENDIX I.

### 7.2 Limit

According to §15.247(d), in any 100 kHz bandwidth outside the frequency band in which the spread spectrum or digitally modulated intentional radiator is operating, the radio frequency power that is produced by the intentional radiator shall be at least 20 dB below that in the 100 kHz bandwidth within the band that contains the highest level of the desired power, based on either an RF conducted or a radiated measurement, provided the transmitter demonstrates compliance with the peak conducted power limits. If the transmitter complies with the conducted power limits based on the use of RMS averaging over a time interval, as permitted under paragraph(b)(3) of this section, the attenuation required under this paragraph shall be 30 dB instead of 20 dB. Attenuation below the general limits specified in section §15.209(a) is not required. In addition, radiated emission which fall in the restricted bands, as defined in section §15.205(a), must also comply with the radiated emission limits specified in section §15.209(a) (see section §15.205(c))

According to § 15.209(a), except as provided elsewhere in this Subpart, the emissions from an intentional radiator shall not exceed the field strength levels specified in the following table

Frequency (MHz)	Limit (uV/m)	Measurement Distance (meter)
0.009 ~ 0.490	2400/F (kHz)	300
0.490 ~ 1705	24000/F (kHz)	30
1705 ~ 30.0	30	30
30 ~ 88	100 **	3
88 ~ 216	150 **	3
216 ~ 960	200 **	3
Above 960	500	3

\*\* Except as provided in 15.209(g), fundamental emissions from intentional radiators operating under this Section shall not be located in the frequency bands 54 - 72 MHz, 76 - 88 MHz, 174 - 216 MHz or 470 - 806 MHz. However, operation within these frequency bands is permitted under other sections of this Part, e.g. 15.231 and 15.241.

According to § 15.205(a) and (b), only spurious emissions are permitted in any of the frequency bands listed below :

MHz	MHz	MHz	MHz	GHz	GHz
0.009 ~ 0.110	8.41425 ~ 8.41475	108 ~ 121.94	1300 ~ 1427	4.5 ~ 5.15	14.47 ~ 14.5
0.495 ~ 0.505	12.29 ~ 12.293	123 ~ 138	1435 ~ 1626.5	5.35 ~ 5.46	15.35 ~ 16.2
2.1735 ~ 2.1905	12.51975 ~	149.9 ~ 150.05	1645.5 ~ 1646.5	7.25 ~ 7.75	17.7 ~ 21.4
4.125 ~ 4.128	12.52025	156.52475 ~	1660 ~ 1710	8.025 ~ 8.5	22.01 ~ 23.12
4.17725 ~ 4.17775	12.57675 ~	156.52525	1718.8 ~ 1722.2	9.0 ~ 9.2	23.6 ~ 24.0
4.20725 ~ 4.20775	12.57725	156.7 ~ 156.9	2200 ~ 2300	9.3 ~ 9.5	31.2 ~ 31.8
6.215 ~ 6.218	13.36 ~ 13.41	162.0125 ~ 167.17	2310 ~ 2390	10.6 ~ 12.7	36.43 ~ 36.5
6.26775 ~ 6.26825	16.42 ~ 16.423	167.72 ~ 173.2	2483.5 ~ 2500	13.25 ~ 13.4	Above 38.6
6.31175 ~ 6.31225	16.69475 ~	240 ~ 285	2655 ~ 2900		
8.291 ~ 8.294	16.69525	322 ~ 335.4	3260 ~ 3267		
8.362 ~ 8.366	16.80425 ~	399.90 ~ 410	3332 ~ 3339		
8.37625 ~ 8.38675	16.80475	608 ~ 614	3345.8 ~ 3358		
	25.5 ~ 25.67	960 ~ 1240	3600 ~ 4400		
	37.5 ~ 38.25				
	73 ~ 74.6				
	74.8 ~ 75.2				

The field strength of emissions appearing within these frequency bands shall not exceed the limits shown in §15.209. At frequencies equal to or less than 1000 MHz, compliance with the limits in §15.209 shall be demonstrated using measurement instrumentation employing a CISPR quasi-peak detector. Above 1000 MHz, compliance with the emission limits in §15.209 shall be demonstrated based on the average value of the measured emissions. The provisions in §15.35 apply to these measurements.

### 7.3. Test Procedures

#### 7.3.1. Test Procedures for Radiated Spurious Emissions

1. The EUT is placed on a non-conductive table. For emission measurements at or below 1 GHz, the table height is 80 cm. For emission measurements above 1 GHz, the table height is 1.5 m. The table was rotated 360 degrees to determine the position of the highest radiation.
2. During performing radiated emission below 1 GHz, the EUT was set 3 meters away from the interference receiving antenna, which was mounted on the top of a variable-height antenna tower. During performing radiated emission above 1 GHz, the EUT was set 1 or 3 meter away from the interference-receiving antenna.
3. For measurements above 1GHz absorbers are placed on the floor between the turn table and the antenna mast in such a way so as to maximize the reduction of reflections. For measurements below 1 GHz, the absorbers are removed.
4. The antenna is a broadband antenna, and its height is varied from 1 meter to 4 meters above the ground to determine the maximum value of the field strength. Both horizontal and vertical polarizations of the antenna are set to make the measurement.
5. For each suspected emission, the EUT was arranged to its worst case and then the antenna was tuned to heights from 1 meter to 4 meters and the table was turned from 0 degrees to 360 degrees to find the maximum reading.
6. The test-receiver system was set to Peak Detect Function and Specified Bandwidth with Maximum Hold Mode.
7. If the emission level of the EUT in peak mode was 10 dB lower than the limit specified, then testing could be stopped and the peak values of the EUT would be reported. Otherwise the emissions that did not have 10 dB margin would be re-tested one by one using peak, quasi-peak or average method as specified and then reported in a data sheet.

NOTE 1. The resolution bandwidth and video bandwidth of test receiver/spectrum analyzer is 120 kHz for Quasi-peak detection (QP) at frequency below 1 GHz.

NOTE 2. The resolution bandwidth and video bandwidth of test receiver/spectrum analyzer is 1 MHz for Peak detection and frequency above 1 GHz.

NOTE 3. The resolution bandwidth of test receiver/spectrum analyzer is 1 MHz and the video bandwidth is 1 kHz for Average detection (AV) at frequency above 1 GHz.

### 7.3.2. Test Procedures for Conducted Spurious Emissions

1. The transmitter output was connected to the spectrum analyzer.
2. The **reference level** of the fundamental frequency was measured with the spectrum analyzer using RBW = 100 kHz, VBW = 300 kHz.
3. The conducted spurious emission was tested each ranges were set as below.

**Frequency range : 9 kHz ~ 30 MHz**

RBW = 100 kHz, VBW = 300 kHz, SWEEP TIME = AUTO, DETECTOR = PEAK, TRACE = MAX HOLD, SWEEP POINT : 40001

**Frequency range : 30 MHz ~ 10 GHz, 10 GHz ~ 25 GHz**

RBW = 1 MHz, VBW = 3 MHz, SWEEP TIME = AUTO, DETECTOR = PEAK, TRACE = MAX HOLD, SWEEP POINT : 40001

**LIMIT LINE = 20 dB below of the reference level of above measurement procedure Step 2. (RBW = 100 kHz, VBW = 300 kHz)**

If the emission level with above setting was close to the limit (ie, less than 3 dB margin) then zoom scan is required using RBW = 100 kHz, VBW = 300 kHz, SPAN = 100 MHz and BINS = 2001 to get accurate emission level within 100 kHz BW.

Also the path loss for conducted measurement setup was used as described on the Appendix I of this test report.

### 7.3.3. Test Plot

Refer to the APPENDIX II

## 7.4. Test Results

### 7.4.1. Radiated Emissions

#### 9 kHz ~ 25 GHz Data (Modulation : GFSK)

##### ▪ Lowest Channel

Tested band	Frequency (MHz)	ANT Pol	EUT Position (Axis)	Det. Mode	Reading (dBuV)	T.F (dB/m)	D.C.F (dB)	Distance Factor (dB)	Result (dBuV/m)	Limit (dBuV/m)	Margin (dB)
RB	2370.03	V	X	PK	51.56	2.84	0.00	N/A	54.40	74.00	19.60
RB	2369.97	V	X	AV	37.94	2.84	-24.79	N/A	15.99	54.00	38.01
RB	4804.38	V	X	PK	53.40	7.99	0.00	N/A	61.39	74.00	12.61
RB	4804.07	V	X	AV	46.30	7.99	-24.79	N/A	29.50	54.00	24.50

##### ▪ Middle Channel

Tested band	Frequency (MHz)	ANT Pol	EUT Position (Axis)	Det. Mode	Reading (dBuV)	T.F (dB/m)	D.C.F (dB)	Distance Factor (dB)	Result (dBuV/m)	Limit (dBuV/m)	Margin (dB)
RB	4882.68	V	X	PK	52.05	8.03	0.00	N/A	60.08	74.00	13.92
RB	4882.09	V	X	AV	44.84	8.03	-24.79	N/A	28.08	54.00	25.92

##### ▪ Highest Channel

Tested band	Frequency (MHz)	ANT Pol	EUT Position (Axis)	Det. Mode	Reading (dBuV)	T.F (dB/m)	D.C.F (dB)	Distance Factor (dB)	Result (dBuV/m)	Limit (dBuV/m)	Margin (dB)
RB	2483.50	V	X	PK	47.05	3.19	0.00	N/A	50.24	74.00	23.76
RB	2483.50	V	X	AV	38.26	3.19	-24.79	N/A	16.66	54.00	37.34
RB	4959.70	V	X	PK	51.41	8.19	0.00	N/A	59.60	74.00	14.40
RB	4960.13	V	X	AV	42.81	8.19	-24.79	N/A	26.21	54.00	27.79

##### ▪ Note.

- This test item was performed in each axis.  
And no other emissions were reported greater than listed emissions above table.
- The limit is applied as below,  
Non-restricted band = Fundamental level – 20dB  
Restricted band = FCC Part15. 209
- Description of tested band  
“F” = Fundamental signal / “NRB” = Emission in non-restricted band / “RB” = Emission in restricted Band
- Description of Distance Factor  
For finding emissions, the test distance might be reduced from 3m to 1m.  
In this case, the distance factor (-9.54 dB) is applied to the result.  
- Calculation of distance factor =  $20 \log(\text{applied distance} / \text{required distance}) = 20 \log(1\text{m} / 3\text{m}) = -9.54\text{dB}$   
When distance factor is “N/A”, the distance is 3m and distance factor is not applied.
- Sample Calculation  
Margin = Limit – Result / Result = Reading + T.F / T.F = AF + CL – AG  
Where, T.F = Total Factor, AF = Antenna Factor, CL = Cable Loss, AG = Amplifier Gain,
- D.C.F Calculation. (D.C.F = Duty Cycle Correction Factor)  
- Time to cycle through all channels =  $\Delta t = T [\text{ms}] \times 20$  minimum hopping channels, where T = pulse width = **2.88 ms**  
-  $100 \text{ms} / \Delta t [\text{ms}] = H \rightarrow$  Round up to next highest integer, to account for worst case,  $H' = 100 / (2.88 \times 20) = 1.736 \approx 2$   
- The Worst Case Dwell Time =  $T [\text{ms}] \times H' = 2.88 \text{ms} \times 2 = 5.76 \text{ms}$   
- D.C.F =  $20 \log(\text{The Worst Case Dwell Time} / 100 \text{ms}) \text{ dB} = 20 \log(5.76 / 100) = -24.79 \text{ dB}$

### 9 kHz ~ 25 GHz Data (Modulation : $\pi/4$ DQPSK)

#### ▪ Lowest Channel

Tested band	Frequency (MHz)	ANT Pol	EUT Position (Axis)	Det. Mode	Reading (dBuV)	T.F (dB/m)	D.C.F (dB)	Distance Factor (dB)	Result (dBuV/m)	Limit (dBuV/m)	Margin (dB)
RB	2369.79	V	X	PK	51.22	2.84	0.00	N/A	54.06	74.00	19.94
RB	2370.27	V	X	AV	37.75	2.84	-24.79	N/A	15.80	54.00	38.20
RB	4803.82	V	X	PK	51.56	7.99	0.00	N/A	59.55	74.00	14.45
RB	4804.09	V	X	AV	40.55	7.99	-24.79	N/A	23.75	54.00	30.25

#### ▪ Middle Channel

Tested band	Frequency (MHz)	ANT Pol	EUT Position (Axis)	Det. Mode	Reading (dBuV)	T.F (dB/m)	D.C.F (dB)	Distance Factor (dB)	Result (dBuV/m)	Limit (dBuV/m)	Margin (dB)
RB	4881.91	V	X	PK	51.52	8.03	0.00	N/A	59.55	74.00	14.45
RB	4882.06	V	X	AV	39.55	8.03	-24.79	N/A	22.79	54.00	31.21

#### ▪ Highest Channel

Tested band	Frequency (MHz)	ANT Pol	EUT Position (Axis)	Det. Mode	Reading (dBuV)	T.F (dB/m)	D.C.F (dB)	Distance Factor (dB)	Result (dBuV/m)	Limit (dBuV/m)	Margin (dB)
RB	2483.50	V	Z	PK	47.90	3.19	0.00	N/A	51.09	74.00	22.91
RB	2483.51	V	Z	AV	37.40	3.19	-24.79	N/A	15.80	54.00	38.20
RB	4960.21	V	X	PK	49.94	8.19	0.00	N/A	58.13	74.00	15.87
RB	4960.05	V	X	AV	38.56	8.19	-24.79	N/A	21.96	54.00	32.04

#### ▪ Note.

- This test item was performed in each axis.  
And no other emissions were reported greater than listed emissions above table.
- The limit is applied as below,  
Non-restricted band = Fundamental level – 20dB  
Restricted band = FCC Part15. 209
- Description of tested band  
“F” = Fundamental signal / “NRB” = Emission in non-restricted band / “RB” = Emission in restricted Band
- Description of Distance Factor  
For finding emissions, the test distance might be reduced from 3m to 1m.  
In this case, the distance factor (-9.54 dB) is applied to the result.  
- Calculation of distance factor =  $20 \log(\text{applied distance} / \text{required distance}) = 20 \log(1\text{m} / 3\text{m}) = -9.54\text{dB}$   
When distance factor is “N/A”, the distance is 3m and distance factor is not applied.
- Sample Calculation  
Margin = Limit – Result / Result = Reading + T.F / T.F = AF + CL – AG  
Where, T.F = Total Factor, AF = Antenna Factor, CL = Cable Loss, AG = Amplifier Gain,
- D.C.F Calculation. (D.C.F = Duty Cycle Correction Factor)  
- Time to cycle through all channels =  $\Delta t = T [\text{ms}] \times 20$  minimum hopping channels, where T = pulse width = **2.88 ms**  
-  $100 \text{ ms} / \Delta t [\text{ms}] = H \rightarrow$  Round up to next highest integer, to account for worst case,  $H' = 100 / (2.88 \times 20) = 1.736 \approx 2$   
- The Worst Case Dwell Time =  $T [\text{ms}] \times H' = 2.88 \text{ ms} \times 2 = 5.76 \text{ ms}$   
- D.C.F =  $20 \text{ Log}(\text{The Worst Case Dwell Time} / 100 \text{ ms}) \text{ dB} = 20 \text{ log}(5.76 / 100) = -24.79 \text{ dB}$

### 9 kHz ~ 25 GHz Data (Modulation : 8DPSK)

#### ▪ Lowest Channel

Tested band	Frequency (MHz)	ANT Pol	EUT Position (Axis)	Det. Mode	Reading (dBuV)	T.F (dB/m)	D.C.F (dB)	Distance Factor (dB)	Result (dBuV/m)	Limit (dBuV/m)	Margin (dB)
RB	2369.71	V	X	PK	50.58	2.84	0.00	N/A	53.42	74.00	20.58
RB	2370.16	V	X	AV	37.76	2.84	-24.79	N/A	15.81	54.00	38.19
RB	4803.75	V	X	PK	51.06	7.99	0.00	N/A	59.05	74.00	14.95
RB	4804.34	V	X	AV	40.23	7.99	-24.79	N/A	23.43	54.00	30.57

#### ▪ Middle Channel

Tested band	Frequency (MHz)	ANT Pol	EUT Position (Axis)	Det. Mode	Reading (dBuV)	T.F (dB/m)	D.C.F (dB)	Distance Factor (dB)	Result (dBuV/m)	Limit (dBuV/m)	Margin (dB)
RB	4881.57	V	X	PK	50.61	8.03	0.00	N/A	58.64	74.00	15.36
RB	4882.02	V	X	AV	39.53	8.03	-24.79	N/A	22.77	54.00	31.23

#### ▪ Highest Channel

Tested band	Frequency (MHz)	ANT Pol	EUT Position (Axis)	Det. Mode	Reading (dBuV)	T.F (dB/m)	D.C.F (dB)	Distance Factor (dB)	Result (dBuV/m)	Limit (dBuV/m)	Margin (dB)
RB	2483.50	V	X	PK	47.52	3.19	0.00	N/A	50.71	74.00	23.29
RB	2483.50	V	X	AV	37.43	3.19	-24.79	N/A	15.83	54.00	38.17
RB	4959.88	V	X	PK	49.89	8.19	0.00	N/A	58.08	74.00	15.92
RB	4960.14	V	X	AV	38.65	8.19	-24.79	N/A	22.05	54.00	31.95

#### ▪ Note.

- This test item was performed in each axis.  
And no other emissions were reported greater than listed emissions above table.
- The limit is applied as below,  
Non-restricted band = Fundamental level – 20dB  
Restricted band = FCC Part15. 209
- Description of tested band  
“F” = Fundamental signal / “NRB” = Emission in non-restricted band / “RB” = Emission in restricted Band
- Description of Distance Factor  
For finding emissions, the test distance might be reduced from 3m to 1m.  
In this case, the distance factor (-9.54 dB) is applied to the result.  
- Calculation of distance factor =  $20 \log(\text{applied distance} / \text{required distance}) = 20 \log(1\text{m} / 3\text{m}) = -9.54\text{dB}$   
When distance factor is “N/A”, the distance is 3m and distance factor is not applied.
- Sample Calculation  
Margin = Limit – Result / Result = Reading + T.F / T.F = AF + CL – AG  
Where, T.F = Total Factor, AF = Antenna Factor, CL = Cable Loss, AG = Amplifier Gain,
- D.C.F Calculation. (D.C.F = Duty Cycle Correction Factor)  
- Time to cycle through all channels =  $\Delta t = T [\text{ms}] \times 20$  minimum hopping channels, where T = pulse width = **2.88 ms**  
-  $100 \text{ ms} / \Delta t [\text{ms}] = H \rightarrow$  Round up to next highest integer, to account for worst case,  $H' = 100 / (2.88 \times 20) = 1.736 \approx 2$   
- The Worst Case Dwell Time =  $T [\text{ms}] \times H' = 2.88 \text{ ms} \times 2 = 5.76 \text{ ms}$   
- D.C.F =  $20 \log(\text{The Worst Case Dwell Time} / 100 \text{ ms}) \text{ dB} = 20 \log(5.76 / 100) = \underline{\underline{-24.79 \text{ dB}}}$

### 7.4.2. Conducted Spurious Emissions

#### Low Band-edge

#### *Lowest Channel & Modulation : GFSK*



#### Low Band-edge

#### *Hopping mode & Modulation : GFSK*

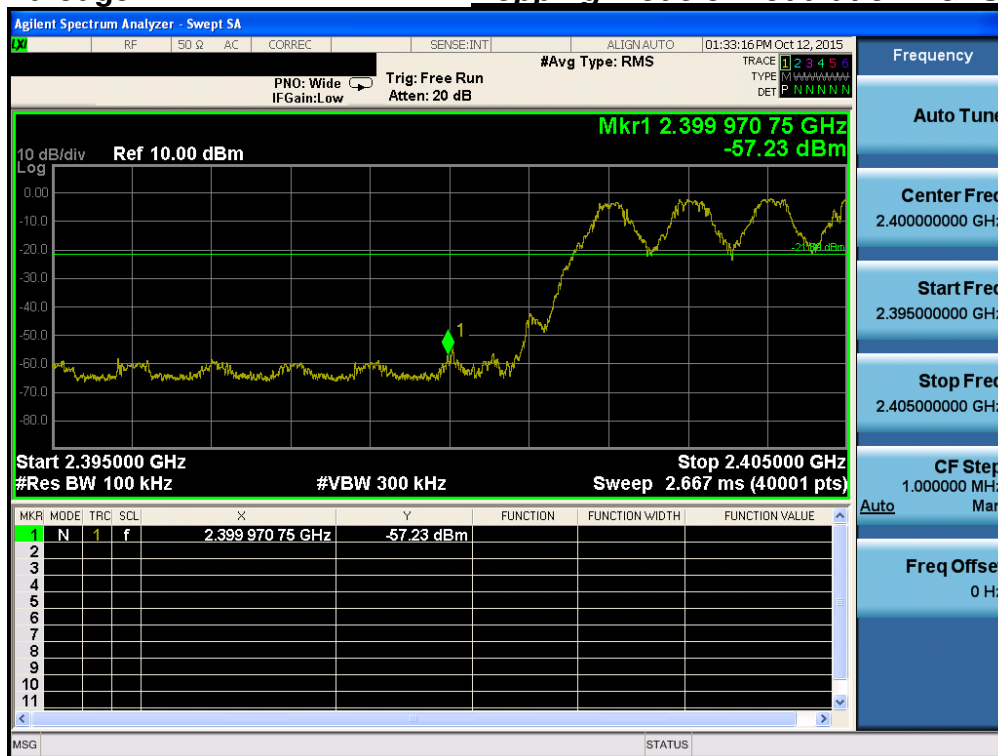

**Conducted Spurious Emissions** *Lowest Channel & Modulation : GFSK*

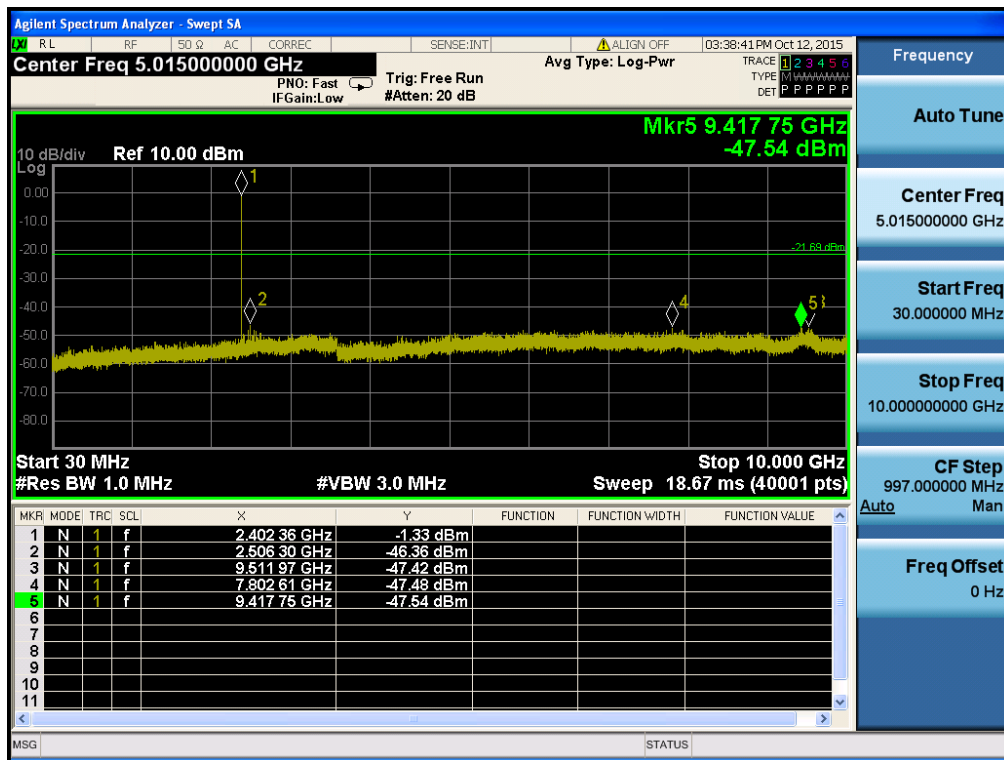
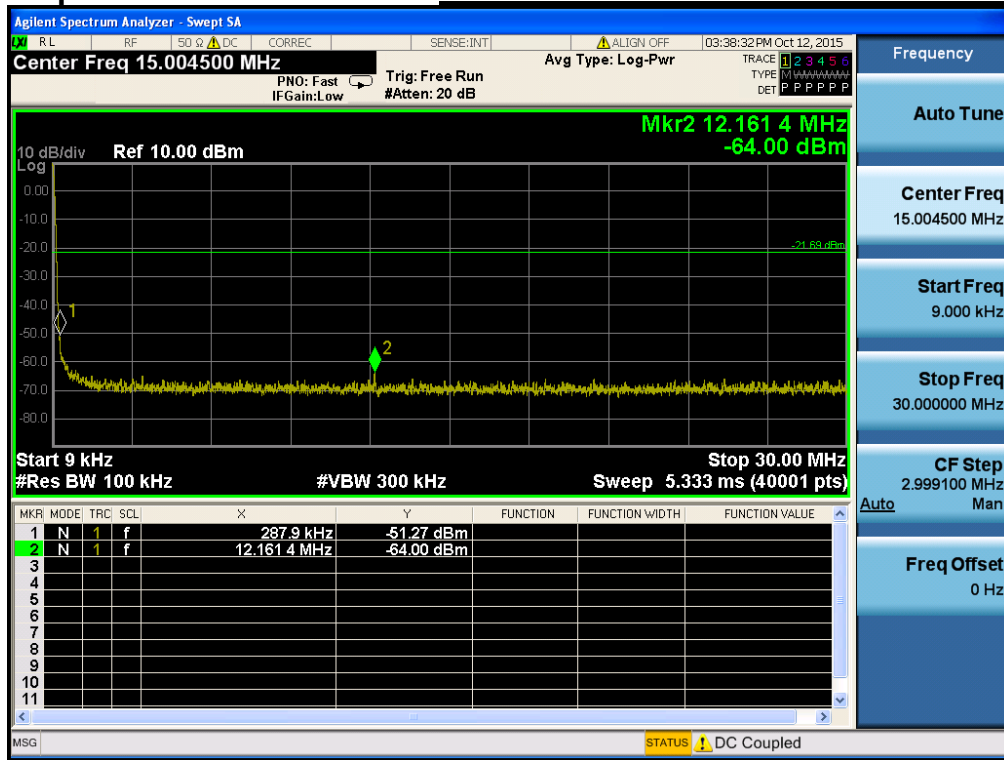

**Conducted Spurious Emissions** *Lowest Channel & Modulation : GFSK*

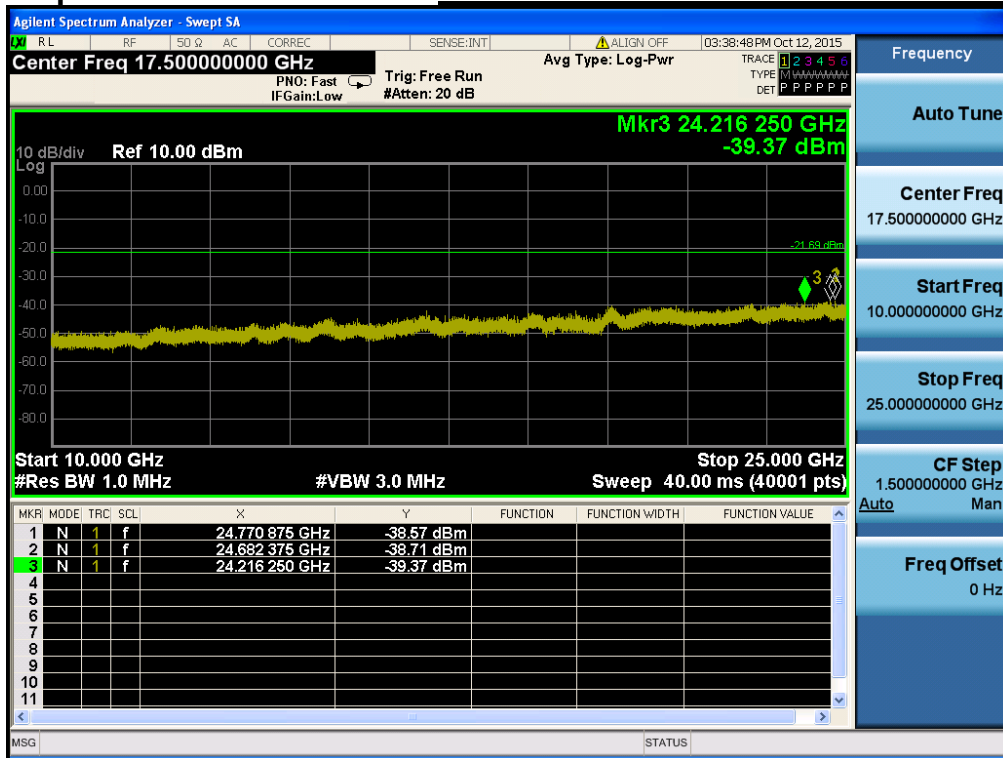

Reference for limit

Middle Channel & Modulation : GFSK

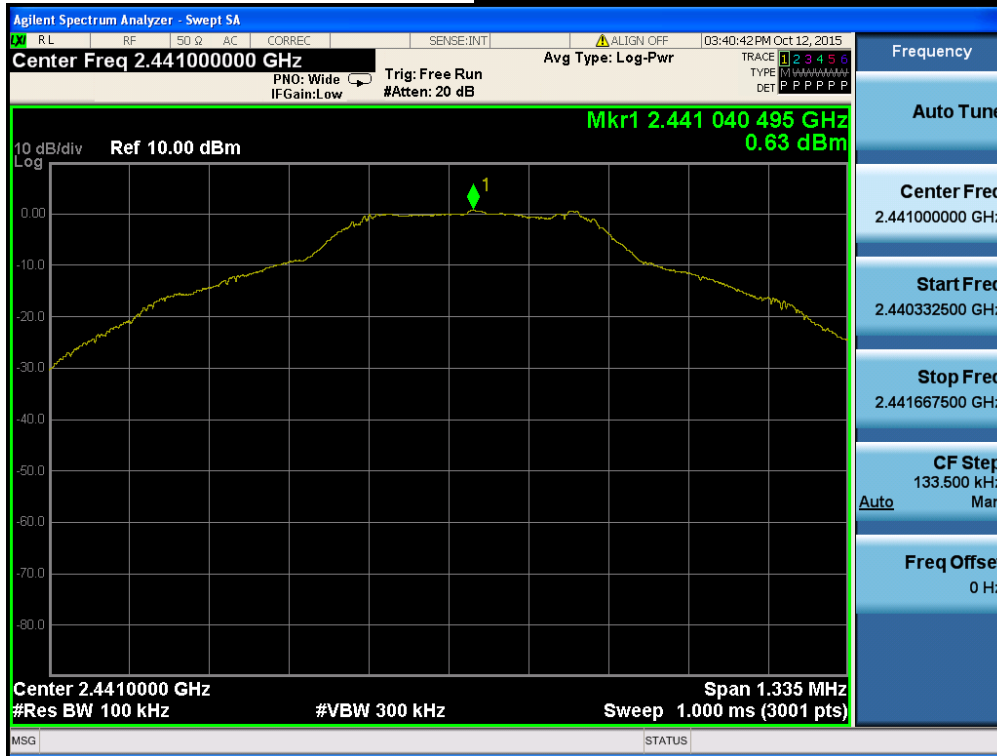

Conducted Spurious Emissions

Middle Channel & Modulation : GFSK

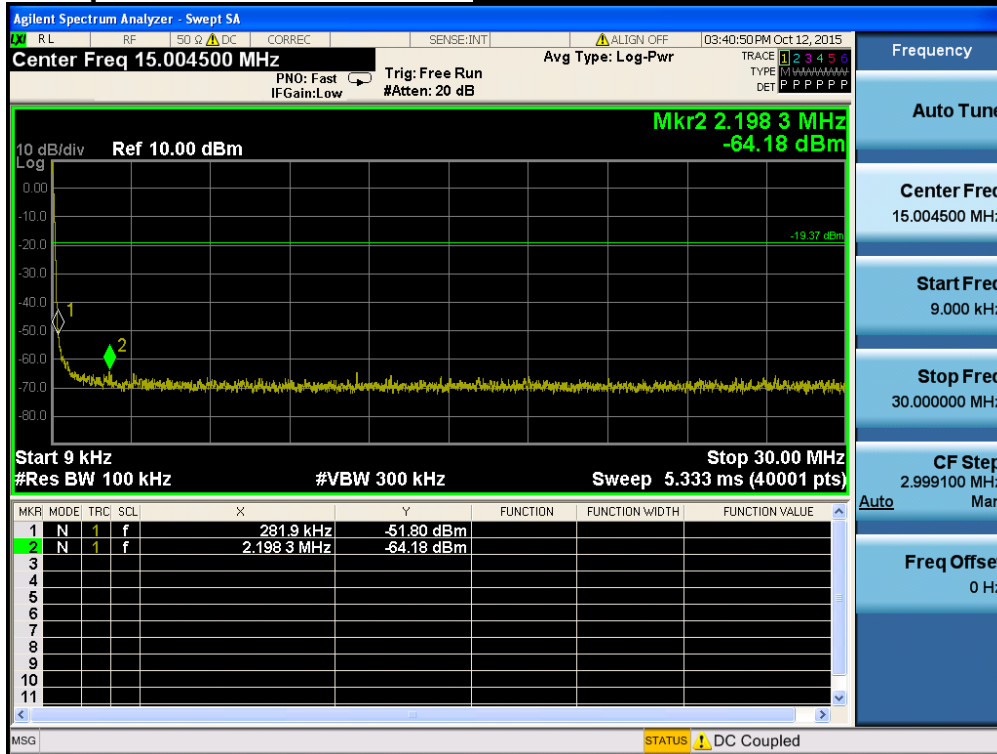

**Conducted Spurious Emissions** *Middle Channel & Modulation : GFSK*

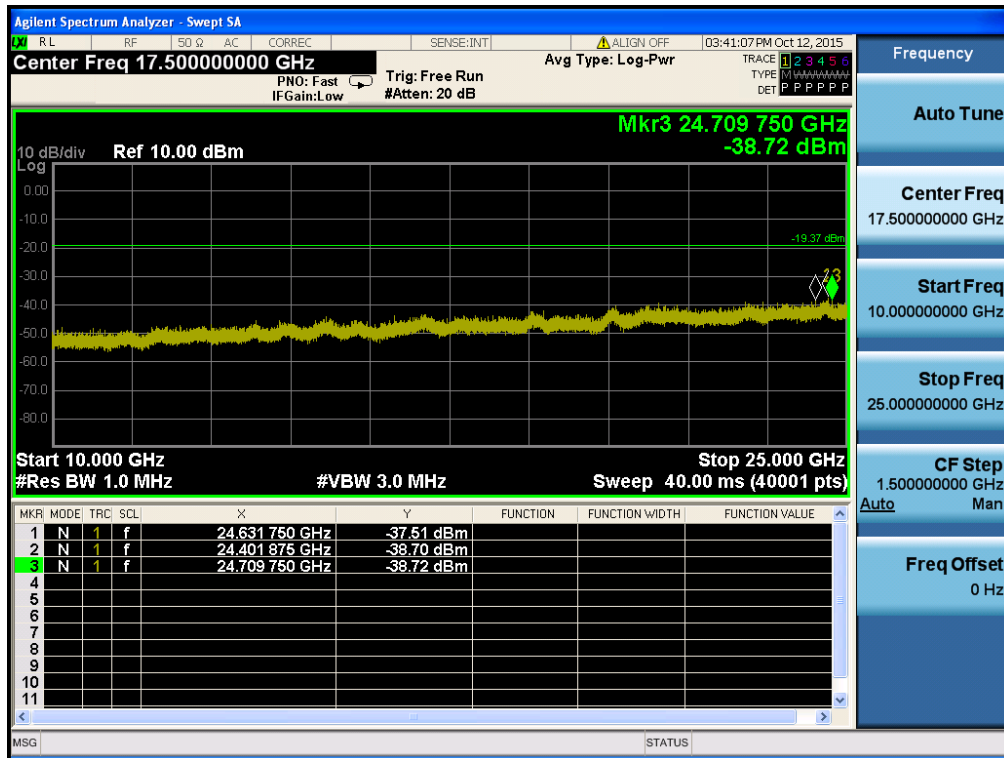
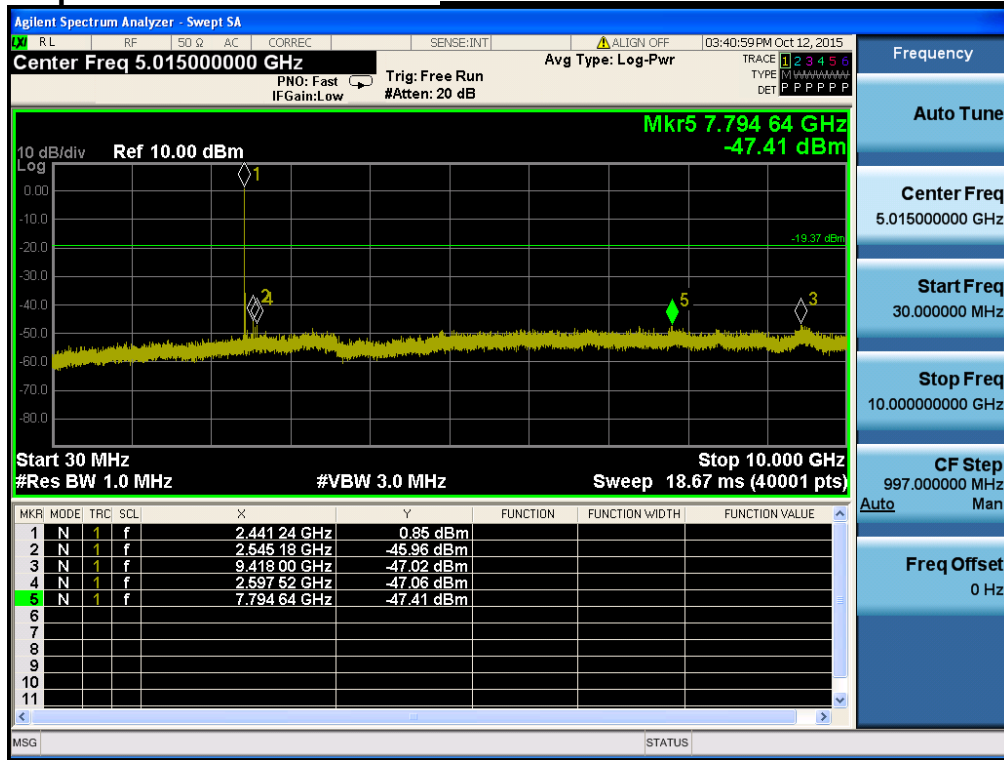

### High Band-edge

### Highest Channel & Modulation : GFSK

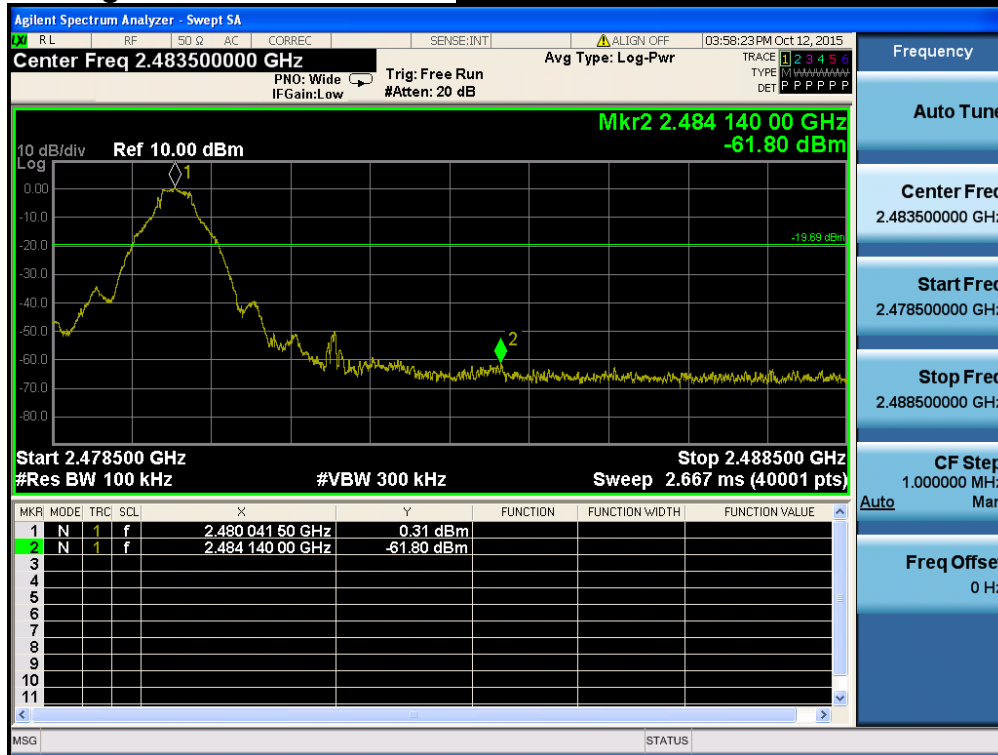

### High Band-edge

### Hopping mode & Modulation : GFSK



**Conducted Spurious Emissions**      *Highest Channel & Modulation : GFSK*

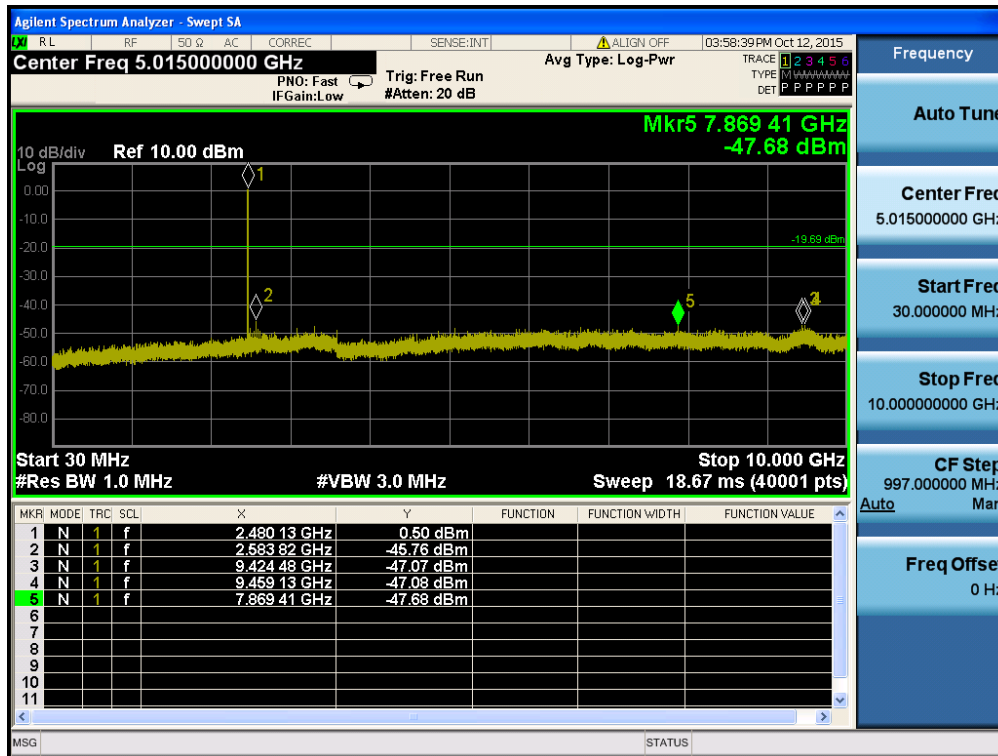
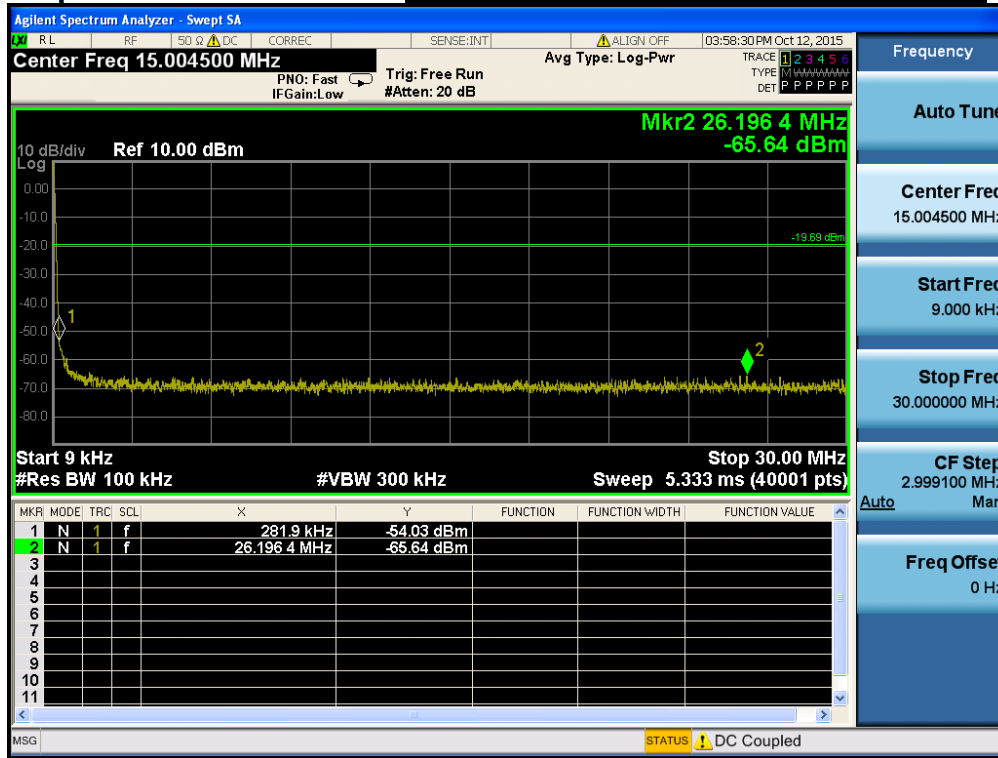

**Conducted Spurious Emissions**      *Highest Channel & Modulation : GFSK*

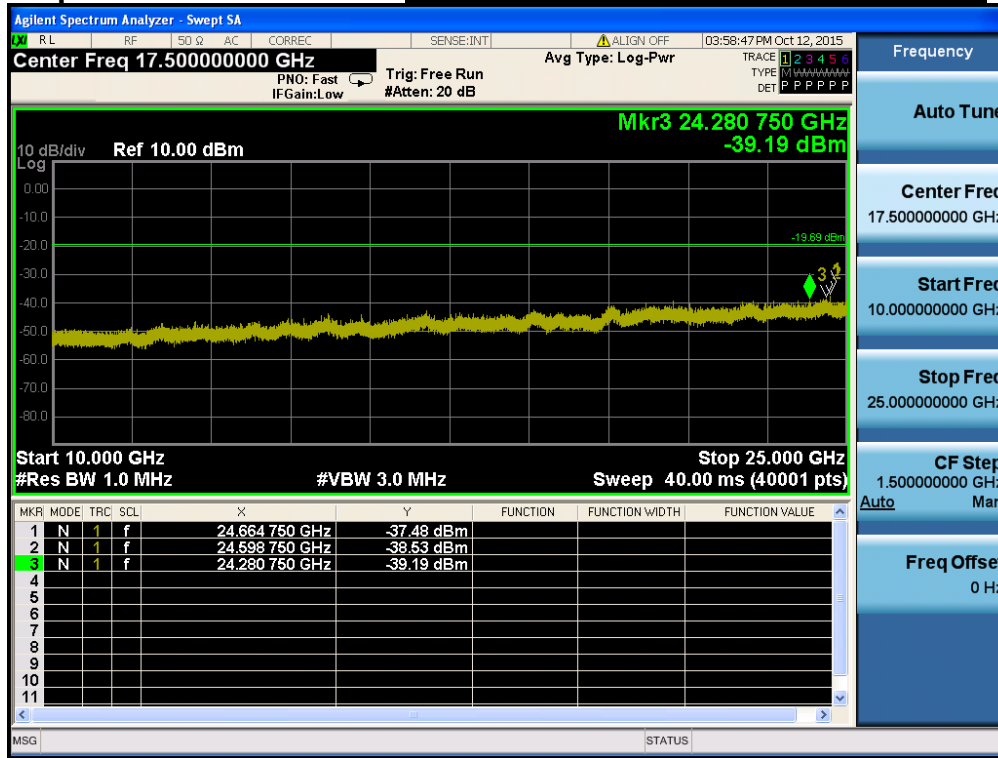

Low Band-edge

Lowest Channel & Modulation :  $\pi/4$ DQPSK

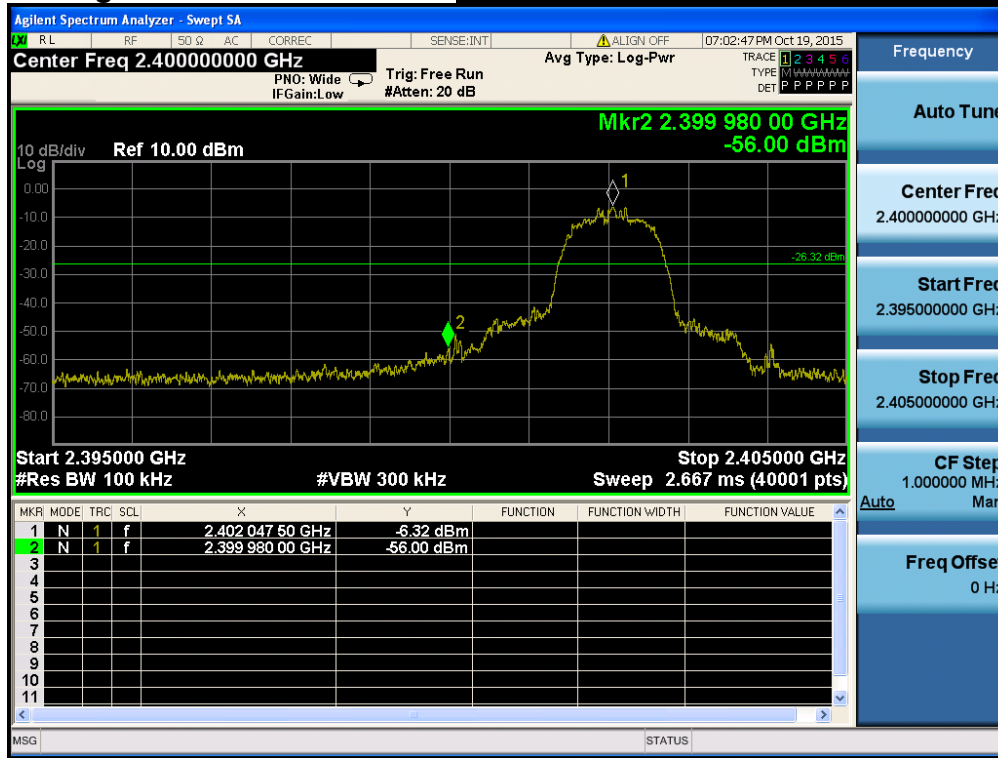

Low Band-edge

Hopping mode & Modulation :  $\pi/4$ DQPSK

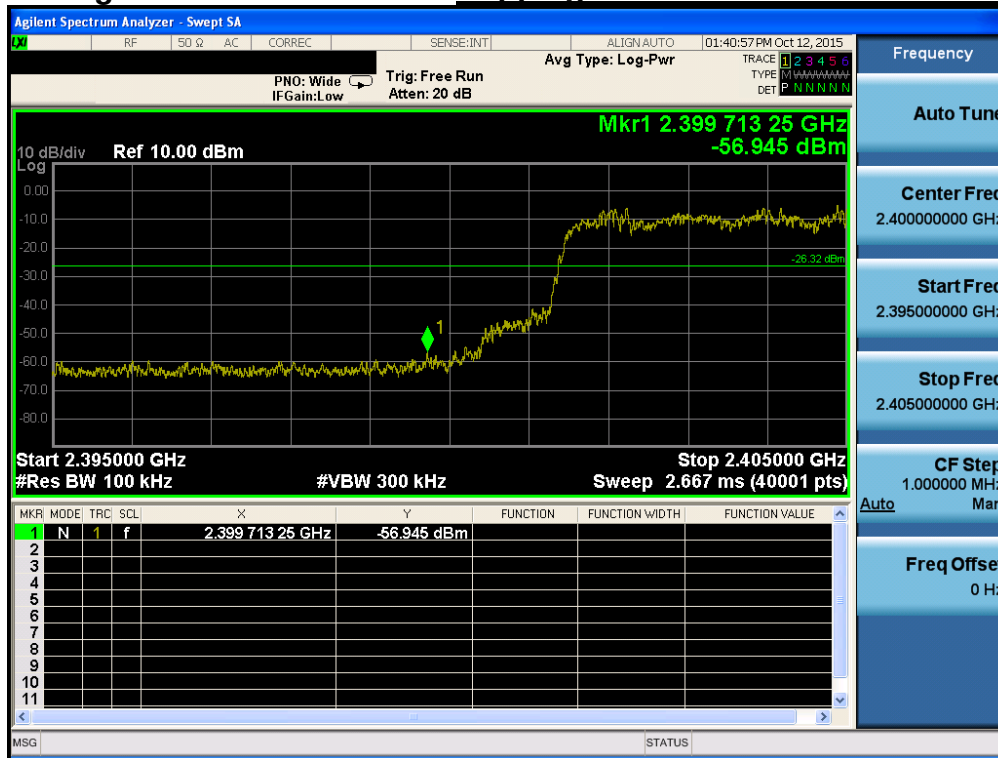

**Conducted Spurious Emissions**      **Lowest Channel & Modulation :  $\pi/4$ DQPSK**

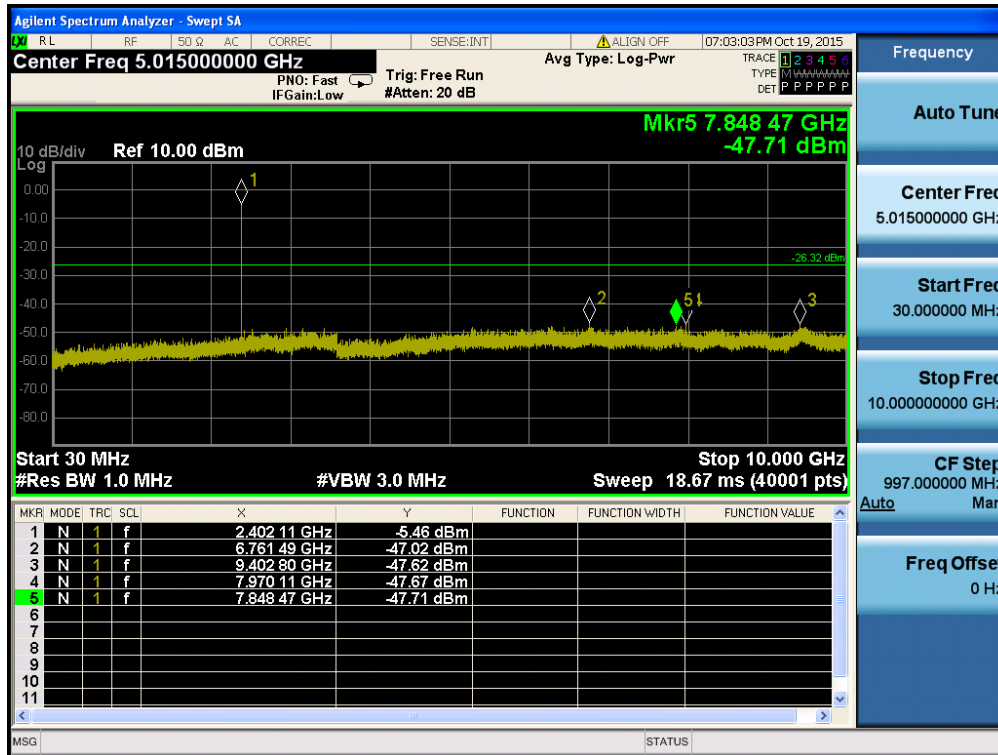
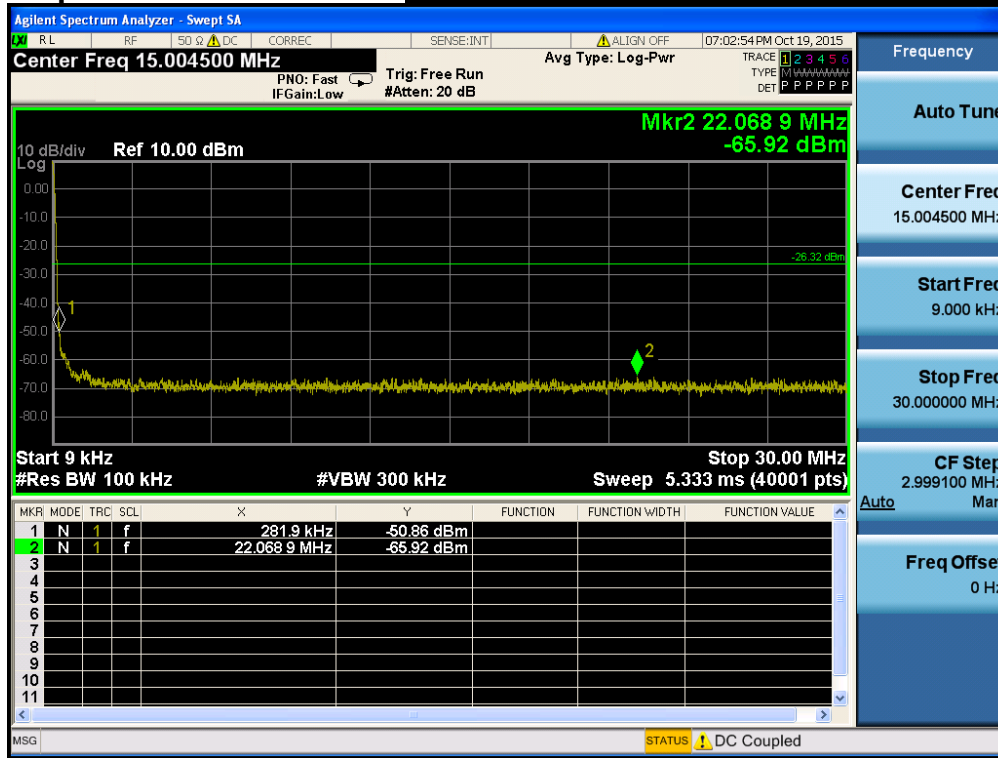

**Conducted Spurious Emissions**      ***Lowest Channel & Modulation :  $\pi/4$ DQPSK***

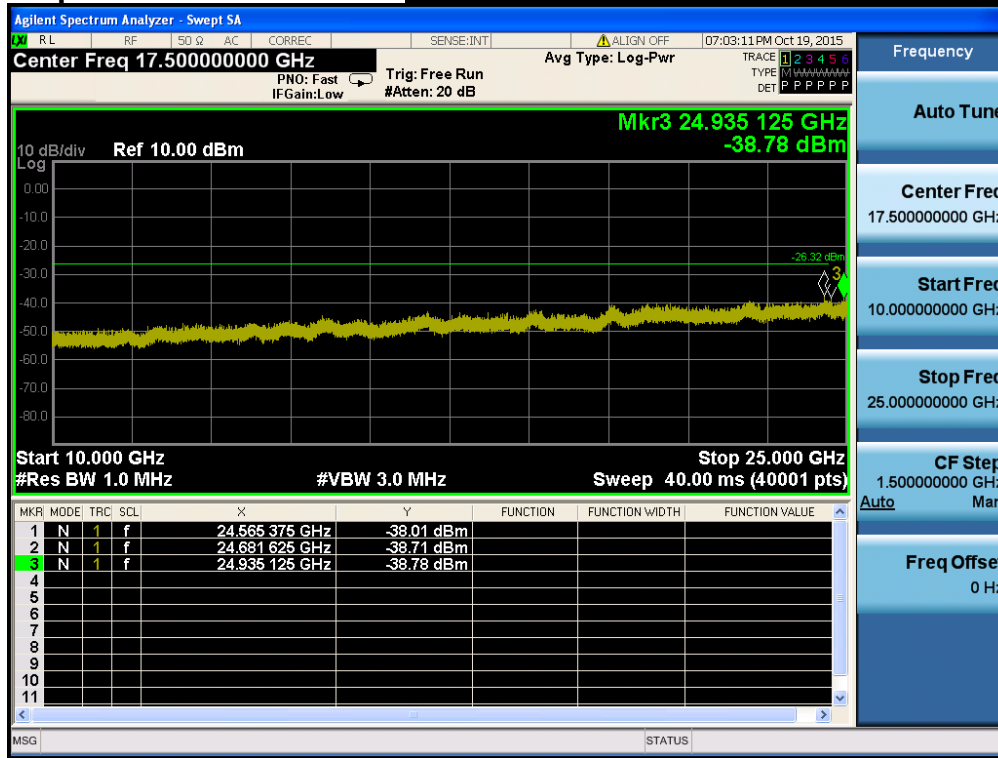

Reference for limit

Middle Channel & Modulation :  $\pi/4$ DQPSK

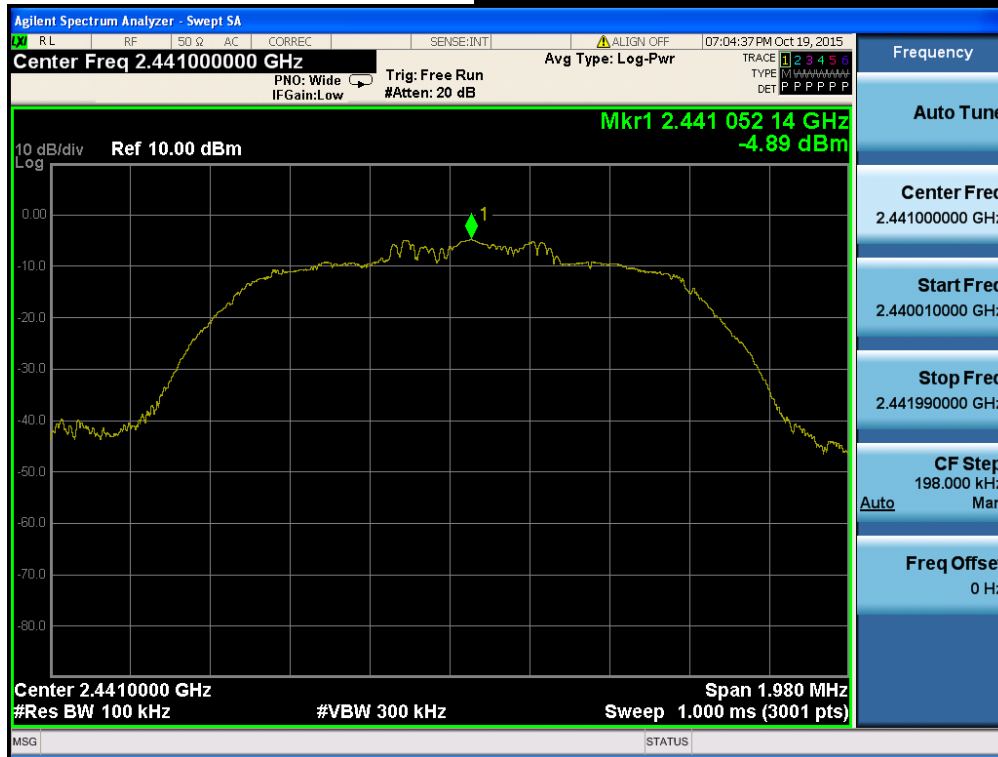

Conducted Spurious Emissions

Middle Channel & Modulation :  $\pi/4$ DQPSK

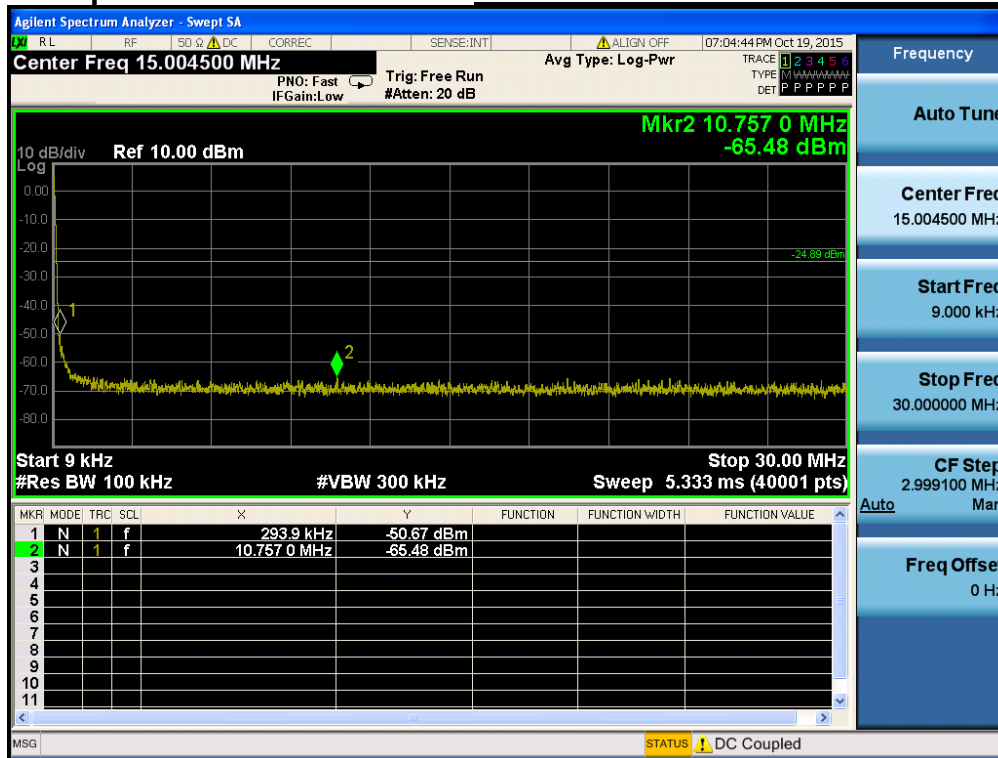

**Conducted Spurious Emissions** *Middle Channel & Modulation :  $\pi/4$ DQPSK*

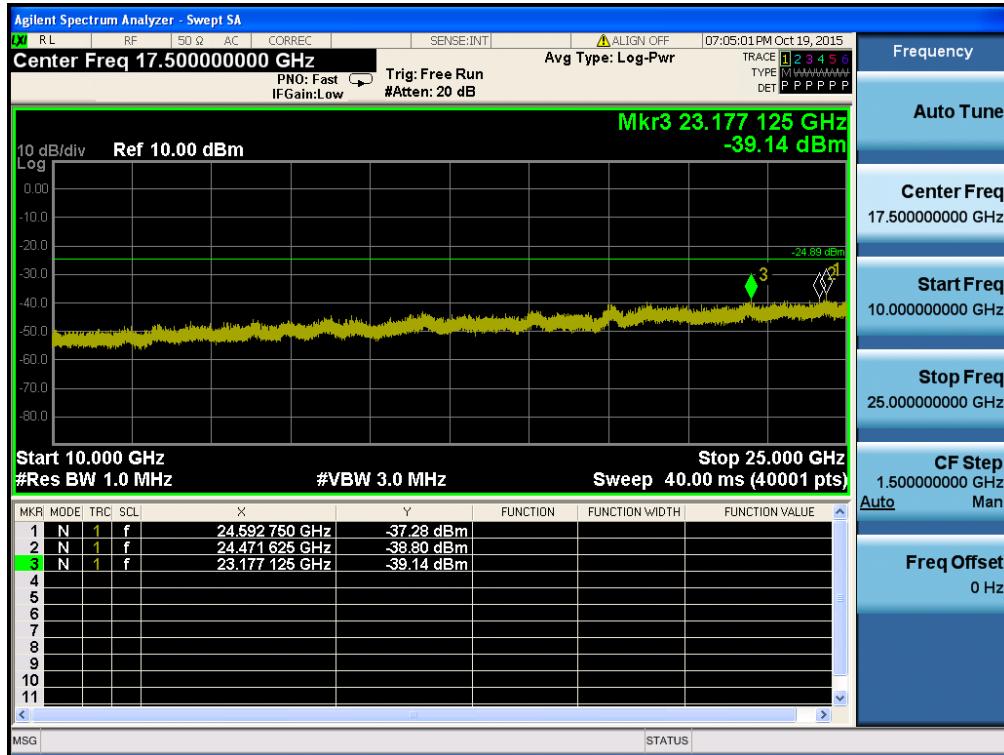
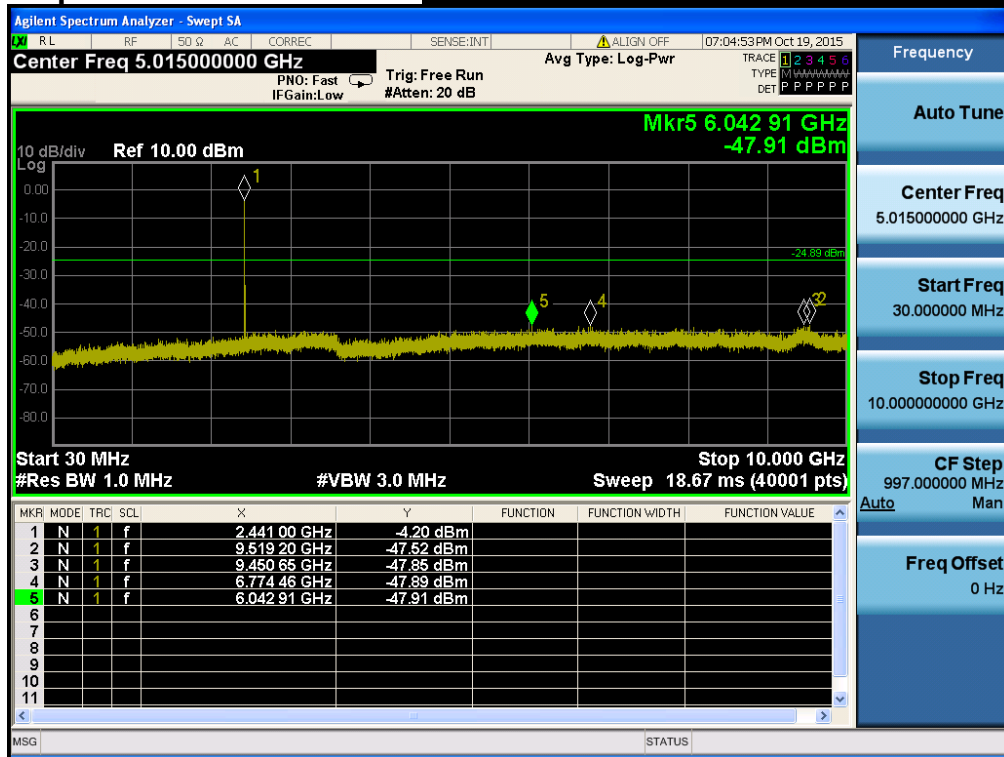

**High Band-edge**

**Highest Channel & Modulation :  $\pi/4$ DQPSK**

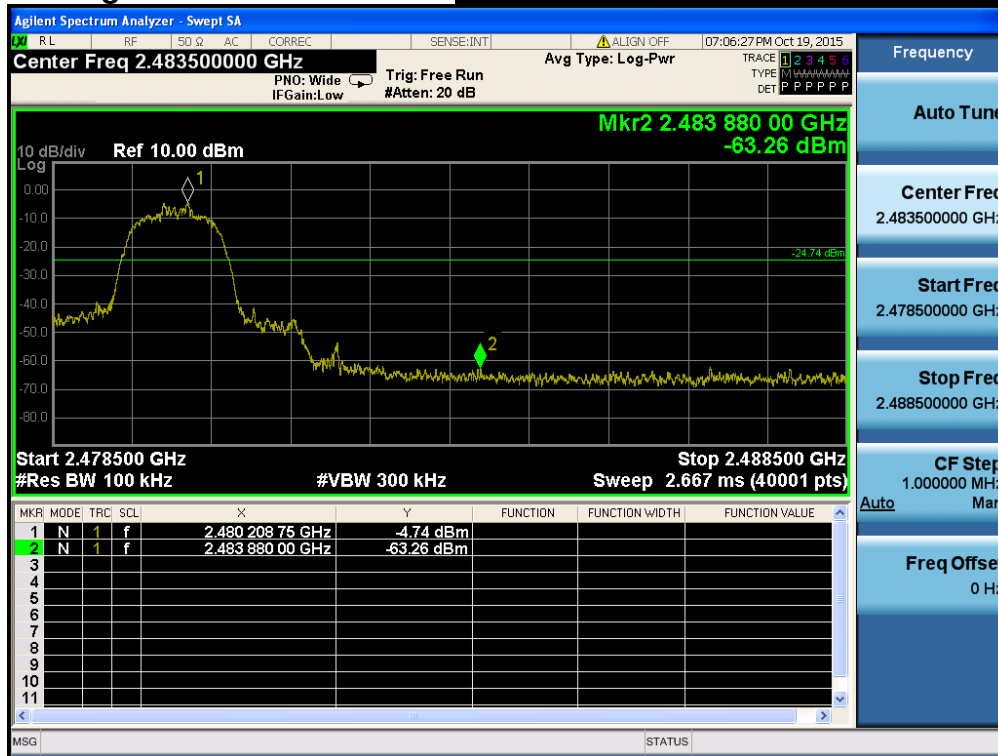

**High Band-edge**

**Hopping mode & Modulation :  $\pi/4$ DQPSK**

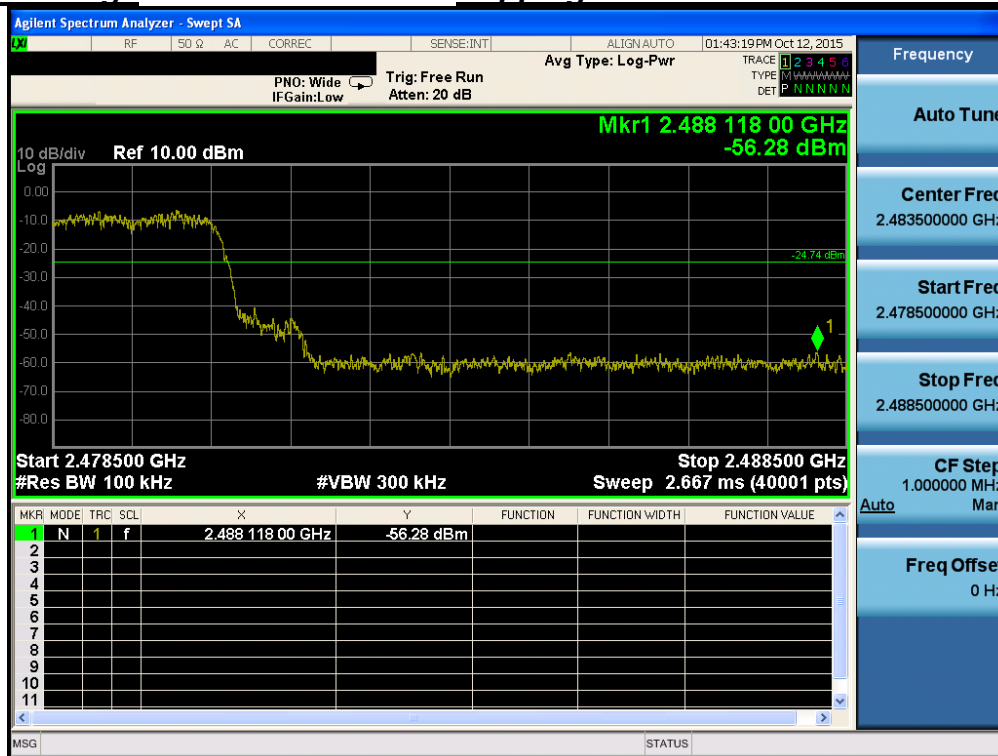

Conducted Spurious Emissions

*Highest Channel & Modulation :  $\pi/4$ DQPSK*

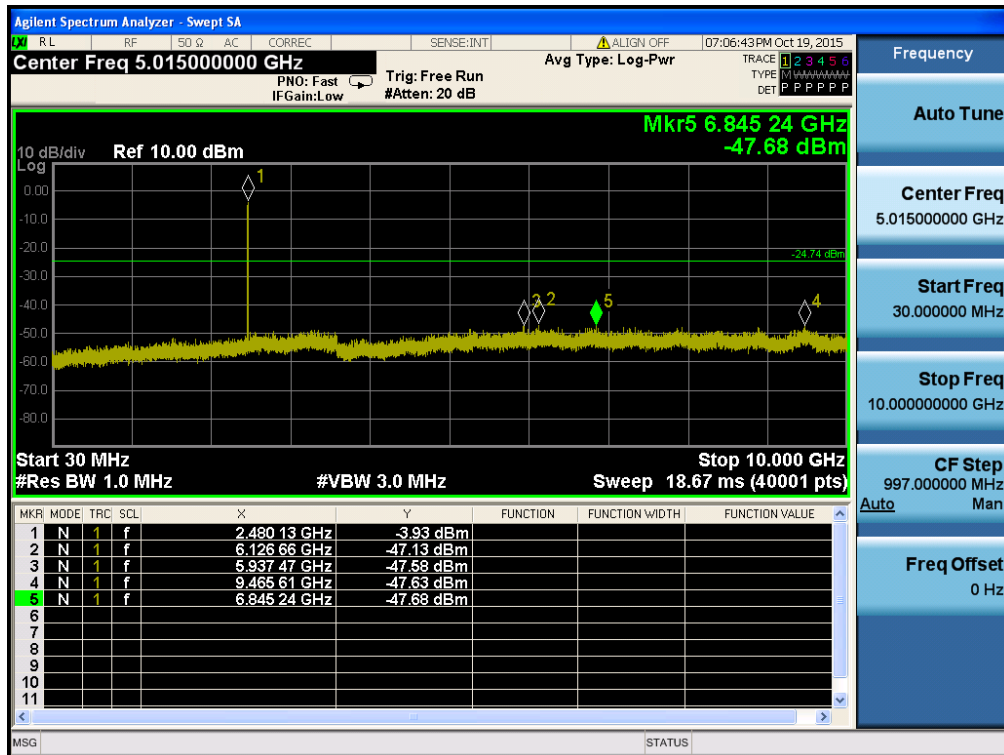
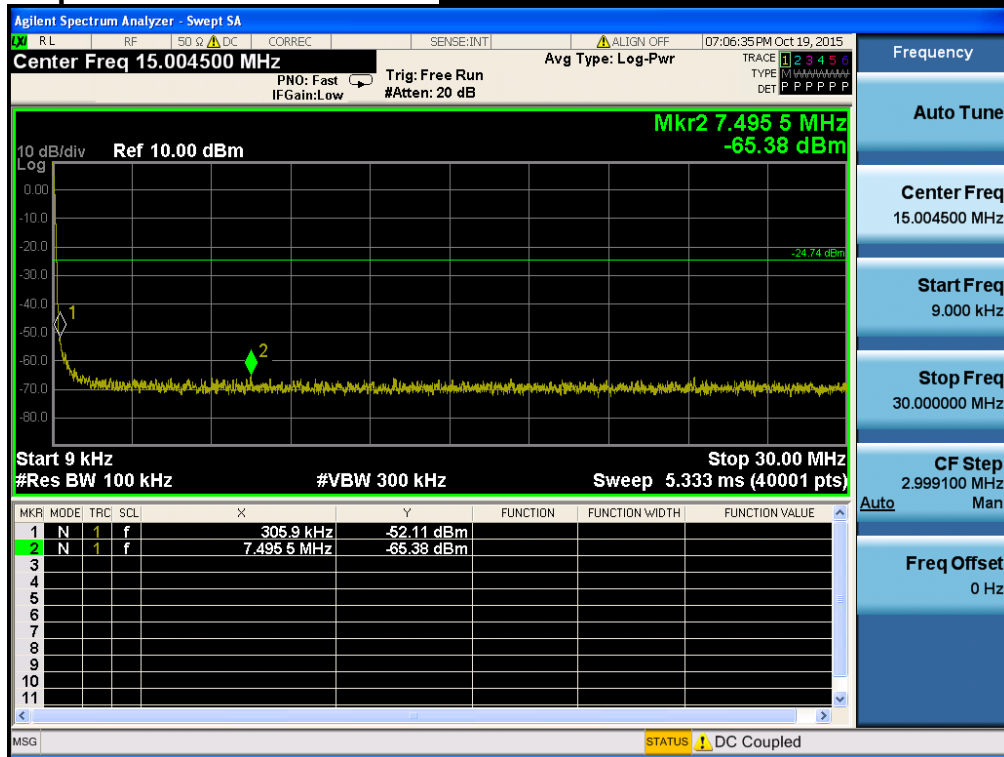

**Conducted Spurious Emissions**

***Highest Channel & Modulation :  $\pi/4$ DQPSK***

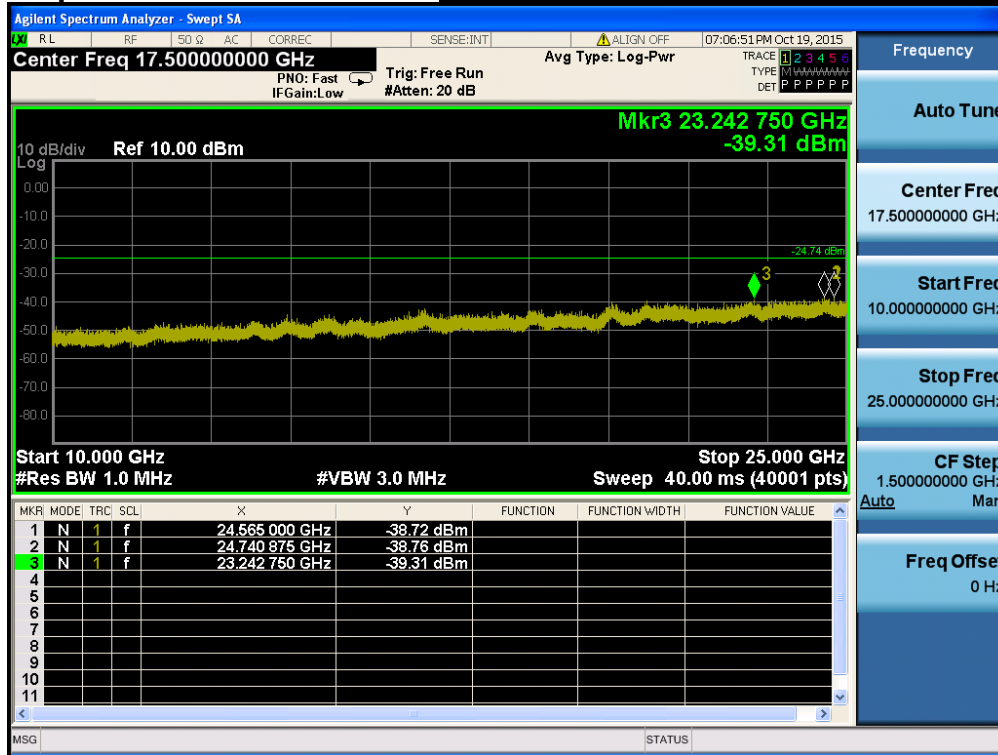

**Low Band-edge**

***Lowest Channel & Modulation : 8DPSK***

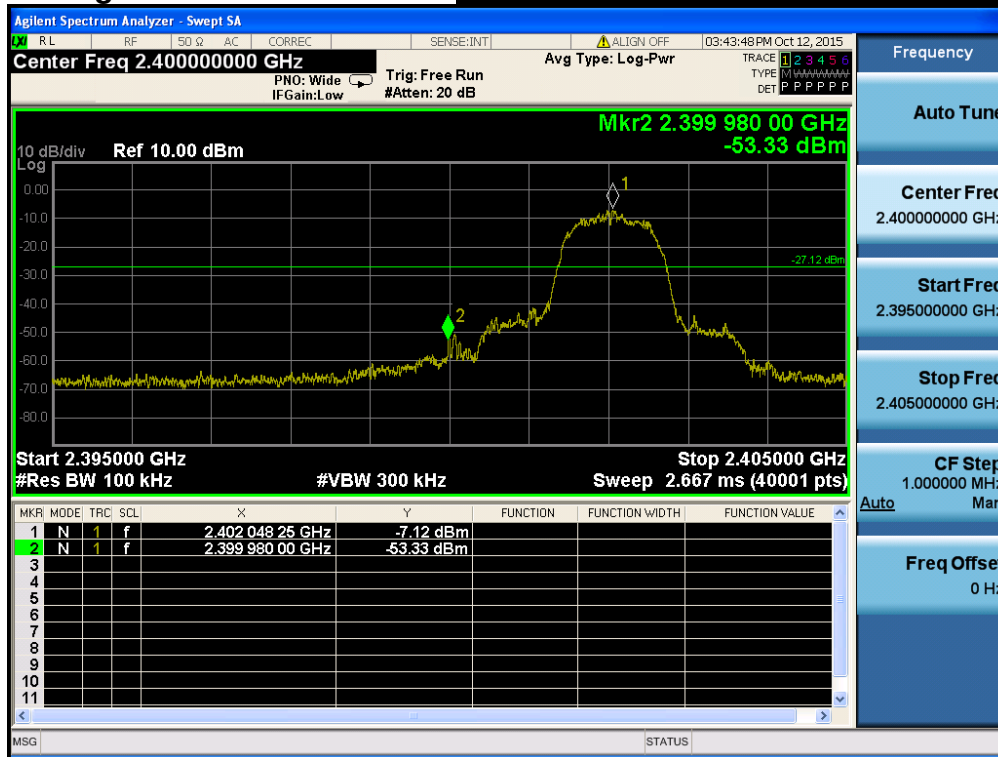

**Low Band-edge**

***Hopping mode & Modulation : 8DPSK***



**Conducted Spurious Emissions** *Lowest Channel & Modulation : 8DPSK*

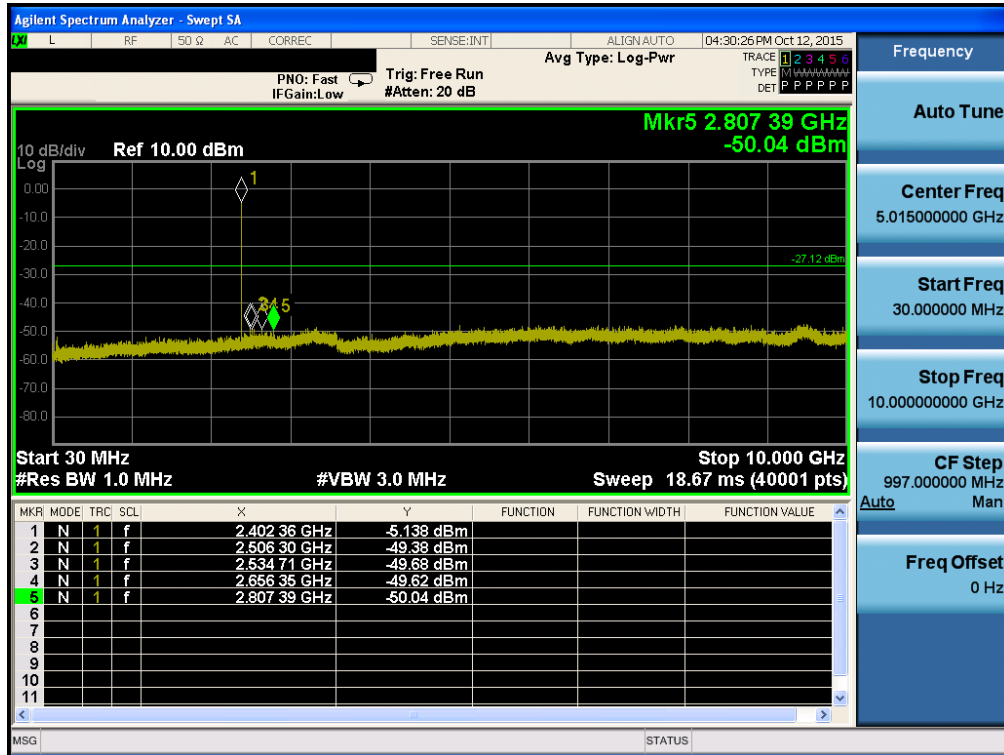
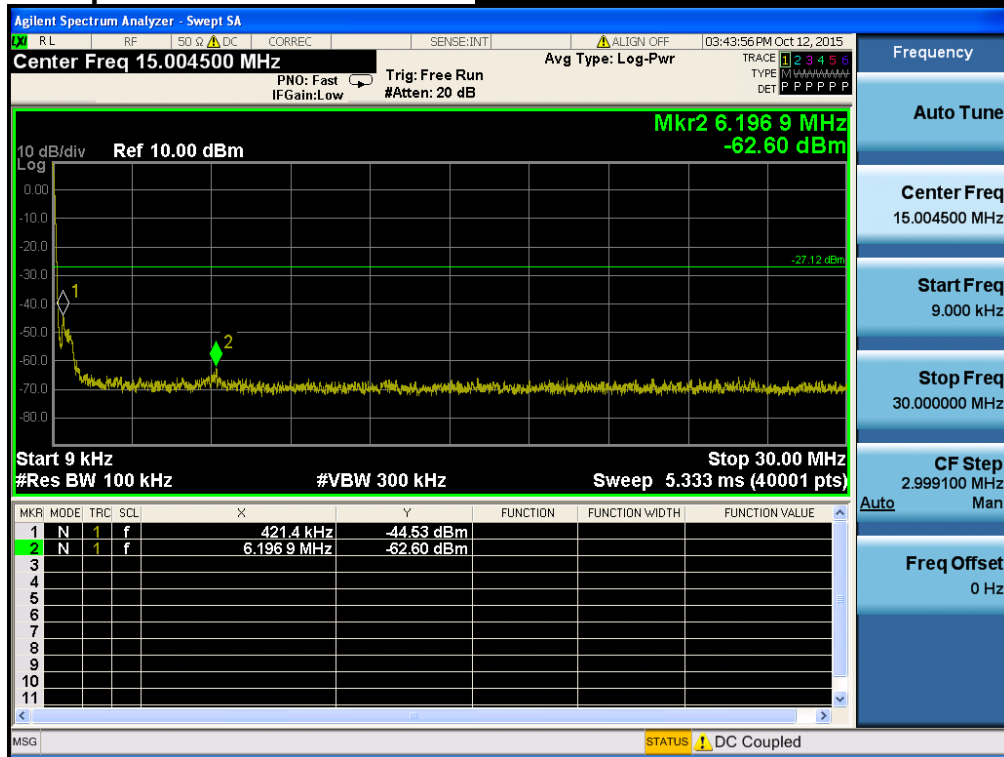

**Conducted Spurious Emissions** *Lowest Channel & Modulation : 8DPSK*

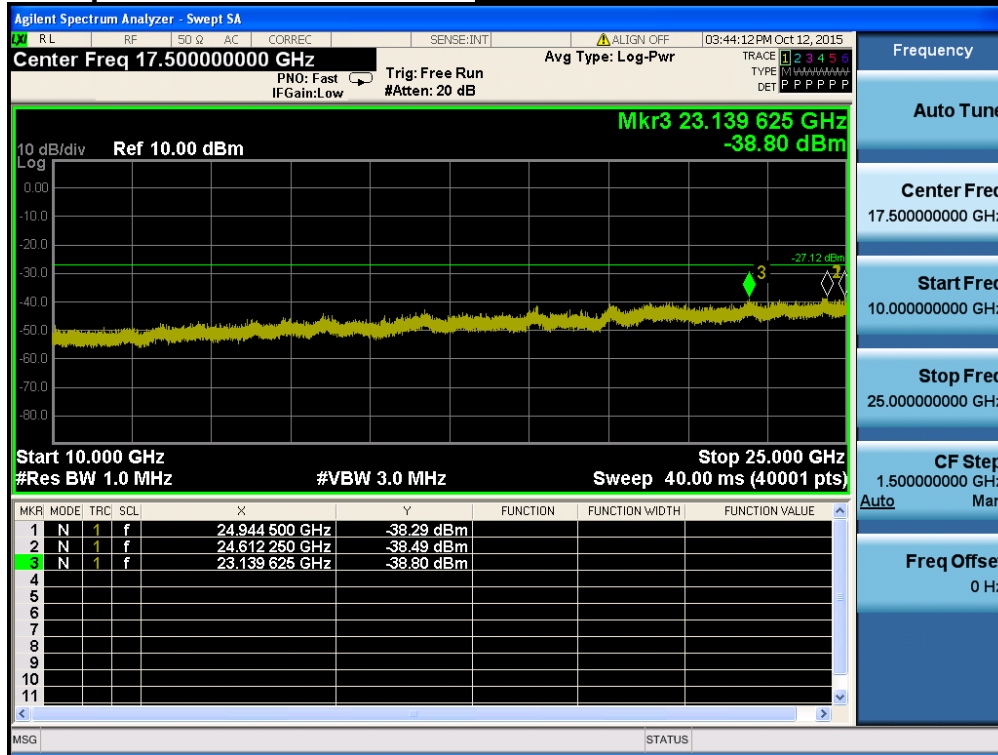

Reference for limit

Middle Channel & Modulation : 8DPSK

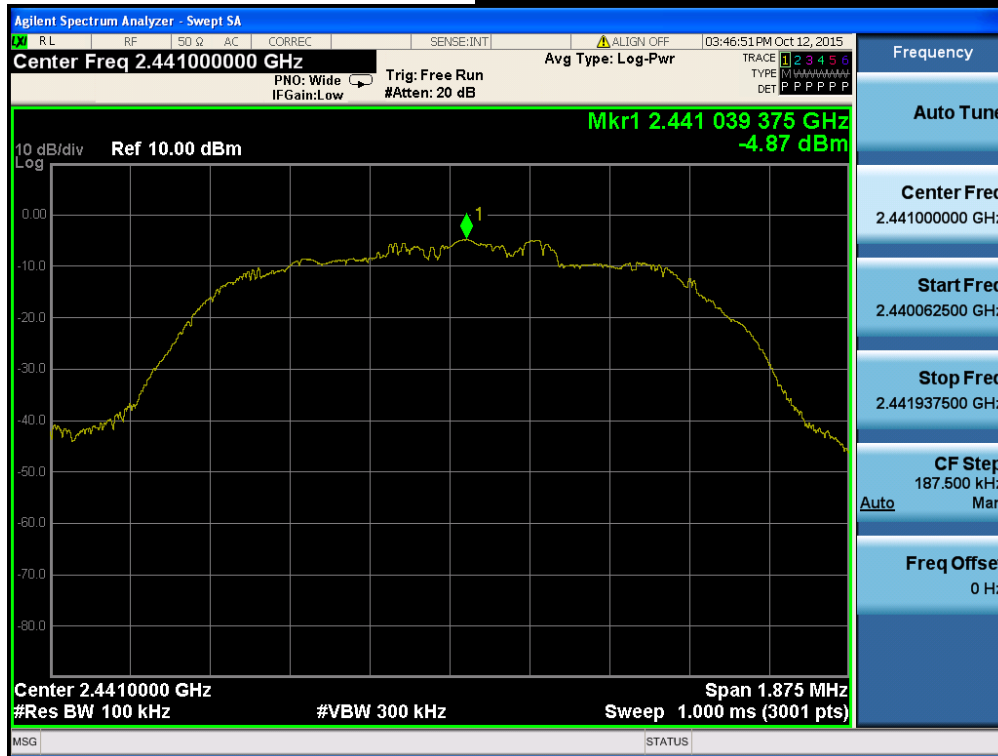

Conducted Spurious Emissions

Middle Channel & Modulation : 8DPSK

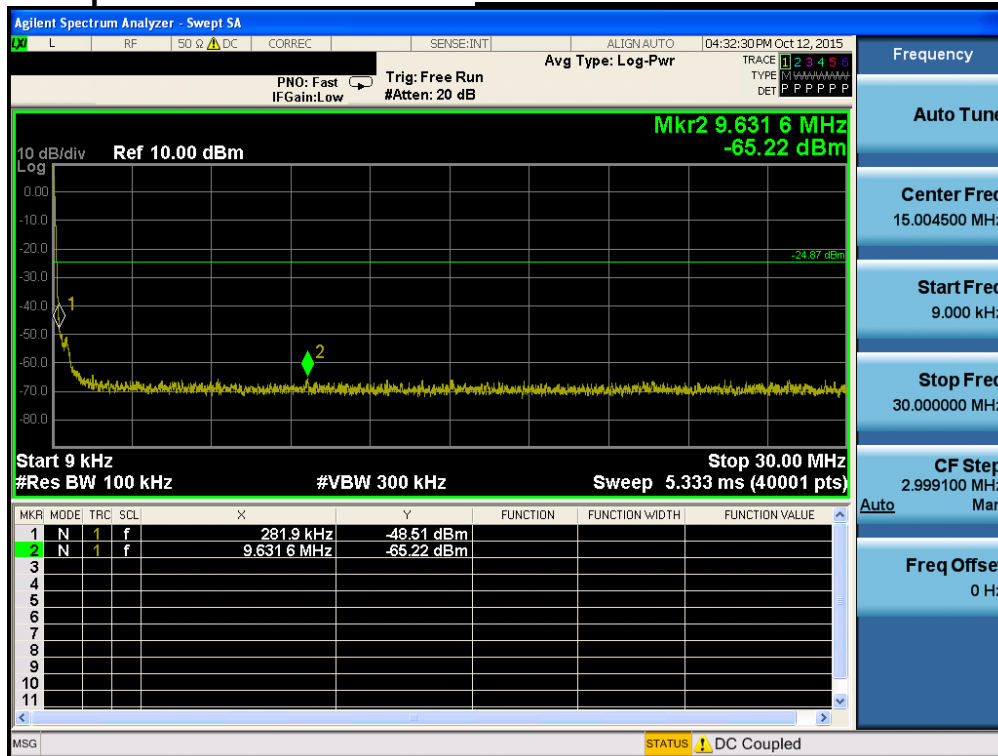

### Conducted Spurious Emissions *Middle Channel & Modulation : 8DPSK*

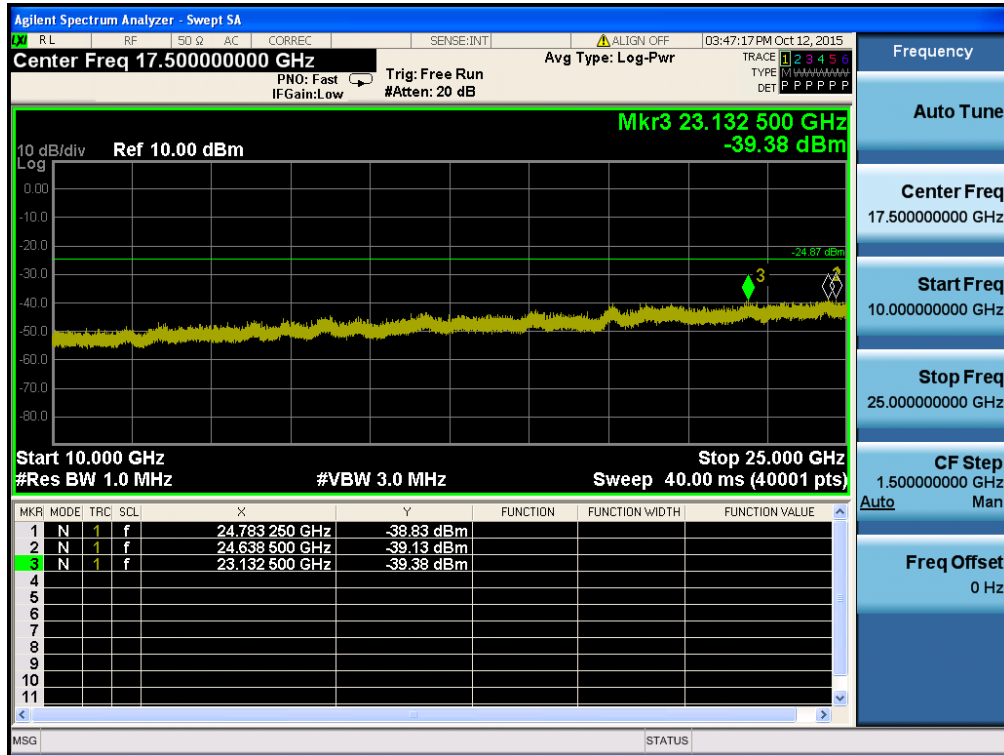
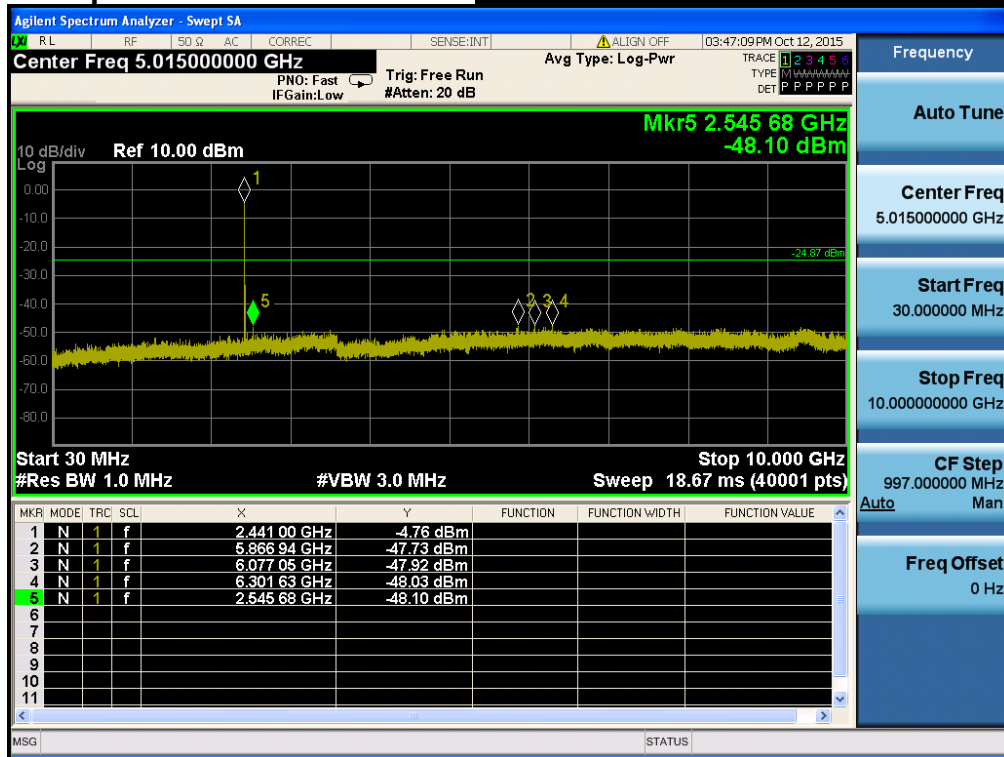

### High Band-edge

### Highest Channel & Modulation : 8DPSK

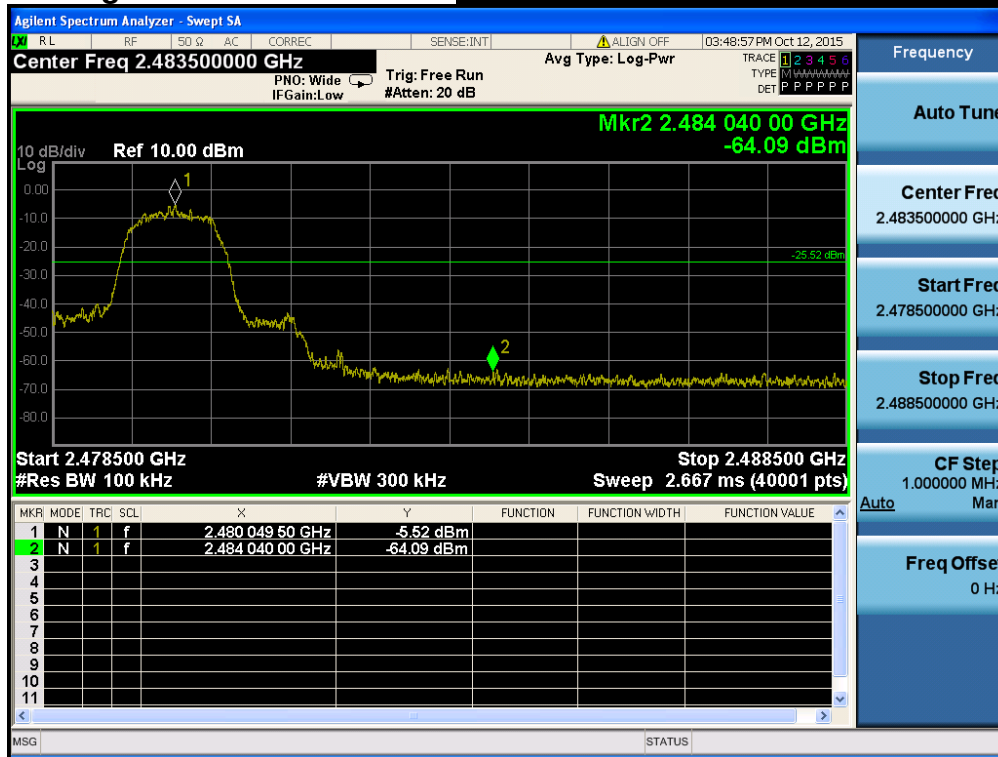

### High Band-edge

### Hopping mode & Modulation : 8DPSK



**Conducted Spurious Emissions**      ***Highest Channel & Modulation : 8DPSK***

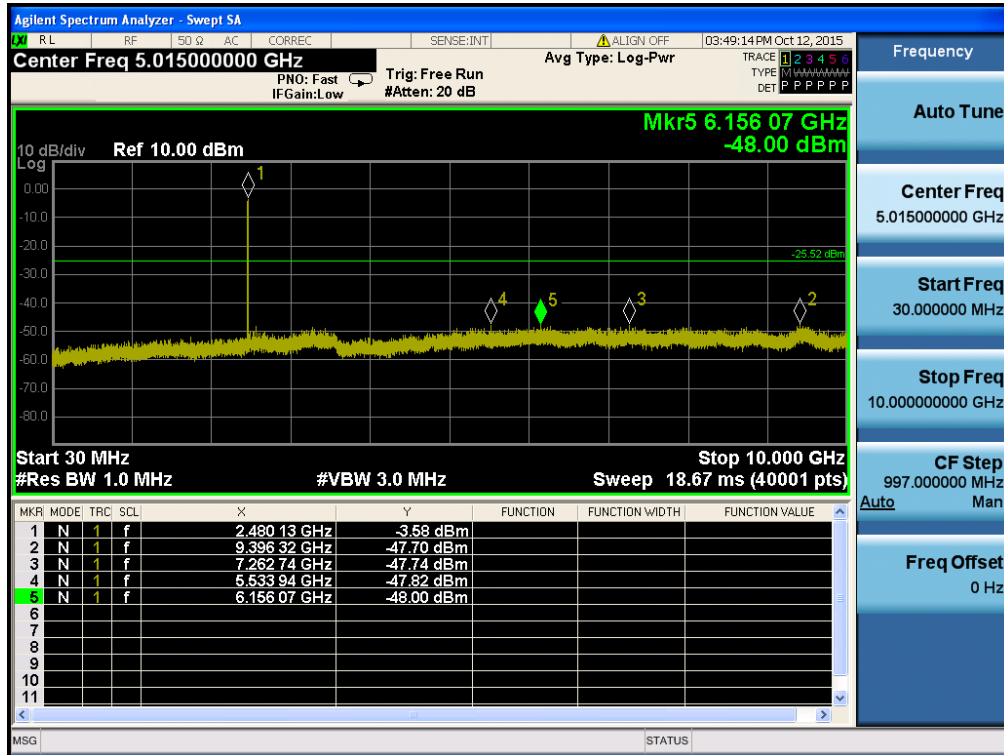
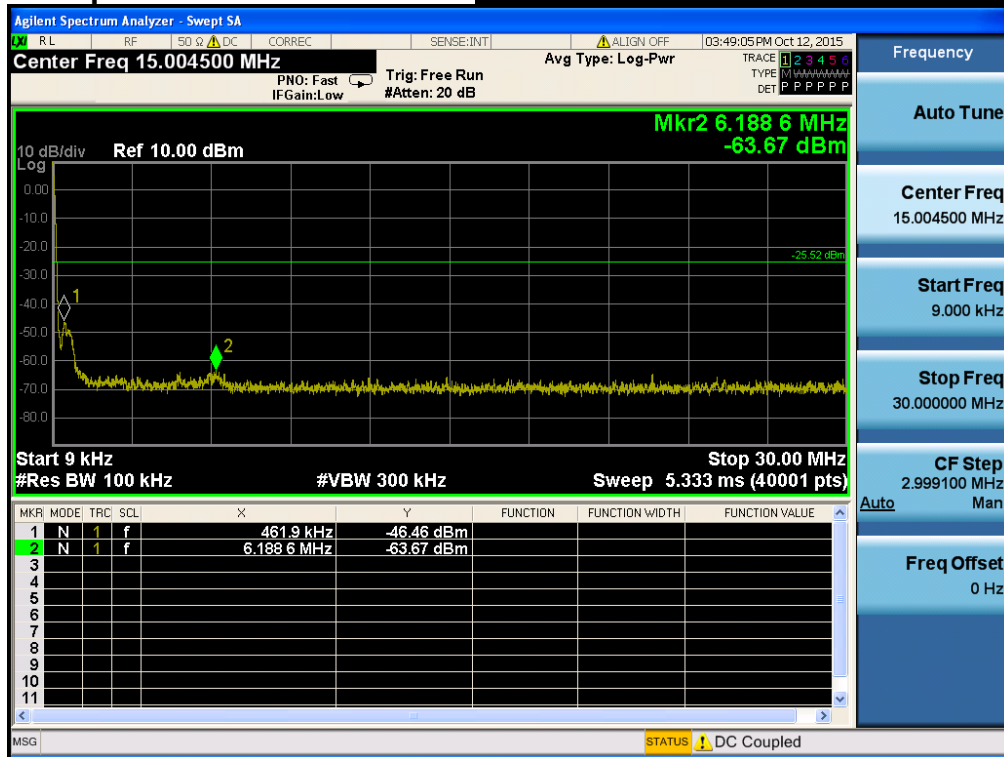

**Conducted Spurious Emissions** *Highest Channel & Modulation : 8DPSK*

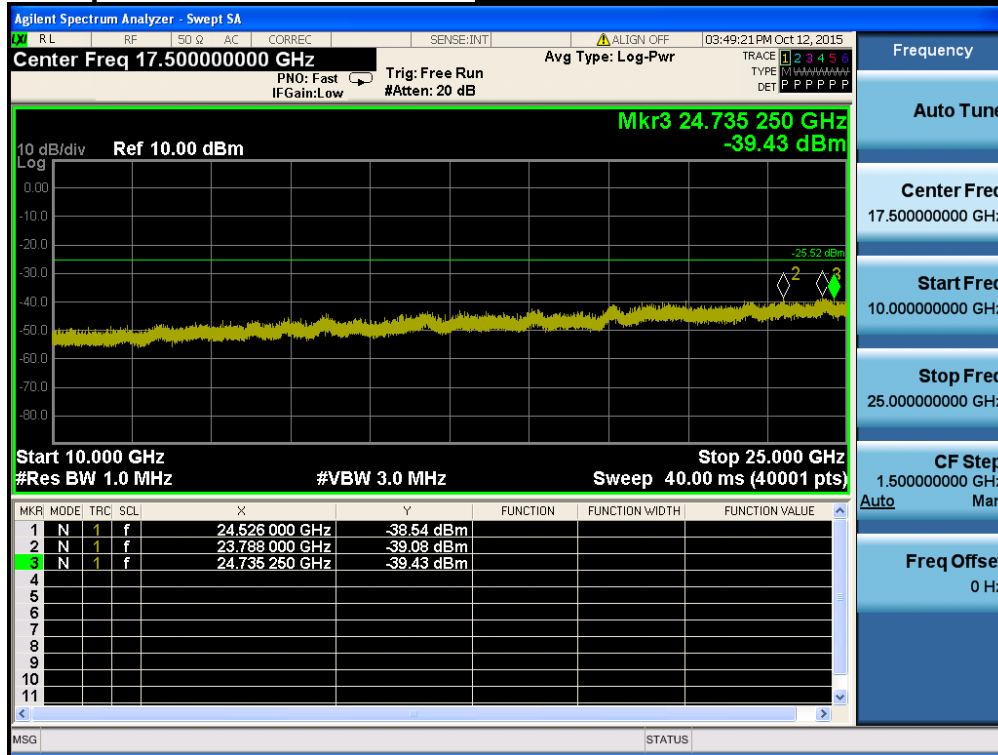

## 8. Transmitter AC Power Line Conducted Emission

### 8.1 Test Setup

Refer to test setup photo.

### 8.2 Limit

According to §15.207(a) for an intentional radiator that is designed to be connected to the public utility (AC) power line, the radio frequency voltage that is conducted back onto the AC power line on any frequency or frequencies, within the band 150 kHz to 30 MHz, shall not exceed the limits in the following table, as measured using a 50 uH/50 ohms line impedance stabilization network (LISN).

Compliance with the provisions of this paragraph shall be based on the measurement of the radio frequency voltage between each power line and ground at the power terminal. The lower applies at the boundary between the frequency ranges.

Frequency Range (MHz)	Conducted Limit (dBuV)	
	Quasi-Peak	Average
0.15 ~ 0.5	66 to 56 *	56 to 46 *
0.5 ~ 5	56	46
5 ~ 30	60	50

\* Decreases with the logarithm of the frequency

### 8.3 Test Procedures

Conducted emissions from the EUT were measured according to the ANSI C63.10.

1. The test procedure is performed in a 6.5 m × 3.5 m × 3.5 m (L × W × H) shielded room. The EUT along with its peripherals were placed on a 1.0 m (W) × 1.5 m (L) and 0.8 m in height wooden table and the EUT was adjusted to maintain a 0.4 meter space from a vertical reference plane.
2. The EUT was connected to power mains through a line impedance stabilization network (LISN) which provides 50 ohm coupling impedance for measuring instrument and the chassis ground was bounded to the horizontal ground plane of shielded room.
3. All peripherals were connected to the second LISN and the chassis ground also bounded to the horizontal ground plane of shielded room.
4. The excess power cable between the EUT and the LISN was bundled. The power cables of peripherals were unbundled. All connecting cables of EUT and peripherals were moved to find the maximum emission.

### 8.4 Test Results

**Not Applicable**

## 9. Antenna Requirement

Describe how the EUT complies with the requirement that either its antenna is permanently attached, or that it employs a unique antenna connector, for every antenna proposed for use with the EUT.

**Conclusion: Comply**

**The antenna is permanently attached. (Refer to Internal photo file.)**

**- Minimum Standard :**

An intentional radiator shall be designed to ensure that no antenna other than that furnished by the responsible party shall be used with the device. The use of a permanently attached antenna or of an antenna that uses a unique coupling to the intentional radiator shall be considered sufficient to comply with the provisions.

## 10. Occupied Bandwidth (99 %)

### 10.1 Test Setup

Refer to the APPENDIX I.

### 10.2 Limit

Limit : Not Applicable

### 10.3 Test Procedure

The 99 % power bandwidth was measured with a calibrated spectrum analyzer.

The resolution bandwidth (RBW) shall be in the range of 1 % to 5 % of the occupied bandwidth (OBW) and video

bandwidth (VBW) shall be approximately  $3 \times$  RBW.

Spectrum analyzer plots are included on the following pages.

### 10.4 Test Results

**Not Applicable**

## APPENDIX I

### Test set up diagrams

#### ▪ Radiated Measurement

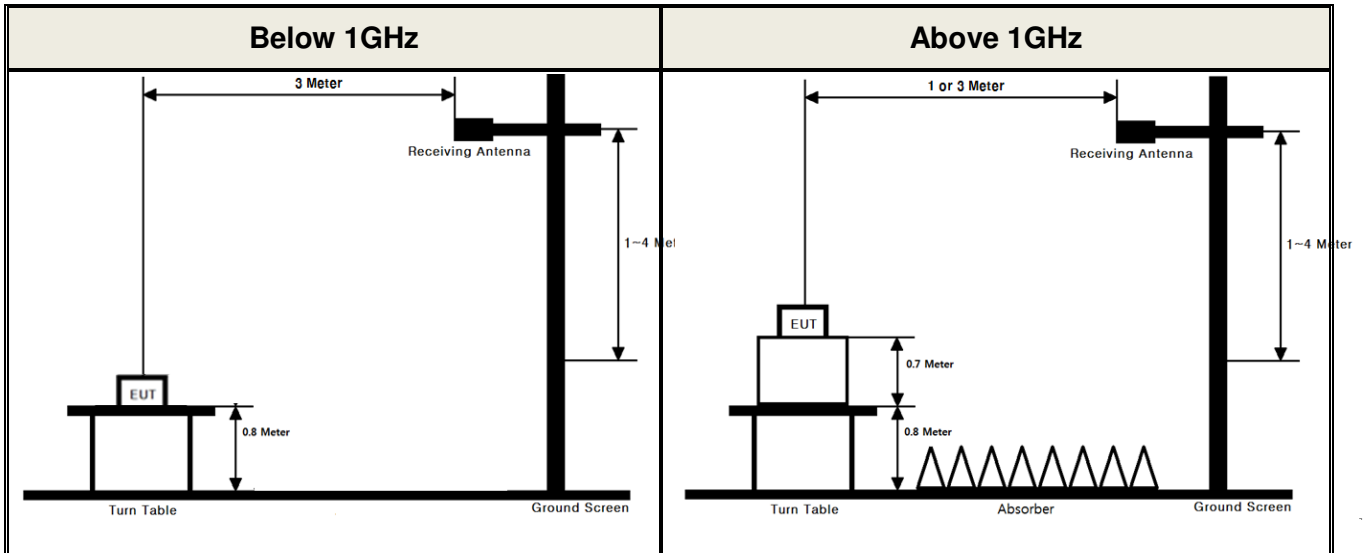

#### ▪ Conducted Measurement

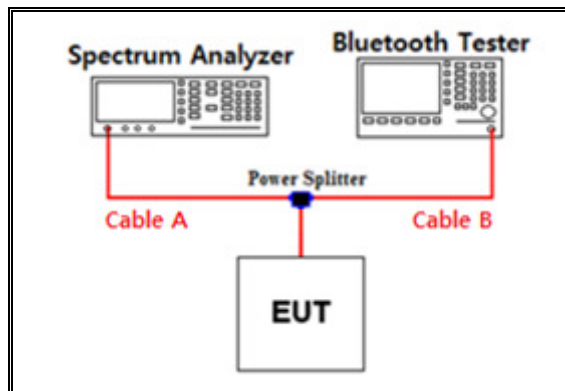

Path loss information

Frequency (GHz)	Path Loss (dB)	Frequency (GHz)	Path Loss (dB)
0.03	6.30	15	10.63
1	7.35	20	11.94
2402 & 2440 & 2480	7.87	25	13.22
5	9.75	-	-
10	10.35	-	-

Note 1 : The path loss from EUT to Spectrum analyzer were measured and used for test.

Path loss ( S/A's Correction factor) = Cable A + Power splitter

## APPENDIX II

### Unwanted Emissions (Radiated) Test Plot

GFSK & Lowest & Edge

Detector Mode : PK

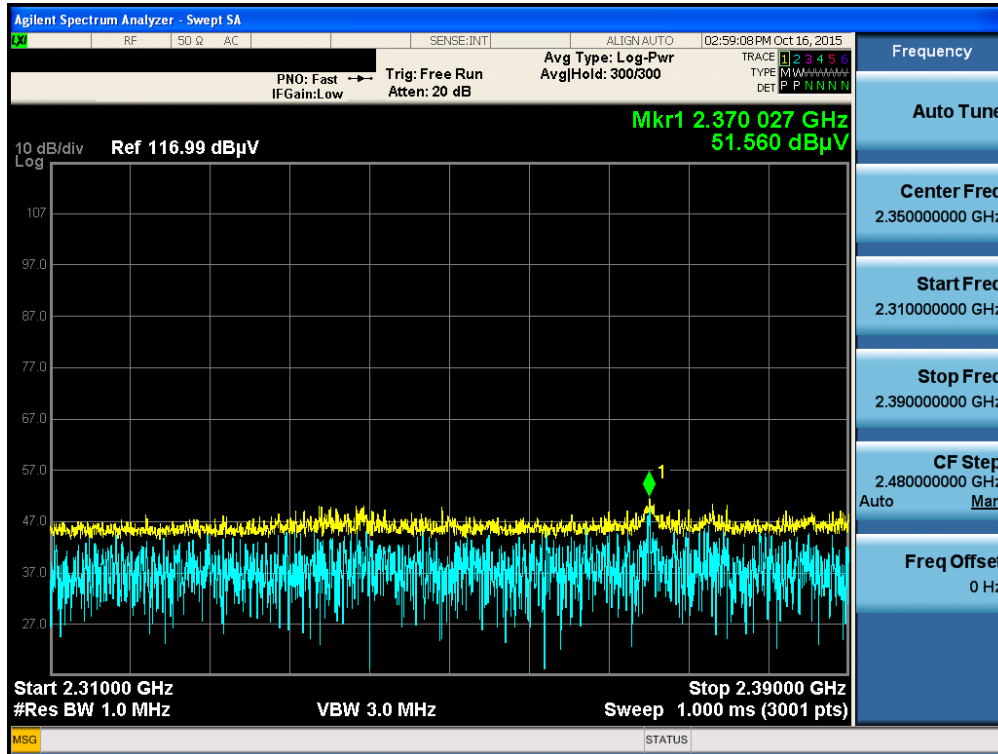

GFSK & Highest & Edge

Detector Mode : PK

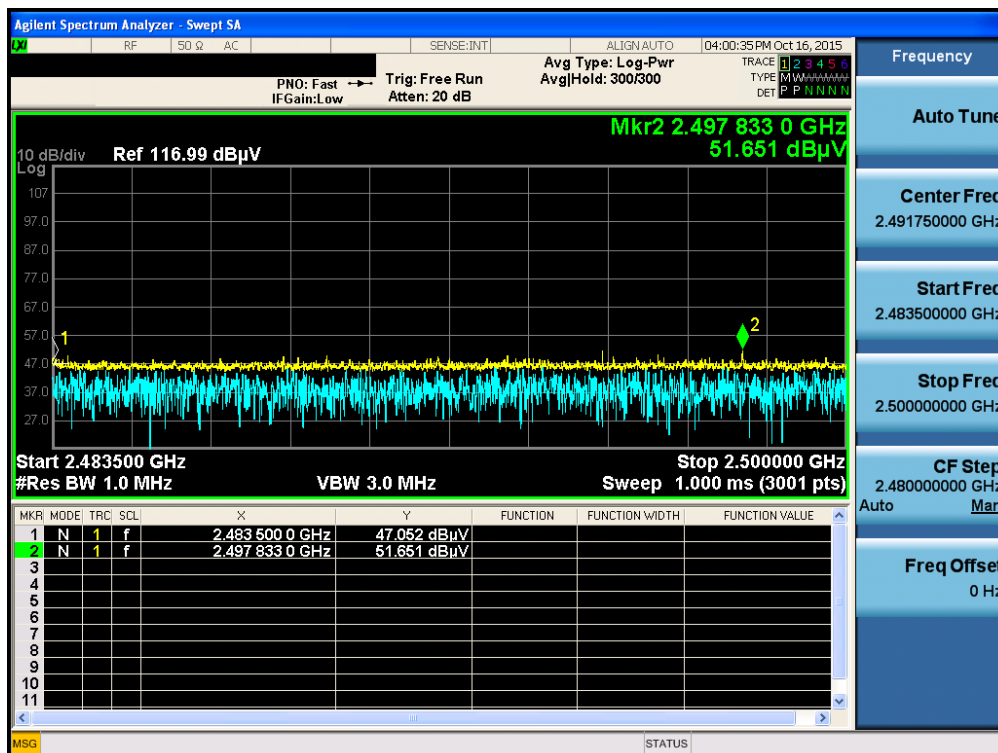

GFSK & Lowest & Harmonic

Detector Mode : PK

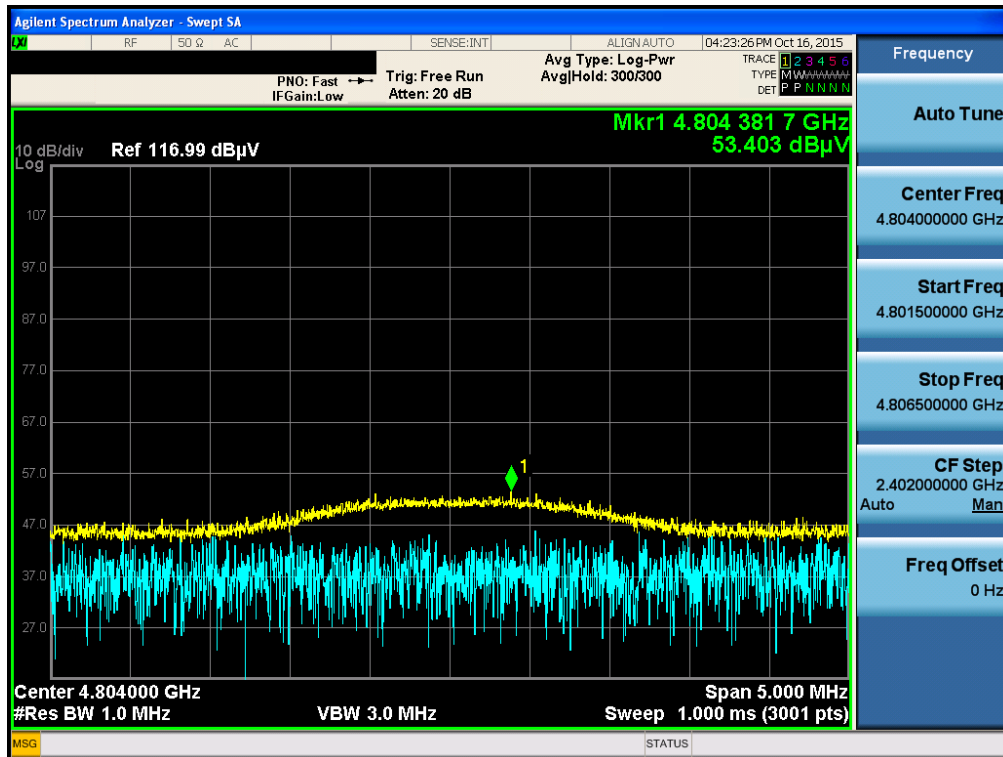

GFSK & Middle & Harmonic

Detector Mode : PK

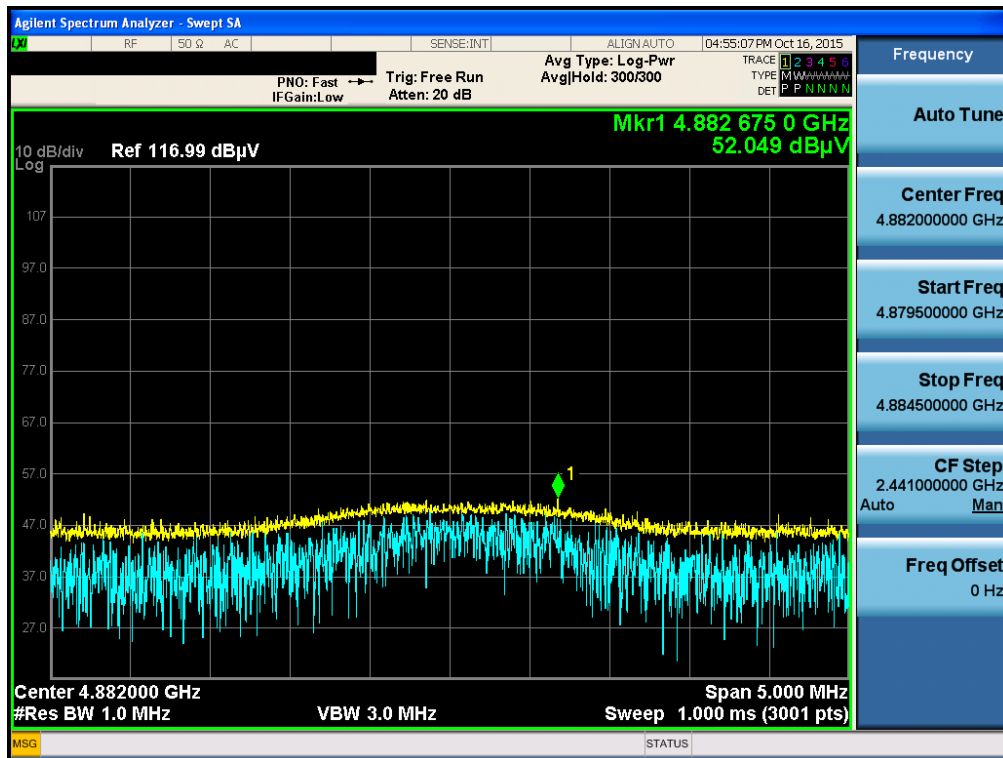



$\pi/4$ -DQPSK & Lowest & Edge

Detector Mode : PK

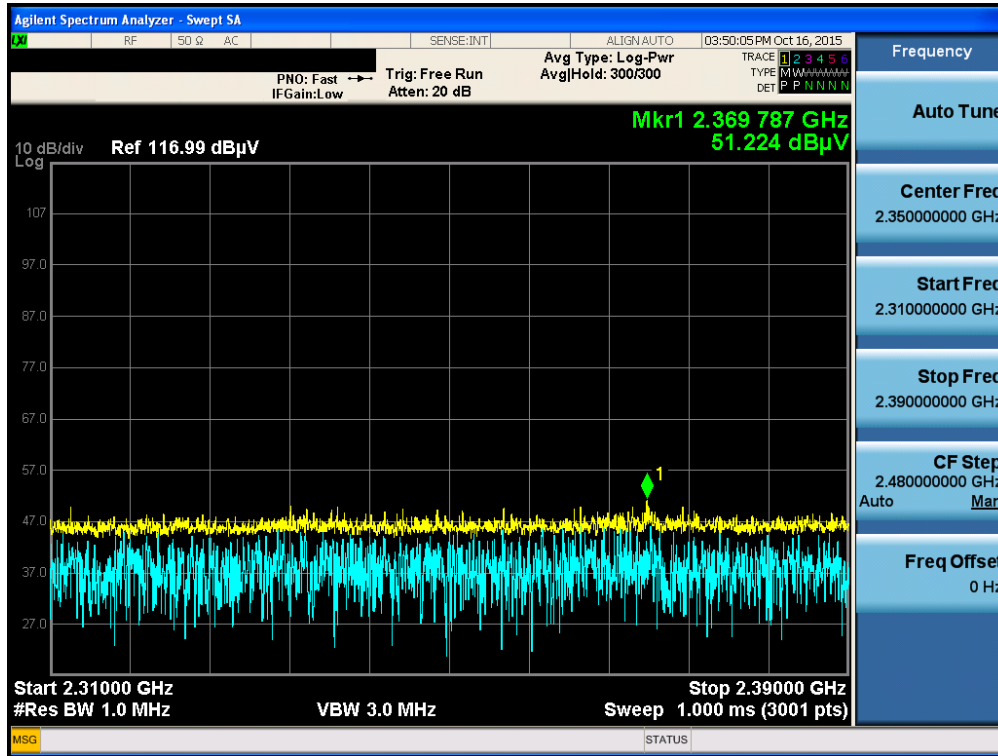

$\pi/4$ -DQPSK & Highest & Edge

Detector Mode : PK

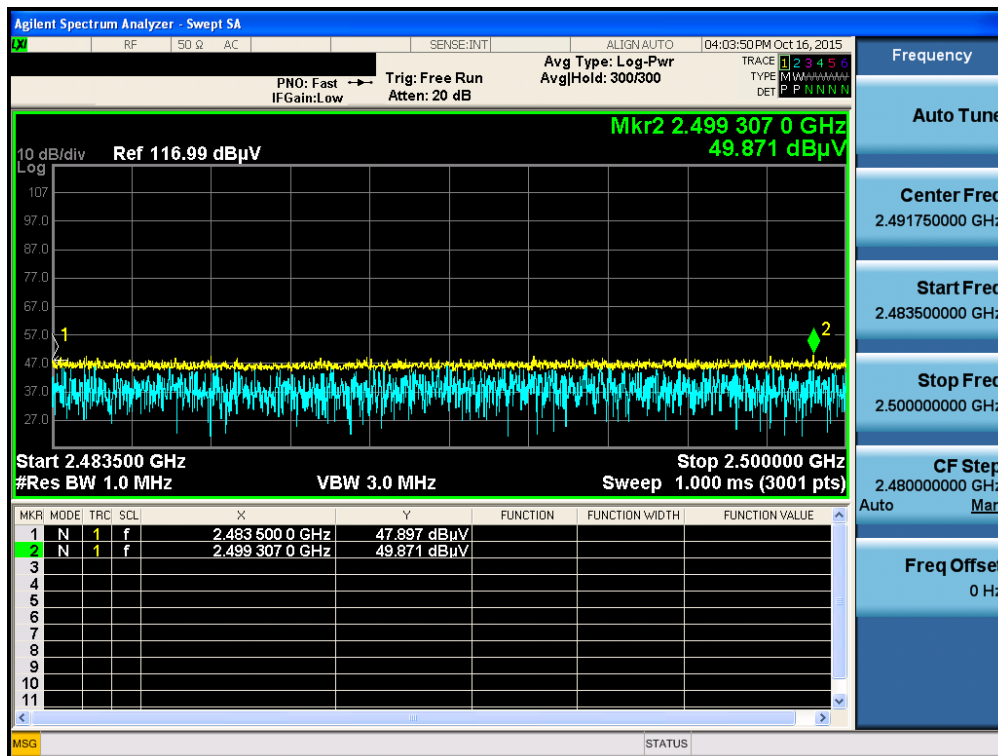

$\pi/4$ -DQPSK & Lowest & Harmonic

Detector Mode : PK

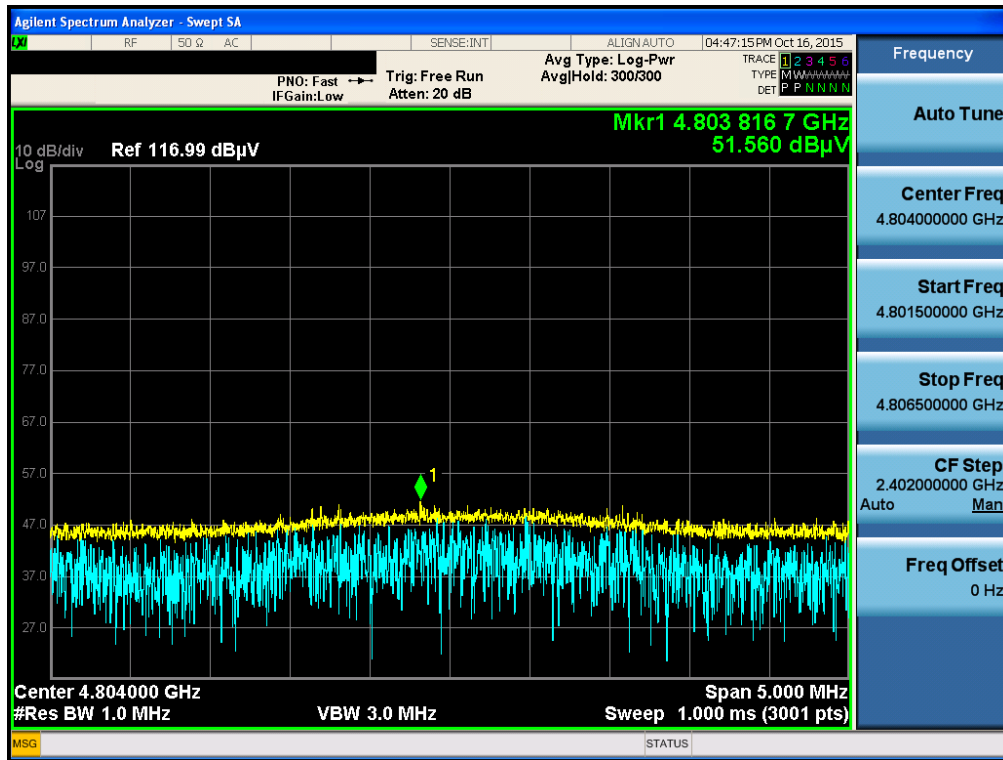

$\pi/4$ -DQPSK & Middle & Harmonic

Detector Mode : PK

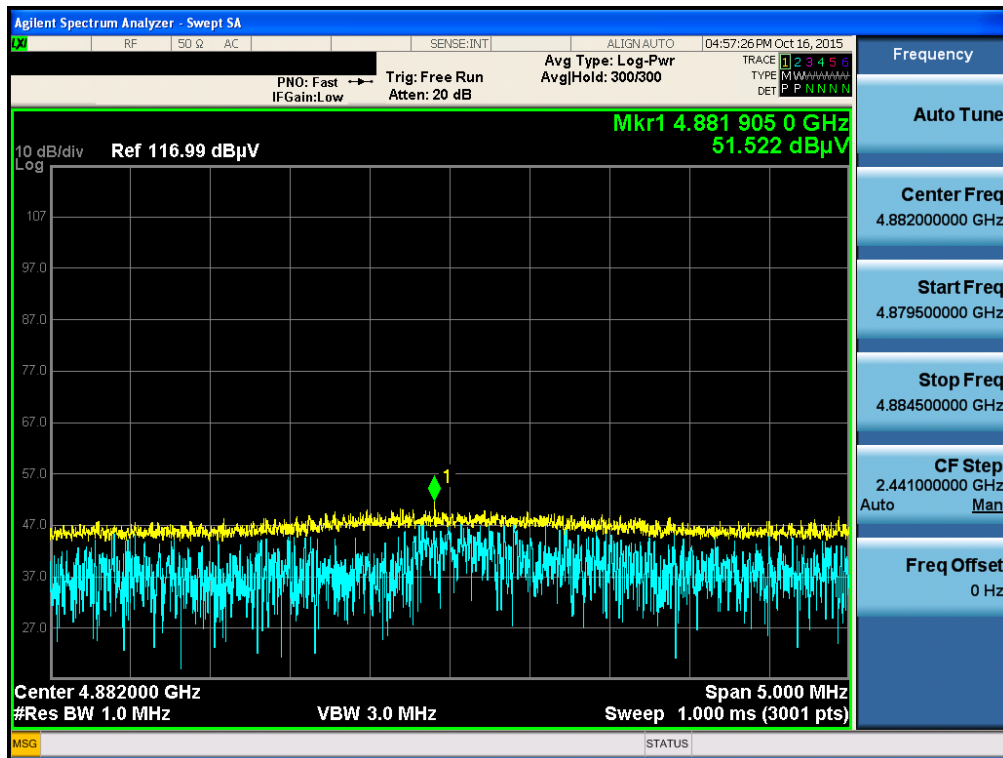

$\pi/4$ -DQPSK & Highest & Harmonic

Detector Mode : PK

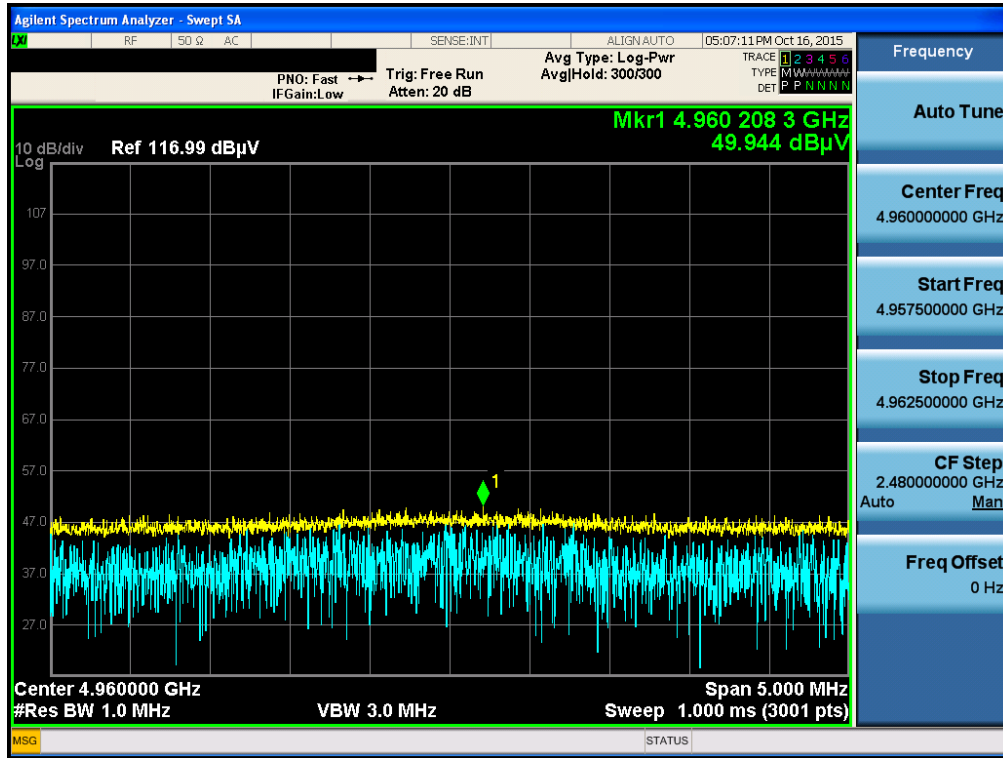

8DPSK & Lowest & Edge

Detector Mode : PK

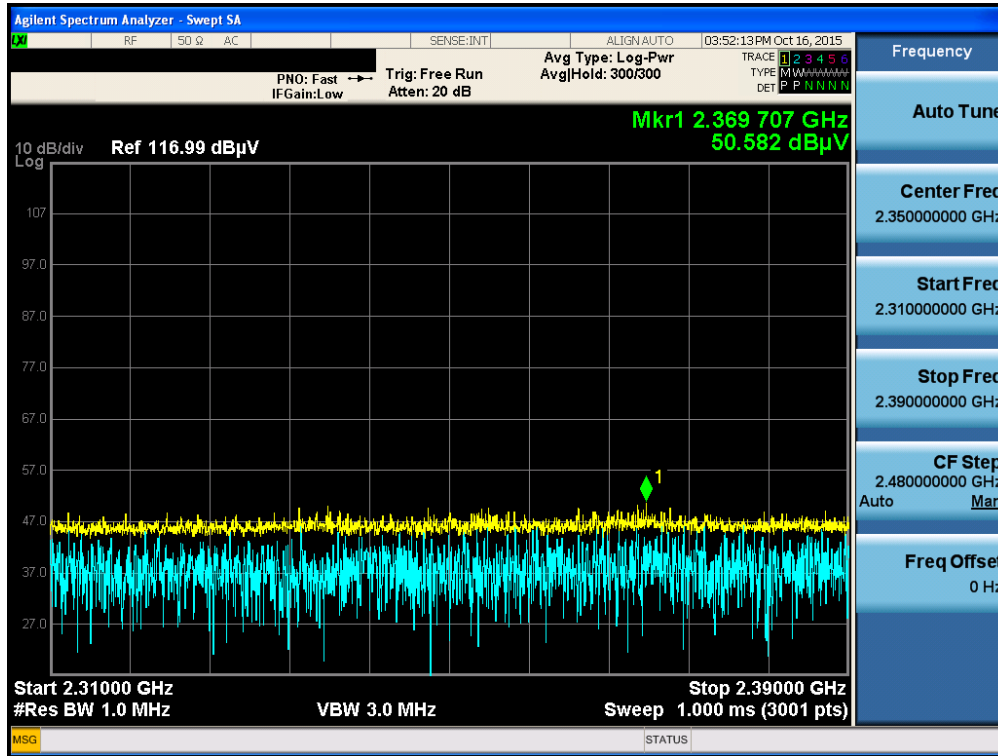

8DPSK & Highest & Edge

Detector Mode : PK

