

# TEST REPORT

<b>KOSTEC CO., Ltd.</b> 28(175-20, Annyeong-dong) 406-gil sejaro, Hwaseong-si, Gyeonggi-do, Korea Tel:031-222-4251, Fax:031-222-4252	Report No.: KST-FCR-180003(2)	 <b>KOSTEC Co., Ltd.</b> http://www.kostec.org
1. Applicant		
• Name : SAM JIN CO., LTD.		
• Address : 81, Anyangcheonseo-ro, Manan-gu Anyang-si, Gyeonggi-do, South Korea		
2. Test Item		
• Product Name: HUB		
• Model Name: STH-ETH-300		
• Brand: None		
• FCC ID: 2AF4S-STH-ETH-300      • IC : 20753-STHETH300		
3. Manufacturer		
• Name : QINGDAO SANJIN ELECTRONIC CO.,LTD.		
• Address : 81, Anyangcheonseo-ro, Manan-gu Anyang-si, Gyeonggi-do, South Korea		
4. Date of Test : 2017. 12. 07. ~ 2017. 12. 08.		
FCC CFR 47, Part 15. Subpart C-15.247		
558074 D01 DTS Meas. Guidance v04		
5. Test Method Used : RSS-GEN Issue 4		
RSS-247 Issue 2		
6. Test Result : Compliance		
7. Note: None		
<b>Supplementary Information</b>		
The device bearing the brand name and FCC ID specified above has been shown to comply with the applicable technical standards as indicated in the measurement report and was tested in accordance with measurement procedures specified in <u>ANSI C 63.10-2013</u> .		
We attest to the accuracy of data and all measurements reported herein were performed by KOSTEC Co., Ltd. and were made under Chief Engineer's supervision. We assume full responsibility for the completeness of these measurements and vouch for the qualifications of all persons taking them.		
The results shown in this test report refer only to the sample(s) tested unless otherwise stated.		
Affirmation	Tested by Name : Jung, Ho-cheol      (Signature)	Technical Manager Name : Park, Gyeong-Hyeon      (Signature)
2018. 04. 18.		
<b>KOSTEC Co., Ltd.</b>		



## Table of Contents

<b>1. GENERAL INFORMATION .....</b>	<b>3</b>
1.1 Test Facility .....	3
1.2 Location .....	3
1.3 Revision History of test report .....	4
<b>2. EQUIPMENT DESCRIPTION .....</b>	<b>5</b>
<b>3. SYSTEM CONFIGURATION FOR TEST .....</b>	<b>6</b>
3.1 Characteristics of equipment .....	6
3.2 Used peripherals list .....	6
3.3 Product Modification .....	6
3.4 Operating Mode .....	6
3.5 Test Setup of EUT .....	6
3.6 Parameters of Test Software Setting .....	7
3.7 Table for Carrier Frequencies .....	7
3.9 Used Test Equipment List .....	8
<b>4. SUMMARY TEST RESULTS .....</b>	<b>10</b>
<b>5. MEASUREMENT RESULTS .....</b>	<b>11</b>
5.1 Max. Conducted output power .....	11
5.2 Power spectral density .....	14
5.3 6 dB spectrum Bandwidth .....	16
5.4 Band-edge Compliance of RF Conducted emissions .....	18
5.5 Spurious RF Radiated emissions .....	20
5.6 Antenna requirement .....	27
5.7 AC Power Conducted emissions .....	28

## 1. GENERAL INFORMATION

### 1.1 Test Facility

#### Test laboratory and address

KOSTEC Co., Ltd.  
128(175-20,Annyeong-dong)406-gil sejaro, Hwaseong-si Gyeonggi-do, Korea

#### Registration information

KOLAS No. : 232  
FCC Designation No. : KR0041  
IC Registration Site No. : 8305A-1

### 1.2 Location

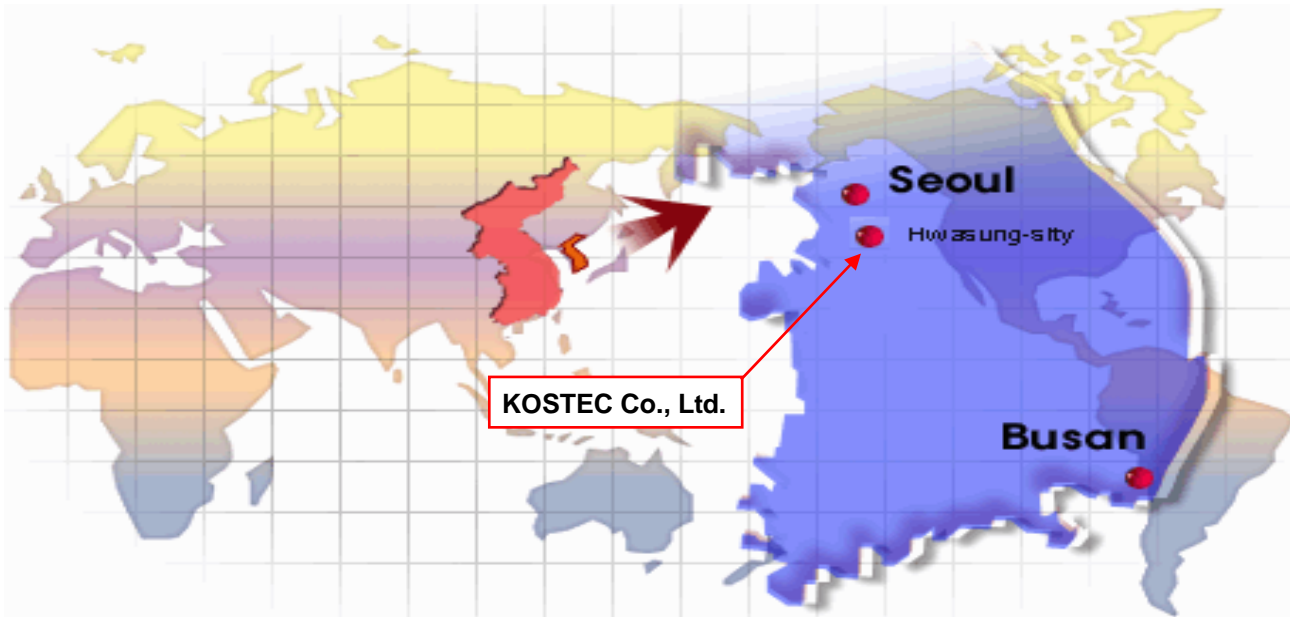



### 1.3 Revision History of test report

Rev.	Revisions	Effect page	Reviewed	Date
-	Initial issue	All	Gyeong Hyeon, Park	2018. 02. 09.
1	Revised address and Product name	1, 5	Gyeong Hyeon, Park	2018. 04. 16.
2	Revised Used Test Equipment List	8~9	Gyeong Hyeon, Park	2018. 04. 18.

## 2. EQUIPMENT DESCRIPTION

The product specification described herein was declared by manufacturer. And refer to user's manual for the details.

Equipment Name	HUB
Model No	STH-ETH-300
Usage	Smart Hub
Serial Number	Proto type
Modulation type	QPSK
Emission Type	G1D
Maximum output power	9.27 dBm
Operated Frequency	2 405 MHz ~ 2 480 MHz
Channel Number	16
Operation temperature	-10 °C ~ 55 °C
Power Source	Adapter DC 5.0 V
Antenna Description	Internal PCB pattern antenna, gain : 2.53 dBi
Remark	<ol style="list-style-type: none"> <li>1. The device was operating at its maximum output power for all measurements.</li> <li>2. The radiation measurements are performed in X, Y, Z axis positioning. Only the worst case (X) is shown in the report.</li> <li>3. The above DUT's information was declared by manufacturer. Please refer to the specifications or user manual for more detailed description.</li> </ol>
FCC ID	2AF4S-STH-ETH-300
IC	20753- STHETH300

### 3. SYSTEM CONFIGURATION FOR TEST

#### 3.1 Characteristics of equipment

The Equipment Under Test (EUT) contains the following capabilities: This equipment is Smart Hub. The detailed explanation is refer as user manual.

#### 3.2 Used peripherals list

Description	Model No.	Serial No.	Manufacture	Remark
Notebook	LG15N54	412NZET043212	LG	
Adapter	PA-1900-14	None	LG	For notebook

#### 3.3 Product Modification

N/A

#### 3.4 Operating Mode

Constantly transmitting with a modulated carrier at maximum power on the low, middle and high channels.

#### 3.5 Test Setup of EUT

The measurements were taken in continuous transmit / receive mode using the TEST MODE.

For controlling the EUT as TEST MODE, the test program and the test cables were provided by the applicant.

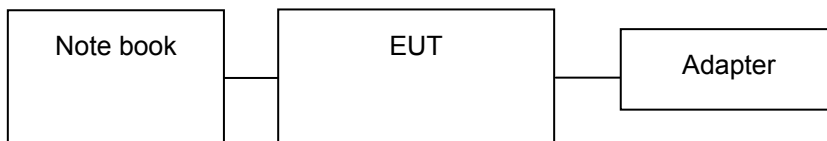

### 3.6 Parameters of Test Software Setting

During testing, Channel & Power Controlling Software provided by the customer was used to control the operating channel as well as the output power level. The RF output power selection is for the setting of RF output power expected by the customer and is going to be fixed on the firmware of the final end product.

■ TX Power setting value during test

Band	Rate	TX Power setting value		
		Low CH	Middle CH	High CH
2.4 GHz band	-	100	100	100

■ Test Program

Tera Term – v4.96

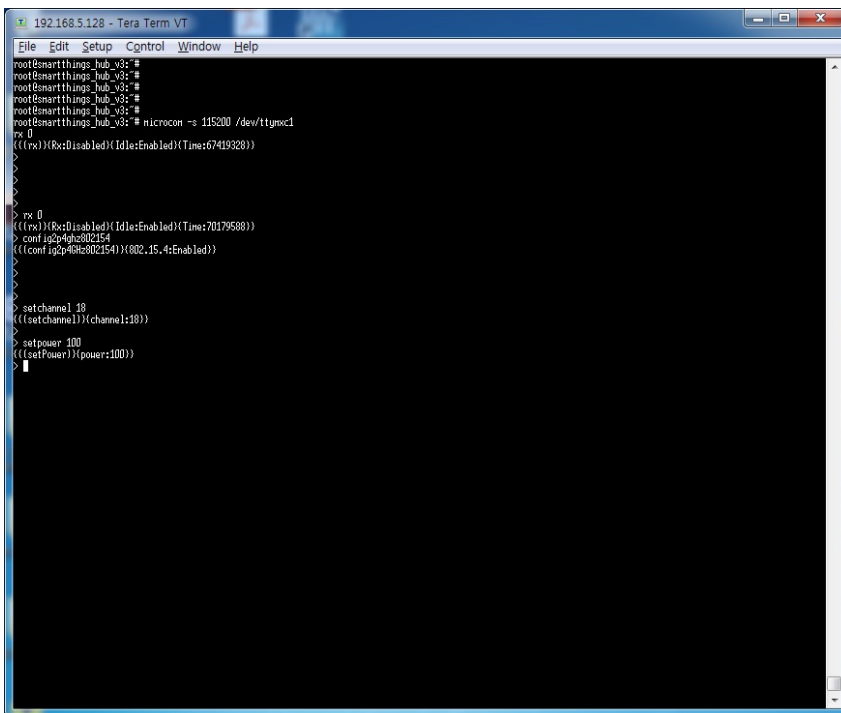

```

192.168.5.128 - Tera Term VT
File Edit Setup Control Window Help
root@smartthings_hub_v3: #
root@smartthings_hub_v3: #
root@smartthings_hub_v3: #
root@smartthings_hub_v3: #
root@smartthings_hub_v3: # microcon -s 115200 /dev/ttyuscl
rx 0
(((rx)|(Rx:Disabled)|(Idle:Enabled)|(Time:6749388))
>
>
> rx 0
(((rx)|(Rx:Disabled)|(Idle:Enabled)|(Time:70179588))
> conf ig0:4ghz:802154
(((conf ig0:4ghz:802154)|(802.15.4:Enabled))
>
>
> setchannel 18
(((setchannel)|(channel:18))
>
> setpower 100
(((setPower)|(power:100))
  
```

### 3.7 Table for Carrier Frequencies

Channel	Frequency (MHz)	Channel	Frequency (MHz)
11	2 405	19	2 445
12	2 410	20	2 450
13	2 415	21	2 455
14	2 420	22	2 460
15	2 425	23	2 465
16	2 430	24	2 470
17	2 435	25	2 475
18	2 440	26	2 480

### 3.9 Used Test Equipment List

No.	Instrument	Model	S/N	Manufacturer	Due to cal date	Cal interval	used
1	T & H Chamber	EY-101	90E14260	TABAI ESPEC	2018.09.06	1 year	<input checked="" type="checkbox"/>
2	T & H Chamber	SH-641	92006831	ESPEC CORP	2018.05.31	1 year	<input type="checkbox"/>
3	Spectrum Analyzer	8563E	3846A10662	Agilent Technology	2018.02.02	1 year	<input type="checkbox"/>
4	Spectrum Analyzer	8593E	3710A02859	Agilent Technology	2018.02.02	1 year	<input type="checkbox"/>
5	Spectrum Analyzer	FSV30	20-353063	Rohde& Schwarz	2018.02.01	1 year	<input checked="" type="checkbox"/>
6	Signal Analyzer	N9010A	MY56070441	Agilent Technologies	2018.05.15	1 year	<input type="checkbox"/>
7	EMI Test Receiver	ESCI7	100823	Rohde& Schwarz	2018.01.31	1 year	<input type="checkbox"/>
8	EMI Test Receiver	ESI	837514/004	Rohde& Schwarz	2017.09.07	1 year	<input type="checkbox"/>
9	Vector Signal Analyzer	89441A	3416A02620	Agilent Technology	2018.02.03	1 year	<input type="checkbox"/>
10	Network Analyzer	8753ES	US39172348	AGILENT	2017.09.06	1 year	<input type="checkbox"/>
11	EPM Series Power meter	E4418B	GB39512547	Agilent Technology	2018.02.01	1 year	<input type="checkbox"/>
12	RF Power Sensor	E9300A	MY41496631	Agilent Technology	2018.02.01	1 year	<input type="checkbox"/>
13	Microwave Frequency Counter	5352B	2908A00480	Agilent Technology	2018.02.01	1 year	<input type="checkbox"/>
14	Modulation Analyzer	8901A	3538A07071	Agilent Technology	2018.02.02	1 year	<input type="checkbox"/>
15	Audio Analyzer	8903B	3514A16919	Agilent Technology	2018.01.31	1 year	<input type="checkbox"/>
16	Audio Telephone Analyzer	DD-5601CID	520010281	CREDIX	2018.02.02	1 year	<input type="checkbox"/>
17	Digital storage Oscilloscope	TDS3052	B015962	Tektronix	2017.09.06	1 year	<input type="checkbox"/>
18	ESG-D Series Signal Generator	E4436B	US39260458	Agilent Technology	2018.02.02	1 year	<input type="checkbox"/>
19	Vector Signal Generator	SMBV100A	257557	Rohde & Schwarz	2018.02.02	1 year	<input checked="" type="checkbox"/>
20	Signal Generator	SMB100A	179628	Rohde & Schwarz	2018.05.18	1 year	<input checked="" type="checkbox"/>
21	Tracking Source	85645A	070521-A1	Agilent Technology	2018.02.03	1 year	<input type="checkbox"/>
22	SLIDAC	None	0207-4	Myoung sung Ele.	2018.01.31	1 year	<input type="checkbox"/>
23	DC Power supply	DRP-5030	9028029	Digital Electronic Co.,Ltd	2018.02.01	1 year	<input type="checkbox"/>
24	DC Power supply	6038A	3440A12674	Agilent Technology	2018.01.31	1 year	<input type="checkbox"/>
25	DC Power supply	E3610A	KR24104505	Agilent Technology	2018.01.31	1 year	<input checked="" type="checkbox"/>
26	DC Power supply	UP-3005T	68	Unicon Co.,Ltd	2018.01.31	1 year	<input type="checkbox"/>
27	DC Power Supply	SM 3004-D	114701000117	DELTAELEKTRONIKA	2018.01.31	1 year	<input type="checkbox"/>
28	Dummy Load	8173	3780	Bird Electronic Co., Corp	2018.02.03	1 year	<input type="checkbox"/>
29	Attenuator	50FH-030-500	140410 9433	JEW Industries Inc.	2018.02.02	1 year	<input type="checkbox"/>
30	Attenuator	24-30-34	BX5630	Aeroflex / Weinschel	2017.12.27	1 year	<input type="checkbox"/>
31	Attenuator	8498A	3318A09485	HP	2018.02.01	1 year	<input type="checkbox"/>
32	Step Attenuator	8494B	3308A32809	HP	2018.02.02	1 year	<input type="checkbox"/>
33	Attenuator	18B50W-20F	64671	INMET	2018.02.02	1 year	<input type="checkbox"/>
34	Attenuator	10 dB	1	Rohde & Schwarz	2018.05.18	1 year	<input checked="" type="checkbox"/>
35	Attenuator	10 dB	2	Rohde & Schwarz	2018.05.18	1 year	<input type="checkbox"/>
36	Attenuator	10 dB	3	Rohde & Schwarz	2018.05.18	1 year	<input type="checkbox"/>
37	Attenuator	10 dB	4	Rohde & Schwarz	2018.05.18	1 year	<input type="checkbox"/>
38	Attenuator	54A-10	74564	WEINSCHHEL	2018.05.18	1 year	<input type="checkbox"/>
39	Attenuator	56-10	66920	WEINSCHHEL	2018.05.18	1 year	<input type="checkbox"/>
40	Power divider	11636B	51212	HP	2018.02.01	1 year	<input type="checkbox"/>
41	3Way Power divider	KPDSU3W	00070365	KMW	2017.09.06	1 year	<input type="checkbox"/>
42	4Way Power divider	70052651	173834	KRYTAR	2018.02.01	1 year	<input type="checkbox"/>
43	3Way Power divider	1580	SQ361	WEINSCHHEL	2018.05.18	1 year	<input type="checkbox"/>
44	OSP	OSP120	101577	Rohde & Schwarz	2018.05.19	1 year	<input type="checkbox"/>
45	White noise audio filter	ST31EQ	101902	SoundTech	2017.09.07	1 year	<input type="checkbox"/>
46	Dual directional coupler	778D	17693	HEWLETT PACKARD	2018.02.02	1 year	<input type="checkbox"/>
47	Dual directional coupler	772D	2839A00924	HEWLETT PACKARD	2018.02.02	1 year	<input type="checkbox"/>
48	Band rejection filter	3TNF-0006	26	DOVER Tech	2018.02.03	1 year	<input type="checkbox"/>
49	Band rejection filter	3TNF-0008	317	DOVER Tech	2018.02.03	1 year	<input type="checkbox"/>
50	Band rejection filter	3TNF-0007	311	DOVER Tech	2018.02.03	1 year	<input type="checkbox"/>



No.	Instrument	Model	S/N	Manufacturer	Due to cal date	Cal interval	used
51	Band rejection filter	WTR-BRF2442-84NN	09020001	WAVE TECH Co.,LTD	2018.02.02	1 year	<input type="checkbox"/>
52	Band rejection filter	WRCJV12-5695-5725-5825-5855-50SS	1	Wainwright Instruments GmbH	2018.05.18	1 year	<input type="checkbox"/>
53	Band rejection filter	WRCJV12-5120-5150-5350-5380-40SS	4	Wainwright Instruments GmbH	2018.05.18	1 year	<input type="checkbox"/>
54	Band rejection filter	WRCGV10-2360-2400-2500-2540-50SS	2	Wainwright Instruments GmbH	2018.05.18	1 year	<input checked="" type="checkbox"/>
55	Highpass Filter	WHJS1100-10EF	1	WAINWRIGHT	2018.02.02	1 year	<input type="checkbox"/>
56	Highpass Filter	WHJS3000-10EF	1	WAINWRIGHT	2018.02.02	1 year	<input type="checkbox"/>
57	Highpass Filter	WHNX6-5530-3000-26500-40CC	2	Wainwright Instruments GmbH	2018.05.19	1 year	<input type="checkbox"/>
58	Highpass Filter	WHNX6-2370-7000-26500-40CC	4	Wainwright Instruments GmbH	2018.05.19	1 year	<input checked="" type="checkbox"/>
59	WideBand Radio Communication Tester	CMW500	102276	Rohde & Schwarz	2018.02.03	1 year	<input type="checkbox"/>
60	Radio Communication Tester	CMU 200	112026	Rohde & Schwarz	2018.02.03	1 year	<input type="checkbox"/>
61	Bluetooth Tester	TC-3000B	3000B6A0166	TESCOM CO., LTD.	2018.02.03	1 year	<input type="checkbox"/>
62	Loop Antenna	6502	9203-0493	EMCO	2019.05.29	2 year	<input checked="" type="checkbox"/>
63	BiconiLog Antenna	3142B	9910-1432	EMCO	2018.04.25	2 year	<input checked="" type="checkbox"/>
64	Trilog-Broadband Antenna	VULB 9168	9168-606	SCHWARZBECK	2018.09.09	2 year	<input type="checkbox"/>
65	Horn Antenna	3115	2996	EMCO	2018.02.11	2 year	<input checked="" type="checkbox"/>
66	Horn Antenna	BBHA9170	BBHA9170152	SCHWARZBECK	2019.04.25	2 year	<input checked="" type="checkbox"/>
67	Antenna Master(3)	AT13	None	AUDIX	N/A	N/A	<input type="checkbox"/>
68	Turn Table(3)	None	None	AUDIX	N/A	N/A	<input type="checkbox"/>
69	PREAMPLIFIER(3)	8449B	3008A02577	Agilent	2018.02.01	1 year	<input type="checkbox"/>
70	Antenna Master(10)	MA4000-EP	None	inno systems GmbH	N/A	N/A	<input checked="" type="checkbox"/>
71	Turn Table(10)	None	None	inno systems GmbH	N/A	N/A	<input checked="" type="checkbox"/>
72	AMPLIFIER(10)	TK-PA6S	120009	TESTEK	2018.01.31	1 year	<input checked="" type="checkbox"/>
73	AMPLIFIER	8447D	2944A07881	H.P	2018.01.31	1 year	<input type="checkbox"/>
74	Antenna Mast	MA2000-EP	None	inno systems GmbH	N/A	N/A	<input type="checkbox"/>
75	Turn Device	DE3700-RH	None	inno systems GmbH	N/A	N/A	<input type="checkbox"/>

## 4. SUMMARY TEST RESULTS

Description of Test	FCC Rule	IC Rule	Reference Clause	Used	Test Result
Max. Conducted output power	15.247(b)	RSS-247, 5.4(d)	Clause 5.1	<input checked="" type="checkbox"/>	Compliance
Power spectral density	15.247(e)	RSS-247, 5.2(b)	Clause 5.2	<input checked="" type="checkbox"/>	Compliance
6 dB spectrum Bandwidth	15.247(a)(2)	RSS-247, 5.2(a)	Clause 5.3	<input checked="" type="checkbox"/>	Compliance
Band edge of RF conducted emissions	15.247(d)	RSS-247, 5.5	Clause 5.4	<input checked="" type="checkbox"/>	Compliance
Spurious RF radiated emissions	15.247(d), 15.209(a)	RSS-247, 5.5	Clause 5.5	<input checked="" type="checkbox"/>	Compliance
Antenna requirement	15.203, 15.247(b)	-	Clause 5.6	<input checked="" type="checkbox"/>	Compliance
AC Power Conducted emissions	15.207	RSS-GEN, 8.8	Clause 5.7	<input checked="" type="checkbox"/>	Compliance
Compliance/pass : The EUT complies with the essential requirements in the standard. Not Compliance : The EUT does not comply with the essential requirements in the standard. N/A : The test was not applicable in the standard.					

### Procedure Reference

FCC CFR 47, Part 15. Subpart C-15.247  
 558074 D01 DTS Meas. Guidance v04  
 RSS-GEN Issue 4  
 RSS-247 Issue 2  
 ANSI C 63.10-2013

## 5. MEASUREMENT RESULTS

### 5.1 Max. Conducted output power

#### 5.1.1 Standard Applicable [FCC §15.247(b)(3) and RSS-247 5.4 (d)]

##### FCC

For systems using digital modulation in the 902 ~ 928 MHz, 2 400 ~ 2 483.5 MHz, and 5 725 ~ 5 850 MHz bands: 1 Watt. As an alternative to a peak power measurement, compliance with the one Watt limit can be based on a measurement of the maximum conducted output power.

##### IC

For DTS employing digital modulation techniques operating in the bands 902 – 928 MHz and 2400 – 2483.5 MHz, the maximum peak conducted output power shall not exceed 1 W. Except as provided in Section 5.4(5), the e.i.r.p. shall not exceed 4 W. Fixed point-to-point systems in the bands 2400-2483.5 MHz and 5725-5850 MHz are permitted to have an e.i.r.p. higher than 4 W provided that the higher e.i.r.p. is achieved by employing higher gain directional antennas and not higher transmitter output powers. Point-to-multipoint systems, omnidirectional applications and multiple co-located transmitters transmitting the same information are prohibited from exceeding an e.i.r.p. of 4 W.

#### 5.1.2 Test Environment conditions

- Ambient temperature : (24 ~ 25) °C • Relative Humidity : (49 ~ 55) % R.H.

#### 5.1.3 Measurement Procedure

The transmitter output was connected to the spectrum analyzer with an attenuator. The maximum peak output power was measured and recorded with the spectrum analyzer. EUT was programmed to be in continuously transmitting mode.

All conducted power tests were performed using a test receiver in accordance with FCC KDB 558074 v04 Section 9.1.1 Measurement Procedure RBW  $\geq$  DTS bandwidth and 9.2.2.4.

The spectrum analyzer is set to the as follows :

##### Peak Power

- Set RBW  $\geq$  DTS bandwidth
- Set the VBW  $\geq 3 \times$  RBW.
- Set the span  $3 \times$  RBW.
- Sweep time = auto couple.
- Detector = peak.
- Trace mode = max hold.
- Allow trace to fully stabilize.
- Use the peak marker function to determine the maximum amplitude level.

#### 5.1.4 Test setup

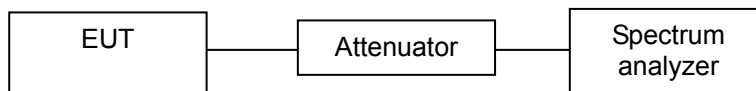



### 5.1.5 Measurement Result

Channel	Frequency [MHz]	Conducted Power	Limit [dBm]	Test Results
		[dBm]		
11	2 405	9.27	30	Compliance
18	2 440	8.51	30	Compliance
26	2 480	9.07	30	Compliance

### 5.1.6 Test Plot

#### CH Low

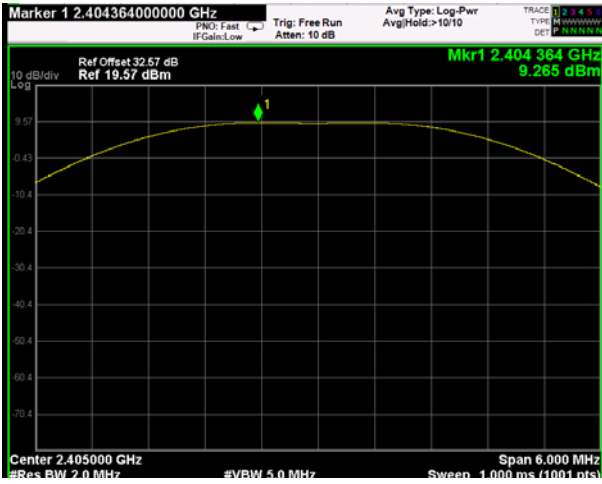

#### CH Middle

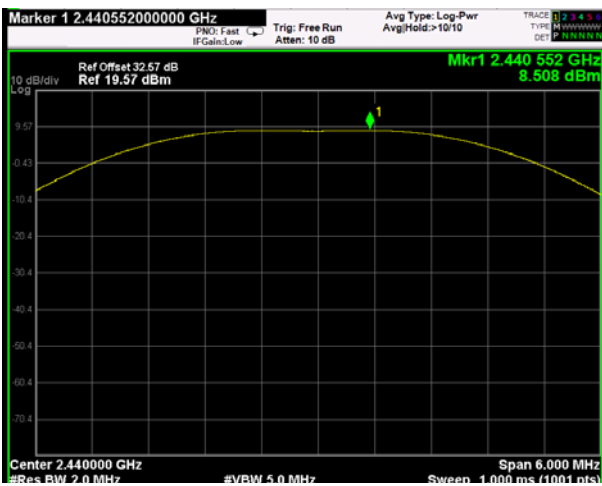

#### CH High

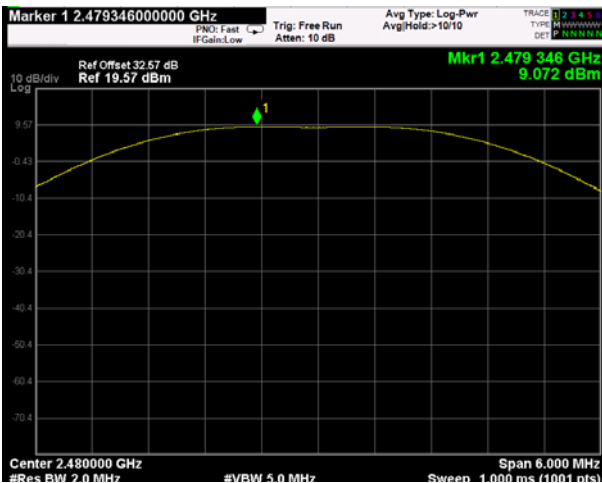

## 5.2 Power spectral density

### 5.2.1 Standard Applicable [FCC §15.247(e) and RSS-247 5.2(b)]

#### FCC

For digitally modulated systems, the power spectral density conducted from the intentional radiator to the antenna shall not be greater than 8 dBm in any 3 kHz band during any time interval of continuous transmit

#### IC

The transmitter power spectral density conducted from the transmitter to the antenna shall not be greater than 8 dBm in any 3 kHz band during any time interval of continuous transmission. This power spectral density shall be determined in accordance with the provisions of Section 5.4(4), (i.e. the power spectral density shall be determined using the same method as is used to determine the conducted output power).

### 5.2.2 Test Environment conditions

- Ambient temperature : (24 ~ 25) °C
- Relative Humidity : (49 ~ 55) % R.H.

### 5.2.3 Measurement Procedure

The power spectral density conducted from the intentional radiator was measured with a spectrum analyzer connected to the antenna terminal, while EUT had the highest, middle and the lowest available channels. After the trace being stable, Use the marker-to-peak function to set the marker to the peak of the emission. The indicated level is the peak power spectral density.

All conducted power tests were performed using a test receiver in accordance with FCC KDB 558074 v04 Section 10.1

The spectrum analyzer is set to the as follows :

- Set analyzer center frequency to DTS channel center frequency.
- Set the span to 1.5 times the DTS bandwidth.
- Set the RBW to:  $3 \text{ kHz} \leq \text{RBW} \leq 100 \text{ kHz}$ .
- Set the VBW  $\geq 3 \times \text{RBW}$ .
- Detector = peak.
- Sweep time = auto couple.
- Trace mode = max hold.
- Allow trace to fully stabilize.
- Use the peak marker function to determine the maximum amplitude level within the RBW.
- If measured value exceeds limit, reduce RBW (no less than 3 kHz) and repeat.

### 5.2.4 Test setup

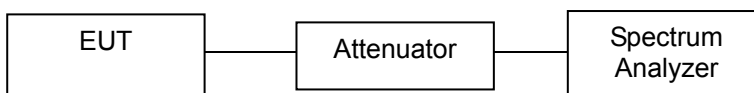

### 5.2.5 Measurement Result

Channel	Frequency [MHz]	Result Value [dBm/3kHz]	Limit [dBm/3kHz]	Test Results
11	2 405	-6.53	8	Compliance
18	2 440	-6.54	8	Compliance
26	2 480	-6.19	8	Compliance

## 5.2.6 Test Plot

### CH Low

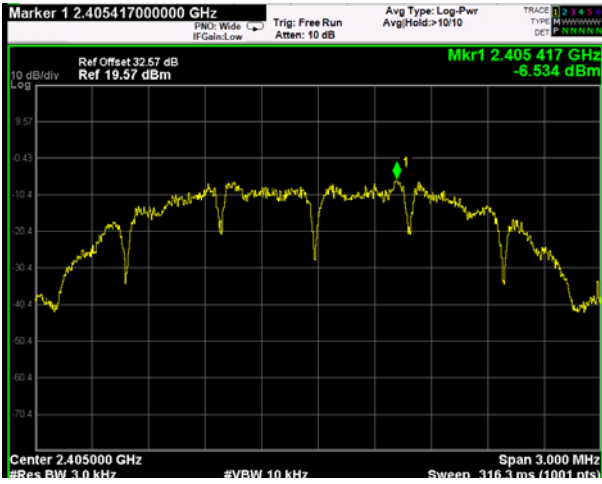

### CH Middle

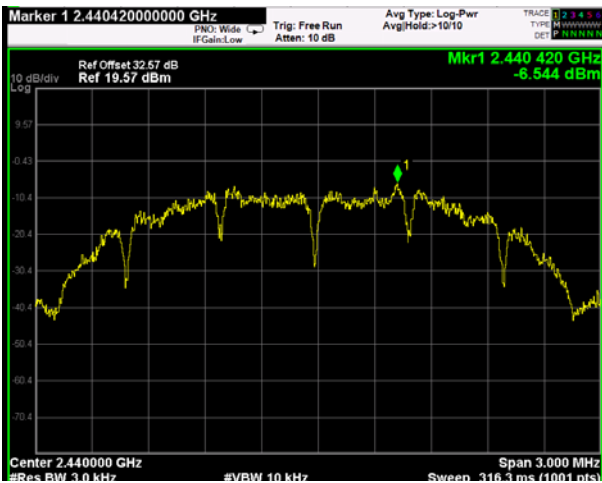

### CH High

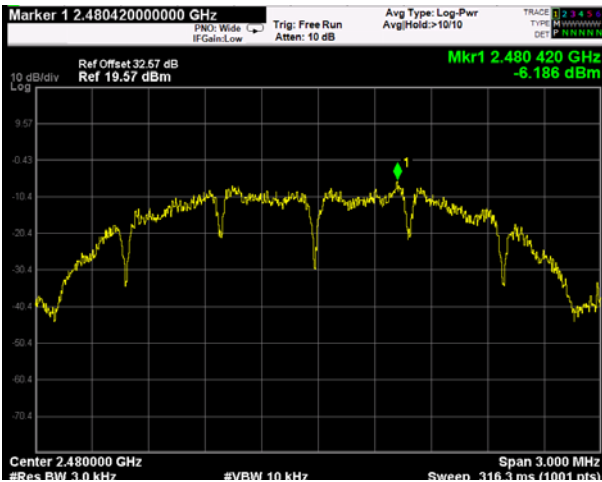

## 5.3 6 dB spectrum Bandwidth

### 5.3.1 Standard Applicable [FCC §15.247(a)(2) and RSS-247 5.2(a)]

#### FCC and IC

Systems using digital modulation techniques may operate in the 902 ~ 928 MHz, 2400 ~ 2483.5 MHz, and 5725 ~ 5850 MHz bands. The minimum 6 dB bandwidth shall be at least 500 kHz.

### 5.3.2 Test Environment conditions

- Ambient temperature : (24 ~ 25) °C
- Relative Humidity : (49 ~ 55) % R.H.

### 5.3.3 Measurement Procedure

1. The transmitter output (antenna port) was connected to the spectrum analyzer in peak hold mode.
2. The resolution bandwidth of 100 kHz and the video bandwidth of 100 kHz were used.
3. Measured the spectrum width with power higher than 6 dB below carrier.

The spectrum analyzer is set to the as follows :

- Set RBW = 100 kHz.
- Set the video bandwidth (VBW)  $\geq 3 \times$  RBW.
- Detector = Peak.
- Trace mode = max hold.
- Sweep = auto couple.
- Allow the trace to stabilize.
- Measure the maximum width of the emission that is constrained by the frequencies associated with the two outermost amplitude points (upper and lower frequencies) that are attenuated by 6 dB relative to the maximum level measured in the fundamental emission.

### 5.3.4 Test setup

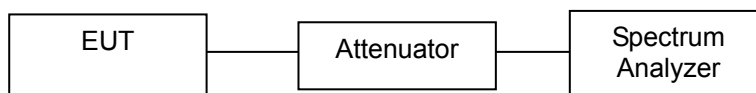

### 5.3.5 Measurement Result

Channel	Frequency [MHz]	6 dB Bandwidth [MHz]	99 % Bandwidth [MHz]	Limit [MHz]	Test Results
11	2 405	1.65	2.28	>0.5	Compliance
18	2 440	1.65	2.28	>0.5	Compliance
26	2 480	1.65	2.28	>0.5	Compliance



### 5.3.6 Test Plot

#### CH Low

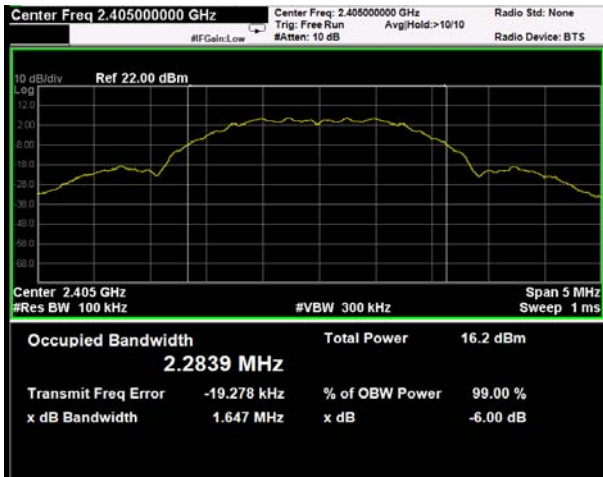

#### CH Middle



#### CH High

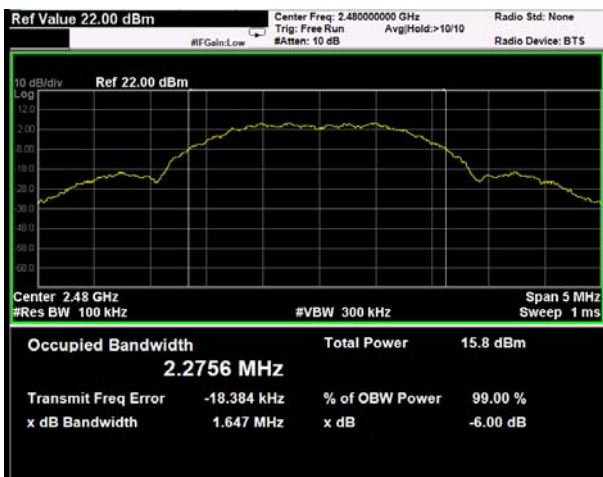

## 5.4 Band-edge Compliance of RF Conducted emissions

### 5.4.1 Standard Applicable [ FCC §15.247(d) and RSS-247 5.5 ]

#### FCC and IC

In any 100 kHz bandwidth outside the frequency band in which the spread spectrum or digitally modulated intentional radiator is operating, the radio frequency power that is produced by the intentional radiator shall be at least 20 dB below that in the 100 kHz bandwidth within the band that contains the highest level of the desired power, based on RF conducted.

### 5.4.2 Test Environment conditions

- Ambient temperature : (24 ~ 25) °C
- Relative Humidity : (49 ~ 55) % R.H.

### 5.4.3 Measurement Procedure

- (1) Pre-calibration for the spectrum analyzer has to be done first through a reference CW signal from signal generator.
- (2) Reference frequency generated from the signal generator is supply to spectrum analyzer input port via RF cable and attenuator, and then, it's applied to offset value on spectrum analyzer.
- (3) Remove the antenna from the EUT and then, connected to spectrum analyzer via a dc Block, suitable low loss RF cable and attenuator.
- (4) Place the EUT on the table and set on the emission at the band-edge,
- (5) After the trace being stable, Use the marker-to-peak function to move the marker to the peak of the in-band emission.
- (6) The marker-delta value now displayed must comply with the limit specified in above standard.
- (7) please refer to the detailed procedure method KDB 558074 v04.

The spectrum analyzer is set to the as follows :

- Span : Wide enough to capture the peak level of the emission operating on the channel closet to the Band-edge, as well as any modulation products which fall outside of the authorized band of operation
- RBW : 100 kHz ( $\geq 1\%$  of the span)
- VBW :  $\geq$  RBW
- Sweep : auto
- Detector function : peak
- Trace : Max hold

### 5.4.4 Test setup

Please refer 5.3.4

### 5.4.5 Measurement Result

Setting Channel		Test Results		
		Measured value [dB]	Limit [dB]	Result
CH 11	~ 2 400 MHz	-50.58	≤ 20 than PSD level	Compliance
CH 26	2 483.5 MHz ~	-44.01		Compliance

5.4.6 Test Plot (Band-edge)

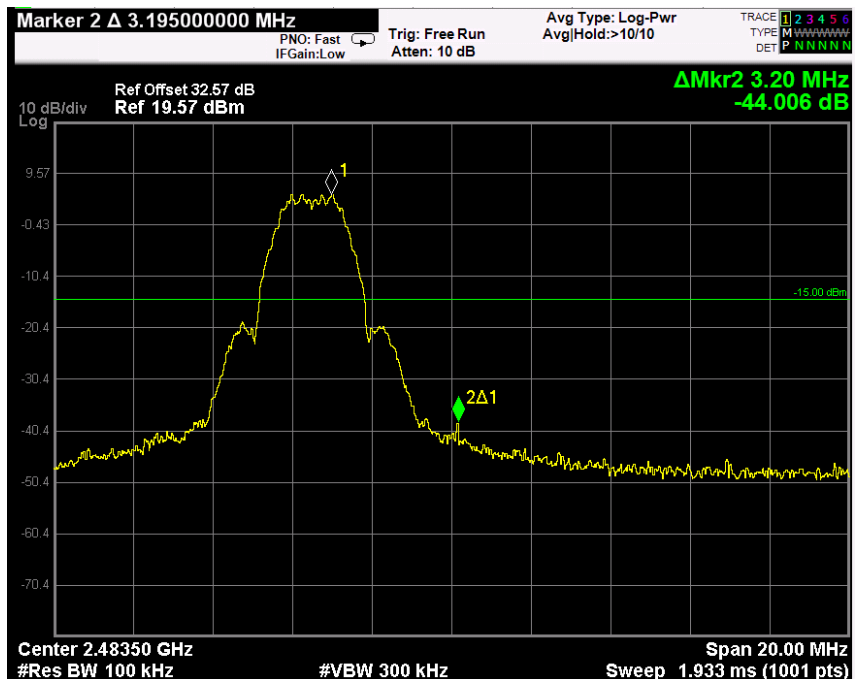
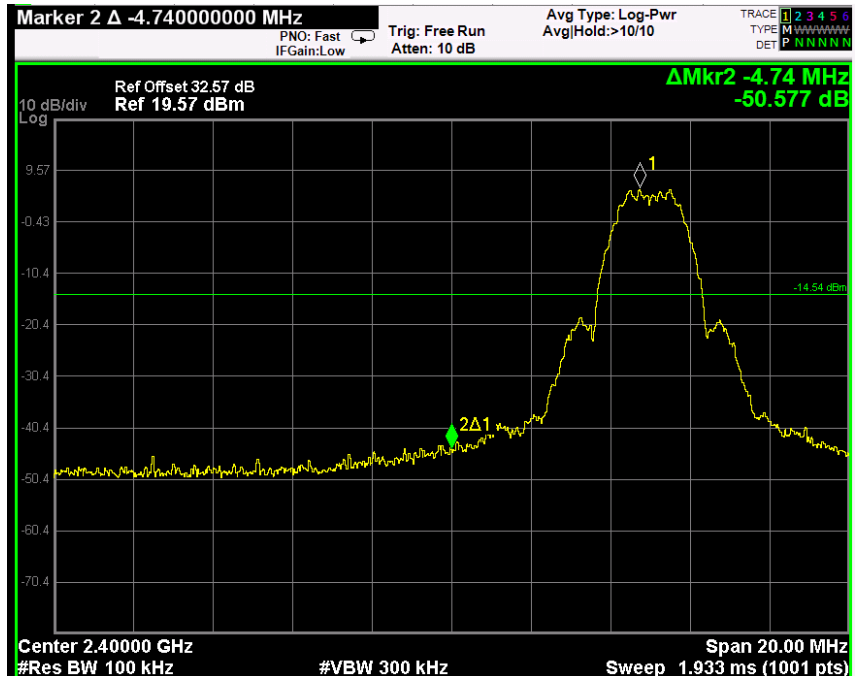

## 5.5 Spurious RF Radiated emissions

### 5.5.1 Standard Applicable [ FCC §15.247(d) and RSS-247 5.5 ]

#### FCC

All other emissions outside these bands shall not exceed the general radiated emission limits specified in §15.209(a). And according to §15.33(a)(1), for an intentional radiator operates below 10 GHz, the frequency Range of measurements: to the tenth harmonic of the highest fundamental frequency or to 40 GHz, Whichever is lower. In addition, radiated emissions which fall in the restricted bands, as defined in Sec.15.205(a), must also comply with the radiated emission limits specified in Sec. 15.209(a)

#### IC

In any 100 kHz bandwidth outside the frequency band in which the spread spectrum or digitally modulated device is operating, the RF power that is produced shall be at least 20 dB below that in the 100 kHz bandwidth within the band that contains the highest level of the desired power, based on either an RF conducted or a radiated measurement, provided that the transmitter demonstrates compliance with the peak conducted power limits. If the transmitter complies with the conducted power limits based on the use of root-mean-square averaging over a time interval, as permitted under Section 5.4(4), the attenuation required shall be 30 dB instead of 20 dB. Attenuation below the general field strength limits specified in RSS-Gen is not required.

#### §15.209 and RSS-Gen limits for radiated emissions measurements (distance at 3 m)

Frequency Band [MHz]	DISTANCE [Meters]	Limit [ $\mu\text{V}/\text{m}$ ]	Limit [ $\text{dB } \mu\text{V}/\text{m}$ ]	Detector
0.009 ~ 0.490	300	2400/F(kHz)	67.6-20log(F)	Peak
0.490 ~ 1.705	30	24000/F(kHz)	87.6-20log(F)	Peak
1.705 ~ 30.0	30	30	29.54	Peak
30 - 88	3	100 **	40.00	Quasi peak
88 - 216	3	150 **	43.52	Quasi peak
216 - 960	3	200 **	46.02	Quasi peak
Above 960	3	500	54.00	Average
Above 1000	3	74.0 dB $\mu\text{V}/\text{m}$ (Peak), 54.0 dB $\mu\text{V}/\text{m}$ (Average)		

\*\* fundamental emissions from intentional radiators operation under this Section shall not be located in the frequency bands 54-72 MHz, 76-88 MHz, 174-216 MHz, or 470-806 MHz. However, operation within these Frequency bands is permitted under other sections of this Part Section 15.231 and 15.241

#### §15.205. Restrict Band of Operation for FCC

[MHz]	[MHz]	[MHz]	[GHz]
0.090 - 0.110	16.42 - 16.423	399.9 - 410	4.5 - 5.15
0.495 - 0.505**	16.694 75 - 16.695 25	608 - 614	5.35 - 5.46
2.173 5 - 2.190 5	16.804 25 - 16.804 75	960 - 1 240	7.25 - 7.75
4.125 - 4.128	25.5 - 25.67	1 300 - 1 427	8.025 - 8.
4.177 25 - 4.177 75	37.5 -38.25	1 435 - 1 626.5	9.0 - 9.2
4.207 25 - 4.207 75	73 - 74.6	1 645.5 - 1 646.5	9.3 - 9.5
6.215 - 6.218	74.8 - 75.2	1 660 - 1 710	10.6 - 12.7
6.267 75 - 6.268 25	108 - 121.94	1 718.8 - 1 722.2	13.25 - 13.4
6.311 75 - 6.312 25	123 - 138	2 200 - 2 300	14.47 - 14.5
8.291 - 8.294	149.9 - 150.05	2 310 - 2 390	15.35 - 16.2
8.362 - 8.366	156.524 75 - 156.525 25	2 483.5 - 2 500	17.7 - 21.4
8.376 25 - 8.38 6 75	156.7 - 156.9	2 690 - 2 900	22.01 - 23.12
8.414 25 - 8.414 75	162.012 5 - 167.17	3 260 - 3 267	23.6 - 24.0
12.29 - 12.293	167.72 - 173.2	3 332 - 3 339	31.2 - 31.8
12.519 75 - 12.520 25	240 - 285	3 345.8 - 3 358	36.43 - 36.5
12.576 75 - 12.577 25	322 - 335.4	3 600 - 4 400	Above 38.6
13.36 - 13.41			

\*\* Until February 1, 1999, this restricted band shall be 0.490-0.510

## §15.205. Restrict Band of Operation for IC

[MHz]	[MHz]	[MHz]	[GHz]
0.090 - 0.110	12.519 75 - 12.520 25	399.9 - 410	5.35 - 5.46
2.173 5 - 2.190 5	12.576 75 - 12.577 25	608 - 614	7.25 - 7.75
3.020 - 3.026	13.36 - 13.41	960 - 1 427	8.025 - 8.
4.125 - 4.128	16.42 - 16.423	1 435 - 1 626.5	9.0 - 9.2
4.177 25 - 4.177 75	16.694 75 - 16.695 25	1 645.5 - 1 646.5	9.3 - 9.5
4.207 25 - 4.207 75	16.804 25 - 16.804 75	1 660 - 1 710	10.6 - 12.7
5.677 - 5.683	25.5 - 25.67	1 718.8 - 1 722.2	13.25 - 13.4
6.215 - 6.218	37.5 - 38.25	2 200 - 2 300	14.47 - 14.5
6.26775-6.26825	73 - 74.6	2 310 - 2 390	15.35 - 16.2
6.31175-6.31225	74.8 - 75.2	2 655 - 2 900	17.7 - 21.4
8.291 - 8.294	108 - 138	3 260 - 3 267	22.01 - 23.12
8.362 - 8.366	156.524 75 - 156.525 25	3 332 - 3 339	23.6 - 24.0
8.376 25 - 8.38 6 75	156.7 - 156.9	3 345.8 - 3 358	31.2 - 31.8
8.414 25 - 8.414 75	240 - 285	3 500 - 4 400	36.43 - 36.5
12.29 - 12.293	322 - 335.4	4 500 - 5 150	Above 38.6

### 5.5.2 Test Environment conditions

- Ambient temperature : (24 ~ 25) °C • Relative Humidity : (49 ~ 55) % R.H.

### 5.5.3 Measurement Procedure

The measurements procedure of the Spurious RF Radiated emissions is as following describe method.

1. The EUT was placed on the top of a rotating table (0.8 meters for below 1 GHz and 1.5 meters for above 1 GHz) above the ground at a 3 meter camber. The table was rotated 360 degree to determine the position of the highest radiation.
  2. The EUT was set 3 meters away from the interference-receiving antenna, which was mounted on the top of a variable-height antenna master.
  3. The antenna height is varied from one meter to four meters above the ground to determine the maximum value of the field strength. Both Horizontal and vertical polarizations of the antenna are set to make the measurement.
  4. For each suspected emission, the EUT was arranged to its worst case and then the antenna was tuned to heights from 1 meter to 4 meters and the rotating table was turned from 0 - 360 degrees to find the maximum reading.
  5. The measuring receiver was set to peak detector and specified bandwidth with max hold function.
  6. Low, Middle and high channels were measured, and radiation measurements are performed in X, Y, Z axis positioning. And found the worst axis position and only the test worst case mode is recorded in the report.
- The measurement results are obtained as described below:  
Result(dB  $\mu$ V/m) = Reading(dB  $\mu$ V) + Antenna factor(dB/m)+ CL(dB) + other applicable factor (dB)
  - The resolution bandwidth of test receiver/spectrum analyzer is 1 MHz and the video bandwidth is 3 MHz for RMS Average (Duty cycle < 98 %) for Average detection (AV) at frequency above 1 GHz, then the measurement results was added to a correction factor (10 log(1/duty cycle)).
  - The resolution bandwidth of test receiver/spectrum analyzer is 1 MHz and the video bandwidth is 10 Hz (Duty cycle  $\geq$  98 %) for Average detection (AV) at frequency above 1 GHz.
  - According to §15.33 (a)(1), Frequency range of radiated measurement is performed the tenth harmonic.

### 5.5.4 Measurement Uncertainty

Radiated Emission measurement: Below 1 GHz : 4.32 dB (CL: Approx 95 %, k=2)  
Above 1 GHz : 4.14 dB (CL: Approx 95 %, k=2)

### 5.5.5 Test Configuration

#### Radiated emission setup, Below 30 MHz

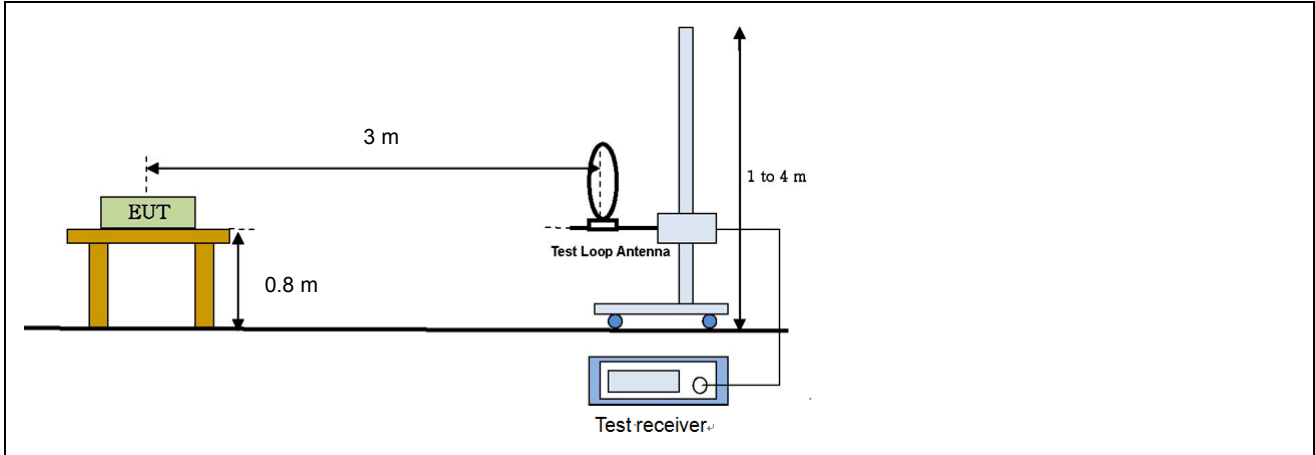

#### Radiated emission setup, Below 1 000 MHz

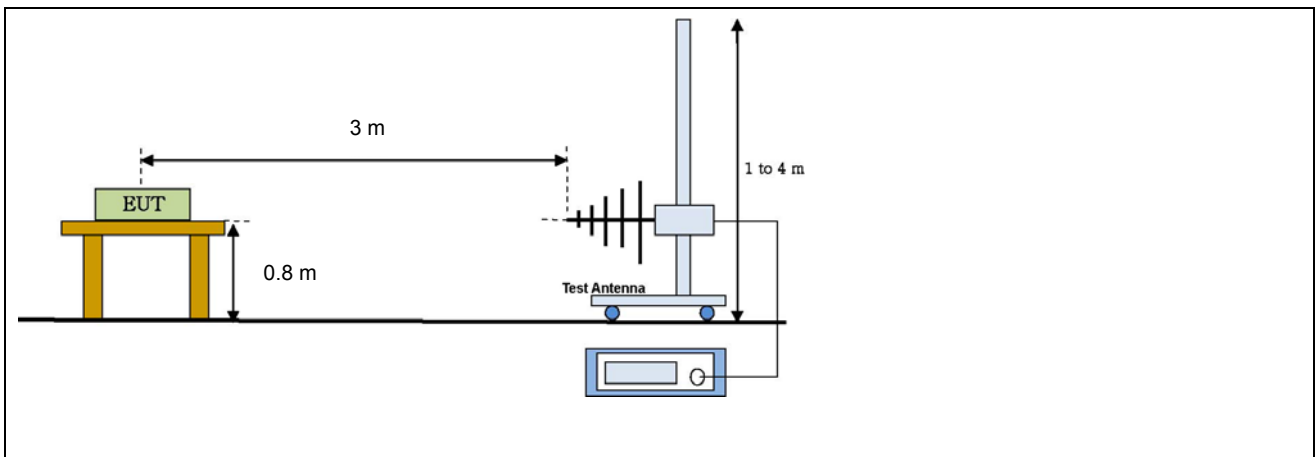

#### Radiated emission setup, Above 1 GHz

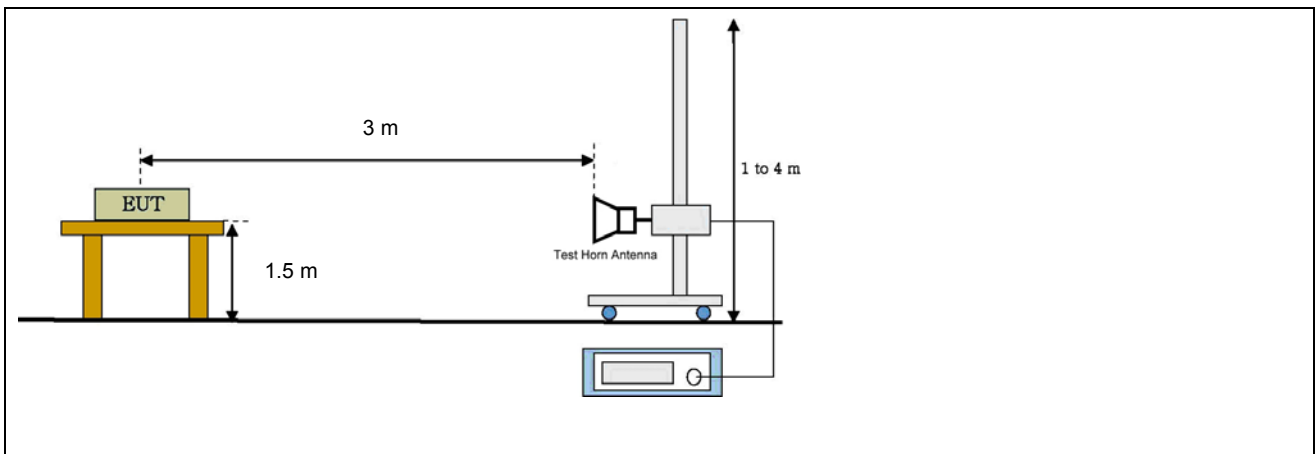

## 5.5.6 Measurement Result

Above 1 GHz

CH0 (2 402 MHz)

Freq. (GHz)	Reading (dB $\mu$ V/m)		Table (Deg)	Antenna			CL (dB)	AMP (dB)	Meas Result (dB $\mu$ V/m)		Limit (dB $\mu$ V/m)		Mgn. (dB)		Result
	PK	AV		Height (m)	Pol. (H/V)	Fctr. (dB/m)			PK	AV	PK	AV	PK	AV	
2.375*	43.43	31.03	180	1.0	V	28.28	6.85	-41.95	36.61	24.21	74	54	37.39	29.79	Compliance
2.375*	39.54	25.56	180	1.0	H	28.28	6.85	-41.95	32.72	18.74	74	54	41.28	35.26	Compliance

\* Restrict band emissions.

CH19 (2 440 MHz)

Freq. (GHz)	Reading (dB $\mu$ V/m)		Table (Deg)	Antenna			CL (dB)	AMP (dB)	Meas Result (dB $\mu$ V/m)		Limit (dB $\mu$ V/m)		Mgn. (dB)		Result
	PK	AV		Height (m)	Pol. (H/V)	Fctr. (dB/m)			PK	AV	PK	AV	PK	AV	
-	-	-	-	-	-	-	-	-	-	-	-	-	-	-	Compliance

CH39 (2 480 MHz)

Freq. (GHz)	Reading (dB $\mu$ V/m)		Table (Deg)	Antenna			CL (dB)	AMP (dB)	Meas Result (dB $\mu$ V/m)		Limit (dB $\mu$ V/m)		Mgn. (dB)		Result
	PK	AV		Height (m)	Pol. (H/V)	Fctr. (dB/m)			PK	AV	PK	AV	PK	AV	
2.485*	44.23	32.15	180	1.0	V	28.57	6.93	-42.26	37.47	25.39	74	54	35.53	28.61	Compliance
2.485*	39.32	26.42	180	1.0	H	28.57	6.93	-42.26	32.56	19.66	74	54	41.44	34.34	Compliance

\* Restrict band emissions.

### ※Note

- Above 1 GHz is measured average and peak detector mode on Spectrum analyzer in accordance with FCC Rule15.35
- Limit: 54 dB $\mu$ V/m(Average), 74 dB $\mu$ V/m(Peak), Attenuated more than 20 dB below the permissible value.
- It is not recorded on the report that the reading of emissions are attenuated more than 20 dB below the permissible limits or the field strength is too small to measured.
- The Reading values are already added value of the duty cycle factor and correction Factor was applied for Average Field Strength.
- For the below 30 MHz and above 2.495 GHz, measured any other signal is not detected on test receiver
- The transmitter radiated spectrum was investigated from 9 kHz to 26.5 GHz.



Below 1 GHz

Freq. (MHz)	Reading (dB $\mu$ V/m)	Table (Deg)	Antenna			CL (dB)	AMP (dB)	Meas Result (dB $\mu$ V/m)	Limit (dB $\mu$ V/m)	Mgn (dB)	Result
			Height (m)	Pol. (H/V)	Fctr. (dB/m)						
54.16	66.31	120	1.0	V	7.21	2.24	-41.61	34.15	40.00	5.85	Compliance
69.69	59.12	120	1.0	V	5.42	2.46	-41.61	25.39	40.00	14.61	Compliance
250.00	56.32	110	2.0	H	12.69	4.17	-40.99	32.19	46.00	13.81	Compliance
350.00	52.42	110	1.0	V	15.26	4.93	-40.69	31.92	46.00	14.08	Compliance
550.00	46.21	160	1.0	V	19.69	6.11	-39.77	32.24	46.00	13.76	Compliance
750.00	46.27	170	2.0	H	22.66	7.29	-38.56	37.66	46.00	8.34	Compliance
790.00	42.32	160	1.0	V	22.96	7.48	-38.33	34.43	46.00	11.57	Compliance

Freq.(MHz) : Measurement frequency, Reading(dB  $\mu$ V/m) : Indicated value for test receiver, Table (Deg) : Directional degree of Turn table  
 Antenna (Height, Pol, Fctr) : Antenna Height, Polarization and Factor, Cbl(dB) : Cable loss, Pre AMP(dB) : Preampifier gain(dB)  
 Meas Result (dB  $\mu$ V/m) : Reading(dB  $\mu$ V/m)+ Antenna factor.(dB/m) + CL(dB) - Pre AMP(dB)  
 Limit(dB  $\mu$ V/m): Limit value specified with FCC Rule, Mgn(dB) : FCC Limit (dB  $\mu$ V/m) – Meas Result(dB  $\mu$ V/m)



Test Plot (Conducted spurious emissions)

CH Low / Reference signal level: 5.46 dBm

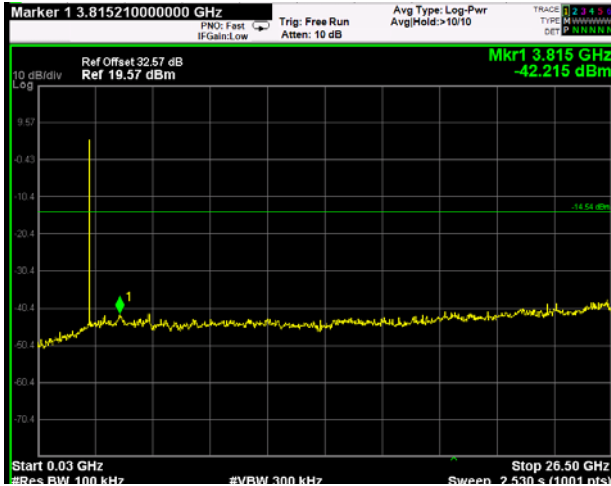

CH Middle / Reference signal level: 4.74 dBm

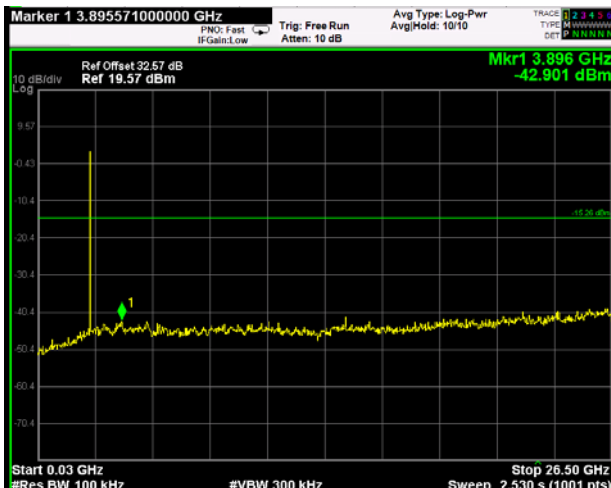

CH High / Reference signal level: 5.00 dBm

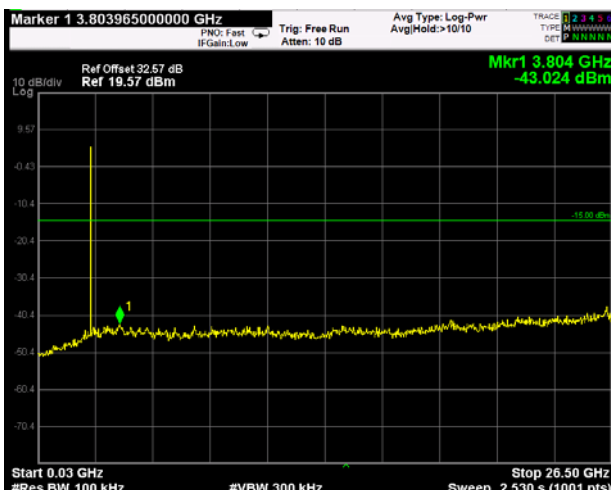

Note: It is not recorded on the report that the reading of emissions are attenuated more than 20 dB below the permissible limits

CH Low / Reference signal level: 5.46 dBm

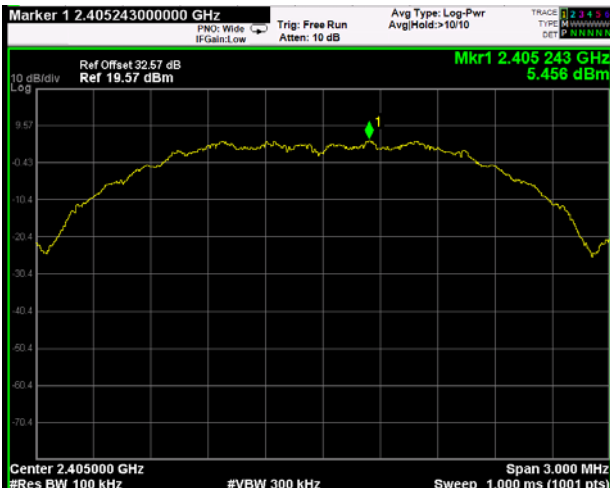

CH Middle / Reference signal level: 4.74 dBm

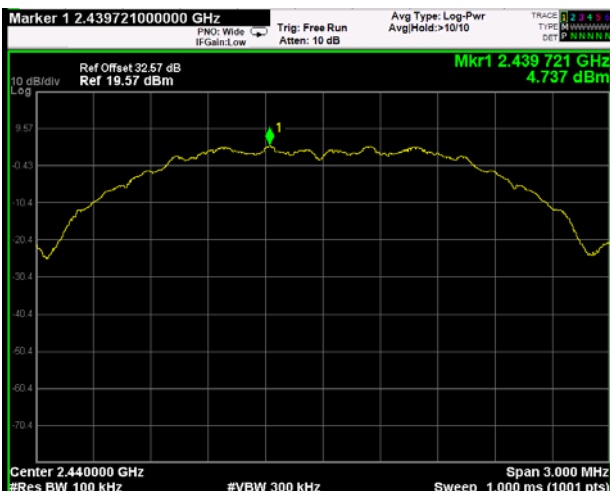

CH High / Reference signal level: 5.00 dBm

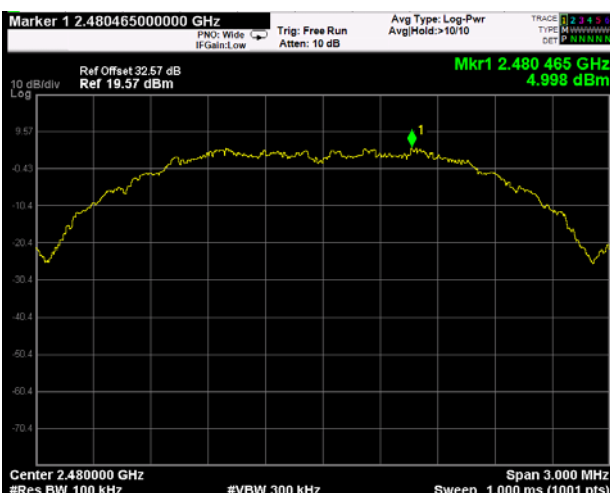

## 5.6 Antenna requirement

### 5.6.1 Standard applicable [FCC §15.203]

For intentional device, according to §15.203, an intentional radiator shall be designed to ensure that no antenna other than furnished by responsible party shall be used with the device.

The use of a permanently attached antenna or of an antenna that user a unique coupling to the intentional radiator shall be considered sufficient to comply with the provisions of this section.

The manufacturer may design the unit so that broken antenna can be replaced by the user, but the use of a standard antenna jack or electrical connector is prohibited.

### 5.6.2 Antenna details

Frequency Band	Antenna Type	Gain [dBi]	Results
2.4 GHz	Internal PCB pattern antenna	2.29	Compliance

## 5.7 AC Power Conducted emissions

### 5.7.1 Standard Applicable [ FCC §15.207(a) and RSS-Gen 8.8 ]

For intentional radiator that is designed to be connected to the public utility(AC)power line, the radio frequency. Voltage that is conducted back onto the AC power line on any frequencies hopping mode within the band 150 kHz to 30 MHz shall not exceed the limits in the following table, as measured using a 50  $\mu$ H/50 ohms line Impedance stabilization network(LISN). Compliance with the provisions of this paragraph shall be based on the measurement of the radio frequency voltage between each power line and ground at the power terminal. The lower limit applies at the boundary between the frequency ranges.

§15.207 limits for AC line conducted emissions;

Frequency of Emission(MHz)	Conducted Limit (dB $\mu$ V)	
	Quasi-peak	Average
0.15 ~ 0.5	66 to 56 *	56 to 46 *
0.5 ~ 5	56	46
5 ~ 30	60	50

\* Decreases with the logarithm of the frequency

### 5.7.2 Test Environment conditions

• Ambient temperature : (24 ~ 25) °C • Relative Humidity : (49 ~ 55) % R.H.

### 5.7.3 Measurement Procedure

EUT was placed on a non- metallic table height of 0.8 m above the reference ground plane. Cables connected to EUT were fixed to cause maximum emission. Test was made with the antenna positioned in both the horizontal and vertical planes of polarization. The measurement antenna was varied in height above the conducting ground plane to obtain the Maximum signal strength.

### 5.7.4 Used equipment

Equipment	Model No.	Serial No.	Manufacturer	Next cal date	Cal interval	Used
Test receiver	ESCS30	100111	Rohde & Schwarz	2018. 01. 31	1 year	<input checked="" type="checkbox"/>
LISN	ESH2-Z5	100044	R&S	2018. 01. 31	1 year	<input type="checkbox"/>
	ESH3-Z5	100147	R&S	2018. 01. 31	1 year	<input checked="" type="checkbox"/>

\*Test Program: " ESXS-K1 V2.2"

Measurement uncertainty

Conducted Emission measurement: 4.48 dB (CL: Approx 95 %, k=2)



### 5.7.5 Measurement Result

Freq. [MHz]	Factor [dB]		POL	QP			CISPR AV		
	LISN	CABLE +P/L		Limit [dB $\mu$ V]	Reading [dB $\mu$ V]	Result [dB $\mu$ V]	Limit [dB $\mu$ V]	Reading [dB $\mu$ V]	Result [dB $\mu$ V]
0.170	0.11	9.97	N	64.98	45.03	45.14	54.98	31.90	32.01
0.396	0.12	9.98	N	57.93	52.08	52.20	47.93	40.70	40.82
0.443	0.12	9.99	N	57.01	47.96	48.08	47.01	38.80	38.92
0.505	0.12	9.99	N	56.00	45.64	45.76	46.00	36.40	36.52
14.021	0.60	10.35	L	60.00	33.99	34.59	50.00	27.50	28.10
15.291	0.66	10.38	L	60.00	41.12	41.78	50.00	32.70	33.36
15.474	0.59	10.38	N	60.00	34.89	35.48	50.00	27.40	27.99
15.705	0.66	10.38	L	60.00	39.55	40.21	50.00	31.20	31.86
16.318	0.61	10.40	N	60.00	33.81	34.42	50.00	29.10	29.71
16.552	0.68	10.40	L	60.00	38.76	39.44	50.00	33.30	33.98
18.580	0.71	10.44	L	60.00	36.70	37.41	50.00	28.90	29.61
20.302	0.74	10.48	L	60.00	31.80	32.54	50.00	26.10	26.84

- \* LISN: LISN insertion Loss, Cable: Cable Loss, P/L:pulse limiter factor
- \* L: Line. Live, N: Line. Neutral
- \* Reading: test receiver reading value (with cable loss & pulse limiter factor)
- \* Result = LISN + Reading



Line. Live

Kostec Co.,Ltd

Conducted Emission

EUT: O-17-0260  
Manuf:  
Op Cond: AC 120V , 60Hz  
Operator:  
Test Spec: FCC  
Comment: Live

Result File: 0260\_L.dat : New Measurement

Scan Settings (1 Range)

Frequencies			Receiver Settings					
Start	Stop	Step	IF BW	Detector	M-Time	Atten	Preamp	OpRge
150kHz	30MHz	3.9063kHz	9kHz	PK+AV	10msec	15 dB	OFF	60dB

Transducer	No.	Start	Stop	Name
	11	9kHz	30MHz	MAIN

Final Measurement: Detectors: X QP / + AV  
Meas Time: 1sec  
Peaks: 25  
Acc Margin: 50 dB

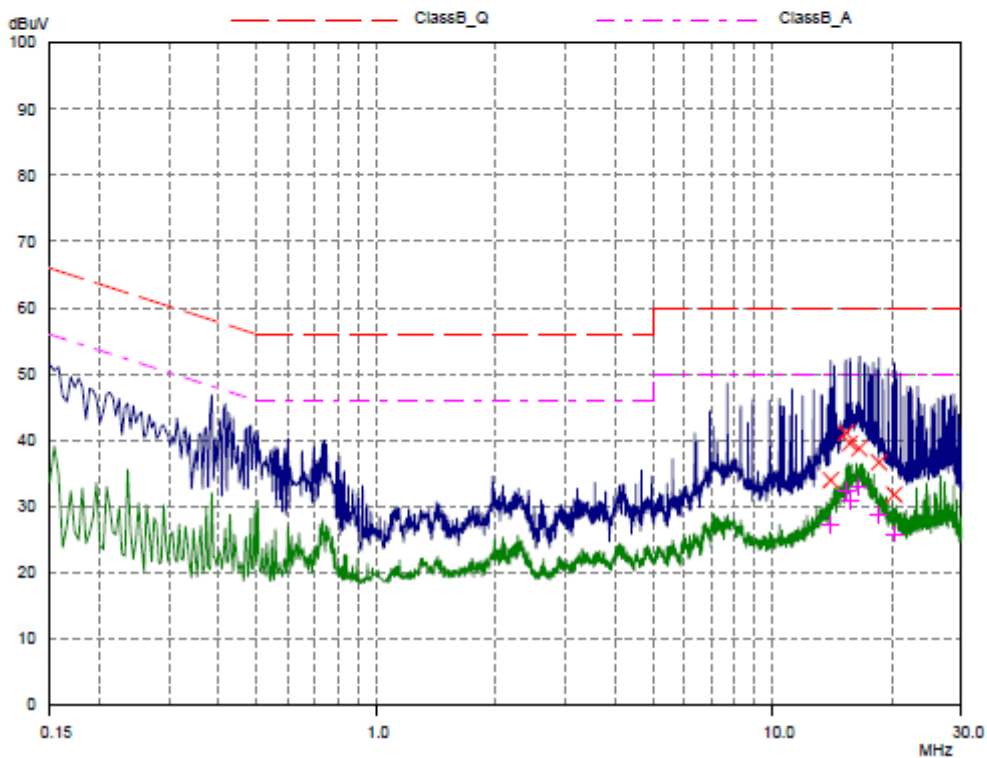



Line: Neutral

Kostec Co.,Ltd

Conducted Emission

EUT: O-17-0260  
Manuf:  
Op Cond: AC 120V , 60Hz  
Operator:  
Test Spec: FCC  
Comment: Neutral

Result File: 0260\_n.dat : New Measurement

Scan Settings (1 Range)

Frequencies			Receiver Settings						
Start	Stop	Step	IF BW	Detector	M-Time	Atten	Preamp	OpRge	
150kHz	30MHz	3.9063kHz	9kHz	PK+AV	10msec	15 dB	OFF	60dB	

Transducer	No.	Start	Stop	Name
	11	9kHz	30MHz	MAIN

Final Measurement: Detectors: X QP / + AV  
Meas Time: 1sec  
Peaks: 25  
Acc Margin: 50 dB

