



# FCC Part 15C Test Report

## FCC ID: 2AF3W-1567261

Product Name:	Ballistic Precision LR Target Camera System
Trademark:	
Model Name :	156726
Prepared For :	Battenfeld Acquisition Company Inc. & Subsidiary
Address :	2501 LeMone Industrial Blvd, Columbia MO 65201,USA
Prepared By :	<b>Shenzhen BCTC Technology Co., Ltd.</b>
Address :	No.101,Yousong Road,Longhua New District, Shenzhen,China
Test Date:	Jun. 21- Jun. 30, 2017
Date of Report :	Jun. 30, 2017
Report No.:	BCTC-LH170702923E



### VERIFICATION OF COMPLIANCE

**Applicant's name** .....: Battenfeld Acquisition Company Inc. & Subsidiary  
 Address.....: 2501 LeMone Industrial Blvd, Columbia MO 65201,USA  
**Manufacture's Name** .....: Maihai Technology Development Co., Ltd.  
 Address.....: No. 8, JinYu First Street, KangHu Street, TangXia Town,  
 DongGuan City,523716, GuangDong Province, China

#### Product description

Product Name: Ballistic Precision LR Target Camera System  
 Trademark:   
 Model Name : 156726  
 Standards: FCC Part15.247  
 ANSI C63.10-2013

This device described above has been tested by BCTC, and the test results show that the equipment under test (EUT) is in compliance with the FCC requirements. And it is applicable only to the tested sample identified in the report.

This report shall not be reproduced except in full, without the written approval of BCTC, this document may be altered or revised by BCTC, personal only, and shall be noted in the revision of the document.

Test Result ..... : **Pass**

Testing Engineer :   
 \_\_\_\_\_  
 Eric Yang

Reviewer (Supervisor) :   
 \_\_\_\_\_  
 Jade Yang

Authorized Signer(Manager) :   
 \_\_\_\_\_  
 Carson Zhang

**Table of Contents**

	<b>Page</b>
<b>1 . SUMMARY OF TEST RESULTS</b>	<b>5</b>
1.1 TEST FACILITY	6
1.2 MEASUREMENT UNCERTAINTY	6
<b>2 . GENERAL INFORMATION</b>	<b>7</b>
2.1 GENERAL DESCRIPTION OF EUT	7
2.2 DESCRIPTION OF TEST MODES	8
2.3 BLOCK DIGRAM SHOWING THE CONFIGURATION OF SYSTEM TESTED	9
2.4 DESCRIPTION OF SUPPORT UNITS(CONDUCTED MODE)	9
<b>3 EQUIPMENTS LIST FOR ALL TEST ITEMS</b>	<b>10</b>
<b>4 . EMC EMISSION TEST</b>	<b>11</b>
4.1 CONDUCTED EMISSION MEASUREMENT	11
4.1.1 POWER LINE CONDUCTED EMISSION LIMITS (FREQUENCY RANGE 150KHZ-30MHZ)	11
4.1.2 TEST PROCEDURE	11
4.1.3 DEVIATION FROM TEST STANDARD	11
4.1.4 TEST SETUP	12
4.1.5 EUT OPERATING CONDITIONS	12
4.1.6 TEST RESULTS	12
4.2 RADIATED EMISSION MEASUREMENT	15
4.2.1 RADIATED EMISSION LIMITS (FREQUENCY RANGE 9KHZ-1000MHZ)	15
4.2.2 TEST PROCEDURE	16
4.2.3 DEVIATION FROM TEST STANDARD	16
4.2.4 TEST SETUP	16
4.2.5 EUT OPERATING CONDITIONS	17
4.2.6 TEST RESULTS (BETWEEN 9KHZ – 30 MHZ)	18
4.2.7 TEST RESULTS (BETWEEN 30MHZ – 1GHZ)	19
4.2.8 TEST RESULTS (1GHZ~25GHZ)THE WORST RESULT WAS REPORT AS BELOW;	21
3.3 RADIATED BAND EMISSION MEASUREMENT	26
3.3.1 TEST REQUIREMENT:	26
3.3.2 TEST PROCEDURE	26
3.3.3 DEVIATION FROM TEST STANDARD	27
3.3.4 TEST SETUP	27
3.3.5 EUT OPERATING CONDITIONS	27
<b>5 . 6DB BANDWIDTH</b>	<b>30</b>
5.1 APPLIED PROCEDURES / LIMIT	30
5.1.1 TEST PROCEDURE	30
5.1.2 DEVIATION FROM STANDARD	30
5.1.3 TEST SETUP	30
5.1.4 EUT OPERATION CONDITIONS	30



<b>Table of Contents</b>		<b>Page</b>
5.1.5 TEST RESULTS		31
<b>6 . DUTY CYCLE</b>		<b>34</b>
6.1 APPLICABLE STANDARD		34
6.2 CONFORMANCE LIMIT		34
6.3 MEASURING INSTRUMENTS		34
6.4 TEST SETUP		34
6.5 TEST PROCEDURE		34
6.6 TEST RESULTS		34
<b>7 . POWER SPECTRAL DENSITY TEST</b>		<b>35</b>
7.1 APPLIED PROCEDURES / LIMIT		35
7.1.1 TEST PROCEDURE		35
7.1.2 DEVIATION FROM STANDARD		35
7.1.3 TEST SETUP		35
7.1.4 EUT OPERATION CONDITIONS		35
7.1.5 TEST RESULTS		36
<b>8 . PEAK OUTPUT POWER TEST</b>		<b>39</b>
8.1 APPLIED PROCEDURES / LIMIT		39
8.1.1 TEST PROCEDURE		39
8.1.2 DEVIATION FROM STANDARD		39
8.1.3 TEST SETUP		39
8.1.4 EUT OPERATION CONDITIONS		39
8.1.5 TEST RESULTS		40
<b>9 . 100 KHZ BANDWIDTH OF FREQUENCY BAND EDGE</b>		<b>41</b>
7.1 APPLICABLE STANDARD		41
7.2 TEST PROCEDURE		41
7.3 DEVIATION FROM STANDARD		41
7.4 TEST SETUP		41
7.5 EUT OPERATION CONDITIONS		41
9.1 TEST RESULTS		41
<b>10 . ANTENNA REQUIREMENT</b>		<b>46</b>
10.1 STANDARD REQUIREMENT		46
10.2 EUT ANTENNA		46
<b>11 . EUT TEST PHOTO</b>		<b>47</b>
<b>12 . EUT PHOTO</b>		<b>49</b>
<b>APPENDIX-PHOTOGRAPHS OF EUT CONSTRUCTIONAL DETAILS</b>		



## 1. SUMMARY OF TEST RESULTS

Test procedures according to the technical standards:

<b>FCC Part15 (15.247) , Subpart C</b>			
Standard Section	Test Item	Judgment	Remark
15.207	Conducted Emission	PASS	
15.247 (a)(2)	6dB Bandwidth	PASS	
15.247 (b)	Peak Output Power	PASS	
15.247 (c)	Radiated Spurious Emission	PASS	
15.247 (d)	Power Spectral Density	PASS	
15.205	Band Edge Emission	PASS	
15.203	Antenna Requirement	PASS	

NOTE:

(1) "N/A" denotes test is not applicable in this Test Report



## 1.1 TEST FACILITY

Shenzhen BCTC Technology Co., Ltd.

Add. : No.101, Yousong Road, Longhua New District, Shenzhen, China

FCC Registered No.: 187086

IC Registered No.: 12655A

## 1.2 MEASUREMENT UNCERTAINTY

The reported uncertainty of measurement  $y \pm U$ , where expanded uncertainty  $U$  is based on a standard uncertainty multiplied by a coverage factor of  $k=2$ , providing a level of confidence of approximately **95 %**.

No.	Item	Uncertainty
1	Conducted Emission Test	$\pm 1.38\text{dB}$
2	RF power, conducted	$\pm 0.16\text{dB}$
3	Spurious emissions, conducted	$\pm 0.21\text{dB}$
4	All emissions, radiated (<1G)	$\pm 4.68\text{dB}$
5	All emissions, radiated (>1G)	$\pm 4.89\text{dB}$
6	Temperature	$\pm 0.5^\circ\text{C}$
7	Humidity	$\pm 2\%$



## 2. GENERAL INFORMATION

### 2.1 GENERAL DESCRIPTION OF EUT

Equipment	Ballistic Precision LR Target Camera System		
Trade Name			
Model Name	156726		
Model Difference	N/A		
Product Description	The EUT is a Dokicam		
	Operation Frequency:	802.11b/g/n20MHz:2412~2462MHz 802.11n40MHz: 2422~2452MHz	
	Modulation Type:	WIFI: OFDM/DSSS	
	Bit Rate of Transmitter	802.11b:11/5.5/2/1 Mbps 802.11g:54/48/36/24/18/12/9/6Mbps 802.11n Up to 150Mbps	
	Number Of Channel	802.11b/g/n20MHz:11 CH 802.11n40MHz:7 CH	
	Antenna Designation:	Please see Note 3.	
Based on the application, features, or specification exhibited in User's Manual, the EUT is considered as an ITE/Computing Device. More details of EUT technical specification, please refer to the User's Manual.			
Channel List	Please refer to the Note 2.		
Power Source	DC 11.1V DC 12.6V from Adapter		
Adapter	N/A		
hardware version	---		
Software version	---		

Note:

1. For a more detailed features description, please refer to the manufacturer's specifications or the User's Manual.

2.

Channel List for 802.11b/g/n(20)							
Channel	Frequency (MHz)	Channel	Frequency (MHz)	Channel	Frequency (MHz)	Channel	Frequency (MHz)
01	2412	04	2427	07	2442	10	2457
02	2417	05	2432	08	2447	11	2462
03	2422	06	2437	09	2452		

Channel List for 802.11n(40)							
Channel	Frequency (MHz)	Channel	Frequency (MHz)	Channel	Frequency (MHz)	Channel	Frequency (MHz)
03	2422	05	2432	07	2442	09	2452
04	2427	06	2437	08	2447		



## 3. Table for Filed Antenna

Ant.	Brand	Model Name	Antenna Type	Gain (dBi)	NOTE
1	N/A	N/A	integrated antenna	14.0dBi	

**2.2 DESCRIPTION OF TEST MODES**

Pretest Mode	Description
Mode 1	802.11b CH1/ CH6/ CH11
Mode 2	802.11g CH1/ CH6/ CH11
Mode 3	802.11n20 CH1/ CH6/ CH11
Mode 4	802.11n40 CH3/ CH6/ CH09
Mode 5	Link Mode

<b>Conducted Emission</b>	
Final Test Mode	Description
Mode 5	Link Mode

<b>For Radiated Emission</b>	
Final Test Mode	Description
Mode 1	802.11b CH1/ CH6/ CH11
Mode 2	802.11g CH1/ CH6/ CH11
Mode 3	802.11n20 CH1/ CH6/ CH11
Mode 4	802.11n40 CH3/ CH6/ CH09

Note:

- (1) The measurements are performed at the highest, middle, lowest available channels.
- (2) The measurements are performed at all Bit Rate of Transmitter, the worst data was reported
- (3) According to ANSI C63.10 standards, the test results are both the "worst case" and "worst setup" 11Mbps for 802.11b, 6Mbps for 802.11g, 13Mbps for 802.11n(H20), 54Mbps for 802.11n(H40).



### 2.3 BLOCK DIGRAM SHOWING THE CONFIGURATION OF SYSTEM TESTED

Radiated Spurious Emission Test

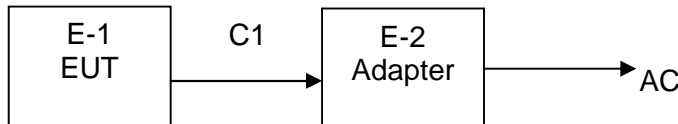

Conducted Spurious Emission Test

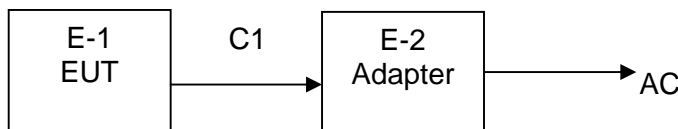

### 2.4 DESCRIPTION OF SUPPORT UNITS(CONDUCTED MODE)

The EUT has been tested as an independent unit together with other necessary accessories or support units. The following support units or accessories were used to form a representative test configuration during the tests.

Item	Equipment	Mfr/Brand	Model/Type No.	Series No.	Note
E-1	Dokicam	N/A	Dokicam	N/A	EUT
E-2	Adapter (Provide by test lab)	N/A	P12-126080	N/A	I/P: AC 100-240V 50/60Hz 0.3A O/P: DC 12.6V/0.8A

Item	Shielded Type	Ferrite Core	Length	Note
C1	NO	NO	1.0m	USB cable

Note:

- (1) The support equipment was authorized by Declaration of Confirmation.
- (2) For detachable type I/O cable should be specified the length in cm in 『Length』 column.



### 3 EQUIPMENTS LIST FOR ALL TEST ITEMS

#### Radiation Test equipment

Item	Kind of Equipment	Manufacturer	Type No.	Serial No.	Last calibration	Calibrated until
1	Spectrum Analyzer	Agilent	E4407B	MY45109572	2016.08.27	2017.08.26
2	Test Receiver	R&S	ESPI	101396	2016.08.27	2017.08.26
3	Bilog Antenna	SCHWARZBECK	VULB9160	VULB9160-3369	2016.08.27	2017.08.26
4	50Ω Coaxial Switch	Anritsu	MP59B	6200264416	2016.08.27	2017.08.26
5	Spectrum Analyzer	Agilent	N9020A	MY5051041	2016.08.27	2017.08.26
6	Horn Antenna	SCHWARZBECK	9120D	9120D-1275	2016.08.27	2017.08.26
7	Horn Ant	Schwarzbeck	BBHA 9170	9170-181	2016.08.25	2017.08.24
8	Amplifier	SCHWARZBECK	BBV9718	9718-270	2016.08.25	2017.08.24
9	Amplifier	SCHWARZBECK	BBV9743	9743-119	2016.08.25	2017.08.24
10	Loop Antenna	ARA	PLEM95X30/B	1029	2016.08.25	2017.08.24
11	Power Meter	R&S	NRVS	100696	2016.08.27	2017.08.26
12	Power Sensor	R&S	URV5-Z4	0395.1619.05	2016.08.27	2017.08.26
13	RF cables	R&S	N/A	N/A	2016.08.27	2017.08.26

#### Conduction Test equipment

Item	Kind of Equipment	Manufacturer	Type No.	Serial No.	Last calibration	Calibrated until
1	Test Receiver	R&S	ESCI	1166.5950K03-101165-ha	2016.08.27	2017.08.26
2	LISN	R&S	NSLK8126	8126466	2016.08.27	2017.08.26
3	LISN	R&S	NSLK8126	8126487	2016.08.27	2017.08.26
4	50Ω Coaxial Switch	Anritsu	MP59B	6200264417	2016.08.27	2017.08.26
5	RF cables	R&S	R204	R20X	2016.08.27	2017.08.26



## 4. EMC EMISSION TEST

### 4.1 CONDUCTED EMISSION MEASUREMENT

#### 4.1.1 POWER LINE CONDUCTED EMISSION LIMITS (FREQUENCY RANGE 150KHZ-30MHZ)

FREQUENCY (MHz)	Limit(dBuV)		Standard
	Quasi-peak	Average	
0.15 -0.5	66 - 56 *	56 - 46 *	FCC
0.50 -5.0	56.00	46.00	FCC
5.0 -30.0	60.00	50.00	FCC

Note:

- (1) The tighter limit applies at the band edges.
- (2) The limit of " \* " marked band means the limitation decreases linearly with the logarithm of the frequency in the range.

The following table is the setting of the receiver

Receiver Parameters	Setting
Attenuation	10 dB
Start Frequency	0.15 MHz
Stop Frequency	30 MHz
IF Bandwidth	9 kHz

#### 4.1.2 TEST PROCEDURE

- a. The EUT was placed 0.8 meters from the horizontal ground plane with EUT being connected to the power mains through a line impedance stabilization network (LISN). All other support equipments powered from additional LISN(s). The LISN provide 50 Ohm/ 50uH of coupling impedance for the measuring instrument.
- b. Interconnecting cables that hang closer than 40 cm to the ground plane shall be folded back and forth in the center forming a bundle 30 to 40 cm long.
- c. I/O cables that are not connected to a peripheral shall be bundled in the center. The end of the cable may be terminated, if required, using the correct terminating impedance. The overall length shall not exceed 1 m.
- d. LISN at least 80 cm from nearest part of EUT chassis.
- e. For the actual test configuration, please refer to the related Item –EUT Test Photos.

#### 4.1.3 DEVIATION FROM TEST STANDARD

No deviation

#### 4.1.4 TEST SETUP

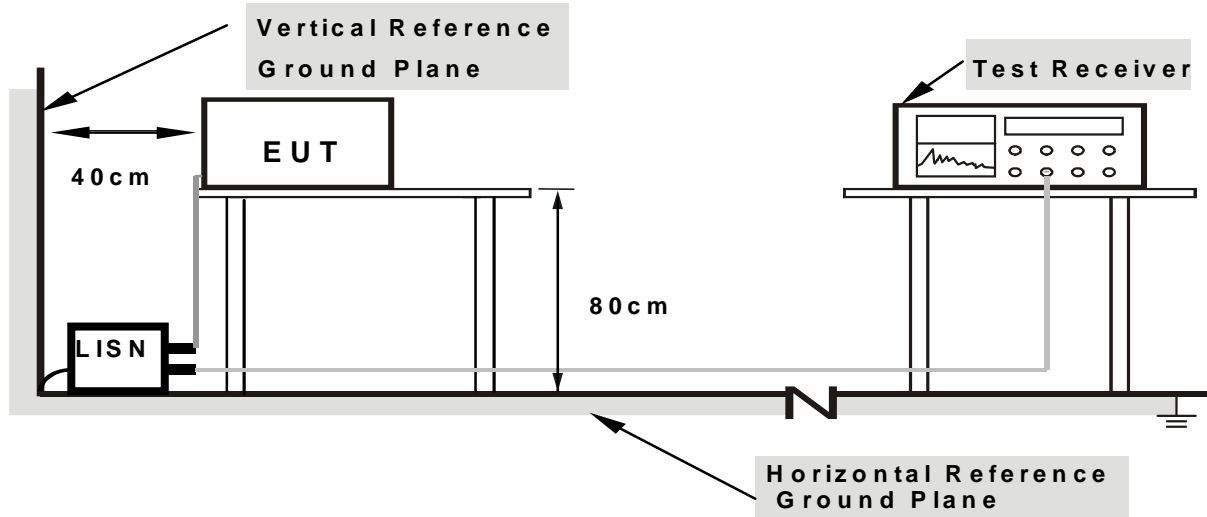

Note: 1. Support units were connected to second LISN.

2. Both of LISNs (AMN) are 80 cm from EUT and at least 80 cm from other units and other metal planes

#### 4.1.5 EUT OPERATING CONDITIONS

The EUT was configured for testing in a typical fashion (as a customer would normally use it). The EUT has been programmed to continuously transmit during test. This operating condition was tested and used to collect the included data.

We pretest AC 120V and AC 240V, the worst voltage was AC 120V and the data recording in the report.

#### 4.1.6 TEST RESULTS



Temperature :	25 °C	Relative Humidity :	54%
Pressure :	1010hPa	Phase :	L
Test Voltage :	AC 120V/60Hz	Test Mode :	Mode 5

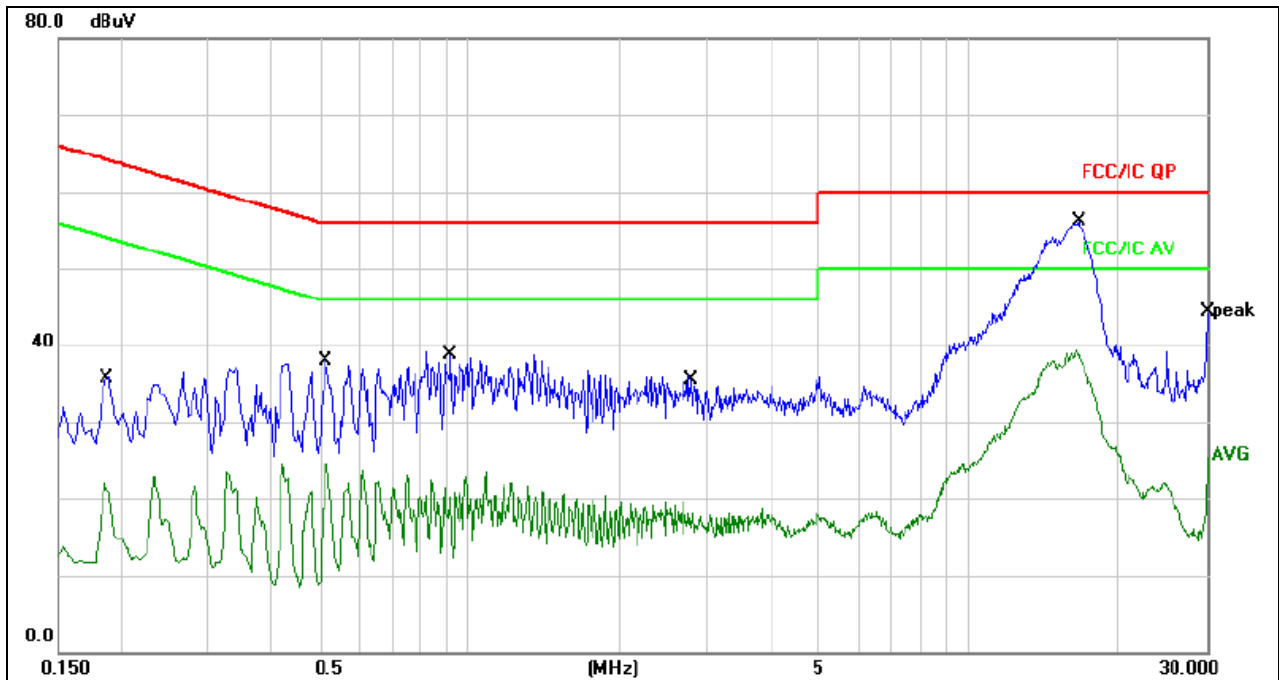

Remark:

1. All readings are Quasi-Peak and Average values.
2. Factor = Insertion Loss + Cable Loss.

No. Mk.	Freq. MHz	Reading Level dBuV	Correct Factor dB	Measure- ment dBuV	Limit dBuV	Over dB	Detector	Comment
1	0.1860	25.94	10.06	36.00	64.21	-28.21	QP	
2	0.1860	12.05	10.06	22.11	54.21	-32.10	AVG	
3	0.5180	27.71	10.12	37.83	56.00	-18.17	QP	
4	0.5180	14.45	10.12	24.57	46.00	-21.43	AVG	
5	0.9140	28.57	10.16	38.73	56.00	-17.27	QP	
6	0.9140	12.84	10.16	23.00	46.00	-23.00	AVG	
7	2.7860	25.39	10.19	35.58	56.00	-20.42	QP	
8	2.7860	7.90	10.19	18.09	46.00	-27.91	AVG	
9 *	16.4340	45.87	10.15	56.02	60.00	-3.98	QP	
10	16.4340	29.08	10.15	39.23	50.00	-10.77	AVG	
11	30.0000	33.98	10.22	44.20	60.00	-15.80	QP	
12	30.0000	15.24	10.22	25.46	50.00	-24.54	AVG	



Temperature :	25 °C	Relative Humidity :	54%
Pressure :	1010hPa	Phase :	N
Test Voltage :	AC 120V/60Hz	Test Mode :	Mode 5

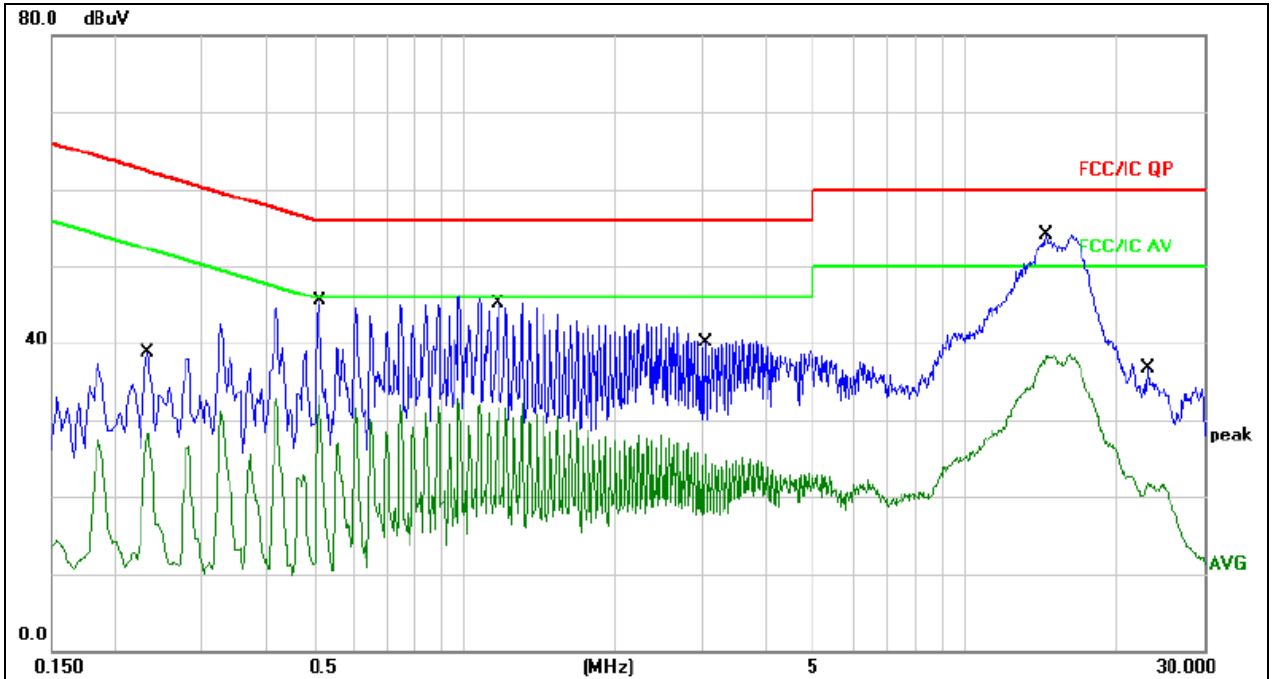

Remark:

1. All readings are Quasi-Peak and Average values.
2. Factor = Insertion Loss + Cable Loss.

No.	Mk.	Freq. MHz	Reading Level dBuV	Correct Factor dB	Measure- ment dBuV	Limit dBuV	Over dB	Detector	Comment
1		0.2340	28.65	10.07	38.72	62.30	-23.58	QP	
2		0.2340	18.24	10.07	28.31	52.30	-23.99	AVG	
3		0.5140	35.40	10.12	45.52	56.00	-10.48	QP	
4		0.5140	23.07	10.12	33.19	46.00	-12.81	AVG	
5		1.1660	34.96	10.17	45.13	56.00	-10.87	QP	
6		1.1660	21.84	10.17	32.01	46.00	-13.99	AVG	
7		3.0300	30.26	10.19	40.45	56.00	-15.55	QP	
8		3.0300	15.30	10.19	25.49	46.00	-20.51	AVG	
9	*	14.6820	43.98	10.15	54.13	60.00	-5.87	QP	
10		14.6820	28.15	10.15	38.30	50.00	-11.70	AVG	
11		23.2420	26.60	10.19	36.79	60.00	-23.21	QP	
12		23.2420	11.64	10.19	21.83	50.00	-28.17	AVG	



**4.2 RADIATED EMISSION MEASUREMENT**

**4.2.1 RADIATED EMISSION LIMITS (FREQUENCY RANGE 9KHZ-1000MHZ)**

20dBc in any 100 kHz bandwidth outside the operating frequency band. In case the emission fall within the restricted band specified on 15.205(a), then the 15.209(a) limit in the table below has to be followed.

Frequencies (MHz)	Field Strength (micorvolts/meter)	Measurement Distance (meters)
0.009~0.490	2400/F(KHz)	300
0.490~1.705	24000/F(KHz)	30
1.705~30.0	30	30
30~88	100	3
88~216	150	3
216~960	200	3
Above 960	500	3

LIMITS OF RADIATED EMISSION MEASUREMENT (Above 1000MHZ)

FREQUENCY (MHz)	Limit(dBuV/m) (at 3M)	
	PEAK	AVERAGE
Above 1000	74	54

Notes:

- (1) The limit for radiated test was performed according to FCC PART 15C.
- (2) The tighter limit applies at the band edges.
- (3) Emission level (dBuV/m)=20log Emission level (uV/m).

Spectrum Parameter	Setting
Attenuation	Auto
Start Frequency	1000 MHz
Stop Frequency	25GHz
RB / VB (emission in restricted band)	1 MHz / 1 MHz for Peak, 1 MHz / 10Hz for Average

Receiver Parameter	Setting
Attenuation	Auto
Start ~ Stop Frequency	9kHz~150kHz / RB 200Hz for QP
Start ~ Stop Frequency	150kHz~30MHz / RB 9kHz for QP
Start ~ Stop Frequency	30MHz~1000MHz / RB 120kHz for QP

#### 4.2.2 TEST PROCEDURE

Below 1GHz test procedure as below:

- a. The EUT was placed on the top of a rotating table 0.8 meters above the ground at a 3 meter semi-anechoic chamber. The table was rotated 360 degrees to determine the position of the highest radiation.
- b. The EUT was set 3 meters away from the interference-receiving antenna, which was mounted on the top of a variable-height antenna tower.
- c. The antenna height is varied from one meter to four meters above the ground to determine the maximum value of the field strength. Both horizontal and vertical polarizations of the antenna are set to make the measurement.
- d. For each suspected emission, the EUT was arranged to its worst case and then the antenna was tuned to heights from 1 meter to 4 meters (for the test frequency of below 30MHz, the antenna was tuned to heights 1 meter) and the rotatable table was turned from 0 degrees to 360 degrees to find the maximum reading.
- e. The test-receiver system was set to Peak Detect Function and Specified Bandwidth with Maximum Hold Mode.
- f. If the emission level of the EUT in peak mode was 10dB lower than the limit specified, then testing could be stopped and the peak values of the EUT would be reported. Otherwise the emissions that did not have 10dB margin would be re-tested one by one using peak, quasi-peak or average method as specified and then reported in a data sheet.

Above 1GHz test procedure as below:

- g. Different between above is the test site, change from Semi- Anechoic Chamber to fully Anechoic Chamber and change form table 0.8 meter to 1.5 meter( Above 18GHz the distance is 1 meter and table is 1.5 meter).
- h. Test the EUT in the lowest channel ,the middle channel ,the Highest channel

Note:

Both horizontal and vertical antenna polarities were tested and performed pretest to three orthogonal axis. The worst case emissions were reported

#### 4.2.3 DEVIATION FROM TEST STANDARD

No deviation

#### 4.2.4 TEST SETUP

(A) Radiated Emission Test-Up Frequency Below 30MHz

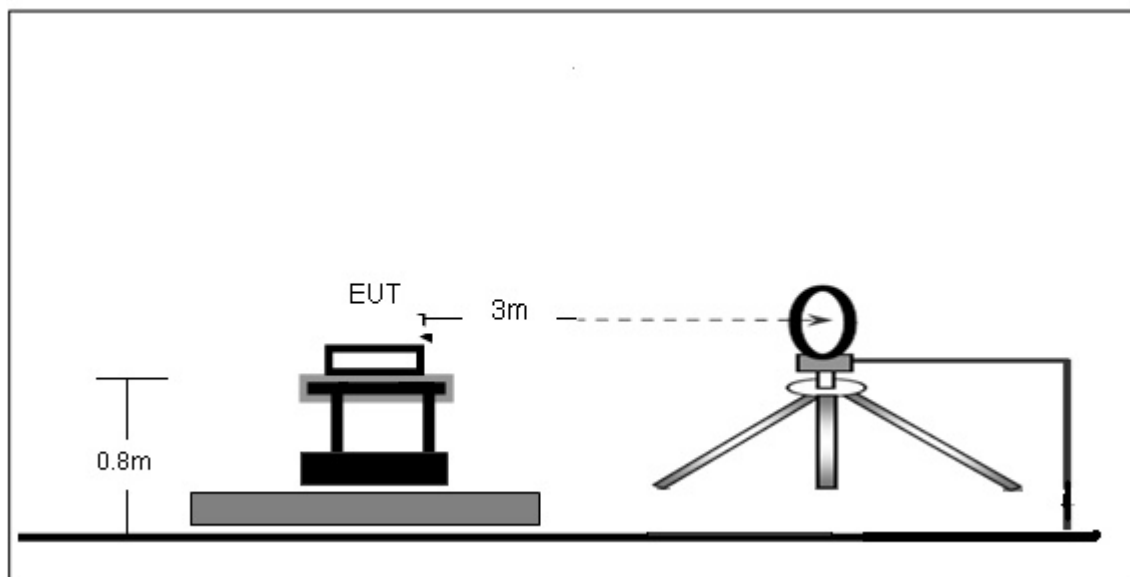



## (B) Radiated Emission Test-Up Frequency 30MHz~1GHz

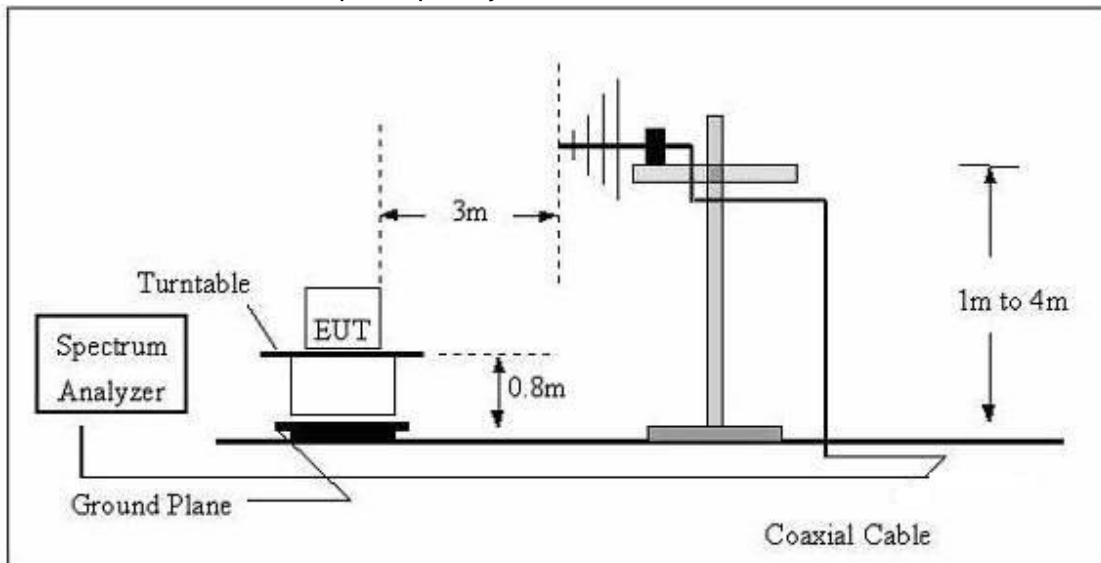

## (C) Radiated Emission Test-Up Frequency Above 1GHz

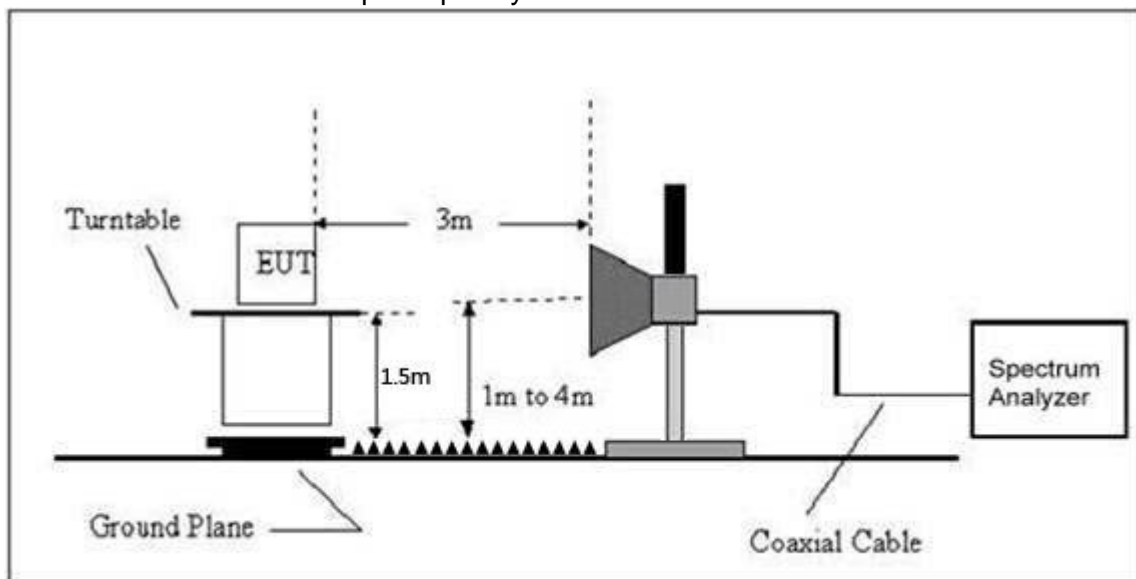

#### 4.2.5 EUT OPERATING CONDITIONS

The EUT tested system was configured as the statements of 2.4 Unless otherwise a special operating condition is specified in the follows during the testing.

**4.2.6 TEST RESULTS (BETWEEN 9KHZ – 30 MHZ)**

Temperature:	20°C	Relative Humidity:	48%
Pressure:	1010 hPa	Test Voltage :	DC 12.6V from Adapter DC 11.1V
Test Mode :	Mode 5	Polarization :	--

Freq. (MHz)	Reading (dBuV/m)	Limit (dBuV/m)	Margin (dB)	State P/F
--	--	--	--	PASS
--	--	--	--	PASS

**NOTE:**

The amplitude of spurious emissions which are attenuated by more than 20dB below the permissible value has no need to be reported.

Distance extrapolation factor =  $40 \log(\text{specific distance}/\text{test distance})$ (dB);

Limit line = specific limits(dBuv) + distance extrapolation factor.



**4.2.7 TEST RESULTS (BETWEEN 30MHZ – 1GHZ)**

Temperature :	26°C	Relative Humidity :	54%
Pressure :	1010 hPa	Polarization :	Vertical
Test Voltage :	DC 12.6V from Adapter		
Test Mode :	Mode 5		

All the modulation modes have been tested, and the worst result was report as below:

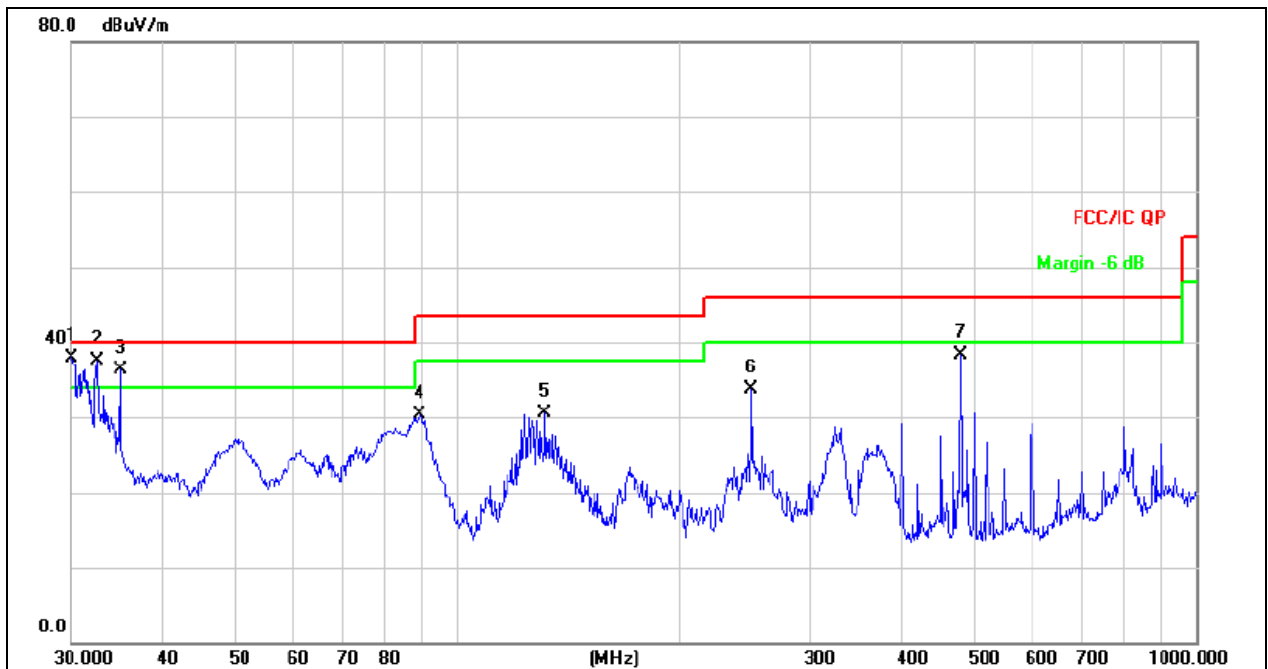

**Remark:**

Absolute Level= Reading Level+ Factor, Margin= Absolute Level - Limit

No.	Mk.	Freq.	Reading Level	Correct Factor	Measurement	Limit	Over	Antenna Height	Table Degree	
		MHz	dBuV	dB/m	dBuV/m	dBuV/m	dB	cm	degree	Comment
1	*	30.1054	46.02	-8.03	37.99	40.00	-2.01	QP		
2	!	32.5197	45.87	-8.36	37.51	40.00	-2.49	QP		
3	!	35.0048	44.73	-8.50	36.23	40.00	-3.77	QP		
4		88.9639	47.87	-17.63	30.24	43.50	-13.26	QP		
5		131.2965	44.55	-14.02	30.53	43.50	-12.97	QP		
6		250.3012	47.96	-14.19	33.77	46.00	-12.23	QP		
7		480.5276	46.80	-8.42	38.38	46.00	-7.62	QP		



Temperature :	26°C	Relative Humidity :	54%
Pressure :	1010 hPa	Polarization :	Horizontal
Test Voltage :	DC 12.6V from Adapter		
Test Mode :	Mode 5		

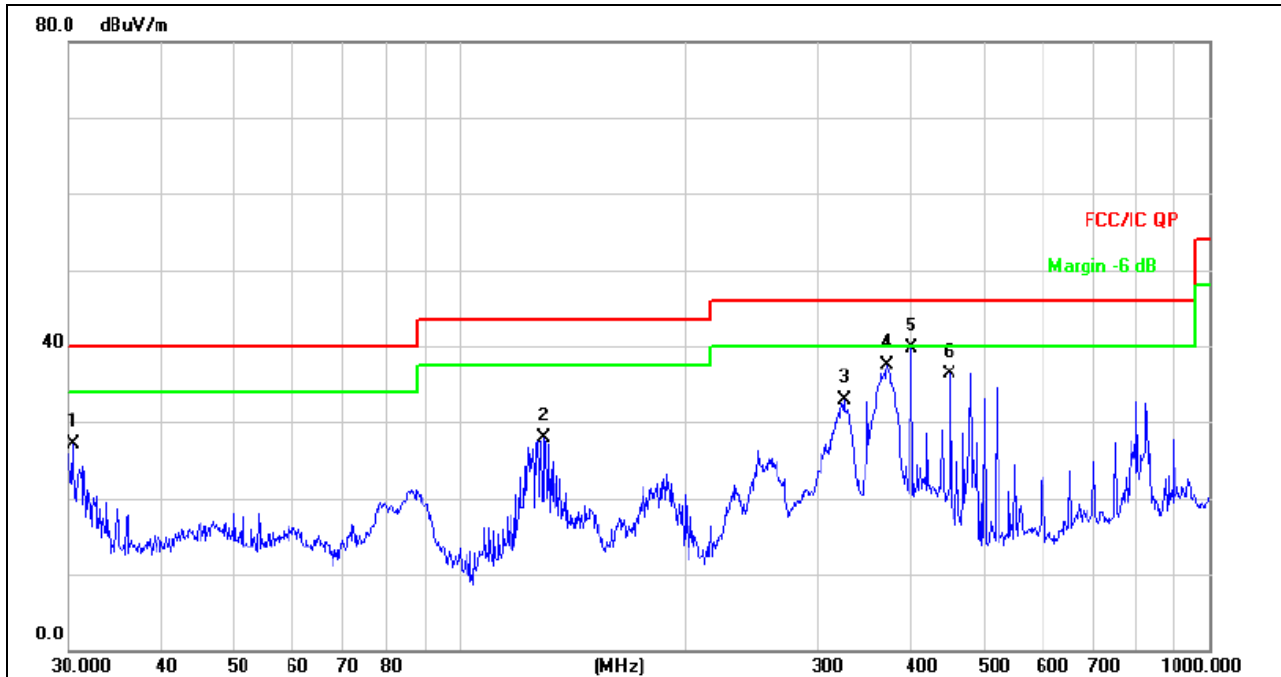

**Remark:**

Absolute Level= Reading Level+ Factor, Margin= Absolute Level - Limit

No.	Mk.	Freq.	Reading Level	Correct Factor	Measurement	Limit	Over	Antenna Height	Table Degree	
		MHz	dBuV	dB/m	dBuV/m	dBuV/m	dB	cm	degree	Comment
1		30.4238	35.24	-8.08	27.16	40.00	-12.84	QP		
2		129.4677	42.00	-14.14	27.86	43.50	-15.64	QP		
3		325.5958	44.77	-11.92	32.85	46.00	-13.15	QP		
4		372.0045	48.42	-10.88	37.54	46.00	-8.46	QP		
5	*	400.4319	49.94	-10.17	39.77	46.00	-6.23	QP		
6		451.1350	45.37	-9.00	36.37	46.00	-9.63	QP		



**4.2.8 TEST RESULTS (1GHZ~25GHZ)THE WORST RESULT WAS REPORT AS BELOW;**

**802.11b**

Polar (H/V)	Frequency	Meter Reading	Pre-amplifier	Cable Loss	Antenna Factor	Emission Level	Limits	Margin	Detector Type
	(MHz)	(dBuV)	(dB)	(dB)	(dB/m)	(dBuV/m)	(dBuV/m)	(dB)	
<b>operation frequency:2412</b>									
V	4824.00	65.63	39.55	7.85	25.66	59.59	74	-14.41	PK
V	4824.00	47.79	39.55	7.85	25.66	41.75	54	-12.25	AV
V	7236.00	66.67	38.33	7.52	24.55	60.41	74	-13.59	PK
V	7236.00	47.29	38.33	7.52	24.55	41.03	54	-12.97	AV
V	15450.00	50.31	35.23	6.75	26.59	48.42	74	-25.58	PK
H	4824.00	67.12	39.55	7.85	25.66	61.08	74	-12.92	PK
H	4824.00	48.25	39.55	7.85	25.66	42.21	54	-11.79	AV
H	7236.00	67.84	38.33	7.52	23.55	60.58	74	-13.42	PK
H	7236.00	51.47	38.33	7.52	23.22	43.88	54	-10.12	AV
H	15450.00	46.62	35.45	6.75	27.88	45.80	74	-28.20	PK
<b>operation frequency:2437</b>									
V	4874.00	63.97	38.89	7.57	25.45	58.10	74	-15.90	PK
V	4874.00	47.47	38.89	7.57	25.45	41.60	54	-12.40	AV
V	7311.00	65.07	38.78	7.35	24.78	58.42	74	-15.58	PK
V	7311.00	47.07	38.78	7.35	24.78	40.42	54	-13.58	AV
V	15450.00	51.09	35.89	6.42	26.47	48.09	74	-25.91	PK
H	4874.00	63.31	38.89	7.57	25.45	57.44	74	-16.56	PK
H	4874.00	48.34	38.89	7.57	25.45	42.47	54	-11.53	AV
H	7311.00	68.65	38.78	7.35	24.78	62.00	74	-12.00	PK
H	7311.00	47.62	38.78	7.35	24.78	40.97	54	-13.03	AV
H	15450.00	47.51	36.68	6.45	26.65	43.93	74	-30.07	PK
<b>operation frequency:2462</b>									
V	4924.00	66.71	38.75	7.46	25.45	60.87	74	-13.13	PK
V	4924.00	49.55	38.75	7.46	25.45	43.71	54	-10.29	AV
V	7386.00	66.11	38.65	7.22	24.78	59.46	74	-14.54	PK
V	7386.00	48.15	38.65	7.22	24.78	41.50	54	-12.50	AV
V	15450.00	52.32	35.58	6.35	26.47	49.56	74	-24.44	PK
H	4924.00	64.62	38.75	7.46	25.45	58.78	74	-15.22	PK
H	4924.00	49.16	38.75	7.46	25.45	43.32	54	-10.68	AV
H	7386.00	68.00	38.65	7.22	24.78	61.35	74	-12.65	PK
H	7386.00	47.06	38.65	7.22	24.78	40.41	54	-13.59	AV
H	15450.00	<b>49.26</b>	36.42	6.32	26.65	<b>45.81</b>	74	<b>-28.19</b>	PK

**Remark:**

1. Emission Level = Meter Reading + Antenna Factor + Cable Loss – Pre-amplifier, Margin= Emission Level - Limit
2. If peak below the average limit, the average emission was no test.
3. The amplitude of spurious emissions which are attenuated by more than 20dB below the permissible value has no need to be reported.



802.11g

Polar (H/V)	Frequency	Meter Reading	Pre-amplifier	Cable Loss	Antenna Factor	Emission Level	Limits	Margin	Detector Type
	(MHz)	(dBuV)	(dB)	(dB)	(dB/m)	(dBuV/m)	(dBuV/m)	(dB)	
<b>operation frequency:2412</b>									
V	4824.00	64.48	39.55	7.85	25.66	58.44	74	-15.56	PK
V	4824.00	48.27	39.55	7.85	25.66	42.23	54	-11.77	AV
V	7236.00	64.65	38.33	7.52	24.55	58.39	74	-15.61	PK
V	7236.00	46.42	38.33	7.52	24.55	40.16	54	-13.84	AV
V	15450.00	49.61	35.23	6.75	26.59	47.72	74	-26.28	PK
H	4824.00	61.59	39.55	7.85	25.66	55.55	74	-18.45	PK
H	4824.00	48.18	39.55	7.85	25.66	42.14	54	-11.86	AV
H	7236.00	67.53	38.33	7.52	23.55	60.27	74	-13.73	PK
H	7236.00	49.15	38.33	7.52	23.22	41.56	54	-12.44	AV
H	15450.00	44.58	35.45	6.75	27.88	43.76	74	-30.24	PK
<b>operation frequency:2437</b>									
V	4874.00	66.24	38.89	7.57	25.45	60.37	74	-13.63	PK
V	4874.00	48.93	38.89	7.57	25.45	43.06	54	-10.94	AV
V	7311.00	67.10	38.78	7.35	24.78	60.45	74	-13.55	PK
V	7311.00	47.44	38.78	7.35	24.78	40.79	54	-13.21	AV
V	15450.00	52.50	35.89	6.42	26.47	49.50	74	-24.50	PK
H	4874.00	64.91	38.89	7.57	25.45	59.04	74	-14.96	PK
H	4874.00	49.16	38.89	7.57	25.45	43.29	54	-10.71	AV
H	7311.00	68.87	38.78	7.35	24.78	62.22	74	-11.78	PK
H	7311.00	47.96	38.78	7.35	24.78	41.31	54	-12.69	AV
H	15450.00	49.04	36.68	6.42	26.65	45.43	74	-28.57	PK
<b>operation frequency:2462</b>									
V	4924.00	64.92	38.75	7.46	25.45	59.08	74	-14.92	PK
V	4924.00	47.96	38.75	7.46	25.45	42.12	54	-11.88	AV
V	7386.00	65.76	38.65	7.22	24.78	59.11	74	-14.89	PK
V	7386.00	46.50	38.65	7.22	24.78	39.85	54	-14.15	AV
V	15450.00	51.46	35.58	6.35	26.47	48.70	74	-25.30	PK
H	4924.00	63.62	38.75	7.46	25.45	57.78	74	-16.22	PK
H	4924.00	48.18	38.75	7.46	25.45	42.34	54	-11.66	AV
H	7386.00	67.50	38.65	7.22	24.78	60.85	74	-13.15	PK
H	7386.00	47.01	38.65	7.22	24.78	40.36	54	-13.64	AV
H	15450.00	48.06	36.42	6.32	26.65	44.61	74	-29.39	PK
<b>Remark:</b> 1. Emission Level = Meter Reading + Antenna Factor + Cable Loss – Pre-amplifier, Margin= Emission Level - Limit 2. If peak below the average limit, the average emission was no test. 3. The amplitude of spurious emissions which are attenuated by more than 20dB below the permissible value has no need to be reported.									



802.11n(20MHz)

Polar (H/V)	Frequency	Meter Reading	Pre-amplifier	Cable Loss	Antenna Factor	Emission Level	Limits	Margin	Detector Type
	(MHz)	(dBuV)	(dB)	(dB)	(dB/m)	(dBuV/m)	(dBuV/m)	(dB)	
<b>operation frequency:2412</b>									
V	4824.00	66.13	39.55	7.85	25.66	60.09	74	-13.91	PK
V	4824.00	47.50	39.55	7.85	25.66	41.46	54	-12.54	AV
V	7236.00	66.80	38.33	7.52	24.55	60.54	74	-13.46	PK
V	7236.00	47.37	38.33	7.52	24.55	41.11	54	-12.89	AV
V	15450.00	50.53	35.23	6.75	26.59	48.64	74	-25.36	PK
H	4824.00	66.70	39.55	7.85	25.66	60.66	74	-13.34	PK
H	4824.00	48.44	39.55	7.85	25.66	42.40	54	-11.60	AV
H	7236.00	67.69	38.33	7.52	23.55	60.43	74	-13.57	PK
H	7236.00	51.21	38.33	7.52	23.22	43.62	54	-10.38	AV
H	15450.00	46.69	35.45	6.75	27.88	45.87	74	-28.13	PK
<b>operation frequency:2437</b>									
V	4874.00	65.11	38.89	7.57	25.45	59.24	74	-14.76	PK
V	4874.00	48.44	38.89	7.57	25.45	42.57	54	-11.43	AV
V	7311.00	65.75	38.78	7.35	24.78	59.10	74	-14.90	PK
V	7311.00	46.30	38.78	7.35	24.78	39.65	54	-14.35	AV
V	15450.00	51.09	35.89	6.42	26.47	48.09	74	-25.91	PK
H	4874.00	64.00	38.89	7.57	25.45	58.13	74	-15.87	PK
H	4874.00	48.46	38.89	7.57	25.45	42.59	54	-11.41	AV
H	7311.00	68.07	38.78	7.35	24.78	61.42	74	-12.58	PK
H	7311.00	47.63	38.78	7.35	24.78	40.98	54	-13.02	AV
H	15450.00	48.43	36.68	6.42	26.65	44.82	74	-29.18	PK
<b>operation frequency:2462</b>									
V	4924.00	67.11	38.75	7.46	25.45	61.27	74	-12.73	PK
V	4924.00	49.16	38.75	7.46	25.45	43.32	54	-10.68	AV
V	7386.00	66.13	38.65	7.22	24.78	59.48	74	-14.52	PK
V	7386.00	48.37	38.65	7.22	24.78	41.72	54	-12.28	AV
V	15450.00	52.09	35.58	6.35	26.47	49.33	74	-24.67	PK
H	4924.00	65.17	38.75	7.46	25.45	59.33	74	-14.67	PK
H	4924.00	49.30	38.75	7.46	25.45	43.46	54	-10.54	AV
H	7386.00	67.61	38.65	7.22	24.78	60.96	74	-13.04	PK
H	7386.00	47.20	38.65	7.22	24.78	40.55	54	-13.45	AV
H	15450.00	48.95	36.42	6.32	26.65	45.50	74	-28.50	PK
<b>Remark:</b>									
1. Emission Level = Meter Reading + Antenna Factor + Cable Loss – Pre-amplifier, Margin= Emission Level - Limit									
2. If peak below the average limit, the average emission was no test.									
3. The amplitude of spurious emissions which are attenuated by more than 20dB below the permissible value has no need to be reported.									



802.11n(40MHz)

Polar (H/V)	Frequency	Meter Reading	Pre-amplifier	Cable Loss	Antenna Factor	Emission Level	Limits	Margin	Detector Type
	(MHz)	(dBuV)	(dB)	(dB)	(dB/m)	(dBuV/m)	(dBuV/m)	(dB)	
<b>operation frequency:2422</b>									
V	4844.000	67.47	39.55	7.77	25.66	61.35	74	-12.65	PK
V	4844.000	47.88	39.55	7.77	25.66	41.76	54	-12.24	AV
V	7266.000	66.47	38.33	7.30	24.55	59.99	74	-14.01	PK
V	7266.000	47.59	38.33	7.30	24.55	41.11	54	-12.89	AV
V	15450.00	50.93	35.23	6.60	26.59	48.89	74	-25.11	PK
H	4844.000	67.68	39.55	7.77	25.66	61.56	74	-12.44	PK
H	4844.000	48.59	39.55	7.77	25.66	42.47	54	-11.53	AV
H	7266.000	68.64	38.33	7.30	23.55	61.16	74	-12.84	PK
H	7266.000	51.71	38.33	7.30	23.22	43.90	54	-10.10	AV
H	15450.00	47.66	35.45	6.60	27.88	46.69	74	-27.31	PK
<b>operation frequency:2437</b>									
V	4874.00	65.70	38.89	7.57	25.45	59.83	74	-14.17	PK
V	4874.00	48.88	38.89	7.57	25.45	43.01	54	-10.99	AV
V	7311.00	66.58	38.78	7.35	24.78	59.93	74	-14.07	PK
V	7311.00	46.99	38.78	7.35	24.78	40.34	54	-13.66	AV
V	15450.00	51.52	35.89	6.42	26.47	48.52	74	-25.48	PK
H	4874.00	64.18	38.89	7.57	25.45	58.31	74	-15.69	PK
H	4874.00	48.88	38.89	7.57	25.45	43.01	54	-10.99	AV
H	7311.00	68.84	38.78	7.35	24.78	62.19	74	-11.81	PK
H	7311.00	47.47	38.78	7.35	24.78	40.82	54	-13.18	AV
H	15450.00	48.67	36.68	6.42	26.65	45.06	74	-28.94	PK
<b>operation frequency:2452</b>									
V	4904.00	67.48	38.75	7.38	25.45	61.56	74	-12.44	PK
V	4904.00	49.55	38.75	7.38	25.45	43.63	54	-10.37	AV
V	7356.00	66.56	38.65	7.15	24.78	59.84	74	-14.16	PK
V	7356.00	49.15	38.65	7.15	24.78	42.43	54	-11.57	AV
V	15450.00	52.59	35.58	6.25	26.47	49.73	74	-24.27	PK
H	4904.00	65.66	38.75	7.38	25.45	59.74	74	-14.26	PK
H	4904.00	50.13	38.75	7.38	25.45	44.21	54	-9.79	AV
H	7356.00	68.65	38.65	7.15	24.78	61.93	74	-12.07	PK
H	7356.00	47.79	38.65	7.15	24.78	41.07	54	-12.93	AV
H	15450.00	49.57	36.42	6.25	26.65	46.05	74	-27.95	PK

**Remark:**

1. Emission Level = Meter Reading + Antenna Factor + Cable Loss – Pre-amplifier,  
Margin= Emission Level - Limit
2. If peak below the average limit, the average emission was no test.
3. The amplitude of spurious emissions which are attenuated by more than 20dB below the permissible value has no need to be reported.





For Conducted

we pretest all mode, the worst mode was 802.11b, and the data only show the worst mode data.

802.11b  
2412MHz

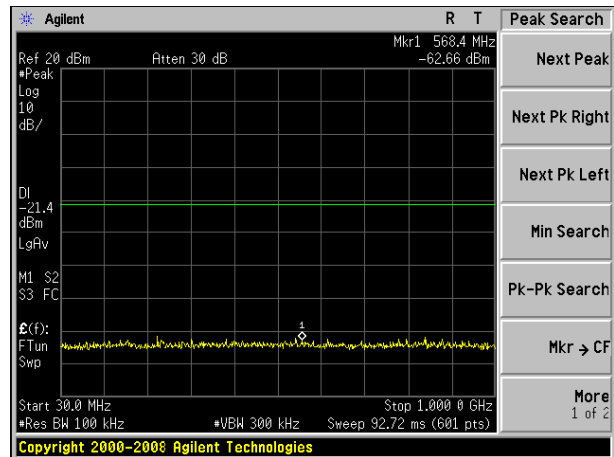
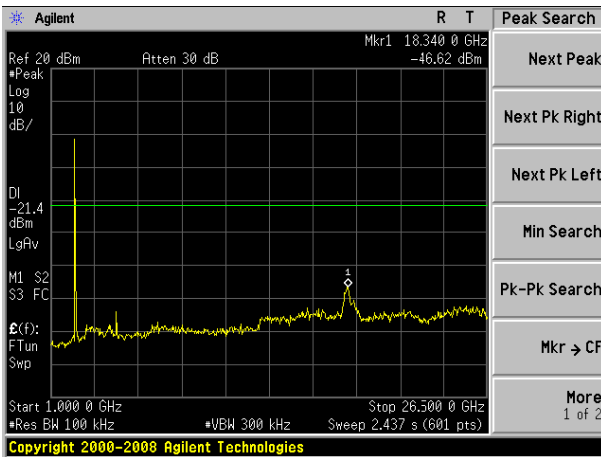

2437MHz

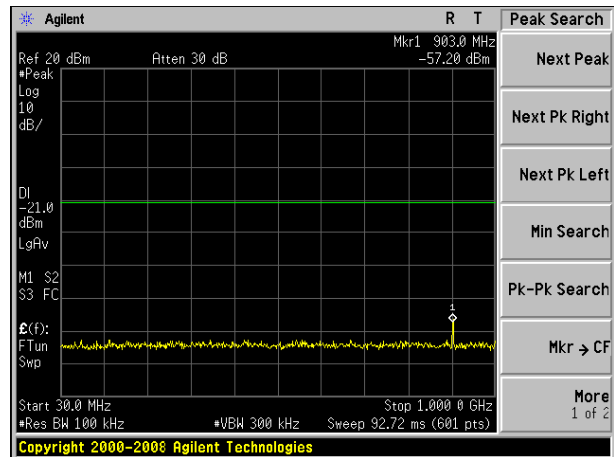
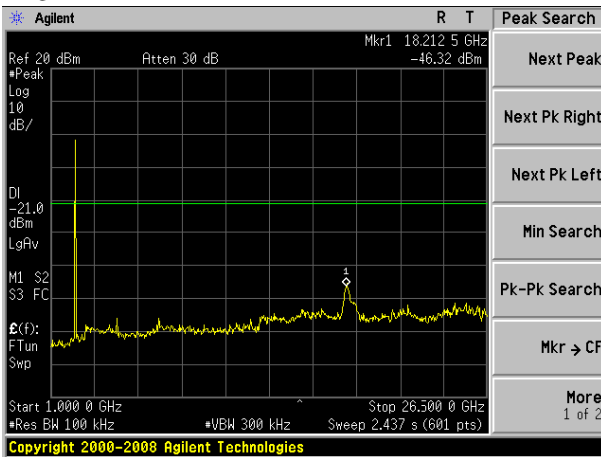

2462MHz

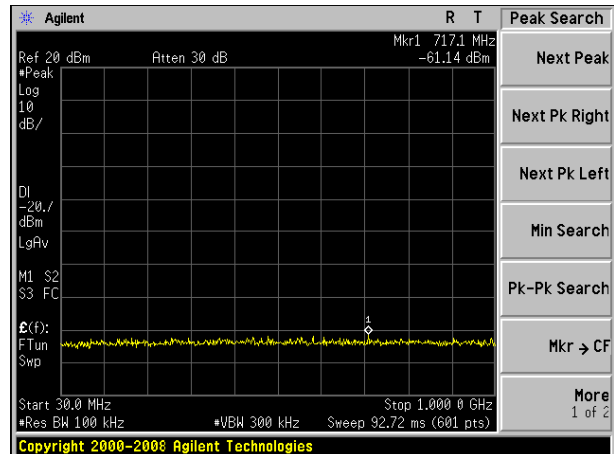
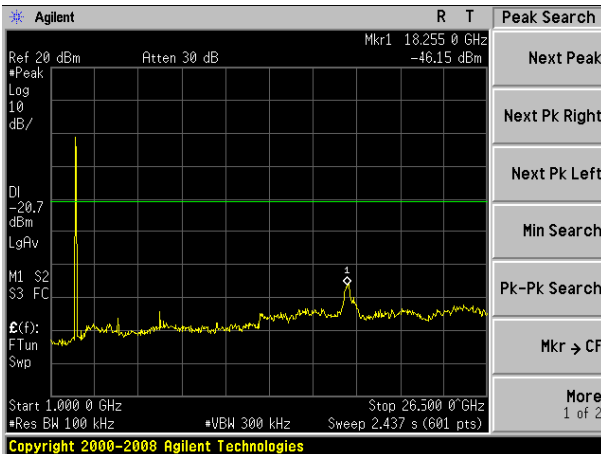



### 3.3 RADIATED BAND EMISSION MEASUREMENT

#### 3.3.1 TEST REQUIREMENT:

RSS-247 5.5

LIMITS OF RADIATED EMISSION MEASUREMENT (Above 1000MHz)

FREQUENCY (MHz)	Limit(dBuV/m) (at 3M)	
	PEAK	AVERAGE
Above 1000	74	54

Notes:

- (1) The limit for radiated test was performed according to FCC PART 15C.
- (2) The tighter limit applies at the band edges.
- (3) Emission level (dBuV/m)=20log Emission level (uV/m).

Spectrum Parameter	Setting
Attenuation	Auto
Start Frequency	2300MHz
Stop Frequency	2520
RB / VB (emission in restricted band)	1 MHz / 1 MHz for Peak, 1 MHz / 10Hz for Average

#### 3.3.2 TEST PROCEDURE

Above 1GHz test procedure as below:

- a. 1. The EUT was placed on the top of a rotating table 1.5 meters above the ground at a 3 meter camber. The table was rotated 360 degrees to determine the position of the highest radiation.
- b. The EUT was set 3 meters away from the interference-receiving antenna, which was mounted on the top of a variable-height antenna tower.
- c. The antenna height is varied from one meter to four meters above the ground to determine the maximum value of the field strength. Both horizontal and vertical polarizations of the antenna are set to make the measurement.
- d. For each suspected emission, the EUT was arranged to its worst case and then the antenna was tuned to heights from 1 meter to 4 meters and the rota table was turned from 0 degrees to 360 degrees to find the maximum reading.
- e. The test-receiver system was set to Peak Detect Function and Specified Bandwidth with Maximum Hold Mode.
- f. If the emission level of the EUT in peak mode was 10dB lower than the limit specified, then testing could be stopped and the peak values of the EUT would be reported. Otherwise the emissions that did not have 10dB margin would be re-tested one by one using peak, quasi-peak or average method as specified and then reported in a data sheet.
- g. Test the EUT in the lowest channel,the Highest channel

Note:

Both horizontal and vertical antenna polarities were tested and performed pretest to three orthogonal axis. The worst case emissions were reported

### 3.3.3 DEVIATION FROM TEST STANDARD

No deviation

### 3.3.4 TEST SETUP

Radiated Emission Test-Up Frequency Above 1GHz

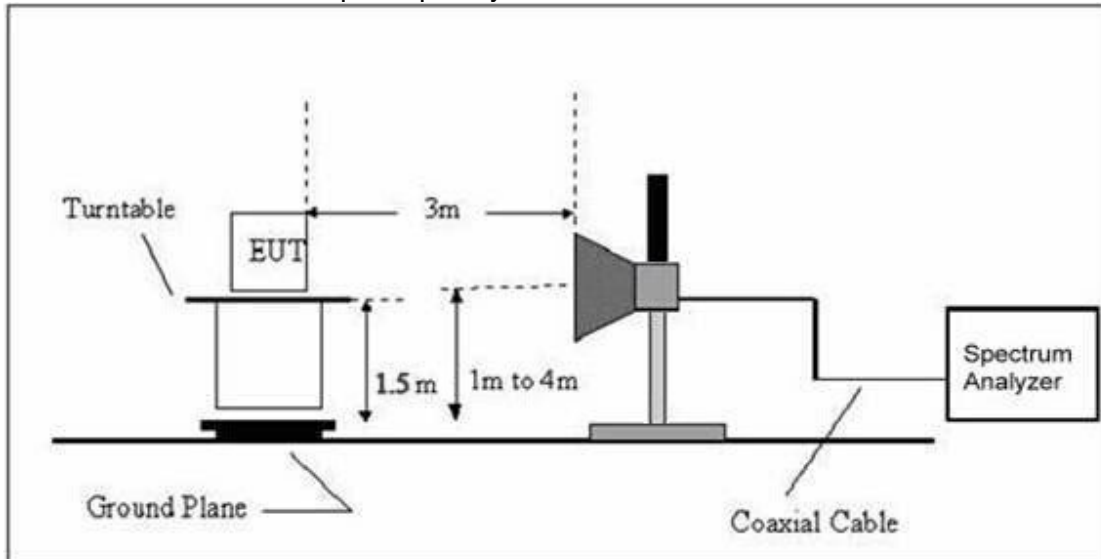

### 3.3.5 EUT OPERATING CONDITIONS

The EUT tested system was configured as the statements of 2.3 Unless otherwise a special operating condition is specified in the follows during the testing.



**3.3.6 TEST RESULT**

Polar (H/V)	Frequency	Meter Reading	Pre-amplifier	Cable Loss	Antenna Factor	Emission level	Limits	Margin	Detector Type
	(MHz)	(dBuV)	(dB)	(dB)	(dB/m)	(dBuV/m)	(dBuV/m)	(dB)	
<b>802.11b operation frequency:2412</b>									
V	2390.00	66.51	38.06	7.42	20.15	56.02	74	-17.98	PK
V	2390.00	55.28	38.06	7.42	20.15	44.79	54	-9.21	AV
V	2400.00	66.74	38.06	7.42	20.15	56.25	74	-17.75	PK
V	2400.00	54.84	38.06	7.42	20.15	44.35	54	-9.65	AV
H	2390.00	66.81	38.06	7.42	20.15	56.32	74	-17.68	PK
H	2390.00	55.31	38.06	7.42	20.15	44.82	54	-9.18	AV
H	2400.00	66.67	38.06	7.42	20.15	56.18	74	-17.82	PK
H	2400.00	55.24	38.06	7.42	20.15	44.75	54	-9.25	AV
<b>802.11b operation frequency:2462</b>									
V	2483.50	66.74	38.17	7.42	20.51	56.50	74	-17.50	PK
V	2483.50	55.51	38.17	7.42	20.51	45.27	54	-8.73	AV
V	2500.00	66.66	38.20	7.45	20.54	56.45	74	-17.55	PK
V	2500.00	54.94	38.20	7.45	20.54	44.73	54	-9.27	AV
H	2483.50	66.85	38.17	7.42	20.51	56.61	74	-17.39	PK
H	2483.50	55.55	38.17	7.42	20.51	45.31	54	-8.69	AV
H	2500.00	66.46	38.20	7.45	20.54	56.25	74	-17.75	PK
H	2500.00	55.80	38.20	7.45	20.54	45.59	54	-8.41	AV
<b>802.11g operation frequency:2412</b>									
V	2390.00	66.51	38.06	7.42	20.15	56.02	74	-17.98	PK
V	2390.00	55.26	38.06	7.42	20.15	44.77	54	-9.23	AV
V	2400.00	66.72	38.06	7.42	20.15	56.23	74	-17.77	PK
V	2400.00	54.84	38.06	7.42	20.15	44.35	54	-9.65	AV
H	2390.00	66.79	38.06	7.42	20.15	56.30	74	-17.70	PK
H	2390.00	55.29	38.06	7.42	20.15	44.80	54	-9.20	AV
H	2400.00	66.67	38.06	7.42	20.15	56.18	74	-17.82	PK
H	2400.00	55.22	38.06	7.42	20.15	44.73	54	-9.27	AV
<b>802.11g operation frequency:2462</b>									
V	2483.50	66.72	38.17	7.42	20.51	56.48	74	-17.52	PK
V	2483.50	55.49	38.17	7.42	20.51	45.25	54	-8.75	AV
V	2500.00	66.66	38.20	7.45	20.54	56.45	74	-17.55	PK
V	2500.00	54.94	38.20	7.45	20.54	44.73	54	-9.27	AV
H	2483.50	66.83	38.17	7.42	20.51	56.59	74	-17.41	PK
H	2483.50	55.53	38.17	7.42	20.51	45.29	54	-8.71	AV
H	2500.00	66.46	38.20	7.45	20.54	56.25	74	-17.75	PK
H	2500.00	55.80	38.20	7.45	20.54	45.59	54	-8.41	AV

**Remark:**

1. Emission Level = Meter Reading + Factor, Margin= Emission Level - Limit
2. If peak below the average limit, the average emission was no test.
3. The amplitude of spurious emissions which are attenuated by more than 20dB below the permissible value has no need to be reported.



Polar (H/V)	Frequency	Meter Reading	Pre-amplifier	Cable Loss	Antenna Factor	Emission level	Limits	Margin	Detector Type
	(MHz)	(dBuV)	(dB)	(dB)	(dB/m)	(dBuV/m)	(dBuV/m)	(dB)	
<b>802.11n(20MHz) operation frequency:2412</b>									
V	2390.00	66.38	38.06	7.42	20.15	55.89	74	-18.11	PK
V	2390.00	55.17	38.06	7.42	20.15	44.68	54	-9.32	AV
V	2400.00	66.61	38.06	7.42	20.15	56.12	74	-17.88	PK
V	2400.00	54.73	38.06	7.42	20.15	44.24	54	-9.76	AV
H	2390.00	66.69	38.06	7.42	20.15	56.20	74	-17.80	PK
H	2390.00	55.20	38.06	7.42	20.15	44.71	54	-9.29	AV
H	2400.00	66.54	38.06	7.42	20.15	56.05	74	-17.95	PK
H	2400.00	55.13	38.06	7.42	20.15	44.64	54	-9.36	AV
<b>802.11n(20MHz) operation frequency:2462</b>									
V	2483.50	66.61	38.17	7.42	20.51	55.89	74	-18.11	PK
V	2483.50	55.41	38.17	7.42	20.51	44.68	54	-9.32	AV
V	2500.00	66.53	38.20	7.45	20.54	56.12	74	-17.88	PK
V	2500.00	54.84	38.20	7.45	20.54	44.24	54	-9.76	AV
H	2483.50	66.73	38.17	7.42	20.51	56.2	74	-17.80	PK
H	2483.50	55.44	38.17	7.42	20.51	44.71	54	-9.29	AV
H	2500.00	66.33	38.20	7.45	20.54	56.05	74	-17.95	PK
H	2500.00	55.69	38.20	7.45	20.54	44.64	54	-9.36	AV
<b>802.11n(40MHz) operation frequency:2422</b>									
V	2390.00	66.25	38.06	7.42	20.15	55.89	74	-18.11	PK
V	2390.00	55.04	38.06	7.42	20.15	44.68	54	-9.32	AV
V	2400.00	66.46	38.06	7.42	20.15	56.12	74	-17.88	PK
V	2400.00	54.62	38.06	7.42	20.15	44.24	54	-9.76	AV
H	2390.00	66.54	38.06	7.42	20.15	56.2	74	-17.80	PK
H	2390.00	55.07	38.06	7.42	20.15	44.71	54	-9.29	AV
H	2400.00	66.41	38.06	7.42	20.15	56.05	74	-17.95	PK
H	2400.00	55.00	38.06	7.42	20.15	44.64	54	-9.36	AV
<b>802.11n(40MHz) operation frequency:2452</b>									
V	2483.50	66.46	38.17	7.42	20.51	55.89	74	-18.11	PK
V	2483.50	55.28	38.17	7.42	20.51	44.68	54	-9.32	AV
V	2500.00	66.40	38.20	7.45	20.54	56.12	74	-17.88	PK
V	2500.00	54.73	38.20	7.45	20.54	44.24	54	-9.76	AV
H	2483.50	66.58	38.17	7.42	20.51	56.2	74	-17.80	PK
H	2483.50	55.32	38.17	7.42	20.51	44.71	54	-9.29	AV
H	2500.00	66.21	38.20	7.45	20.54	56.05	74	-17.95	PK
H	2500.00	55.58	38.20	7.45	20.54	44.64	54	-9.36	AV

**Remark:**

1. Emission Level = Meter Reading + Factor, Margin= Emission Level - Limit
2. If peak below the average limit, the average emission was no test.
3. The amplitude of spurious emissions which are attenuated by more than 20dB below the permissible value has no need to be reported.

**5. 6DB BANDWIDTH**

**5.1 APPLIED PROCEDURES / LIMIT**

FCC Part15 (15.247) , Subpart C				
Section	Test Item	Limit	Frequency Range (MHz)	Result
15.247(a)(2)	Bandwidth	>= 500KHz (6dB bandwidth)	2400-2483.5	PASS

**5.1.1 TEST PROCEDURE**

1. Set RBW = 100 kHz.
2. Set the video bandwidth (VBW) ≥ 3 x RBW.
3. Detector = Peak.
4. Trace mode = max hold.
5. Sweep = auto couple.
6. Allow the trace to stabilize.
7. Measure the maximum width of the emission that is constrained by the frequencies associated with the two outermost amplitude points (upper and lower frequencies) that are attenuated by 6 dB relative to the maximum level measured in the fundamental emission.

**5.1.2 DEVIATION FROM STANDARD**

No deviation.

**5.1.3 TEST SETUP**



**5.1.4 EUT OPERATION CONDITIONS**

The EUT tested system was configured as the statements of 2.4 Unless otherwise a special operating condition is specified in the follows during the testing.



### 5.1.5 TEST RESULTS

#### 802.11b Mode

Channel	Frequency (MHz)	6dB bandwidth (MHz)	Limit (kHz)	Result
Low	2412	10.109	500	Pass
Middle	2437	10.108	500	Pass
High	2462	10.100	500	Pass

#### 802.11g Mode

Channel	Frequency (MHz)	6dB bandwidth (MHz)	Limit (kHz)	Result
Low	2412	16.627	500	Pass
Middle	2437	16.626	500	Pass
High	2462	16.625	500	Pass

#### 802.11n20 Mode

Channel	Frequency (MHz)	6dB bandwidth (MHz)	Limit (kHz)	Result
Low	2412	17.846	500	Pass
Middle	2437	17.865	500	Pass
High	2462	17.848	500	Pass

#### 802.11n40 Mode

Channel	Frequency (MHz)	6dB bandwidth (MHz)	Limit (kHz)	Result
Low	2422	36.568	500	Pass
Middle	2437	36.552	500	Pass
High	2452	36.541	500	Pass



(802.11b) 6dB Bandwidth plot on channel 1



(802.11g) 6dB Bandwidth plot on channel 1

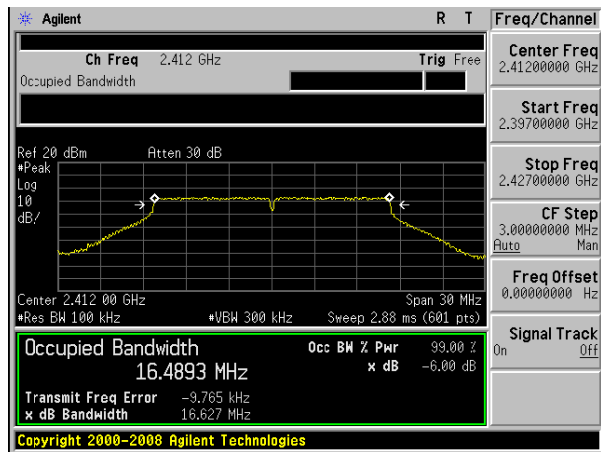

(802.11b) 6dB Bandwidth plot on channel 6

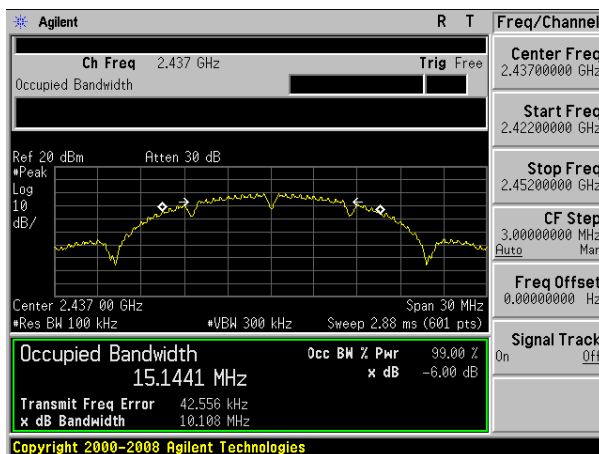

(802.11g) 6dB Bandwidth plot on channel 6

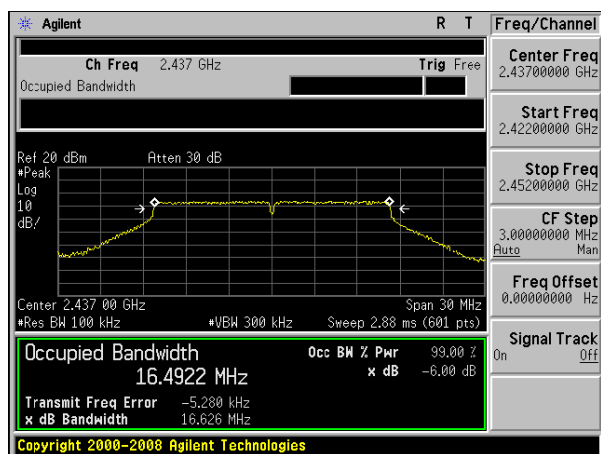

(802.11b) 6dB Bandwidth plot on channel 11

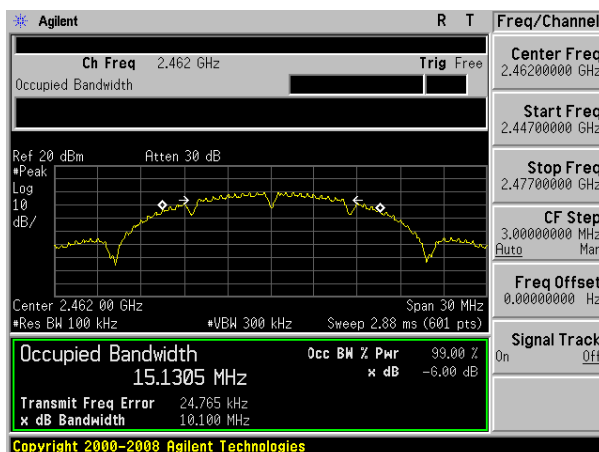

(802.11g) 6dB Bandwidth plot on channel 11

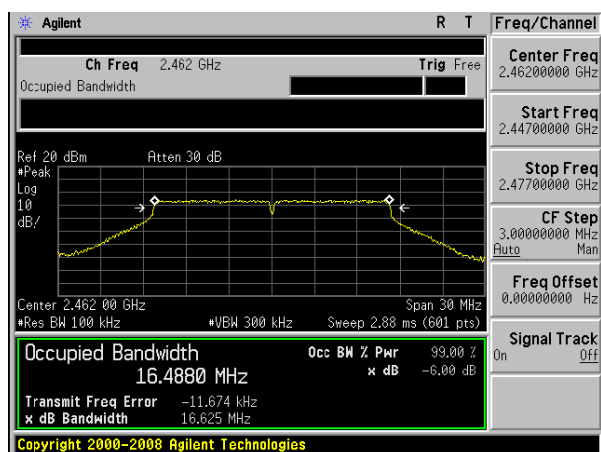





(802.11n20) 6dB Bandwidth plot on channel 1

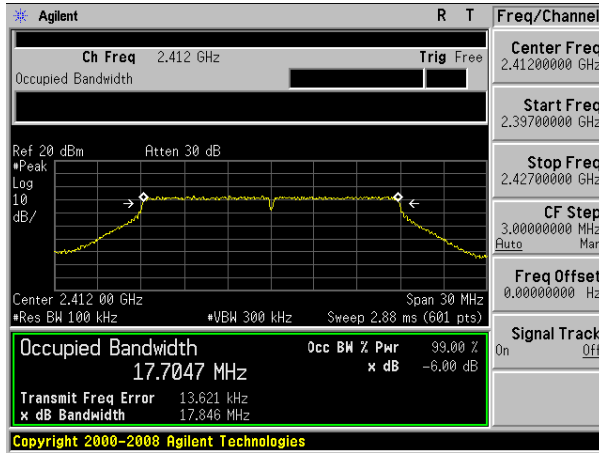

(802.11n40) 6dB Bandwidth plot on channel 3

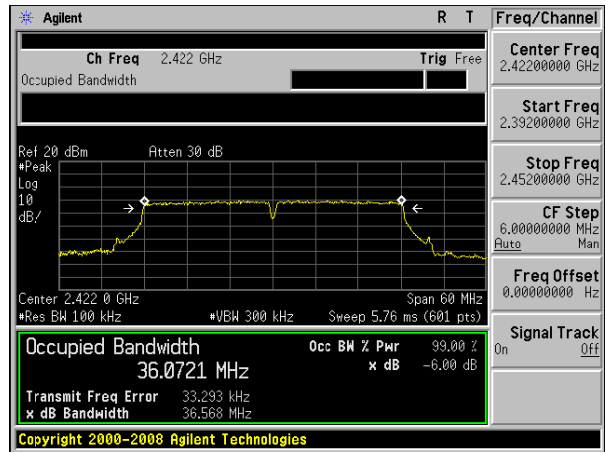

(802.11n20) 6dB Bandwidth plot on channel 6

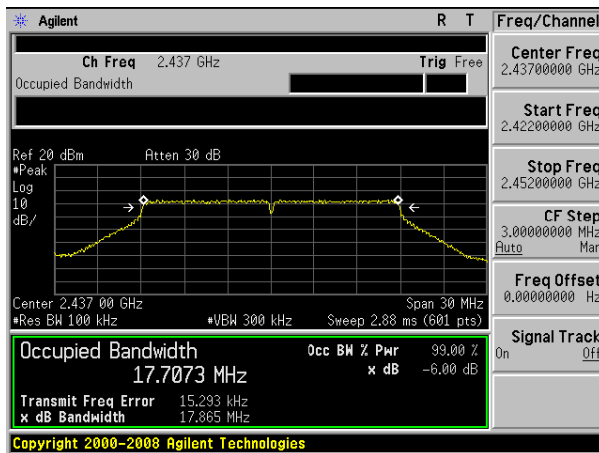

(802.11n40) 6dB Bandwidth plot on channel 6

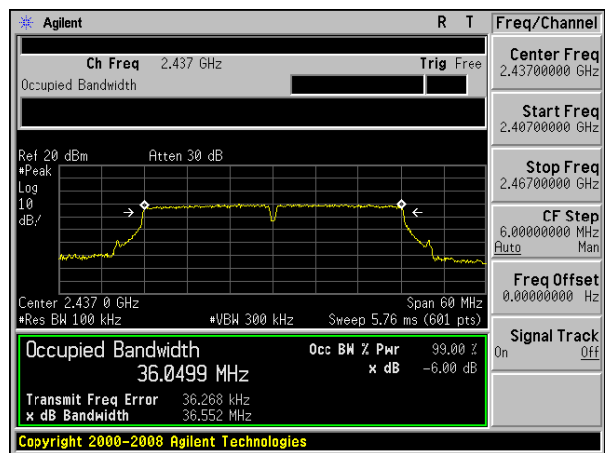

(802.11n20) 6dB Bandwidth plot on channel 11

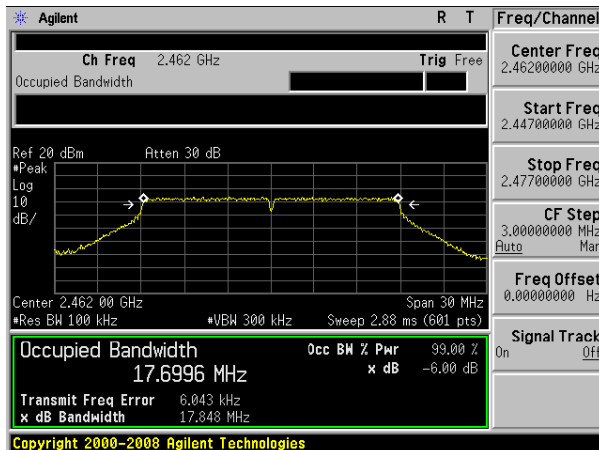

(802.11n40) 6dB Bandwidth plot on channel 9

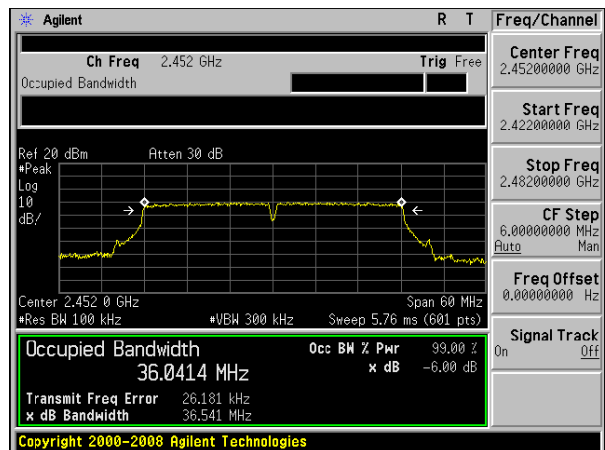



## 6. DUTY CYCLE

### 6.1 APPLICABLE STANDARD

According to KDB 558074)6)b), issued 06/09/2015

### 6.2 CONFORMANCE LIMIT

No limit requirement.

### 6.3 MEASURING INSTRUMENTS

The Measuring equipment is listed in the section 6.3 of this test report.

### 6.4 TEST SETUP

Please refer to Section 6.1 of this test report.

### 6.5 TEST PROCEDURE

The zero-span mode on a spectrum analyzer or EMI receiver if the response time and spacing between bins on the sweep are sufficient to permit accurate measurements of the on and off times of the transmitted signal. Set the center frequency of the instrument to the center frequency of the transmission. Set  $RBW \geq OBW$  if possible; otherwise, set RBW to the largest available value. Set  $VBW \geq RBW$ . Set detector = peak or average. The zero-span measurement method shall not be used unless both RBW and VBW are  $> 50/T$  and the number of sweep points across duration T exceeds 100. (For example, if VBW and/or RBW are limited to 3 MHz, then the zero-span method of measuring duty cycle shall not be used if  $T \leq 16.7$  microseconds.)

The transmitter output is connected to the Spectrum Analyzer. We tested according to the zero-span measurement method, 6.0)b) in KDB 558074(issued 06/09/2015)

The largest available value of RBW is 8 MHz and VBW is 50 MHz. The zero-span method of measuring duty cycle shall not be used if  $T \leq 6.25$  microseconds. ( $50/6.25 = 8$ )

The zero-span method was used because all measured T data are  $> 6.25$  microseconds and both RBW and VBW are  $> 50/T$ .

The RF output of EUT was connected to the spectrum analyzer by RF cable and attenuator.

The path loss was compensated to the results for each measurement.

Set to the maximum power setting and enable the EUT transmit continuously.

The EUT was operating in controlled its channel.

Use the following spectrum analyzer settings:

Span = Zero Span

RBW = 8MHz(the largest available value)

VBW = 8MHz ( $\geq$  RBW)

Number of points in Sweep  $> 100$

Detector function = peak

Trace = Clear write

Measure  $T_{total}$  and  $T_{on}$

Calculate Duty Cycle =  $T_{on} / T_{total}$  and Duty Cycle Factor =  $10 * \log(1/Duty\ Cycle)$

### 6.6 TEST RESULTS

Mode	Data rate	Channel	$T_{on}$	$T_{total}$	Duty Cycle %	Duty Cycle Factor (dB)	1/T Minimum VBW (kHz)
802.11b	1Mbps	6	10	10	100	0.00	0.01
802.11g	6Mbps	6	10	10	100	0.00	0.01
802.11n HT20	MCS0	6	10	10	100	0.00	0.01
802.11n HT40	MCS0	6	10	10	100	0.00	0.01

## 7. POWER SPECTRAL DENSITY TEST

### 7.1 APPLIED PROCEDURES / LIMIT

FCC Part15 (15.247) , Subpart C				
Section	Test Item	Limit	Frequency Range (MHz)	Result
15.247	Power Spectral Density	8 dBm (in any 3KHz)	2400-2483.5	PASS

#### 7.1.1 TEST PROCEDURE

1. Set analyzer center frequency to DTS channel center frequency.
2. Set the span to 1.5 times the DTS bandwidth.
3. Set the RBW to:  $3 \text{ kHz} \leq \text{RBW} \leq 100 \text{ kHz}$ .
4. Set the VBW  $\geq 3 \times \text{RBW}$ .
5. Detector = peak.
6. Sweep time = auto couple.
7. Trace mode = max hold.
8. Allow trace to fully stabilize.
9. Use the peak marker function to determine the maximum amplitude level within the RBW.
10. If measured value exceeds limit, reduce RBW (no less than 3 kHz) and repeat.

#### 7.1.2 DEVIATION FROM STANDARD

No deviation.

#### 7.1.3 TEST SETUP



#### 7.1.4 EUT OPERATION CONDITIONS

The EUT tested system was configured as the statements of 2.1 Unless otherwise a special operating condition is specified in the follows during the testing.

**7.1.5 TEST RESULTS**

Temperature :	25°C	Relative Humidity :	60%
Pressure :	1015 hPa	Test Voltage :	DC 11.7V
Test Mode :	TX Mode		

Frequency	Power Spectral Density(dBm)	Limit (dBm)	Result
<b>802.11b</b>			
2412 MHz	-11.58	0	PASS
2437 MHz	-10.97	0	PASS
2462 MHz	-12.15	0	PASS
<b>802.11g</b>			
2412 MHz	-14.33	0	PASS
2437 MHz	-15.01	0	PASS
2462 MHz	-12.82	0	PASS
<b>802.11n(20MHz)</b>			
2412 MHz	-14.67	0	PASS
2437 MHz	-13.98	0	PASS
2462 MHz	-12.94	0	PASS
<b>802.11n(40MHz)</b>			
2422 MHz	-15.03	0	PASS
2437 MHz	-14.96	0	PASS
2452 MHz	-15.04	0	PASS



(802.11b) PSD plot on channel 1

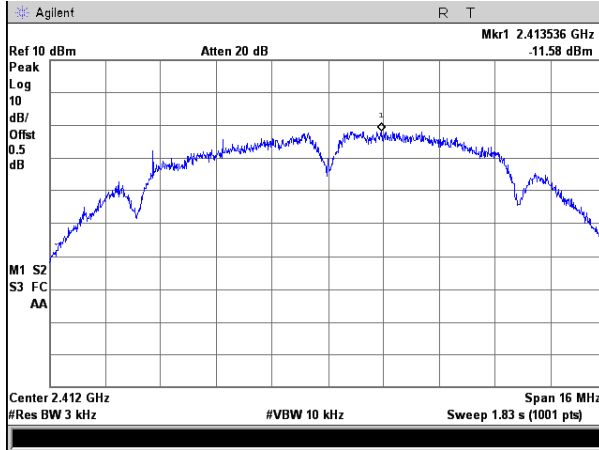

(802.11g) PSD plot on channel 1

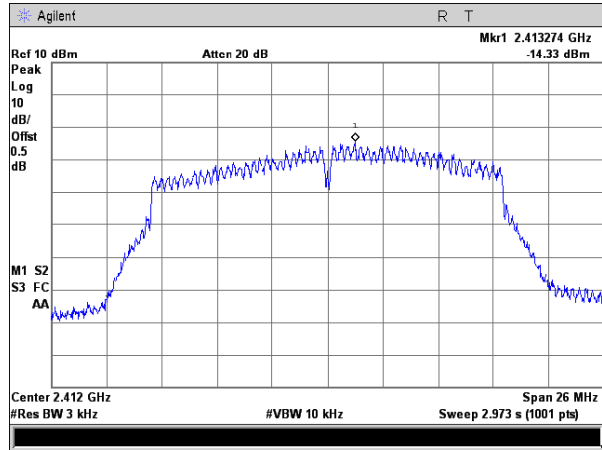

(802.11b) PSD plot on channel 6

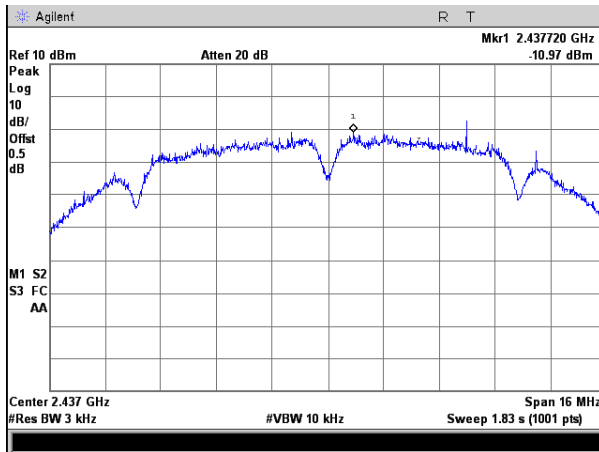

(802.11g) PSD plot on channel 6

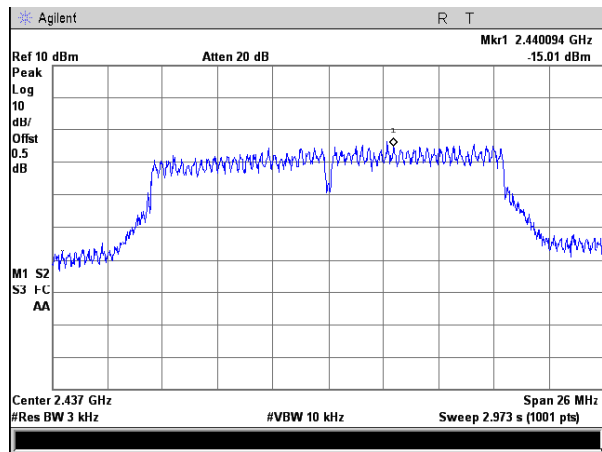

(802.11b) PSD plot on channel 11

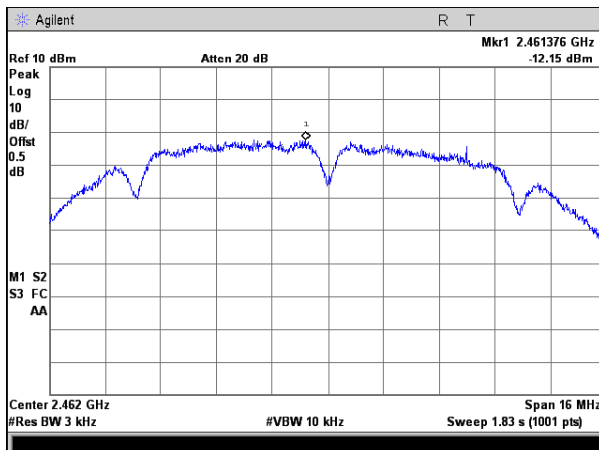

(802.11g) PSD plot on channel 11

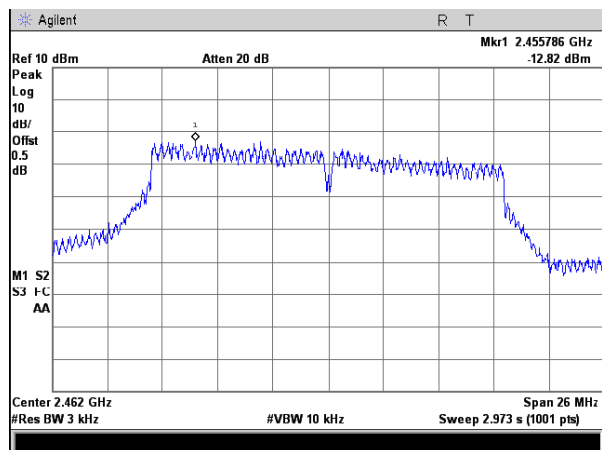



(802.11n20) PSD plot on channel 1

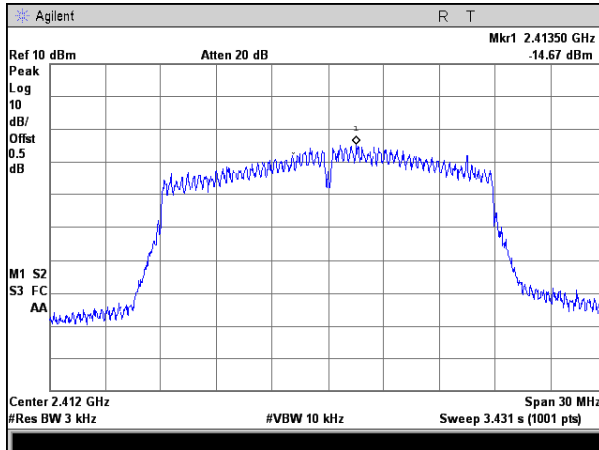

(802.11n40) PSD plot on channel 3

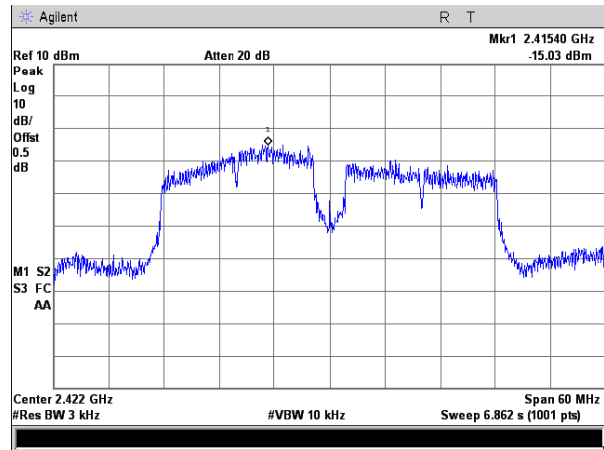

(802.11n20) PSD plot on channel 6

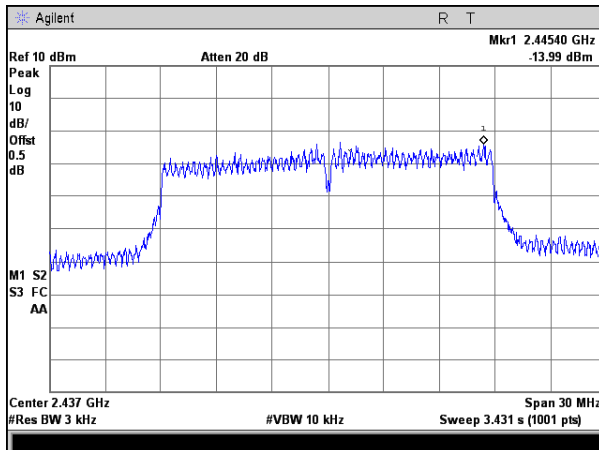

(802.11n40) PSD plot on channel 6

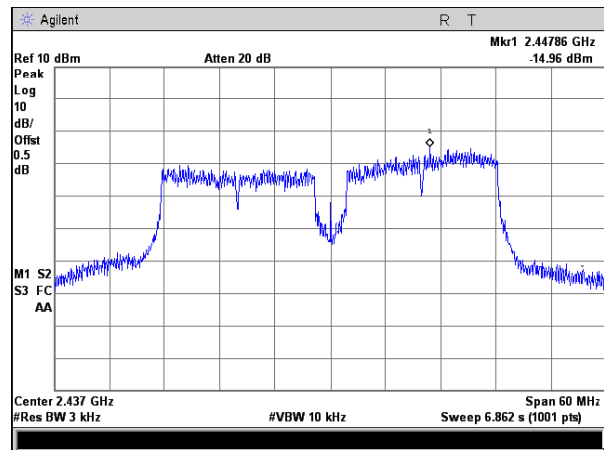

(802.11n20) PSD plot on channel 11

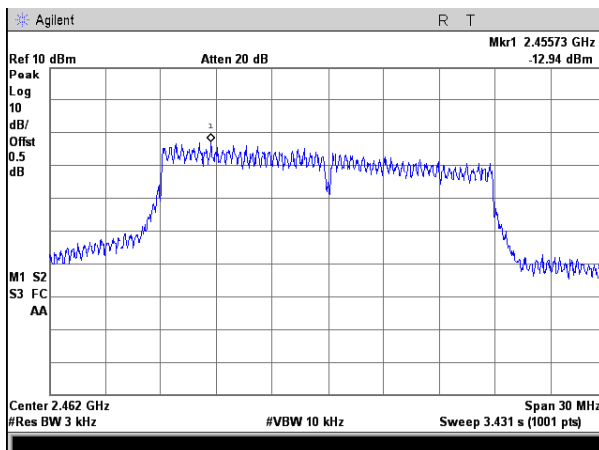

(802.11n40) PSD plot on channel 9

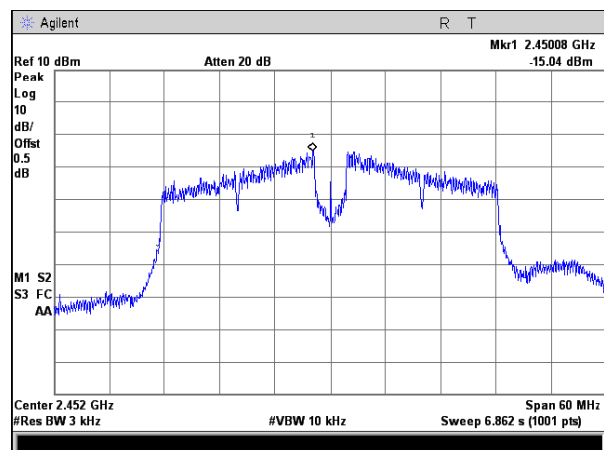



## 8. PEAK OUTPUT POWER TEST

### 8.1 APPLIED PROCEDURES / LIMIT

FCC Part15 (15.247) , Subpart C				
Section	Test Item	Limit	Frequency Range (MHz)	Result
15.247(b)(3)	Peak Output Power	1 watt or 30dBm	2400-2483.5	PASS

#### 8.1.1 TEST PROCEDURE

- a. The EUT was directly connected to the Power meter

#### 8.1.2 DEVIATION FROM STANDARD

No deviation.

#### 8.1.3 TEST SETUP



#### 8.1.4 EUT OPERATION CONDITIONS

The EUT tested system was configured as the statements of 2.4 Unless otherwise a special operating condition is specified in the follows during the testing.

**8.1.5 TEST RESULTS**

	Frequency	Maximum Conducted Output Power(PK)	LIMIT
	(MHz)	(dBm)	dBm
802.11b	2412	15.83	22
	2437	15.74	22
	2462	15.80	22
802.11g	2412	13.72	22
	2437	13.58	22
	2462	13.62	22
802.11n20	2412	12.55	22
	2437	12.61	22
	2462	12.79	22
802.11n40	2422	11.36	22
	2437	11.30	22
	2452	11.34	22



## 9. 100 KHZ BANDWIDTH OF FREQUENCY BAND EDGE

### 7.1 APPLICABLE STANDARD

In any 100 kHz bandwidth outside the frequency band in which the spread spectrum intentional radiator is operating, the radio frequency power that is produced by the intentional radiator shall be at least 20 dB below that in the 100 kHz bandwidth within the band that contains the highest level of the desired power, based on either an RF conducted or a radiated measurement.

### 7.2 TEST PROCEDURE

- a) Check the calibration of the measuring instrument using either an internal calibrator or a known signal from an external generator.
- b) Position the EUT without connection to measurement instrument. Turn on the EUT and connect its antenna terminal to measurement instrument via a low loss cable. Then set it to any one measured frequency within its operating range, and make sure the instrument is operated in its linear range.
- c) Set RBW to 100 kHz and VBW of spectrum analyzer to 100 kHz with a convenient frequency span including 100 kHz bandwidth from band edge.
- d) Measure the highest amplitude appearing on spectral display and set it as a reference level. Plot the graph with marking the highest point and edge frequency.
- e) Repeat above procedures until all measured frequencies were complete.

### 7.3 DEVIATION FROM STANDARD

No deviation.

### 7.4 TEST SETUP



### 7.5 EUT OPERATION CONDITIONS

The EUT tested system was configured as the statements of 2.4 Unless otherwise a special operating condition is specified in the follows during the testing.

## 9.1 TEST RESULTS



802.11b: Band Edge, Left Side

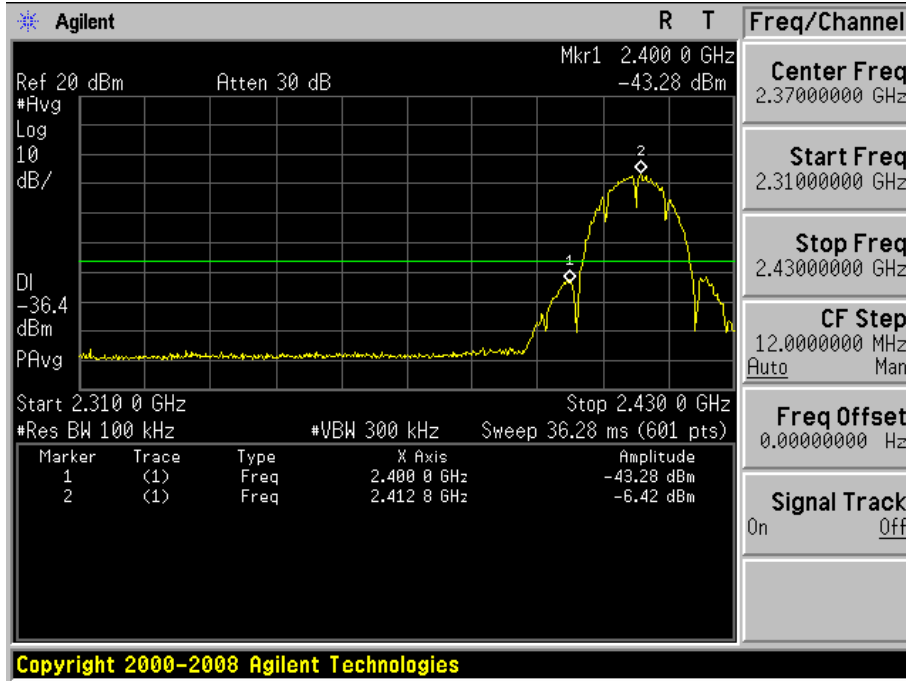

802.11b: Band Edge, Right Side

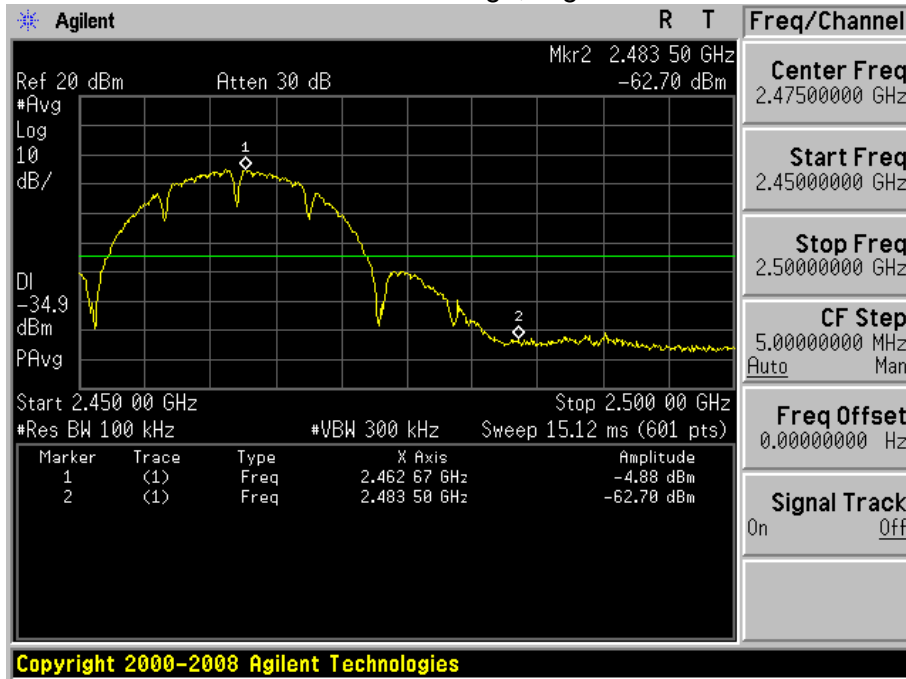



802.11g: Band Edge, Left Side

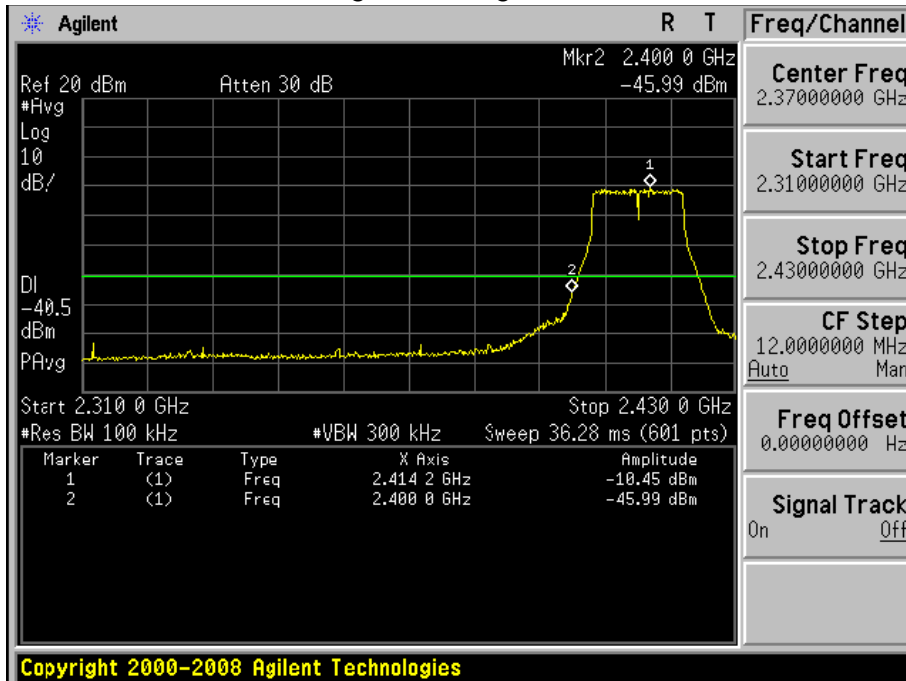

802.11g: Band Edge, Right Side

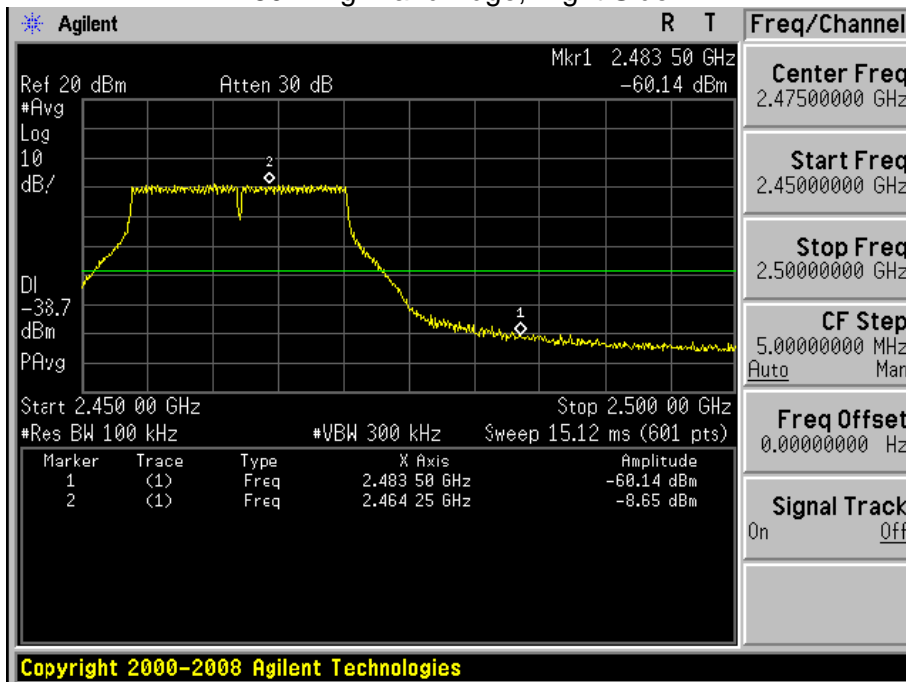



### 802.11n-HT20: Band Edge, Left Side

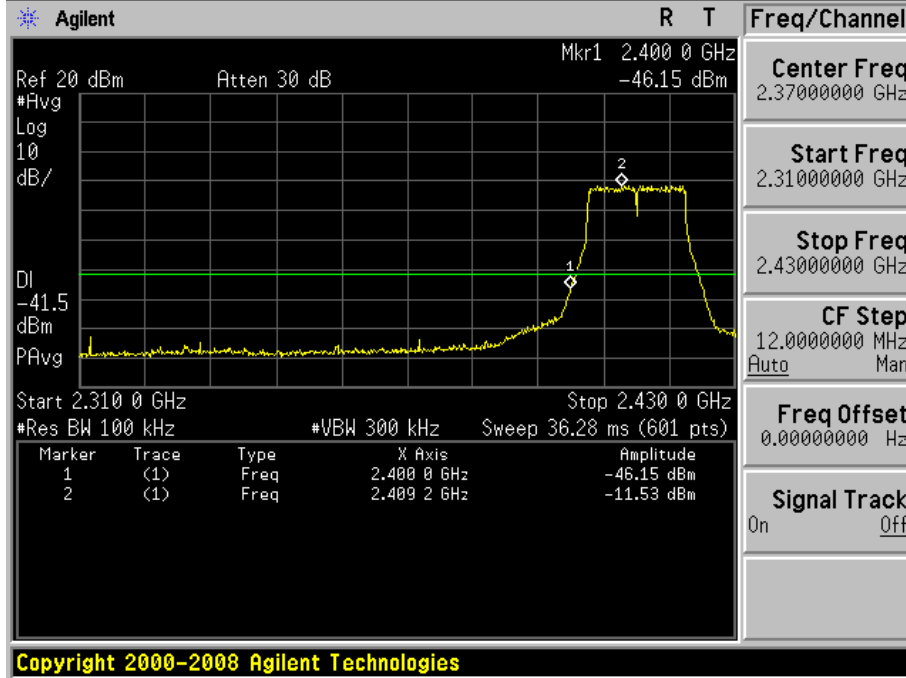

### 802.11n-HT20: Band Edge, Right Side

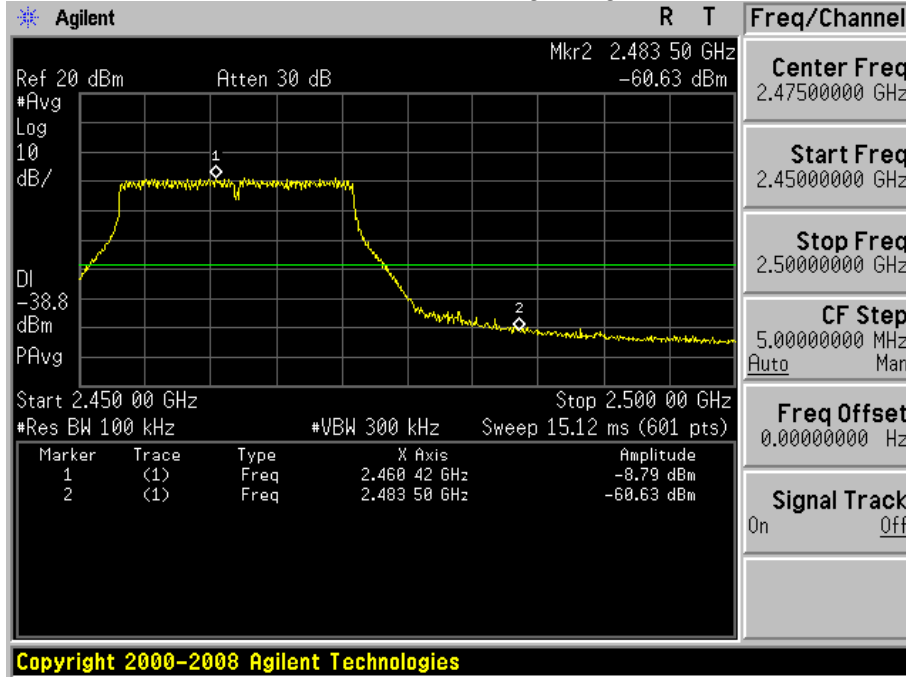



802.11n-HT40: Band Edge, Left Side

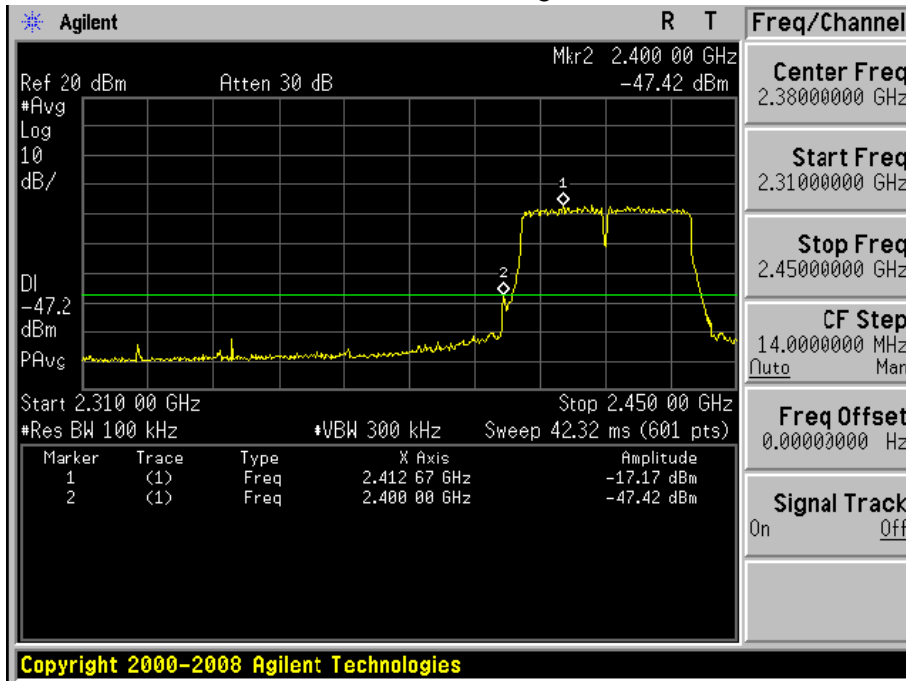

802.11n-HT40: Band Edge, Right Side

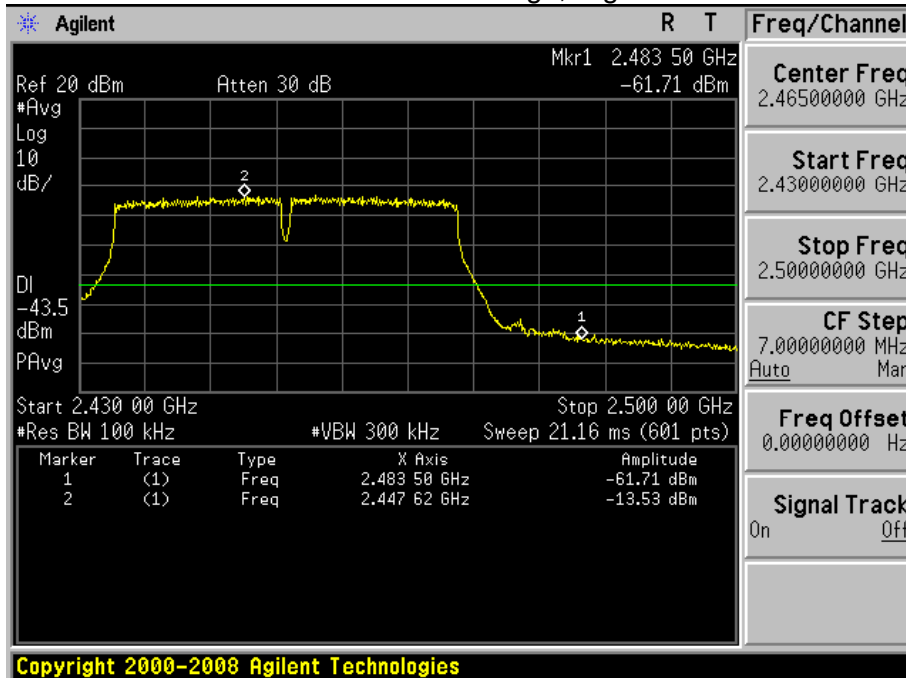



## **10. ANTENNA REQUIREMENT**

### **10.1 STANDARD REQUIREMENT**

15.203 requirement: For intentional device, according to 15.203: an intentional radiator shall be designed to ensure that no antenna other than that furnished by the responsible party shall be used with the device.

### **10.2 EUT ANTENNA**

The EUT antenna is integrated antenna, It comply with the standard requirement.

## 11. EUT TEST PHOTO

### Radiated Measurement Photos

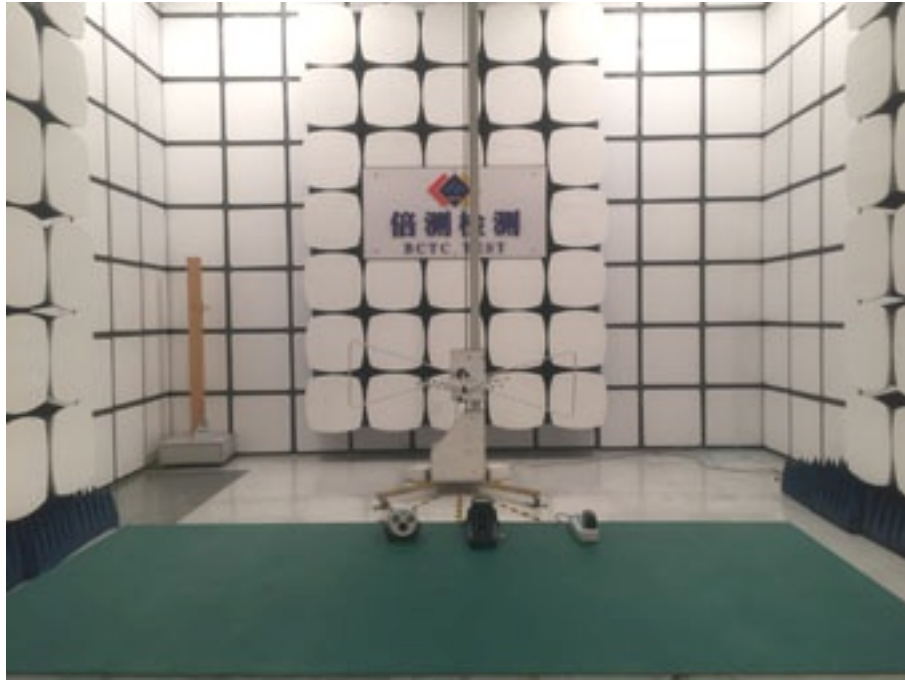

### Radiated Measurement Photos





### Conducted Emission





## 12. EUT PHOTO







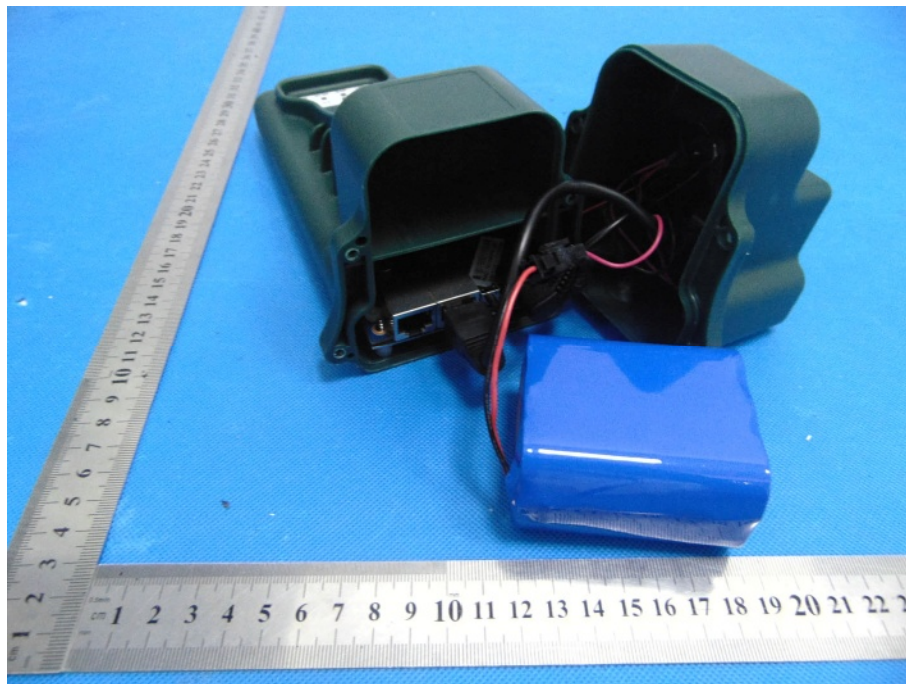

\*\*\*\*\* END OF REPORT \*\*\*\*\*