





Square Register

Getting Started

 Square 1955 Broadway Ste 600, Oakland, CA 94612		
PROJECT X2B Packaging	DELIVERABLE GSG - 16pg - US	INKS/COATING 1/1 + Matte AQ
MATERIAL 128g text C2S - SUN	SIZE Flat: 272mm x 136mm Folded: 136mm x 136mm	
VENDOR Veritiv China	FINISHING diecut, fold, staple	
DESIGN Eric Manago	PRODUCTION Mike O'Neal	PRODUCTION NOTES Dieline —————
MODIFIED November 4, 2020 1:00 PM	PROGRAM MANAGER Isabel Turnquist	
FILE NAME M-LIT-0239-03_X2_GSG_16-pages_US_M02		
PART # M-LIT-0239	REV -03	
REV NOTES <i>REV-02 (08/20): MP release</i> <i>REV-03 (10/20): MP rerelease with correction to images</i>		SUPPLIER NOTES

WELCOME TO SQUARE

Let's get your Square Register up and running. Start by taking a quick look at what's in the box.

Square Register



Power button

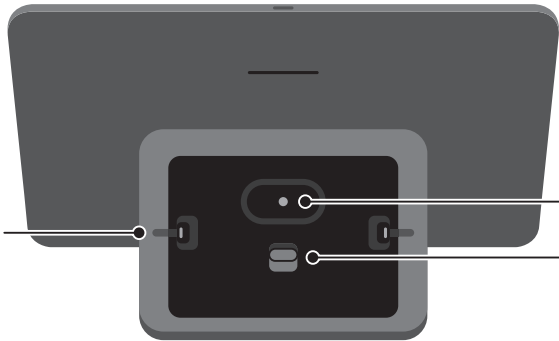

Micro USB ports

Mounting plate
cleat slot

Customer display
release latch

Bottom view

Customer display



Front view



Back view



Power adapter
cable

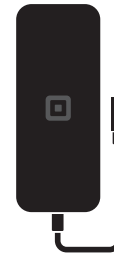

Power
adapter



Hub



Customer
display cable

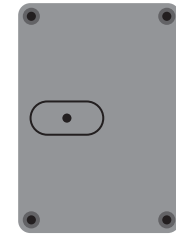

Mounting plate

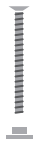

Mounting screws
and thumb nuts
(x4)

SETTING UP SQUARE REGISTER

Start by connecting Square Register to the hardware hub and power adapter.

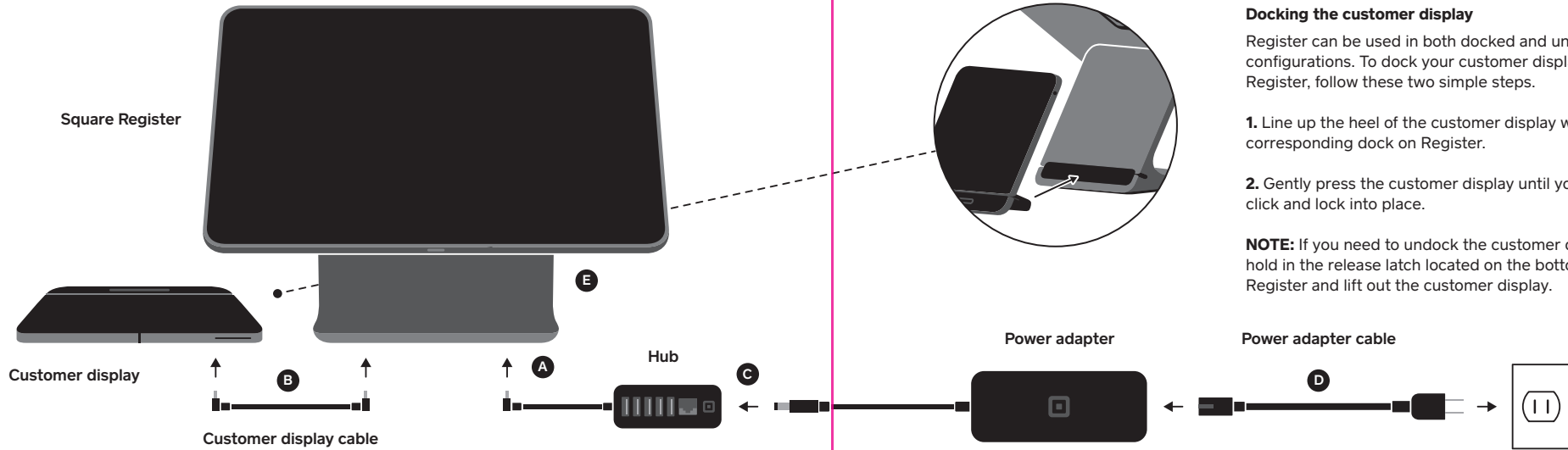

Docking the customer display

Register can be used in both docked and undocked configurations. To dock your customer display to Register, follow these two simple steps.

1. Line up the heel of the customer display with the corresponding dock on Register.
2. Gently press the customer display until you feel it click and lock into place.

NOTE: If you need to undock the customer display, hold in the release latch located on the bottom of Register and lift out the customer display.

A

Connect Register to hub

Connect the hub cable to the bottom of Register through any micro USB port.

B

Connect Register to customer display (undocked)

Plug either end of the customer display cable into the customer display, then plug the other end into the bottom of Register.

C

Connect the power adapter to hub

Plug the power adapter into the hub.

D

Plug into power outlet

Plug the power adapter cable into the power adapter, then into a power outlet.

E

Power up

Press the power button on the base of the Register display until the Square logo appears onscreen.

HOW TO TAKE PAYMENTS (DOCKED)

Position Register so customers can easily see the customer display and pay with their cards and devices. To take a payment, ring up the sale and tap **Charge**.



Tap

Ask your customer to hold a contactless device or card near the customer display to trigger payment.

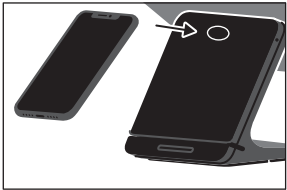

Dip

Ask your customer to insert a chip card into the chip card slot on the customer display and leave it in place until the sale is complete.

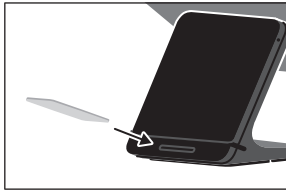

Swipe

Ask your customer to swipe a magnetic-stripe card through the magstripe reader on the customer display.

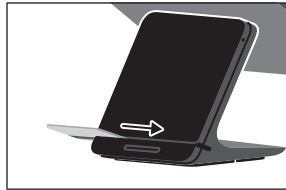

HOW TO TAKE PAYMENTS (UNDOCKED)

Make sure the customer display is correctly oriented so it's sitting horizontally on your countertop. Position the customer display so your customers can easily see it and pay with their cards and devices. To take a payment, ring up the sale and tap **Charge**.

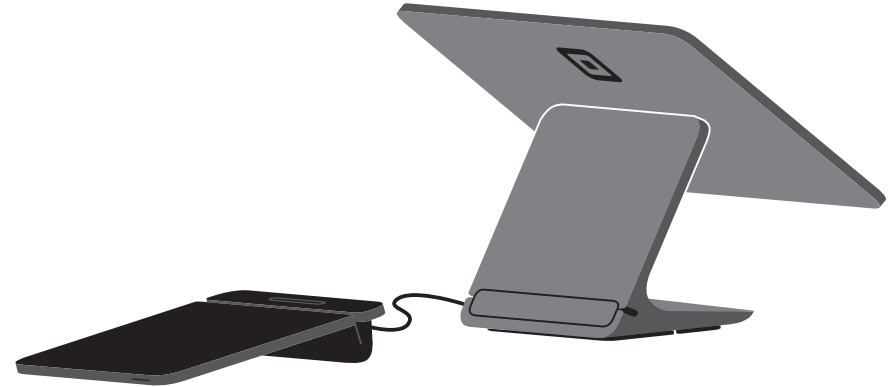

Tap

Ask your customer to hold a contactless device or card near the customer display to trigger payment.

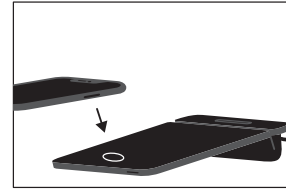

Dip

Ask your customer to insert a chip card into the chip card slot on the customer display and leave it in place until the sale is complete.

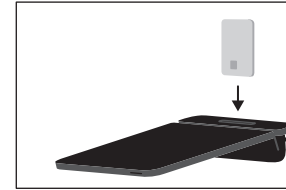

Swipe

Ask your customer to swipe a magnetic-stripe card through the magstripe reader on the customer display.

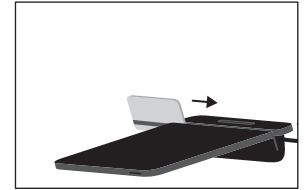

MOUNT SQUARE REGISTER TO YOUR COUNTER WITH ADHESIVE

1. Prepare the adhesive strips

Grab the mounting plate. Remove the backing from the adhesive strips located on the underside of the plate.

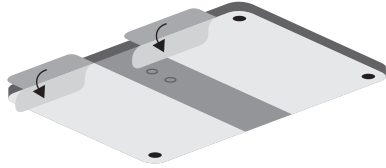

2. Position properly

Make sure the raised cleat of the mounting plate is on your side of the counter, not the customer's side. Adhere the plate to your counter in the desired position and press down firmly for 30 seconds. Wait 30 minutes for the adhesive to set. If you need to remove the plate, slowly pull the tabs on the adhesive strips until they release.

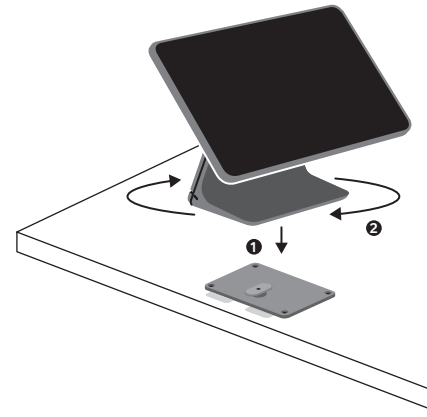
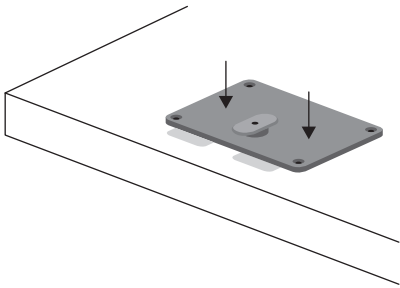

3. Twist and lock

Place Register onto the mounting plate with the larger screen facing right. Make sure the cleat is positioned in its slot. Turn Register 90 degrees clockwise so it locks into place.

MOUNT SQUARE REGISTER TO YOUR COUNTER WITH SCREWS

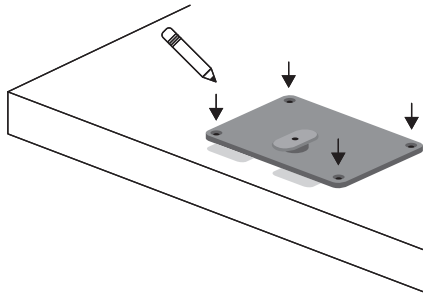

1. Pick a spot

Grab the mounting plate. Pick a spot on your counter for Register, position the plate, and use a pencil to mark the four screw holes on your counter. Make sure the raised cleat is on your side of the counter, not the customer's side. **Note:** Maximum counter thickness is 2 inches (50 mm).

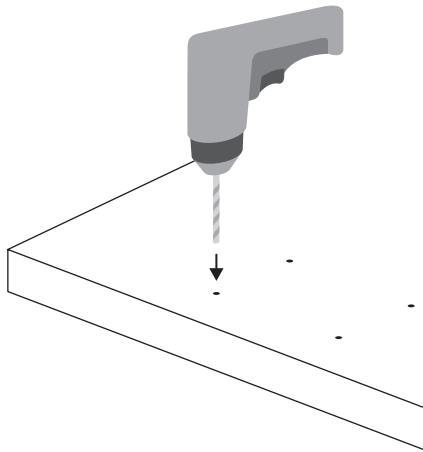

2. Drill your counter carefully

You need a drill, a 3/16" (5 mm) drill bit, and the included screws and thumb nuts. Use the drill and drill bit to make the four holes you've marked for the plate.

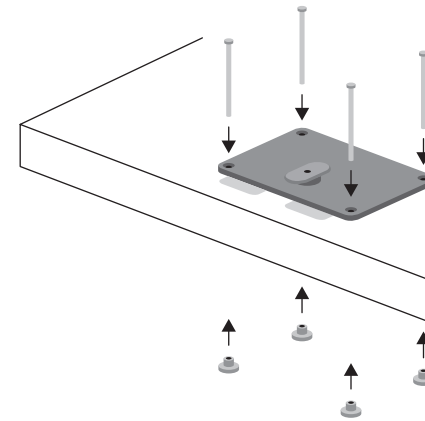

3. Position properly

Position the mounting plate onto the holes you've drilled, then insert a screw into each hole. From the underside of your counter, place a thumb nut onto each screw and tighten until the thumb nut is flush against your counter.

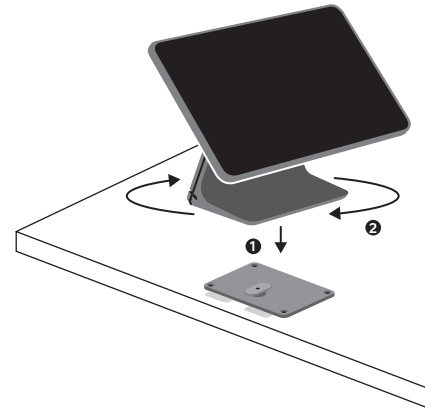

4. Twist and lock

Place Register onto the mounting plate with the larger screen facing right. Make sure the cleat is positioned in its slot. Turn Register 90 degrees clockwise so it locks into place.

CONNECT TO THE INTERNET VIA ETHERNET OR CONNECT USB ACCESSORIES

Ethernet: Plug one end of an Ethernet cable into the hub and the other into a modem or Ethernet port.



USB accessories: Plug any USB accessories into the hub, such as a bar code scanner, receipt printer, or cash drawer.

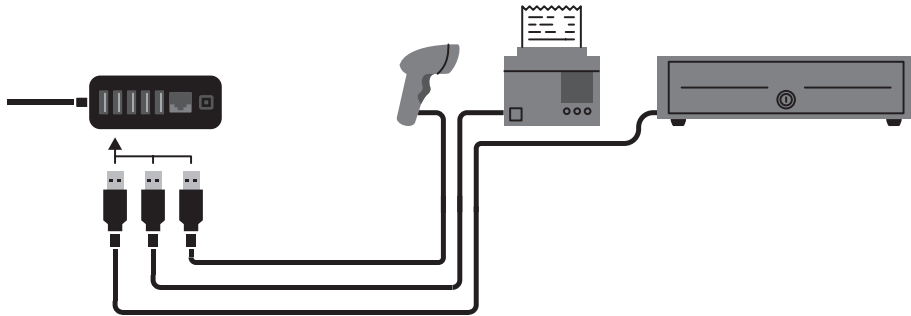

Note: The Ethernet port can only be used to connect Register to the internet.

HELP AND SUPPORT

Read our FAQs, learn more about compatible hardware, and get troubleshooting support at square.com/register-setup.

HARDWARE WARRANTY

You're covered from defects for up to two years under a limited warranty. See square.com/warranty.

FREE 30-DAY RETURNS

Square offers a 30-day, risk-free return policy for all purchases made from square.com/shop. Simply go to square.com/returns so we can make things right. After a return is complete, a refund will be credited back to you.

REGULATORY INFORMATION

You can view regulatory information for Square Register and Customer display by going to [Settings > General > Regulatory](#). To view FCC information, go to [Support > Legal > Hardware Disclaimer](#).

This device complies with Part 15 of the FCC Rules. Operation is subject to the following two conditions: (1) this device may not cause harmful interference, and (2) this device must accept any interference received, including interference that may cause undesired operation.

FCC RF Radiation Exposure Statement: This equipment complies with FCC radiation exposure limits set forth for an uncontrolled environment. This equipment should be installed and operated with a minimum distance of 20 cm between the radiator and any part of your body.

ACCESSORY HUB INFORMATION

Hub output provides power to peripherals. Register output provides power to Square Register.

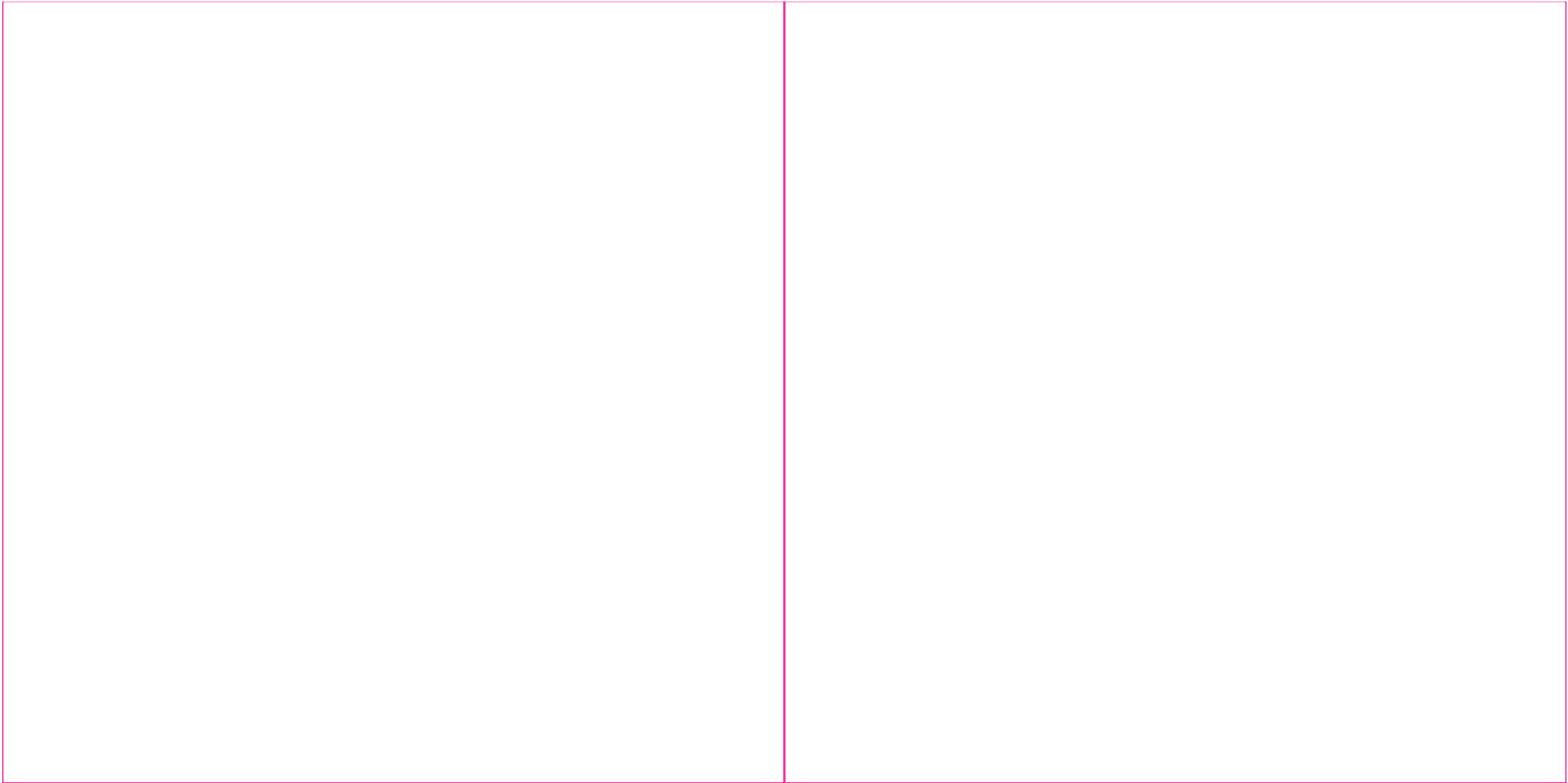

© 2020 Square, Inc., 1455 Market St., Ste. 600, San Francisco, CA 94103. Square, the Square logo, and Square Register are trademarks of Square, Inc. M-LIT-0239-03