



Canada

RF Test Report

As per

**RSS-210 Annex B.6,
Issue 9:2016**

&

FCC Part 15 Subpart 15.225:2017

**Low Power Licence Exempt Radio
Communication Devices
Intentional Radiators**

on the

SPC1

Wireless card reader

Issued by:

TÜV SÜD Canada Inc.
11 Gordon Collins Dr,
Gormley, ON, L0H 1G0
Canada
Ph: (905) 883-7255

Testing produced for



See Appendix A for full client &
EUT details.

Prepared by:

Raymond Lee Au,
Project Engineer

Reviewed by:

Amir Emami,
Project Engineer



Innovation, Science and
Economic Development Canada
**Registration #
6844A-3**



Testing Laboratory
Certificate #2955.02



**R-4023, G-506
C-4498, T-1246**



**Registration #
CA6844**



Client	Square Inc.	
Product	Wireless card reader model SPC1-01	
Standard(s)	RSS 210 Annex B.6, Issue 9:2016 FCC Part 15 Subpart 15.225:2017	

Table of Contents

Table of Contents	2
Report Scope	3
Summary	4
Test Results Summary	5
Notes, Justifications, or Deviations	6
Sample Calculation(s)	7
Applicable Standards, Specifications and Methods	7
Document Revision Status	8
Definitions and Acronyms	9
Testing Facility	10
Calibrations and Accreditations	10
Testing Environmental Conditions and Dates	11
Detailed Test Results Section	12
Radiated Emission Field Strength	13
Transmitter Spurious Radiated Emissions	24
Appendix A – EUT Summary	33
Appendix B – EUT and Test Setup Photos	35

Client	Square Inc.	
Product	Wireless card reader model SPC1-01	
Standard(s)	RSS 210 Annex B.6, Issue 9:2016 FCC Part 15 Subpart 15.225:2017	

Report Scope

This report addresses the EMC verification testing and test results of the wireless card reader accepting NFC contactless payments and EMV chip card transactions unit from Square Inc, model: **SPC1**. This unit is herein referred to as EUT (Equipment Under Test). The EUT was tested for compliance against the following standards:

RSS-210 Annex B.6, Issue 9:2016,
FCC Part 15 Subpart C 15.225:2017

Test procedures, results, justifications, and engineering considerations, if any, follow later in this report.

This report does not imply product endorsement by any government, accreditation agency, or TÜV SÜD Canada Inc.

Opinions or interpretations expressed in this report, if any, are outside the scope of TÜV SÜD Canada Inc accreditations. Any opinions expressed do not necessarily reflect the opinions of TÜV SÜD Canada Inc, unless otherwise stated.

Client	Square Inc.	
Product	Wireless card reader model SPC1-01	
Standard(s)	RSS 210 Annex B.6, Issue 9:2016 FCC Part 15 Subpart 15.225:2017	

Summary

The results contained in this report relate only to the item(s) tested.

EUT Model:	SPC1-01
EUT FCC Certification #, FCC ID:	2AF3K-SPC1
EUT passed all tests performed	Yes
Tests conducted by	Raymond Lee Au

For testing dates, see "Testing Environmental Conditions and Dates".

Client	Square Inc.	
Product	Wireless card reader model SPC1-01	
Standard(s)	RSS 210 Annex B.6, Issue 9:2016 FCC Part 15 Subpart 15.225:2017	

Test Results Summary

Standard/Method	Description	Class/Limit	Result
FCC 15.203	Antenna Requirement	Unique	Pass ^a
FCC 15.225 (a), (b), (c) RSS-210 B.6	Operation within the band 13.110-14.010 MHz (Field Strength)	Quasi-Peak Average	Pass
FCC 15.225 (d) FCC 15.209 RSS-GEN (Tables 5 & 6)	Transmitter Spurious Radiated Emissions	Quasi-Peak Average	Pass
Overall Result			Pass

^a See *Notes, Justifications, or Deviations* section for more details.

If the product as tested or otherwise complies with the specification, the EUT is deemed to comply with the requirement and is deemed a 'PASS' grade. If not 'FAIL' grade will be issued. Note that 'PASS' / 'FAIL' grade is independent of any measurement uncertainties. A 'PASS' / 'FAIL' grade within measurement uncertainty is marked with a '*'.

Client	Square Inc.	
Product	Wireless card reader model SPC1-01	
Standard(s)	RSS 210 Annex B.6, Issue 9:2016 FCC Part 15 Subpart 15.225:2017	

Notes, Justifications, or Deviations

The following notes, justifications for tests not performed or deviations from the above listed specifications apply:

This report incorporates test results performed after changes to the EUT by the manufacturer on the power supply circuitry. As per the manufacturer, the updated unit is electrically equivalent to the previously certified unit, and the transmitter portions are not changed.

This report incorporates test results performed after the following changes to the EUT by the manufacturer:

1. Added a linear regulator for the VCOIN supply.
 - This circuit provides DC supply to Vcoin domain of the secure chip to maintain security circuitry when main battery is depleted. A linear voltage regulator LDO is added to regulate this voltage to 2.2V so the main battery voltage variations does not affect this voltage.
2. Added an optional supervisor circuitry for main 3.3V supply.
 - In this block U3 is supposed to block the 3.3V supply (main digital supply) to be turned on until the input voltage supplied by battery or the charger reaches a certain level (2.8V).

The EUT is a portable credit card reader with BLE (2.402 – 2.480 MHz) and NFC RFID (13.56 MHz) capabilities. This report deals with the NFC RFID characteristics (tested to FCC 15.225). See report # 7169006115R-BLE-000 for the report regarding the BLE characteristics (tested to FCC 15.247).

For the antenna requirement specified in FCC 15.203, the antennas have not been changed, and continue to meet requirements.

The EUT was tested positioned in the three orthogonal axis. Worst case results are presented, and occurs with the EUT positioned upright (broad side facing test antenna) during NFC testing. See *Appendix B* for test photos.

For the Restricted Bands of operation, the EUT is designed to only operate between 13.110-14.010 MHz.

The EUT's output is set to transmit continuously at 100% duty cycle at the maximum output power.

Client	Square Inc.	
Product	Wireless card reader model SPC1-01	
Standard(s)	RSS 210 Annex B.6, Issue 9:2016 FCC Part 15 Subpart 15.225:2017	

See separate RF Exposure Exhibit for this unit regarding the permissible RF exposure levels.

SAR assessment is applied to the EUT. An assessment distance of ≤ 5 mm is applied. The device meets the SAR Test exemption criteria and no test is required. See RF Exposure exhibits for more details.

Sample Calculation(s)

Radiated Emission Test

Margin = Limit – (Received Signal + Antenna Factor + Cable Loss – Pre-Amp Gain)

Margin = 50.5dB μ V/m – (50dB μ V + 10dB + 2.5dB – 20dB)

Margin = 8.0 dB (pass)

Applicable Standards, Specifications and Methods

ANSI C63.4:2014	Methods of Measurement of Radio-Noise Emissions from Low-Voltage Electrical and Electronic Equipment in the Range of 9 kHz to 40 GHz
ANSI C63.10:2013	American National Standard For Testing Unlicensed Wireless Devices
CFR 47 FCC 15 Subpart C:2017	Code of Federal Regulations – Radio Frequency Devices, Intentional Radiators
RSS-Gen Issue 5 2018	General Requirements and Information for the Certification of Radio Apparatus
RSS 210:2016	Issue 9: Licence-exempt Radio Apparatus (All Frequency Bands): Category I Equipment
ISO 17025:2005	General Requirements for the Competence of Testing and Calibration Laboratories

Client	Square Inc.	
Product	Wireless card reader model SPC1-01	
Standard(s)	RSS 210 Annex B.6, Issue 9:2016 FCC Part 15 Subpart 15.225:2017	

Document Revision Status

Revision 000 June 25, 2019
 - Initial Release

Client	Square Inc.	
Product	Wireless card reader model SPC1-01	
Standard(s)	RSS 210 Annex B.6, Issue 9:2016 FCC Part 15 Subpart 15.225:2017	

Definitions and Acronyms

The following definitions and acronyms are applicable in this report.
See also ANSI C63.14.

AE – Auxiliary Equipment. A digital accessory that feeds data into or receives data from another device (host) that in turn, controls its operation.

BW – Bandwidth. Unless otherwise stated, this refers to the 6 dB bandwidth.

EMC – Electro-Magnetic Compatibility. The ability of an equipment or system to function satisfactorily in its electromagnetic environment without introducing intolerable electromagnetic disturbances to anything in that environment.

EMI – Electro-Magnetic Immunity. The ability to maintain a specified performance when the equipment is subjected to disturbance (unwanted) signals of specified levels.

EUT – Equipment Under Test. A device or system being evaluated for compliance that is representative of a product to be marketed.

ITE – Information Technology Equipment with a primary function(s) of entry, storage, display, retrieval, transmission, processing, switching, or control, of data.

LISN – Line Impedance Stabilization Network

NCR – No Calibration Required

RF – Radio Frequency

Client	Square Inc.	
Product	Wireless card reader model SPC1-01	
Standard(s)	RSS 210 Annex B.6, Issue 9:2016 FCC Part 15 Subpart 15.225:2017	

Testing Facility

Testing for EMC on the EUT was carried out at TÜV SÜD Canada labs near Toronto, Ontario. The testing lab consists of a 3m semi-anechoic chamber calibrated to be able to allow measurements on an EUT that has a maximum width or length of up to 2m and a height of up to 3m. The chamber is equipped with a turntable that is capable of testing devices up to 3300lb in weight. This facility is capable of testing products that are rated for 120Vac and 240Vac single phase, or devices that are rated for a 208Vac 3 phase input. DC capability is also available for testing. The chamber is equipped with a mast that controls the polarization and height of the antenna. Control of the mast occurs in the control room adjoining the shielded chamber. Radiated emission measurements are performed using a BiLog antenna and a Horn antenna where applicable. Conducted emissions, unless otherwise stated, are performed using a LISN and using the Vertical Ground plane if applicable.

Calibrations and Accreditations

The 3m semi-anechoic chamber is registered with Federal Communications Commission (FCC, CA6844), Industry Canada (IC, 6844A-3) and Voluntary Control Council for Interference (VCCI, R-4023, G-506, C-4498, and T-1246). This chamber was calibrated for Normalized Site Attenuation (NSA) using test procedures outlined in ANSI C63.4 "Methods of Measurement of Radio-Noise Emissions from Low-Voltage Electrical and Electronic Equipment in the Range of 9 kHz to 40 GHz". The chamber is lined with ferrite tiles and absorption cones to minimize any undesired reflections. The NSA data is kept on file at TÜV SÜD Canada. For radiated susceptibility testing, a 16 point field calibration has been performed on the chamber. The field uniformity data is kept on file at TÜV SÜD Canada. TÜV SÜD Canada Inc is accredited to ISO 17025 by A2LA with Testing Certificate #2555.01. The laboratory's current scope of accreditation listing can be found as listed on the A2LA website. All measuring equipment is calibrated on an annual or biennial basis as listed for each respective test.

Client	Square Inc.	
Product	Wireless card reader model SPC1-01	
Standard(s)	RSS 210 Annex B.6, Issue 9:2016 FCC Part 15 Subpart 15.225:2017	

Testing Environmental Conditions and Dates

Following environmental conditions were recorded in the facility during time of testing

Date	Test	Initials	Temperature (°C)	Humidity (%)	Pressure (kPa)
Jun. 3, 2019	Operation within the band 13.110-14.010 MHz (Field Strength)	RA	21.9	33.4	101.8
Jun. 10, 2019	Transmitter Spurious Radiated Emissions	RA	23.4	44.8	101.6

Client	Square Inc.	
Product	Wireless card reader model SPC1-01	
Standard(s)	RSS 210 Annex B.6, Issue 9:2016 FCC Part 15 Subpart 15.225:2017	

Detailed Test Results Section

Client	Square Inc.	
Product	Wireless card reader model SPC1-01	
Standard(s)	RSS 210 Annex B.6, Issue 9:2016 FCC Part 15 Subpart 15.225:2017	

Radiated Emission Field Strength

Purpose

The purpose of this test is to ensure that the RF energy unintentionally emitted from the EUT does not exceed the limits listed below as defined in the applicable test standard, as measured from a receiving antenna. This helps protect other devices which may be using the same spectrum allocations for similar or other purposes and also ensures the transmit range of the device is within the pre-determined suitable range. This also ensures public safety by not exceeding a level which has been deemed safe for human exposure.

Limits and Method

The method is as defined in ANSI C63.4.

The limits are defined in FCC Part 15.225 (a), (b), (c), and RSS-210 B.6.

The field strength of any emissions within the bands given in the table below shall not exceed the limits specified.

The testing is performed using a loop antenna.

Frequency Range (MHz)	Limit (uV/m) ¹ at 30m	Limit (dBuV/m) ¹ at 3m
< 13.110	Emission limits of FCC 15.209 apply. See <i>Transmitter Spurious Radiated Emissions</i> section	
13.110 – 13.410	106	80.5
13.410 – 13.553	334	90.5
13.553 – 13.567	15,848	124.0
13.567 – 13.710	334	90.5
13.710 – 14.010	106	80.5
> 14.010	Emission limits of FCC 15.209 apply. See <i>Transmitter Spurious Radiated Emissions</i> section	

¹ Limit is with a Quasi-Peak detector with bandwidths as defined in CISPR-16-1-1

Based on ANSI C63.4 Section 4.2, if the Peak detector measurements do not exceed the Quasi-Peak limits, where defined, then the EUT is deemed to have passed the requirements.

In accordance with FCC Part 15, section 15.31(f)(2), testing was performed at a 3 meter test distance and an extrapolation factor of 40 dB/decade was applied. For example, an extrapolation of 30m to 3m is $20\text{Log}(uV/m) + 40\text{Log}(30m/3m)$.

Client	Square Inc.	
Product	Wireless card reader model SPC1-01	
Standard(s)	RSS 210 Annex B.6, Issue 9:2016 FCC Part 15 Subpart 15.225:2017	

Typical Radiated Emissions Setup

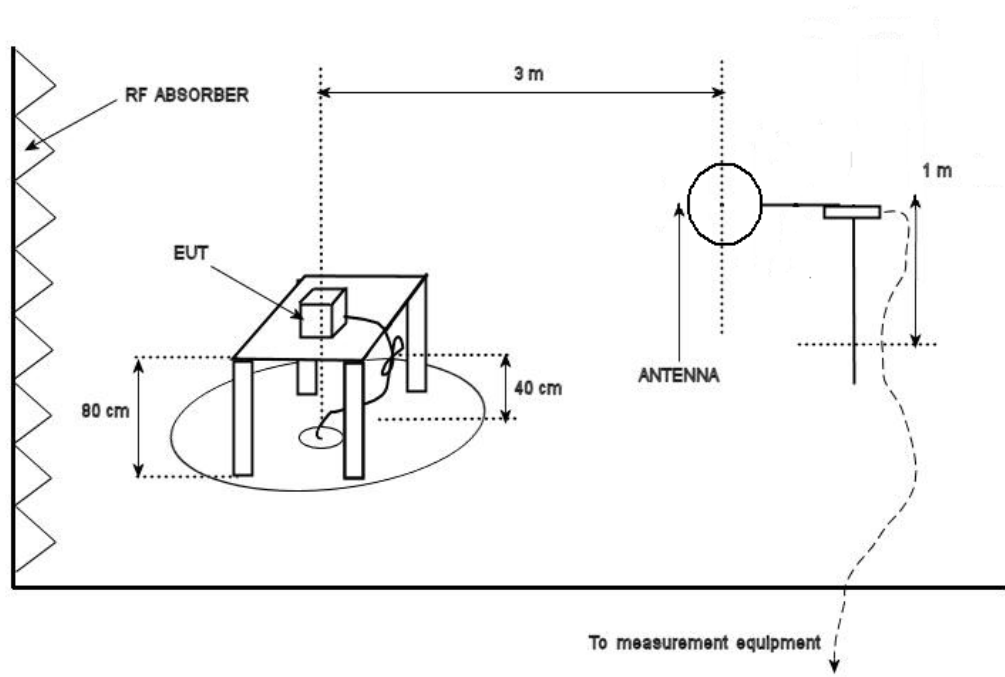

Measurement Uncertainty

The expanded measurement uncertainty is calculated in accordance with CISPR 16-4-2 and is $\pm 4.25\text{dB}$ for 30MHz – 1GHz and $\pm 4.93\text{dB}$ for 1GHz – 18GHz with a 'k=2' coverage factor and a 95% confidence level.

Preliminary Graphs

The graphs shown below are maximized peak measurement graphs over a full 0-360° rotation. The loop was orientated at 0 degrees and 90 degrees and a maximized reading is shown. The marker shows the value before factors are applied. See the *Final Measurements* section following for factor corrected values.

Client	Square Inc.	
Product	Wireless card reader model SPC1-01	
Standard(s)	RSS 210 Annex B.6, Issue 9:2016 FCC Part 15 Subpart 15.225:2017	

Peak Emission
Band Edges
13.410-13.553 MHz
3m test distance
 (Factors not incorporated. See *Final Measurements.*)

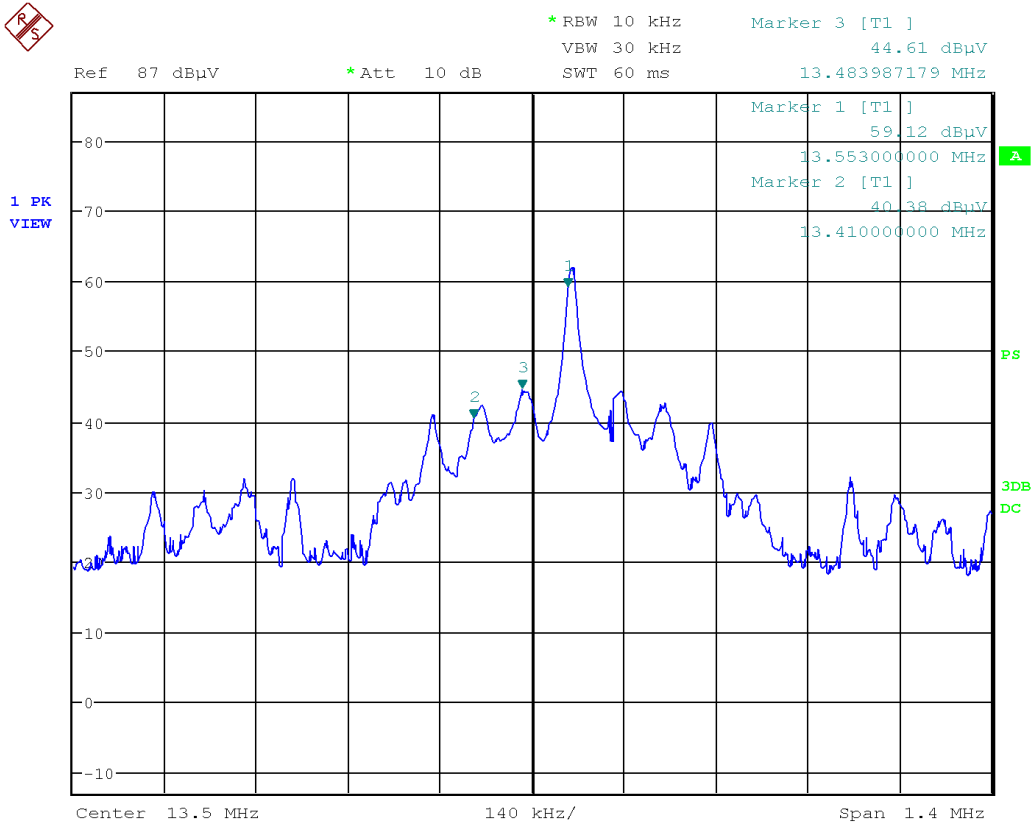

Client	Square Inc.	
Product	Wireless card reader model SPC1-01	
Standard(s)	RSS 210 Annex B.6, Issue 9:2016 FCC Part 15 Subpart 15.225:2017	

**Peak Emission
Band Edges**
13.110-13.410 MHz
3m test distance
 (Factors not incorporated. See *Final Measurements.*)

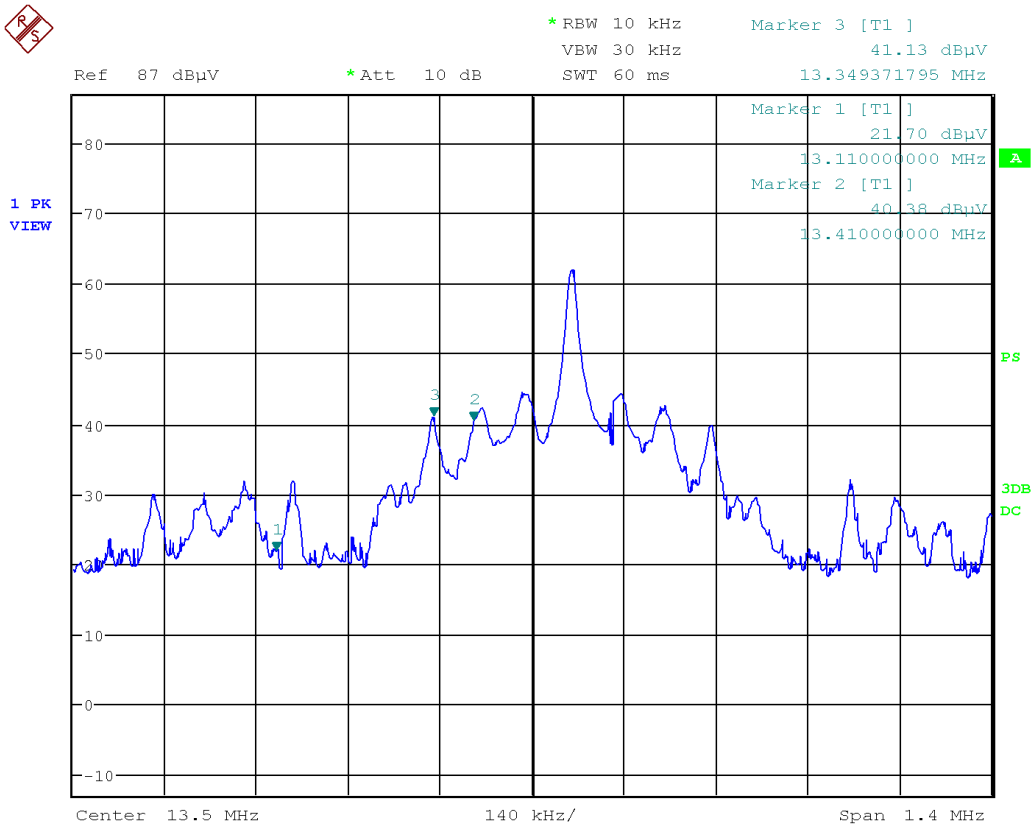

Client	Square Inc.	
Product	Wireless card reader model SPC1-01	
Standard(s)	RSS 210 Annex B.6, Issue 9:2016 FCC Part 15 Subpart 15.225:2017	

Peak Emission
Band Edges
< 13.110 MHz
3m test distance
 (Factors not incorporated. See *Final Measurements.*)

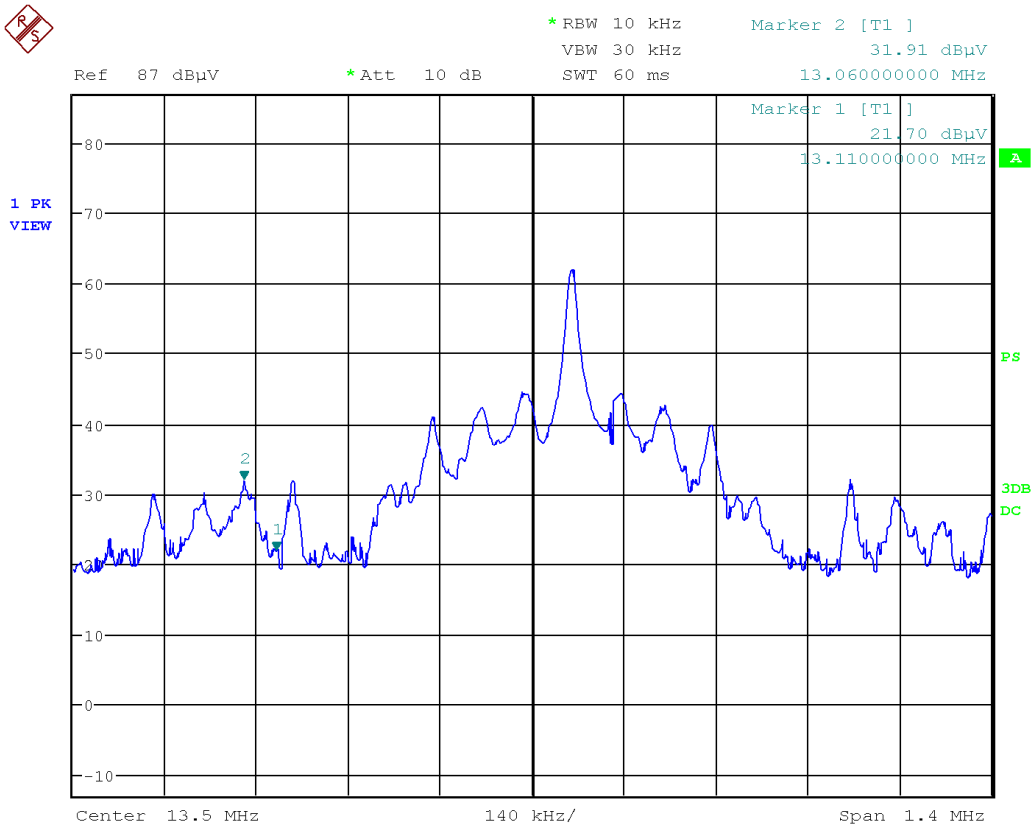

Client	Square Inc.	
Product	Wireless card reader model SPC1-01	
Standard(s)	RSS 210 Annex B.6, Issue 9:2016 FCC Part 15 Subpart 15.225:2017	

**Peak Emission
 Band Edges
 13.567-13.710 MHz
 3m test distance
 (Factors not incorporated. See *Final Measurements.*)**

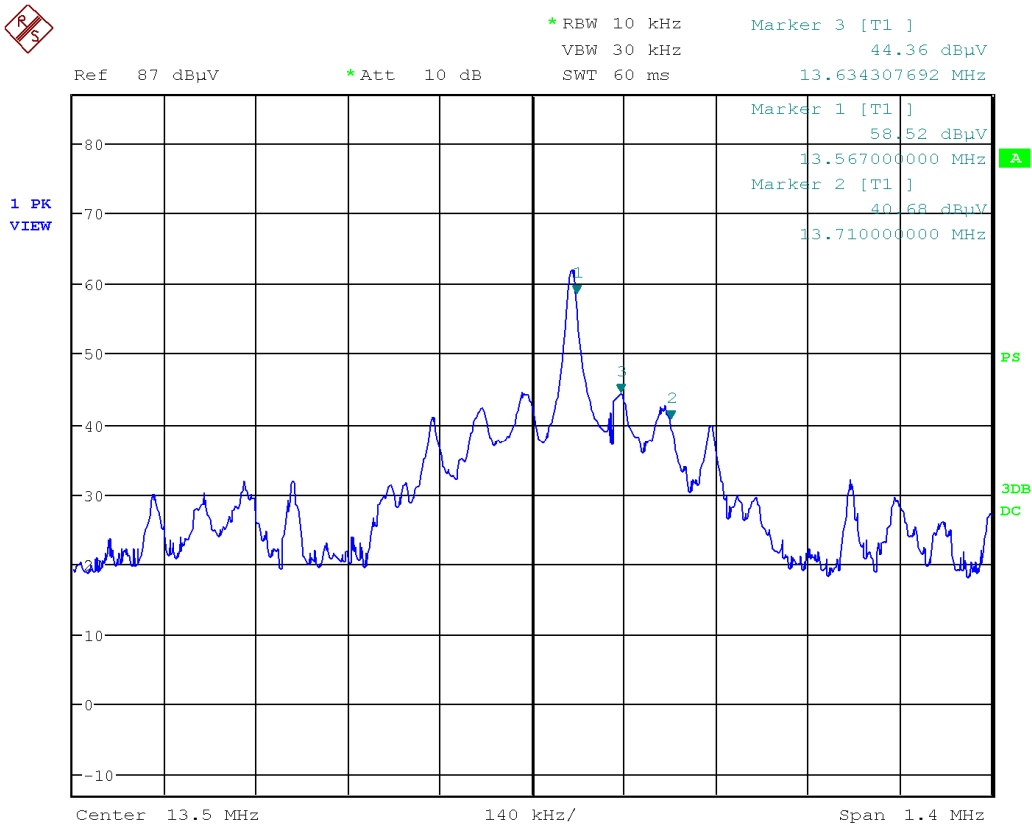

Client	Square Inc.	
Product	Wireless card reader model SPC1-01	
Standard(s)	RSS 210 Annex B.6, Issue 9:2016 FCC Part 15 Subpart 15.225:2017	

**Peak Emission
 Band Edges
 13.710-14.010 MHz
 3m test distance
 (Factors not incorporated. See *Final Measurements.*)**

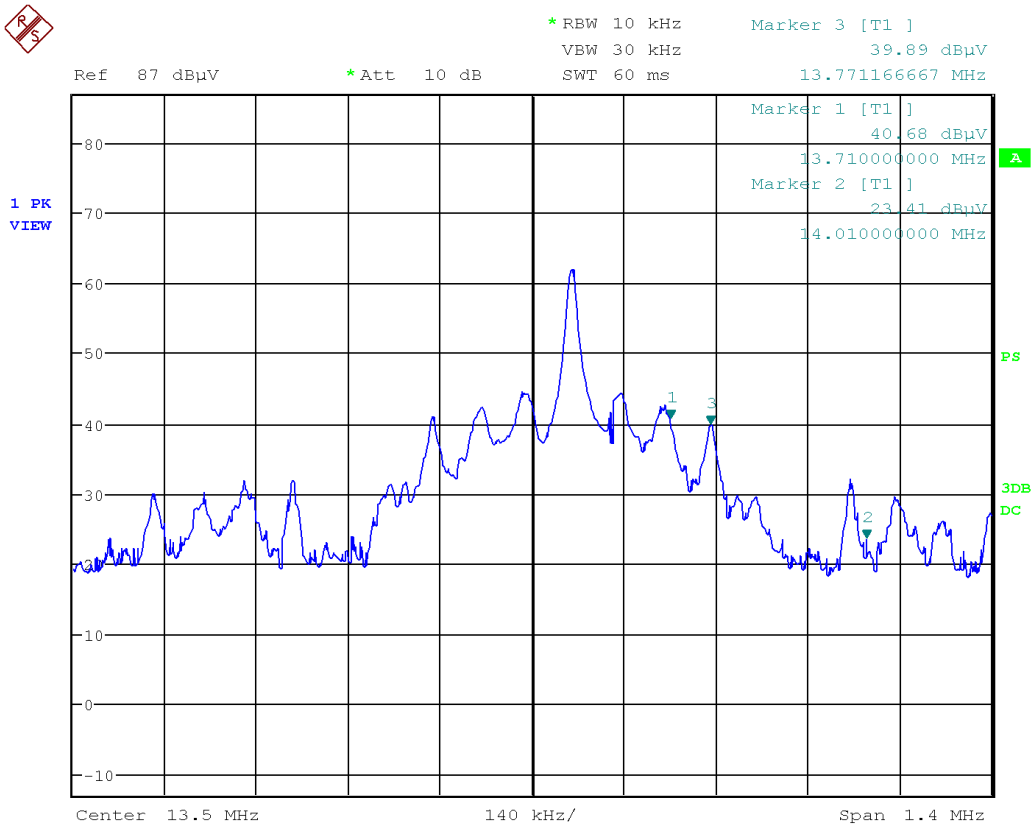

Client	Square Inc.	
Product	Wireless card reader model SPC1-01	
Standard(s)	RSS 210 Annex B.6, Issue 9:2016 FCC Part 15 Subpart 15.225:2017	

**Peak Emission
 Band Edges
 > 14.010 MHz
 3m test distance**
 (Factors not incorporated. See *Final Measurements.*)

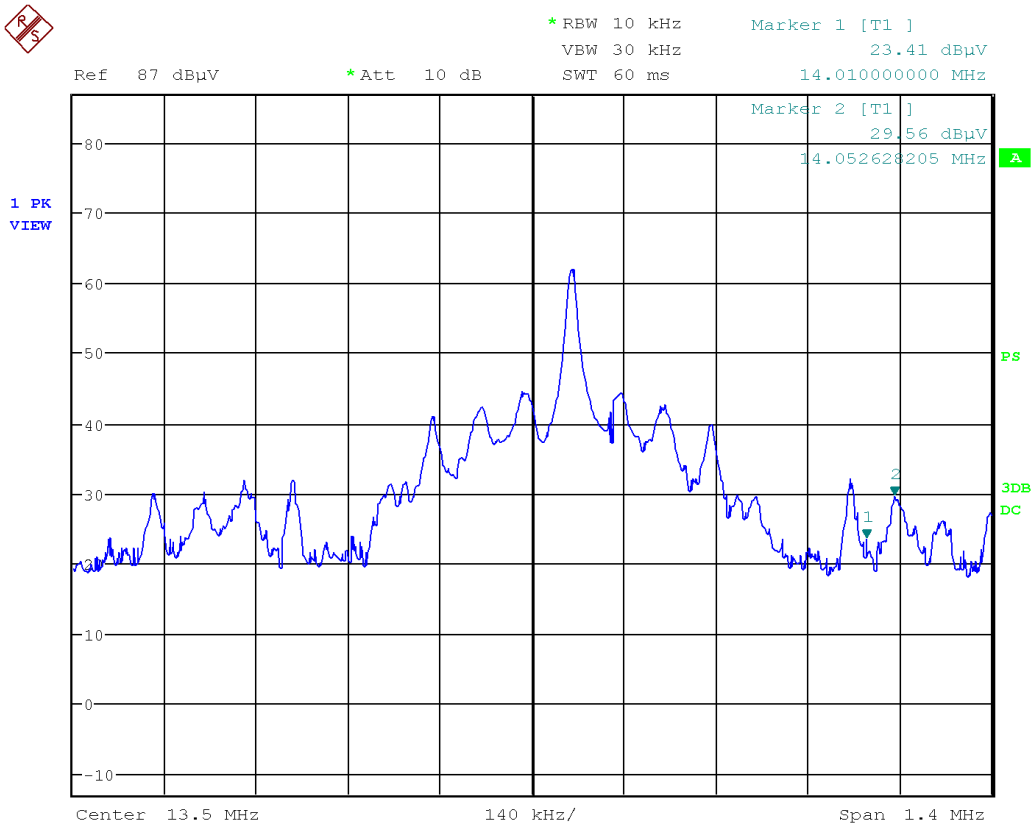

Client	Square Inc.	
Product	Wireless card reader model SPC1-01	
Standard(s)	RSS 210 Annex B.6, Issue 9:2016 FCC Part 15 Subpart 15.225:2017	

Final Measurements

Radiated Emissions Table - 15.225
Fundamental

Test Frequency (MHz)	Detection mode	Raw signal dB(μ A)	Cable loss + Pre-selector dB	dB μ A to dB μ V conversion factor	Antenna factor dB	Pre-Amp Gain dB	Received signal dB(μ V/m)	Emission limit dB(μ V/m)	Margin dB(μ V)	Result
13.56	Peak	62.12	0.3	51.5	-16.7	-28.5	68.72	123.9	55.18	Pass

Radiated Emissions Table - 15.225
Band Edges

Test Frequency (MHz)	Detection mode	Raw signal dB(μ A)	Cable loss + Pre-selector dB	dB μ A to dB μ V conversion factor	Antenna factor dB	Pre-Amp Gain dB	Received signal dB(μ V/m)	Emission limit dB(μ V/m)	Margin dB(μ V)	Result
13.060	Peak	31.91	0.3	51.5	-16.8	-28.5	38.41	69.5	31.09	Pass
13.110	Peak	21.7	0.3	51.5	-16.8	-28.5	28.2	69.5	41.3	Pass
13.349	Peak	41.13	0.3	51.5	-16.8	-28.5	47.63	80.5	32.87	Pass
13.410	Peak	40.38	0.3	51.5	-16.8	-28.5	46.88	80.5	33.62	Pass
13.484	Peak	44.61	0.3	51.5	-16.8	-28.5	51.11	90.47	39.36	Pass
13.553	Peak	59.12	0.3	51.5	-16.7	-28.5	65.72	90.47	24.75	Pass
13.567	Peak	58.52	0.3	51.5	-16.7	-28.5	65.12	90.47	25.35	Pass
13.634	Peak	44.36	0.3	51.5	-16.7	-28.5	50.96	90.47	39.51	Pass
13.710	Peak	40.68	0.3	51.5	-16.7	-28.5	47.28	80.5	33.22	Pass
13.771	Peak	39.89	0.3	51.5	-16.7	-28.5	46.49	80.5	34.01	Pass
14.010	Peak	23.41	0.3	51.5	-16.7	-28.5	30.01	69.5	39.49	Pass
14.053	Peak	29.56	0.3	51.5	-16.7	-28.5	36.16	69.5	33.34	Pass

Notes:

See *Transmitter Spurious Radiated Emissions* section in this report for spurious emissions test results outside of the FCC 15.225 bands.

See 'Appendix B – EUT and Test Setup Photos' for photos showing the test set-up.

Client	Square Inc.	
Product	Wireless card reader model SPC1-01	
Standard(s)	RSS 210 Annex B.6, Issue 9:2016 FCC Part 15 Subpart 15.225:2017	

Test Equipment List

Equipment	Model No.	Manufacturer	Last Calibration / Verification Date	Next Calibration / Verification Date	Asset #
Spectrum Analyzer	ESU 40	Rohde & Schwarz	Jan. 12, 2018	Jan. 12, 2020	GEMC 233
Loop Antenna 150 kHz – 30 MHz	EM 6872	Electro-Metrics	Feb 15, 2019	Feb 15, 2021	GEMC 71
Pre-Amp 9 kHz – 1 GHz	LNA 6901	Teseq	Feb. 25, 2019	Feb. 25, 2021	GEMC 168
RF Cable 10m	LMR-400- 10M-50Ω-MN- MN	LexTec	NCR	NCR	GEMC 274
RF Cable 2m	Sucoflex 104A	Huber+Suhner	NCR	NCR	GEMC 271

Client	Square Inc.	
Product	Wireless card reader model SPC1-01	
Standard(s)	RSS 210 Annex B.6, Issue 9:2016 FCC Part 15 Subpart 15.225:2017	

Transmitter Spurious Radiated Emissions

Purpose

The purpose of this test is to ensure that the RF energy unintentionally emitted from the EUT does not exceed the limits listed below as defined in the applicable test standard, as measured from a receiving antenna. This helps protect broadcast radio services such as television, FM radio, pagers, cellular telephones, emergency services, and so on, from unwanted interference.

Limits and Method

The method is defined in ANSI C63.10.

The requirement is stated in FCC 15.225(d), and RSS-210 B.6(d.)

The limits are as defined in 47 CFR FCC Part 15.209 and RSS- Gen (Table 5 and Table 6).

The limits apply for emissions that fall outside the 13.110- 14.010 MHz band.

These limits are as follows:

Frequency	Limit
0.009 MHz – 0.490 MHz	2400/F(kHz) uV/m at 30m ¹
0.490 MHz – 1.705 MHz	24000/F(kHz) uV/m at 30m ¹
1.705 MHz – 30 MHz	30 uV/m at 30m ¹
30 MHz – 88 MHz	100 uV/m (40.0 dBuV/m ¹) at 3m
88 MHz – 216 MHz	150 uV/m (43.5 dBuV/m ¹) at 3m
216 MHz – 960 MHz	200 uV/m (46.0 dBuV/m ¹) at 3m
Above 960 MHz	500 uV/m (54.0 dBuV/m ¹) at 3m
Above 1000 MHz	500 uV/m (54 dBuV/m ²) at 3m
Above 1000 MHz	500 uV/m (74 dBuV/m ³) at 3m

¹Limit is with Quasi Peak detector with bandwidths as defined in CISPR-16-1-1

²Limit is with 1 MHz measurement bandwidth and using an Average detector

³Limit is with 1 MHz measurement bandwidth and using a Peak detector

Based on ANSI C63.4 Section 4.2, if the Peak detector measurements do not exceed the Quasi-Peak limits, where defined, then the EUT is deemed to have passed the requirements.

Client	Square Inc.	
Product	Wireless card reader model SPC1-01	
Standard(s)	RSS 210 Annex B.6, Issue 9:2016 FCC Part 15 Subpart 15.225:2017	

Typical Radiated Emissions Setup

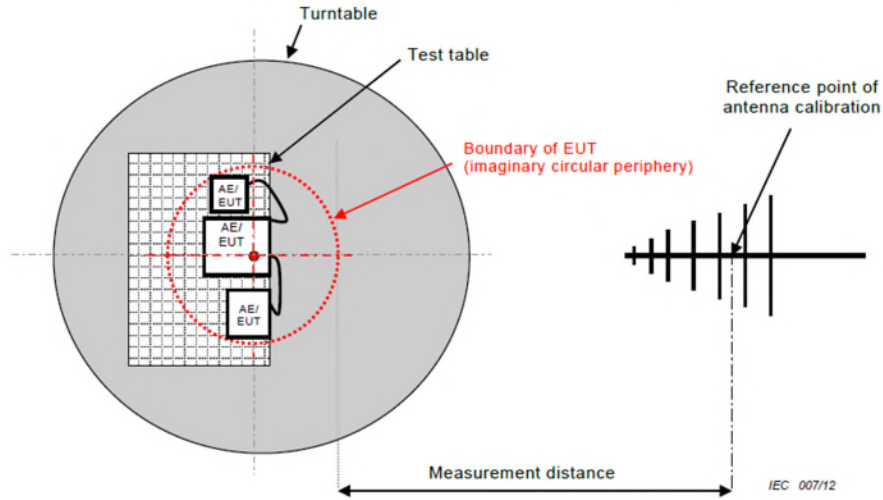

Measurement Uncertainty

The expanded measurement uncertainty is calculated in accordance with CISPR 16-4-2 and is $\pm 4.25\text{dB}$ for 30MHz – 1GHz and $\pm 4.93\text{dB}$ for 1GHz – 18GHz with a 'k=2' coverage factor and a 95% confidence level.

Client	Square Inc.	
Product	Wireless card reader model SPC1-01	
Standard(s)	RSS 210 Annex B.6, Issue 9:2016 FCC Part 15 Subpart 15.225:2017	

Preliminary Graphs

The graphs shown below are maximized peak measurement graphs measured with a resolution bandwidth greater than or equal to the final required detector over a full 0-360°. This peaking process is done as a worst case measurement and enables the detection of frequencies of concern for final measurement. For final measurements with the appropriate detector, where applicable, please refer to the tables under *Final Measurements*.

In accordance with FCC Part 15, Subpart A, Section 15.33, the device was scanned to the 10th harmonic.

Devices scanned may be scanned at alternate test distances and in accordance with FCC Part 15, Subpart A, Section 15.31, an extrapolation factor of 20 dB/decade was used above 30 MHz and 40 dB/decade below 30 MHz.

The three orthogonal axis were investigated. Worst case graphs are presented.

All transmitters in the EUT are on and transmitting continuous modulated data at the maximum power setting used by the manufacturer.

Plots and measurements are made at a 3 meter distance.

See *Radiated Emission Field Strength* section for measurements at the band-edges.

Client	Square Inc.	
Product	Wireless card reader model SPC1-01	
Standard(s)	RSS 210 Annex B.6, Issue 9:2016 FCC Part 15 Subpart 15.225:2017	

9 kHz – 150 kHz
Peak Emission Graph

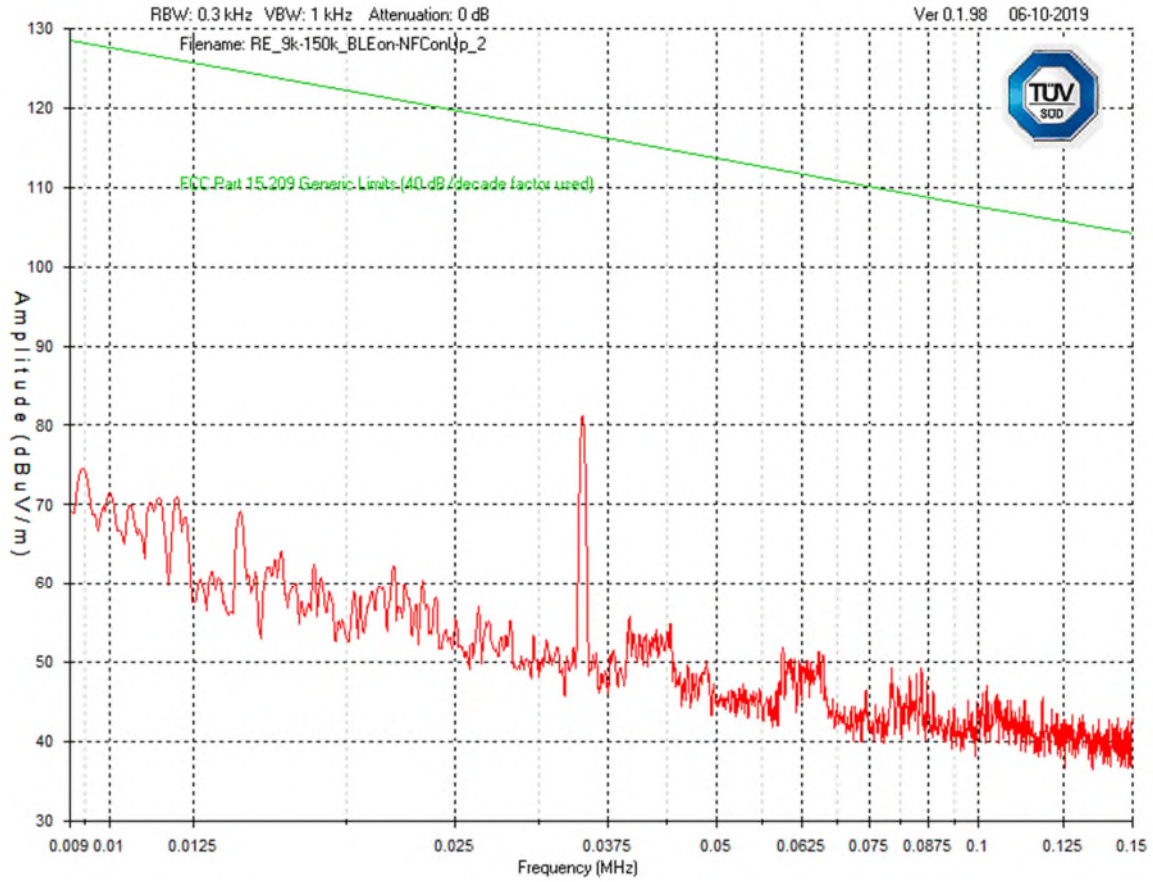

Client	Square Inc.	
Product	Wireless card reader model SPC1-01	
Standard(s)	RSS 210 Annex B.6, Issue 9:2016 FCC Part 15 Subpart 15.225:2017	

150 kHz – 30 MHz
Peak Emission Graph

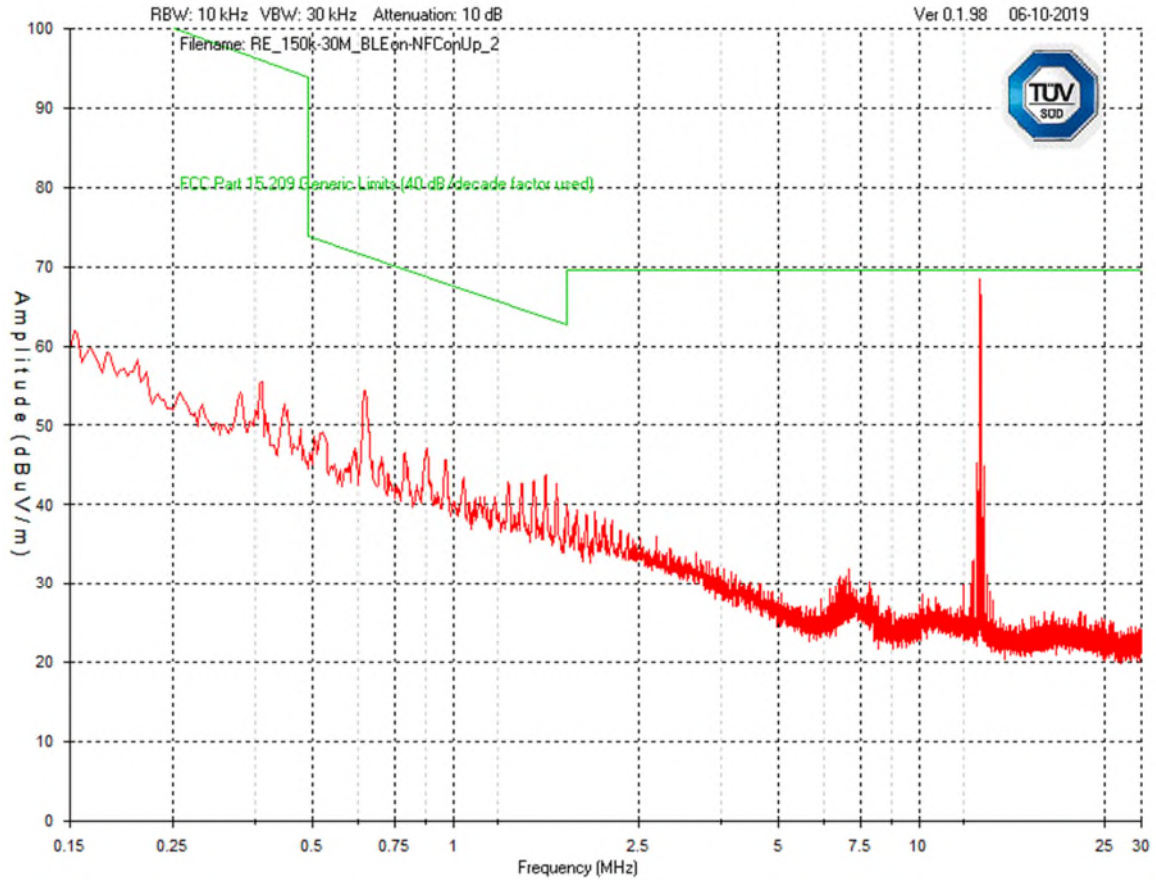

Client	Square Inc.	
Product	Wireless card reader model SPC1-01	
Standard(s)	RSS 210 Annex B.6, Issue 9:2016 FCC Part 15 Subpart 15.225:2017	

30 MHz – 1 GHz
Horizontal - Peak Emission Graph

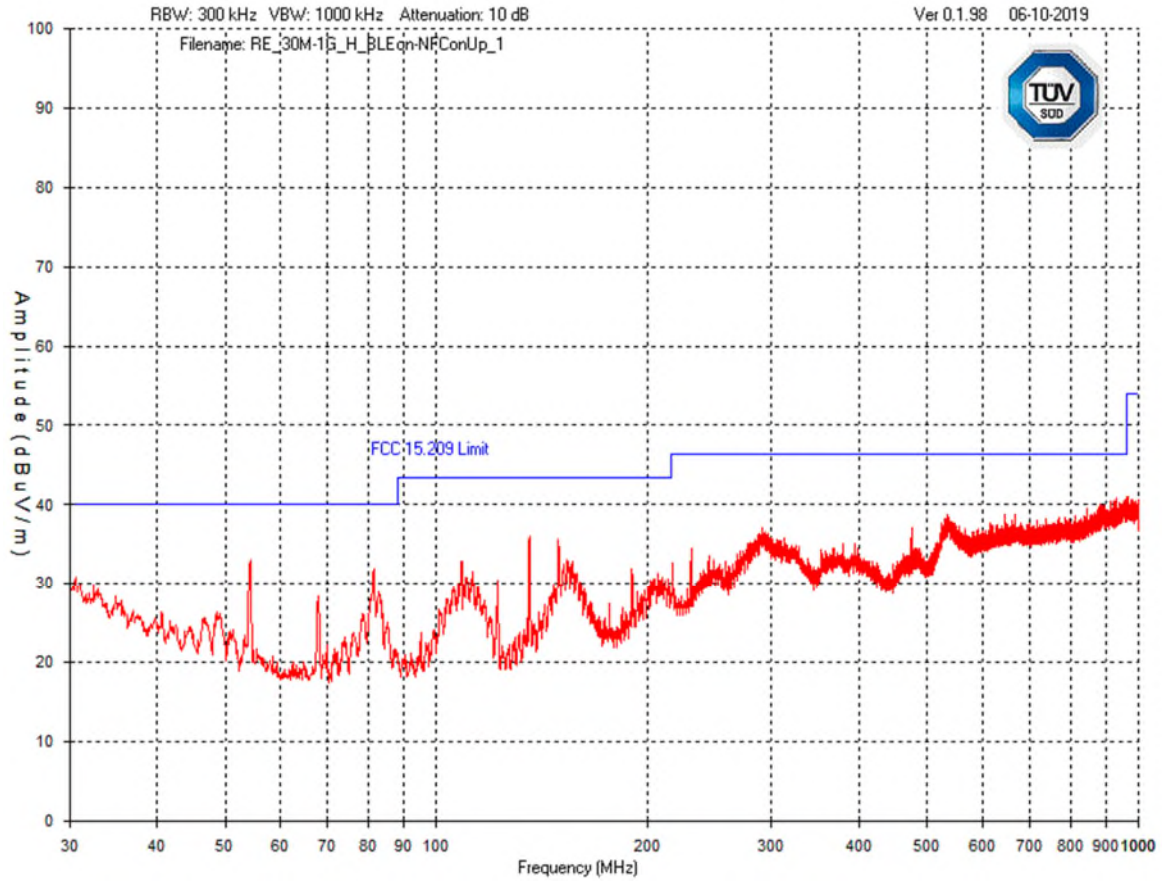

Client	Square Inc.	
Product	Wireless card reader model SPC1-01	
Standard(s)	RSS 210 Annex B.6, Issue 9:2016 FCC Part 15 Subpart 15.225:2017	

30 MHz – 1 GHz
Vertical - Peak Emission Graph

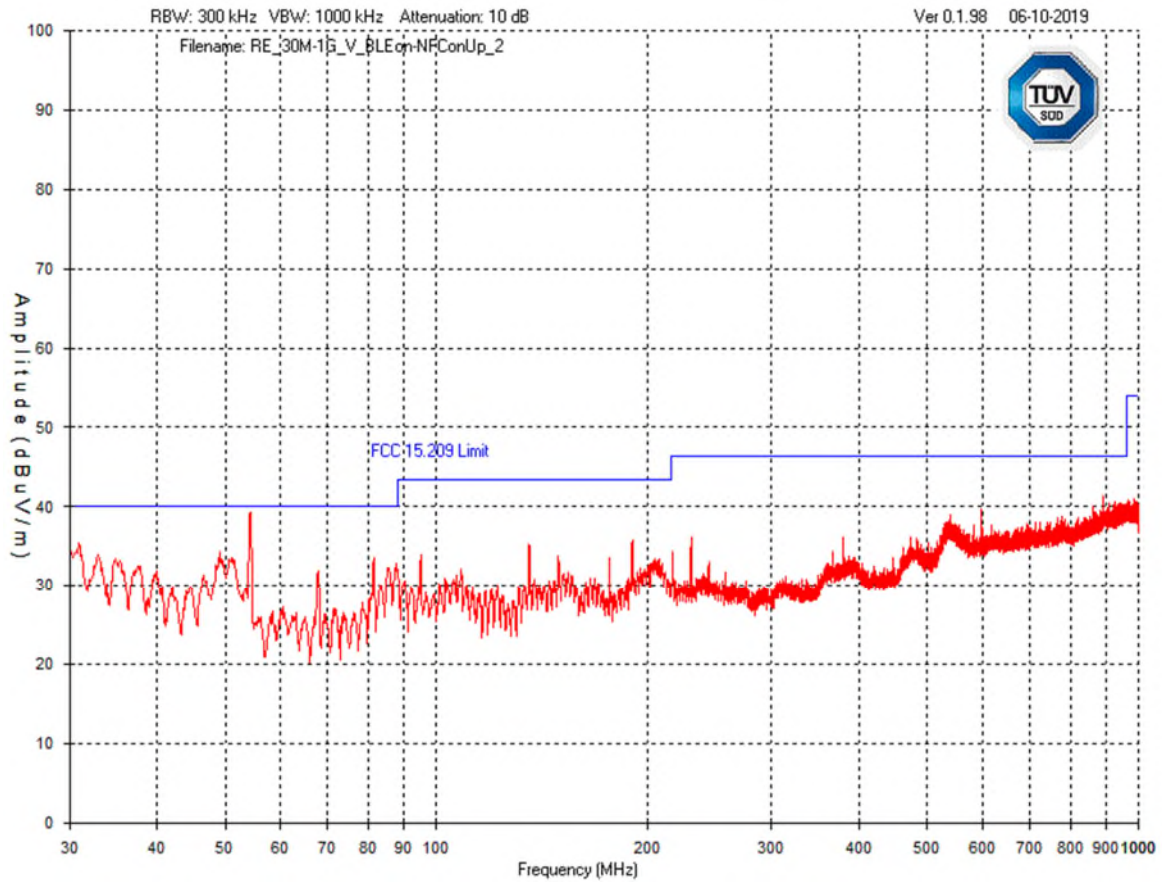

Client	Square Inc.	
Product	Wireless card reader model SPC1-01	
Standard(s)	RSS 210 Annex B.6, Issue 9:2016 FCC Part 15 Subpart 15.225:2017	

Final Measurements and Results

The measurements were maximized by rotating the turn table over a full 0-360° rotation and the antenna height was varied from 1 m to 4 m.

Spurious Radiated Emissions Table

Frequency (MHz)	Detector	Received Signal (dBµV)	Antenna Factor (dB/m)	Atten Factor (dB)	Cable Factor (dB)	Pre-Amp (dB)	Level (dBµV/m)	Limit (dBµV/m)	Margin (dB)	Pass/Fail
Horizontal Antenna Polarization										
54.27	PEAK	47	7.8	6	0.7	-28.5	33	40	7	Pass
135.64	PEAK	50.2	7.1	6	1.2	-28.5	36	43.5	7.5	Pass
149.14	PEAK	48.2	8.6	6	1.3	-28.5	35.6	43.5	7.9	Pass
81.36	PEAK	47.2	6.3	6	0.9	-28.5	31.9	40	8.1	Pass
474.80	PEAK	38.6	18.3	6	3	-28.6	37.3	46.4	9.1	Pass
291.48	PEAK	45.4	12.3	6	2	-28.5	37.2	46.4	9.2	Pass
Vertical Antenna Polarization										
54.27	QP	48.2	7.8	6	0.7	-28.5	34.2	40	5.8	Pass
30.97	PEAK	40.8	16.6	6	0.5	-28.5	35.4	40	4.6	Pass
49.13	PEAK	47.2	8.9	6	0.7	-28.5	34.3	40	5.7	Pass
81.36	PEAK	49	6.3	6	0.9	-28.5	33.7	40	6.3	Pass
87.48	PEAK	47.4	6.9	6	0.9	-28.5	32.7	40	7.3	Pass
190.02	PEAK	46.6	10.1	6	1.5	-28.5	35.7	43.5	7.8	Pass

Client	Square Inc.	
Product	Wireless card reader model SPC1-01	
Standard(s)	RSS 210 Annex B.6, Issue 9:2016 FCC Part 15 Subpart 15.225:2017	

Test Equipment List

Equipment	Model No.	Manufacturer	Last Calibration / Verification Date	Next Calibration / Verification Date	Asset #
Spectrum Analyzer	ESU 40	Rohde & Schwarz	Jan. 12, 2018	Jan. 12, 2020	GEMC 233
Loop Antenna 9 – 150 kHz	EM 6871	Electro-Metrics	Feb 15, 2019	Feb 15, 2021	GEMC 70
Loop Antenna 150 kHz – 30 MHz	EM 6872	Electro-Metrics	Feb 15, 2019	Feb 15, 2021	GEMC 71
BiLog Antenna	3142-C	ETS	Oct. 19, 2018	Oct. 19, 2020	GEMC 8
Pre-Amp 9 kHz – 1 GHz	LNA 6901	Teseq	Feb. 25, 2019	Feb. 25, 2021	GEMC 168
Attenuator 6 dB	612-6-1	Meca Electronics, Inc	NCR	NCR	GEMC 286
RF Cable 10m	LMR-400- 10M-50Ω-MN- MN	LexTec	NCR	NCR	GEMC 274
RF Cable 2m	Sucoflex 104A	Huber+Suhner	NCR	NCR	GEMC 271
Emissions Software	0.1.97	Global EMC	NCR	NCR	GEMC 58

FCC - 15.209 -Radiated Emissions_Rev1

Client	Square Inc.	
Product	Wireless card reader model SPC1-01	
Standard(s)	RSS 210 Annex B.6, Issue 9:2016 FCC Part 15 Subpart 15.225:2017	

Appendix A – EUT Summary

Client	Square Inc.	
Product	Wireless card reader model SPC1-01	
Standard(s)	RSS 210 Annex B.6, Issue 9:2016 FCC Part 15 Subpart 15.225:2017	

For further details for filing purposes, refer to filing package.

General EUT Description

Client Details	
Organization / Address	Square Inc. 1455 Market St. Suite 600 San Francisco, CA USA 95014
Contact	Gavin Demonte
Phone	416-319-7479
Email	gavin@squareup.com
EUT (Equipment Under Test) Details	
EUT Name	Wireless card reader
EUT Model	SPC1-01
EUT is powered using	Internal rechargeable battery charged using USB cable.
Input voltage (V)	USB: 5 VDC Internal rechargeable battery: 3.7 VDC (nominal)
Rated input current (A)	0.5 A
Frequency range(s) (Hz)	BLE: 2402-2480 MHz NFC: 13.56 MHz
Nominal power consumption (W)	2.5 W (max for USB)
Transmits RF energy? (describe)	Bluetooth LE transceiver NFC transceiver
Basic EUT functionality description	Wireless card reader accepting NFC contactless payments and EMV chip card transactions
Modes of operation	Bluetooth LE: 2402-2480 MHz, GFSK modulation. NFC: 13.56 MHz, ASK modulation.
Frequency of all clocks present in EUT	32.768 kHz, 24 MHz, 27.12 MHz
I/O cable description	30 cm micro-USB-to-Type-A cable
Available connectors on EUT	Micro-USB
Peripherals required to exercise EUT	S089 stand (provided by manufacturer)
Dimensions of product	L: 67mm, W: 67mm, H: 11mm

Note the EUT is considered to have been received the date of the commencement of the first test, unless otherwise stated.

For close-up pictures of the EUT, see 'Appendix B – EUT and Test Setup Photos'.

Client	Square Inc.	
Product	Wireless card reader model SPC1-01	
Standard(s)	RSS 210 Annex B.6, Issue 9:2016 FCC Part 15 Subpart 15.225:2017	

Appendix B – EUT and Test Setup Photos

Note: These photos are for information purposes only.
Also refer to submitted files that are separate from this test report.

Client	Square Inc.	
Product	Wireless card reader model SPC1-01	
Standard(s)	RSS 210 Annex B.6, Issue 9:2016 FCC Part 15 Subpart 15.225:2017	



EUT – External view 1

Client	Square Inc.	
Product	Wireless card reader model SPC1-01	
Standard(s)	RSS 210 Annex B.6, Issue 9:2016 FCC Part 15 Subpart 15.225:2017	



EUT – External view 2

Client	Square Inc.	
Product	Wireless card reader model SPC1-01	
Standard(s)	RSS 210 Annex B.6, Issue 9:2016 FCC Part 15 Subpart 15.225:2017	



EUT – Internal view 1
Back cover removed.

Client	Square Inc.	
Product	Wireless card reader model SPC1-01	
Standard(s)	RSS 210 Annex B.6, Issue 9:2016 FCC Part 15 Subpart 15.225:2017	

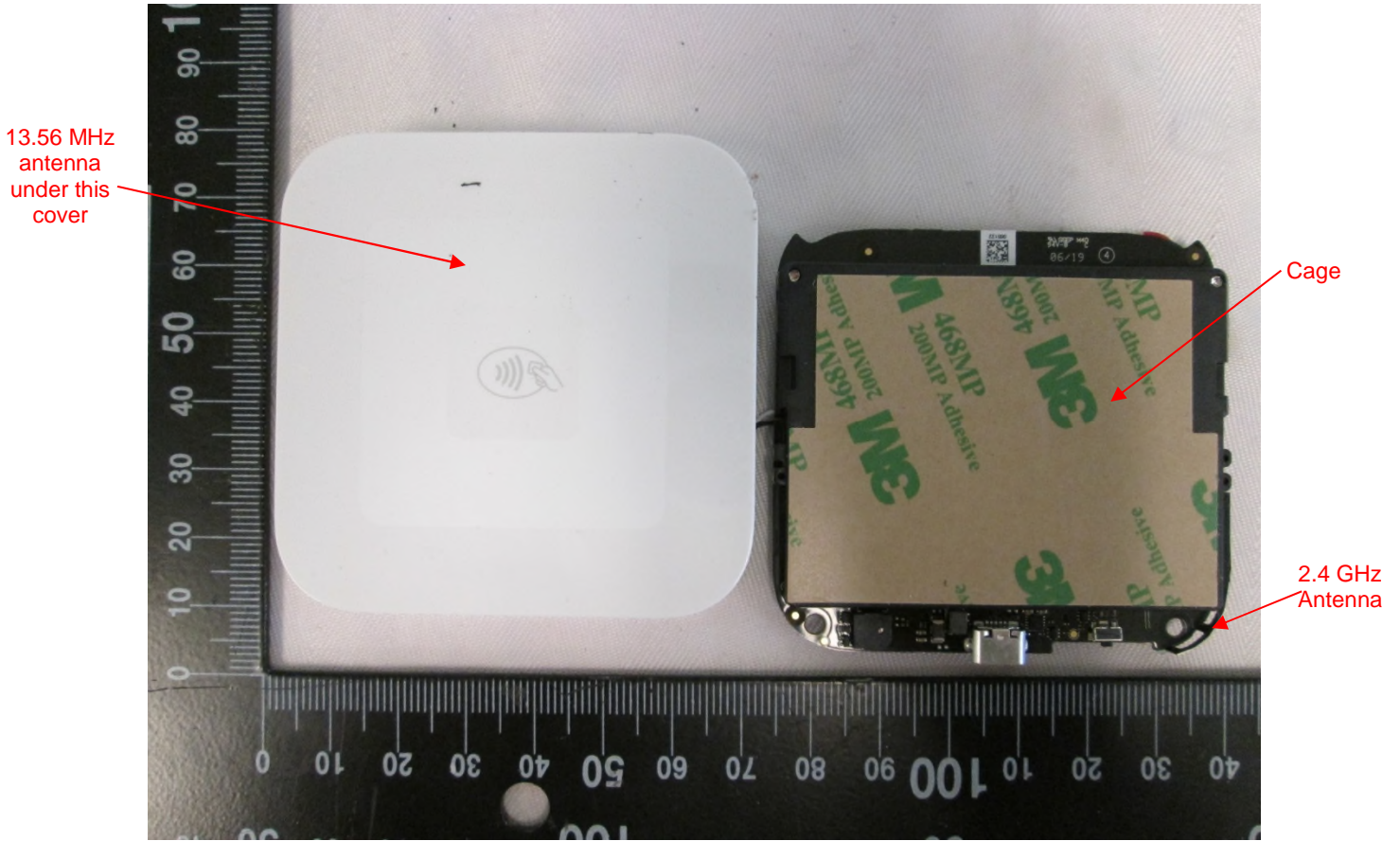

EUT – Internal view 2
PCB removed from enclosure

Client	Square Inc.	
Product	Wireless card reader model SPC1-01	
Standard(s)	RSS 210 Annex B.6, Issue 9:2016 FCC Part 15 Subpart 15.225:2017	

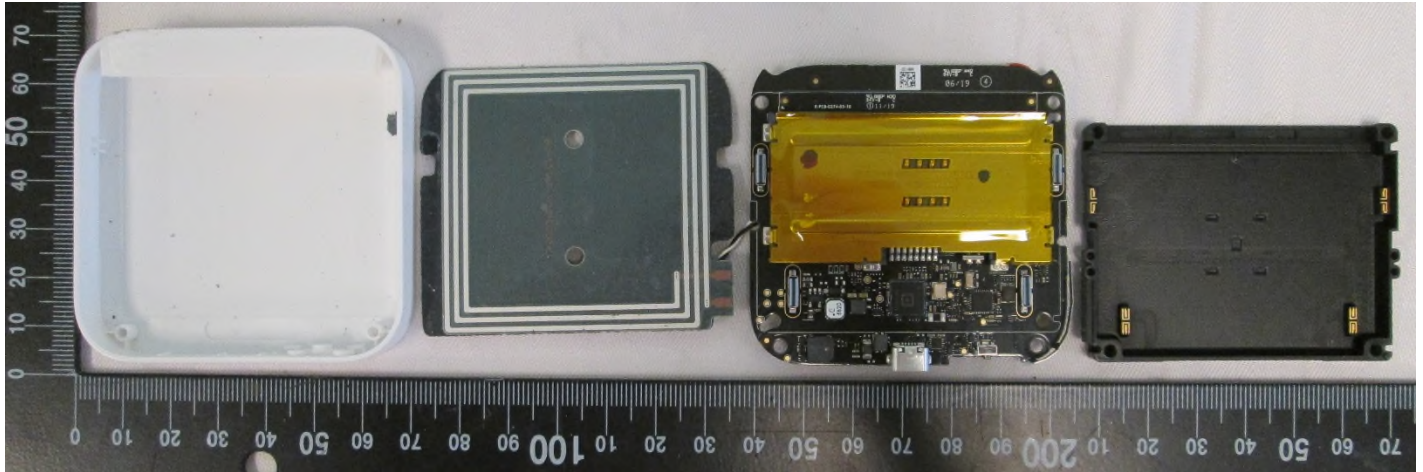

EUT – Internal view 3
 Cage removed.
 Cover removed over 13.56 MHz antenna.

Client	Square Inc.	
Product	Wireless card reader model SPC1-01	
Standard(s)	RSS 210 Annex B.6, Issue 9:2016 FCC Part 15 Subpart 15.225:2017	

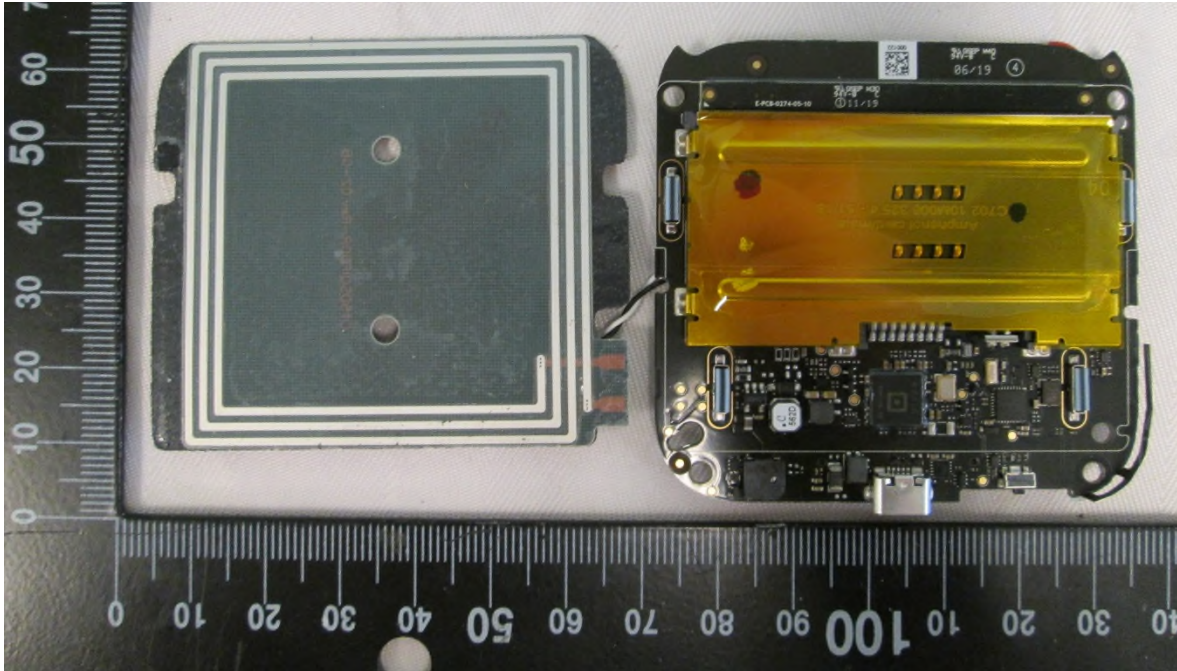

EUT – Internal view 4
Close-up of PCB, side 1

Client	Square Inc.	
Product	Wireless card reader model SPC1-01	
Standard(s)	RSS 210 Annex B.6, Issue 9:2016 FCC Part 15 Subpart 15.225:2017	

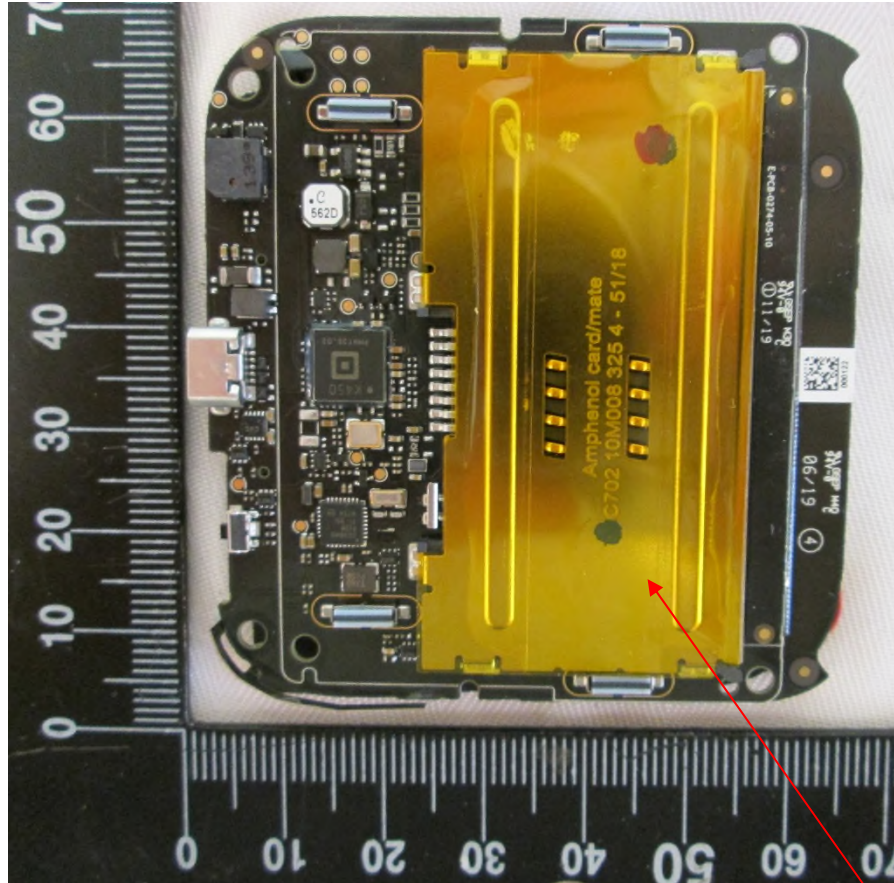

EUT – Internal view 5
Close-up of PCB side 1, alternate view

Contact card socket
soldered directly onto the
PCB. Not a shield. No
components under this part.

Client	Square Inc.	
Product	Wireless card reader model SPC1-01	
Standard(s)	RSS 210 Annex B.6, Issue 9:2016 FCC Part 15 Subpart 15.225:2017	

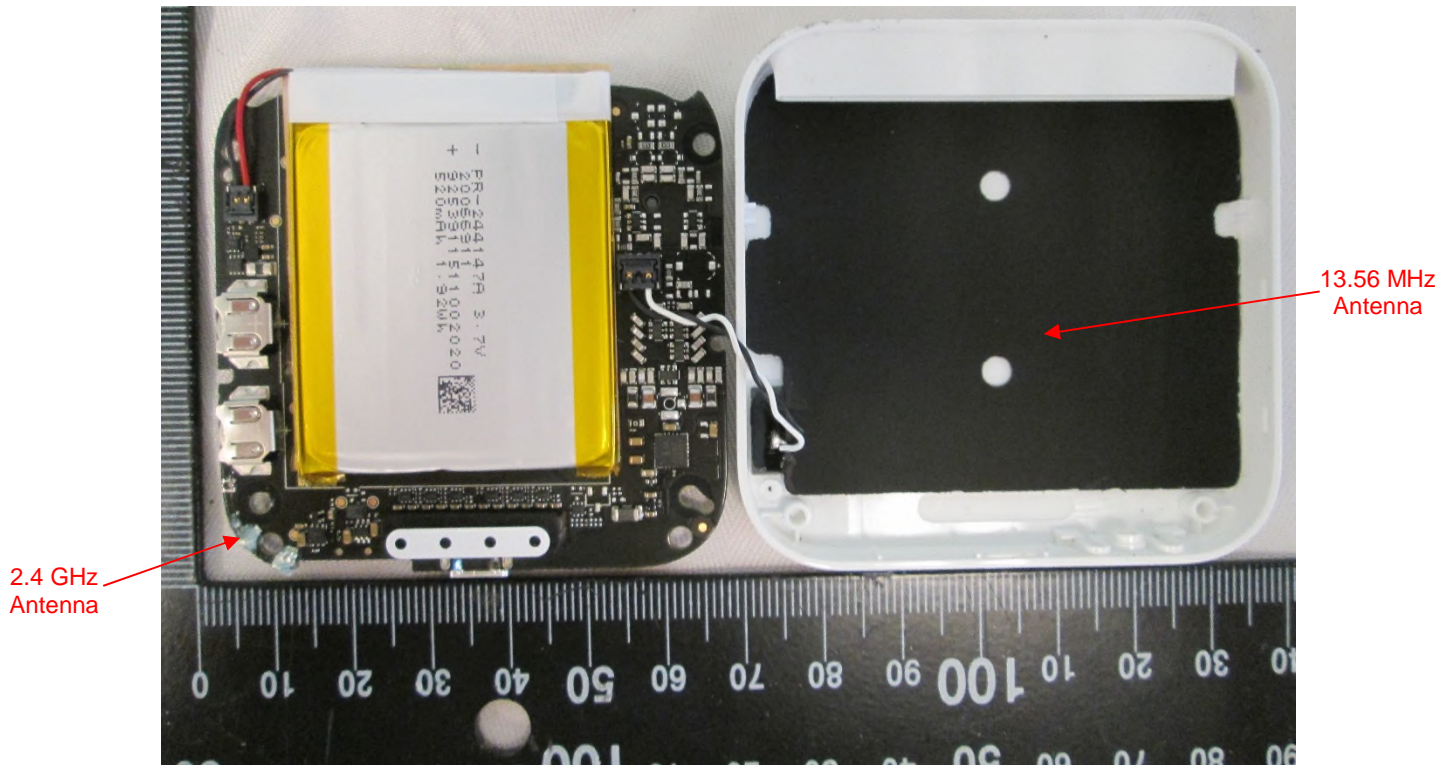

EUT – Internal view 6
PCB removed from enclosure and inverted
PCB side 2 shown.

Client	Square Inc.	
Product	Wireless card reader model SPC1-01	
Standard(s)	RSS 210 Annex B.6, Issue 9:2016 FCC Part 15 Subpart 15.225:2017	

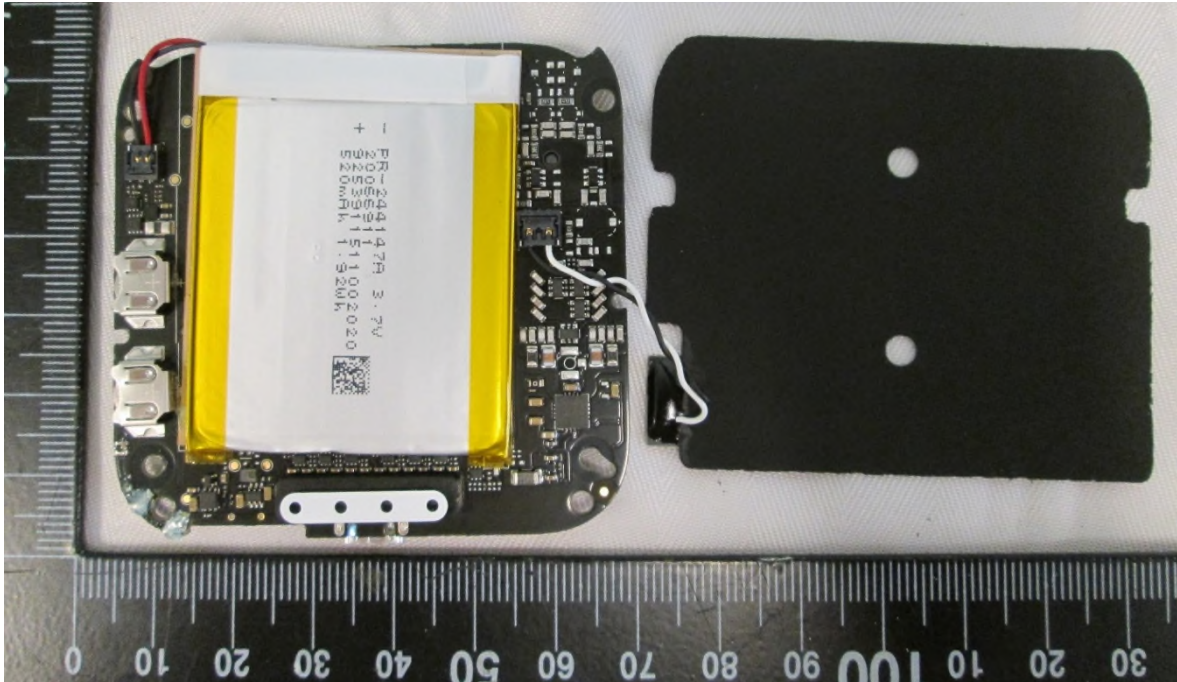

EUT – Internal view 7
Close-up of PCB side 2.

Client	Square Inc.	
Product	Wireless card reader model SPC1-01	
Standard(s)	RSS 210 Annex B.6, Issue 9:2016 FCC Part 15 Subpart 15.225:2017	

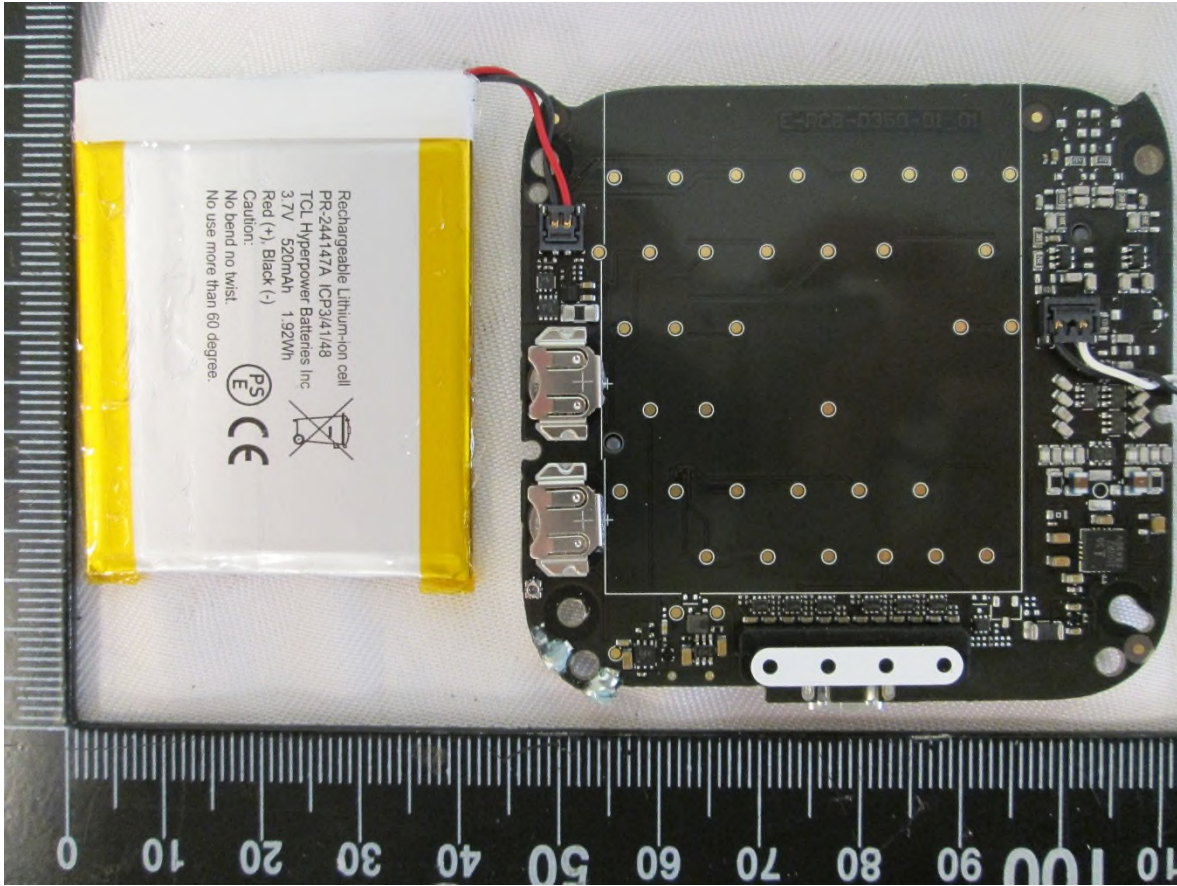

EUT – Internal view 8
Close-up of PCB side 2, with battery moved aside.

Client	Square Inc.	
Product	Wireless card reader model SPC1-01	
Standard(s)	RSS 210 Annex B.6, Issue 9:2016 FCC Part 15 Subpart 15.225:2017	



Test setup photo 1
Radiated measurements, 9 kHz – 30 MHz

Client	Square Inc.	
Product	Wireless card reader model SPC1-01	
Standard(s)	RSS 210 Annex B.6, Issue 9:2016 FCC Part 15 Subpart 15.225:2017	

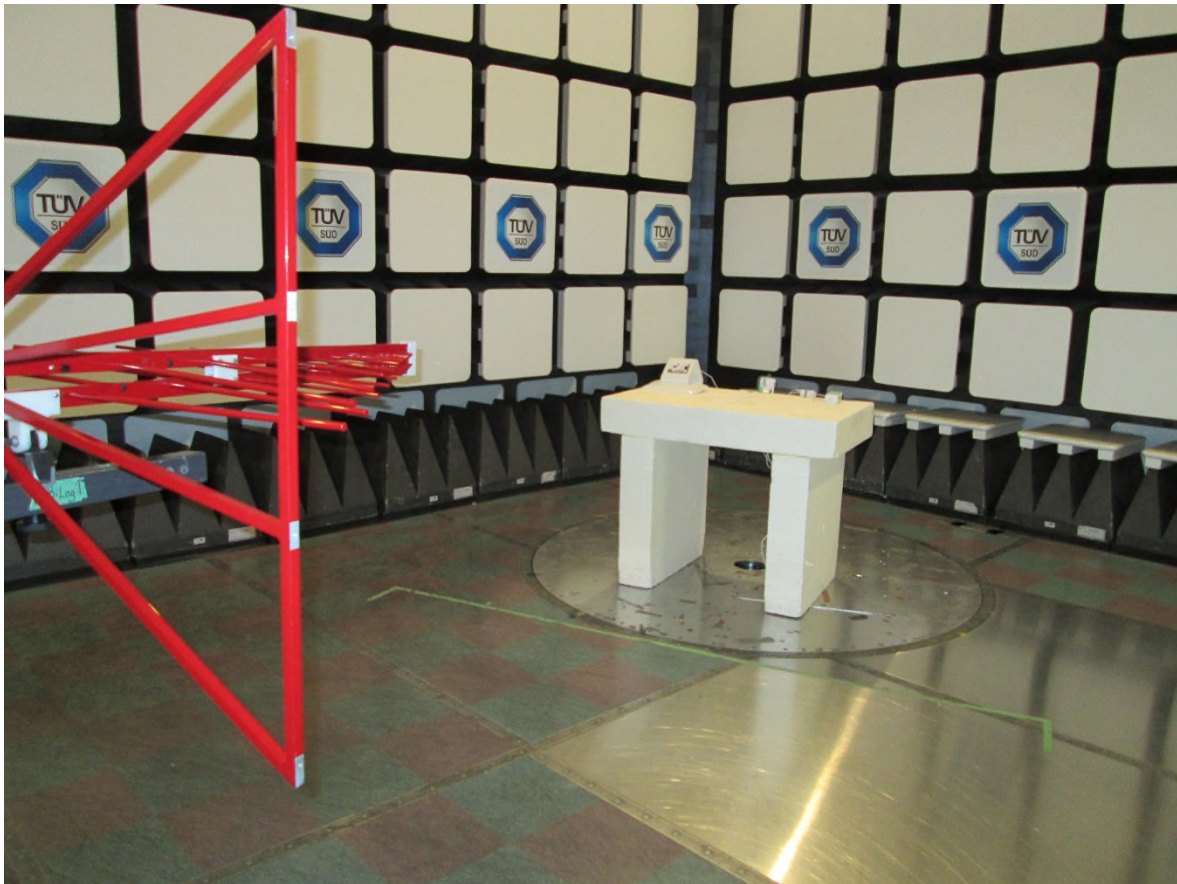

Test setup photo 2
Radiated measurements, 30 MHz – 1 GHz