

Global EMC Inc. Labs

EMC & RF Test Report

As per

FCC Part 15 Subpart C:2015

&

RSS 210 Issue 8:2010

Unlicensed Intentional Radiators

on the

S6 Mobile Credit Card Reader (RFID)



Raymond Lee Au, B.Eng
Project Engineer
Global EMC Inc.
11 Gordon Collins Dr.
Gormley, ON
Canada, L0H 1G0
Ph: (905) 883-8189

Testing produced for



See Appendix A for full customer & EUT details.





Client	Square Inc.	
Product	S6 Mobile Credit Card Reader (RFID)	
Standard(s)	FCC Part 15 Subpart C 15:2015 / RSS 210 Issue 8:2010	

Table of Contents

Table of Contents	2
Report Scope	3
Summary	4
Test Results Summary	5
Notes, Justifications, or Deviations	6
Applicable Standards, Specifications and Methods	8
Sample calculation(s)	9
Document Revision Status	9
Definitions and Acronyms	10
Testing Facility	11
Calibrations and Accreditations	11
Testing Environmental Conditions and Dates	12
Detailed Test Results Section	13
Radiated Emissions – Spurious	14
Radiated Emissions – Fundamental Field Strength	28
20 dB Bandwidth	55
Power Line Conducted Emissions	58
Frequency Stability at Extreme Temperatures	64
Frequency Stability at Extreme Voltages	66
Appendix A – EUT Summary	68
Appendix B – EUT and Test Setup Photographs	69

Client	Square Inc.	
Product	S6 Mobile Credit Card Reader (RFID)	
Standard(s)	FCC Part 15 Subpart C 15:2015 / RSS 210 Issue 8:2010	

Report Scope

This report addresses the EMC testing and test results of the S6 Mobile Credit Card Reader from Square Inc. This unit is herein referred to as EUT (Equipment Under Test). Testing is performed at Global EMC Labs.

The EUT was tested for compliance against the following standards:

RSS 210 Issue 8:2010
FCC Part 15 Subpart C:2015

Test procedures, results, justifications, and engineering considerations, if any, follow later in this report.

The results contained in this report relate only to the item(s) tested.

This report does not imply product endorsement by A2LA or any other accreditation agency, any government, or Global EMC Inc.

Opinions/interpretations expressed in this report, if any, are outside the scope of Global EMC Inc accreditation. Any opinions expressed do not necessarily reflect the opinions of Global EMC Inc, unless otherwise stated.

Client	Square Inc.	
Product	S6 Mobile Credit Card Reader (RFID)	
Standard(s)	FCC Part 15 Subpart C 15:2015 / RSS 210 Issue 8:2010	

Summary

The results contained in this report relate only to the item(s) tested.

EUT FCC Certification #, FCC ID:	2AF3K-1SQHW
EUT Passed all tests performed.	Yes (see test results summary)
Tests conducted by	Raymond Lee Au

Client	Square Inc.	
Product	S6 Mobile Credit Card Reader (RFID)	
Standard(s)	FCC Part 15 Subpart C 15:2015 / RSS 210 Issue 8:2010	

Test Results Summary

Standard/Method	Description	Class/Limit	Result
FCC 15.203	Antenna Requirement	Unique	Pass
FCC 15.205 RSS-Gen (Table 6)	Restricted Bands for intentional operation	Quasi-Peak Average	Pass
FCC 15.207 RSS-Gen (Table 3)	Power Line Conducted Emissions	Quasi-Peak Average	Pass
FCC 15.209 RSS-Gen (Tables 4.5)	Spurious Radiated Emissions	Quasi-Peak Average	Pass
FCC 15.225(a – d)	Fundamental Field Strength	Various 13.110 – 14.010 MHz	Pass
FCC 15.225(e)	Frequency Stability at Extreme Temperatures	-20°C - +50°C	Pass
FCC 15.225(e)	Frequency Stability at Extreme Voltages	85% to 115% of rated.	Pass
Overall Result			PASS

See the following *Notes, Justifications, or Deviations* section for important information regarding these tests.

All tests were performed by Raymond Lee Au.

If the product as tested or otherwise complies with the specification, the EUT is deemed to comply with the requirement and is deemed a 'PASS' grade. If not 'FAIL' grade will be issued. Note that 'PASS' / 'FAIL' grade is independent of any measurement uncertainties.

Client	Square Inc.	
Product	S6 Mobile Credit Card Reader (RFID)	
Standard(s)	FCC Part 15 Subpart C 15:2015 / RSS 210 Issue 8:2010	

Notes, Justifications, or Deviations

The following justifications for tests not performed or deviations from the above listed specifications apply:

The EUT is a portable credit card reader with BLE (2.402 – 2.480 MHz) and NFC RFID (13.56 MHz) capabilities. This report deals with the NFC / RFID characteristics. See report # GEMC-FCC-23230AR1 for the report regarding the BLE, and the device as a whole.

For the antenna requirement specified in FCC 15.203, the NFC antenna is mounted on the PCB, and is sealed within the unit's enclosure. It is not meant to be replicable by the user, nor is it accessible.

The EUT is rated to be operated at a minimum of 0°C. The RFID transmitter does not operate or transmit at -20°C. Therefore, frequency stability test results are available down to -10°C only, as that is the lowest temperature at which the 13.56 MHz transmission is operational.

The EUT was tested in the three orthogonal axes. The worst case results are obtained with the EUT upright. Worst case results are presented for all tests.

See separate RF Exposure Exhibit for this unit regarding the permissible RF exposure levels.

For the Restricted Bands of operation, the 15.225 transmitter is designed to operate at 13.56 MHz.

Class 2 Permissive Change

This report (GEMC-FCC-23230BR2) is an update of report # GEMC-FCC-23230BR1 for a Class 2 Permissive Change. As per the manufacturer, the following changes were made to the EUT:

- Linear regulator (U23) and capacitor (C150), which provide power to the 13.56 MHz NFC chip, are removed, and a 0.0 Ω resistor (R99) is added to directly power the chip.

The voltage input to the NFC chip is unchanged, remaining at 5V. This modification only involves the NFC circuitry. The 2.4 GHz BLE circuitry does not draw power from this part.

Client	Square Inc.	
Product	S6 Mobile Credit Card Reader (RFID)	
Standard(s)	FCC Part 15 Subpart C 15:2015 / RSS 210 Issue 8:2010	

To evaluate the impact of these changes on the EUT, testing of the maximum fundamental emission, spurious emissions, and band edge values, were repeated.

Test results obtained with the changes noted above will be indicated with “C2PC” (Class 2 Permissive Changes) in this report.

Results from testing the EUT after the C2PC are performed with the EUT disconnected from the PC used to program it into the required test states. The manufacturer has reprogrammed the test software to allow the EUT to remain in its test state after disconnection from a PC, allowing testing to be performed with just the EUT inside the test chamber, and results to be unaffected by the presence of auxiliary equipment. This will provide the most accurate results for emissions from the EUT, although passing of the EUT along with auxiliary equipment in the test chamber indicates that the EUT passes alone as well.

Client	Square Inc.	
Product	S6 Mobile Credit Card Reader (RFID)	
Standard(s)	FCC Part 15 Subpart C 15:2015 / RSS 210 Issue 8:2010	

Applicable Standards, Specifications and Methods

- ANSI C63.4:2009 - Methods of Measurement of Radio-Noise Emissions from Low-Voltage Electrical and Electronic Equipment in the Range of 9 kHz to 40 GHz
- ANSI C63.10:2009 - American national standard for testing unlicensed wireless devices
- CFR 47 FCC 15:2015 - Code of Federal Regulations – Radio Frequency Devices
- CISPR 22:2008 - Information technology equipment – Radio disturbance characteristics – Limits and methods of measurement
- ICES-003:2012 - Digital Apparatus - Spectrum Management and Telecommunications Policy Interference-Causing Equipment Standard
- ISO 17025:2005 - General Requirements for the competence of testing and calibration laboratories
- RSS-Gen:2014 - General Requirements and Information for the Certification of Radio Apparatus
- RSS 210:2010 - Issue 8: Licence-exempt Radio Apparatus (All Frequency Bands): Category I Equipment

Client	Square Inc.	
Product	S6 Mobile Credit Card Reader (RFID)	
Standard(s)	FCC Part 15 Subpart C 15:2015 / RSS 210 Issue 8:2010	

Sample calculation(s)

Margin = limit – (received signal + antenna factor + cable loss – pre-amp gain)

Margin = 50.5dBuV/m – (50dBuV + 10dB + 2.5dB – 20dB)

Margin = 8 dB

Document Revision Status

Release 1 - November 29, 2015
- Initial release.

Release 2 - January 7, 2016
- Includes test results from modified power circuitry to NFC chip for Class 2 Permissive Change.

This report replaces any previous reports or drafts in its entirety.

Client	Square Inc.	
Product	S6 Mobile Credit Card Reader (RFID)	
Standard(s)	FCC Part 15 Subpart C 15:2015 / RSS 210 Issue 8:2010	

Definitions and Acronyms

The following definitions and acronyms are applicable in this report.
See also ANSI C63.14.

AE – Auxillary Equipment.

BW – Bandwidth. Unless otherwise stated, this is refers to the 6 dB bandwidth.

C2PC – Class 2 Permissive Change(s)

EMC – Electro-Magnetic Compatibility

EMI – Electro-Magnetic Immunity

EUT – Equipment Under Test

ITE – Information Technology Equipment with a primary function(s) of entry, storage, display, retrieval, transmission, processing, switching, or control, of data.

LISN – Line impedance stabilization network

NCR – No Calibration Required

RF – Radio Frequency

Client	Square Inc.	
Product	S6 Mobile Credit Card Reader (RFID)	
Standard(s)	FCC Part 15 Subpart C 15:2015 / RSS 210 Issue 8:2010	

Testing Facility

Testing for EMC on the EUT was carried out at Global EMC labs in Toronto, Ontario, Canada. The testing lab consists of a 3m semi-anechoic chamber calibrated to be able to allow measurements on an EUT with a maximum width or length of up to 2m and height up to 3m. The chamber is equipped with a turn table that is capable of testing devices up to 3300lb in weight. This facility is capable of testing products that are rated for 120 Vac and 240Vac single phase, or 208 Vac 3 phase input. DC capability is also available. The chamber is equipped with an antenna mast that controls polarization and height from the control room adjoining the shielded chamber. Radiated emissions measurements are performed using a Bilog, and Horn antenna where applicable. Conducted emissions, unless otherwise stated, are performed using a LISN.

Calibrations and Accreditations

The measurement site used is registered with Federal Communications Commission (FCC) and Industry Canada (IC). This site is calibrated for Normalized Site Attenuation (NSA) using test procedures outlined in ANSI C63.4 “Methods of Measurement of Radio-Noise Emissions from Low-Voltage Electrical and Electronic Equipment in the Range of 9 kHz to 40 GHz”. The semi-anechoic chamber is lined with ferrite tiles and absorption cones to minimize any undesired reflections. All measuring equipment is calibrated on an annual or bi-annual basis as listed for each respective test.

Client	Square Inc.	
Product	S6 Mobile Credit Card Reader (RFID)	
Standard(s)	FCC Part 15 Subpart C 15:2015 / RSS 210 Issue 8:2010	

Testing Environmental Conditions and Dates

Following were the environmental conditions in the facility during time of testing –

Date	Test	Init.	Temperature (°C)	Humidity (%)	Pressure (kPa)
Nov. 9, 2015	RE	RA	20-25°C	30-45%	100 -103kPa
Dec. 18, 2015	RE (C2PC)	RA	20-25°C	30-45%	100 -103kPa
Nov. 13, 2015	CE	RA	20-25°C	30-45%	100 -103kPa
Nov. 13, 2015	FFS	RA	20-25°C	30-45%	100 -103kPa
Dec. 18, 2015	FFS (C2PC)	RA	20-25°C	30-45%	100 -103kPa
Nov.10, 2015	BW	RA	20-25°C	30-45%	100 -103kPa
Dec. 18, 2015	BW (C2PC)	RA	20-25°C	30-45%	100 -103kPa
Nov.13, 2015	Temp	RA	20-25°C (Outside temperature chamber)	30-45%	100 -103kPa
Nov.13, 2015	Volt	RA	20-25°C	30-45%	100 -103kPa

RE = Radiated Emissions
 CE = Conducted Emissions
 FFS = Fundamental Field Strength
 BW = Bandwidth Measurements
 Temp = Frequency Stability at Extreme Temperatures
 Volt = Frequency Stability at Extreme Voltages
 C2PC = Class 2 Permissive Change measurement

Client	Square Inc.	
Product	S6 Mobile Credit Card Reader (RFID)	
Standard(s)	FCC Part 15 Subpart C 15:2015 / RSS 210 Issue 8:2010	

Detailed Test Results Section

Client	Square Inc.	
Product	S6 Mobile Credit Card Reader (RFID)	
Standard(s)	FCC Part 15 Subpart C 15:2015 / RSS 210 Issue 8:2010	

Radiated Emissions – Spurious

Purpose

The purpose of this test is to ensure that the RF energy unintentionally emitted from the EUT does not exceed the limits listed below as defined in the applicable test standard, as measured from a receiving antenna. This helps protect broadcast radio services such as television, FM radio, pagers, cellular telephones, emergency services, and so on, from unwanted interference.

Limit(s) and Method

The method is as defined in ANSI C63.4:2009.

The limits are as defined in FCC Part 15, Section 15.209:

0.009 MHz – 0.490 MHz:	2400/ F uV/m (67.6-20log F dBuV/m) at 300 m ⁽¹⁾ (147.6-20log(F) at 3 m) ⁽¹⁾
0.490 MHz – 1.705 MHz:	24000/ F uV/m (87.6-20log(F) dBuV/m) at 30 m ⁽¹⁾ (127.6-20log(F) at 3 m) ⁽¹⁾
1.705 MHz – 30.0 MHz:	30 uV/m (29.5 dBuV/m) at 30 m ⁽¹⁾ , (69.5 dBuV/m at 3m) ⁽¹⁾
30 MHz – 88 MHz:	100 uV/m (40.0 dBuV/m ¹) at 3 m ⁽¹⁾
88 MHz – 216 MHz:	150 uV/m (43.5 dBuV/m ¹) at 3 m ⁽¹⁾
216 MHz – 960 MHz:	200 uV/m (46.0 dBuV/m ¹) at 3 m ⁽¹⁾
Above 960 MHz:	500 uV/m (54.0 dBuV/m ¹) at 3 m ⁽¹⁾
Above 1000 MHz:	500 uV/m (54 dBuV/m ²) at 3m ⁽²⁾
Above 1000 MHz:	500 uV/m (74 dBuV/m ³) at 3m ⁽³⁾

⁽¹⁾ Limit is with Quasi Peak detector with bandwidths as defined in CISPR-16-1-1.

⁽²⁾ Limit is with 1 MHz measurement bandwidth and using an Average detector.

⁽³⁾ Limit is with 1 MHz measurement bandwidth and using a Peak detector

Client	Square Inc.	
Product	S6 Mobile Credit Card Reader (RFID)	
Standard(s)	FCC Part 15 Subpart C 15:2015 / RSS 210 Issue 8:2010	

Typical Radiated Emissions Setup

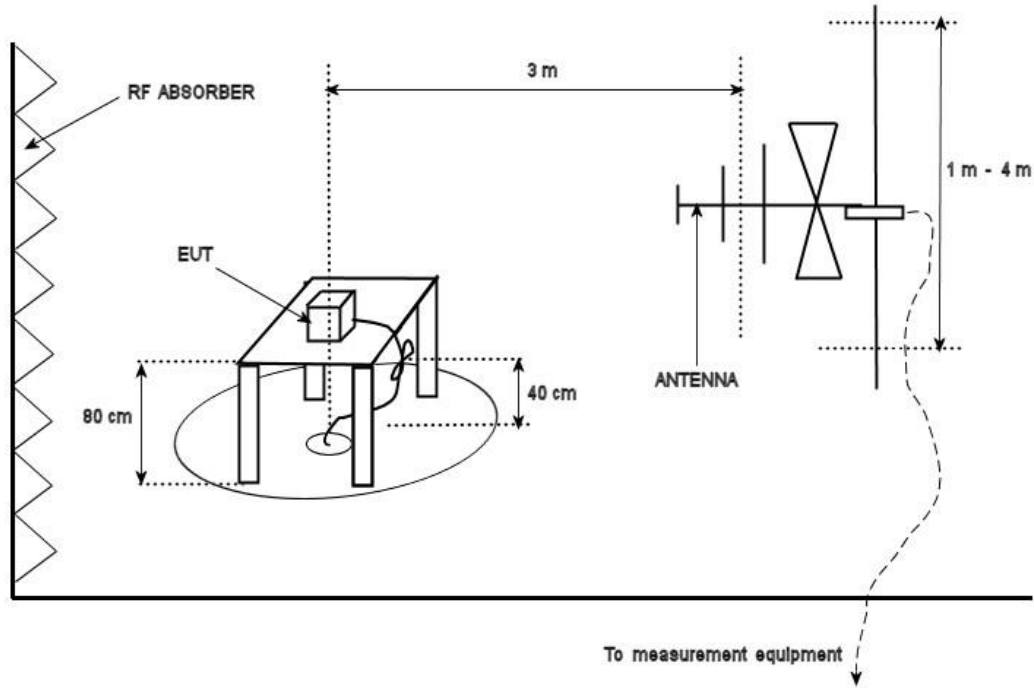

Measurement Uncertainty

The expanded measurement uncertainty is calculated in accordance with CISPR 16-4-2 and is +/-4.4 dB with a 'k=2' coverage factor and a 95% confidence level.

Preliminary Graphs

Note the graphs shown below are for graphical illustration only. For final measurements with the appropriate detector, please refer to the final measurement table where applicable. The graphs shown below are maximized peak measurement graphs, measured with a resolution bandwidth greater than or equal to, the final required detector and over a full 0-360° rotation. This peaking process is done as a worst case measurement. This process enables the detection of frequencies of concern for final measurement, and provides considerable time savings.

In accordance with FCC Part 15, Subpart A, Section 15.33, the device was scanned to the 10th harmonic.

Client	Square Inc.	
Product	S6 Mobile Credit Card Reader (RFID)	
Standard(s)	FCC Part 15 Subpart C 15:2015 / RSS 210 Issue 8:2010	

Devices may be scanned at alternate test distances, and in accordance with FCC Part 15, Subpart A, Section 15.31, an extrapolation factor of 20 dB/decade was used above 30 MHz and 40 dB/decade below 30 MHz. For example for 1 meter measurements, an extrapolation factor 9.5 dB from 20 Log (1m/3m) is applied.

See final measurement section for all measurements.

Both the BLE and the NFC transmitters are active and constantly transmitting modulated data at maximum power during all tests.

Plots and measurements are made at a 3 meter distance.

The 4 initial plots are obtained by testing the EUT while connected to a laptop PC, which is auxiliary equipment. The PC is also in the test chamber during these tests. This is necessary to maintain the EUT in its test state with continuous modulated transmission at maximum power. The tests performed after the C2PC are done with the EUT in the test chamber alone, as the manufacturer has updated test software allowing the EUT to operate in its test state even after being detached from the PC.

Client	Square Inc.	
Product	S6 Mobile Credit Card Reader (RFID)	
Standard(s)	FCC Part 15 Subpart C 15:2015 / RSS 210 Issue 8:2010	

Peak Emissions Graph
9 kHz to 150 kHz

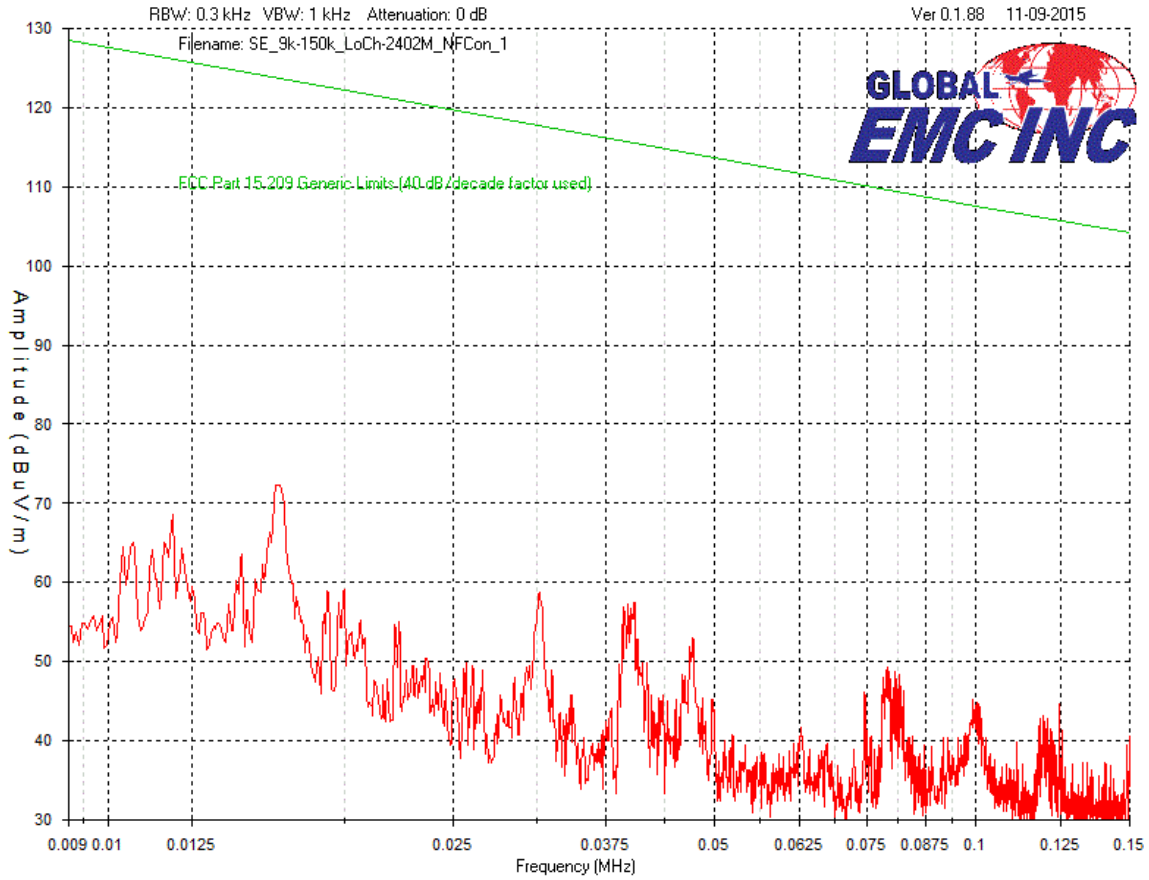

Client	Square Inc.	
Product	S6 Mobile Credit Card Reader (RFID)	
Standard(s)	FCC Part 15 Subpart C 15:2015 / RSS 210 Issue 8:2010	

Peak Emissions Graph
150 kHz to 30 MHz

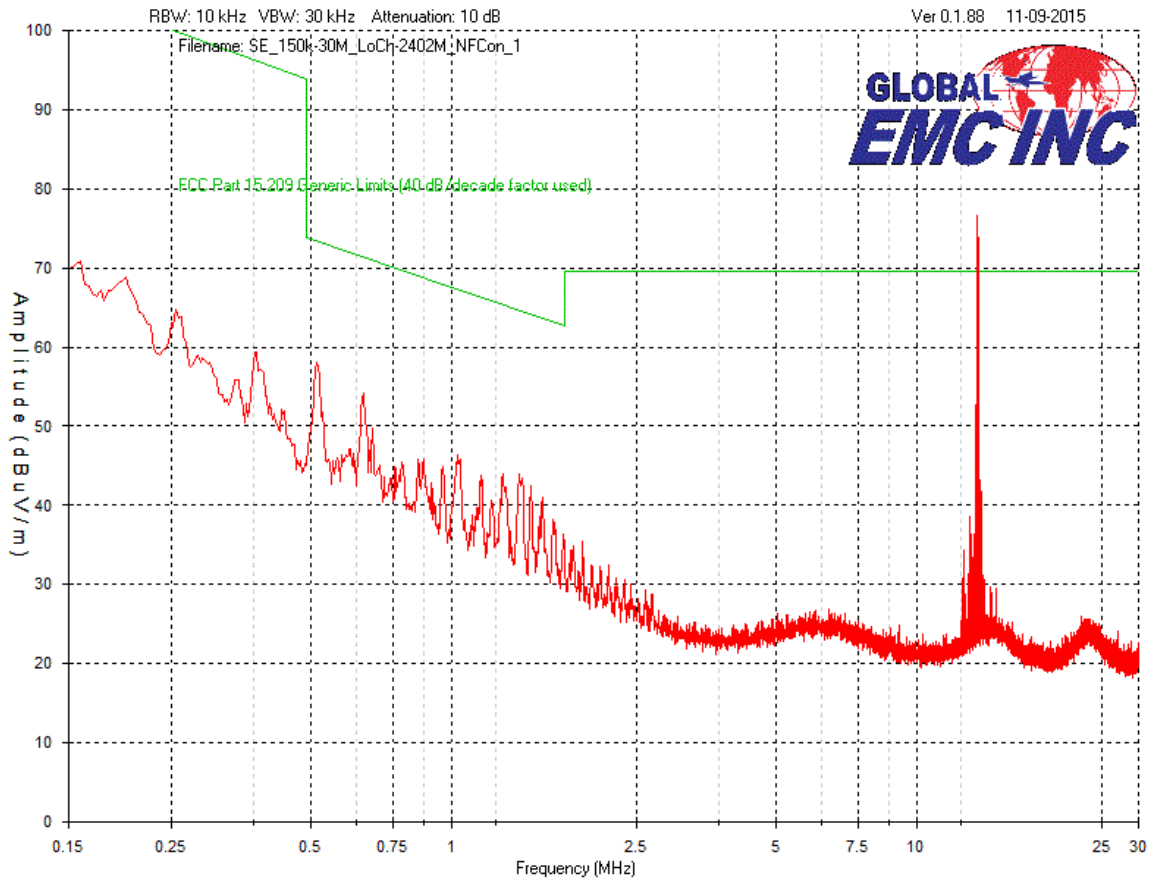

Note: Peak between 10 MHz – 25 MHz is the intentional transmission from the 13.56 MHz RFID.

Client	Square Inc.	
Product	S6 Mobile Credit Card Reader (RFID)	
Standard(s)	FCC Part 15 Subpart C 15:2015 / RSS 210 Issue 8:2010	

Peak Emissions Graph
Vertical Antenna Polarity
30 MHz to 1 GHz

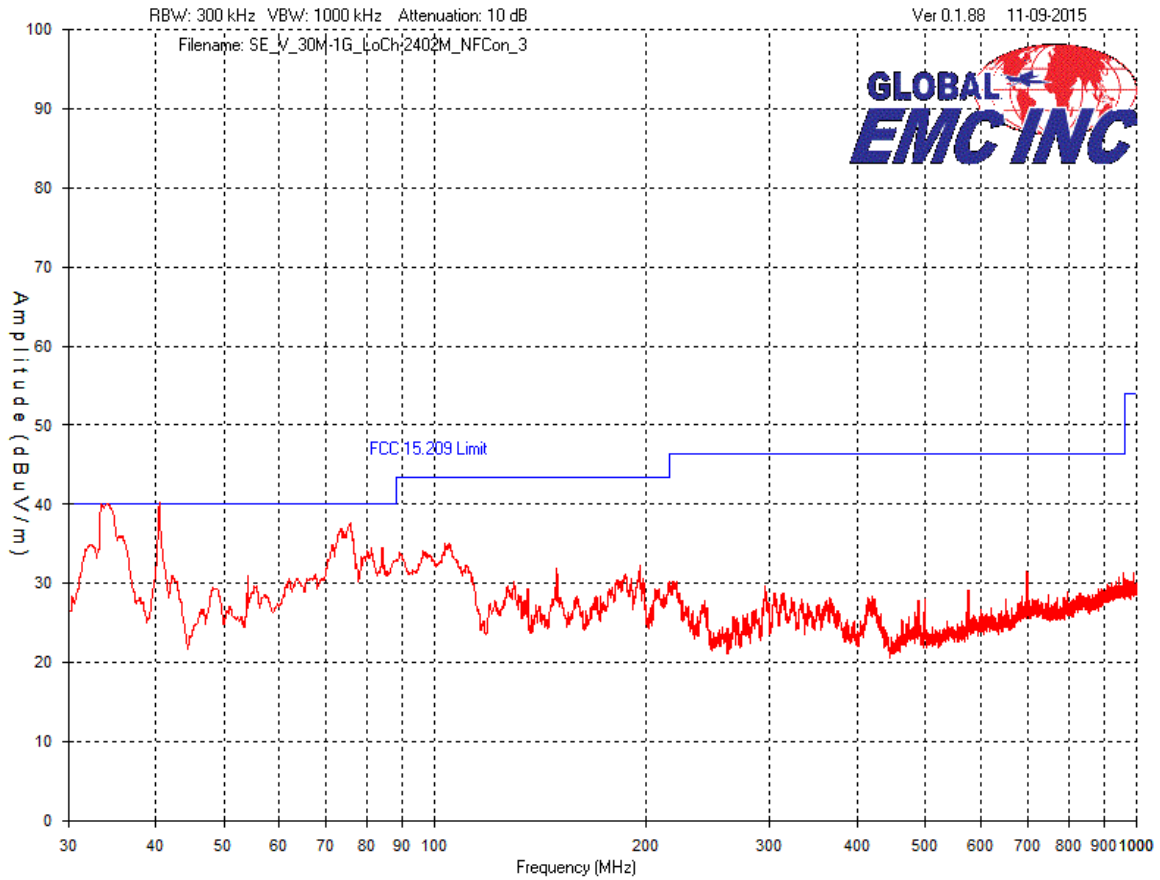

Client	Square Inc.	
Product	S6 Mobile Credit Card Reader (RFID)	
Standard(s)	FCC Part 15 Subpart C 15:2015 / RSS 210 Issue 8:2010	

Peak Emissions Graph
Horizontal Antenna Polarity
30 MHz to 1 GHz

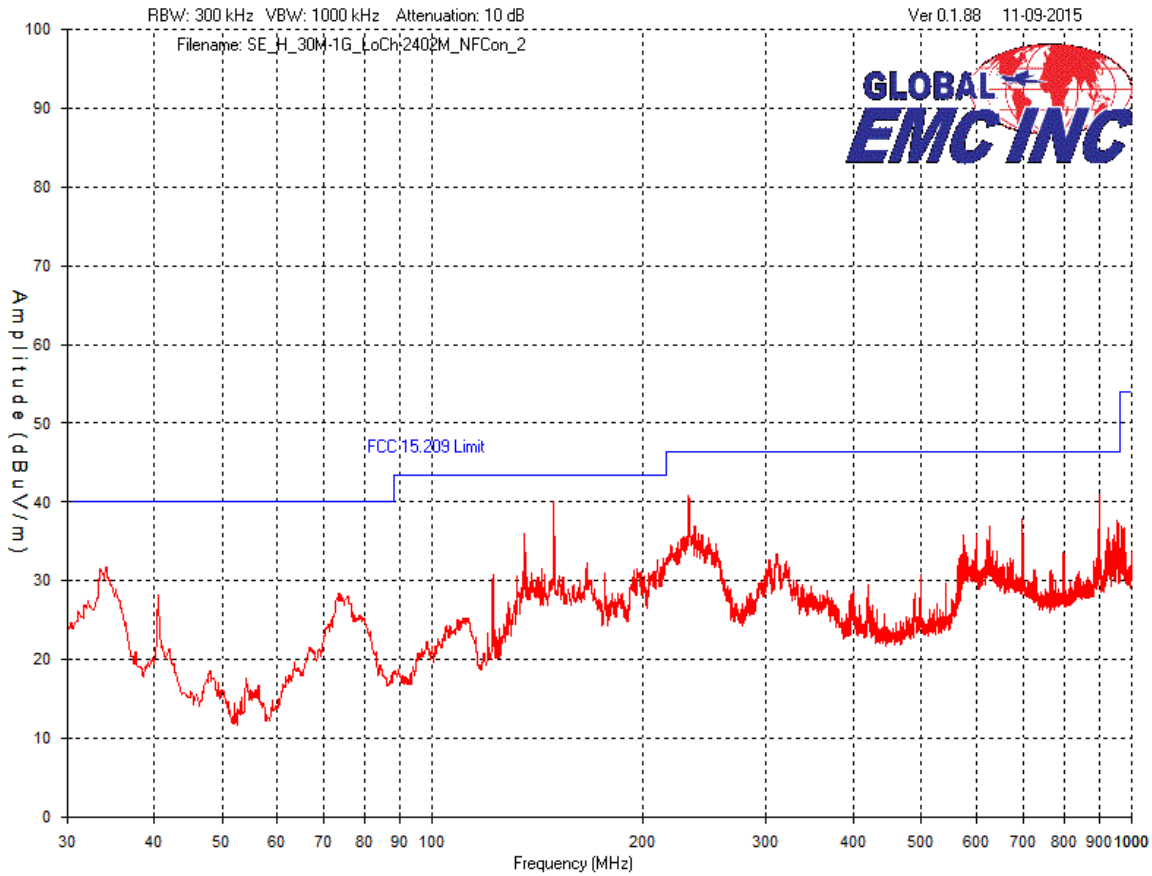

Client	Square Inc.	
Product	S6 Mobile Credit Card Reader (RFID)	
Standard(s)	FCC Part 15 Subpart C 15:2015 / RSS 210 Issue 8:2010	

EUT with C2PC
Peak Emissions Graph
9 kHz to 150 kHz

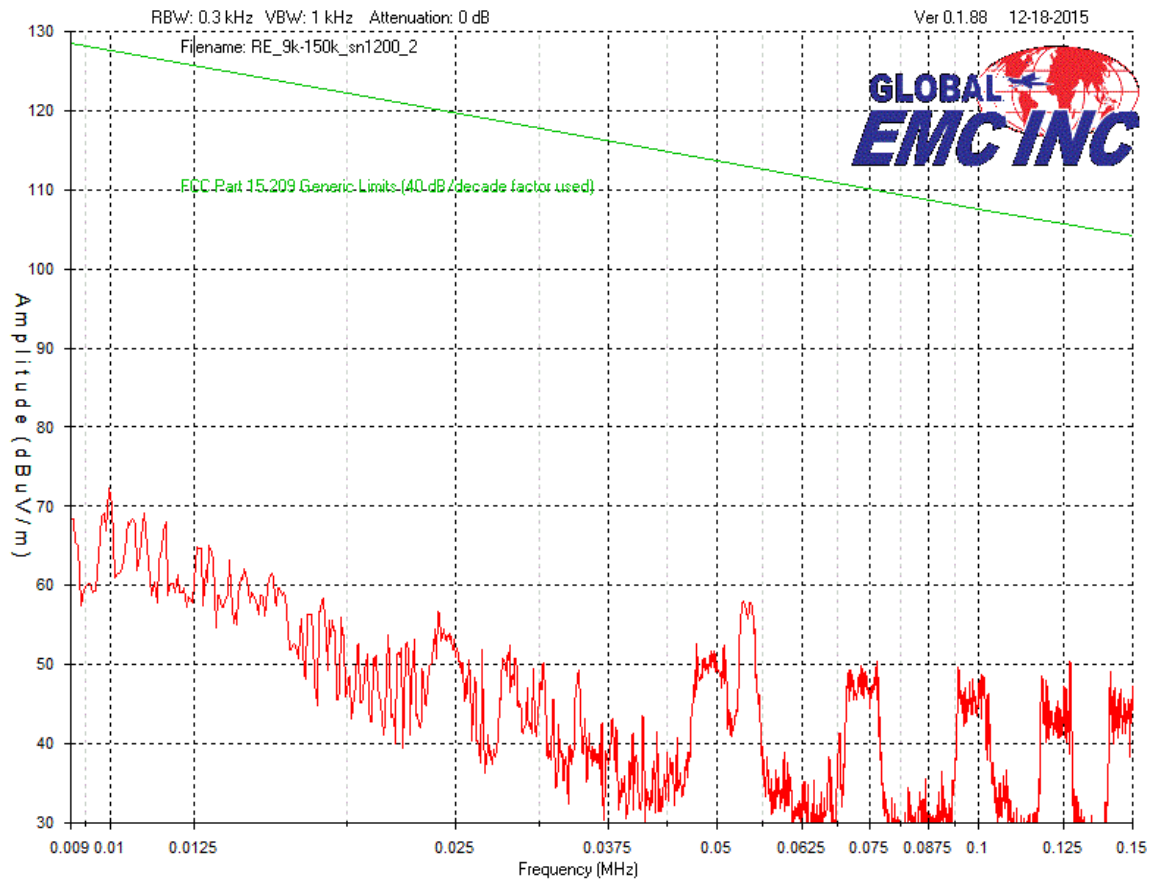

Client	Square Inc.	
Product	S6 Mobile Credit Card Reader (RFID)	
Standard(s)	FCC Part 15 Subpart C 15:2015 / RSS 210 Issue 8:2010	

EUT with C2PC
Peak Emissions Graph
150 kHz to 30 MHz

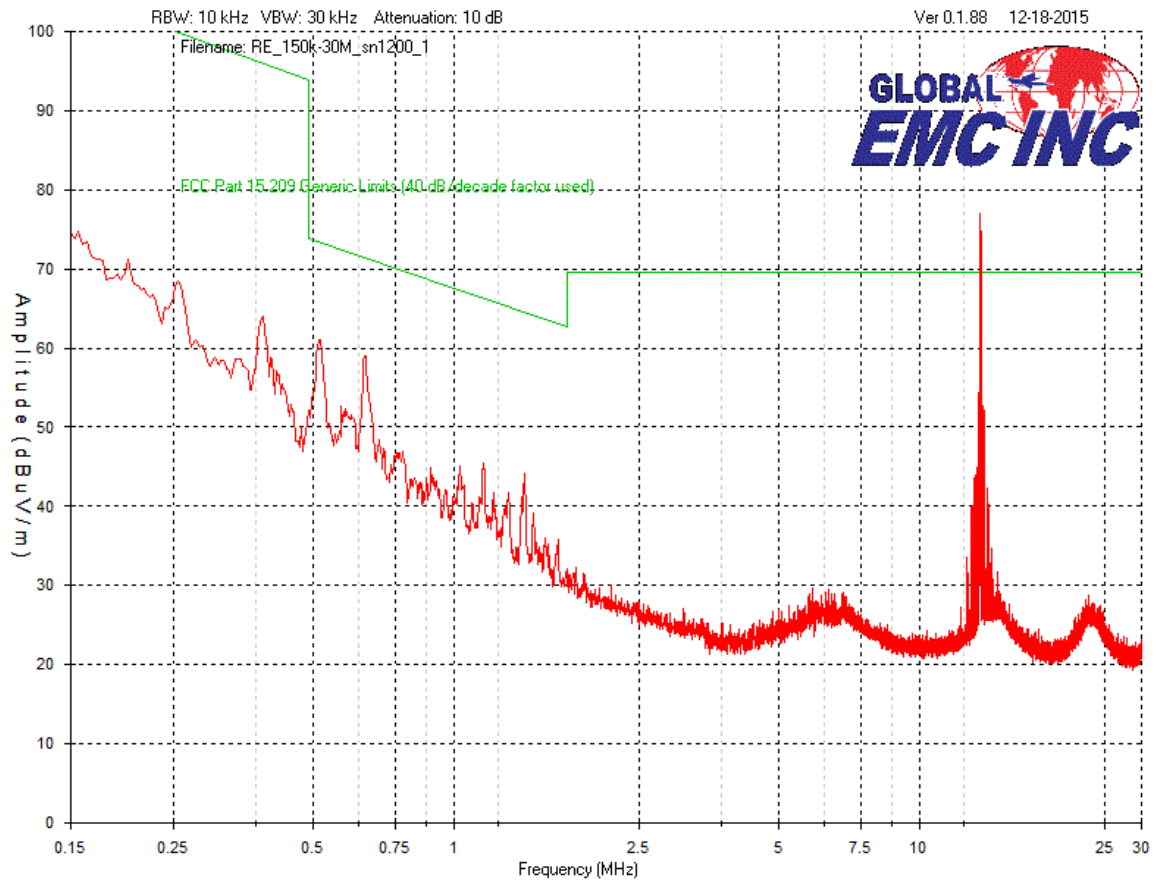

Client	Square Inc.	
Product	S6 Mobile Credit Card Reader (RFID)	
Standard(s)	FCC Part 15 Subpart C 15:2015 / RSS 210 Issue 8:2010	

EUT with C2PC
 Vertical Antenna Polarity
 30 MHz to 1 GHz

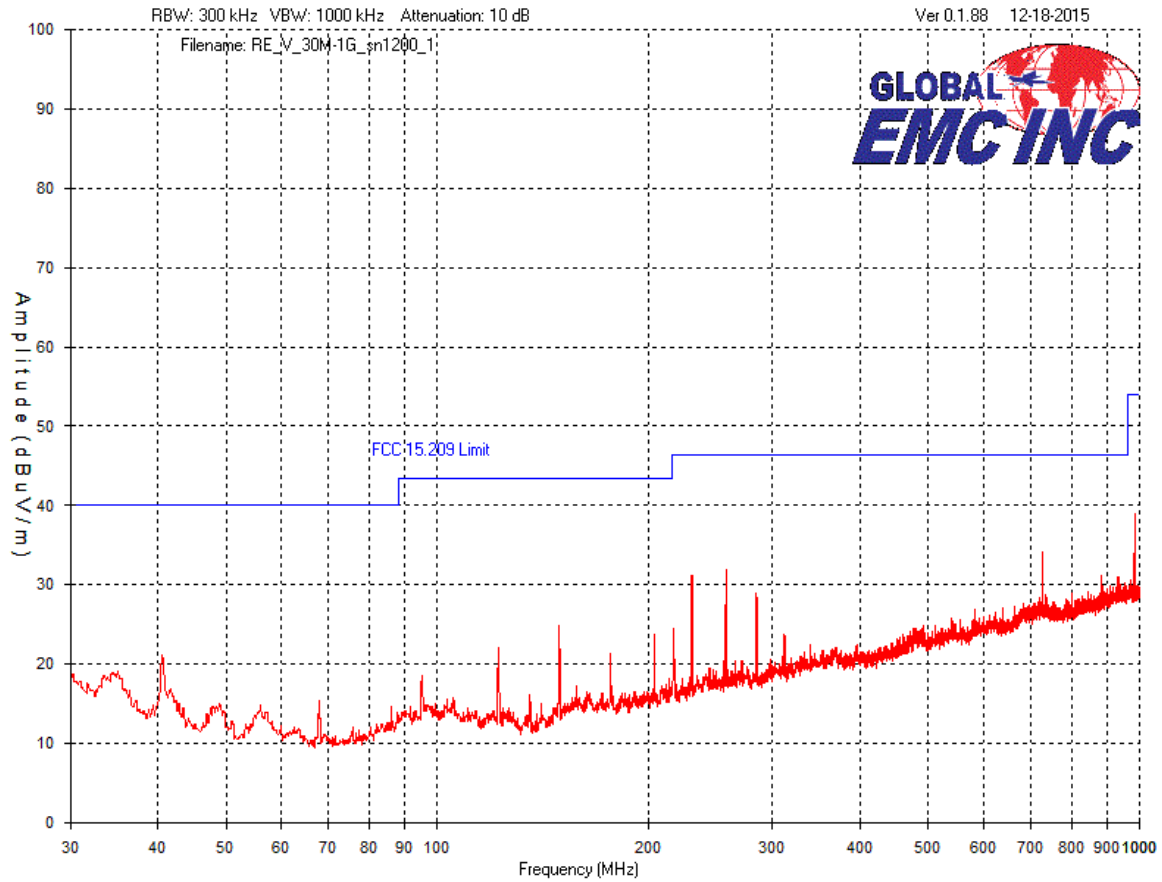

Client	Square Inc.	
Product	S6 Mobile Credit Card Reader (RFID)	
Standard(s)	FCC Part 15 Subpart C 15:2015 / RSS 210 Issue 8:2010	

EUT with C2PC
Horizontal Antenna Polarity
30 MHz to 1 GHz

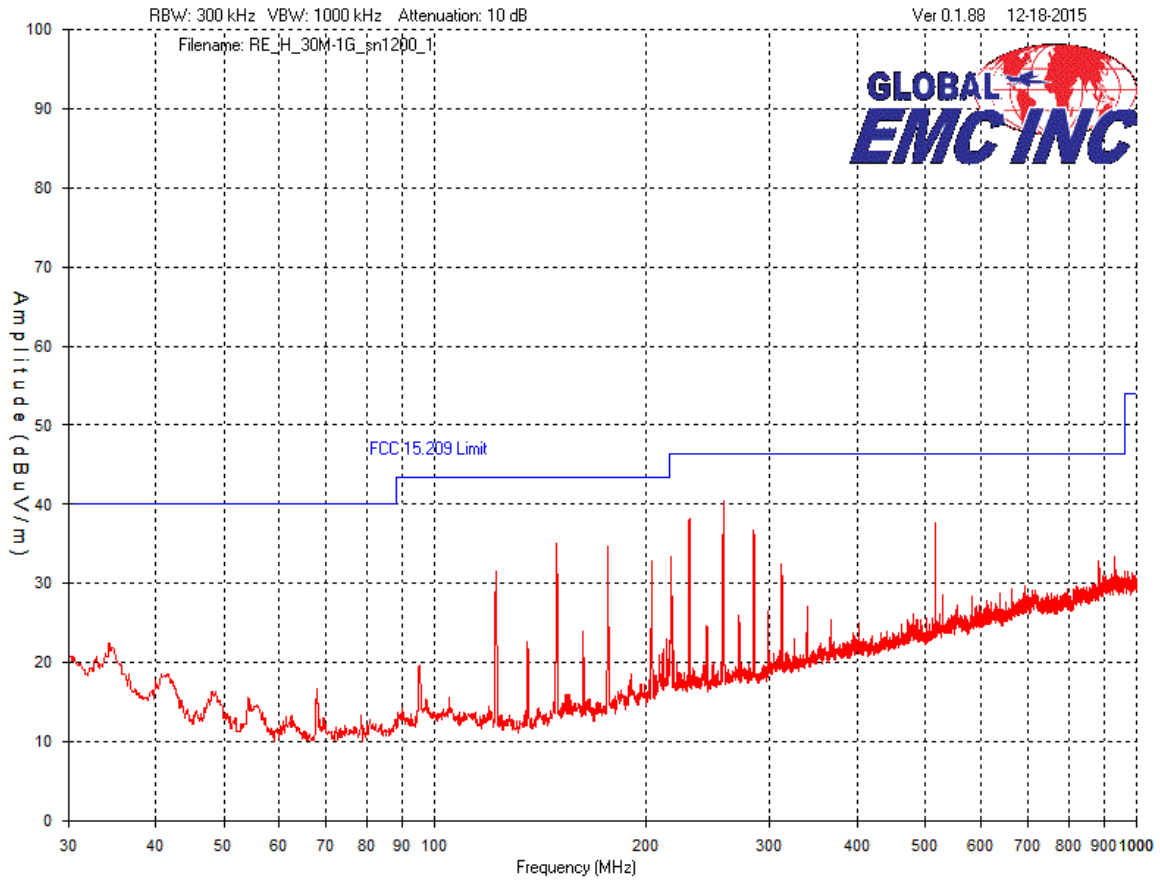

Client	Square Inc.	
Product	S6 Mobile Credit Card Reader (RFID)	
Standard(s)	FCC Part 15 Subpart C 15:2015 / RSS 210 Issue 8:2010	

Final Measurements

Table 1: Radiated Emissions
Spurious emissions
3m measurement distance

Test Frequency (MHz)	Detection mode	Raw signal dB(μ V)	Antenna factor dB	Cable loss dB + Pre-selector	Pre-Amp Gain dB	Received signal dB(μ V/m)	Emission limit dB(μ V/m)	Margin dB(μ V)	Result
Vertical Antenna Polarity									
40.5	QP	56.55	10.2	0.5	-33.1	34.15	40	5.85	Pass
33.5	QP	48.6	13.5	0.5	-33.1	29.5	40	10.5	Pass
75.7	QP	52.61	5.9	0.7	-33.2	26.01	40	13.99	Pass
195.9	Peak	54.3	10.3	1.1	-33.4	32.3	43.5	11.2	Pass
149.1	Peak	55.3	8.9	0.9	-33.2	31.9	43.5	11.6	Pass
129.5	Peak	54.8	7.8	0.9	-33.3	30.2	43.5	13.3	Pass
Horizontal Antenna Polarity									
149.0	Peak	63.4	9	0.9	-33.2	40.1	43.5	3.4	Pass
898.0	Peak	47	23.6	2.3	-31.8	41.1	46.4	5.3	Pass
232.2	Peak	61.3	11.9	1.2	-33.5	40.9	46.4	5.5	Pass
135.4	Peak	60.7	7.6	0.9	-33.2	36	43.5	7.5	Pass
34.1	Peak	48.2	16.2	0.5	-33.1	31.8	40	8.2	Pass
950.5	Peak	43.3	23.6	2.4	-31.5	37.8	46.4	8.6	Pass



Client	Square Inc.	
Product	S6 Mobile Credit Card Reader (RFID)	
Standard(s)	FCC Part 15 Subpart C 15:2015 / RSS 210 Issue 8:2010	

Table 2: EUT with C2PC
Radiated Emissions
Spurious emissions
3m measurement distance

Test Frequency (MHz)	Detection mode	Raw signal dB(μV)	Antenna factor dB	Cable loss dB + Pre-selector	Pre-Amp Gain dB	Received signal dB(μV/m)	Emission limit dB(μV/m)	Margin dB(μV)	Result
Vertical Antenna Polarity									
728.0	Peak	44	21.2	2	-33.2	34	46.4	12.4	Pass
257.6	Peak	51.7	12.6	1.2	-33.6	31.9	46.4	14.5	Pass
982.4	Peak	45.1	22.6	2.4	-31.3	38.8	54	15.2	Pass
230.4	Peak	51.7	11.7	1.2	-33.5	31.1	46.4	15.3	Pass
284.7	Peak	48.5	12.7	1.3	-33.6	28.9	46.4	17.5	Pass
149.0	Peak	48.2	8.9	0.9	-33.2	24.8	43.5	18.7	Pass
Horizontal Antenna Polarity									
257.6	Peak	60.3	12.5	1.2	-33.6	40.4	46.4	6	Pass
230.4	Peak	58.8	11.7	1.2	-33.5	38.2	46.4	8.2	Pass
149.0	Peak	58.5	8.8	0.9	-33.2	35	43.5	8.5	Pass
515.5	Peak	51.2	18.5	1.8	-33.9	37.6	46.4	8.8	Pass
176.3	Peak	57.6	9.5	1	-33.4	34.7	43.5	8.8	Pass
284.7	Peak	56.1	13	1.3	-33.6	36.8	46.4	9.6	Pass

Client	Square Inc.	
Product	S6 Mobile Credit Card Reader (RFID)	
Standard(s)	FCC Part 15 Subpart C 15:2015 / RSS 210 Issue 8:2010	

Test Equipment List

Equipment	Model No.	Manufacturer	Last calibration date	Next calibration due date	Asset #
Spectrum Analyzer	8566B	HP	May 21, 2014	May 21, 2016	GEMC 193
Quasi-Peak Adapter	85650A	HP	May 22, 2014	May 22, 2016	GEMC 194
Loop Antenna 30Hz – 1MHz	EM 6871	Electro-Metrics	Feb. 3, 2015	Feb. 3, 2017	GEMC 70
Loop Antenna 100kHz – 30MHz	EM 6872	Electro-Metrics	Feb. 3, 2015	Feb. 3, 2017	GEMC 71
BiLog Antenna	3142-C	ETS	Feb. 10, 2015	Feb. 10, 2017	GEMC 137
Preamp	CPA9231A	Chase	Sept. 9, 2014	Sept. 9, 2016	GEMC 6403
RF Cable 7m	LMR-400-7M-50OHM-MN-MN	LexTec	NCR	NCR	GEMC 28
RF Cable 1m	LMR-400-1M-50OHM-MN-MN	LexTec	NCR	NCR	GEMC 29

Client	Square Inc.	
Product	S6 Mobile Credit Card Reader (RFID)	
Standard(s)	FCC Part 15 Subpart C 15:2015 / RSS 210 Issue 8:2010	

Radiated Emissions – Fundamental Field Strength

Purpose

The purpose of these tests is to ensure that the RF energy emitted from the EUT does not exceed the limits listed below as defined in the applicable test standard, as measured from a receiving antenna. This helps protect broadcast radio services such as television, FM radio, pagers, cellular telephones, emergency services, and so on, from unwanted interference. RF energy unintentionally emitted from the EUT, and the intentionally emitted fundamental and its harmonics, have limits as shown below.

Limit(s) and Method

The method is as defined in ANSI C63.4:2009 and as per applicable standards.

For the fundamental and harmonics, the limits are as defined in FCC Part 15, Section 15.225 (at 3m):

Frequency Band(s) ⁴	Field strength limits at 30m	Field strength limits at 3m
13.553-13.567 MHz	15,848 $\mu\text{V/m}$	124.0 dB $\mu\text{V/m}$
13.410-13.553 MHz and 13.567-13.710 MHz	334 $\mu\text{V/m}$	90.5 dB $\mu\text{V/m}$
3.110-13.410 MHz and 13.710-14.010 MHz	106 $\mu\text{V/m}$	80.5 dB $\mu\text{V/m}$
Outside 13.110-14.010 MHz	Emission limits of FCC 15.209 apply. See previous section, <i>Radiated Emissions – Spurious</i> .	

⁴ In the frequency band 150 kHz – 30 MHz, the limit is defined with a 9 kHz measurement bandwidth.

To obtain the maximum emission, the loop antenna is positioned with its plane vertical and rotated about its vertical axis at the maximum azimuth position. This is then repeated with its plane horizontal, and rotated about the horizontal axis. The maximum obtained emission is presented.

Client	Square Inc.	
Product	S6 Mobile Credit Card Reader (RFID)	
Standard(s)	FCC Part 15 Subpart C 15:2015 / RSS 210 Issue 8:2010	

Typical Radiated Emissions Setup

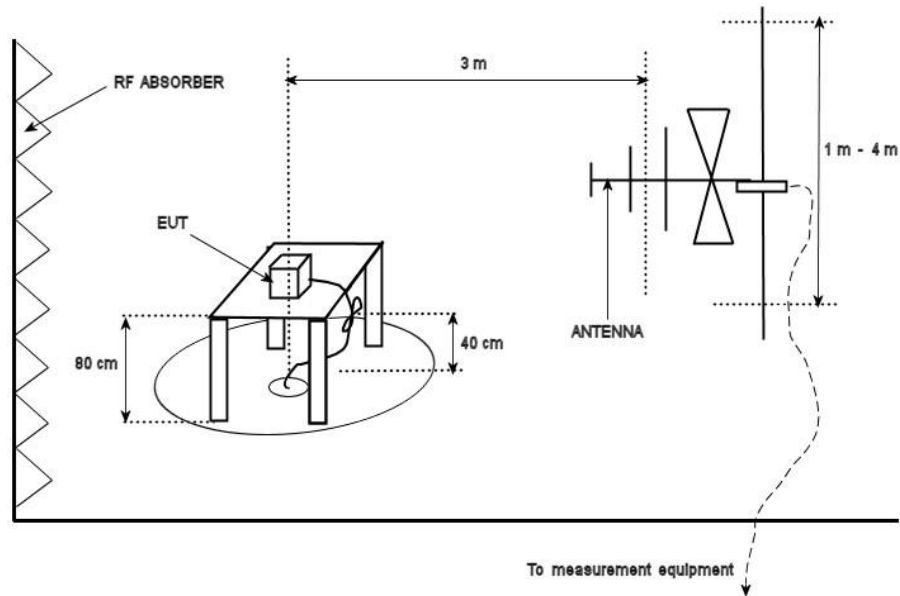

Measurement Uncertainty

The expanded measurement uncertainty is calculated in accordance with CISPR 16-4-2 and is +/-4.4 dB with a 'k=2' coverage factor and a 95% confidence level.

Preliminary Graphs

The graphs shown below are peak scans for graphical illustration only. For final measurements with the appropriate detector, please refer to the final measurement table where applicable. The graph shown below is a maximized peak measurement graph, measured with a resolution bandwidth greater than or equal to, the final required detector and over a full 0-360° rotation. This peaking process is done as a worst case measurement. This process enables the detection of frequencies of concern for final measurement, and provides considerable time savings.

In accordance with FCC Part 15, Subpart A, Section 15.33, the device was scanned to at least the 10th harmonic.

Client	Square Inc.	
Product	S6 Mobile Credit Card Reader (RFID)	
Standard(s)	FCC Part 15 Subpart C 15:2015 / RSS 210 Issue 8:2010	

Peak Emission – Fundamental
13.553-13.567 MHz
3m test distance
(Factors not incorporated. See *Final Measurements.*)

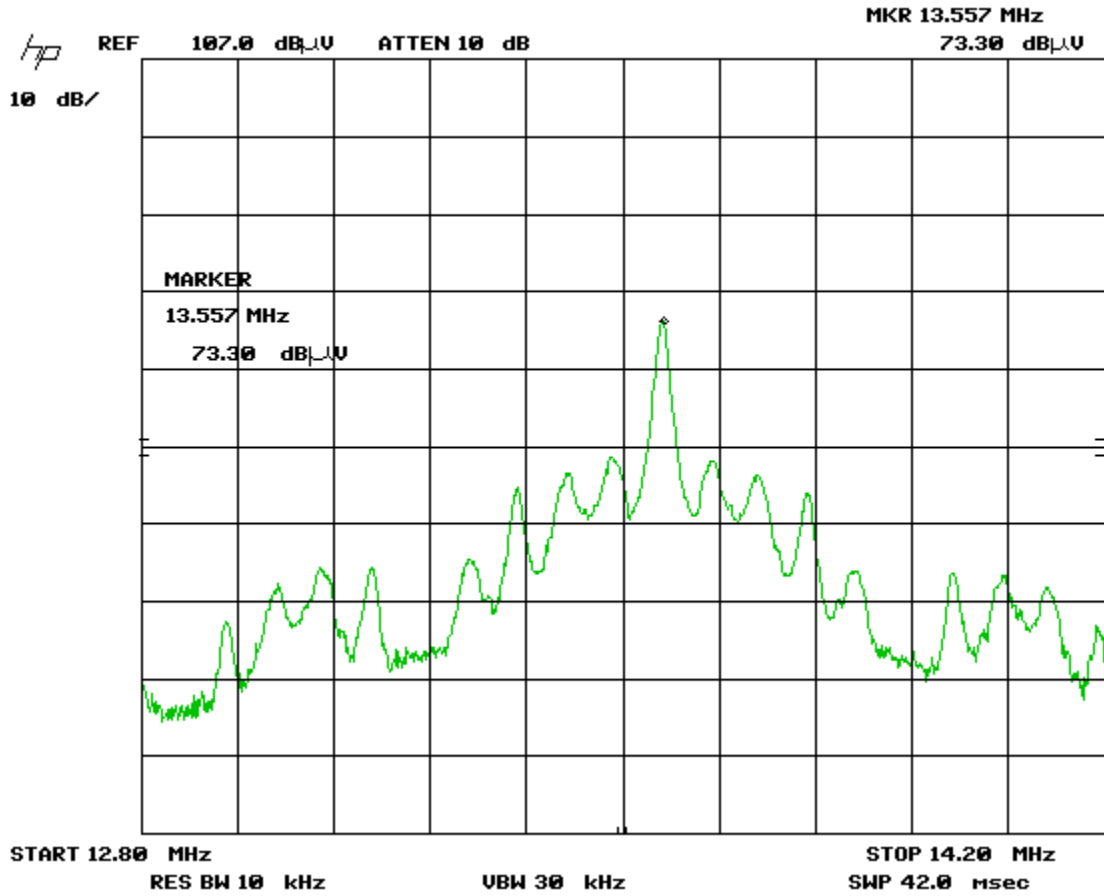

Client	Square Inc.	
Product	S6 Mobile Credit Card Reader (RFID)	
Standard(s)	FCC Part 15 Subpart C 15:2015 / RSS 210 Issue 8:2010	

C2PC
 Peak Emission – Fundamental
 13.553-13.567 MHz
 3m test distance
 (Factors not incorporated. See *Final Measurements.*)

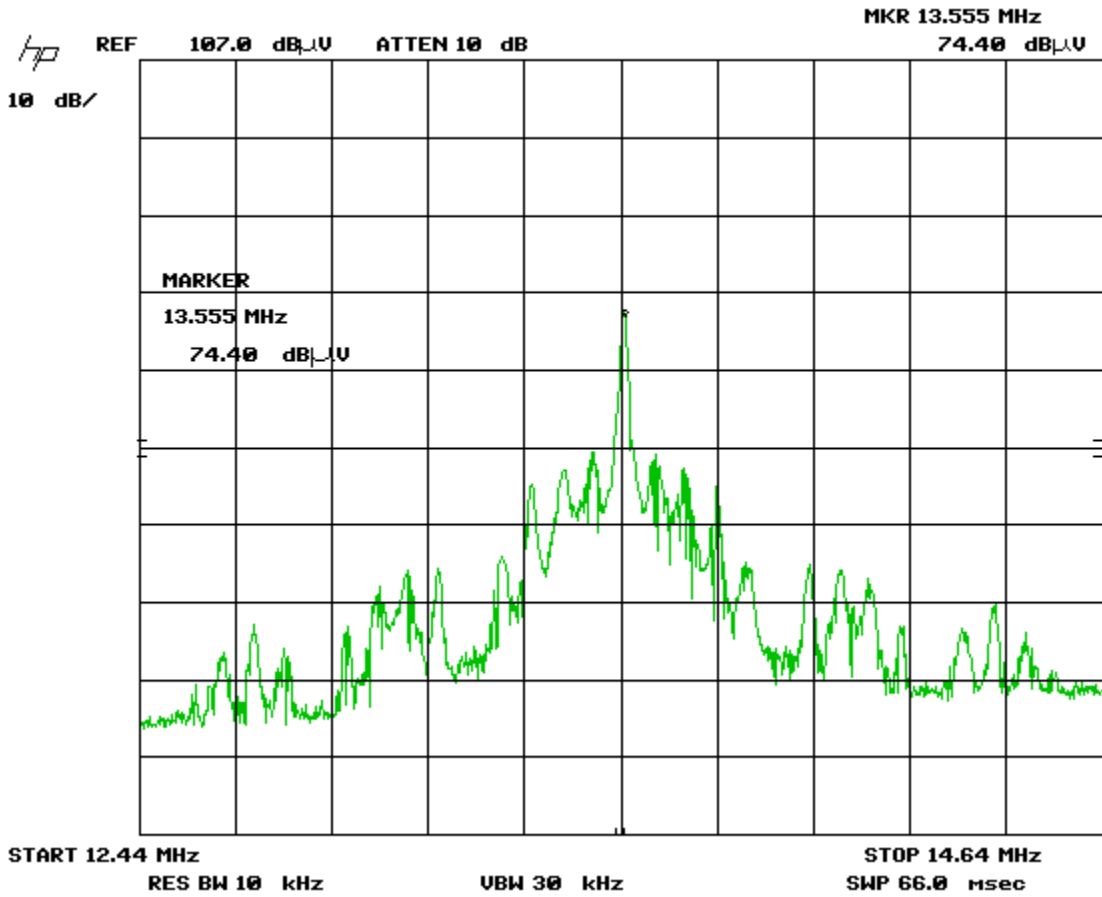

Client	Square Inc.	
Product	S6 Mobile Credit Card Reader (RFID)	
Standard(s)	FCC Part 15 Subpart C 15:2015 / RSS 210 Issue 8:2010	

Peak Emission – Band Edges
13.410-13.553 MHz
3m test distance
(Factors not incorporated. See *Final Measurements.*)

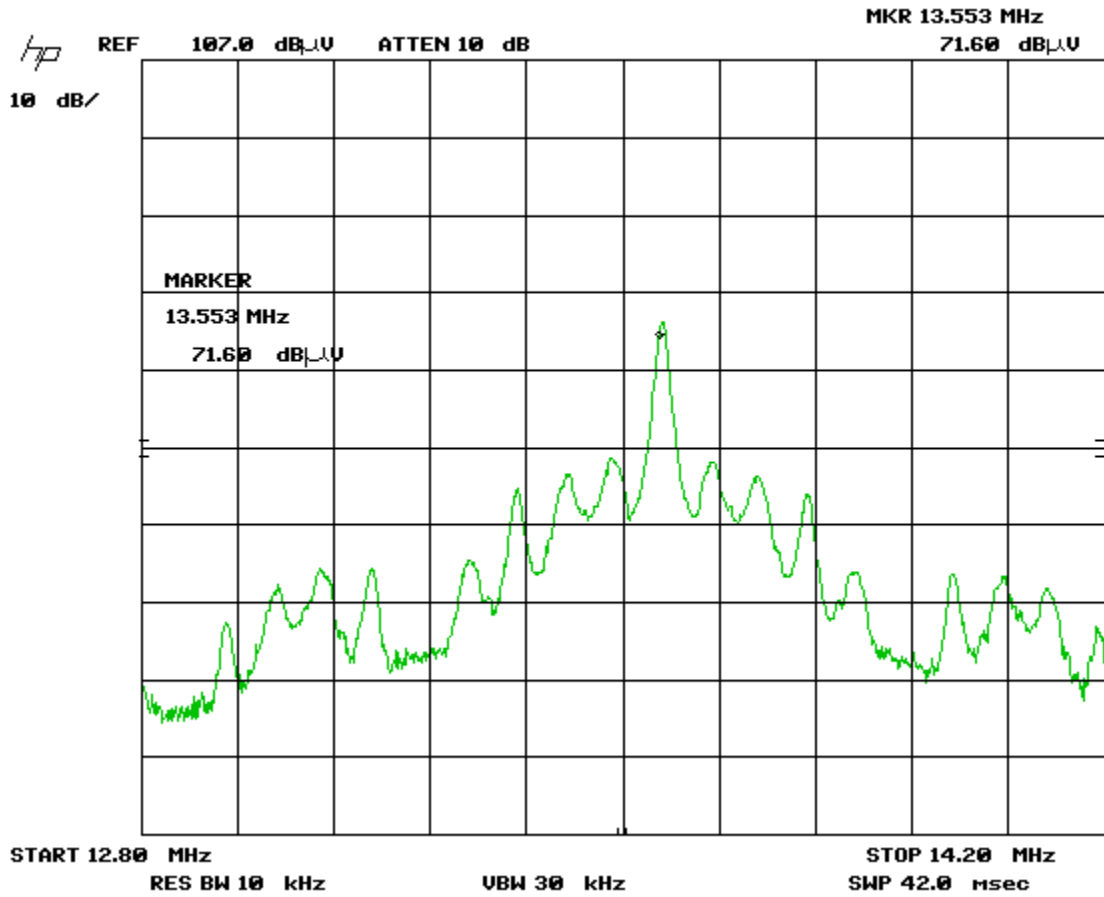

Client	Square Inc.	
Product	S6 Mobile Credit Card Reader (RFID)	
Standard(s)	FCC Part 15 Subpart C 15:2015 / RSS 210 Issue 8:2010	

Peak Emission – Band Edges
13.110-13.410 MHz
3m test distance
(Factors not incorporated. See *Final Measurements*.)

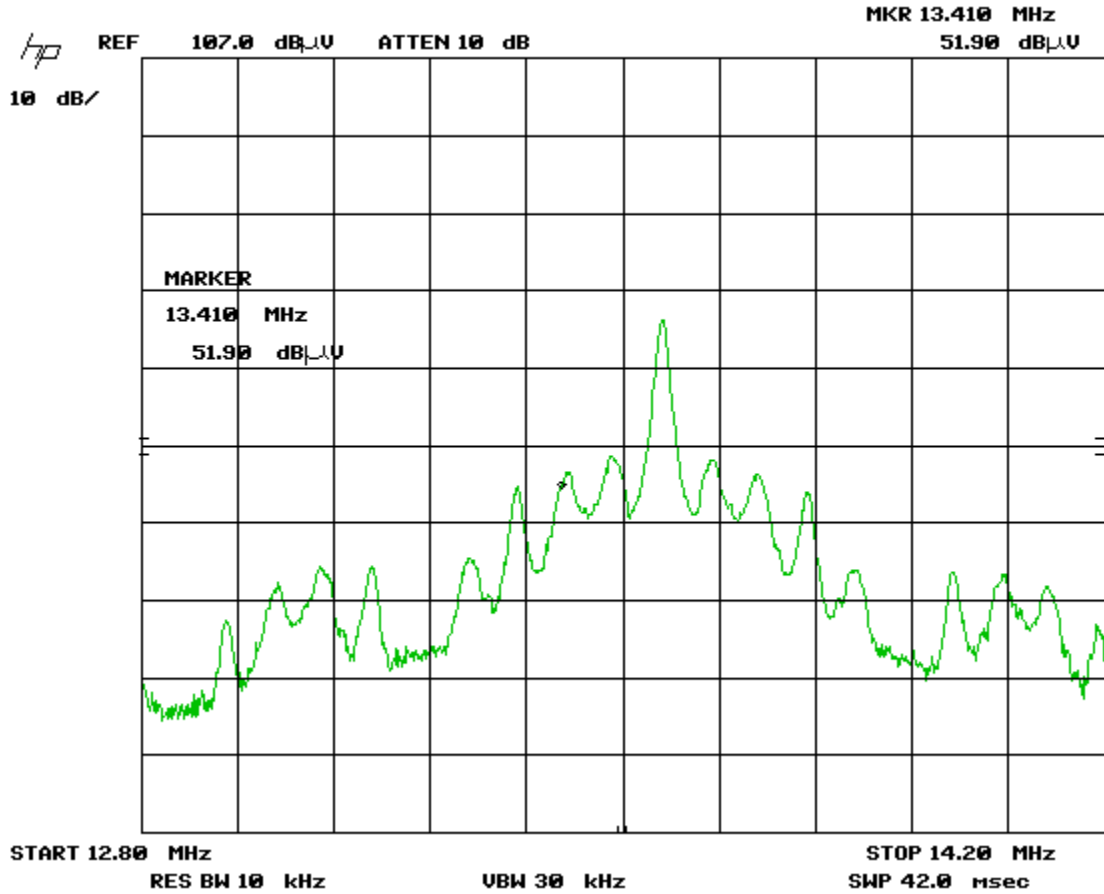

Client	Square Inc.	
Product	S6 Mobile Credit Card Reader (RFID)	
Standard(s)	FCC Part 15 Subpart C 15:2015 / RSS 210 Issue 8:2010	

Peak Emission – Band Edges
13.110-13.410 MHz (Maximum in range)
3m test distance
(Factors not incorporated. See *Final Measurements*.)

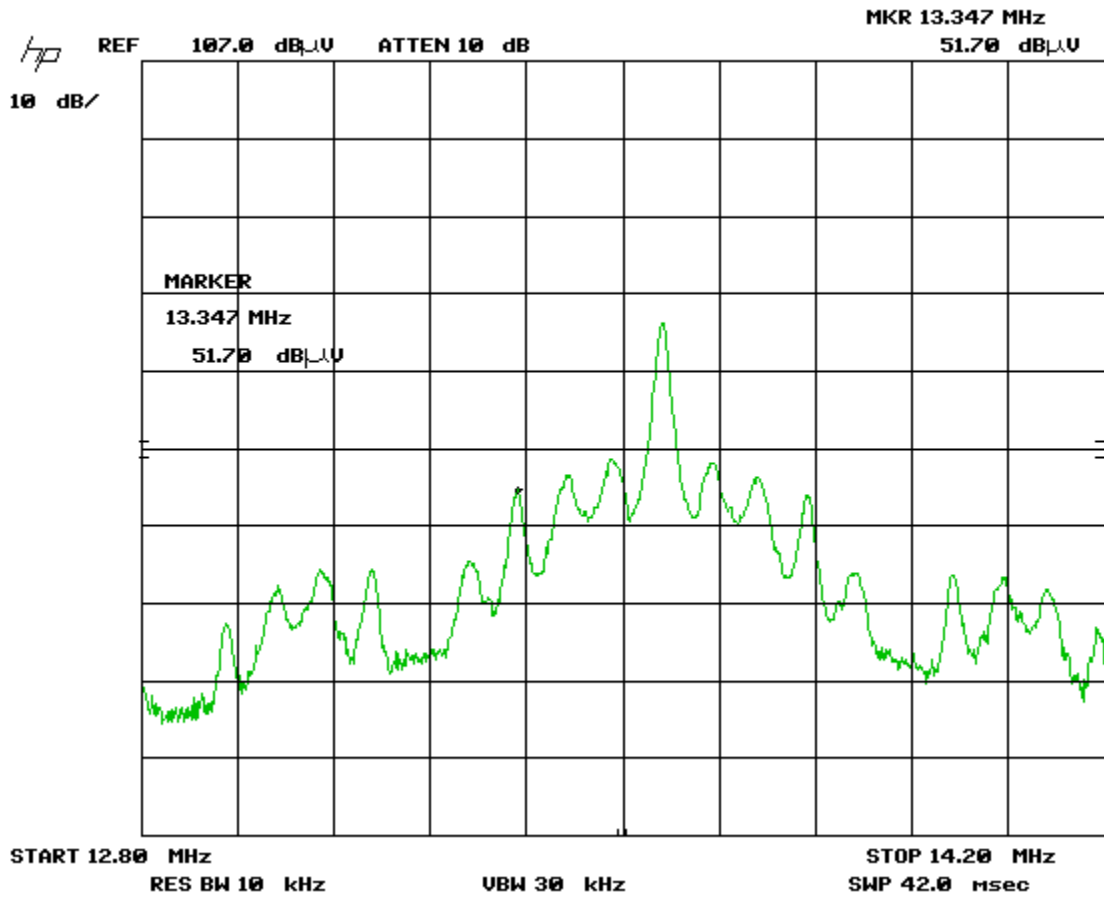

Client	Square Inc.	
Product	S6 Mobile Credit Card Reader (RFID)	
Standard(s)	FCC Part 15 Subpart C 15:2015 / RSS 210 Issue 8:2010	

Peak Emission – Band Edges
13.110 MHz
3m test distance
(Factors not incorporated. See *Final Measurements*.)

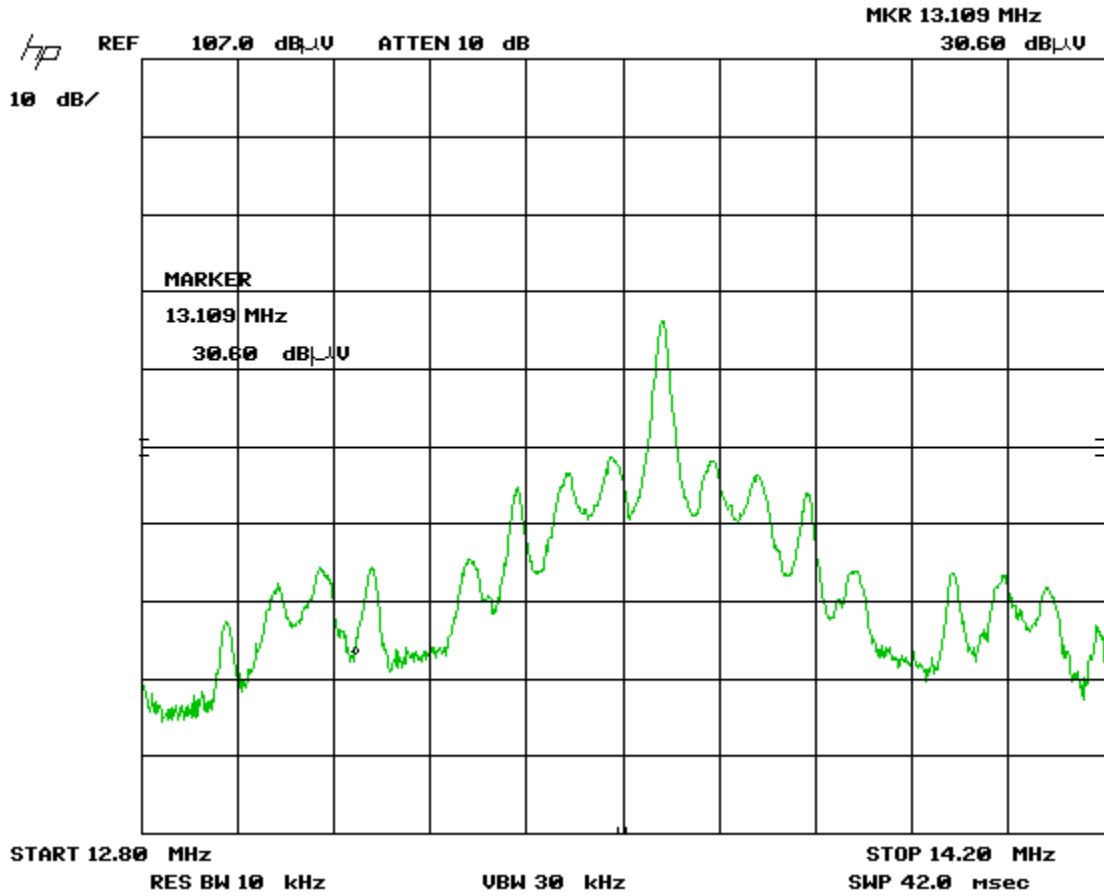

Client	Square Inc.	
Product	S6 Mobile Credit Card Reader (RFID)	
Standard(s)	FCC Part 15 Subpart C 15:2015 / RSS 210 Issue 8:2010	

Peak Emission – Band Edges
13.056 MHz
3m test distance
(Factors not incorporated. See *Final Measurements.*)

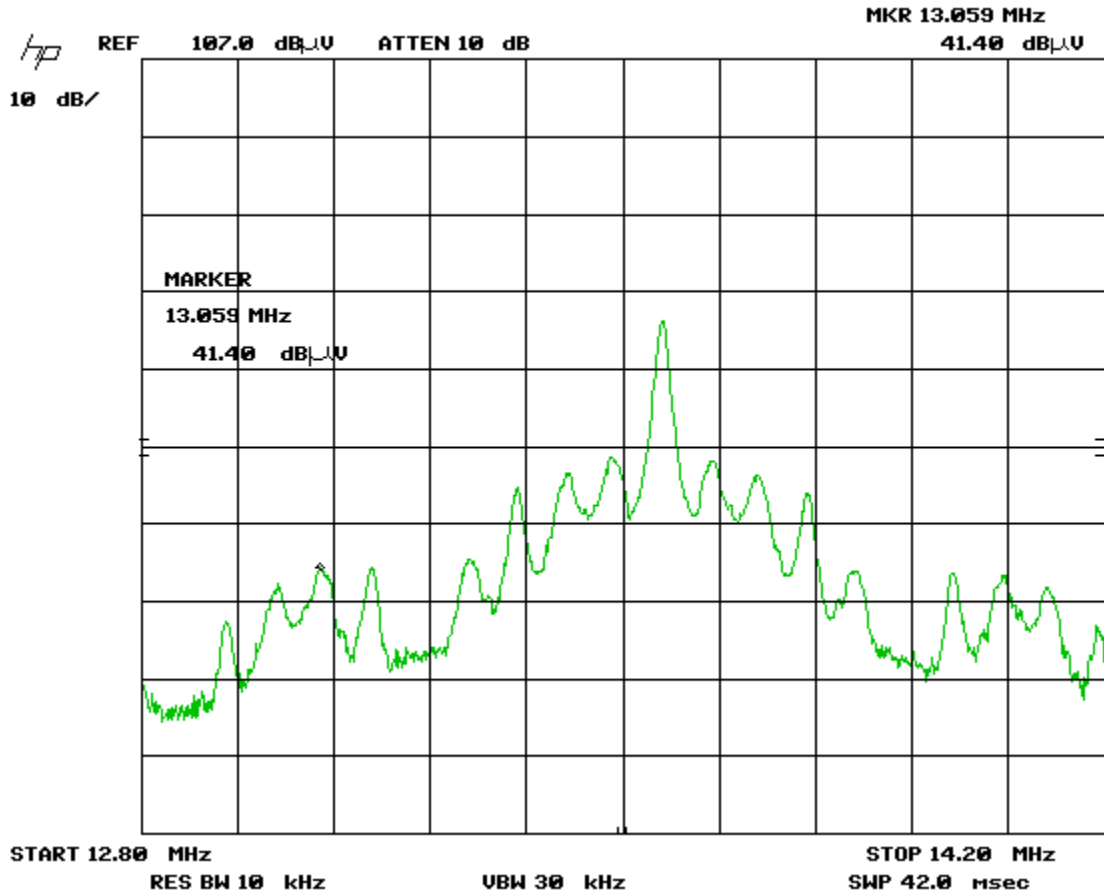

Client	Square Inc.	
Product	S6 Mobile Credit Card Reader (RFID)	
Standard(s)	FCC Part 15 Subpart C 15:2015 / RSS 210 Issue 8:2010	

Peak Emission – Band Edges
13.567-13.710
3m test distance
(Factors not incorporated. See *Final Measurements.*)

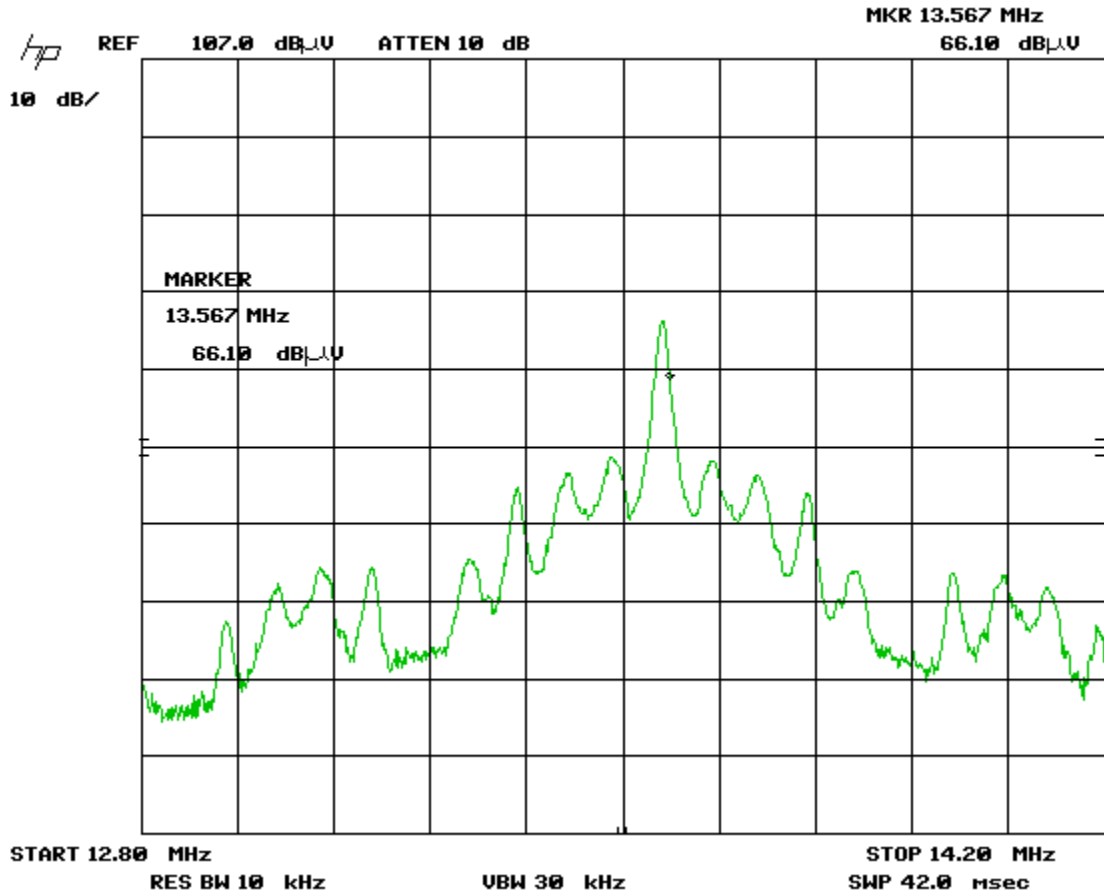

Client	Square Inc.	
Product	S6 Mobile Credit Card Reader (RFID)	
Standard(s)	FCC Part 15 Subpart C 15:2015 / RSS 210 Issue 8:2010	

Peak Emission – Band Edges
13.710-14.010
3m test distance
(Factors not incorporated. See *Final Measurements.*)

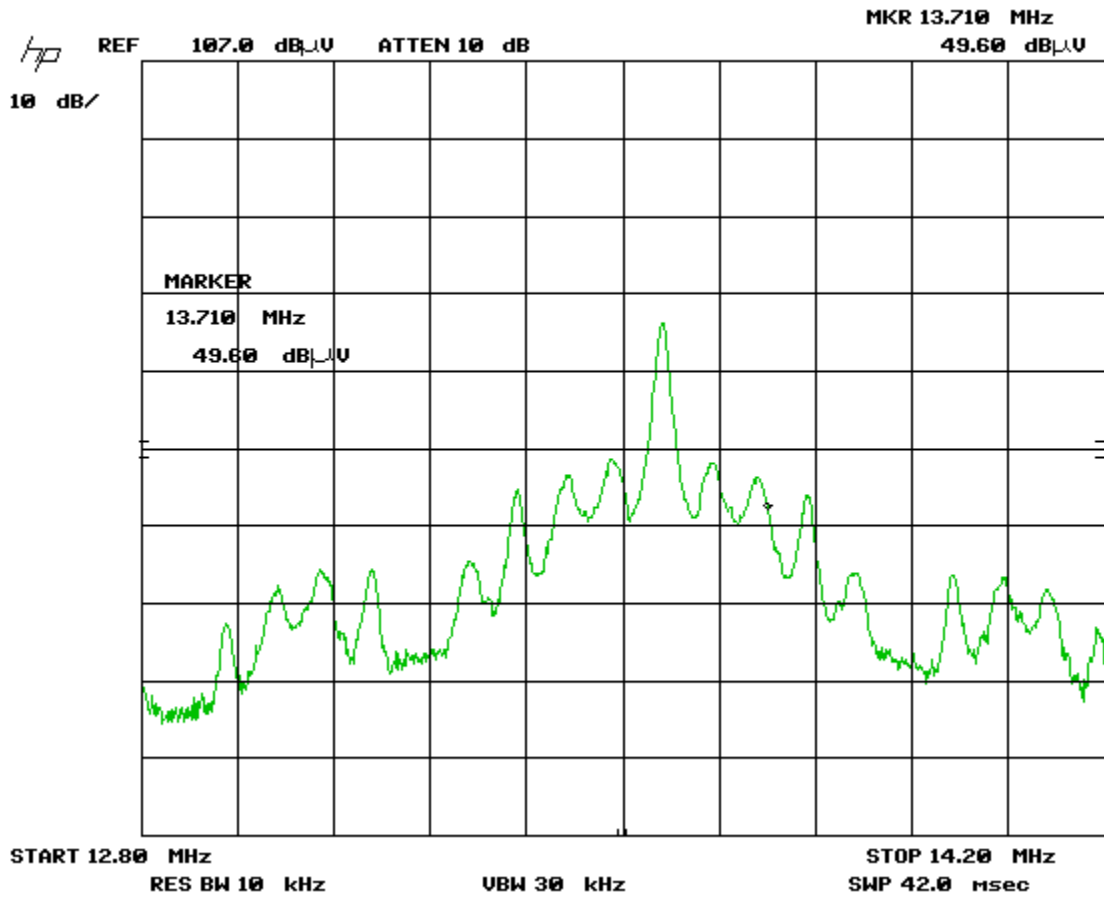

Client	Square Inc.	
Product	S6 Mobile Credit Card Reader (RFID)	
Standard(s)	FCC Part 15 Subpart C 15:2015 / RSS 210 Issue 8:2010	

Peak Emission – Band Edges
13.710-14.010 MHz (Maximum in range)
3m test distance
(Factors not incorporated. See *Final Measurements.*)

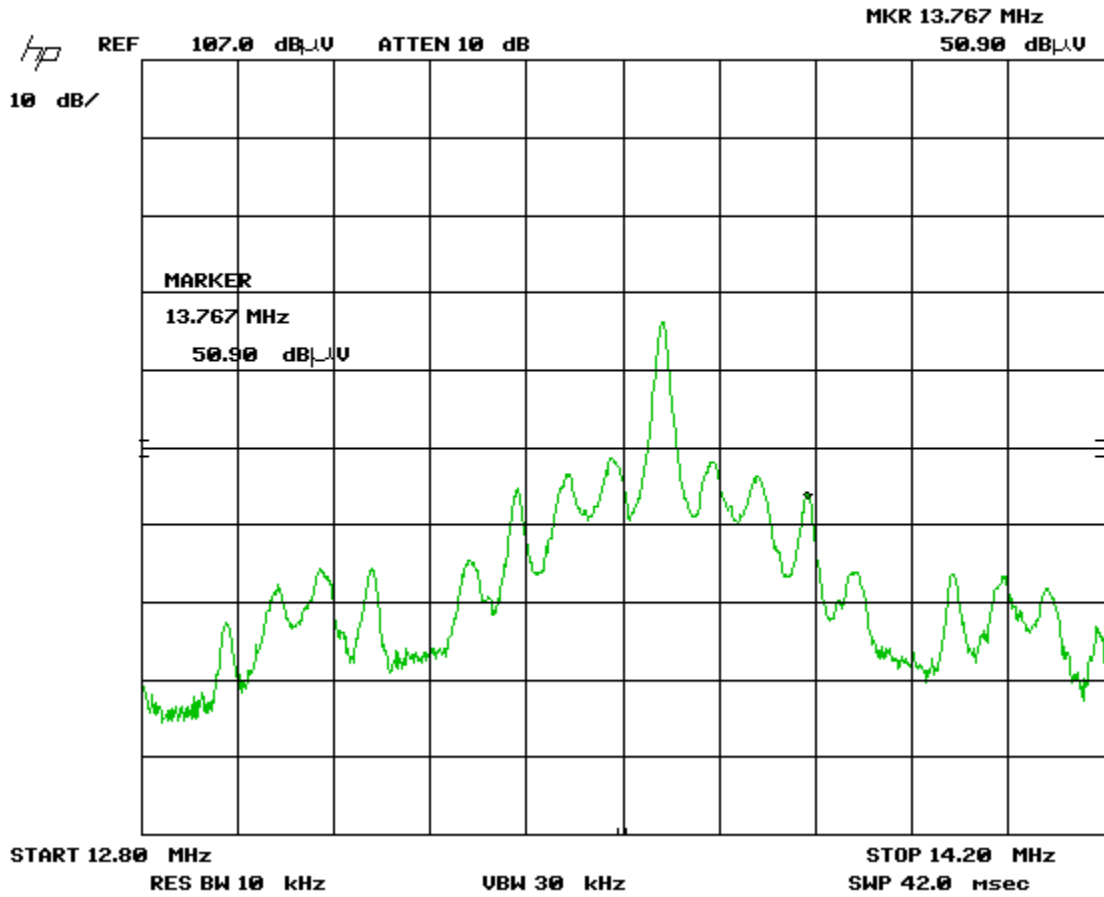

Client	Square Inc.	
Product	S6 Mobile Credit Card Reader (RFID)	
Standard(s)	FCC Part 15 Subpart C 15:2015 / RSS 210 Issue 8:2010	

Peak Emission – Band Edges
14.010 MHz
3m test distance
(Factors not incorporated. See *Final Measurements*.)

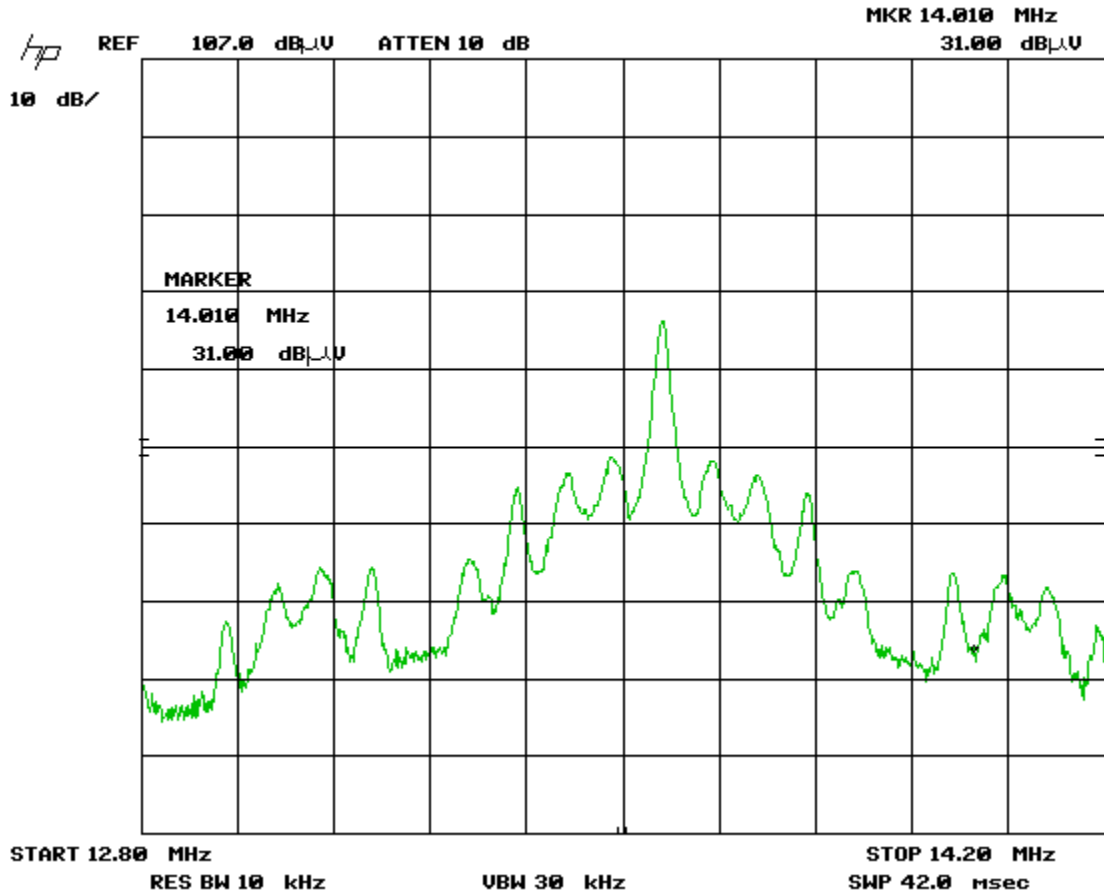

Client	Square Inc.	
Product	S6 Mobile Credit Card Reader (RFID)	
Standard(s)	FCC Part 15 Subpart C 15:2015 / RSS 210 Issue 8:2010	

Peak Emission – Band Edges
14.056 MHz
3m test distance
(Factors not incorporated. See *Final Measurements.*)

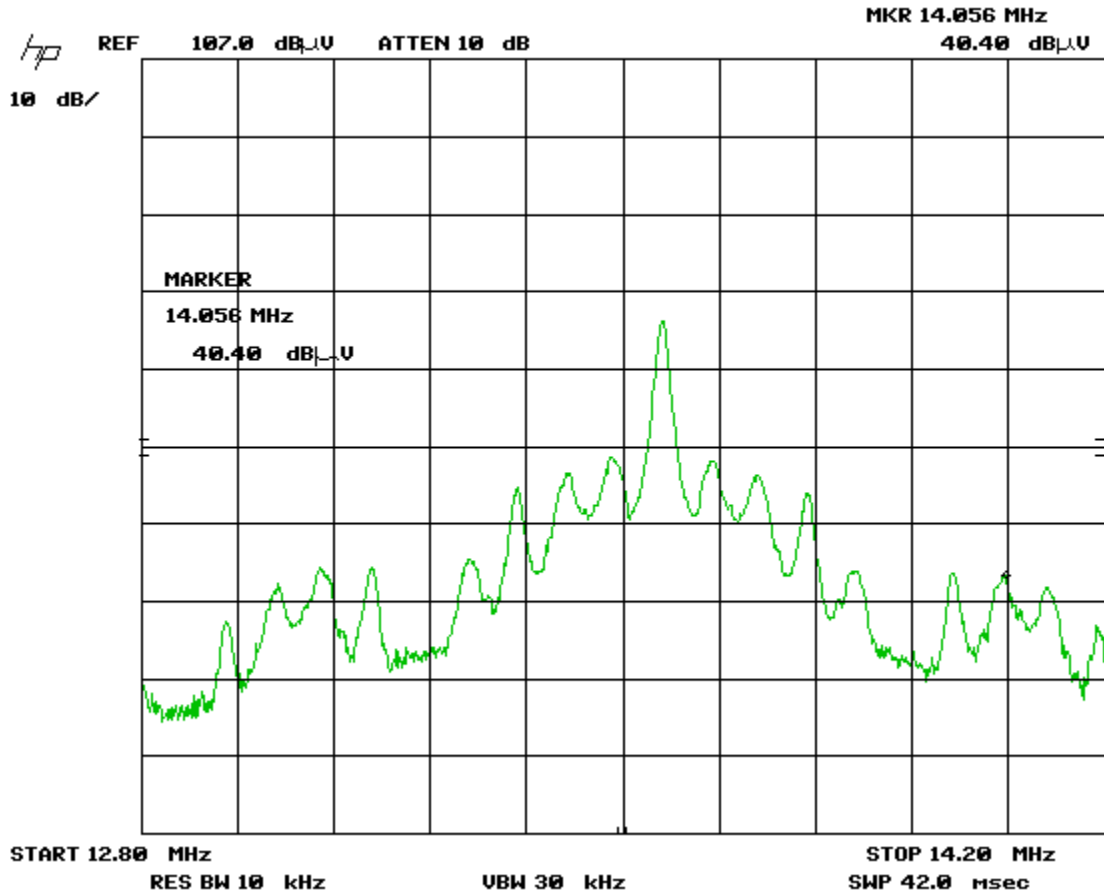

Client	Square Inc.	
Product	S6 Mobile Credit Card Reader (RFID)	
Standard(s)	FCC Part 15 Subpart C 15:2015 / RSS 210 Issue 8:2010	

C2PC
 Peak Emission – Band Edges
 13.410-13.553 MHz
 3m test distance
 (Factors not incorporated. See *Final Measurements.*)

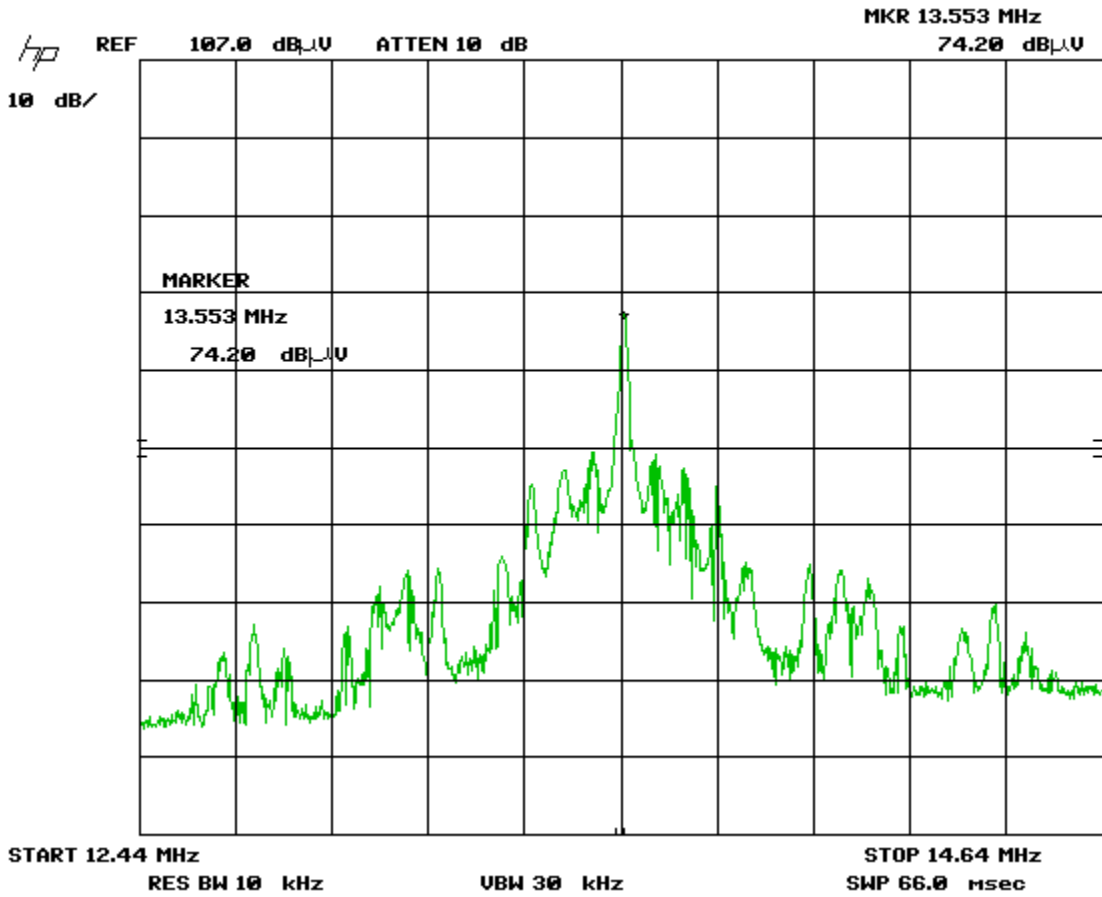

Client	Square Inc.	
Product	S6 Mobile Credit Card Reader (RFID)	
Standard(s)	FCC Part 15 Subpart C 15:2015 / RSS 210 Issue 8:2010	

C2PC
 Peak Emission – Band Edges
 13.110-13.410 MHz
 3m test distance
 (Factors not incorporated. See *Final Measurements.*)

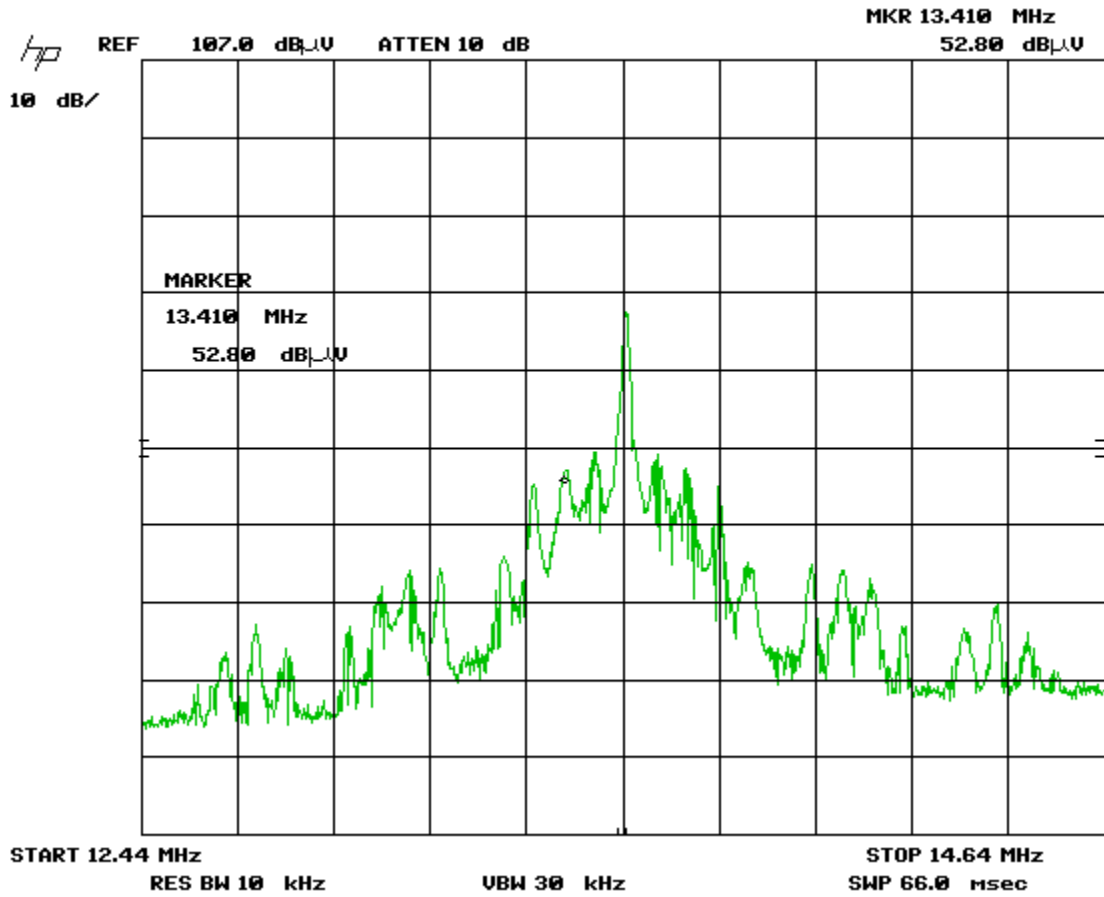

Client	Square Inc.	
Product	S6 Mobile Credit Card Reader (RFID)	
Standard(s)	FCC Part 15 Subpart C 15:2015 / RSS 210 Issue 8:2010	

C2PC
 Peak Emission – Band Edges
 13.110-13.410 MHz (Maximum in range)
 3m test distance
 (Factors not incorporated. See *Final Measurements.*)

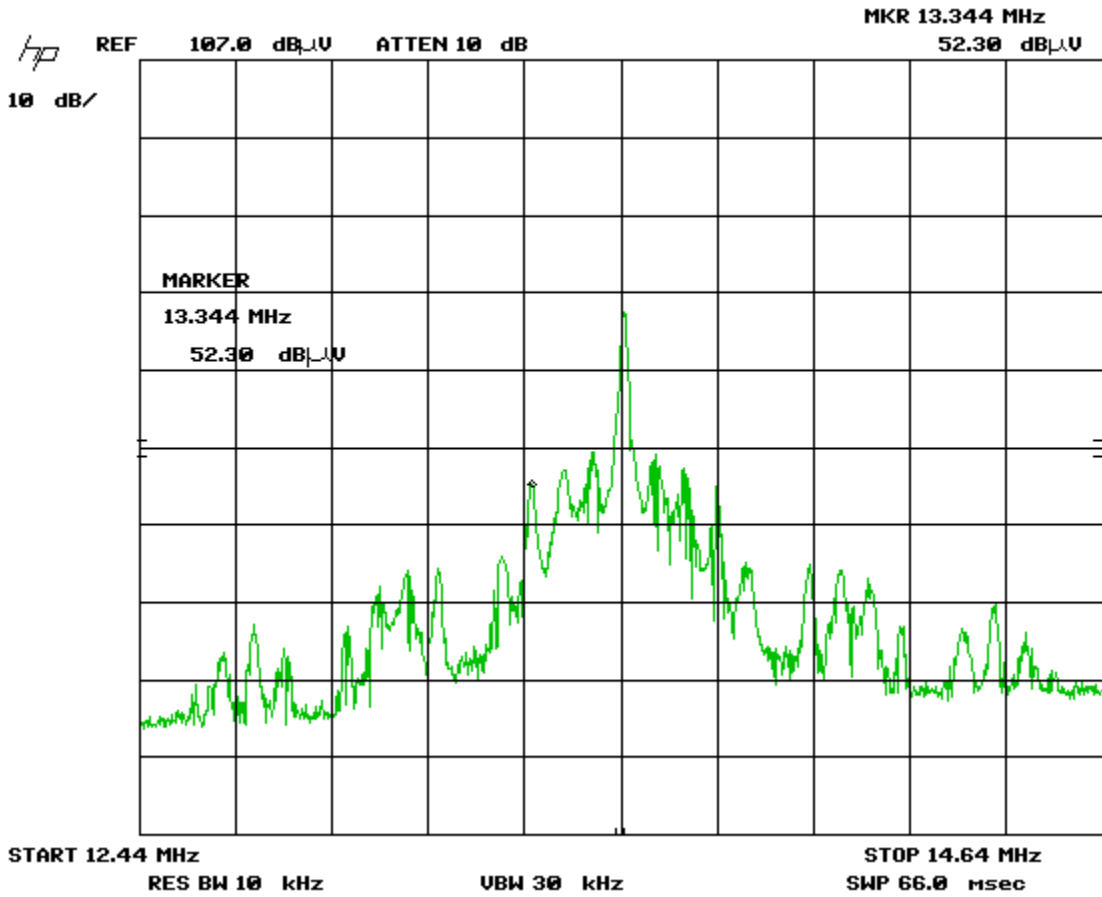

Client	Square Inc.	
Product	S6 Mobile Credit Card Reader (RFID)	
Standard(s)	FCC Part 15 Subpart C 15:2015 / RSS 210 Issue 8:2010	

C2PC
 Peak Emission – Band Edges
 13.110 MHz
 3m test distance
 (Factors not incorporated. See *Final Measurements.*)

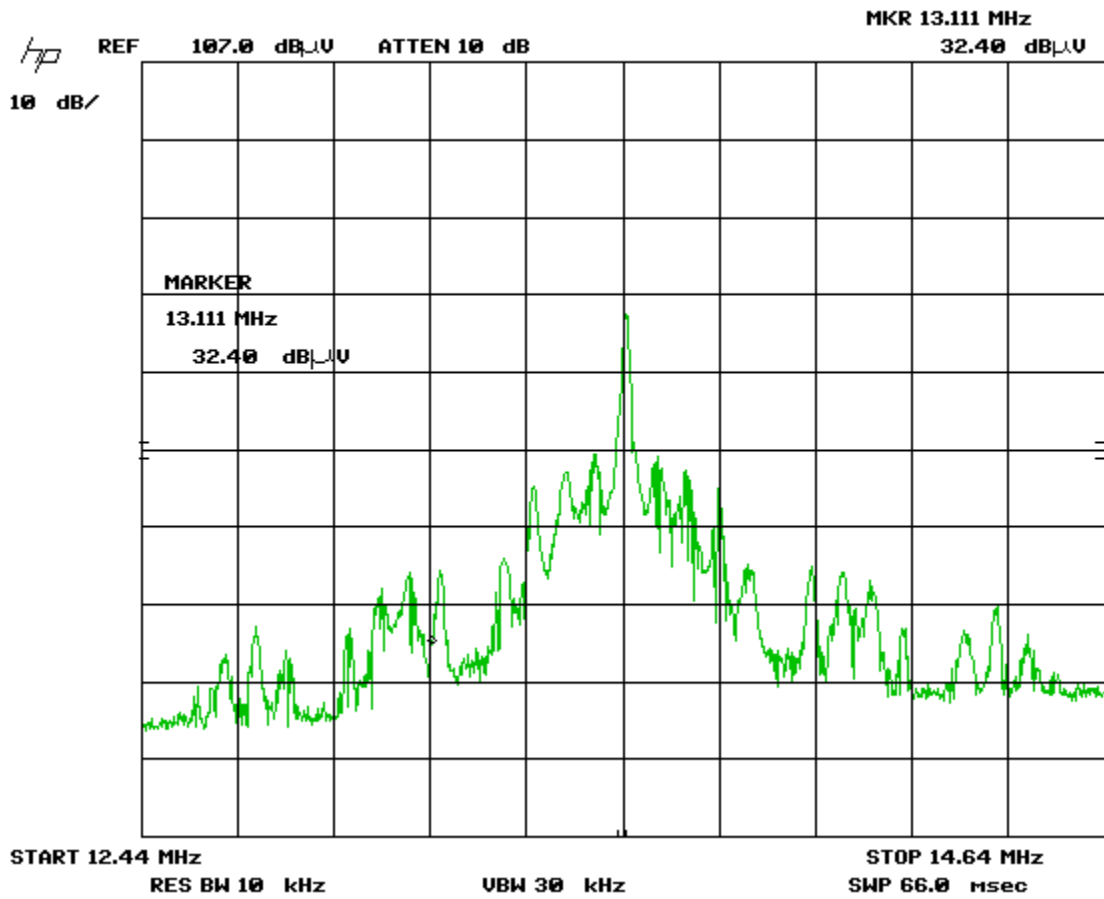

Client	Square Inc.	
Product	S6 Mobile Credit Card Reader (RFID)	
Standard(s)	FCC Part 15 Subpart C 15:2015 / RSS 210 Issue 8:2010	

C2PC
 Peak Emission – Band Edges
 13.056 MHz
 3m test distance
 (Factors not incorporated. See *Final Measurements.*)

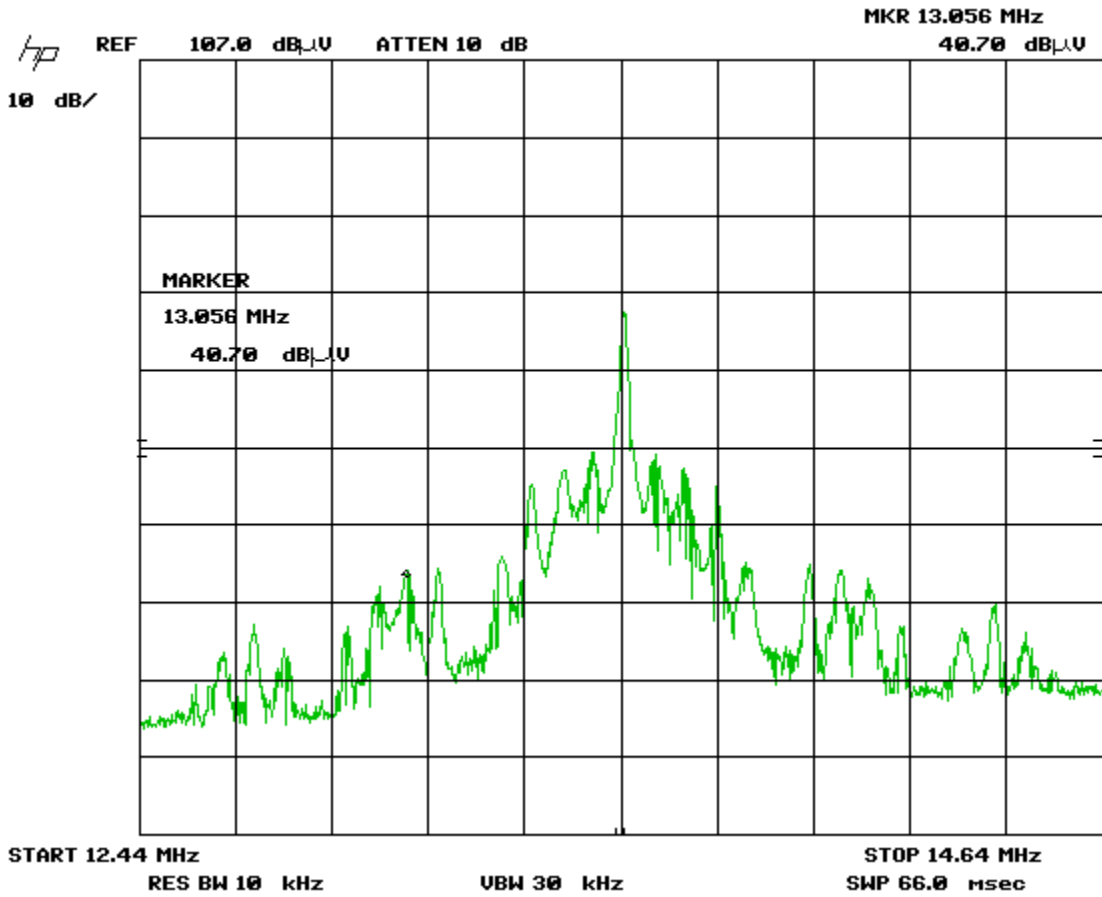

Client	Square Inc.	
Product	S6 Mobile Credit Card Reader (RFID)	
Standard(s)	FCC Part 15 Subpart C 15:2015 / RSS 210 Issue 8:2010	

C2PC
 Peak Emission – Band Edges
 13.567-13.710
 3m test distance
 (Factors not incorporated. See *Final Measurements.*)

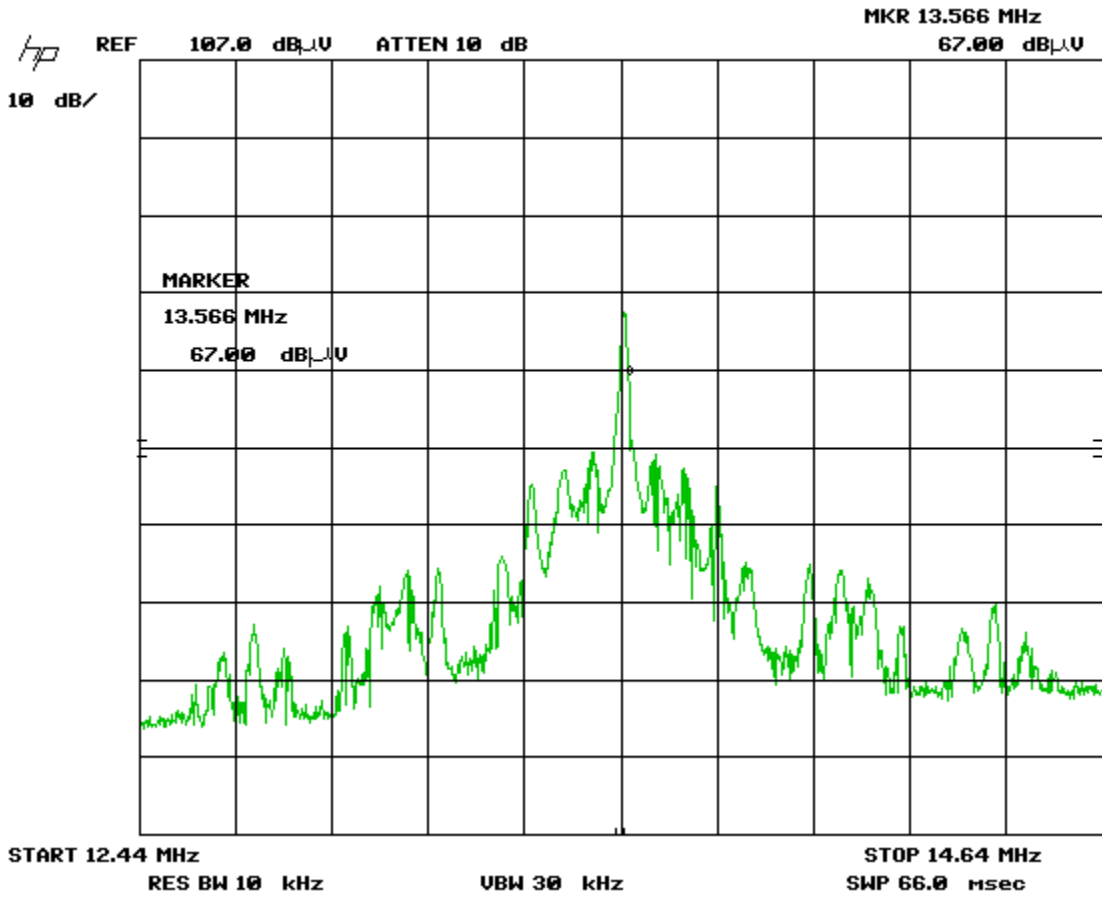

Client	Square Inc.	
Product	S6 Mobile Credit Card Reader (RFID)	
Standard(s)	FCC Part 15 Subpart C 15:2015 / RSS 210 Issue 8:2010	

C2PC
 Peak Emission – Band Edges
 13.710-14.010
 3m test distance
 (Factors not incorporated. See *Final Measurements.*)

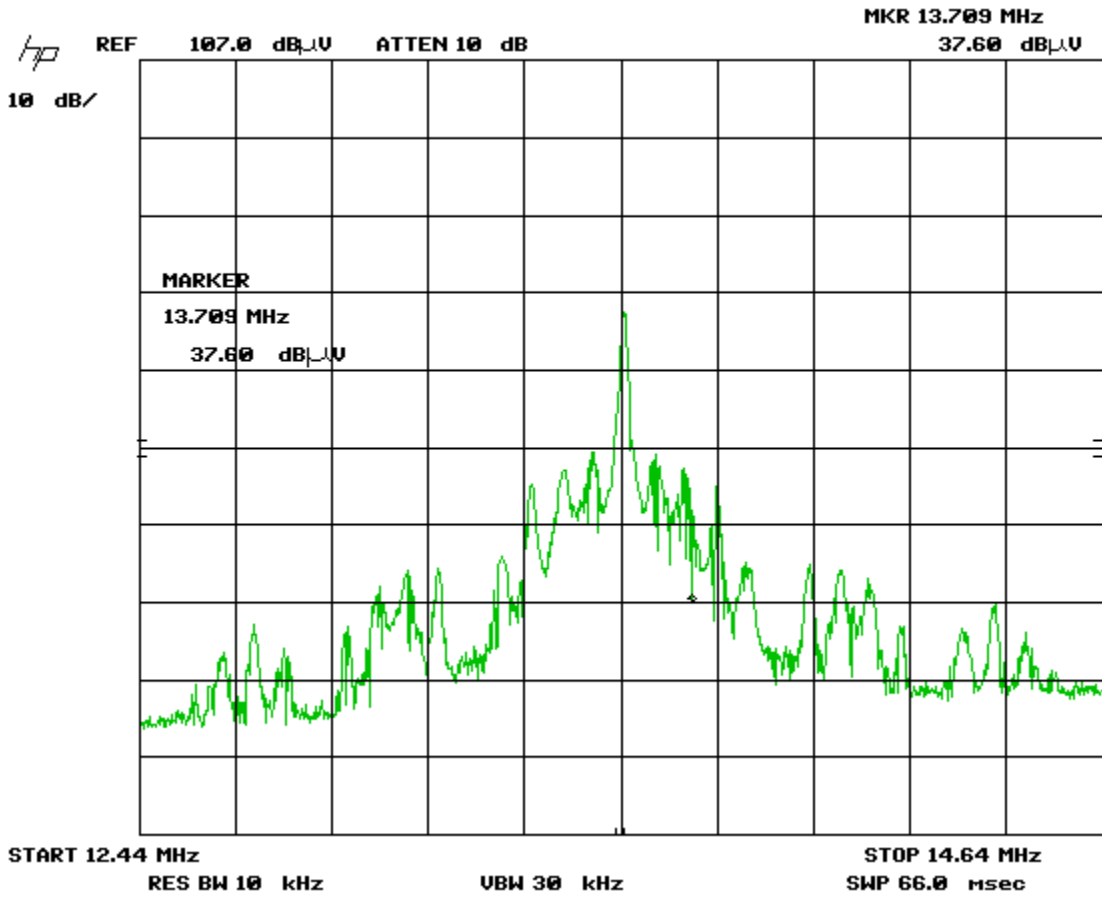

Client	Square Inc.	
Product	S6 Mobile Credit Card Reader (RFID)	
Standard(s)	FCC Part 15 Subpart C 15:2015 / RSS 210 Issue 8:2010	

C2PC
 Peak Emission – Band Edges
 13.710-14.010 MHz (Maximum in range)
 3m test distance
 (Factors not incorporated. See *Final Measurements.*)

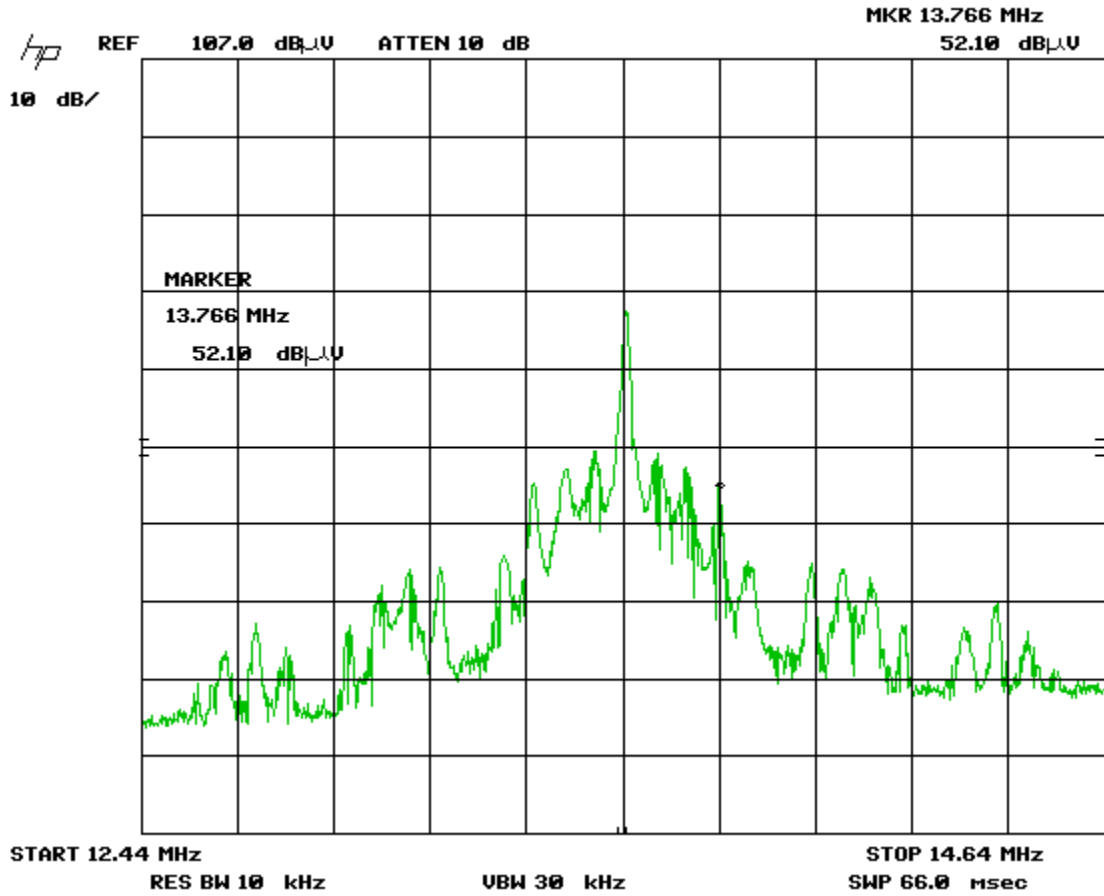

Client	Square Inc.	
Product	S6 Mobile Credit Card Reader (RFID)	
Standard(s)	FCC Part 15 Subpart C 15:2015 / RSS 210 Issue 8:2010	

C2PC
 Peak Emission – Band Edges
 14.010 MHz
 3m test distance
 (Factors not incorporated. See *Final Measurements.*)

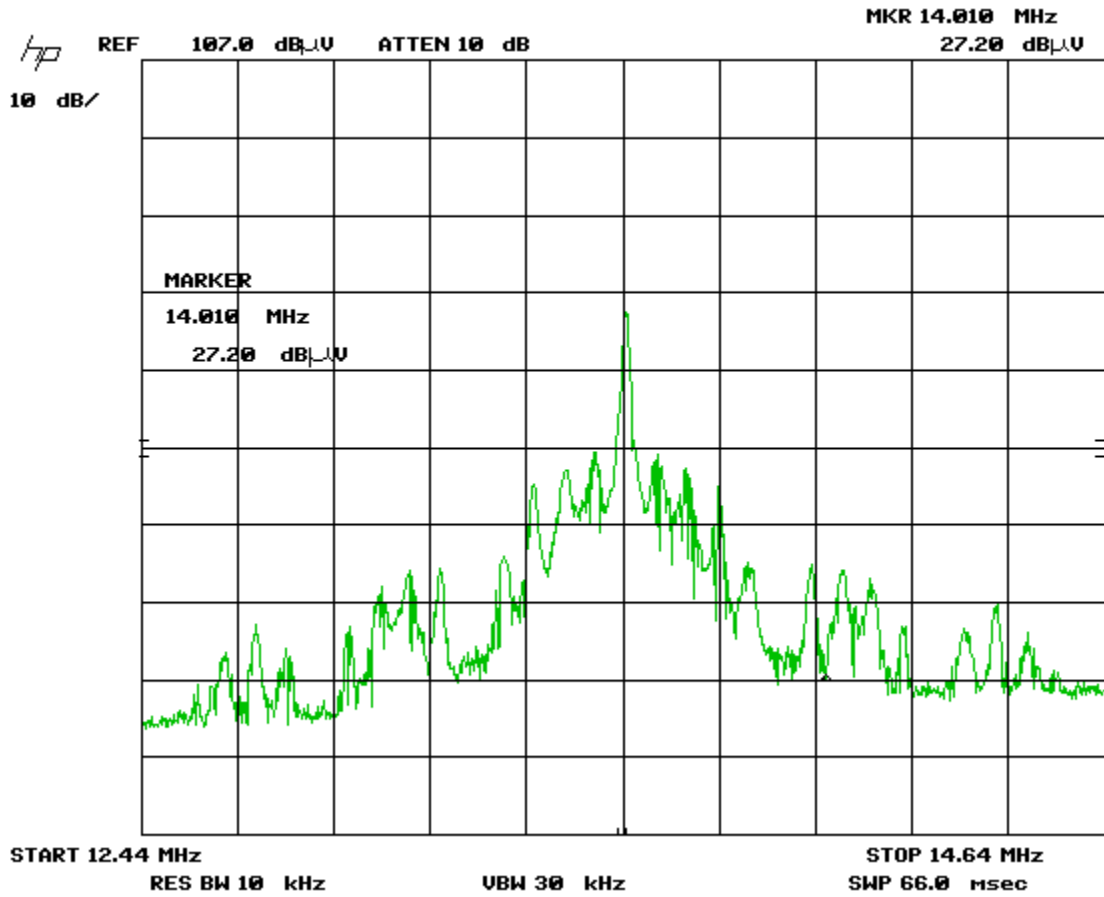

Client	Square Inc.	
Product	S6 Mobile Credit Card Reader (RFID)	
Standard(s)	FCC Part 15 Subpart C 15:2015 / RSS 210 Issue 8:2010	

C2PC
 Peak Emission – Band Edges
 14.050 MHz
 3m test distance
 (Factors not incorporated. See *Final Measurements.*)

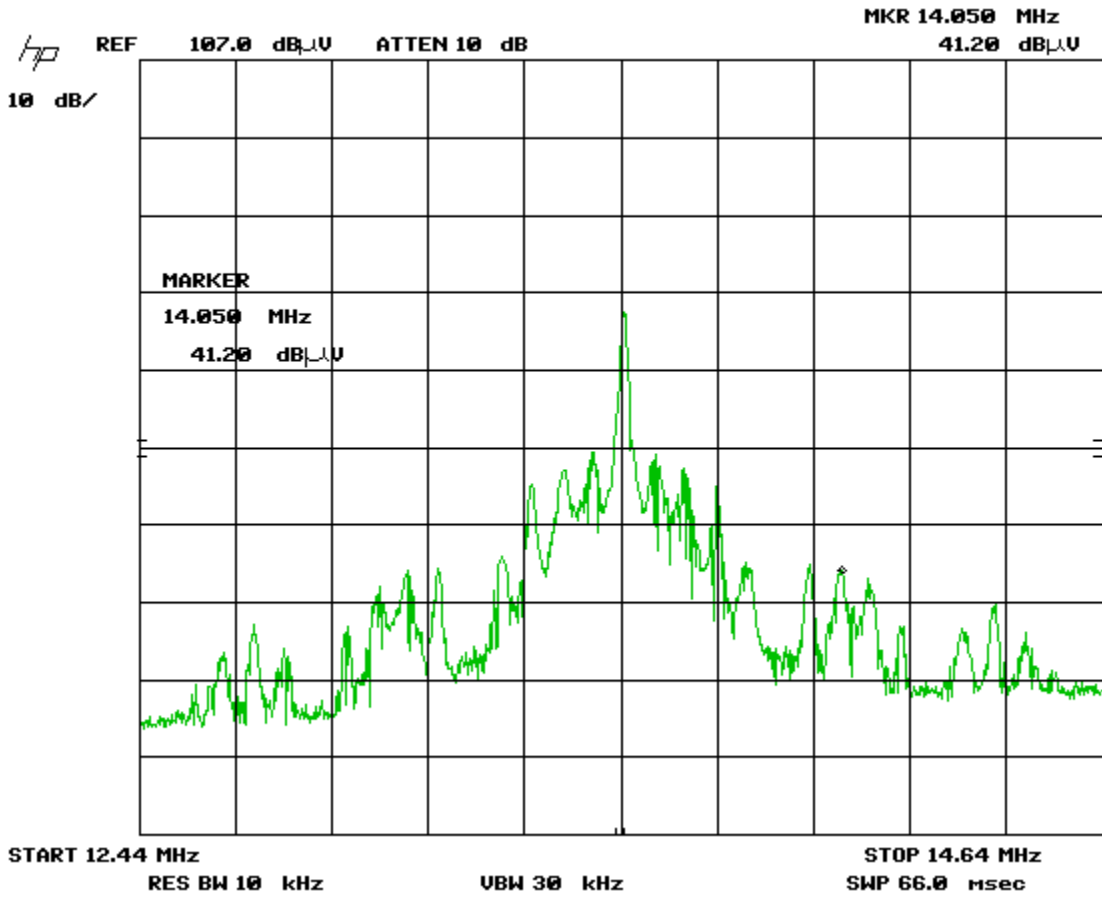

Client	Square Inc.	
Product	S6 Mobile Credit Card Reader (RFID)	
Standard(s)	FCC Part 15 Subpart C 15:2015 / RSS 210 Issue 8:2010	

Final Measurements

Radiated Emissions - 15.225 Fundamental

Test Frequency (MHz)	Detection mode	Raw signal dB(μA)	dBμA to dBμV conversion factor	Antenna factor dB	Cable loss + Pre-selector dB	Pre-Amp Gain dB	Received signal dB(μV/m)	Emission limit dB(μV/m)	Margin dB(μV)	Result
13.56	Peak	73.3	51.5	-16.2	0.3	33.0	75.9	124.0	48.1	Pass

Radiated Emissions - 15.225 Band Edges

Test Frequency (MHz)	Detection mode	Raw signal dB(μA)	dBμA to dBμV conversion factor	Antenna factor dB	Cable loss + Pre-selector dB	Pre-Amp Gain dB	Received signal dB(μV/m)	Emission limit dB(μV/m)	Margin dB(μV)	Result
13.553	Peak	71.6	51.5	-16.2	0.3	33.0	74.2	90.4	16.2	Pass
13.410	Peak	51.9	51.5	-16.2	0.3	33.0	54.5	80.5	26.0	Pass
13.347	Peak	51.7	51.5	-16.2	0.3	33.0	54.3	80.5	26.2	Pass
13.11	Peak	30.6	51.5	-16.2	0.3	33.0	33.2	69.5	36.3	Pass
13.059	Peak	41.4	51.5	-16.2	0.3	33.0	44.0	69.5	25.5	Pass
13.567	Peak	66.1	51.5	-16.2	0.3	33.0	68.7	90.4	21.7	Pass
13.71	Peak	49.6	51.5	-16.2	0.3	33.0	52.2	80.5	28.3	Pass
13.767	Peak	50.9	51.5	-16.2	0.3	33.0	53.5	80.5	27.0	Pass
14.010	Peak	31.0	51.5	-16.2	0.3	33.0	33.6	69.5	35.9	Pass
14.056	Peak	40.4	51.5	-16.2	0.3	33.0	43.0	69.5	26.5	Pass

Client	Square Inc.	
Product	S6 Mobile Credit Card Reader (RFID)	
Standard(s)	FCC Part 15 Subpart C 15:2015 / RSS 210 Issue 8:2010	

C2PC
Radiated Emissions - 15.225
Fundamental

Test Frequency (MHz)	Detection mode	Raw signal dB(μA)	dBμA to dBμV conversion factor	Antenna factor dB	Cable loss + Pre-selector dB	Pre-Amp Gain dB	Received signal dB(μV/m)	Emission limit dB(μV/m)	Margin dB(μV)	Result
13.56	Peak	74.4	51.5	-16.2	0.3	33.0	77.0	124.0	47.0	Pass

C2PC
Radiated Emissions - 15.225
Band Edges

Test Frequency (MHz)	Detection mode	Raw signal dB(μA)	dBμA to dBμV conversion factor	Antenna factor dB	Cable loss + Pre-selector dB	Pre-Amp Gain dB	Received signal dB(μV/m)	Emission limit dB(μV/m)	Margin dB(μV)	Result
13.553	Peak	74.2	51.5	-16.2	0.3	33.0	76.8	90.4	13.6	Pass
13.410	Peak	52.8	51.5	-16.2	0.3	33.0	55.4	80.5	25.1	Pass
13.344	Peak	52.3	51.5	-16.2	0.3	33.0	54.9	80.5	25.6	Pass
13.110	Peak	32.4	51.5	-16.2	0.3	33.0	35.0	69.5	34.5	Pass
13.056	Peak	40.7	51.5	-16.2	0.3	33.0	43.3	69.5	26.2	Pass
13.567	Peak	67.0	51.5	-16.2	0.3	33.0	69.6	90.4	20.8	Pass
13.710	Peak	37.6	51.5	-16.2	0.3	33.0	40.2	80.5	40.3	Pass
13.766	Peak	52.1	51.5	-16.2	0.3	33.0	54.7	80.5	25.8	Pass
14.010	Peak	27.2	51.5	-16.2	0.3	33.0	29.8	69.5	39.7	Pass
14.050	Peak	41.2	51.5	-16.2	0.3	33.0	43.8	69.5	25.7	Pass

See *Radiated Emissions – Spurious* section in this report for spurious emissions test results outside of the FCC 15.225 bands.

Client	Square Inc.	
Product	S6 Mobile Credit Card Reader (RFID)	
Standard(s)	FCC Part 15 Subpart C 15:2015 / RSS 210 Issue 8:2010	

Test Equipment List

Equipment	Model No.	Manufacturer	Last calibration date	Next calibration due date	Asset #
Spectrum Analyzer	8566B	HP	May 21, 2014	May 21, 2016	GEMC 193
Loop Antenna 100kHz – 30MHz	EM 6872	Electro-Metrics	Feb. 3, 2015	Feb. 3, 2017	GEMC 71
Preamp	CPA9231A	Chase	Sept. 9, 2014	Sept. 9, 2016	GEMC 6403
RF Cable 7m	LMR-400-7M- 50OHM-MN- MN	LexTec	NCR	NCR	GEMC 28
RF Cable 1m	LMR-400-1M- 50OHM-MN- MN	LexTec	NCR	NCR	GEMC 29

Client	Square Inc.	
Product	S6 Mobile Credit Card Reader (RFID)	
Standard(s)	FCC Part 15 Subpart C 15:2015 / RSS 210 Issue 8:2010	

20 dB Bandwidth

Purpose

The purpose of this test is to find the 20 dB bandwidth of the emission. This is the bandwidth which is attenuated 20 dB from the peak of the intentional transmission.

Limit(s) and Method

The method is as defined in ANSI C63.10.

There are no applicable limits for this test. Its results are for informational purposes only.

Client	Square Inc.	
Product	S6 Mobile Credit Card Reader (RFID)	
Standard(s)	FCC Part 15 Subpart C 15:2015 / RSS 210 Issue 8:2010	

Preliminary Graphs

20 dB Bandwidth for 13.56 MHz Transmission

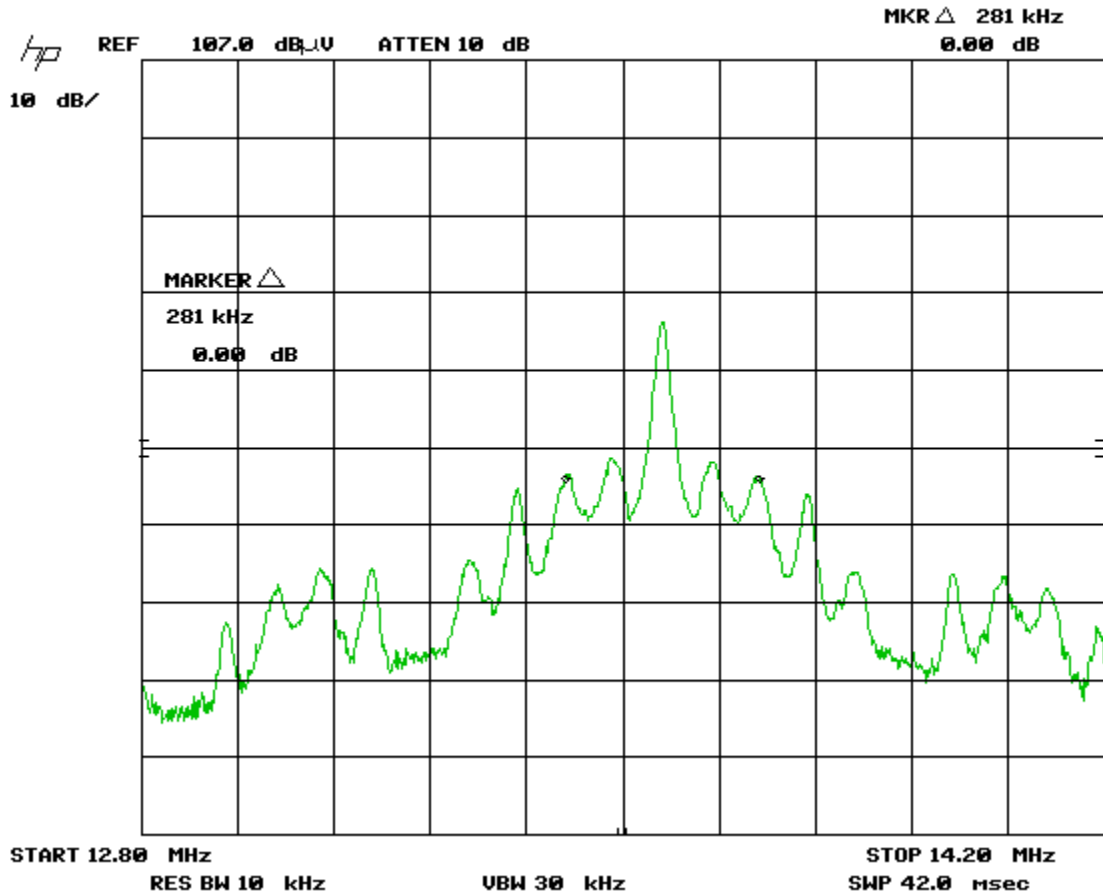

Results

The 20 dB bandwidth for the 13.56 MHz transmission is 281 kHz.

Client	Square Inc.	
Product	S6 Mobile Credit Card Reader (RFID)	
Standard(s)	FCC Part 15 Subpart C 15:2015 / RSS 210 Issue 8:2010	

Test Equipment List

Equipment	Model No.	Manufacturer	Last calibration date	Next calibration due date	Asset #
Spectrum Analyzer	8566B	HP	May 21, 2014	May 21, 2016	GEMC 193
Loop Antenna 100kHz – 30MHz	EM 6872	Electro-Metrics	Feb. 3, 2015	Feb. 3, 2017	GEMC 71
Preamp	CPA9231A	Chase	Sept. 9, 2014	Sept. 9, 2016	GEMC 6403
RF Cable 7m	LMR-400-7M- 50OHM-MN- MN	LexTec	NCR	NCR	GEMC 28
RF Cable 1m	LMR-400-1M- 50OHM-MN- MN	LexTec	NCR	NCR	GEMC 29

Client	Square Inc.	
Product	S6 Mobile Credit Card Reader (RFID)	
Standard(s)	FCC Part 15 Subpart C 15:2015 / RSS 210 Issue 8:2010	

Power Line Conducted Emissions

Purpose

The purpose of this test is to ensure that the RF energy unintentionally emitted from the EUT's power line does not exceed the limits listed below as defined in the applicable test standard, as measured from a LISN. This helps protect lower frequency radio services such as AM radio, shortwave radio, amateur radio operators, maritime radio, CB radio, and so on, from unwanted interference.

Limits & Method

The limits and method are as defined in 47 CFR FCC Part 15 Section 15.207, and RSS-Gen 8.8, Table 3.

<u>Average Limits</u>		<u>QuasiPeak Limits</u>	
150 kHz – 500 kHz	56 to 46 dBuV	150 kHz – 500 kHz	66 to 56 dBuV
500 kHz – 5 MHz	46 dBuV	500 kHz – 5 MHz	56 dBuV
5 MHz – 30 MHz	50 dBuV	500 kHz – 30 MHz	60 dBuV

The limit decreases linearly with the logarithm of the frequency in the range 0.15 MHz to 0.50 MHz.

Note: If the Peak or Quasi Peak detector measurements do not exceed the Average limits, then the EUT is deemed to have passed the requirements.

Both limits are applicable, and each is specified as being measured with a 9 kHz measurement bandwidth.

Client	Square Inc.	
Product	S6 Mobile Credit Card Reader (RFID)	
Standard(s)	FCC Part 15 Subpart C 15:2015 / RSS 210 Issue 8:2010	

Typical Setup Diagram

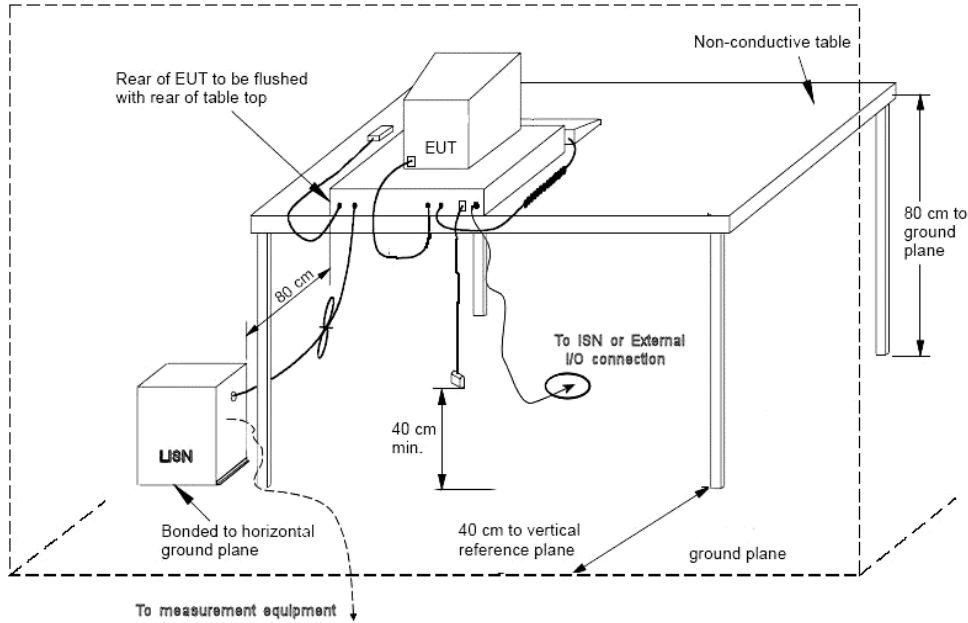

Measurement Uncertainty

The expanded measurement uncertainty is calculated in accordance with CISPR 16-4-2 and is +/-3.6 dB with a 'k=2' coverage factor and a 95% confidence level.

Preliminary Graphs

Note the graphs shown below are for graphical illustration only. For final measurements with the appropriate detector where applicable, please refer to the table. The graphs shown below are peak measurement graphs, measured with a resolution bandwidth greater than or equal to the final required detector. These graphs are performed as a worst case measurement to enable the detection of frequencies of concern and for considerable time savings. Power line conducted emissions is performed with the BLE and NFC transmitters transmitting with constant modulated data at maximum output power.

Client	Square Inc.	
Product	S6 Mobile Credit Card Reader (RFID)	
Standard(s)	FCC Part 15 Subpart C 15:2015 / RSS 210 Issue 8:2010	

Peak Emissions Graph - Line 1, Phase
120V, 60Hz

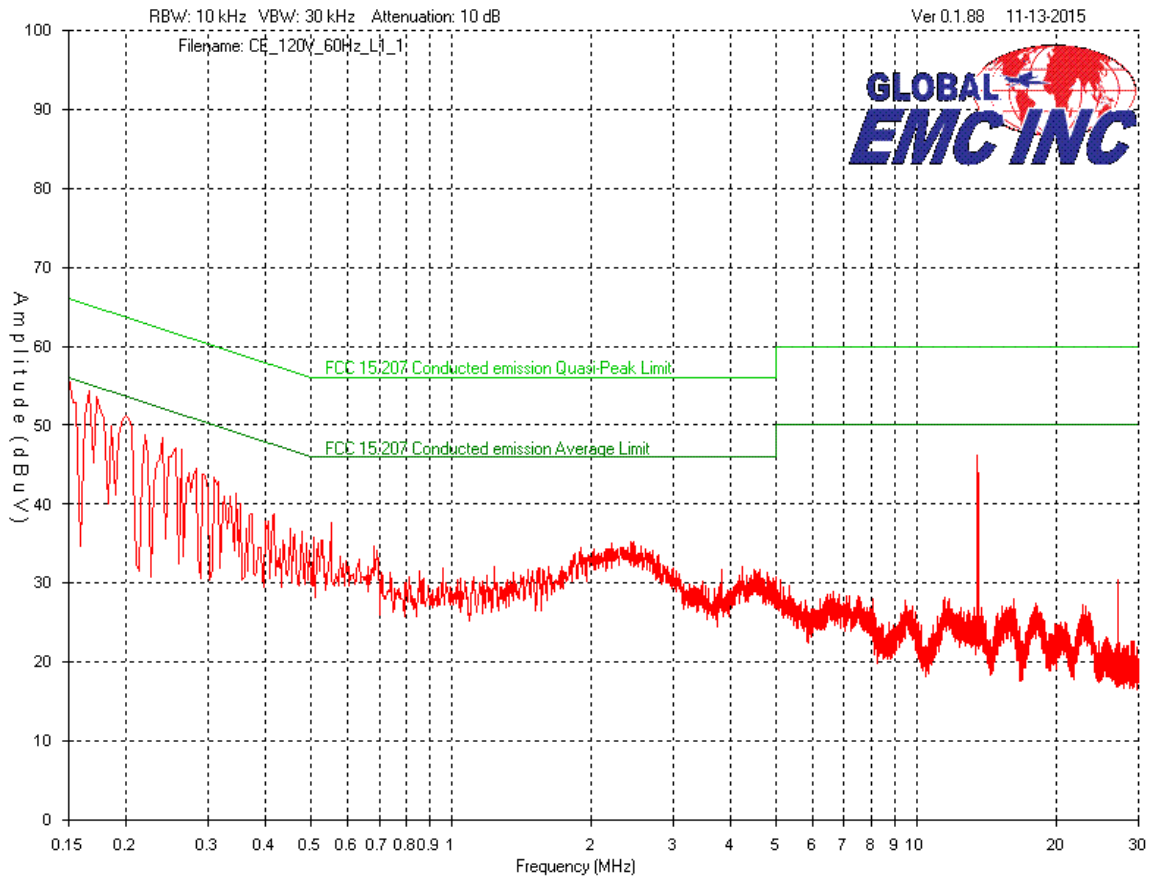

Client	Square Inc.	
Product	S6 Mobile Credit Card Reader (RFID)	
Standard(s)	FCC Part 15 Subpart C 15:2015 / RSS 210 Issue 8:2010	

Peak Emissions Graph - Line 2, Neutral
120V, 60Hz

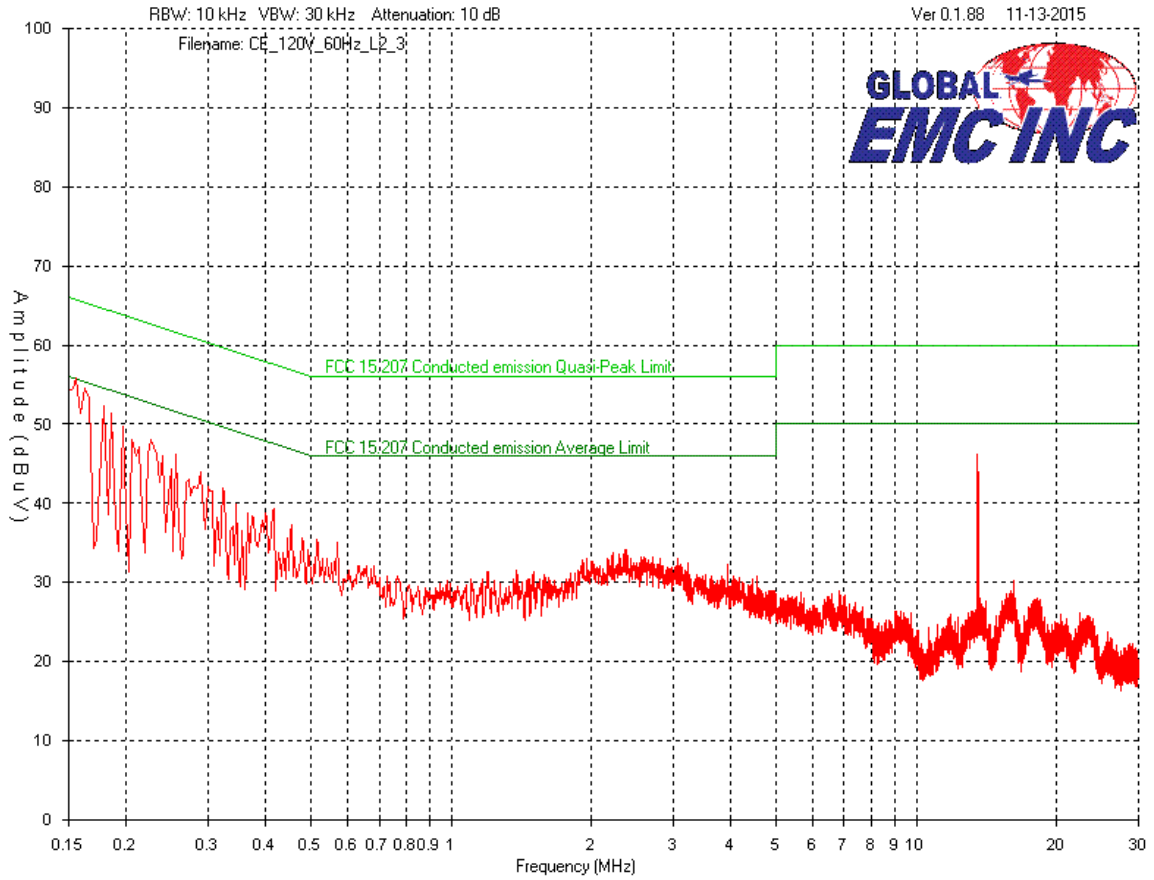

Client	Square Inc.	
Product	S6 Mobile Credit Card Reader (RFID)	
Standard(s)	FCC Part 15 Subpart C 15:2015 / RSS 210 Issue 8:2010	

Final Measurements

Emissions Table 120V, 60Hz

Test Frequency (MHz)	Detector	Received signal (dBµV)	Attenuator (dB)	Cable loss (dB)	LISN factor (dB)	Emission Level (dBµV)	Quasi-Peak Emission limit (dBµV)	Average Emission limit (dBµV)	Quasi-Peak Margin (dB)	Average Margin (dB)	Result
Line 1: Phase Line											
0.167	Peak	44.3	10	0.1	0	54.4	65.1	---	10.7	---	Pass
0.167	Avg.	28.42	10	0.1	0	38.52	---	55.1	---	16.58	Pass
0.173	Peak	43.4	10	0.1	0	53.5	64.8	---	11.3	---	Pass
0.173	Avg.	26.02	10	0.1	0	36.12	---	54.8	---	18.68	Pass
13.56	Peak	35.9	10	0.2	0.1	46.2	60	---	13.8	---	Pass
13.56	Avg.	35.72	10	0.2	0.1	46.02	---	50	---	3.98	Pass
0.200	Peak	41	10	0.1	0	51.1	63.6	53.6	12.5	2.5	Pass
0.153	Peak	42.8	10	0.1	0	52.9	65.8	55.8	12.9	2.9	Pass
0.240	Peak	38.4	10	0.1	0	48.5	62.1	52.1	13.6	3.6	Pass
Line 2: Neutral Line											
0.157	Peak	45.6	10	0.1	0	55.7	65.6	---	9.9	---	Pass
0.157	Avg.	28.77	10	0.1	0	38.87	---	55.6	---	16.73	Pass
0.180	Peak	42.2	10	0.1	0	52.3	64.5	---	12.2	---	Pass
0.180	Avg.	25.18	10	0.1	0	35.28	---	54.5	---	19.22	Pass
13.56	Peak	35.9	10	0.2	0.1	46.2	60	---	13.8	---	Pass
13.56	Avg.	36.16	10	0.2	0.1	46.46	---	50	---	3.54	Pass
0.187	Peak	41.3	10	0.1	0	51.4	64.2	54.2	12.8	2.8	Pass
0.196	Peak	39.5	10	0.1	0	49.6	63.8	53.8	14.2	4.2	Pass
0.226	Peak	37.9	10	0.1	0	48	62.6	52.6	14.6	4.6	Pass

Notes:

Peak = Peak measurement

Avg. = Average measurement

See 'Appendix B – EUT & Test Setup Photographs' for photos showing the test set-up

Client	Square Inc.	
Product	S6 Mobile Credit Card Reader (RFID)	
Standard(s)	FCC Part 15 Subpart C 15:2015 / RSS 210 Issue 8:2010	

Test Equipment List

Equipment	Model No.	Manufacturer	Last calibration date	Next calibration due date	Asset #
Spectrum Analyzer	FSU	Rohde & Schwarz	Jan. 19, 2015	Jan. 19, 2017	GEMC 198
LISN	FCC-LISN-50/250-16-2-01	FCC	Jan. 15, 2015	Jan. 15, 2017	GEMC 65
RF Cable 7m	LMR-400-7M-50OHM-MN-MN	LexTec	NCR	NCR	GEMC 28
Attenuator 10 dB	FP-50-10	Trilithic	NCR	NCR	GEMC 42

This report module is based on GEMC template "FCC – Power Line Conducted Emissions Class B_Rev1"

Client	Square Inc.	
Product	S6 Mobile Credit Card Reader (RFID)	
Standard(s)	FCC Part 15 Subpart C 15:2015 / RSS 210 Issue 8:2010	

Frequency Stability at Extreme Temperatures

Purpose

The purpose of this test is to ensure that the frequency tolerance of the carrier signal is maintained within the required limits during extreme temperature variations. This helps protect radio broadcasts and receivers close to the equipment under test from unwanted interference. This also helps ensure proper reception of the intended signal by ensuring the transmit frequency is correct over the expected temperature range.

Limit(s) and Method

The temperature test range is as defined in FCC Part 15, Section 15.225(e).

The variation of frequency must be recorded over the temperature range of -20°C to +50°C. The output frequency must remain within $\pm 0.01\%$ of the operating frequency (i.e. 13.54644 - 13.561356 MHz).

Results / Measurement Graphs

There is no deviation in the frequency of the EUT during this test which would cause it to be non-compliant with the specifications. The results are presented in the chart below.

The EUT is only rated to be used within 0°C - 40°C. The lowest temperature at which the RFID's fundamental transmission was detected is -10°C. The RFID is not operational at -20°C, and no transmission is detected at this temperature.

Temperature	Frequency Recorded After EUT is Turned On (MHz)			
	Immediately	2 mins	5 mins	10 mins
+50°C	13.5600961540	13.5600961540	13.5600961540	13.5600961540
+40 °C	13.5600961540	13.5600961540	13.5600961540	13.5600961540
+30 °C	13.5600961540	13.5600961540	13.5600961540	13.5600961540
+20 °C	13.5600961540	13.5600961540	13.5600961540	13.5600961540
+10°C	13.5600961540	13.5600961540	13.5600961540	13.5600961540
0 °C	13.5600961540	13.5600961540	13.5600961540	13.5600961540
-10 °C	13.5600961540	13.5600961540	13.5608974360	13.5600961540
-20 °C	13.56MHz circuit on EUT fails to operate at this temperature. No transmission.			

Client	Square Inc.	
Product	S6 Mobile Credit Card Reader (RFID)	
Standard(s)	FCC Part 15 Subpart C 15:2015 / RSS 210 Issue 8:2010	

Test Equipment List

Equipment	Model No.	Manufacturer	Last calibration date	Next calibration due date	Asset #
Spectrum Analyzer	FSU	Rohde & Schwarz	Jan. 19, 2015	Jan. 19, 2017	GEMC 198
Loop Antenna 100kHz – 30MHz	EM 6872	Electro-Metrics	Feb. 3, 2015	Feb. 3, 2017	GEMC 71
Temperature and Humidity Meter	HMP233	Vaisala	Dec. 1, 2014	Dec. 1, 2015	CANE 00043
RF Cable 1m	LMR-400- 1M-50OHM- MN-MN	LexTec	NCR	NCR	GEMC 29

This report module is based on GEMC template "FCC - 15.225 - RFID Freq Stab_Rev1.doc"

Client	Square Inc.	
Product	S6 Mobile Credit Card Reader (RFID)	
Standard(s)	FCC Part 15 Subpart C 15:2015 / RSS 210 Issue 8:2010	

Frequency Stability at Extreme Voltages

Purpose

The purpose of this test is to ensure that the frequency tolerance of the carrier signal is maintained within the required limits during extreme voltage variations. This helps protect radio broadcasts and receivers close to the equipment under test from unwanted interference. This also helps ensure proper reception of the intended signal by ensuring the transmit frequency is correct over expected variations in voltage.

Limits

The temperature test range is as defined in FCC Part 15, Section 15.225(e).

The variation of frequency must be recorded for a variation in the primary supply voltage from 85% - 115% of the rated supply voltage at a temperature of 20°C

Test Results.

There is no deviation in the frequency of the EUT during this test which would cause it to be non-compliant with the specifications. The results are presented in the chart below.

EUT rated voltage: 3.7 Vdc.

Voltage variation: 3.145 Vdc – 4.255 Vdc

Voltage (Vdc)	Frequency (MHz)
4.255	13.560320513
3.7	13.560320513
3.3	13.560320513
3.145	EUT fails to operate at this voltage. Voltage regulation stops operation of the EUT if the primary voltage source is below ~3.3Vdc.

Client	Square Inc.	
Product	S6 Mobile Credit Card Reader (RFID)	
Standard(s)	FCC Part 15 Subpart C 15:2015 / RSS 210 Issue 8:2010	

Test Equipment List

Equipment	Model No.	Manufacturer	Last calibration date	Next calibration due date	Asset #
Spectrum Analyzer	FSU	Rohde & Schwarz	Jan. 19, 2015	Jan. 19, 2017	GEMC 198
Loop Antenna 100kHz – 30MHz	EM 6872	Electro-Metrics	Feb. 3, 2015	Feb. 3, 2017	GEMC 71
Digital Multimeter	287	Fluke	Jun. 1, 2015	Jun. 1, 2016	CANE 00151
RF Cable 1m	LMR-400- 1M-50OHM- MN-MN	LexTec	NCR	NCR	GEMC 29

Client	Square Inc.	
Product	S6 Mobile Credit Card Reader (RFID)	
Standard(s)	FCC Part 15 Subpart C 15:2015 / RSS 210 Issue 8:2010	

Appendix A – EUT Summary

For further details for filing purposes, refer to filing package.

General EUT Description

Client Details	
Organization / Address	Square Inc. 1455 Market St. Suite 600 San Francisco, CA USA 95014
Contact	Kevin Ng
Phone	416-204-0032 x 85111
Email	kevinng@squareup.com
EUT (Equipment Under Test) Details	
EUT Model / Name	S6 / R12 Mobile Credit Card Reader
EUT is powered using	Internal Li-poly rechargeable battery or USB
Input voltage range(s) (V)	5VDC +/- 10%
Frequency range(s) (Hz)	NFC (13.56 MHz), Bluetooth Low Energy (2.402 GHz - 2.480 GHz)
Rated input current (A)	500 mA
Nominal power consumption (W)	1W (NFC radio on)
Transmits RF energy? (describe)	NFC and BLE. Both radios can transmit simultaneously
Basic EUT functionality description	Mobile credit card reader that can read contact and contactless cards. It connects to host devices via BLE or USB
Modes of operation	1, on
Frequency of all clocks present in EUT	32.768 kHz, 13.56 MHz, 24 MHz
I/O connectors description	USB Micro-B connector
Peripherals required to exercise EUT	Laptop to issue commands to the unit to enable radios
Dimensions of product	L: 68 mm W: 68 mm H: 11 mm

Note the EUT is considered to have been received the date of the commencement of the first test, unless otherwise stated. For a close-up picture of the EUT, see ‘Appendix B – EUT & Test Setup Photographs’.

Client	Square Inc.	
Product	S6 Mobile Credit Card Reader (RFID)	
Standard(s)	FCC Part 15 Subpart C 15:2015 / RSS 210 Issue 8:2010	

Appendix B – EUT and Test Setup Photographs

Notes:

These photos are for information purposes only.
 Also refer to .PDF files that are separate from this test report.

Picture captioned with “Internal view 8,” show the PCB after C2PC.
 Other photos of the EUT are similar before and after the C2PC.

Client	Square Inc.	
Product	S6 Mobile Credit Card Reader (RFID)	
Standard(s)	FCC Part 15 Subpart C 15:2015 / RSS 210 Issue 8:2010	

EUT – External view 1



Client	Square Inc.	
Product	S6 Mobile Credit Card Reader (RFID)	
Standard(s)	FCC Part 15 Subpart C 15:2015 / RSS 210 Issue 8:2010	

EUT – External view 2



Client	Square Inc.	
Product	S6 Mobile Credit Card Reader (RFID)	
Standard(s)	FCC Part 15 Subpart C 15:2015 / RSS 210 Issue 8:2010	

EUT – External view 3



Client	Square Inc.	
Product	S6 Mobile Credit Card Reader (RFID)	
Standard(s)	FCC Part 15 Subpart C 15:2015 / RSS 210 Issue 8:2010	

EUT – Internal view 1
Enclosure Cover removed

BLE antenna



Client	Square Inc.	
Product	S6 Mobile Credit Card Reader (RFID)	
Standard(s)	FCC Part 15 Subpart C 15:2015 / RSS 210 Issue 8:2010	

EUT – Internal view 2
PCB, side 1, with cage

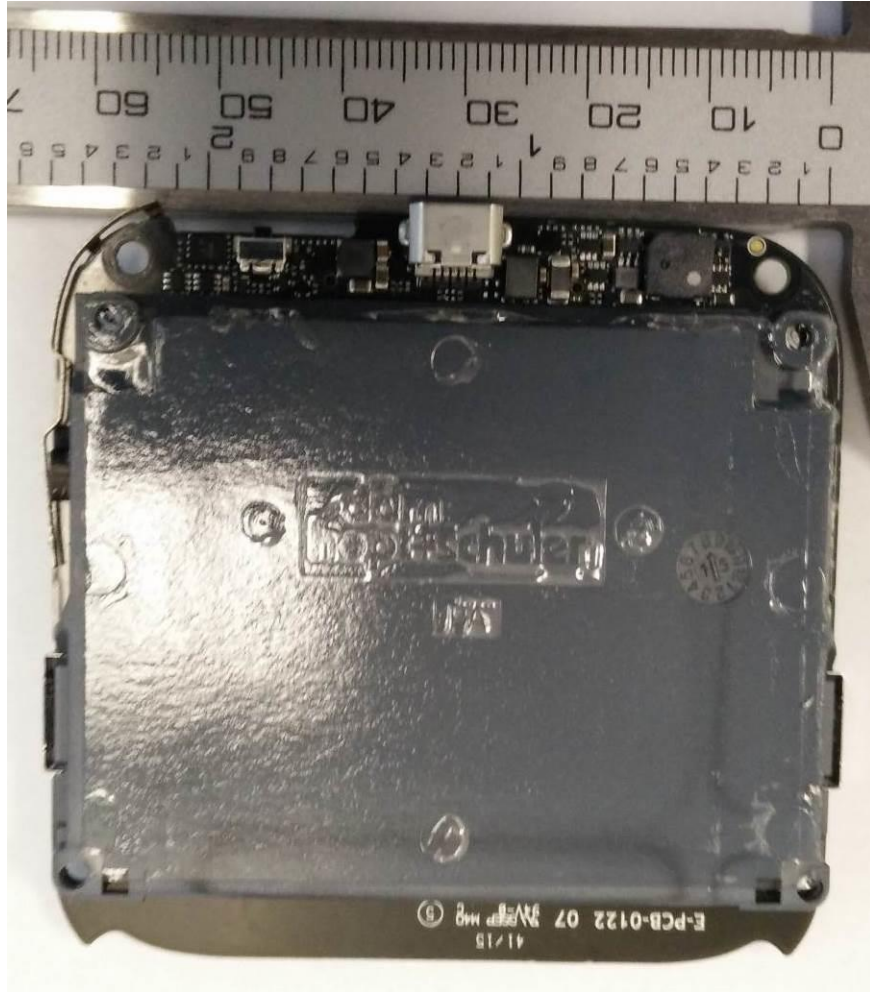

Client	Square Inc.	
Product	S6 Mobile Credit Card Reader (RFID)	
Standard(s)	FCC Part 15 Subpart C 15:2015 / RSS 210 Issue 8:2010	

EUT – Internal view 3
PCB, side 1, cage removed

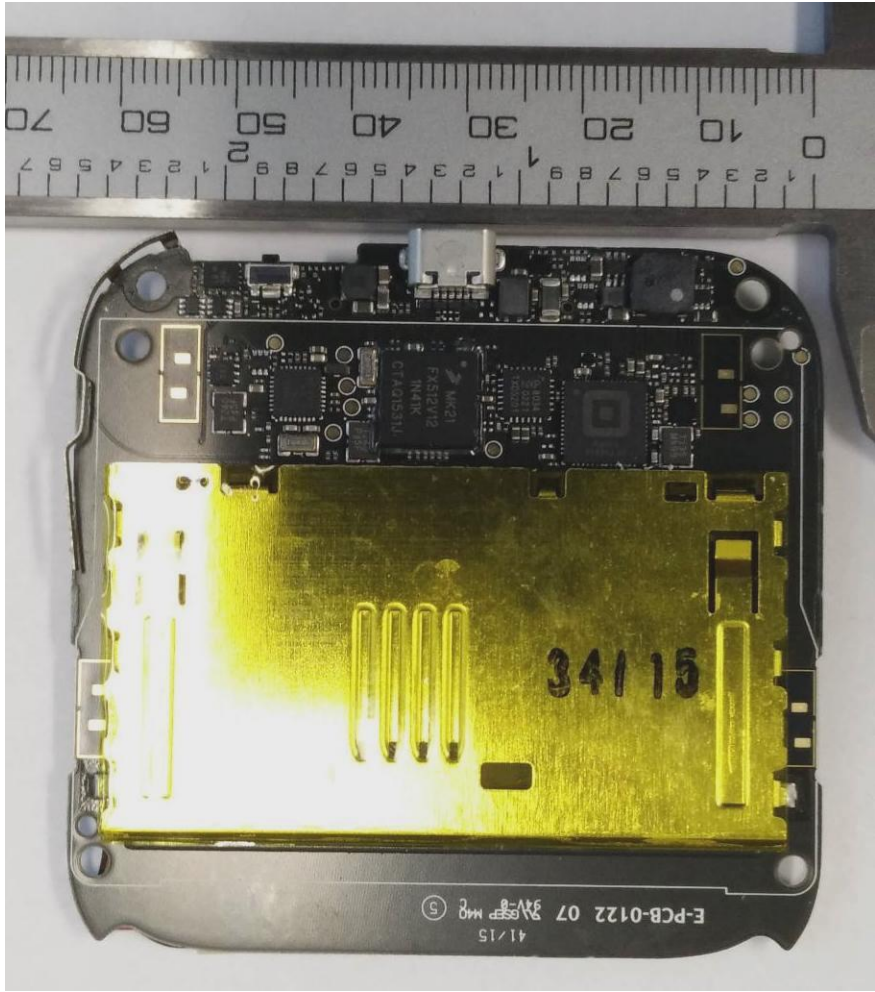

Client	Square Inc.	
Product	S6 Mobile Credit Card Reader (RFID)	
Standard(s)	FCC Part 15 Subpart C 15:2015 / RSS 210 Issue 8:2010	

EUT – Internal view 4
 PCB, side 1, cage removed, alternate angle



BLE antenna

Contact card socket soldered directly onto PCB. Not a shield. There are no components under this part.

Client	Square Inc.	
Product	S6 Mobile Credit Card Reader (RFID)	
Standard(s)	FCC Part 15 Subpart C 15:2015 / RSS 210 Issue 8:2010	

EUT – Internal view 5
PCB, side 2, with battery in place



Client	Square Inc.	
Product	S6 Mobile Credit Card Reader (RFID)	
Standard(s)	FCC Part 15 Subpart C 15:2015 / RSS 210 Issue 8:2010	

EUT – Internal view 6
PCB, side 2, battery removed

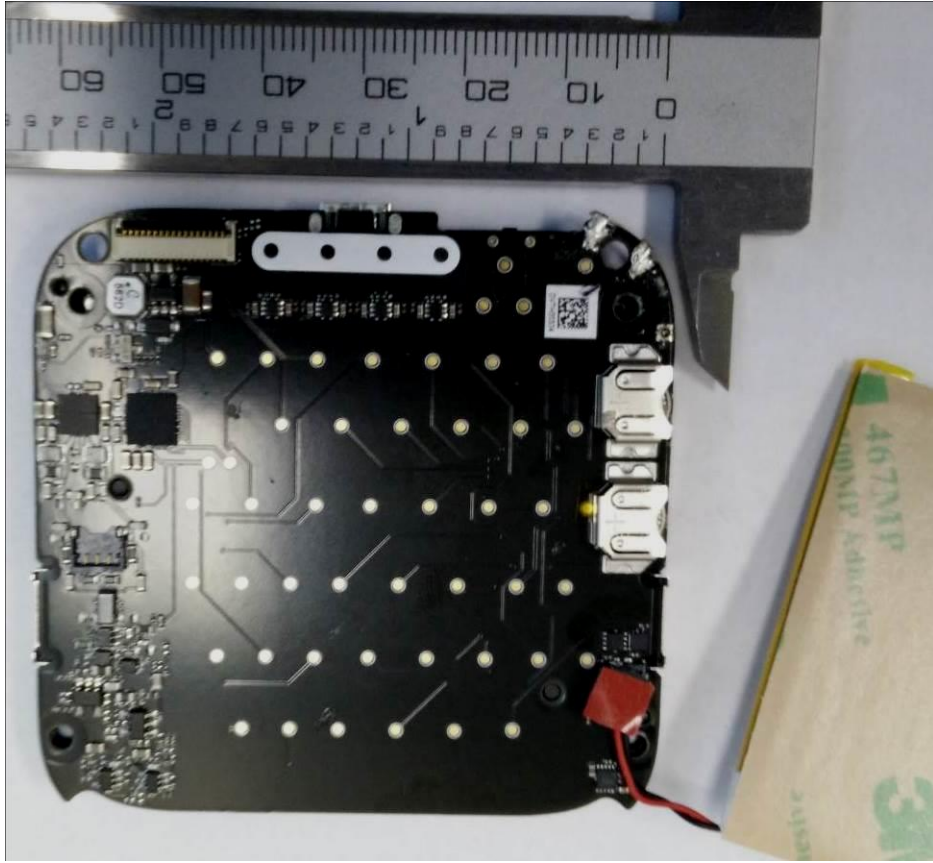

Client	Square Inc.	
Product	S6 Mobile Credit Card Reader (RFID)	
Standard(s)	FCC Part 15 Subpart C 15:2015 / RSS 210 Issue 8:2010	

EUT – Internal view 7
NFC antenna, mounted to housing

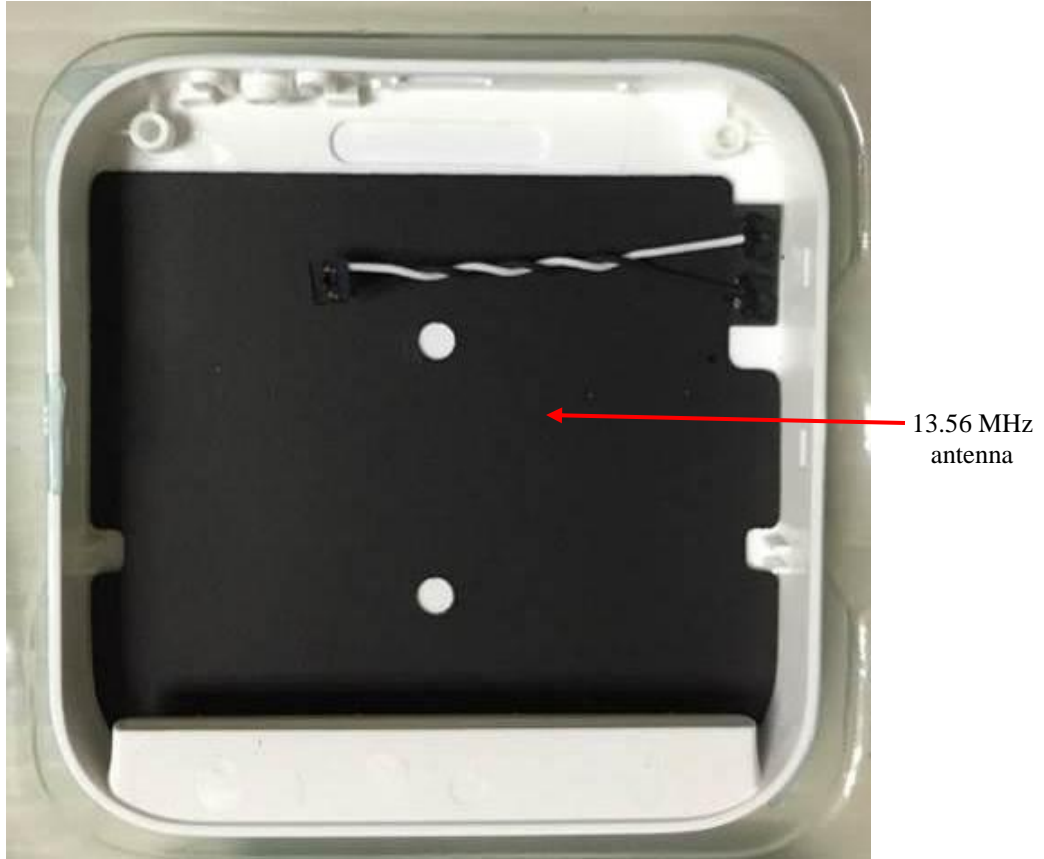

Client	Square Inc.	
Product	S6 Mobile Credit Card Reader (RFID)	
Standard(s)	FCC Part 15 Subpart C 15:2015 / RSS 210 Issue 8:2010	

EUT after C2PC– Internal view 8
PCB, side 2, battery removed

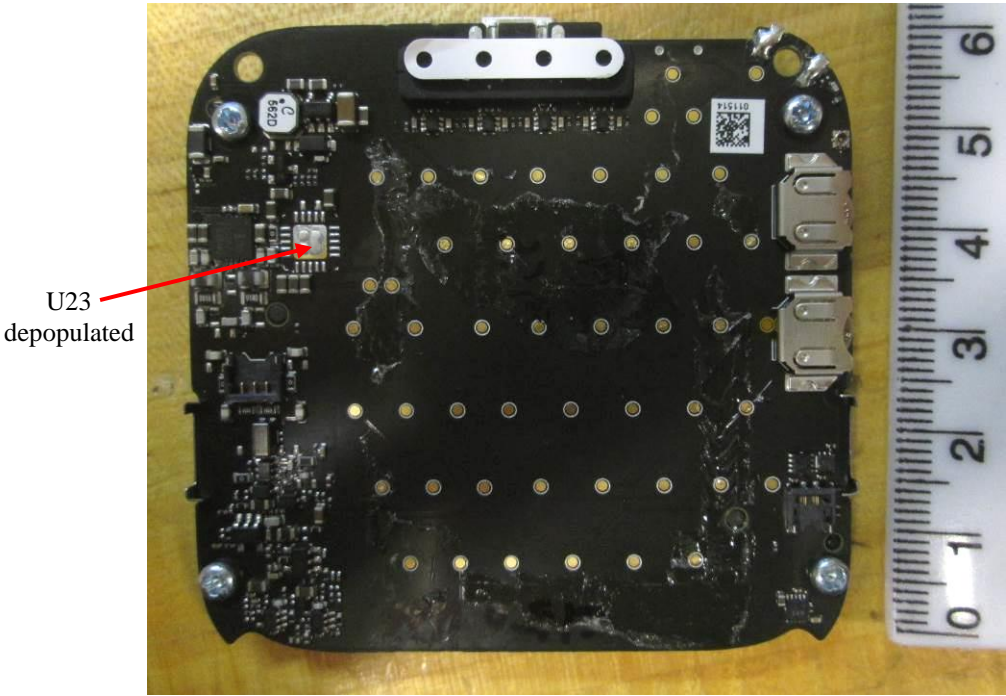

Client	Square Inc.	
Product	S6 Mobile Credit Card Reader (RFID)	
Standard(s)	FCC Part 15 Subpart C 15:2015 / RSS 210 Issue 8:2010	

Radiated Emissions Photo 1



Client	Square Inc.	
Product	S6 Mobile Credit Card Reader (RFID)	
Standard(s)	FCC Part 15 Subpart C 15:2015 / RSS 210 Issue 8:2010	

Radiated Emissions Photo 2



Client	Square Inc.	
Product	S6 Mobile Credit Card Reader (RFID)	
Standard(s)	FCC Part 15 Subpart C 15:2015 / RSS 210 Issue 8:2010	

Frequency Stability at Extreme Temperatures



Client	Square Inc.	
Product	S6 Mobile Credit Card Reader (RFID)	
Standard(s)	FCC Part 15 Subpart C 15:2015 / RSS 210 Issue 8:2010	

Frequency Stability at Extreme Voltages

