

FCC Radio Test Report

FCC ID: 2AF2V-MGT101

Original Grant

Report No. : TB-FCC145360
Applicant : Motic China Group Co., LTD
Equipment Under Test (EUT)
EUT Name : 10.1 inch Quad core capacitive touch tablet
Model No. : MGT101
Series No. : N/A
Brand Name : Motic
Receipt Date : 2015-09-08
Test Date : 2015-09-08 to 2015-09-29
Issue Date : 2015-09-30
Standards : FCC Part 15, Subpart C (15.247:2015)
Test Method : ANSI C63.10: 2013
Conclusions : **PASS**

In the configuration tested, the EUT complied with the standards specified above,
The EUT technically complies with the FCC and IC requirements

**Test/Witness
Engineer** :

IWAN SU

**Approved &
Authorized** :

Rayhai

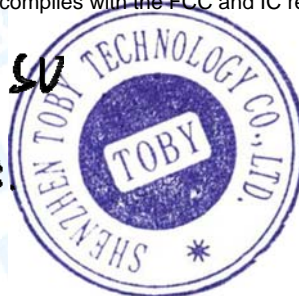

This report details the results of the testing carried out on one sample. The results contained in this test report do not relate to other samples of the same product. The manufacturer should ensure that all products in series production are in conformity with the product sample detailed in the report.

Contents

CONTENTS	2
1. GENERAL INFORMATION ABOUT EUT	4
1.1 Client Information.....	4
1.2 General Description of EUT (Equipment Under Test)	4
1.3 Block Diagram Showing the Configuration of System Tested.....	5
1.4 Description of Support Units	5
1.5 Description of Test Mode.....	6
1.6 Description of Test Software Setting	7
1.7 Measurement Uncertainty	7
1.8 Test Facility.....	8
2. TEST SUMMARY	9
3. TEST EQUIPMENT	10
4. CONDUCTED EMISSION TEST	11
4.1 Test Standard and Limit.....	11
4.2 Test Setup.....	11
4.3 Test Procedure.....	11
4.4 EUT Operating Mode	12
4.5 Test Data.....	12
5. RADIATED EMISSION TEST	17
5.1 Test Standard and Limit.....	17
5.2 Test Setup.....	18
5.3 Test Procedure.....	19
5.4 EUT Operating Condition	20
5.5 Test Data.....	20
6. RESTRICTED BANDS REQUIREMENT	33
6.1 Test Standard and Limit.....	33
6.2 Test Setup.....	33
6.3 Test Procedure.....	33
6.4 EUT Operating Condition	34
6.5 Test Data.....	34
7. BANDWIDTH TEST	40
7.1 Test Standard and Limit.....	40
7.2 Test Setup.....	40
7.3 Test Procedure.....	40
7.4 EUT Operating Condition	40
7.5 Test Data.....	41
8. PEAK OUTPUT POWER TEST	43
8.1 Test Standard and Limit.....	43
8.2 Test Setup.....	43

8.3 Test Procedure.....	43
8.4 EUT Operating Condition	43
8.5 Test Data.....	44
9. POWER SPECTRAL DENSITY TEST	46
9.1 Test Standard and Limit.....	46
9.2 Test Setup.....	46
9.3 Test Procedure.....	46
9.4 EUT Operating Condition	46
8.5 Test Data.....	47
10. ANTENNA REQUIREMENT.....	49
10.1 Standard Requirement.....	49
10.2 Antenna Connected Construction.....	49
10.3 Result.....	49

1. General Information about EUT

1.1 Client Information

Applicant : Motic China Group Co., LTD
Address : Motic Building, Torch Hi-Tech Industrial Development Zone, Xiamen, P.R.C
Manufacturer : Shenzhen Huaruian Technology Co., Ltd
Address : HuaRuiAn Building, The Third Industrial Park, Gushu, Xixiang, Bao'an District, Shenzhen, Guangdong, China

1.2 General Description of EUT (Equipment Under Test)

EUT Name	: 10.1 inch Quad core capacitive touch tablet
Models No.	: MGT101
Model Difference	: N/A
Product Description	Operation Frequency: 2402MHz~2480MHz
	Number of Channel: Bluetooth 4.0 (BLE): 40 channels <i>see note(3)</i>
	RF Output Power: 3.803 dBm Conducted Power
	Antenna Gain: 0.75 dBi FPC Antenna
	Modulation Type: GFSK
	Bit Rate of Transmitter: 1Mbps(GFSK)
Power Supply	: DC Voltage supplied from Host System by USB cable. DC power supplied by AC/DC Adapter. DC power by Li-ion Battery.
Power Rating	: DC 5.0V by USB cable. DC 3.7V 6000mAh Li-ion Battery. AC/DC Adapter: Input:100~240V, 50/60Hz 0.4A Output:5V, 2000mA
Connecting I/O Port(S)	: Please refer to the User's Manual

Note:

- (1) This Test Report is FCC Part 15.247 for Bluetooth BLE, the test procedure follows the FCC KDB 558074 D01 DTS Meas Guidance v03r03.
- (2) For a more detailed features description, please refer to the manufacturer's specifications or the User's Manual.
- (3) Antenna information provided by the applicant.
- (4) Channel List:

Channel	Frequency (MHz)	Channel	Frequency (MHz)	Channel	Frequency (MHz)
00	2402	14	2430	28	2458
01	2404	15	2432	29	2460
02	2406	16	2434	30	2462
03	2408	17	2436	31	2464
04	2410	18	2438	32	2466
05	2412	19	2440	33	2468
06	2414	20	2442	34	2470
07	2416	21	2444	35	2472
08	2418	22	2446	36	2474
09	2420	23	2448	37	2476
10	2422	24	2450	38	2478
11	2424	25	2452	39	2480
12	2426	26	2454		
13	2428	27	2456		

1.3 Block Diagram Showing the Configuration of System Tested

TX Mode

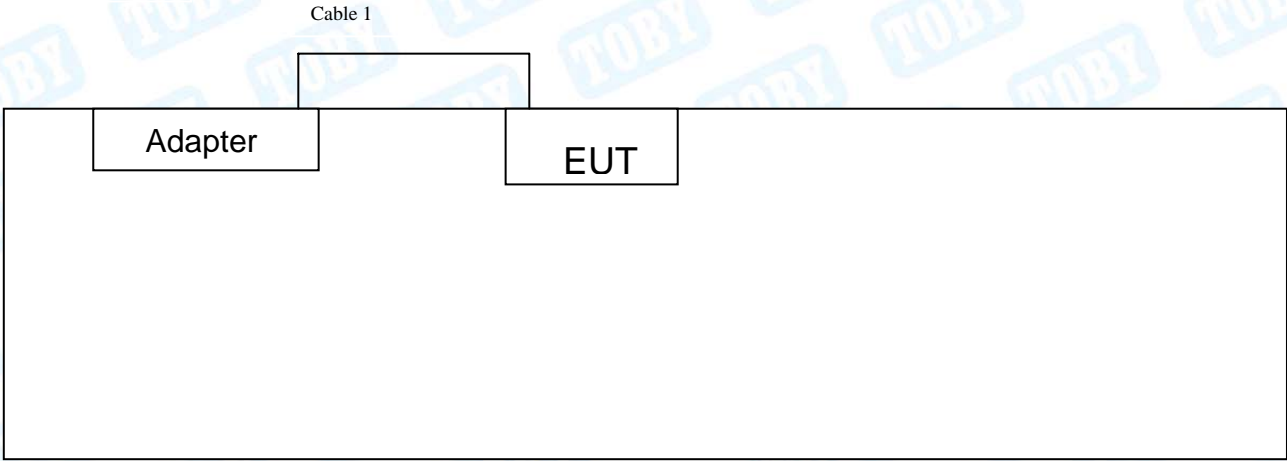

1.4 Description of Support Units

Equipment Information				
Name	Model	FCC ID/DOC	Manufacturer	Used “√”
N/A	N/A	N/A	N/A	N/A
Cable Information				
Number	Shielded Type	Ferrite Core	Length	Note
Cable 1	NO	NO	1.2M	

1.5 Description of Test Mode

To investigate the maximum EMI emission characteristics generates from EUT, the test system was pre-scanning tested base on the consideration of following EUT operation mode or test configuration mode which possible have effect on EMI emission level. Each of these EUT operation mode(s) or test configuration mode(s) mentioned follow was evaluated respectively.

For Conducted Test	
Final Test Mode	Description
Mode 1	AC Charging With TX Mode

For Radiated Test	
Final Test Mode	Description
Mode 2	AC Charging With TX Mode
Mode 3	TX Mode (Channel 00/20/39)

Note:

- (1) For all test, we have verified the construction and function in typical operation. And all the test modes were carried out with the EUT in transmitting operation in maximum power with all kinds of data rate.

According to ANSI C63.10 standards, the measurements are performed at the highest, middle, lowest available channels, and the worst case data rate as follows:

Bluetooth BLE Mode: GFSK Modulation Transmitting mode.

- (2) During the testing procedure, the continuously transmitting with the maximum power mode was programmed by the customer.
- (3) The EUT is considered a mobile unit; in normal use it was positioned on X-plane. The worst case was found positioned on X-plane. Therefore only the test data of this X-plane was used for radiated emission measurement test.

1.6 Description of Test Software Setting

During testing channel & Power controlling software provided by the customer was used to control the operating channel as well as the output power level. The RF output power selection is for the setting of RF output power expected by the customer and is going to be fixed on the firmware of the final end product power parameters of RF setting.

Test Software Version	Ampak TestTool, VER :5.3		
Channel	CH 00	CH 20	CH 39
BLE Mode	DEF	DEF	DEF

1.7 Measurement Uncertainty

The reported uncertainty of measurement $y \pm U$, where expanded uncertainty U is based on a standard uncertainty multiplied by a coverage factor of $k=2$, providing a level of confidence of approximately 95 %.

Test Item	Parameters	Expanded Uncertainty (U_{Lab})
Conducted Emission	Level Accuracy: 9kHz~150kHz	± 3.42 dB
	150kHz to 30MHz	± 3.42 dB
Radiated Emission	Level Accuracy: 9kHz to 30 MHz	± 4.60 dB
Radiated Emission	Level Accuracy: 30MHz to 1000 MHz	± 4.40 dB
Radiated Emission	Level Accuracy: Above 1000MHz	± 4.20 dB

1.8 Test Facility

The testing report were performed by the Shenzhen Toby Technology Co., Ltd., in their facilities located at 1A/F., Bldg.6, Yusheng Industrial Zone, The National Road No.107 Xixiang Section 467, Xixiang, Bao'an, Shenzhen, Guangdong, China. At the time of testing, the following bodies accredited the Laboratory:

CNAS (L5813)

The Laboratory has been accredited by CNAS to ISO/IEC 17025: 2005 General Requirements for the Competence of Testing and Calibration Laboratories for the competence in the field of testing. And the Registration No.: CNAS L5813.

FCC List No.: (811562)

The Laboratory is listed in the United States of American Federal Communications Commission (FCC), and the registration number is 811562.

IC Registration No.: (11950A-1)

The Laboratory has been registered by Certification and Engineering Bureau of Industry Canada for radio equipment testing. The site registration: Site# 11950A-1.

May 22, 2014 certificated by TUV Rheinland(China) Co., Ltd. with TUV certificate No.: UA 50282953 0001 and report No.: 17026822 002. The certificate is valid until the next scheduled audit or up to 18 months, at the discretion of TUV Rhineland.

2. Test Summary

FCC Part 15 Subpart C(15.247)/RSS 247 Issue 1				
Standard Section		Test Item	Judgment	Remark
FCC	IC			
15.203	/	Antenna Requirement	PASS	N/A
15.207	RSS-GEN 7.2.4	Conducted Emission	PASS	N/A
15.205	RSS-GEN 7.2.2	Restricted Bands	PASS	N/A
15.247(a)(2)	RSS 247 5.2 (1)	6dB Bandwidth	PASS	N/A
15.247(b)	RSS 247 5.4 (4)	Peak Output Power	PASS	N/A
15.247(e)	RSS 247 5.2 (2)	Power Spectral Density	PASS	N/A
15.247(d)	RSS 247 5.5	Transmitter Radiated Spurious Emission	PASS	N/A

Note: “/” for no requirement for this test item.
N/A is an abbreviation for Not Applicable.

3. Test Equipment

Conducted Emission Test					
Equipment	Manufacturer	Model No.	Serial No.	Last Cal.	Cal. Due Date
EMI Test Receiver	Rohde & Schwarz	ESCI	100321	Aug. 07, 2015	Aug. 06, 2016
RF Switching Unit	Compliance Direction Systems Inc	RSU-A4	34403	Aug. 07, 2015	Aug. 06, 2016
AMN	SCHWARZBECK	NNBL 8226-2	8226-2/164	Aug. 07, 2015	Aug. 06, 2016
LISN	Rohde & Schwarz	ENV216	101131	Aug. 07, 2015	Aug. 06, 2016
Radiation Emission Test					
Equipment	Manufacturer	Model No.	Serial No.	Last Cal.	Cal. Due Date
Spectrum Analyzer	Agilent	E4407B	MY45106456	Aug. 29, 2015	Aug. 28, 2016
EMI Test Receiver	Rohde & Schwarz	ESCI	100010/007	Aug. 07, 2015	Aug. 06, 2016
Bilog Antenna	ETS-LINDGREN	3142E	00117537	Mar. 28, 2015	Mar. 27, 2016
Bilog Antenna	ETS-LINDGREN	3142E	00117542	Mar. 28, 2015	Mar. 27, 2016
Horn Antenna	ETS-LINDGREN	3117	00143207	Mar. 28, 2015	Mar. 27, 2016
Horn Antenna	ETS-LINDGREN	3117	00143209	Mar. 28, 2015	Mar. 27, 2016
Pre-amplifier	Sonoma	310N	185903	Mar. 28, 2015	Mar. 27, 2016
Pre-amplifier	HP	8447B	3008A00849	Mar. 28, 2015	Mar. 27, 2016
Cable	HUBER+SUHNER	100	SUCOFLEX	Mar. 28, 2015	Mar. 27, 2016
Positioning Controller	ETS-LINDGREN	2090	N/A	N/A	N/A

4. Conducted Emission Test

4.1 Test Standard and Limit

4.1.1 Test Standard
FCC Part 15.207

4.1.2 Test Limit

Conducted Emission Test Limit

Frequency	Maximum RF Line Voltage (dB μ V)	
	Quasi-peak Level	Average Level
150kHz~500kHz	66 ~ 56 *	56 ~ 46 *
500kHz~5MHz	56	46
5MHz~30MHz	60	50

Notes:

- (1) *Decreasing linearly with logarithm of the frequency.
- (2) The lower limit shall apply at the transition frequencies.
- (3) The limit decrease in line with the logarithm of the frequency in the range of 0.15 to 0.50MHz.

4.2 Test Setup

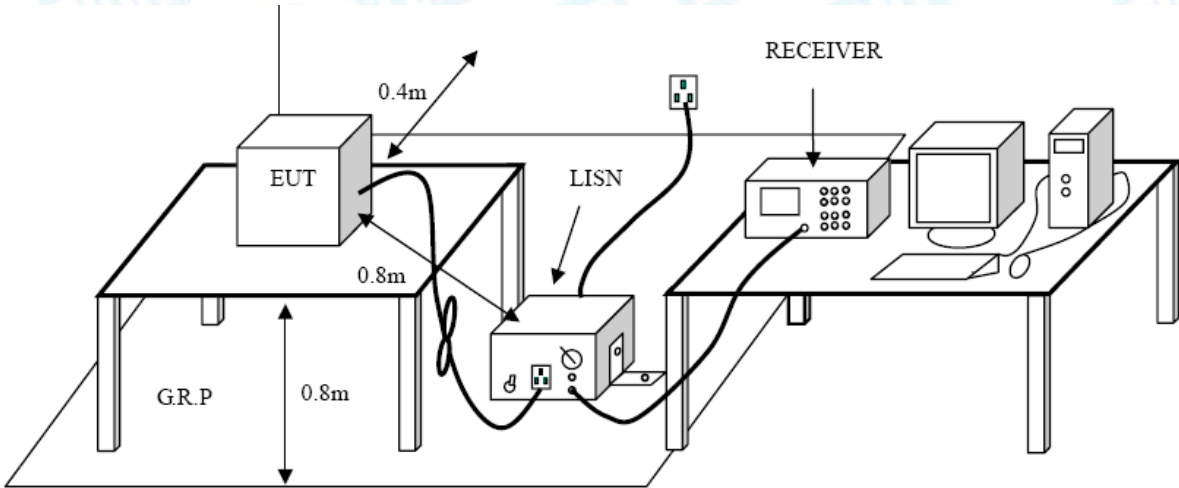

4.3 Test Procedure

The EUT was placed 0.8 meters from the horizontal ground plane with EUT being connected to the power mains through a line impedance stabilization network (LISN). All other support equipments powered from additional LISN(s). The LISN provide 50 Ohm/ 50uH of coupling impedance for the measuring instrument.

Interconnecting cables that hang closer than 40 cm to the ground plane shall be folded back and forth in the center forming a bundle 30 to 40 cm long.

I/O cables that are not connected to a peripheral shall be bundled in the center. The end of the cable may be terminated, if required, using the correct terminating impedance. The overall length shall not exceed 1 m.

LISN at least 80 cm from nearest part of EUT chassis.

The bandwidth of EMI test receiver is set at 9kHz, and the test frequency band is from 0.15MHz to 30MHz.

4.4 EUT Operating Mode

Please refer to the description of test mode.

4.5 Test Data

Test data please refer the following pages.

EUT:	10.1 inch Quad core capacitive touch tablet	Model Name :	MGT101
Temperature:	25 °C	Relative Humidity:	55%
Test Voltage:	AC 120V/60Hz		
Terminal:	Line		
Test Mode:	AC Charging with TX BLE Mode 2402MHz		
Remark:	Only worse case is reported		

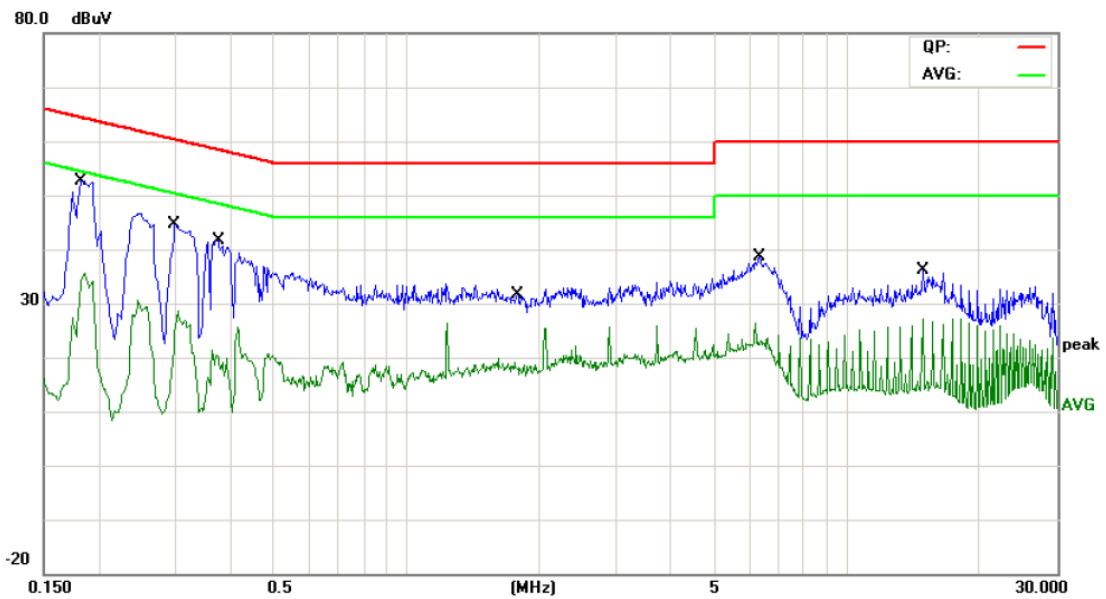

No.	Mk.	Freq. MHz	Reading Level dBuV	Correct Factor dB	Measure- ment dBuV	Limit dBuV	Over dB	Detector
1	*	0.1819	39.61	9.98	49.59	64.39	-14.80	QP
2		0.1819	22.94	9.98	32.92	54.39	-21.47	AVG
3		0.2980	29.64	10.02	39.66	60.30	-20.64	QP
4		0.2980	14.03	10.02	24.05	50.30	-26.25	AVG
5		0.3740	27.07	10.02	37.09	58.41	-21.32	QP
6		0.3740	8.80	10.02	18.82	48.41	-29.59	AVG
7		1.7820	16.32	10.06	26.38	56.00	-29.62	QP
8		1.7820	7.42	10.06	17.48	46.00	-28.52	AVG
9		6.3340	22.04	10.03	32.07	60.00	-27.93	QP
10		6.3340	11.90	10.03	21.93	50.00	-28.07	AVG
11		14.8580	20.93	10.26	31.19	60.00	-28.81	QP
12		14.8580	16.42	10.26	26.68	50.00	-23.32	AVG

*:Maximum data x:Over limit !:over margin

Emission Level= Read Level+ Correct Factor

EUT:	10.1 inch Quad core capacitive touch tablet	Model Name :	MGT101
Temperature:	25 °C	Relative Humidity:	55%
Test Voltage:	AC 120V/60Hz		
Terminal:	Neutral		
Test Mode:	AC Charging with TX BLE Mode 2402MHz		
Remark:	Only worse case is reported		

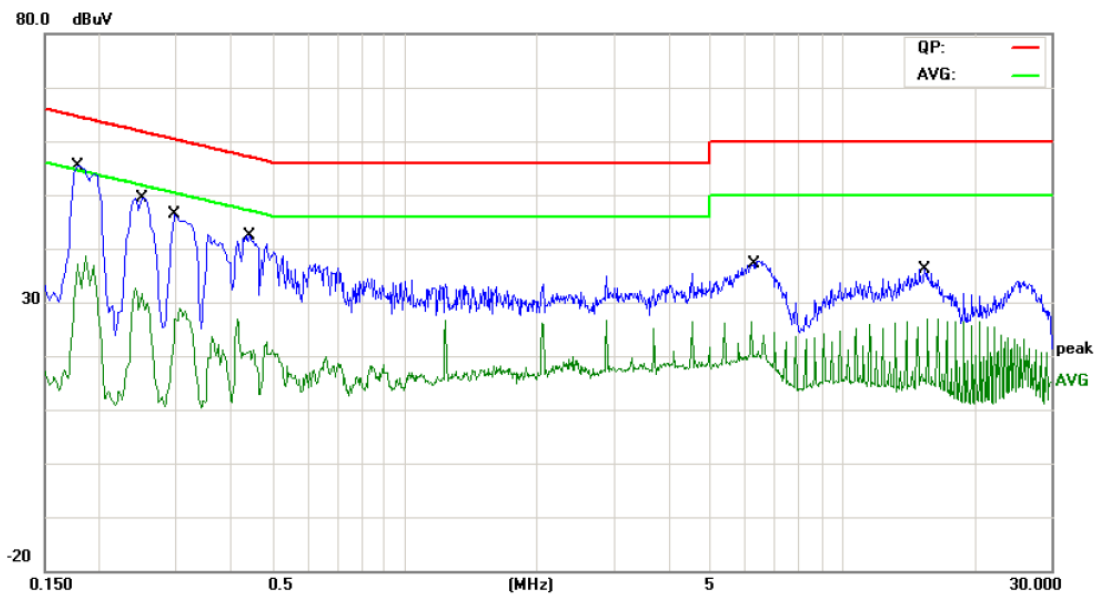

No.	Mk.	Freq. MHz	Reading Level dBuV	Correct Factor dB	Measure- ment dBuV	Limit dBuV	Over dB	Detector
1	*	0.1780	40.76	10.12	50.88	64.57	-13.69	QP
2		0.1780	21.31	10.12	31.43	54.57	-23.14	AVG
3		0.2500	35.54	10.10	45.64	61.75	-16.11	QP
4		0.2500	19.60	10.10	29.70	51.75	-22.05	AVG
5		0.2980	31.80	10.09	41.89	60.30	-18.41	QP
6		0.2980	15.10	10.09	25.19	50.30	-25.11	AVG
7		0.4420	26.22	10.04	36.26	57.02	-20.76	QP
8		0.4420	8.73	10.04	18.77	47.02	-28.25	AVG
9		6.2819	21.71	10.06	31.77	60.00	-28.23	QP
10		6.2819	8.17	10.06	18.23	50.00	-31.77	AVG
11		15.4660	18.01	10.06	28.07	60.00	-31.93	QP
12		15.4660	3.34	10.06	13.40	50.00	-36.60	AVG

*:Maximum data x:Over limit !:over margin

Emission Level= Read Level+ Correct Factor

EUT:	10.1 inch Quad core capacitive touch tablet	Model Name :	MGT101
Temperature:	25 °C	Relative Humidity:	55%
Test Voltage:	AC 240V/60Hz		
Terminal:	Line		
Test Mode:	AC Charging with TX BLE Mode 2402MHz		
Remark:	Only worse case is reported		



No.	Mk.	Freq. MHz	Reading Level dBuV	Correct Factor dB	Measure- ment dBuV	Limit dBuV	Over dB	Detector
1	*	0.1860	41.58	9.99	51.57	64.21	-12.64	QP
2		0.1860	25.87	9.99	35.86	54.21	-18.35	AVG
3		0.2380	35.29	10.02	45.31	62.16	-16.85	QP
4		0.2380	19.29	10.02	29.31	52.16	-22.85	AVG
5		0.3740	29.32	10.02	39.34	58.41	-19.07	QP
6		0.3740	16.30	10.02	26.32	48.41	-22.09	AVG
7		6.3940	21.68	10.03	31.71	60.00	-28.29	QP
8		6.3940	11.78	10.03	21.81	50.00	-28.19	AVG
9		15.6380	16.93	10.25	27.18	60.00	-32.82	QP
10		15.6380	7.80	10.25	18.05	50.00	-31.95	AVG
11		25.9340	19.37	10.18	29.55	60.00	-30.45	QP
12		25.9340	12.38	10.18	22.56	50.00	-27.44	AVG

*:Maximum data x:Over limit !:over margin

Emission Level= Read Level+ Correct Factor

EUT:	10.1 inch Quad core capacitive touch tablet	Model Name :	MGT101
Temperature:	25 °C	Relative Humidity:	55%
Test Voltage:	AC 240V/60Hz		
Terminal:	Neutral		
Test Mode:	AC Charging with TX BLE Mode 2402MHz		
Remark:	Only worse case is reported		

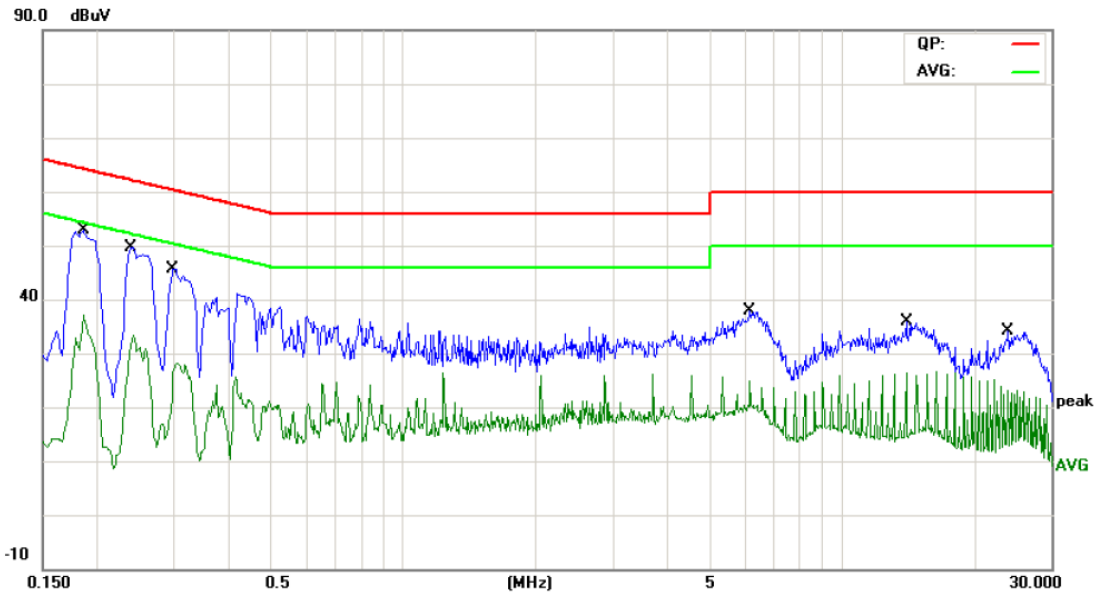

No.	Mk.	Freq. MHz	Reading Level dBuV	Correct Factor dB	Measure- ment dBuV	Limit dBuV	Over dB	Detector
1	*	0.1860	39.37	9.99	49.36	64.21	-14.85	QP
2		0.1860	23.59	9.99	33.58	54.21	-20.63	AVG
3		0.2380	34.54	10.02	44.56	62.16	-17.60	QP
4		0.2380	17.03	10.02	27.05	52.16	-25.11	AVG
5		0.2980	31.16	10.02	41.18	60.30	-19.12	QP
6		0.2980	15.06	10.02	25.08	50.30	-25.22	AVG
7		6.1779	22.45	10.02	32.47	60.00	-27.53	QP
8		6.1779	15.21	10.02	25.23	50.00	-24.77	AVG
9		14.0020	18.40	10.24	28.64	60.00	-31.36	QP
10		14.0020	12.31	10.24	22.55	50.00	-27.45	AVG
11		23.8900	16.85	10.16	27.01	60.00	-32.99	QP
12		23.8900	11.32	10.16	21.48	50.00	-28.52	AVG

*:Maximum data x:Over limit !:over margin

Emission Level= Read Level+ Correct Factor

5. Radiated Emission Test

5.1 Test Standard and Limit

5.1.1 Test Standard

FCC Part 15.209

5.1.2 Test Limit

Radiated Emission Limits (9kHz~1000MHz)

Frequency (MHz)	Field Strength (microvolt/meter)	Measurement Distance (meters)
0.009~0.490	2400/F(KHz)	300
0.490~1.705	24000/F(KHz)	30
1.705~30.0	30	30
30~88	100	3
88~216	150	3
216~960	200	3
Above 960	500	3

Radiated Emission Limit (Above 1000MHz)

Frequency (MHz)	Class A (dBuV/m)(at 3 M)		Class B (dBuV/m)(at 3 M)	
	Peak	Average	Peak	Average
Above 1000	80	60	74	54

Note:

- (1) The tighter limit applies at the band edges.
- (2) Emission Level(dBuV/m)=20log Emission Level(uV/m)

5.2 Test Setup

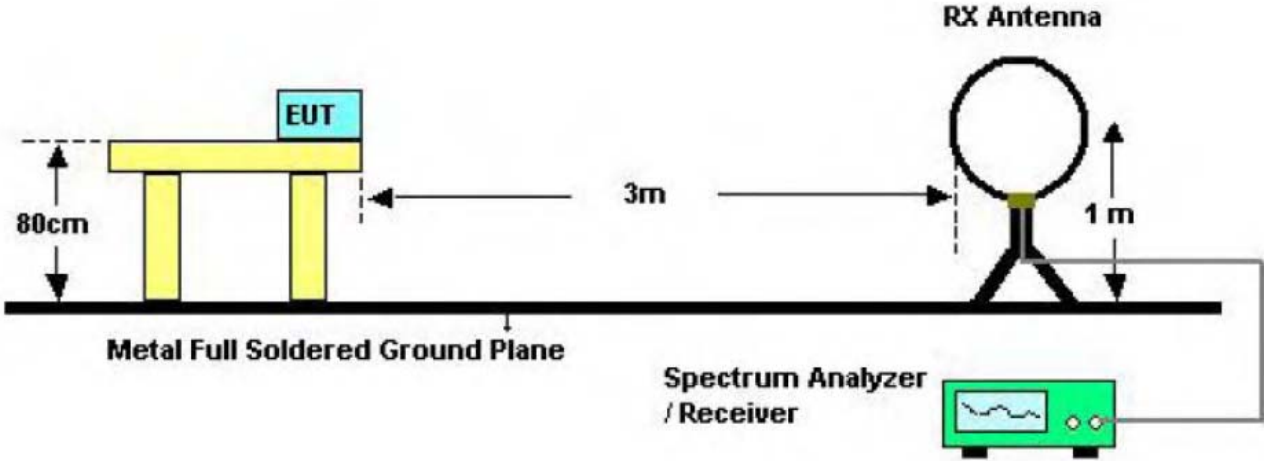

Below 30MHz Test Setup

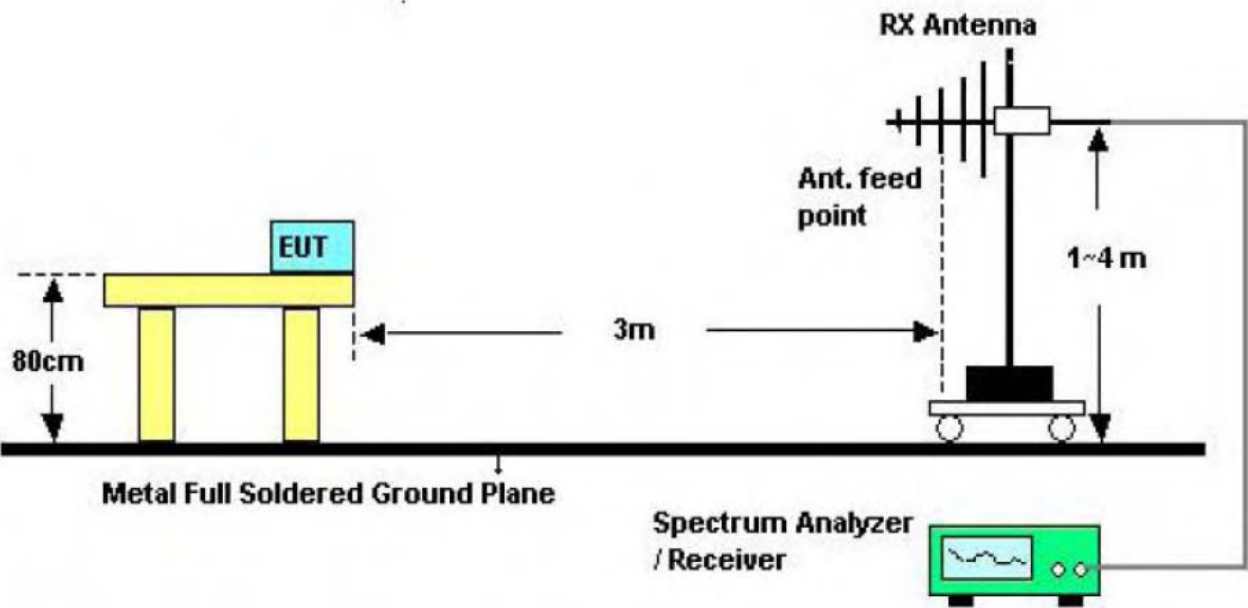

Below 1000MHz Test Setup

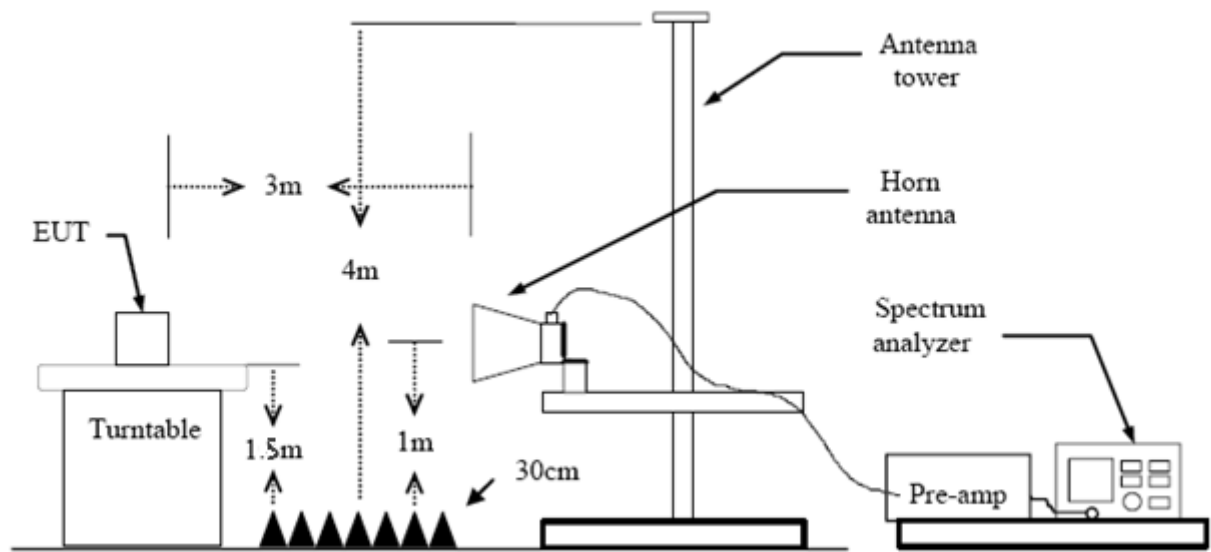

Above 1GHz Test Setup

5.3 Test Procedure

- (1) The measuring distance of 3m shall be used for measurements at frequency up to 1GHz and above 1 GHz. The EUT was placed on a rotating 0.8m high above ground, the table was rotated 360 degrees to determine the position of the highest radiation.
- (2) Measurements at frequency above 1GHz. The EUT was placed on a rotating 1.5m high above the ground. RF absorbers covered the ground plane with a minimum area of 3.0m by 3.0m between the EUT and measurement receiver antenna. The RF absorber shall not exceed 30cm in high above the conducting floor. The table was rotated 360 degrees to determine the position of the highest radiation.
- (3) The Test antenna shall vary between 1m and 4m, Both Horizontal and Vertical antenna are set to make measurement.
- (4) The initial step in collecting conducted emission data is a spectrum analyzer peak detector mode pre-scanning the measurement frequency range. Significant peaks are then marked and then Quasi Peak detector mode re-measured.
- (5) If the Peak Mode measured value compliance with and lower than Quasi Peak Mode Limit Bellow 1 GHz, the EUT shall be deemed to meet QP Limits and then no additional QP Mode measurement performed. But the Peak Value and average value both need to comply with applicable limit above 1 GHz.
- (6) Testing frequency range below 1GHz the measuring instrument use VBW=120 kHz with Quasi-peak detection.
- (7) Testing frequency range above 1GHz the measuring instrument use RBW=1 MHz and VBW=3 MHz with Peak Detector for Peak Values, and use RBW=1 MHz and VBW=10 Hz with Peak Detector for Average Values.
- (8) For the actual test configuration, please see the test setup photo.

5.4 EUT Operating Condition

The Equipment Under Test was set to Continual Transmitting in maximum power.

5.5 Test Data

Remark: During testing above 1GHz the measuring instrument use RBW=1 MHz and VBW=3 MHz with Peak Detector for Peak Values, and use RBW=1 MHz and VBW=1 kHz with Peak Detector for Average Values.

Test data please refer the following pages.

EUT:	10.1 inch Quad core capacitive touch tablet	Model:	MGT101
Temperature:	25 °C	Relative Humidity:	55%
Test Voltage:	AC 120V/60Hz		
Ant. Pol.	Horizontal		
Test Mode:	BLE TX 2402 Mode		
Remark:	Only worse case is reported		

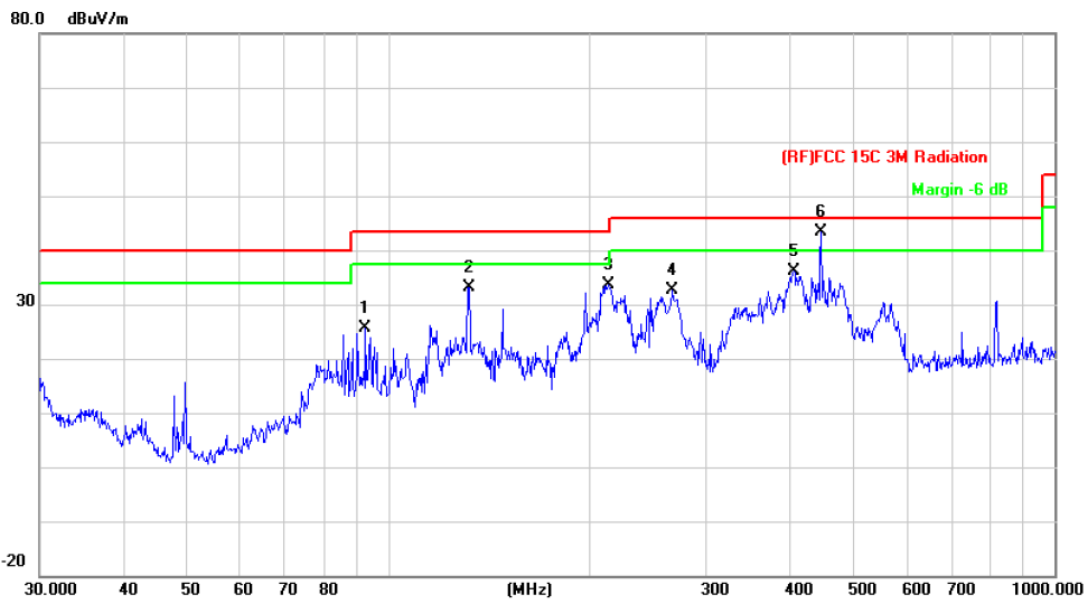

No.	Mk.	Freq.	Reading Level	Correct Factor	Measurement	Limit	Over	
		MHz	dBuV	dB/m	dBuV/m	dBuV/m	dB	Detector
1		92.4624	48.07	-22.48	25.59	43.50	-17.91	peak
2		132.2206	55.29	-22.13	33.16	43.50	-10.34	peak
3		214.5143	53.41	-19.76	33.65	43.50	-9.85	peak
4		266.6089	50.33	-17.76	32.57	46.00	-13.43	peak
5		406.0880	49.06	-12.83	36.23	46.00	-9.77	peak
6	*	446.4141	55.84	-12.53	43.31	46.00	-2.69	peak

*:Maximum data x:Over limit !:over margin

Emission Level= Read Level+ Correct Factor

EUT:	10.1 inch Quad core capacitive touch tablet	Model:	MGT101
Temperature:	25 °C	Relative Humidity:	55%
Test Voltage:	AC 120V/60Hz		
Ant. Pol.	Vertical		
Test Mode:	BLE TX 2402 Mode		
Remark:	Only worse case is reported		

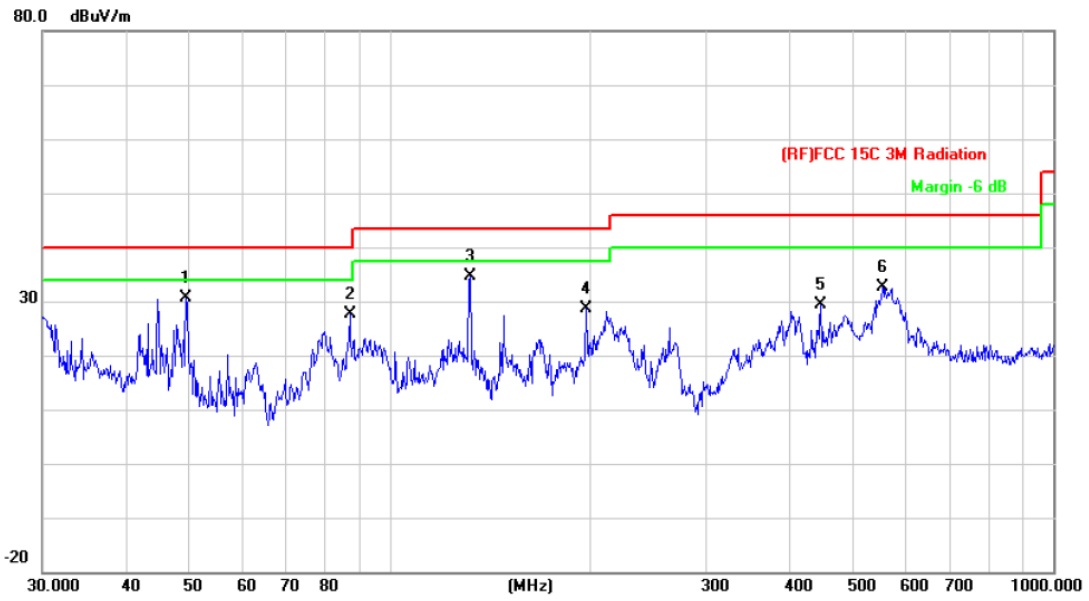

No.	Mk.	Freq.	Reading Level	Correct Factor	Measurement	Limit	Over	
		MHz	dBuV	dB/m	dBuV/m	dBuV/m	dB	Detector
1		49.3594	54.79	-24.12	30.67	40.00	-9.33	peak
2		87.1117	50.37	-22.86	27.51	40.00	-12.49	peak
3	*	132.2206	56.74	-22.13	34.61	43.50	-8.89	peak
4		197.8928	49.23	-20.49	28.74	43.50	-14.76	peak
5		446.4141	41.85	-12.53	29.32	46.00	-16.68	peak
6		552.8832	42.65	-10.13	32.52	46.00	-13.48	peak

*:Maximum data x:Over limit !:over margin

Emission Level= Read Level+ Correct Factor

EUT:	10.1 inch Quad core capacitive touch tablet	Model:	MGT101
Temperature:	25 °C	Relative Humidity:	55%
Test Voltage:	AC 120V/60Hz		
Ant. Pol.	Horizontal		
Test Mode:	BLE TX 2442 Mode		
Remark:	Only worse case is reported		

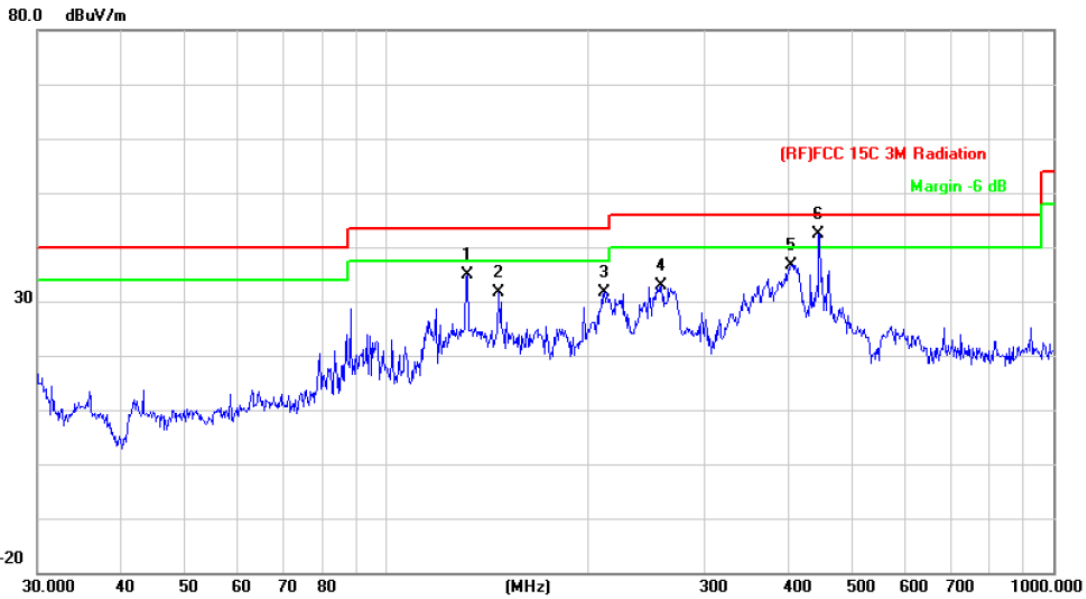

No.	Mk.	Freq.	Reading Level	Correct Factor	Measurement	Limit	Over	Detector
		MHz	dBuV	dB/m	dBuV/m	dBuV/m	dB	
1		132.2206	56.92	-22.13	34.79	43.50	-8.71	peak
2		147.4036	52.99	-21.38	31.61	43.50	-11.89	peak
3		212.2695	51.55	-19.86	31.69	43.50	-11.81	peak
4		258.3264	50.78	-17.94	32.84	46.00	-13.16	peak
5		404.6665	49.40	-12.83	36.57	46.00	-9.43	peak
6	*	444.8514	55.00	-12.55	42.45	46.00	-3.55	peak

*:Maximum data x:Over limit !:over margin

Emission Level= Read Level+ Correct Factor

EUT:	10.1 inch Quad core capacitive touch tablet	Model:	MGT101
Temperature:	25 °C	Relative Humidity:	55%
Test Voltage:	AC 120V/60Hz		
Ant. Pol.	Vertical		
Test Mode:	BLE TX 2442 Mode		
Remark:	Only worse case is reported		

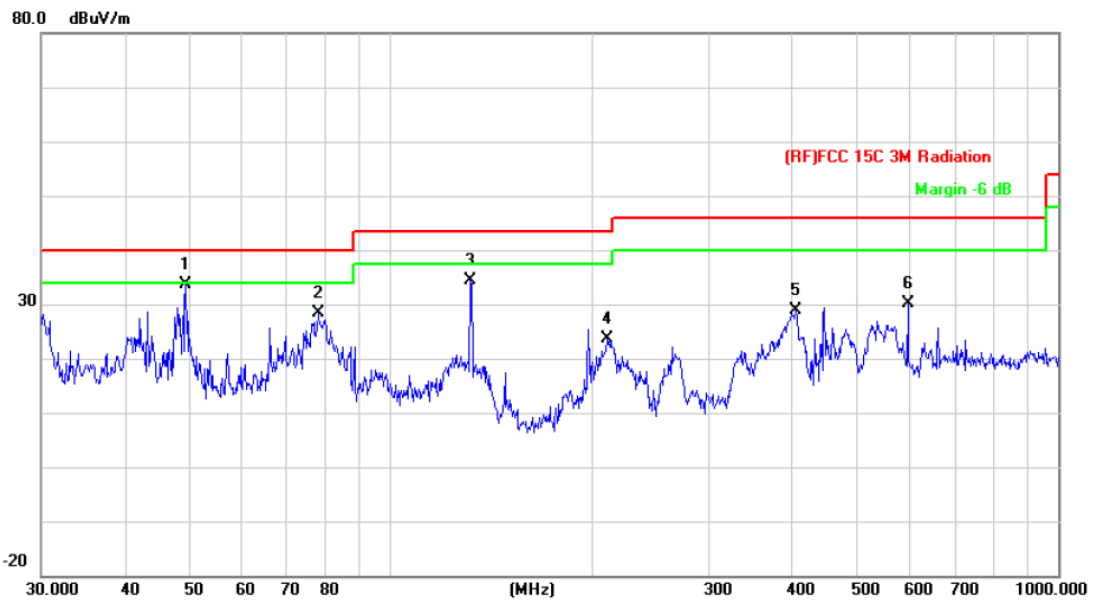

No.	Mk.	Freq. MHz	Reading Level dBuV	Correct Factor dB/m	Measure- ment dBuV/m	Limit dBuV/m	Over dB	Detector
1	*	49.3594	57.87	-24.12	33.75	40.00	-6.25	peak
2		77.8654	51.73	-23.35	28.38	40.00	-11.62	peak
3		131.7577	56.60	-22.14	34.46	43.50	-9.04	peak
4		210.7860	43.57	-19.92	23.65	43.50	-19.85	peak
5		404.6665	41.72	-12.83	28.89	46.00	-17.11	peak
6		595.1329	39.73	-9.59	30.14	46.00	-15.86	peak

*:Maximum data x:Over limit !:over margin

Emission Level= Read Level+ Correct Factor

EUT:	10.1 inch Quad core capacitive touch tablet	Model:	MGT101
Temperature:	25 °C	Relative Humidity:	55%
Test Voltage:	AC 120V/60Hz		
Ant. Pol.	Horizontal		
Test Mode:	BLE TX 2480 Mode		
Remark:	Only worse case is reported		

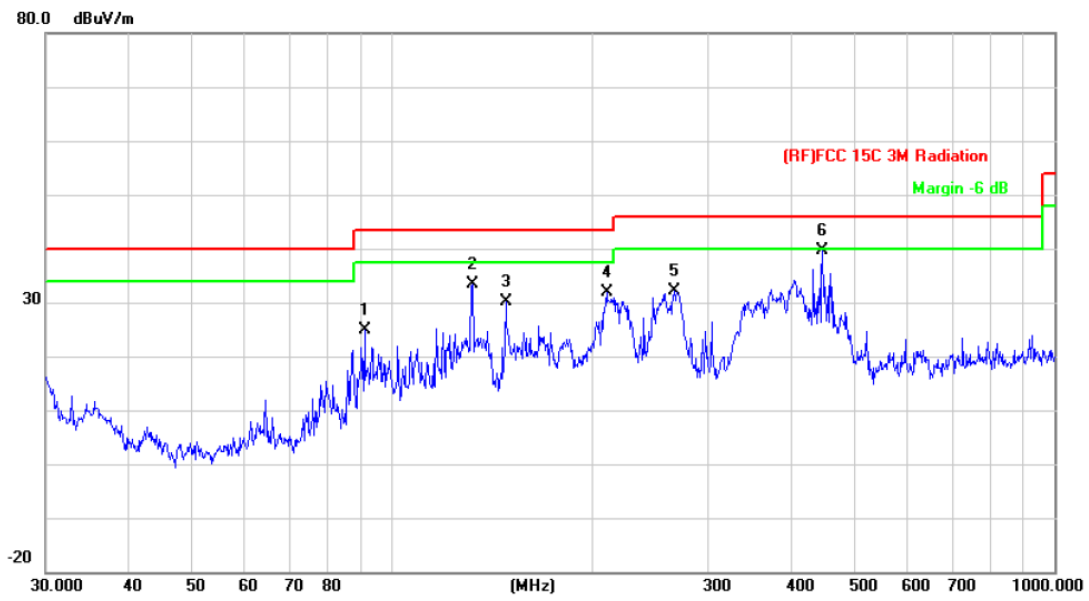

No.	Mk.	Freq. MHz	Reading Level dBuV	Correct Factor dB/m	Measure- ment dBuV/m	Limit dBuV/m	Over dB	Detector
1		90.8554	47.54	-22.61	24.93	43.50	-18.57	peak
2		132.2206	55.45	-22.13	33.32	43.50	-10.18	peak
3		148.4410	51.53	-21.30	30.23	43.50	-13.27	peak
4		210.7860	51.85	-19.92	31.93	43.50	-11.57	peak
5		266.6089	49.92	-17.76	32.16	46.00	-13.84	peak
6	*	446.4141	52.23	-12.53	39.70	46.00	-6.30	peak

*:Maximum data x:Over limit !:over margin

Emission Level= Read Level+ Correct Factor

EUT:	10.1 inch Quad core capacitive touch tablet	Model:	MGT101
Temperature:	25 °C	Relative Humidity:	55%
Test Voltage:	AC 120V/60Hz		
Ant. Pol.	Vertical		
Test Mode:	BLE TX 2480 Mode		
Remark:	Only worse case is reported		

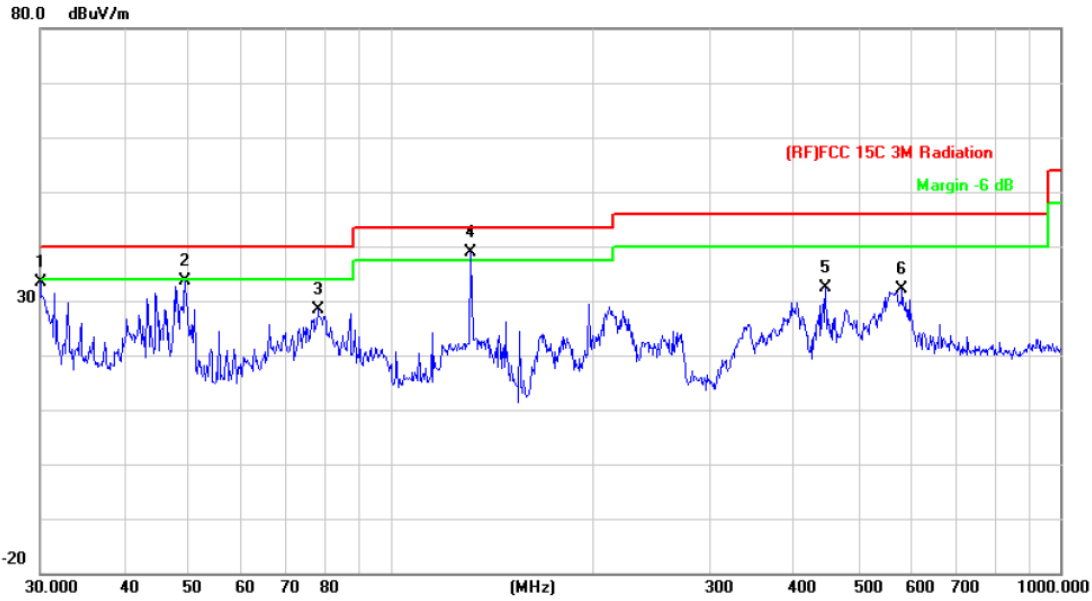

No.	Mk.	Freq. MHz	Reading Level dBuV	Correct Factor dB/m	Measure- ment dBuV/m	Limit dBuV/m	Over dB	Detector
1		30.0000	47.32	-13.96	33.36	40.00	-6.64	peak
2		49.3594	57.87	-24.12	33.75	40.00	-6.25	peak
3		77.8654	51.73	-23.35	28.38	40.00	-11.62	peak
4	*	131.7577	60.92	-22.14	38.78	43.50	-4.72	peak
5		446.4141	44.88	-12.53	32.35	46.00	-13.65	peak
6		580.7026	42.04	-9.98	32.06	46.00	-13.94	peak

*:Maximum data x:Over limit !:over margin

Emission Level= Read Level+ Correct Factor

EUT:	10.1 inch Quad core capacitive touch tablet	Model:	MGT101
Temperature:	25 °C	Relative Humidity:	55%
Test Voltage:	AC 120V/60Hz		
Ant. Pol.	Horizontal		
Test Mode:	BLE Mode TX 2402 MHz		
Remark:	No report for the emission which more than 10 dB below the prescribed limit.		

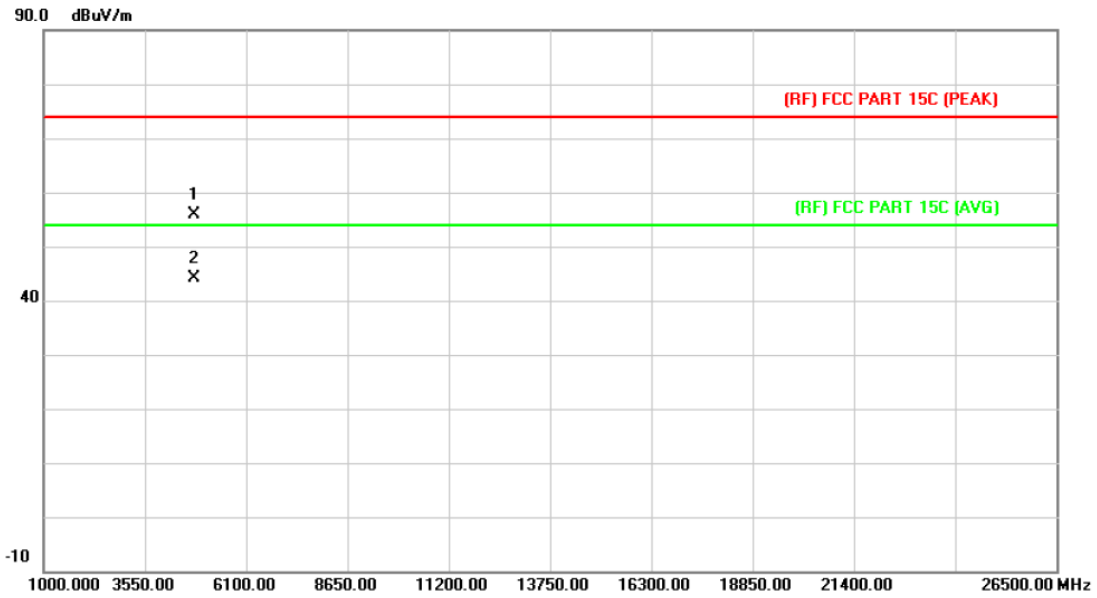

No.	Mk.	Freq.	Reading Level	Correct Factor	Measurement	Limit	Over	Detector
		MHz	dBuV	dB/m	dBuV/m	dBuV/m	dB	
1		4804.099	42.52	13.44	55.96	74.00	-18.04	peak
2	*	4804.357	30.62	13.44	44.06	54.00	-9.94	AVG

Emission Level= Read Level+ Correct Factor

EUT:	10.1 inch Quad core capacitive touch tablet	Model:	MGT101
Temperature:	25 °C	Relative Humidity:	55%
Test Voltage:	AC 120V/60Hz		
Ant. Pol.	Vertical		
Test Mode:	BLE Mode TX 2402 MHz		
Remark:	No report for the emission which more than 10 dB below the prescribed limit.		

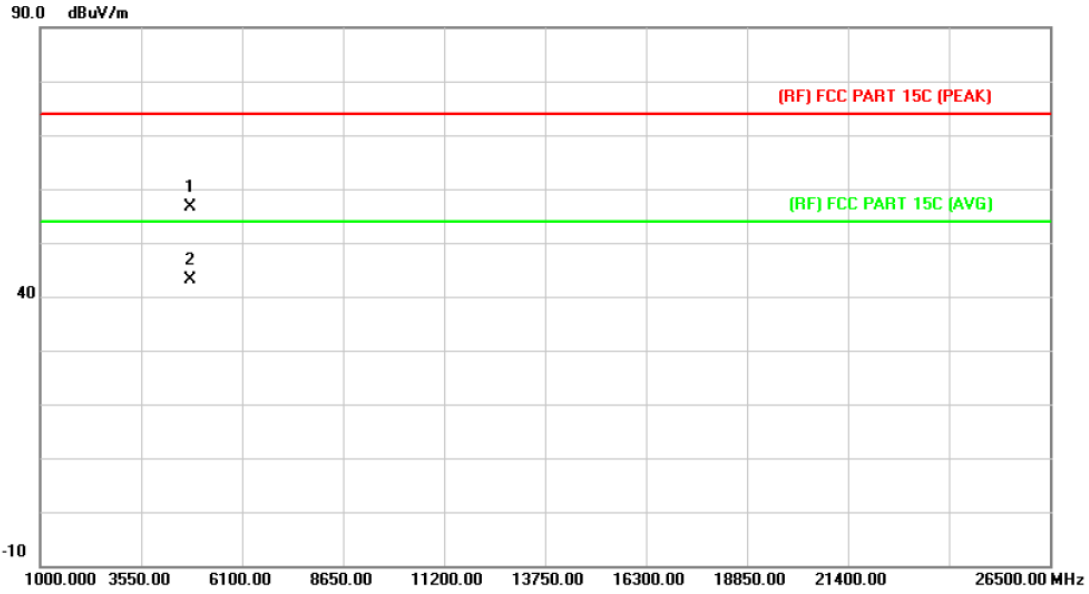

No.	Mk.	Freq.	Reading Level	Correct Factor	Measurement	Limit	Over	Detector
		MHz	dBuV	dB/m	dBuV/m	dBuV/m	dB	
1		4804.087	43.24	13.44	56.68	74.00	-17.32	peak
2	*	4804.393	29.61	13.44	43.05	54.00	-10.95	AVG

Emission Level= Read Level+ Correct Factor

EUT:	10.1 inch Quad core capacitive touch tablet	Model:	MGT101
Temperature:	25 °C	Relative Humidity:	55%
Test Voltage:	AC 120V/60Hz		
Ant. Pol.	Horizontal		
Test Mode:	BLE Mode TX 2442 MHz		
Remark:	No report for the emission which more than 10 dB below the prescribed limit.		

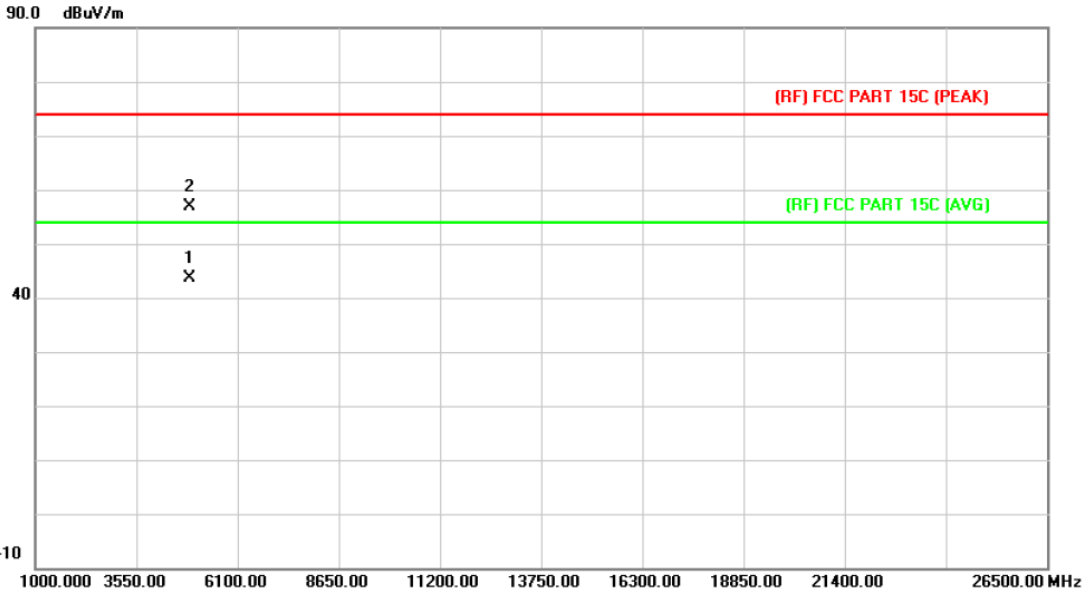

No.	Mk.	Freq.	Reading Level	Correct Factor	Measurement	Limit	Over	Detector
		MHz	dBuV	dB/m	dBuV/m	dBuV/m	dB	
1	*	4883.796	29.79	13.92	43.71	54.00	-10.29	AVG
2		4884.033	43.07	13.92	56.99	74.00	-17.01	peak

Emission Level= Read Level+ Correct Factor

EUT:	10.1 inch Quad core capacitive touch tablet	Model:	MGT101
Temperature:	25 °C	Relative Humidity:	55%
Test Voltage:	AC 120V/60Hz		
Ant. Pol.	Vertical		
Test Mode:	BLE Mode TX 2442 MHz		
Remark:	No report for the emission which more than 10 dB below the prescribed limit.		

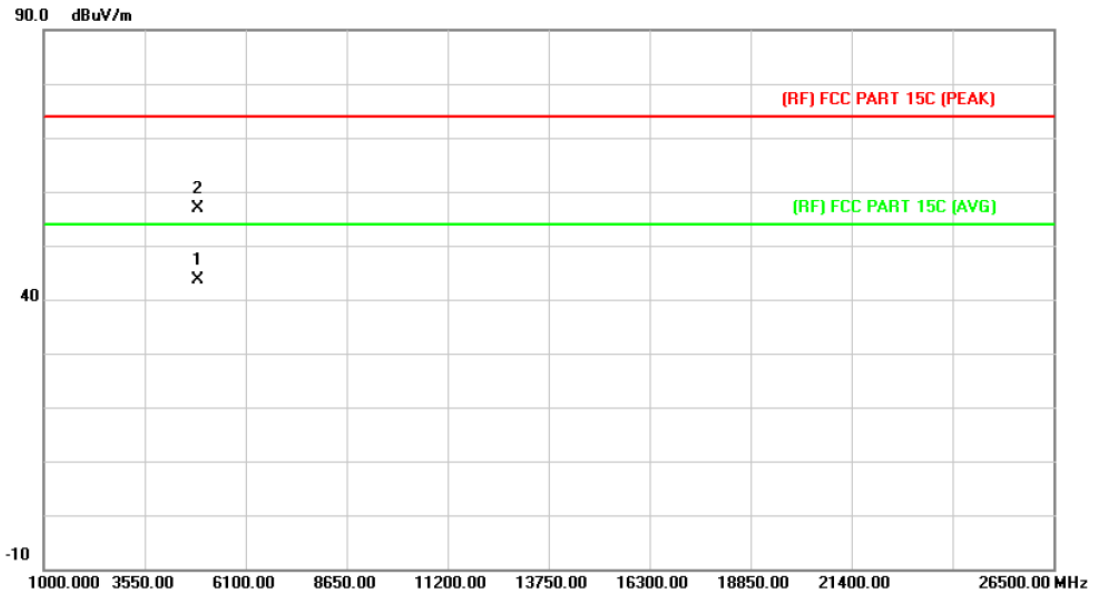

No.	Mk.	Freq.	Reading Level	Correct Factor	Measurement	Limit	Over	Detector
		MHz	dBuV	dB/m	dBuV/m	dBuV/m	dB	
1	*	4883.748	29.81	13.92	43.73	54.00	-10.27	AVG
2		4884.372	42.85	13.92	56.77	74.00	-17.23	peak

Emission Level= Read Level+ Correct Factor

EUT:	10.1 inch Quad core capacitive touch tablet	Model:	MGT101
Temperature:	25 °C	Relative Humidity:	55%
Test Voltage:	AC 120V/60Hz		
Ant. Pol.	Horizontal		
Test Mode:	BLE Mode TX 2480 MHz		
Remark:	No report for the emission which more than 10 dB below the prescribed limit.		

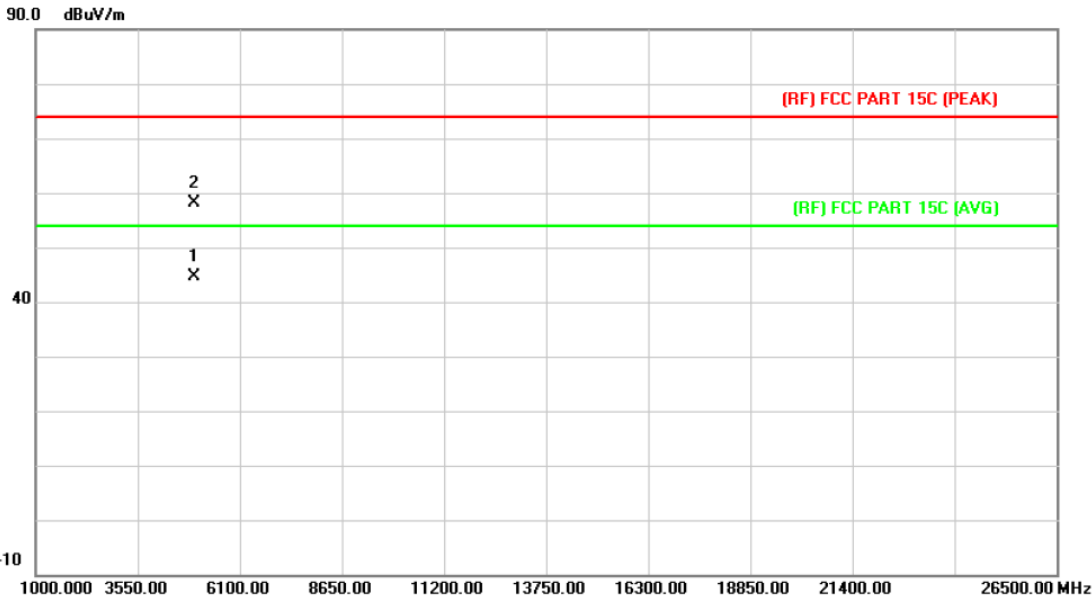

No.	Mk.	Freq.	Reading Level	Correct Factor	Measurement	Limit	Over	Detector
		MHz	dBuV	dB/m	dBuV/m	dBuV/m	dB	
1	*	4959.871	30.31	14.36	44.67	54.00	-9.33	AVG
2		4959.918	43.66	14.36	58.02	74.00	-15.98	peak

Emission Level= Read Level+ Correct Factor

EUT:	10.1 inch Quad core capacitive touch tablet	Model:	MGT101
Temperature:	25 °C	Relative Humidity:	55%
Test Voltage:	AC 120V/60Hz		
Ant. Pol.	Vertical		
Test Mode:	BLE Mode TX 2480 MHz		
Remark:	No report for the emission which more than 10 dB below the prescribed limit.		

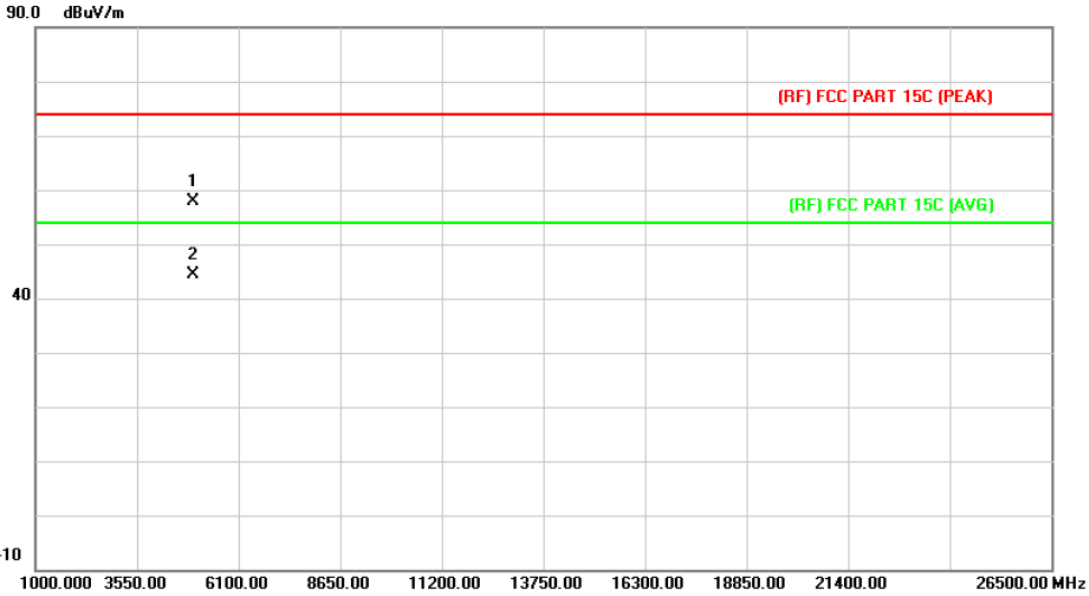

No.	Mk.	Freq.	Reading Level	Correct Factor	Measurement	Limit	Over	Detector
		MHz	dBuV	dB/m	dBuV/m	dBuV/m	dB	
1		4960.426	43.50	14.36	57.86	74.00	-16.14	peak
2	*	4960.475	30.09	14.36	44.45	54.00	-9.55	AVG

Emission Level= Read Level+ Correct Factor

6. Restricted Bands Requirement

6.1 Test Standard and Limit

6.1.1 Test Standard

FCC Part 15.209 FCC Part 15.205

6.1.2 Test Limit

Restricted Frequency Band (MHz)	Class B (dBuV/m)(at 3 M)	
	Peak	Average
2310 ~2390	74	54
2483.5 ~2500	74	54

6.2 Test Setup

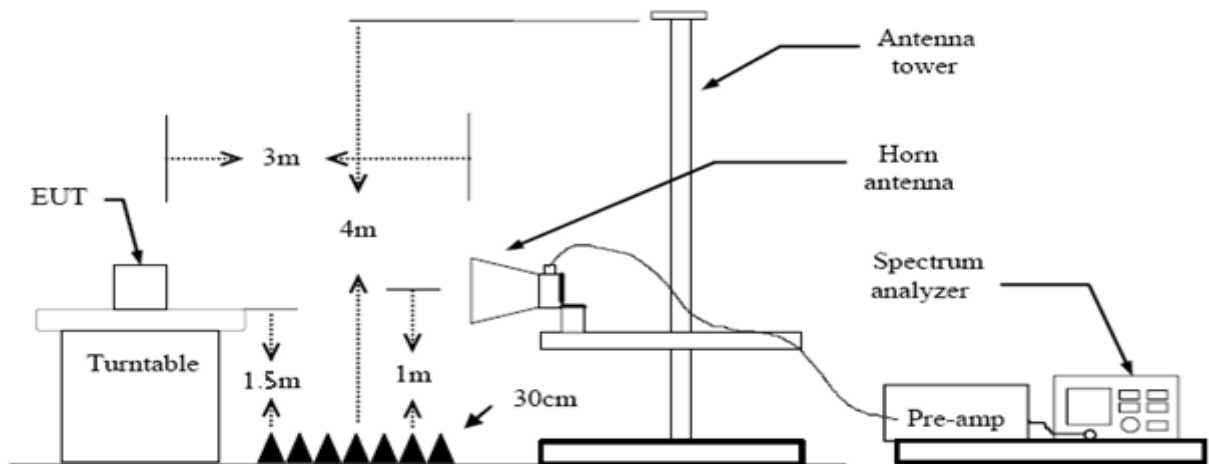

6.3 Test Procedure

- (1) The measuring distance of 3m shall be used for measurements at frequency up to 1GHz and above 1 GHz. The EUT was placed on a rotating 0.8m high above ground, the table was rotated 360 degrees to determine the position of the highest radiation.
- (2) Measurements at frequency above 1GHz. The EUT was placed on a rotating 1.5m high above the ground. RF absorbers covered the ground plane with a minimum area of 3.0m by 3.0m between the EUT and measurement receiver antenna. The RF absorber shall not exceed 30cm in high above the conducting floor. The table was rotated 360 degrees to determine the position of the highest radiation.
- (3) The Test antenna shall vary between 1m and 4m, Both Horizontal and Vertical antenna are set to make measurement.
- (4) The initial step in collecting conducted emission data is a spectrum analyzer peak detector mode pre-scanning the measurement frequency range. Significant peaks are then marked

and then Quasi Peak detector mode re-measured.

- (5) If the Peak Mode measured value compliance with and lower than Quasi Peak Mode Limit Bellow 1 GHz, the EUT shall be deemed to meet QP Limits and then no additional QP Mode measurement performed. But the Peak Value and average value both need to comply with applicable limit above 1 GHz.
- (6) Testing frequency range below 1GHz the measuring instrument use VBW=120 kHz with Quasi-peak detection.
- (7) Testing frequency range above 1GHz the measuring instrument use RBW=1 MHz and VBW=3 MHz with Peak Detector for Peak Values, and use RBW=1 MHz and VBW=10 KHz with Peak Detector for Average Values.
- (8) For the actual test configuration, please see the test setup photo.

6.4 EUT Operating Condition

The Equipment Under Test was set to Continual Transmitting in maximum power.

6.5 Test Data

Remark: During testing above 1GHz the measuring instrument use RBW=1 MHz and VBW=3 MHz with Peak Detector for Peak Values, and use RBW=1 MHz and VBW=1kHz with Peak Detector for Average Values.

Test data please refer the following pages.

(1) Radiation Test

EUT:	10.1 inch Quad core capacitive touch tablet	Model:	MGT101
Temperature:	25 °C	Relative Humidity:	55%
Test Voltage:	AC 120V/60Hz		
Ant. Pol.	Horizontal		
Test Mode:	BLE Mode TX 2402 MHz		
Remark:	N/A		

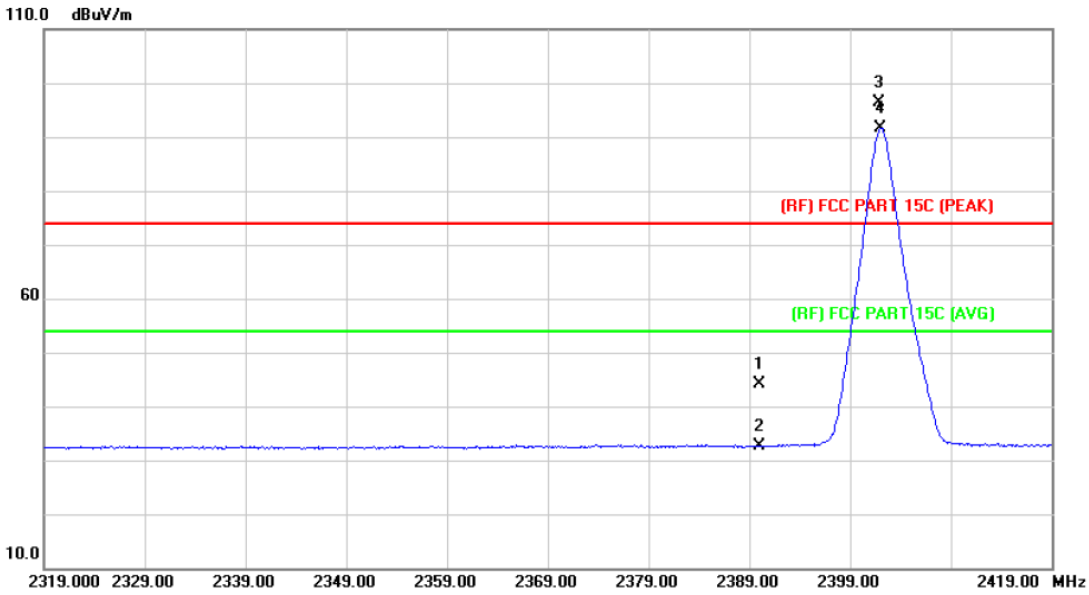

No.	Mk.	Freq. MHz	Reading Level dBuV	Correct Factor dB/m	Measure- ment dBuV/m	Limit dBuV/m	Over dB	Detector
1		2390.000	43.24	0.77	44.01	74.00	-29.99	peak
2		2390.000	31.86	0.77	32.63	54.00	-21.37	AVG
3	X	2401.800	95.59	0.82	96.41	Fundamental Frequency		peak
4	*	2402.000	90.81	0.82	91.63	Fundamental Frequency		AVG

Emission Level= Read Level+ Correct Factor

EUT:	10.1 inch Quad core capacitive touch tablet	Model:	MGT101
Temperature:	25 °C	Relative Humidity:	55%
Test Voltage:	AC 120V/60Hz		
Ant. Pol.	Vertical		
Test Mode:	BLE Mode TX 2402 MHz		
Remark:	N/A		

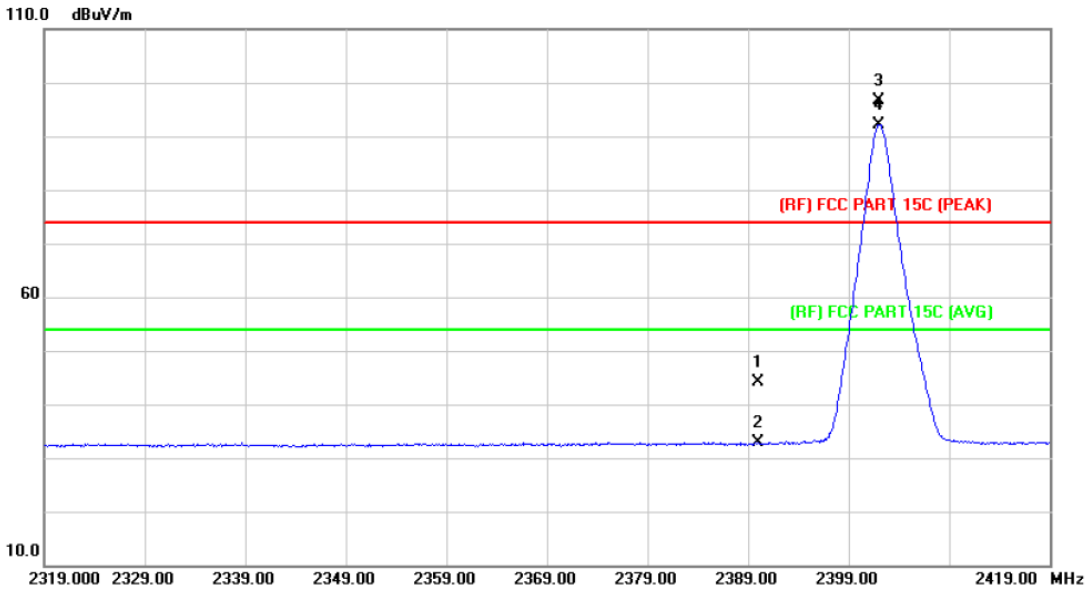

No.	Mk.	Freq.	Reading Level	Correct Factor	Measurement	Limit	Over	Detector
		MHz	dBuV	dB/m	dBuV/m	dBuV/m	dB	
1		2390.000	43.36	0.77	44.13	74.00	-29.87	peak
2		2390.000	32.02	0.77	32.79	54.00	-21.21	AVG
3	X	2402.000	95.92	0.82	96.74	Fundamental Frequency		peak
4	*	2402.000	91.38	0.82	92.20	Fundamental Frequency		AVG

Emission Level= Read Level+ Correct Factor

EUT:	10.1 inch Quad core capacitive touch tablet	Model:	MGT101
Temperature:	25 °C	Relative Humidity:	55%
Test Voltage:	AC 120V/60Hz		
Ant. Pol.	Horizontal		
Test Mode:	BLE Mode TX 2480 MHz		
Remark:	N/A		

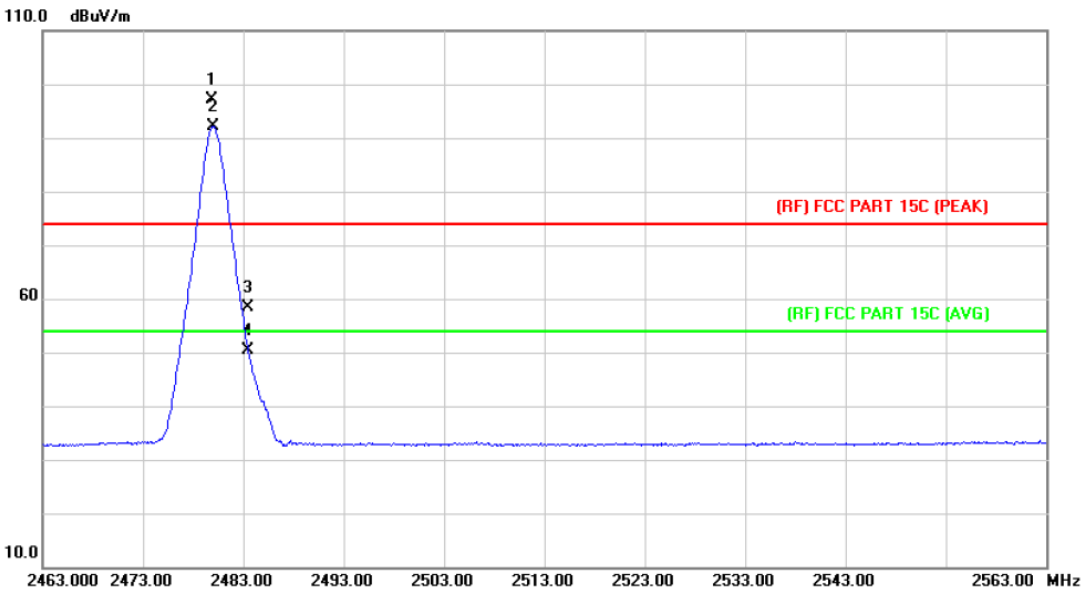

No.	Mk.	Freq.	Reading Level	Correct Factor	Measurement	Limit	Over	Detector
		MHz	dBuV	dB/m	dBuV/m	dBuV/m	dB	
1	X	2479.900	96.00	1.15	97.15	Fundamental Frequency		peak
2	*	2480.000	90.97	1.15	92.12	Fundamental Frequency		AVG
3		2483.500	57.29	1.17	58.46	74.00	-15.54	peak
4		2483.500	49.10	1.17	50.27	54.00	-3.73	AVG

Emission Level= Read Level+ Correct Factor

EUT:	10.1 inch Quad core capacitive touch tablet	Model:	MGT101
Temperature:	25 °C	Relative Humidity:	55%
Test Voltage:	AC 120V/60Hz		
Ant. Pol.	Vertical		
Test Mode:	BLE Mode TX 2480 MHz		
Remark:	N/A		

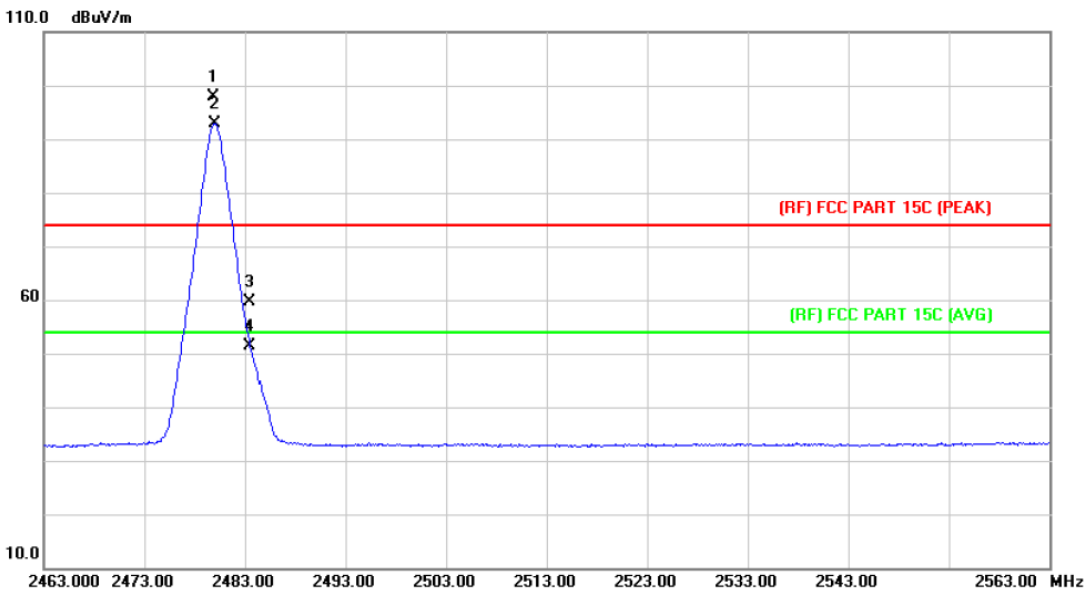

No.	Mk.	Freq. MHz	Reading Level dBuV	Correct Factor dB/m	Measure- ment dBuV/m	Limit dBuV/m	Over dB	Detector
1	X	2479.900	96.85	1.15	98.00	Fundamental Frequency		peak
2	*	2480.000	91.72	1.15	92.87	Fundamental Frequency		AVG
3		2483.500	58.51	1.17	59.68	74.00	-14.32	peak
4		2483.500	50.25	1.17	51.42	54.00	-2.58	AVG

Emission Level= Read Level+ Correct Factor

(2) Conducted Test

EUT:	10.1 inch Quad core capacitive touch tablet	Model:	MGT101
Temperature:	25 °C	Relative Humidity:	55%
Test Voltage:	AC 120V/60Hz		
Test Mode:	BLE Mode TX 2402MHz / BLE Mode TX 2480MHz		
Remark:	The EUT is programed in continuously transmitting mode		

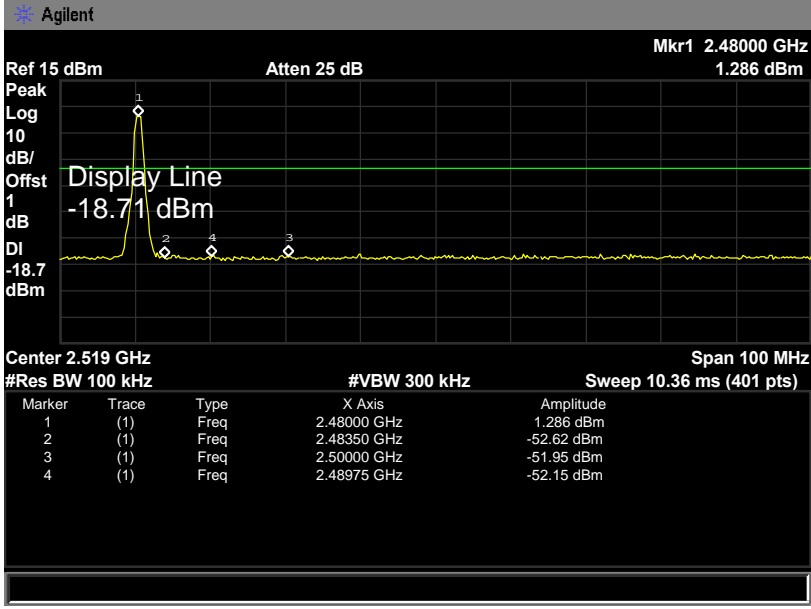
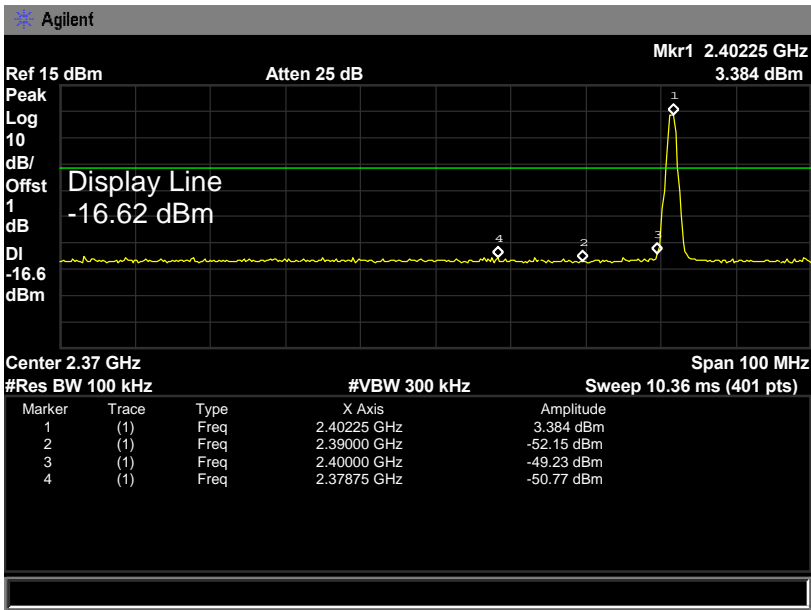

7. Bandwidth Test

7.1 Test Standard and Limit

- 7.1.1 Test Standard
FCC Part 15.247 (a)(2)
- 7.1.2 Test Limit

FCC Part 15 Subpart C(15.247)/RSS-247		
Test Item	Limit	Frequency Range(MHz)
Bandwidth	≥ 500 KHz (6dB bandwidth)	2400~2483.5

7.2 Test Setup

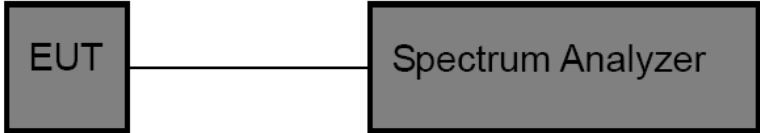

7.3 Test Procedure

- (1) The EUT was directly connected to the spectrum analyzer and antenna output port as show in the block diagram above.
- (2) The bandwidth is measured at an amplitude level reduced 6dB from the reference level. The reference level is the level of the highest amplitude signal observed from the transmitter at the fundamental frequency. Once the reference level is established, the equipment is conditioned with typical modulating signal to produce the worst -case (i.e the widest) bandwidth.
- (3) Measure the channel separation the spectrum analyzer was set to Resolution Bandwidth:100 kHz, and Video Bandwidth:300 kHz, Detector: Peak, Sweep Time set auto.

7.4 EUT Operating Condition

The EUT was set to continuously transmitting in each mode and low, middle and high channel for the test.

7.5 Test Data

EUT:	10.1 inch Quad core capacitive touch tablet	Model:	MGT101
Temperature:	25 °C	Relative Humidity:	55%
Test Voltage:	AC 120V/60Hz		
Test Mode:	BLE TX Mode		
Channel frequency (MHz)	6dB Bandwidth (kHz)	99% Bandwidth (kHz)	Limit (kHz)
2402	751.617	1098.50	≥500
2442	747.513	1096.80	
2480	739.133	1099.20	
BLE Mode			
2402 MHz			

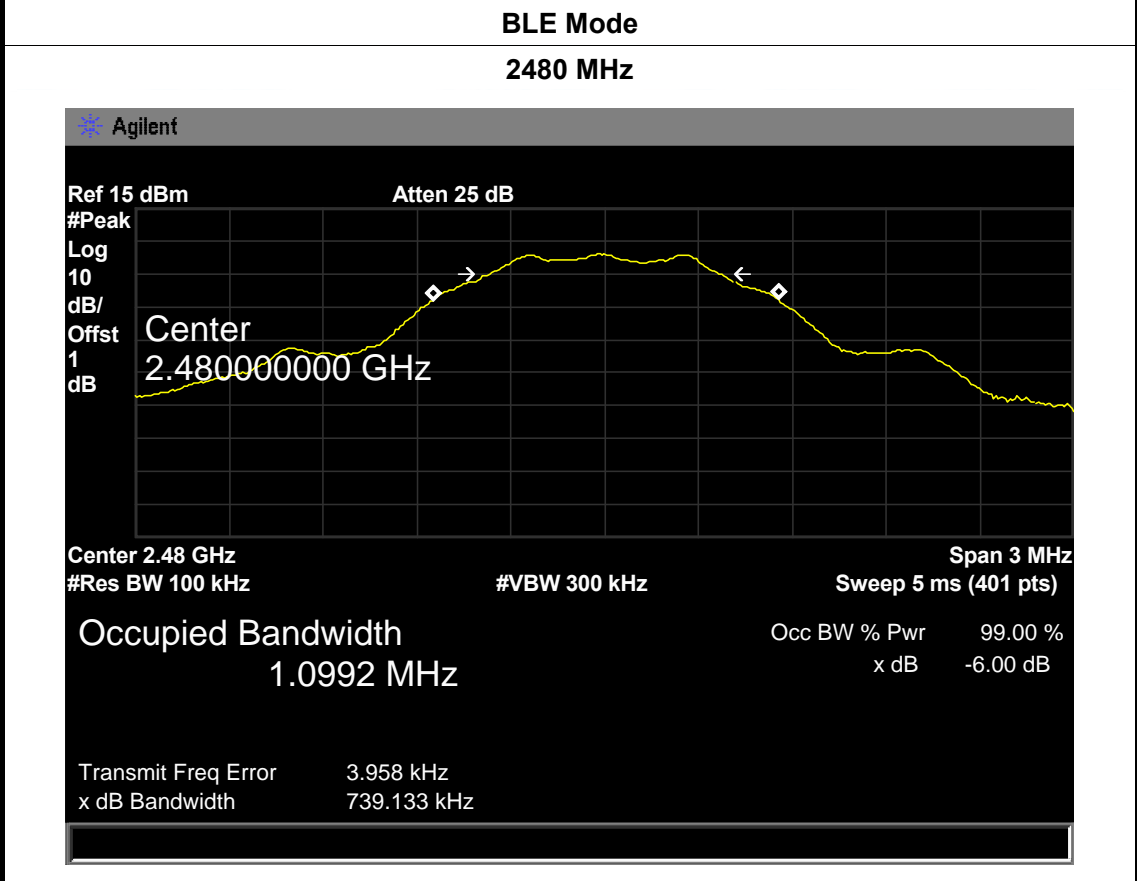
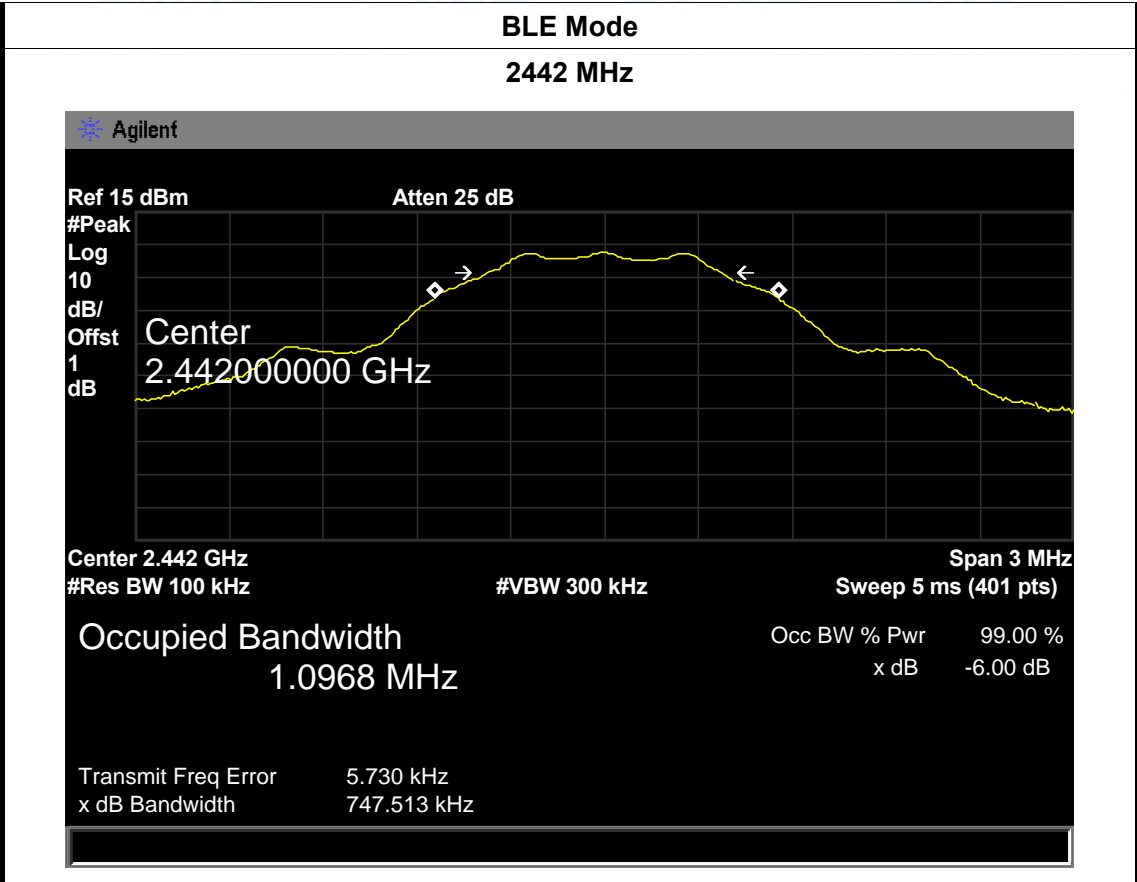

8. Peak Output Power Test

8.1 Test Standard and Limit

8.1.1 Test Standard
FCC Part 15.247 (b)

8.1.2 Test Limit

FCC Part 15 Subpart C(15.247)/RSS-247		
Test Item	Limit	Frequency Range(MHz)
Peak Output Power	1 Watt or 30 dBm	2400~2483.5

8.2 Test Setup

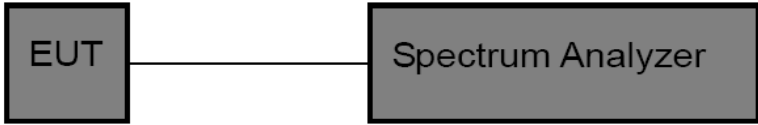

8.3 Test Procedure

The EUT was directly connected to the Spectrum Analyzer and antenna output port as show in the block diagram above. The measurement is according to section 9.1.1 of KDB 558074 D01 DTS Meas Guidance v03r03.

- (1) Set the $RBW \geq DTS$ Bandwidth
- (2) Set $VBW \geq 3 * RBW$
- (3) Set $Span \geq 3 * RBW$
- (4) Sweep time=auto
- (5) Detector= peak
- (6) Trace mode= maxhold.
- (7) Allow trace to fully stabilize, and then use peak marker function to determine the peak amplitude level.

8.4 EUT Operating Condition

The EUT was set to continuously transmitting in the max power during the test.

8.5 Test Data

EUT:	10.1 inch Quad core capacitive touch tablet	Model:	MGT101
Temperature:	25 °C	Relative Humidity:	55%
Test Voltage:	AC 120V/60Hz		
Test Mode:	BLE TX Mode		
Channel frequency (MHz)	Test Result (dBm)	Limit (dBm)	
2402	2.013	30	
2442	3.351		
2480	3.803		
BLE Mode			
2402 MHz			

The screenshot displays a spectrum analyzer interface with the following details:

- Brand:** Agilent
- Reference Level:** Ref 15 dBm
- Attenuation:** Atten 25 dB
- Marker 1:** Mkr1 2.4800300 GHz, 2.013 dBm
- Y-axis:** Peak Log 10 dB/Offst 1 dB
- Marker Info:** Marker 2.480030000 GHz, 2.013 dBm
- Resolution Bandwidth:** #Res BW 1 MHz
- Video Bandwidth:** #VBW 3 MHz
- Center Frequency:** Center 2.48 GHz
- Span:** Span 3 MHz
- Sweep Time:** Sweep 5 ms (401 pts)

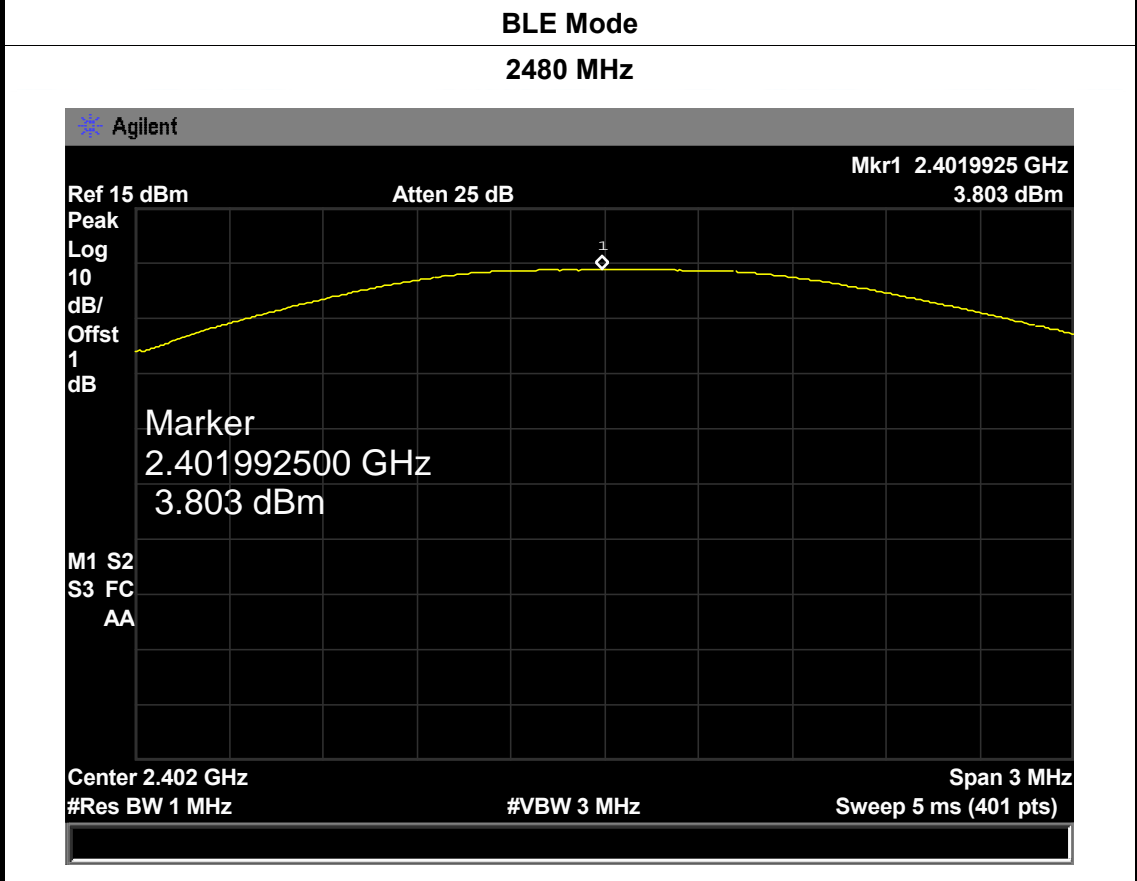
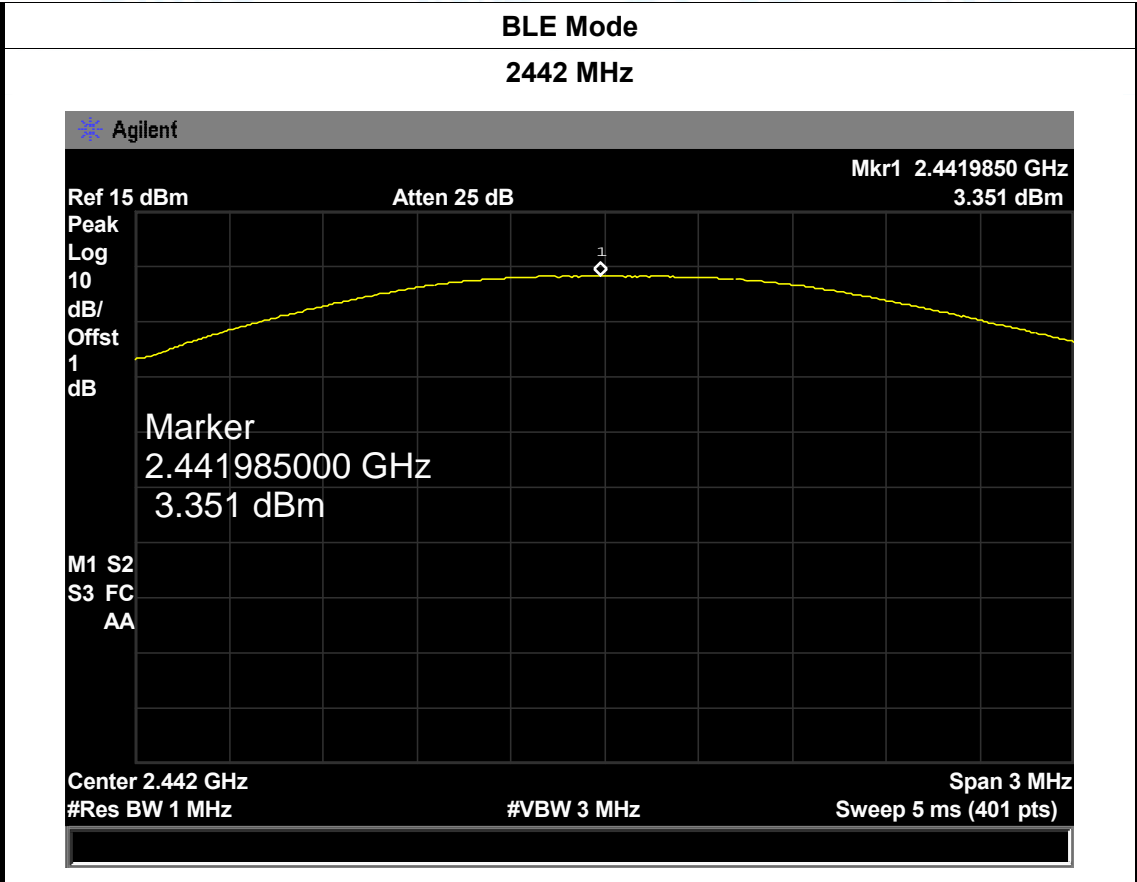

9. Power Spectral Density Test

9.1 Test Standard and Limit

9.1.1 Test Standard

FCC Part 15.247 (e)

9.1.2 Test Limit

FCC Part 15 Subpart C(15.247)		
Test Item	Limit	Frequency Range(MHz)
Power Spectral Density	8dBm(in any 3 kHz)	2400~2483.5

9.2 Test Setup

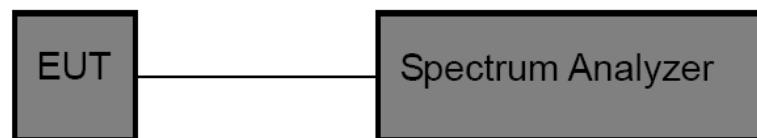

9.3 Test Procedure

The EUT was directly connected to the Spectrum Analyzer and antenna output port as show in the block diagram above. The measurement according to section 10.2 of KDB 558074 D01 DTS Meas Guidance v03r03.

- (1) The EUT was directly connected to the spectrum analyzer and antenna output port as show in the block diagram above.
- (2) Set analyser center frequency to DTS channel center frequencyc.
- (3) Set the span to 1.5 times the DTS bandwidth.
- (4) Set the RBW to: 3 kHz
- (5) Set the VBW to: 10 kHz
- (6) Detector: peak
- (7) Sweep time: auto
- (8) Allow trace to fully stabilize. Then use the peak marker function to determine the maximum amplitude level.

9.4 EUT Operating Condition

The EUT was set to continuously transmitting in each mode and low, Midle and high channel for the test.

8.5 Test Data

EUT:	10.1 inch Quad core capacitive touch tablet	Model:	MGT101
Temperature:	25 °C	Relative Humidity:	55%
Test Voltage:	AC 120V/60Hz		
Test Mode:	BLE TX Mode		
Channel Frequency (MHz)	Power Density (3 kHz/dBm)	Limit (dBm)	
2402	-9.957	8	
2442	-10.48		
2480	-11.95		

BLE Mode
2402 MHz

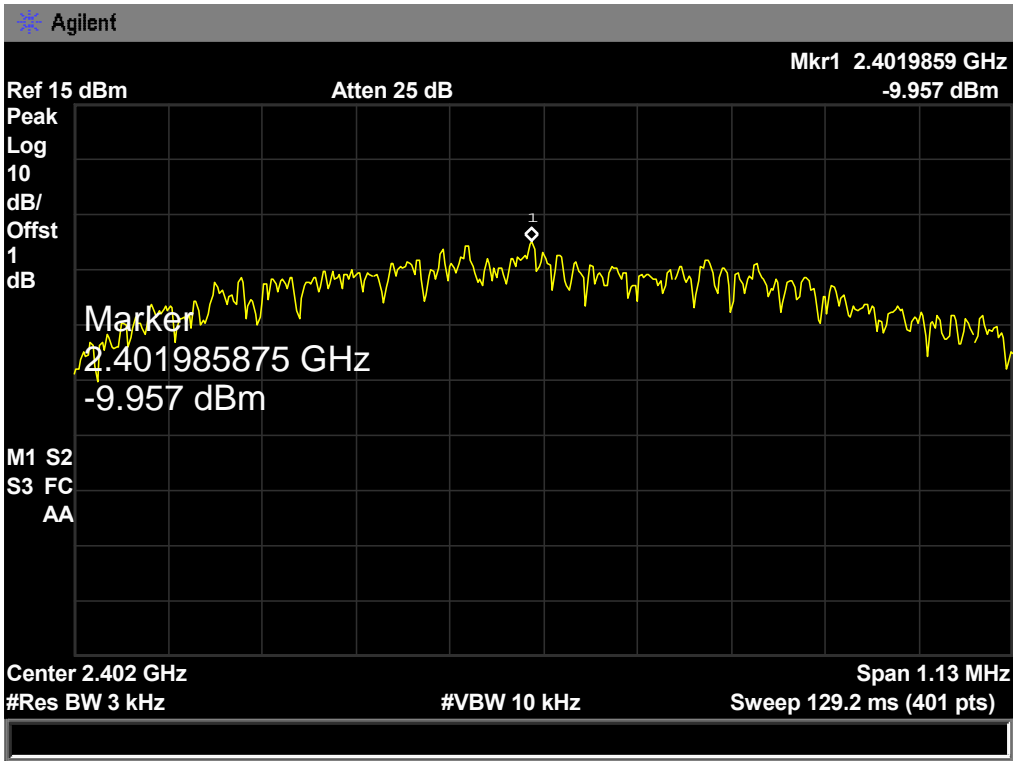

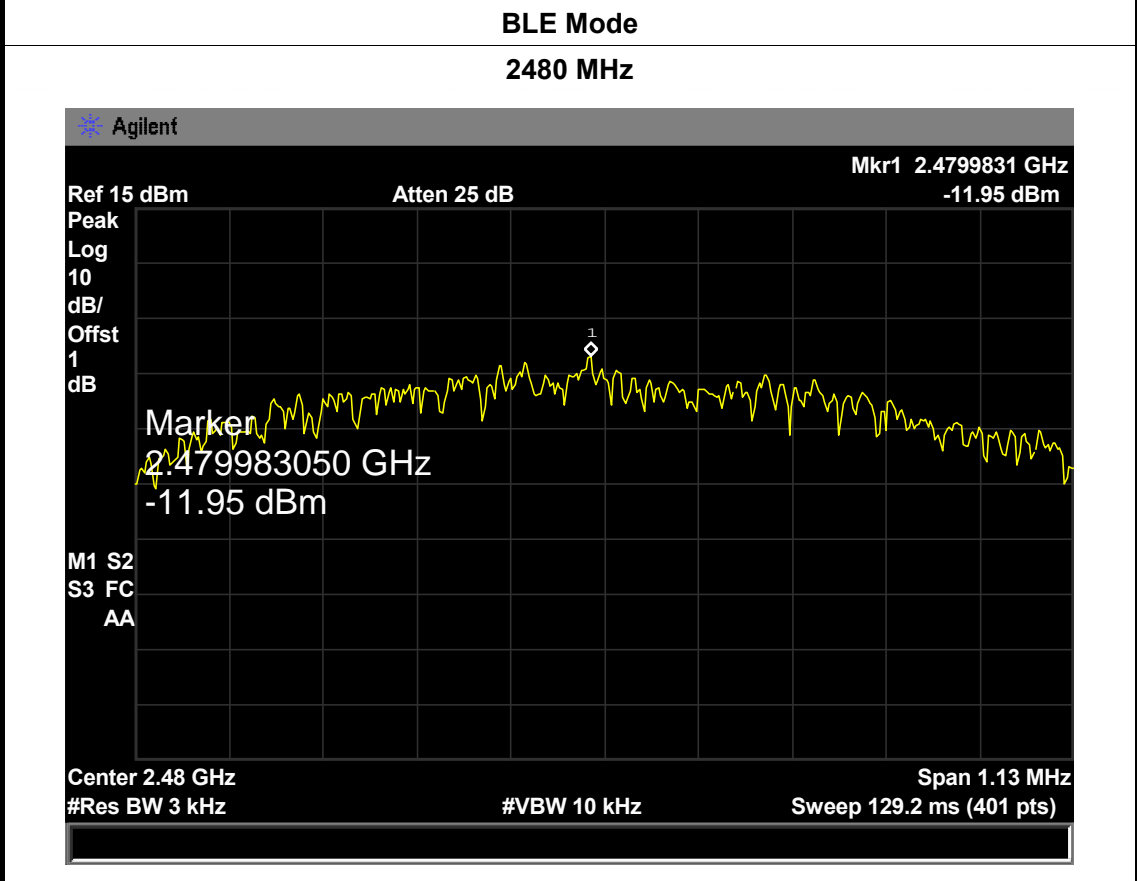
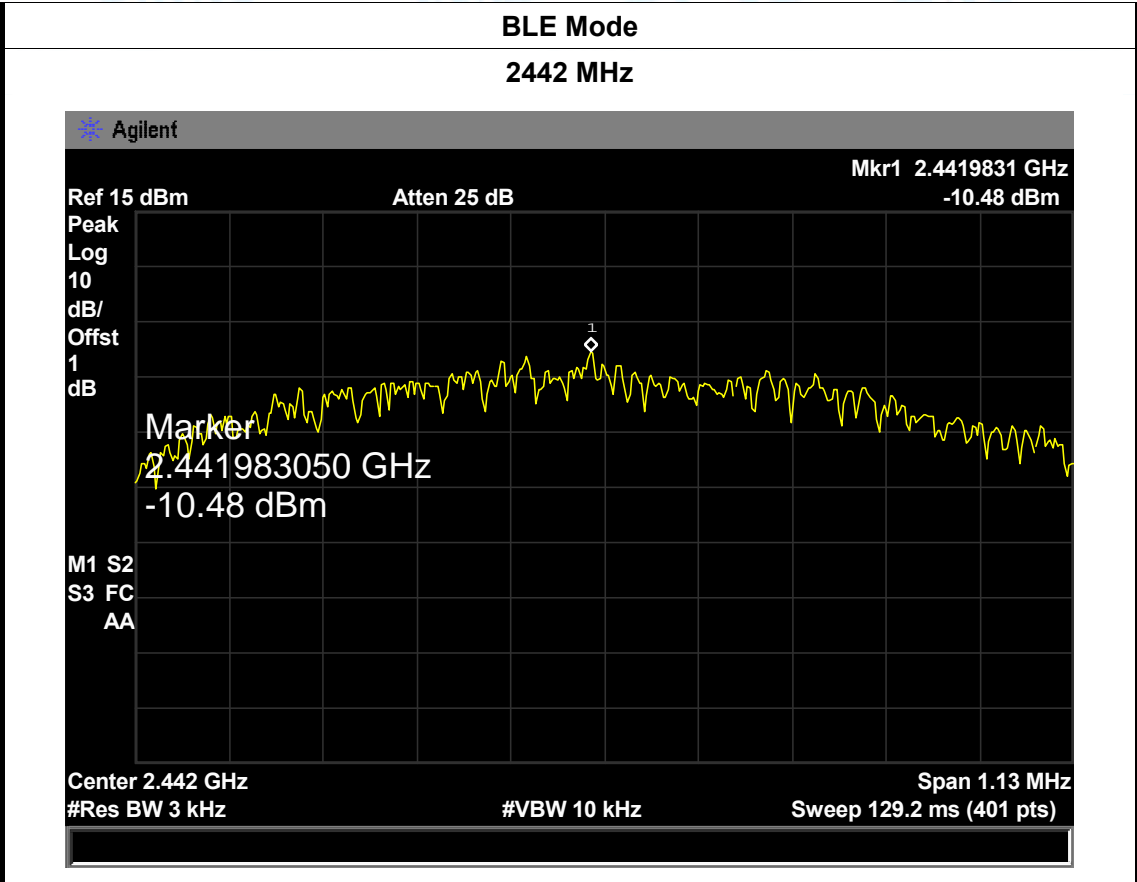

10. Antenna Requirement

10.1 Standard Requirement

10.1.1 Standard

FCC Part 15.203

10.1.2 Requirement

An intentional radiator shall be designed to ensure that no antenna other than that furnished by the responsible party shall be used with the device. The use of a permanently attached antenna or of an antenna that uses a unique coupling to the intentional radiator shall be considered sufficient to comply with the provisions of this Section. The manufacturer may design the unit so that a broken antenna can be replaced by the user, but the use of a standard antenna jack or electrical connector is prohibited.

10.2 Antenna Connected Construction

The directional gains of the antenna used for transmitting is 0.75 dBi, and the antenna de-signed with permanent attachment and no consideration of replacement. Please see the EUT photo for details.

10.3 Result

The EUT antenna is a FPC Antenna. It complies with the standard requirement.

Antenna Type
<input checked="" type="checkbox"/> Permanent attached antenna
<input type="checkbox"/> Unique connector antenna
<input type="checkbox"/> Professional installation antenna