

TEST REPORT

Applicant: SHENZHEN COMISO DIGITAL TECHNOLOGY LIMITED

Address of Applicant: 12/F,XinLong Technology Park,SongGang Town, BaoAn District, ShenZhen City, China

Manufacturer/Factory: SHENZHEN COMISO DIGITAL TECHNOLOGY LIMITED

Address of Manufacturer/Factory: 12/F,XinLong Technology Park,SongGang Town, BaoAn District, ShenZhen City, China

Equipment Under Test (EUT)

Product Name: Bluetooth speakers

Model No.: X26, X16, X6, M20S, M229

Trade Mark: COMISO

FCC ID: 2AEZG-X260

Applicable standards: FCC CFR Title 47 Part 15 Subpart C Section 15.247

Date of sample receipt: February 24, 2022

Date of Test: February 25-28, 2022

Date of report issued: March 01, 2022

Test Result : PASS *

* In the configuration tested, the EUT complied with the standards specified above.

Authorized Signature:



Robinson Luo
Laboratory Manager

This results shown in this test report refer only to the sample(s) tested, this test report cannot be reproduced, except in full, without prior written permission of the company. The report would be invalid without specific stamp of test institute and the signatures of compiler and approver.

2 Version

| Version No. | Date | Description |
|-------------|----------------|-------------|
| 00 | March 01, 2022 | Original |
| | | |
| | | |
| | | |
| | | |

Prepared By:

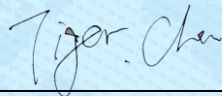

Date:

March 01, 2022

Project Engineer

Check By:



Reviewer

Date:

March 01, 2022

3 Contents

| | Page |
|--|------|
| 1 COVER PAGE..... | 1 |
| 2 VERSION..... | 2 |
| 3 CONTENTS | 3 |
| 4 TEST SUMMARY | 4 |
| 5 GENERAL INFORMATION..... | 5 |
| 5.1 GENERAL DESCRIPTION OF EUT | 5 |
| 5.2 TEST MODE | 7 |
| 5.3 DESCRIPTION OF SUPPORT UNITS | 7 |
| 5.4 DEVIATION FROM STANDARDS..... | 7 |
| 5.5 ABNORMALITIES FROM STANDARD CONDITIONS..... | 7 |
| 5.6 TEST FACILITY..... | 7 |
| 5.7 TEST LOCATION | 7 |
| 5.8 ADDITIONAL INSTRUCTIONS..... | 7 |
| 6 TEST INSTRUMENTS LIST | 8 |
| 7 TEST RESULTS AND MEASUREMENT DATA..... | 10 |
| 7.1 ANTENNA REQUIREMENT | 10 |
| 7.2 CONDUCTED EMISSIONS | 11 |
| 7.3 CONDUCTED PEAK OUTPUT POWER | 14 |
| 7.4 20dB EMISSION BANDWIDTH | 15 |
| 7.5 CARRIER FREQUENCIES SEPARATION..... | 16 |
| 7.6 HOPPING CHANNEL NUMBER | 17 |
| 7.7 DWELL TIME..... | 18 |
| 7.8 SPURIOUS EMISSION IN NON-RESTRICTED & RESTRICTED BANDS | 19 |
| 7.8.1 Conducted Emission Method..... | 19 |
| 7.8.2 Radiated Emission Method..... | 20 |
| 8 TEST SETUP PHOTO..... | 30 |
| 9 EUT CONSTRUCTIONAL DETAILS | 30 |

4 Test Summary

| Test Item | Section in CFR 47 | Result |
|----------------------------------|--------------------|--------|
| Antenna Requirement | 15.203/15.247 (c) | Pass |
| AC Power Line Conducted Emission | 15.207 | Pass |
| Conducted Peak Output Power | 15.247 (b)(1) | Pass |
| 20dB Occupied Bandwidth | 15.247 (a)(1) | Pass |
| Carrier Frequencies Separation | 15.247 (a)(1) | Pass |
| Hopping Channel Number | 15.247 (a)(1)(iii) | Pass |
| Dwell Time | 15.247 (a)(1)(iii) | Pass |
| Radiated Emission | 15.205/15.209 | Pass |
| Band Edge | 15.247(d) | Pass |

Remarks:

1. Pass: The EUT complies with the essential requirements in the standard.
2. Test according to ANSI C63.10:2013

Measurement Uncertainty

| Test Item | Frequency Range | Measurement Uncertainty | Notes |
|----------------------------------|-----------------|-------------------------|-------|
| Radiated Emission | 9kHz-30MHz | 3.1dB | (1) |
| Radiated Emission | 30MHz-200MHz | 3.8039dB | (1) |
| Radiated Emission | 200MHz-1GHz | 3.9679dB | (1) |
| Radiated Emission | 1GHz-18GHz | 4.29dB | (1) |
| Radiated Emission | 18GHz-40GHz | 3.30dB | (1) |
| AC Power Line Conducted Emission | 0.15MHz ~ 30MHz | 3.44dB | (1) |

Note (1): The measurement uncertainty is for coverage factor of k=2 and a level of confidence of 95%.

5 General Information

5.1 General Description of EUT

| | |
|--|--|
| Product Name: | Bluetooth speakers |
| Model No.: | X26, X16, X6, M20S, M229 |
| Test Model No.: | X26 |
| Remark: All above models are identical in the same PCB layout, interior structure and electrical circuits. The only difference is model name for commercial purpose. | |
| Test sample(s) ID: | GTS202202000101-1 |
| Sample(s) Status: | Engineer sample |
| S/N: | N/A |
| Hardware Version: | ATS2819VER |
| Software Version: | BT5.0-KSD9-comiso-X26_2020.9.28.fw |
| Operation Frequency: | 2402MHz~2480MHz |
| Channel numbers: | 79 |
| Channel separation: | 1MHz |
| Modulation type: | GFSK, $\pi/4$ -DQPSK, 8-DPSK |
| Antenna Type: | PCB Antenna |
| Antenna gain: | -0.58 dBi |
| Power supply: | DC 5V USB Charger Or DC 3.7V 2000 mAh 7.4 Wh Battery |

| Operation Frequency each of channel | | | | | | | |
|-------------------------------------|-----------|---------|-----------|---------|-----------|---------|-----------|
| Channel | Frequency | Channel | Frequency | Channel | Frequency | Channel | Frequency |
| 1 | 2402MHz | 21 | 2422MHz | 41 | 2442MHz | 61 | 2462MHz |
| 2 | 2403MHz | 22 | 2423MHz | 42 | 2443MHz | 62 | 2463MHz |
| 3 | 2404MHz | 23 | 2424MHz | 43 | 2444MHz | 63 | 2464MHz |
| 4 | 2405MHz | 24 | 2425MHz | 44 | 2445MHz | 64 | 2465MHz |
| 5 | 2406MHz | 25 | 2426MHz | 45 | 2446MHz | 65 | 2466MHz |
| 6 | 2407MHz | 26 | 2427MHz | 46 | 2447MHz | 66 | 2467MHz |
| 7 | 2408MHz | 27 | 2428MHz | 47 | 2448MHz | 67 | 2468MHz |
| 8 | 2409MHz | 28 | 2429MHz | 48 | 2449MHz | 68 | 2469MHz |
| 9 | 2410MHz | 29 | 2430MHz | 49 | 2450MHz | 69 | 2470MHz |
| 10 | 2411MHz | 30 | 2431MHz | 50 | 2451MHz | 70 | 2471MHz |
| 11 | 2412MHz | 31 | 2432MHz | 51 | 2452MHz | 71 | 2472MHz |
| 12 | 2413MHz | 32 | 2433MHz | 52 | 2453MHz | 72 | 2473MHz |
| 13 | 2414MHz | 33 | 2434MHz | 53 | 2454MHz | 73 | 2474MHz |
| 14 | 2415MHz | 34 | 2435MHz | 54 | 2455MHz | 74 | 2475MHz |
| 15 | 2416MHz | 35 | 2436MHz | 55 | 2456MHz | 75 | 2476MHz |
| 16 | 2417MHz | 36 | 2437MHz | 56 | 2457MHz | 76 | 2477MHz |
| 17 | 2418MHz | 37 | 2438MHz | 57 | 2458MHz | 77 | 2478MHz |
| 18 | 2419MHz | 38 | 2439MHz | 58 | 2459MHz | 78 | 2479MHz |
| 19 | 2420MHz | 39 | 2440MHz | 59 | 2460MHz | 79 | 2480MHz |
| 20 | 2421MHz | 40 | 2441MHz | 60 | 2461MHz | | |

Note:

In section 15.31(m), regards to the operating frequency range over 10 MHz, the Lowest frequency, the middle frequency, and the highest frequency of channel were selected to perform the test, and the selected channel see below:

| Channel | Frequency |
|---------------------|-----------|
| The lowest channel | 2402MHz |
| The middle channel | 2441MHz |
| The Highest channel | 2480MHz |

5.2 Test mode

| | |
|-------------------|---|
| Transmitting mode | Keep the EUT in continuously transmitting mode. |
|-------------------|---|

5.3 Description of Support Units

| Manufacturer | Description | Model | Serial Number |
|--------------|-------------|-------|---------------|
| APPLE | USB Charger | A1399 | N/A |

5.4 Deviation from Standards

| |
|-------|
| None. |
|-------|

5.5 Abnormalities from Standard Conditions

| |
|-------|
| None. |
|-------|

5.6 Test Facility

| |
|--|
| <p>The test facility is recognized, certified, or accredited by the following organizations:</p> <ul style="list-style-type: none"> • FCC —Registration No.: 381383 Designation Number: CN5029 Global United Technology Services Co., Ltd., Shenzhen EMC Laboratory has been registered and fully described in a report filed with the (FCC) Federal Communications Commission. The acceptance letter from the FCC is maintained in files. • IC —Registration No.: 9079A CAB identifier: CN0091 The 3m Semi-anechoic chamber of Global United Technology Services Co., Ltd. has been registered by Certification and Engineering Bureau of Industry Canada for radio equipment testing. • NVLAP (LAB CODE:600179-0) Global United Technology Services Co., Ltd., is accredited by the National Voluntary Laboratory Accreditation Program (NVLAP). |
|--|

5.7 Test Location

| |
|---|
| All tests were performed at: |
| <p>Global United Technology Services Co., Ltd. Address: No. 123-128, Tower A, Jinyuan Business Building, No.2, Laodong Industrial Zone, Xixiang Road, Baoan District, Shenzhen, Guangdong, China 518102 Tel: 0755-27798480 Fax: 0755-27798960</p> |

5.8 Additional Instructions

| | |
|-------------------|--|
| Test Software | Special test software provided by manufacturer |
| Power level setup | Default |

6 Test Instruments list

| Radiated Emission: | | | | | | |
|--------------------|-------------------------------------|--------------------------------|-----------------------------|---------------|---------------------|-------------------------|
| Item | Test Equipment | Manufacturer | Model No. | Inventory No. | Cal.Date (mm-dd-yy) | Cal.Due date (mm-dd-yy) |
| 1 | 3m Semi- Anechoic Chamber | ZhongYu Electron | 9.2(L)*6.2(W)* 6.4(H) | GTS250 | July. 02 2020 | July. 01 2025 |
| 2 | Control Room | ZhongYu Electron | 6.2(L)*2.5(W)* 2.4(H) | GTS251 | N/A | N/A |
| 3 | EMI Test Receiver | Rohde & Schwarz | ESU26 | GTS203 | June. 24 2021 | June. 23 2022 |
| 4 | BiConiLog Antenna | SCHWARZBECK MESS-ELEKTRONIK | VULB9163 | GTS214 | June. 24 2021 | June. 23 2022 |
| 5 | Double -ridged waveguide horn | SCHWARZBECK MESS-ELEKTRONIK | BBHA 9120 D | GTS208 | June. 24 2021 | June. 23 2022 |
| 6 | Horn Antenna | ETS-LINDGREN | 3160 | GTS217 | June. 24 2021 | June. 23 2022 |
| 7 | EMI Test Software | AUDIX | E3 | N/A | N/A | N/A |
| 8 | Coaxial Cable | GTS | N/A | GTS213 | June. 24 2021 | June. 23 2022 |
| 9 | Coaxial Cable | GTS | N/A | GTS211 | June. 24 2021 | June. 23 2022 |
| 10 | Coaxial cable | GTS | N/A | GTS210 | June. 24 2021 | June. 23 2022 |
| 11 | Coaxial Cable | GTS | N/A | GTS212 | June. 24 2021 | June. 23 2022 |
| 12 | Amplifier(100kHz-3GHz) | HP | 8347A | GTS204 | June. 24 2021 | June. 23 2022 |
| 13 | Amplifier(2GHz-20GHz) | HP | 84722A | GTS206 | June. 24 2021 | June. 23 2022 |
| 14 | Amplifier (18-26GHz) | Rohde & Schwarz | AFS33-18002 650-30-8P-44 | GTS218 | June. 24 2021 | June. 23 2022 |
| 15 | Band filter | Amindeon | 82346 | GTS219 | June. 24 2021 | June. 23 2022 |
| 16 | Power Meter | Anritsu | ML2495A | GTS540 | June. 24 2021 | June. 23 2022 |
| 17 | Power Sensor | Anritsu | MA2411B | GTS541 | June. 24 2021 | June. 23 2022 |
| 18 | Wideband Radio Communication Tester | Rohde & Schwarz | CMW500 | GTS575 | June. 24 2021 | June. 23 2022 |
| 19 | Splitter | Agilent | 11636B | GTS237 | June. 24 2021 | June. 23 2022 |
| 20 | Loop Antenna | ZHINAN | ZN30900A | GTS534 | June. 24 2021 | June. 23 2022 |
| 21 | Breitband hornantenne | SCHWARZBECK | BBHA 9170 | GTS579 | Oct. 17 2021 | Oct. 16 2022 |
| 22 | Amplifier | TDK | PA-02-02 | GTS574 | Oct. 17 2021 | Oct. 16 2022 |
| 23 | Amplifier | TDK | PA-02-03 | GTS576 | Oct. 17 2021 | Oct. 16 2022 |
| 24 | PSA Series Spectrum Analyzer | Rohde & Schwarz | FSP | GTS578 | June. 24 2021 | June. 23 2022 |

| Conducted Emission | | | | | | |
|--------------------|---------------------------|-------------------------|----------------------|---------------|---------------------|-------------------------|
| Item | Test Equipment | Manufacturer | Model No. | Inventory No. | Cal.Date (mm-dd-yy) | Cal.Due date (mm-dd-yy) |
| 1 | Shielding Room | ZhongYu Electron | 7.3(L)x3.1(W)x2.9(H) | GTS252 | May.15 2019 | May.14 2022 |
| 2 | EMI Test Receiver | R&S | ESCI 7 | GTS552 | June. 24 2021 | June. 23 2022 |
| 3 | Coaxial Switch | ANRITSU CORP | MP59B | GTS225 | June. 24 2021 | June. 23 2022 |
| 4 | ENV216 2-L-V-NETZNACHB.DE | ROHDE&SCHWARZ | ENV216 | GTS226 | June. 24 2021 | June. 23 2022 |
| 5 | Coaxial Cable | GTS | N/A | GTS227 | N/A | N/A |
| 6 | EMI Test Software | AUDIX | E3 | N/A | N/A | N/A |
| 7 | Thermo meter | KTJ | TA328 | GTS233 | June. 24 2021 | June. 23 2022 |
| 8 | Absorbing clamp | Elektronik-Feinmechanik | MDS21 | GTS229 | June. 24 2021 | June. 23 2022 |
| 9 | ISN | SCHWARZBECK | NTFM 8158 | GTS565 | June. 24 2021 | June. 23 2022 |
| 10 | High voltage probe | SCHWARZBECK | TK9420 | GTS537 | July. 09 2021 | July. 08 2022 |

| RF Conducted Test: | | | | | | |
|--------------------|--|--------------|------------------|------------|---------------------|-------------------------|
| Item | Test Equipment | Manufacturer | Model No. | Serial No. | Cal.Date (mm-dd-yy) | Cal.Due date (mm-dd-yy) |
| 1 | MXA Signal Analyzer | Agilent | N9020A | GTS566 | June. 24 2021 | June. 23 2022 |
| 2 | EMI Test Receiver | R&S | ESCI 7 | GTS552 | June. 24 2021 | June. 23 2022 |
| 3 | Spectrum Analyzer | Agilent | E4440A | GTS533 | June. 24 2021 | June. 23 2022 |
| 4 | MXG vector Signal Generator | Agilent | N5182A | GTS567 | June. 24 2021 | June. 23 2022 |
| 5 | ESG Analog Signal Generator | Agilent | E4428C | GTS568 | June. 24 2021 | June. 23 2022 |
| 6 | USB RF Power Sensor | DARE | RPR3006W | GTS569 | June. 24 2021 | June. 23 2022 |
| 7 | RF Switch Box | Shongyi | RFSW3003328 | GTS571 | June. 24 2021 | June. 23 2022 |
| 8 | Programmable Constant Temp & Humi Test Chamber | WEWON | WHTH-150L-40-880 | GTS572 | June. 24 2021 | June. 23 2022 |

| General used equipment: | | | | | | |
|-------------------------|---------------------------------|--------------|-----------|---------------|---------------------|-------------------------|
| Item | Test Equipment | Manufacturer | Model No. | Inventory No. | Cal.Date (mm-dd-yy) | Cal.Due date (mm-dd-yy) |
| 1 | Humidity/ Temperature Indicator | KTJ | TA328 | GTS243 | June. 24 2021 | June. 23 2022 |
| 2 | Barometer | ChangChun | DYM3 | GTS255 | June. 24 2021 | June. 23 2022 |

7 Test results and Measurement Data

7.1 Antenna requirement

| | |
|--|-------------------------------------|
| Standard requirement: | FCC Part15 C Section 15.203 /247(c) |
| <p>15.203 requirement:</p> <p>An intentional radiator shall be designed to ensure that no antenna other than that furnished by the responsible party shall be used with the device. The use of a permanently attached antenna or of an antenna that uses a unique coupling to the intentional radiator, the manufacturer may design the unit so that a broken antenna can be replaced by the user, but the use of a standard antenna jack or electrical connector is prohibited.</p> <p>15.247(c) (1)(i) requirement:</p> <p>(i) Systems operating in the 2400-2483.5 MHz band that is used exclusively for fixed. Point-to-point operations may employ transmitting antennas with directional gain greater than 6dBi provided the maximum conducted output power of the intentional radiator is reduced by 1 dB for every 3 dB that the directional gain of the antenna exceeds 6dBi.</p> | |
| E.U.T Antenna: | |
| <i>The antenna is PCB antenna, the best case gain of the is -0.58dBi, reference to the appendix II for details</i> | |

7.2 Conducted Emissions

| | | | | | |
|--|--|-------|--------------|-----------|------------------|
| Test Requirement: | FCC Part15 C Section 15.207 | | | | |
| Test Method: | ANSI C63.10:2013 | | | | |
| Test Frequency Range: | 150KHz to 30MHz | | | | |
| Class / Severity: | Class B | | | | |
| Receiver setup: | RBW=9KHz, VBW=30KHz, Sweep time=auto | | | | |
| Limit: | Frequency range (MHz) | | Limit (dBuV) | | |
| | | | Quasi-peak | Average | |
| | 0.15-0.5 | | 66 to 56* | 56 to 46* | |
| | 0.5-5 | | 56 | 46 | |
| 5-30 | | 60 | 50 | | |
| * Decreases with the logarithm of the frequency. | | | | | |
| Test setup: | <p>Remark E.U.T: Equipment Under Test LISN: Line Impedance Stabilization Network Test table height=0.8m</p> | | | | |
| Test procedure: | <ol style="list-style-type: none"> 1. The E.U.T and simulators are connected to the main power through a line impedance stabilization network (L.I.S.N.). This provides a 50ohm/50uH coupling impedance for the measuring equipment. 2. The peripheral devices are also connected to the main power through a LISN that provides a 50ohm/50uH coupling impedance with 50ohm termination. (Please refer to the block diagram of the test setup and photographs). 3. Both sides of A.C. line are checked for maximum conducted interference. In order to find the maximum emission, the relative positions of equipment and all of the interface cables must be changed according to ANSI C63.10:2013 on conducted measurement. | | | | |
| Test Instruments: | Refer to section 6.0 for details | | | | |
| Test mode: | Refer to section 5.2 for details | | | | |
| Test environment: | Temp.: | 25 °C | Humid.: | 52% | Press.: 1012mbar |
| Test results: | Pass | | | | |

Remark: Both high and low voltages have been tested to show only the worst low voltage test data.

Measurement data:
Line:

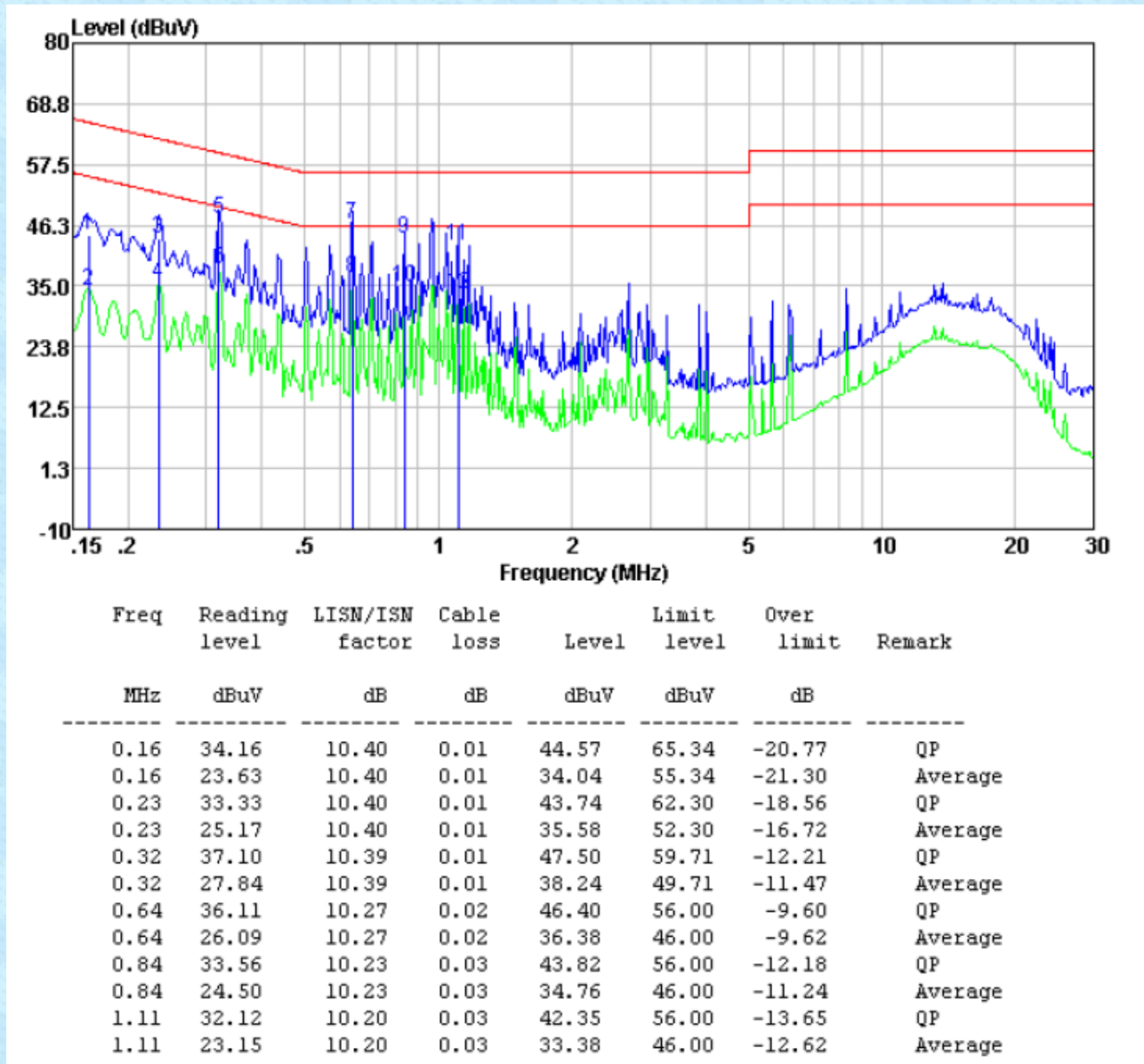

Neutral:

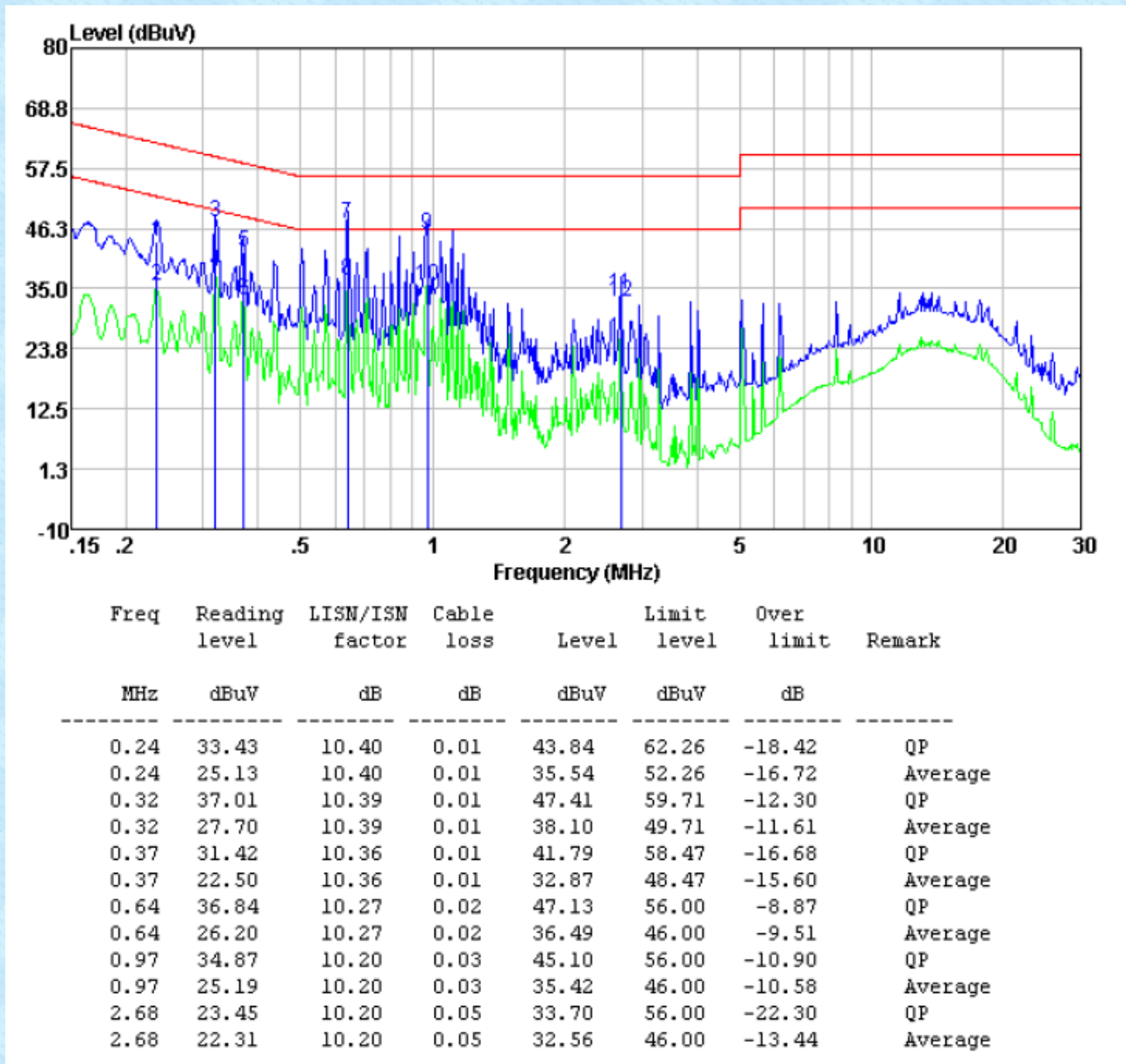

Notes:

1. An initial pre-scan was performed on the line and neutral lines with peak detector.
2. Quasi-Peak and Average measurement were performed at the frequencies with maximized peak emission.
3. Final Level = Receiver Read level + LISN Factor + Cable Loss

7.3 Conducted Peak Output Power

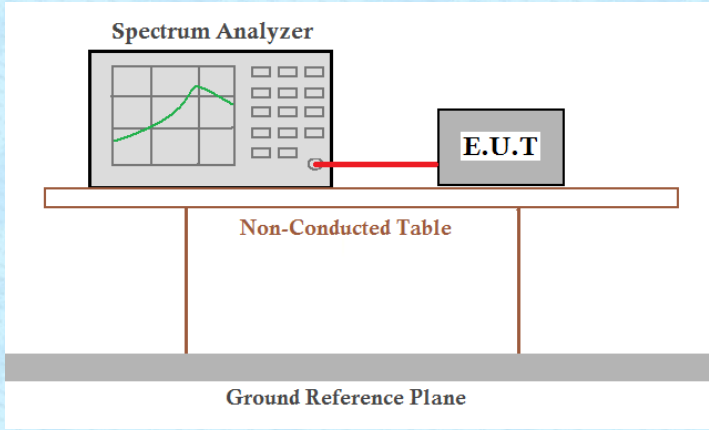
| | |
|-------------------|---|
| Test Requirement: | FCC Part15 C Section 15.247 (a)(1) |
| Test Method: | ANSI C63.10:2013 |
| Limit: | 30dBm(for GFSK),20.97dBm(for EDR) |
| Test setup: |  <p>The diagram illustrates the test setup. A Spectrum Analyzer is connected to an E.U.T. (Equipment Under Test) via a red cable. Both are placed on a Non-Conducted Table, which sits on a Ground Reference Plane.</p> |
| Test Instruments: | Refer to section 6.0 for details |
| Test mode: | Refer to section 5.2 for details |
| Test results: | Pass |

Measurement Data: The detailed test data see Appendix for BT EDR.

7.4 20dB Emission Bandwidth

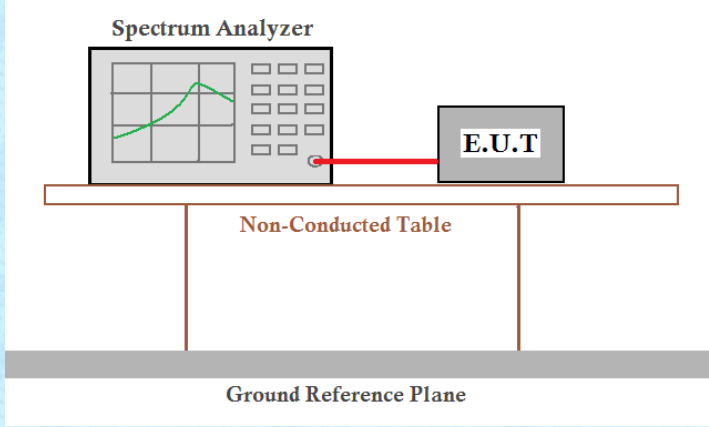
| | |
|-------------------|---|
| Test Requirement: | FCC Part15 C Section 15.247 (a)(1) |
| Test Method: | ANSI C63.10:2013 |
| Limit: | N/A |
| Test setup: |  <p>The diagram illustrates the test setup. A Spectrum Analyzer is connected to an E.U.T. (Equipment Under Test) via a red cable. Both are placed on a Non-Conducted Table, which sits on a Ground Reference Plane.</p> |
| Test Instruments: | Refer to section 6.0 for details |
| Test mode: | Refer to section 5.2 for details |
| Test results: | Pass |

Measurement Data: The detailed test data see Appendix for BT EDR.

7.5 Carrier Frequencies Separation

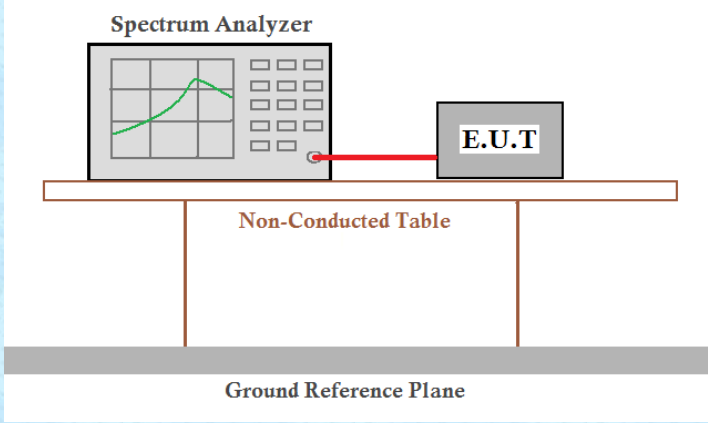
| | |
|-------------------|--|
| Test Requirement: | FCC Part15 C Section 15.247 (a)(1) |
| Test Method: | ANSI C63.10:2013 |
| Receiver setup: | RBW=100KHz, VBW=300KHz, detector=Peak |
| Limit: | GFSK: 20dB bandwidth $\pi/4$ -DQPSK & 8DSK: 0.025MHz or 2/3 of the 20dB bandwidth (whichever is greater) |
| Test setup: |  <p>The diagram illustrates the test setup. A Spectrum Analyzer is connected to an E.U.T. (Equipment Under Test) via a red cable. Both are placed on a Non-Conducted Table, which is supported by a Ground Reference Plane.</p> |
| Test Instruments: | Refer to section 6.0 for details |
| Test mode: | Refer to section 5.2 for details |
| Test results: | Pass |

Measurement Data: The detailed test data see Appendix for BT EDR.

7.6 Hopping Channel Number

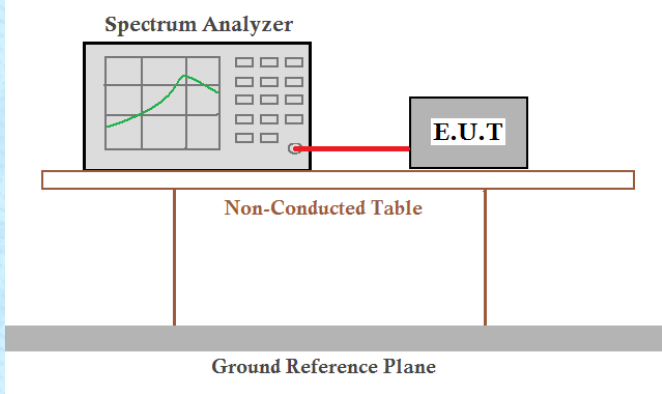
| | |
|-------------------|---|
| Test Requirement: | FCC Part15 C Section 15.247 (a)(1)(iii) |
| Test Method: | ANSI C63.10:2013 |
| Receiver setup: | RBW=100kHz, VBW=300kHz, Frequency range=2400MHz-2483.5MHz, Detector=Peak |
| Limit: | 15 channels |
| Test setup: |  <p>The diagram illustrates the test setup. A Spectrum Analyzer is connected to an E.U.T. (Equipment Under Test) via a red cable. Both are placed on a Non-Conducted Table, which is supported by a Ground Reference Plane.</p> |
| Test Instruments: | Refer to section 6.0 for details |
| Test mode: | Refer to section 5.2 for details |
| Test results: | Pass |

Measurement Data: The detailed test data see Appendix for BT EDR.

7.7 Dwell Time

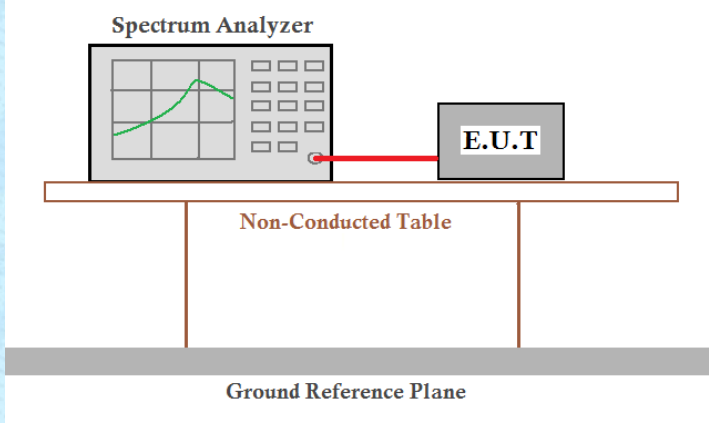
| | |
|-------------------|---|
| Test Requirement: | FCC Part15 C Section 15.247 (a)(1)(iii) |
| Test Method: | ANSI C63.10:2013 |
| Receiver setup: | RBW=1MHz, VBW=1MHz, Span=0Hz, Detector=Peak |
| Limit: | 0.4 Second |
| Test setup: |  <p>The diagram illustrates the test setup. A Spectrum Analyzer is connected to an E.U.T. (Equipment Under Test) via a red cable. Both are placed on a Non-Conducted Table, which is supported by a Ground Reference Plane.</p> |
| Test Instruments: | Refer to section 6.0 for details |
| Test mode: | Refer to section 5.2 for details |
| Test results: | Pass |

Measurement Data: The detailed test data see Appendix for BT EDR.

7.8 Spurious Emission in Non-restricted & restricted Bands

7.8.1 Conducted Emission Method

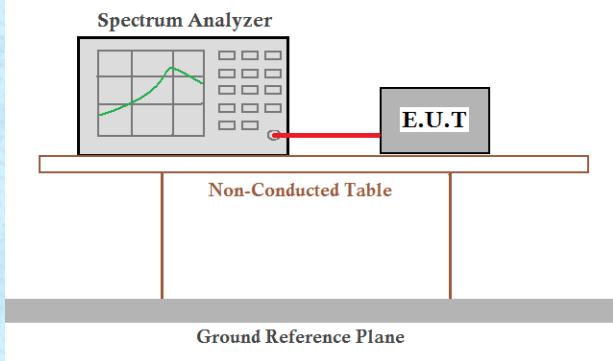
| | |
|-------------------|---|
| Test Requirement: | FCC Part15 C Section 15.247 (d) |
| Test Method: | ANSI C63.10:2013 |
| Receiver setup: | RBW=100kHz, VBW=300kHz, Detector=Peak |
| Limit: | In any 100 kHz bandwidth outside the frequency band in which the spread spectrum intentional radiator is operating, the radio frequency power that is produced by the intentional radiator shall be at least 20 dB below that in the 100 kHz bandwidth within the band that contains the highest level of the desired power, based on either an RF conducted or a radiated measurement. |
| Test setup: |  <p>The diagram illustrates the test setup. A Spectrum Analyzer is connected to an E.U.T. (Equipment Under Test) via a red cable. Both the Spectrum Analyzer and the E.U.T. are placed on a Non-Conducted Table. The table is supported by two legs and sits on a Ground Reference Plane.</p> |
| Test Instruments: | Refer to section 6.0 for details |
| Test mode: | Refer to section 5.2 for details |
| Test results: | Pass |

Measurement Data: The detailed test data see Appendix for BT EDR.

7.8.2 Radiated Emission Method

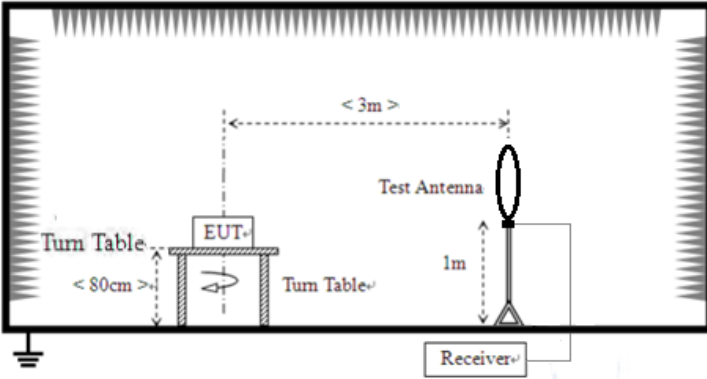
| | | | | | |
|-----------------------|--|--------------|---------|----------------------|------------|
| Test Requirement: | FCC Part15 C Section 15.209 | | | | |
| Test Method: | ANSI C63.10:2013 | | | | |
| Test Frequency Range: | 9kHz to 25GHz | | | | |
| Test site: | Measurement Distance: 3m | | | | |
| Receiver setup: | Frequency | Detector | RBW | VBW | Value |
| | 9KHz-150KHz | Quasi-peak | 200Hz | 600Hz | Quasi-peak |
| | 150KHz-30MHz | Quasi-peak | 9KHz | 30KHz | Quasi-peak |
| | 30MHz-1GHz | Quasi-peak | 120KHz | 300KHz | Quasi-peak |
| | Above 1GHz | Peak | 1MHz | 3MHz | Peak |
| Peak | | 1MHz | 10Hz | Average | |
| Limit: | Frequency | Limit (uV/m) | Value | Measurement Distance | |
| | 0.009MHz-0.490MHz | 2400/F(KHz) | QP | 300m | |
| | 0.490MHz-1.705MHz | 24000/F(KHz) | QP | 30m | |
| | 1.705MHz-30MHz | 30 | QP | 30m | |
| | 30MHz-88MHz | 100 | QP | 3m | |
| | 88MHz-216MHz | 150 | QP | | |
| | 216MHz-960MHz | 200 | QP | | |
| | 960MHz-1GHz | 500 | QP | | |
| | Above 1GHz | 500 | Average | | |
| 5000 | | Peak | | | |
| Test setup: | For radiated emissions from 9kHz to 30MHz | | | | |
| |  <p>The diagram illustrates the test setup for radiated emissions from 9kHz to 30MHz. It shows an Equipment Under Test (EUT) placed on a turn table. The turn table has a diameter of less than 80cm. The EUT is positioned on the turn table. A test antenna is mounted on a stand that is 1m high. The distance between the EUT and the test antenna is 3m. The test antenna is connected to a receiver. The ground plane is indicated by a ground symbol.</p> | | | | |

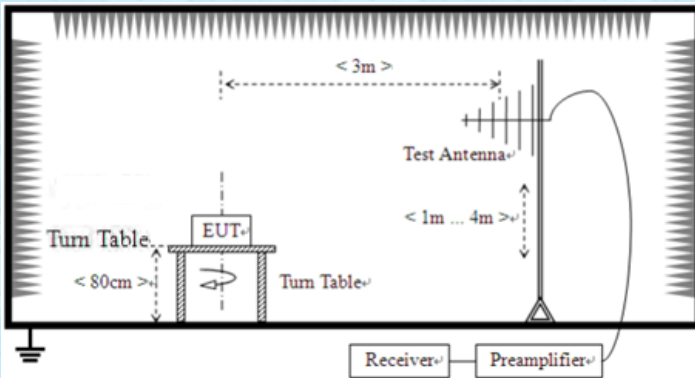
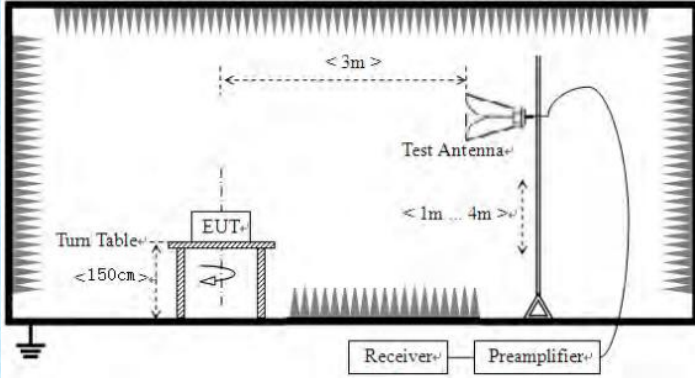
| | |
|--------------------------|--|
| | <p>For radiated emissions from 30MHz to1GHz</p>  <p>For radiated emissions above 1GHz</p>  |
| <p>Test Procedure:</p> | <ol style="list-style-type: none"> 1. The EUT was placed on the top of a rotating table (0.8m for below 1G and 1.5m for above 1G) above the ground at a 3 meter camber. The table was rotated 360 degrees to determine the position of the highest radiation. 2. The EUT was set 3 meters away from the interference-receiving antenna, which was mounted on the top of a variable-height antenna tower. 3. The antenna height is varied from one meter to four meters above the ground to determine the maximum value of the field strength. Both horizontal and vertical polarizations of the antenna are set to make the measurement. 4. For each suspected emission, the EUT was arranged to its worst case and then the antenna was tuned to heights from 1 meter to 4 meters and the rota table was turned from 0 degrees to 360 degrees to find the maximum reading. 5. The test-receiver system was set to Peak Detect Function and Specified Bandwidth with Maximum Hold Mode. 6. If the emission level of the EUT in peak mode was 10dB lower than the limit specified, then testing could be stopped and the peak values of the EUT would be reported. Otherwise the emissions that did not have 10dB margin would be re-tested one by one using peak, quasi-peak or average method as specified and then reported in a data sheet. |
| <p>Test Instruments:</p> | <p>Refer to section 6.0 for details</p> |
| <p>Test mode:</p> | <p>Refer to section 5.2 for details</p> |

| | | | | | | |
|-------------------|--------|-------|---------|-----|---------|----------|
| Test environment: | Temp.: | 25 °C | Humid.: | 52% | Press.: | 1012mbar |
| Test results: | Pass | | | | | |

Measurement data:

Remarks:

1. During the test, pre-scan the GFSK, $\pi/4$ -DQPSK, 8-DPSK modulation, and found the GFSK modulation which it is worse case.
2. Pre-scan all kind of the place mode (X-axis, Y-axis, Z-axis), and found the Y-axis which it is worse case.

■ 9kHz~30MHz

The low frequency, which started from 9 kHz to 30 MHz, was pre-scanned and the result which was 20 dB lower than the limit line per 15.31(o) was not reported.

■ Below 1GHz

Pre-scan all test modes, found worst case at GFSK 2480MHz, and so only show the test result of it

Horizontal:

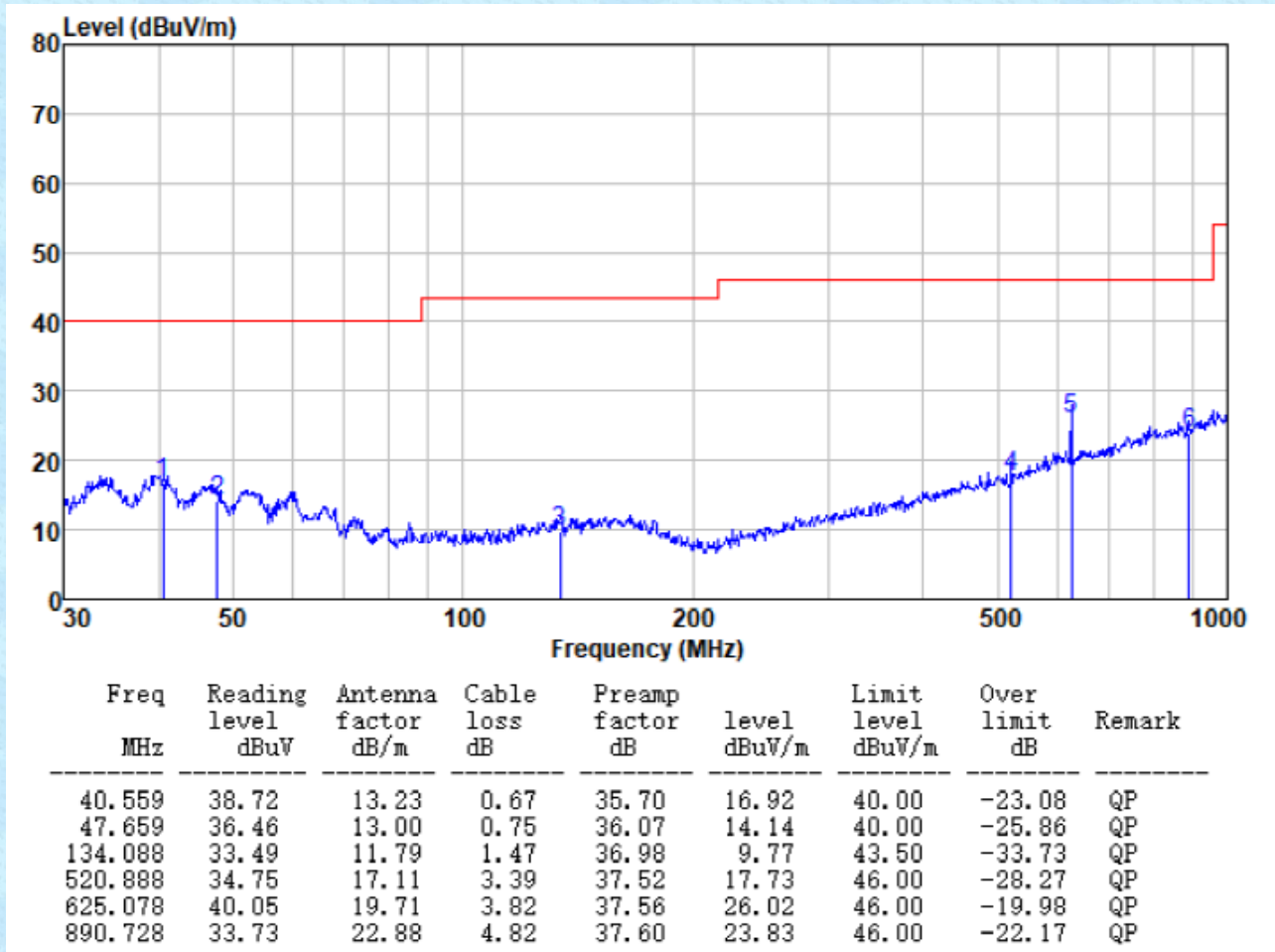

Vertical:

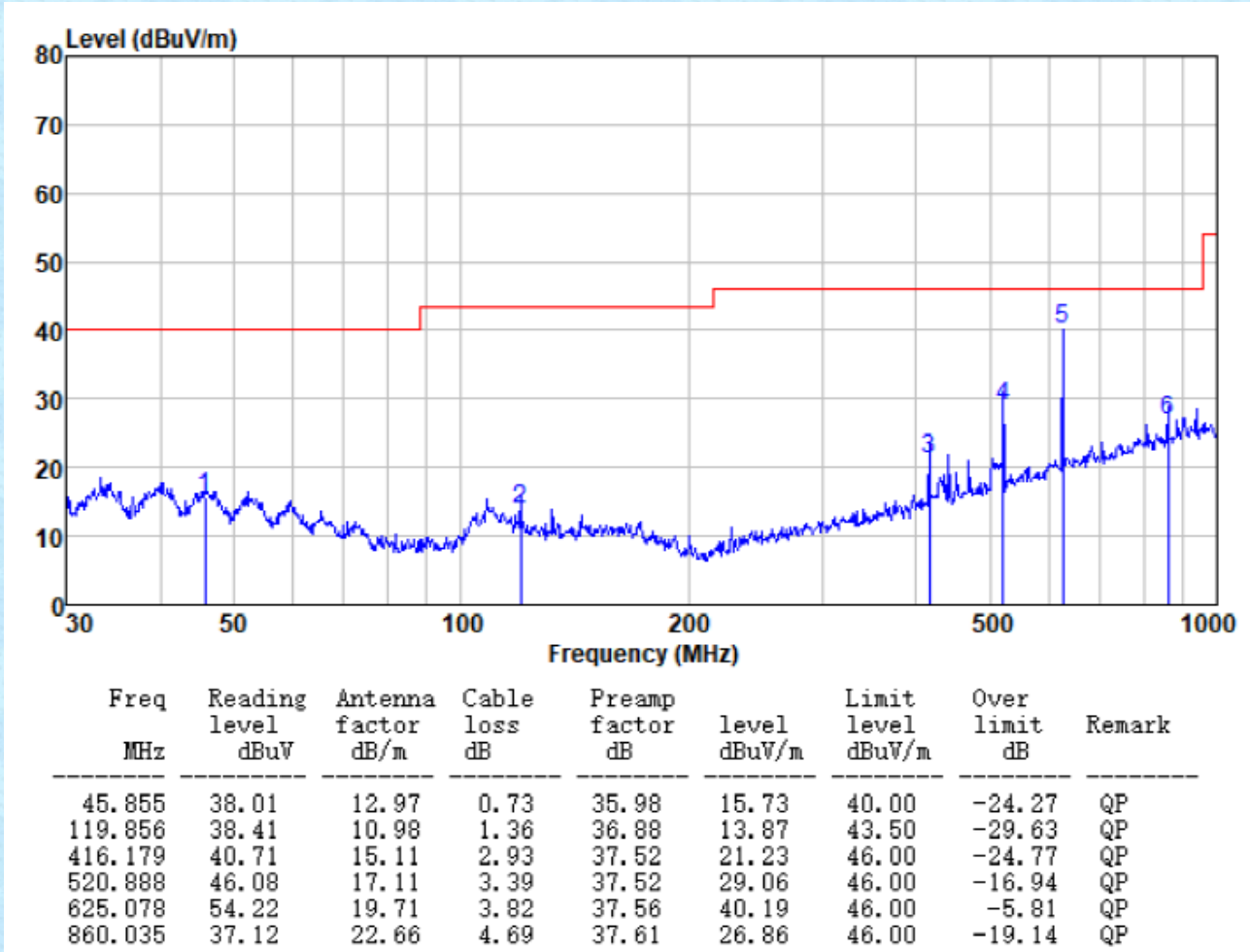

■ Above 1GHz

| | |
|---------------|----------------|
| Test channel: | Lowest channel |
|---------------|----------------|

Peak value:

| Frequency (MHz) | Read Level (dBuV) | Antenna Factor (dB/m) | Cable Loss (dB) | Preamp Factor (dB) | Level (dBuV/m) | Limit Line (dBuV/m) | Over Limit (dB) | polarization |
|-----------------|-------------------|-----------------------|-----------------|--------------------|----------------|---------------------|-----------------|--------------|
| 4804.00 | 34.45 | 31.20 | 4.61 | 37.70 | 32.56 | 74.00 | -41.44 | Vertical |
| 7206.00 | 29.94 | 36.16 | 6.48 | 37.82 | 34.76 | 74.00 | -39.24 | Vertical |
| 9608.00 | 29.78 | 37.93 | 7.97 | 37.92 | 37.76 | 74.00 | -36.24 | Vertical |
| 4804.00 | 38.15 | 31.20 | 4.61 | 37.70 | 36.26 | 74.00 | -37.74 | Horizontal |
| 7206.00 | 31.44 | 36.16 | 6.48 | 37.82 | 36.26 | 74.00 | -37.74 | Horizontal |
| 9608.00 | 28.94 | 37.93 | 7.97 | 37.92 | 36.92 | 74.00 | -37.08 | Horizontal |

Average value:

| Frequency (MHz) | Read Level (dBuV) | Antenna Factor (dB/m) | Cable Loss (dB) | Preamp Factor (dB) | Level (dBuV/m) | Limit Line (dBuV/m) | Over Limit (dB) | polarization |
|-----------------|-------------------|-----------------------|-----------------|--------------------|----------------|---------------------|-----------------|--------------|
| 4804.00 | 23.81 | 31.20 | 4.61 | 37.70 | 21.92 | 54.00 | -32.08 | Vertical |
| 7206.00 | 18.95 | 36.16 | 6.48 | 37.82 | 23.77 | 54.00 | -30.23 | Vertical |
| 9608.00 | 18.20 | 37.93 | 7.97 | 37.92 | 26.18 | 54.00 | -27.82 | Vertical |
| 4804.00 | 27.72 | 31.20 | 4.61 | 37.70 | 25.83 | 54.00 | -28.17 | Horizontal |
| 7206.00 | 20.93 | 36.16 | 6.48 | 37.82 | 25.75 | 54.00 | -28.25 | Horizontal |
| 9608.00 | 17.69 | 37.93 | 7.97 | 37.92 | 25.67 | 54.00 | -28.33 | Horizontal |

| | |
|---------------|----------------|
| Test channel: | Middle channel |
|---------------|----------------|

Peak value:

| Frequency (MHz) | Read Level (dBuV) | Antenna Factor (dB/m) | Cable Loss (dB) | Preamp Factor (dB) | Level (dBuV/m) | Limit Line (dBuV/m) | Over Limit (dB) | polarization |
|-----------------|-------------------|-----------------------|-----------------|--------------------|----------------|---------------------|-----------------|--------------|
| 4882.00 | 33.29 | 31.33 | 4.69 | 37.62 | 31.69 | 74.00 | -42.31 | Vertical |
| 7323.00 | 29.17 | 36.43 | 6.63 | 37.77 | 34.46 | 74.00 | -39.54 | Vertical |
| 9764.00 | 29.10 | 38.10 | 8.03 | 37.95 | 37.28 | 74.00 | -36.72 | Vertical |
| 4882.00 | 36.75 | 31.33 | 4.69 | 37.62 | 35.15 | 74.00 | -38.85 | Horizontal |
| 7323.00 | 30.57 | 36.43 | 6.63 | 37.77 | 35.86 | 74.00 | -38.14 | Horizontal |
| 9764.00 | 28.14 | 38.10 | 8.03 | 37.95 | 36.32 | 74.00 | -37.68 | Horizontal |

Average value:

| Frequency (MHz) | Read Level (dBuV) | Antenna Factor (dB/m) | Cable Loss (dB) | Preamp Factor (dB) | Level (dBuV/m) | Limit Line (dBuV/m) | Over Limit (dB) | polarization |
|-----------------|-------------------|-----------------------|-----------------|--------------------|----------------|---------------------|-----------------|--------------|
| 4882.00 | 22.86 | 31.33 | 4.69 | 37.62 | 21.26 | 54.00 | -32.74 | Vertical |
| 7323.00 | 18.30 | 36.43 | 6.63 | 37.77 | 23.59 | 54.00 | -30.41 | Vertical |
| 9764.00 | 17.63 | 38.10 | 8.03 | 37.95 | 25.81 | 54.00 | -28.19 | Vertical |
| 4882.00 | 26.64 | 31.33 | 4.69 | 37.62 | 25.04 | 54.00 | -28.96 | Horizontal |
| 7323.00 | 20.21 | 36.43 | 6.63 | 37.77 | 25.50 | 54.00 | -28.50 | Horizontal |
| 9764.00 | 17.03 | 38.10 | 8.03 | 37.95 | 25.21 | 54.00 | -28.79 | Horizontal |

| | |
|---------------|-----------------|
| Test channel: | Highest channel |
|---------------|-----------------|

Peak value:

| Frequency (MHz) | Read Level (dBuV) | Antenna Factor (dB/m) | Cable Loss (dB) | Preamp Factor (dB) | Level (dBuV/m) | Limit Line (dBuV/m) | Over Limit (dB) | polarization |
|-----------------|-------------------|-----------------------|-----------------|--------------------|----------------|---------------------|-----------------|--------------|
| 4960.00 | 34.88 | 31.44 | 4.79 | 37.54 | 33.57 | 74.00 | -40.43 | Vertical |
| 7440.00 | 30.22 | 36.66 | 6.77 | 37.72 | 35.93 | 74.00 | -38.07 | Vertical |
| 9920.00 | 30.04 | 38.30 | 8.09 | 37.98 | 38.45 | 74.00 | -35.55 | Vertical |
| 4960.00 | 38.67 | 31.44 | 4.79 | 37.54 | 37.36 | 74.00 | -36.64 | Horizontal |
| 7440.00 | 31.76 | 36.66 | 6.77 | 37.72 | 37.47 | 74.00 | -36.53 | Horizontal |
| 9920.00 | 29.23 | 38.30 | 8.09 | 37.98 | 37.64 | 74.00 | -36.36 | Horizontal |

Average value:

| Frequency (MHz) | Read Level (dBuV) | Antenna Factor (dB/m) | Cable Loss (dB) | Preamp Factor (dB) | Level (dBuV/m) | Limit Line (dBuV/m) | Over Limit (dB) | polarization |
|-----------------|-------------------|-----------------------|-----------------|--------------------|----------------|---------------------|-----------------|--------------|
| 4960.00 | 24.16 | 31.44 | 4.79 | 37.54 | 22.85 | 54.00 | -31.15 | Vertical |
| 7440.00 | 19.19 | 36.66 | 6.77 | 37.72 | 24.90 | 54.00 | -29.10 | Vertical |
| 9920.00 | 18.42 | 38.30 | 8.09 | 37.98 | 26.83 | 54.00 | -27.17 | Vertical |
| 4960.00 | 28.12 | 31.44 | 4.79 | 37.54 | 26.81 | 54.00 | -27.19 | Horizontal |
| 7440.00 | 21.20 | 36.66 | 6.77 | 37.72 | 26.91 | 54.00 | -27.09 | Horizontal |
| 9920.00 | 17.95 | 38.30 | 8.09 | 37.98 | 26.36 | 54.00 | -27.64 | Horizontal |

Remarks:

1. *Final Level = Receiver Read level + Antenna Factor + Cable Loss – Preamplifier Factor*
2. *The emission levels of other frequencies are very lower than the limit and not show in test report.*

■ **Unwanted Emissions in Non-restricted Frequency Bands**

| | |
|---------------|----------------|
| Test channel: | Lowest channel |
|---------------|----------------|

Peak value:

| Frequency (MHz) | Read Level (dBuV) | Antenna Factor (dB/m) | Cable Loss (dB) | Preamp Factor (dB) | Level (dBuV/m) | Limit Line (dBuV/m) | Over Limit (dB) | Polarization |
|-----------------|-------------------|-----------------------|-----------------|--------------------|----------------|---------------------|-----------------|--------------|
| 2310.00 | 43.83 | 27.14 | 2.81 | 38.64 | 35.14 | 74.00 | -38.86 | Horizontal |
| 2390.00 | 47.76 | 27.37 | 2.91 | 38.84 | 39.20 | 74.00 | -34.80 | Horizontal |
| 2310.00 | 44.47 | 27.14 | 2.81 | 38.64 | 35.78 | 74.00 | -38.22 | Vertical |
| 2390.00 | 47.89 | 27.37 | 2.91 | 38.84 | 39.33 | 74.00 | -34.67 | Vertical |

Average value:

| Frequency (MHz) | Read Level (dBuV) | Antenna Factor (dB/m) | Cable Loss (dB) | Preamp Factor (dB) | Level (dBuV/m) | Limit Line (dBuV/m) | Over Limit (dB) | Polarization |
|-----------------|-------------------|-----------------------|-----------------|--------------------|----------------|---------------------|-----------------|--------------|
| 2310.00 | 34.17 | 27.14 | 2.81 | 38.64 | 25.48 | 54.00 | -28.52 | Horizontal |
| 2390.00 | 35.46 | 27.37 | 2.91 | 38.84 | 26.90 | 54.00 | -27.10 | Horizontal |
| 2310.00 | 34.18 | 27.14 | 2.81 | 38.64 | 25.49 | 54.00 | -28.51 | Vertical |
| 2390.00 | 36.20 | 27.37 | 2.91 | 38.84 | 27.64 | 54.00 | -26.36 | Vertical |

| | |
|---------------|-----------------|
| Test channel: | Highest channel |
|---------------|-----------------|

Peak value:

| Frequency (MHz) | Read Level (dBuV) | Antenna Factor (dB/m) | Cable Loss (dB) | Preamp Factor (dB) | Level (dBuV/m) | Limit Line (dBuV/m) | Over Limit (dB) | Polarization |
|-----------------|-------------------|-----------------------|-----------------|--------------------|----------------|---------------------|-----------------|--------------|
| 2483.50 | 46.05 | 27.66 | 2.99 | 39.06 | 37.64 | 74.00 | -36.36 | Horizontal |
| 2500.00 | 45.04 | 27.70 | 3.01 | 39.10 | 36.65 | 74.00 | -37.35 | Horizontal |
| 2483.50 | 47.05 | 27.66 | 2.99 | 39.06 | 38.64 | 74.00 | -35.36 | Vertical |
| 2500.00 | 46.13 | 27.70 | 3.01 | 39.10 | 37.74 | 74.00 | -36.26 | Vertical |

Average value:

| Frequency (MHz) | Read Level (dBuV) | Antenna Factor (dB/m) | Cable Loss (dB) | Preamp Factor (dB) | Level (dBuV/m) | Limit Line (dBuV/m) | Over Limit (dB) | Polarization |
|-----------------|-------------------|-----------------------|-----------------|--------------------|----------------|---------------------|-----------------|--------------|
| 2483.50 | 35.00 | 27.66 | 2.99 | 39.06 | 26.59 | 54.00 | -27.41 | Horizontal |
| 2500.00 | 34.87 | 27.70 | 3.01 | 39.10 | 26.48 | 54.00 | -27.52 | Horizontal |
| 2483.50 | 35.53 | 27.66 | 2.99 | 39.06 | 27.12 | 54.00 | -26.88 | Vertical |
| 2500.00 | 34.87 | 27.70 | 3.01 | 39.10 | 26.48 | 54.00 | -27.52 | Vertical |

Remarks:

1. *Final Level = Receiver Read level + Antenna Factor + Cable Loss – Pre-amplifier Factor*
2. *The emission levels of other frequencies are very lower than the limit and not show in test report.*

8 Test Setup Photo

Reference to the **appendix I** for details.

9 EUT Constructional Details

Reference to the **appendix II** for details.

-----End-----