

TEST REPORT

Report Reference No. : 180203001RFC-1 70998
FCC ID : 2AEY7-S8A003
Applicant's name : Bak USA Technologies Corp.
Address : 425 Michigan Avenue, Buffalo, New York 14203, USA
Manufacturer : Bak USA Technologies Corp.
Address : 425 Michigan Avenue, Buffalo, New York 14203, USA
Test item description : Tablet PC
Trade Mark : -
Model/Type reference : Seal8Pro
Listed Model(s) : -
Standard : FCC CFR Title 47 Part 15 Subpart E Section 15.407
Date of receipt of test sample : Mar. 15, 2018
Date of testing : Mar. 15, 2017- Mar. 23, 2018
Date of issue : Mar. 26, 2018
Result : PASS

Tested by : Engineer : Henry Lu
Reviewed by : Assistant Manager : Kevin Liang
Approved by : Technical Director : Billy Li

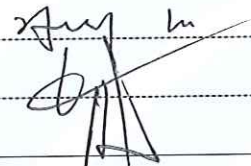

Testing Laboratory Name : Shenzhen UnionTrust Quality and Technology Co., Ltd.
Address : 16/F, Block A, Building 6, Baoneng Science and Technology Park, Qingxiang Road No.1, Longhua New District, Shenzhen, China

Contents

1.	<u>TEST STANDARDS AND REPORT VERSION</u>	3
1.1.	Test Standards	3
1.2.	Report Version	3
2.	<u>TEST DESCRIPTION</u>	4
	Dynamic Frequency Selection(DFS)	4
3.	<u>SUMMARY</u>	5
3.1.	Client Information	5
3.2.	Product Description	5
3.3.	Operation state	6
3.4.	EUT configuration	7
3.5.	Modifications	7
4.	<u>TEST ENVIRONMENT</u>	8
4.1.	Address of the test laboratory	8
4.2.	Test Facility	8
4.3.	Environmental conditions	9
4.4.	Statement of the measurement uncertainty	9
4.5.	Equipments Used during the Test	10
5.	<u>TEST CONDITIONS AND RESULTS</u>	11
5.1.	Antenna requirement	11
5.2.	Conducted Emissions (AC Main)	12
5.3.	Maximum Conducted Output Power	15
5.4.	Maximum Power Spectral Density	17
5.5.	26dB bandwidth and 99% Occupy bandwidth	31
5.6.	6dB Bandwidth	41
5.7.	Band edge	45
5.8.	Radiated Spurious Emissions	51
5.9.	Dynamic Frequency Selection(DFS)	59
6.	<u>TEST SETUP PHOTOS OF THE EUT</u>	73
7.	<u>EXTERNAL AND INTERNAL PHOTOS OF THE EUT</u>	75

1. TEST STANDARDS AND REPORT VERSION

1.1. Test Standards

The tests were performed according to following standards:
[FCC Rules Part 15.407](#): General technical requirements.

[ANSI C63.10-2013](#): American National Standard for Testing Unlicensed Wireless Devices

[KDB789033 D02 v01r04](#): GUIDELINES FOR COMPLIANCE TESTING OF UNLICENSED NATIONAL INFORMATION INFRASTRUCTURE (U-NII) DEVICES PART 15, SUBPART E

1.2. Report Version

Version No.	Date of issue	Description
N/A	Mar.26, 2018	Original

2. TEST DESCRIPTION

Test Item	FCC Rule	Result	Test Engineer
Antenna Requirement	15.203	PASS	Henry Lu
Line Conducted Emissions (AC Main)	15.207	PASS	Andy Lin
Maximum Conducted Output Power	15.407(a)	PASS	Henry Lu
Maximum Power Spectral Density	15.407(a)	PASS	Henry Lu
26dB Bandwidth and 99% Occupancy bandwidth	15.407(a)	PASS	Henry Lu
6dB Bandwidth	15.407(a)	PASS	Henry Lu
Band edge	15.407(b)	PASS	Henry Lu
Radiated Spurious Emissions	15.209	PASS	Terence Chen
Dynamic Frequency Selection(DFS)	15.407(h)	PASS	Henry Lu

Remark: The measurement uncertainty is not included in the test result.

3. SUMMARY

3.1. Client Information

Applicant:	Bak USA Technologies Corp.
Address:	425 Michigan Avenue, Buffalo, New York 14203, USA
Manufacturer:	Bak USA Technologies Corp.
Address:	425 Michigan Avenue, Buffalo, New York 14203, USA

3.2. Product Description

Name of EUT	Tablet PC		
Trade Mark:	-		
Model No.:	Seal8Pro		
Listed Model(s):	-		
Power supply:	DC 3.7V From exchange battery		
Adapter information:	Input: 100-240Va.c., 50/60Hz, 0.6A Output: 5Vd.c., 5A		
5G WIFI			
Supported type:	<input type="checkbox"/> 802.11a	<input type="checkbox"/> 802.11n(HT20)	<input type="checkbox"/> 802.11n(HT40)
	<input checked="" type="checkbox"/> 802.11ac(HT20)	<input checked="" type="checkbox"/> 802.11ac(HT40)	<input checked="" type="checkbox"/> 802.11ac(HT80)
Function:	<input type="checkbox"/> Outdoor AP	<input type="checkbox"/> Indoor AP	<input type="checkbox"/> Fixed P2P
	<input checked="" type="checkbox"/> Client		
DFS type:	<input type="checkbox"/> master devices	<input type="checkbox"/> Slave devices with radar detection	<input checked="" type="checkbox"/> Slave devices without radar detection
Modulation:	BPSK, QPSK, 16QAM, 64QAM		
Operation frequency:	<input checked="" type="checkbox"/> Band I:	5150MHz~5250MHz	
	<input checked="" type="checkbox"/> Band II:	5250MHz~5350MHz	
	<input checked="" type="checkbox"/> Band III:	5470MHz~5725MHz	
	<input checked="" type="checkbox"/> Band IV:	5725MHz~5850MHz	
Supported Bandwidth	20MHz:	802.11ac	
	40MHz:	802.11ac	
	80MHz:	802.11ac	
Antenna type:	Integral antenna		
Antenna gain:	2dBi		

3.3. Operation state

➤ Frequency list

According to section 15.31(m), regards to the operating frequency range over 10 MHz, must select three channel which were tested. the Lowest frequency, the middle frequency, and the highest frequency of channel were selected to perform the test, please see the above gray bottom.

Band	Test Channel	20MHz		40MHz		80MHz	
		Channel	Frequency (MHz)	Channel	Frequency (MHz)	Channel	Frequency (MHz)
I	CH _L	36	5180	38	5190	-	-
	CH _M	44	5220	-	-	42	5210
	CH _H	48	5240	46	5230	-	-
II	CH _L	52	5260	54	5270	-	-
	CH _M	56	5280	-	-	58	5290
	CH _H	64	5320	62	5310	-	-
III	CH _L	100	5500	102	5510	106	5530
	CH _M	120	5600	118	5590	-	-
	CH _H	140	5700	134	5670	122	5610
IV	CH _L	149	5745	151	5755	-	-
	CH _M	157	5785	-	-	155	5775
	CH _H	165	5825	159	5795	-	-

➤ Data Rated

Preliminary tests were performed in different data rate, and found which the below bit rate is worst case mode, so only show data which it is a worst case mode.

Mode	Data rate (worst mode)
802.11ac(HT20)	MCS0
802.11ac(HT40)	MCS0
802.11ac(HT80)	MCS0

➤ Test mode

For RF test items
The engineering test program was provided and enabled to make EUT continuous transmit (duty cycle>98%).
For AC power line conducted emissions:
The EUT was set to connect with the WLAN AP under large package sizes transmission.
For Radiated suprious emissions test item:
The engineering test program was provided and enabled to make EUT continuous transmit(duty cycle>98%). The EUT in each of three orthogonal axis emissions had been tested ,but only the worst case (X axis) data Recorded in the report.

3.4. EUT configuration

The following peripheral devices and interface cables were connected during the measurement:

- - supplied by the manufacturer
- - supplied by the lab

○	N/A	Manufacturer :	N/A
		Model No. :	N/A
○	N/A	Manufacturer :	N/A
		Model No. :	N/A

3.5. Modifications

No modifications were implemented to meet testing criteria.

4. TEST ENVIRONMENT

4.1. Address of the test laboratory

Shenzhen UnionTrust Quality and Technology Co., Ltd.

Address: 16/F, Block A, Building 6, Baoneng Science and Technology Park, Qingxiang Road No.1, Longhua New District, Shenzhen, China 518109

Phone: +86 (0) 755 2823 0888 Fax: +86 (0) 755 2823 0886

4.2. Test Facility

CNAS-Lab Code: L9069

The measuring equipment utilized to perform the tests documented in this report has been calibrated once a year or in accordance with the manufacturer's recommendations, and is traceable under the ISO/IEC/EN 17025 to international or national standards. Equipment has been calibrated by accredited calibration laboratories.

IC-Registration No.: 21600-1

The 3m Semi-anechoic chamber of Shenzhen UnionTrust Quality and Technology Co., Ltd. has been registered by Certification and Engineering Bureau of Industry Canada for radio equipment testing with Registration No.: 21600-1

A2LA-Lab Certificate No.: 4312.01

Shenzhen UnionTrust Quality and Technology Co., Ltd. has been accredited by A2LA for technical competence in the field of electrical testing, and proved to be in compliance with ISO/IEC 17025: 2005 General Requirements for the Competence of Testing and Calibration Laboratories and any additional program requirements in the identified field of testing.

FCC Accredited Lab

Designation Number: CN1194

Test Firm Registration Number: 25948

4.3. Environmental conditions

During the measurement the environmental conditions were within the listed ranges:

Temperature:	15~35°C
Relative Humidity:	30~60 %
Air Pressure:	950~1050mba

4.4. Statement of the measurement uncertainty

Where relevant, the following measurement uncertainty levels have been estimated for tests performed on the Product as specified in CISPR 16-4-2. This uncertainty represents an expanded uncertainty expressed at approximately the 95% confidence level using a coverage factor of k=2

No.	Item	Measurement Uncertainty
1	Conducted emission 9KHz-150KHz	±3.8 dB
2	Conducted emission 150KHz-30MHz	±3.4 dB
3	Radiated emission 9KHz-30MHz	±4.9 dB
4	Radiated emission 30MHz-1GHz	±4.7 dB
5	Radiated emission 1GHz-18GHz	±5.1 dB
6	Radiated emission 18GHz-26GHz	±5.2 dB
7	Radiated emission 26GHz-40GHz	±5.2 dB

4.5. Equipments Used during the Test

Radiated Emission Test Equipment List						
Used	Equipment	Manufacturer	Model No.	Serial Number	Cal. date (mm dd, yyyy)	Cal. Due date (mm dd, yyyy)
<input checked="" type="checkbox"/>	3M Chamber & Accessory Equipment	ETS-LINDGREN	3M	N/A	Dec. 20, 2015	Dec. 19, 2018
<input checked="" type="checkbox"/>	Receiver	R&S	ESIB26	100114	Dec. 10, 2017	Dec. 10, 2018
<input checked="" type="checkbox"/>	Broadband Antenna	ETS-LINDGREN	3142E	00201566	Dec. 17, 2017	Dec. 17, 2018
<input checked="" type="checkbox"/>	Preamplifier	HP	8447F	2805A02960	Dec. 10, 2017	Dec. 10, 2018
<input checked="" type="checkbox"/>	Horn Antenna (Pre-amplifier)	ETS-LINDGREN	3117-PA	00201874	Dec. 17, 2017	Dec. 17, 2018
<input checked="" type="checkbox"/>	Multi device Controller	ETS-LINDGREN	7006-001	00160105	N/A	N/A
<input checked="" type="checkbox"/>	Band Rejection Filter (5150MHz~5880MHz)	Micro-Tronics	BRM50716	G1868	N/A	N/A
<input checked="" type="checkbox"/>	Test Software	Audix	e3	Software Version: 9.160323		

Conducted RF test Equipment List						
Used	Equipment	Manufacturer	Model No.	Serial Number	Cal. date (mm dd, yyyy)	Cal. Due date (mm dd, yyyy)
<input checked="" type="checkbox"/>	EXA Spectrum Analyzer	KEYSIGHT	N9010A	MY51440197	Dec. 10, 2017	Dec. 10, 2018
<input checked="" type="checkbox"/>	Receiver	R&S	ESR7	1316.3003K07-101181-K3	Dec. 10, 2017	Dec. 10, 2018
<input checked="" type="checkbox"/>	USB Wideband Power Sensor	KEYSIGHT	U2021XA	MY55430035	Dec. 10, 2017	Dec. 10, 2018
<input checked="" type="checkbox"/>	MXG X-Series RF Vector Signal Generator	KEYSIGHT	N5182B	MY51350267	Dec. 10, 2017	Dec. 10, 2018
<input checked="" type="checkbox"/>	Temp & Humidity chamber	Votisch	VT4002	58566133290020	Jun. 19, 2017	Jun. 18, 2018

Conducted Emission Test Equipment List						
Used	Equipment	Manufacturer	Model No.	Serial Number	Cal. date (mm dd, yyyy)	Cal. Due date (mm dd, yyyy)
<input checked="" type="checkbox"/>	Receiver	R&S	ESR7	1316.3003K07-101181-K3	Dec. 10, 2017	Dec. 10, 2018
<input checked="" type="checkbox"/>	Pulse Limiter	R&S	ESH3-Z2	0357.8810.54	Dec. 10, 2017	Dec. 10, 2018
<input checked="" type="checkbox"/>	LISN	R&S	ESH2-Z5	860014/024	Dec. 10, 2017	Dec. 10, 2018
<input checked="" type="checkbox"/>	Test Software	Audix	e3	Software Version: 9.160323		

5. TEST CONDITIONS AND RESULTS

5.1. Antenna requirement

Requirement

FCC CFR Title 47 Part 15 Subpart C Section 15.203:

An intentional radiator shall be designed to ensure that no antenna other than that furnished by the responsible party shall be used with the device. The use of a permanently attached antenna or of an antenna that uses a unique coupling to the intentional radiator, the manufacturer may design the unit so that a broken antenna can be replaced by the user, but the use of a standard antenna jack or electrical connector is prohibited.

Test Result:

The directional gain of the antenna less than 6 dBi, please refer to the below antenna photo.

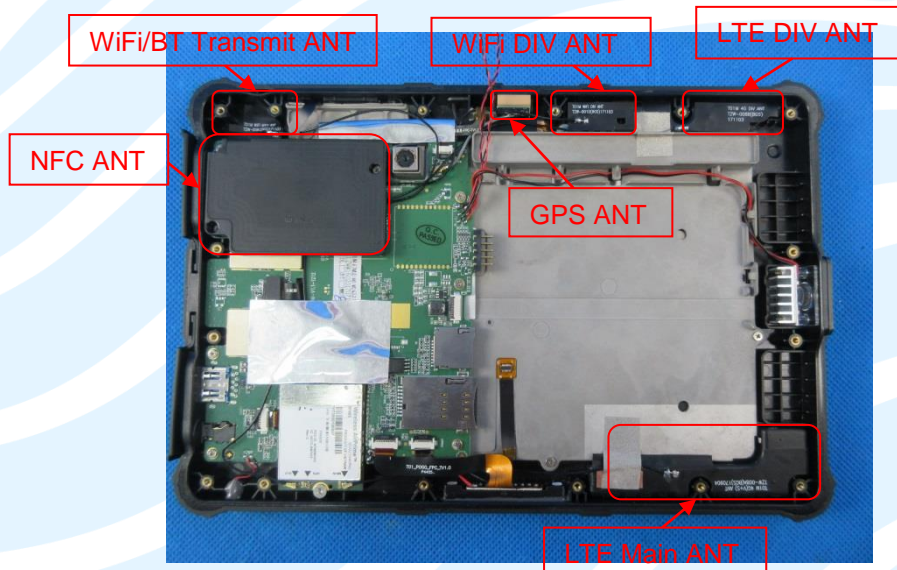

5.2. Conducted Emissions (AC Main)

LIMIT

FCC CFR Title 47 Part 15 Subpart C Section 15.207:

Frequency range (MHz)	Limit (dBuV)	
	Quasi-peak	Average
0.15-0.5	66 to 56*	56 to 46*
0.5-5	56	46
5-30	60	50

* Decreases with the logarithm of the frequency.

TEST CONFIGURATION

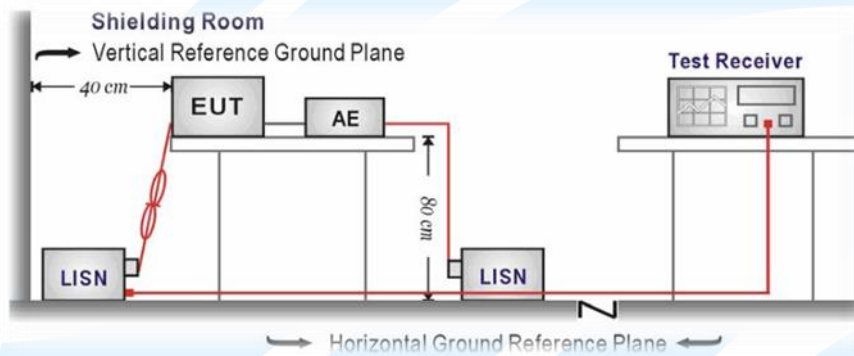

TEST PROCEDURE

1. The EUT was setup according to ANSI C63.10:2013 requirements.
2. The EUT was placed on a platform of nominal size, 1 m by 1.5 m, raised 80 cm above the conducting ground plane. The vertical conducting plane was located 40 cm to the rear of the EUT. All other surfaces of EUT were at least 80 cm from any other grounded conducting surface.
3. The EUT and simulators are connected to the main power through a line impedances stabilization network (LISN). The LISN provides a 50 ohm /50uH coupling impedance for the measuring equipment.
4. The peripheral devices are also connected to the main power through a LISN. (Please refer to the block diagram of the test setup and photographs)
5. Each current-carrying conductor of the EUT power cord, except the ground (safety) conductor, was individually connected through a LISN to the input power source.
6. The excess length of the power cord between the EUT and the LISN receptacle were folded back and forth at the center of the lead to form a bundle not exceeding 40 cm in length.
7. Conducted Emissions were investigated over the frequency range from 0.15MHz to 30MHz using a receiver bandwidth of 9 kHz.
8. During the above scans, the emissions were maximized by cable manipulation.

TEST MODE:

Please refer to the clause 3.3

TEST RESULTS

Passed Not Applicable

Note:

- 1) Transd=Cable lose+ Pulse Limiter Factor + Artificial Mains Factor
- 2) Margin= Limit -Level

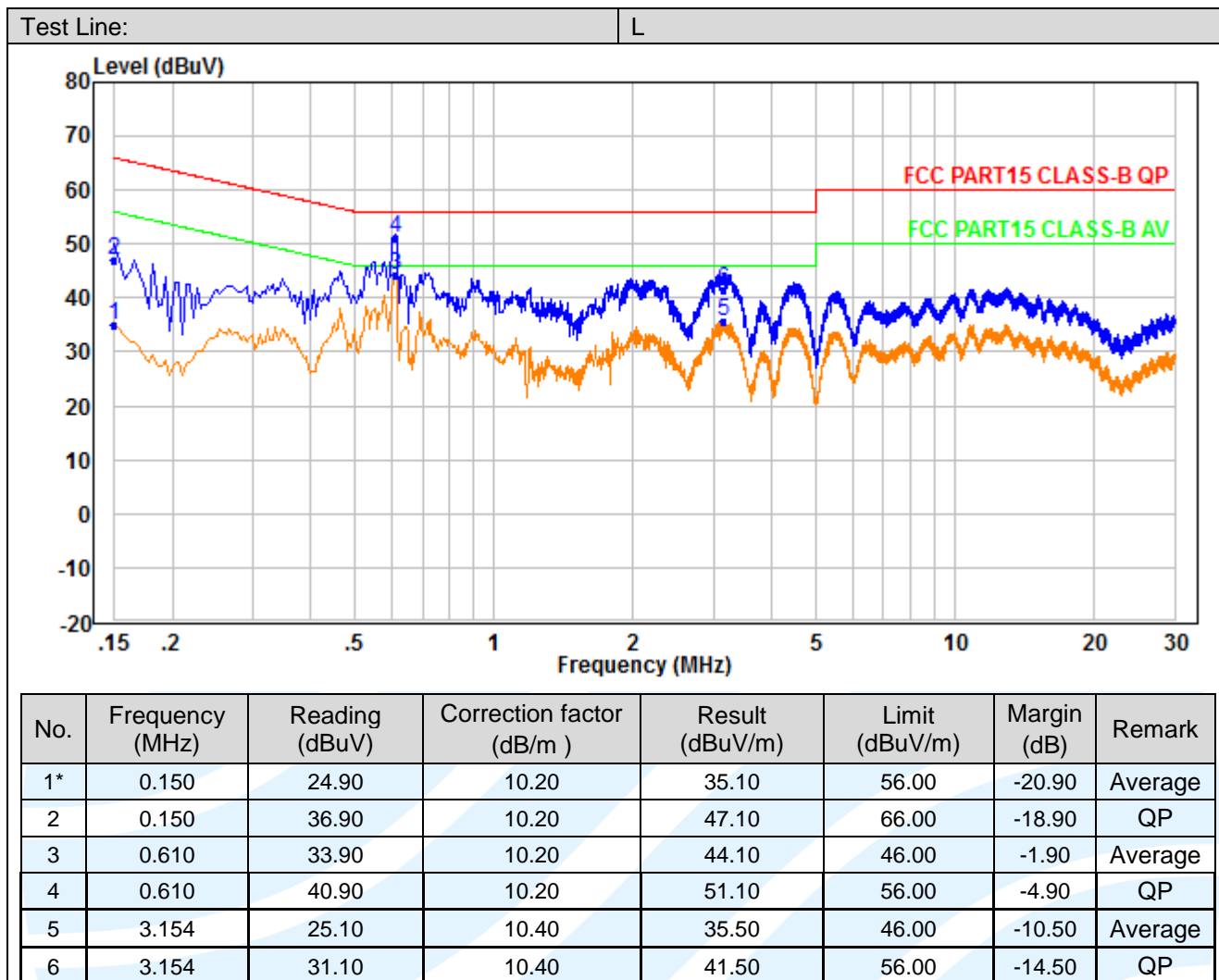

Test Line: N

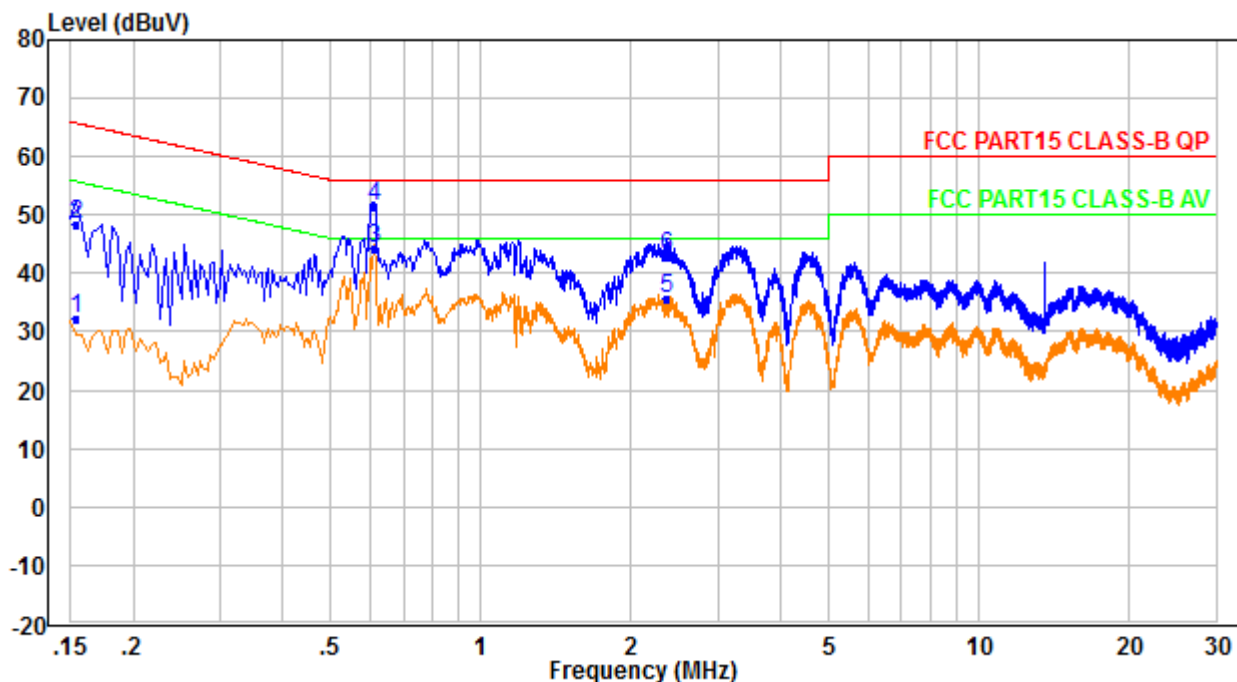

No.	Frequency (MHz)	Reading (dBuV)	Correction factor (dB/m)	Result (dBuV/m)	Limit (dBuV/m)	Margin (dB)	Remark
1*	0.154	22.20	10.20	32.40	55.80	-23.40	Average
2	0.154	38.20	10.20	48.40	65.80	-17.40	QP
3	0.610	33.70	10.40	44.10	46.00	-1.90	Average
4	0.610	41.00	10.40	51.40	56.00	-4.60	QP
5	2.366	25.20	10.50	35.70	46.00	-10.30	Average
6	2.366	32.20	10.50	42.70	56.00	-13.30	QP

Remark:
Margin=Limit -Level

5.3. Maximum Conducted Output Power

LIMIT

FCC CFR Title 47 Part 15 Subpart E Section 15.407(a):

For the 5.15~5.25GHz band:

- Outdoor AP
The maximum conducted output power (P_{out}) shall not exceed the lesser of 1W (30dBm).
if $G_{Tx} > 6\text{dBi}$, then $P_{out} = 30 - (G_{Tx} - 6)$. e.i.r.p. at any elevation angle above 30 degrees $\leq 125\text{mW}$ (21dBm)
- Indoor AP
The maximum conducted output power (P_{out}) shall not exceed the lesser of 1W (30dBm).
if $G_{Tx} > 6\text{dBi}$, then $P_{out} = 30 - (G_{Tx} - 6)$.
- Point-to-point AP
The maximum conducted output power (P_{out}) shall not exceed the lesser of 1W (30dBm).
if $G_{Tx} > 23\text{dBi}$, then $P_{out} = 30 - (G_{Tx} - 23)$.
- Client devices
The maximum conducted output power (P_{out}) shall not exceed the lesser of 250W (24dBm).
if $G_{Tx} > 6\text{dBi}$, then $P_{out} = 24 - (G_{Tx} - 6)$.

For the 5.25~5.35GHz band:

The maximum conducted output power (P_{out}) shall not exceed the lesser of 250mW (24dBm) or 11dBm+10 log B, where B is the 26dB emission bandwidth in MHz.
if $G_{Tx} > 6\text{dBi}$, then $P_{out} = 24 - (G_{Tx} - 6)$.

For the 5.47~5.725GHz band:

The maximum conducted output power (P_{out}) shall not exceed the lesser of 250mW (24dBm) or 11dBm+10 log B, where B is the 26dB emission bandwidth in MHz.
if $G_{Tx} > 6\text{dBi}$, then $P_{out} = 24 - (G_{Tx} - 6)$.

For the 5.725~5.85GHz band:

- Point-to-multipoint systems (P2M)
The maximum conducted output power (P_{out}) shall not exceed the lesser of 1W (30dBm).
if $G_{Tx} > 6\text{dBi}$, then $P_{out} = 30 - (G_{Tx} - 6)$.
- Point-to-point systems (P2P)
The maximum conducted output power (P_{out}) shall not exceed the lesser of 1W (30dBm).

TEST CONFIGURATION

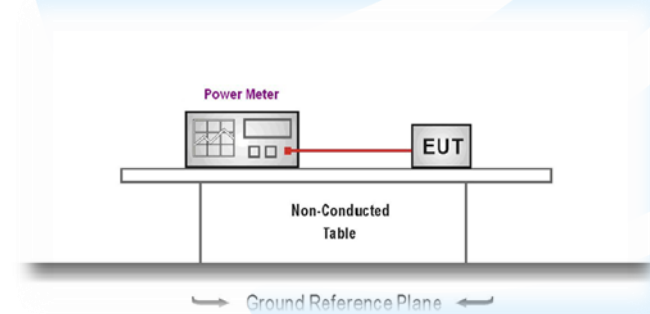

TEST PROCEDURE

1. The EUT was tested according to KDB789033 Section E-3-b)
2. The maximum conducted output power may be measured using a broadband AVG RF power meter.
3. Average power measurements were performed only when the EUT was transmitting at its maximum power control level using a broadband power meter with a pulse sensor.
4. The power meter implemented triggering and gating capabilities which were set up such that power measurements were recorded only during the ON time of the transmitter.
5. Record the measurement data.

TEST MODE:

Please refer to the clause 3.3

Shenzhen UnionTrust Quality and Technology Co., Ltd.

Address: 16/F, Block A, Building 6, Baoneng Science and Technology Park, Qingxiang Road No.1, Longhua New District, Shenzhen, China
Tel: +86-755-28230888 Fax: +86-755-28230886 E-mail: info@uttlab.com [Http://www.uttlab.com](http://www.uttlab.com)

TEST RESULTS
 Passed Not Applicable

Band	Bandwidth (MHz)	Type	Channel	Conducted Output Power (dBm)	Limit (dBm)	Result
I	20	802.11ac	CH _L	13.51	24.00	Pass
			CH _M	13.55		
			CH _H	13.38		
	40	802.11ac	CH _L	12.00	24.00	Pass
			CH _H	11.99		
	80	802.11ac	CH _M	10.53	24.00	Pass
II	20	802.11ac	CH _L	12.75	24.00	Pass
			CH _M	12.45		
			CH _H	12.71		
	40	802.11ac	CH _L	11.72	24.00	Pass
			CH _H	11.33		
	80	802.11ac	CH _M	9.77	24.00	Pass

Band	Bandwidth (MHz)	Type	Channel	Conducted Output Power (dBm)	Limit (dBm)	Result
III	20	802.11ac	CH _L	12.50	24.00	Pass
			CH _M	11.78		
			CH _H	12.13		
	40	802.11ac	CH _L	11.00	24.00	Pass
			CH _M	11.14		
			CH _H	11.69		
80	802.11ac	CH _L	9.63	24.00	Pass	
		CH _H	9.99			
IV	20	802.11ac	CH _L	12.16	30.00	Pass
			CH _M	12.37		
			CH _H	12.20		
	40	802.11ac	CH _L	11.75	30.00	Pass
			CH _H	11.08		
	80	802.11ac	CH _M	9.21	30.00	Pass

5.4. Maximum Power Spectral Density

LIMIT

FCC CFR Title 47 Part 15 Subpart E Section 15.407(a):

For the 5.15~5.25GHz band:

- Outdoor AP
The peak power spectral density (PSD) shall not exceed the lesser of 17dBm/MHz.
if $G_{TX} > 6\text{dBi}$, then $\text{PSD} = 17 - (G_{TX} - 6)$.
- Indoor AP
The peak power spectral density (PSD) shall not exceed the lesser of 17dBm/MHz.
if $G_{TX} > 6\text{dBi}$, then $\text{PSD} = 17 - (G_{TX} - 6)$.
- Point-to-point AP
The peak power spectral density (PSD) shall not exceed the lesser of 17dBm/MHz.
if $G_{TX} > 23\text{dBi}$, then $\text{PSD} = 17 - (G_{TX} - 23)$.
- Client devices
The peak power spectral density (PSD) shall not exceed the lesser of 11dBm/MHz.
if $G_{TX} > 6\text{dBi}$, then $\text{PSD} = 11 - (G_{TX} - 6)$.

For the 5.25~5.35GHz band:

The peak power spectral density (PSD) shall not exceed the lesser of 11dBm/MHz.
if $G_{TX} > 6\text{dBi}$, then $\text{PSD} = 11 - (G_{TX} - 6)$.

For the 5.47~5.725GHz band:

The peak power spectral density (PSD) shall not exceed the lesser of 11dBm/MHz.
if $G_{TX} > 6\text{dBi}$, then $\text{PSD} = 11 - (G_{TX} - 6)$.

For the 5.725~5.85GHz band:

- Point-to-multipoint systems (P2M)
The peak power spectral density (PSD) shall not exceed the lesser of 30dBm/500kHz.
if $G_{TX} > 6\text{dBi}$, then $\text{PSD} = 30 - (G_{TX} - 6)$.
- Point-to-point systems (P2P)
The peak power spectral density (PSD) shall not exceed the lesser of 30dBm/500kHz.

TEST CONFIGURATION

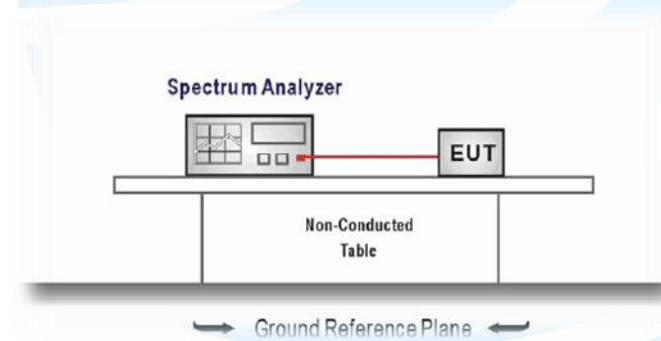

TEST PROCEDURE

1. According KDB 789033 D02 – Section F
2. Analyzer was setting as follow:
Center frequency: test channel
Span was set to encompass the entire emission bandwidth of the signal
RBW=1MHz for devices operating in the bands 5.15-5.25 GHz, 5.25-5.35 GHz, and 5.47-5.725 GHz
RBW=500kHz for devices operating in the band 5.725-5.85 GHz
VBW ≥ 3 RBW
Number of sweep points > 2 x (span/RBW)
Sweep time = auto
Detector = Peak
Trigger was set to free run for all modes, trace was averaged over 100 sweeps
3. The peak search function of the spectrum analyzer was used to find the peak of the spectrum.

TEST MODE:

Please refer to the clause 3.3

Shenzhen UnionTrust Quality and Technology Co., Ltd.

Address: 16/F, Block A, Building 6, Baoneng Science and Technology Park, Qingxiang Road No.1, Longhua New District, Shenzhen, China
Tel: +86-755-28230888 Fax: +86-755-28230886 E-mail: info@uttlab.com [Http://www.uttlab.com](http://www.uttlab.com)

TEST RESULTS
 Passed Not Applicable

Band	Bandwidth (MHz)	Type	Channel	Power Spectral Density (dBm/MHz)	Limit (dBm/1MHz)	Result
I	20	802.11ac	CH _L	1.96	11.00	Pass
			CH _M	4.24		
			CH _H	3.40		
	40	802.11ac	CH _L	-0.42	11.00	Pass
			CH _H	-0.71		
	80	802.11ac	CH _M	-4.56	11.00	Pass
II	20	802.11ac	CH _L	6.37	11.00	Pass
			CH _M	2.50		
			CH _H	2.43		
	40	802.11ac	CH _L	-0.84	11.00	Pass
			CH _H	-1.33		
	80	802.11ac	CH _M	-5.52	11.00	Pass

Band	Bandwidth (MHz)	Type	Channel	Power Spectral Density (dBm/MHz)	Limit (dBm/1MHz)	Result
III	20	802.11ac	CH _L	1.96	11.00	Pass
			CH _M	1.04		
			CH _H	0.45		
	40	802.11ac	CH _L	-1.70	11.00	Pass
			CH _M	-2.83		
			CH _H	0.22		
80	802.11ac	CH _L	-5.54	11.00	Pass	
		CH _H	-5.55			

Band	Bandwidth (MHz)	Type	Channel	Power Spectral Density (dBm/500kHz)	Limit (dBm/500kHz)	Result
IV	20	802.11ac	CH _L	1.22	30.00	Pass
			CH _M	0.94		
			CH _H	-0.16		
	40	802.11ac	CH _L	-4.17	30.00	Pass
			CH _H	-4.51		
	80	802.11ac	CH _M	-6.27	30.00	Pass

Test plot as follows:

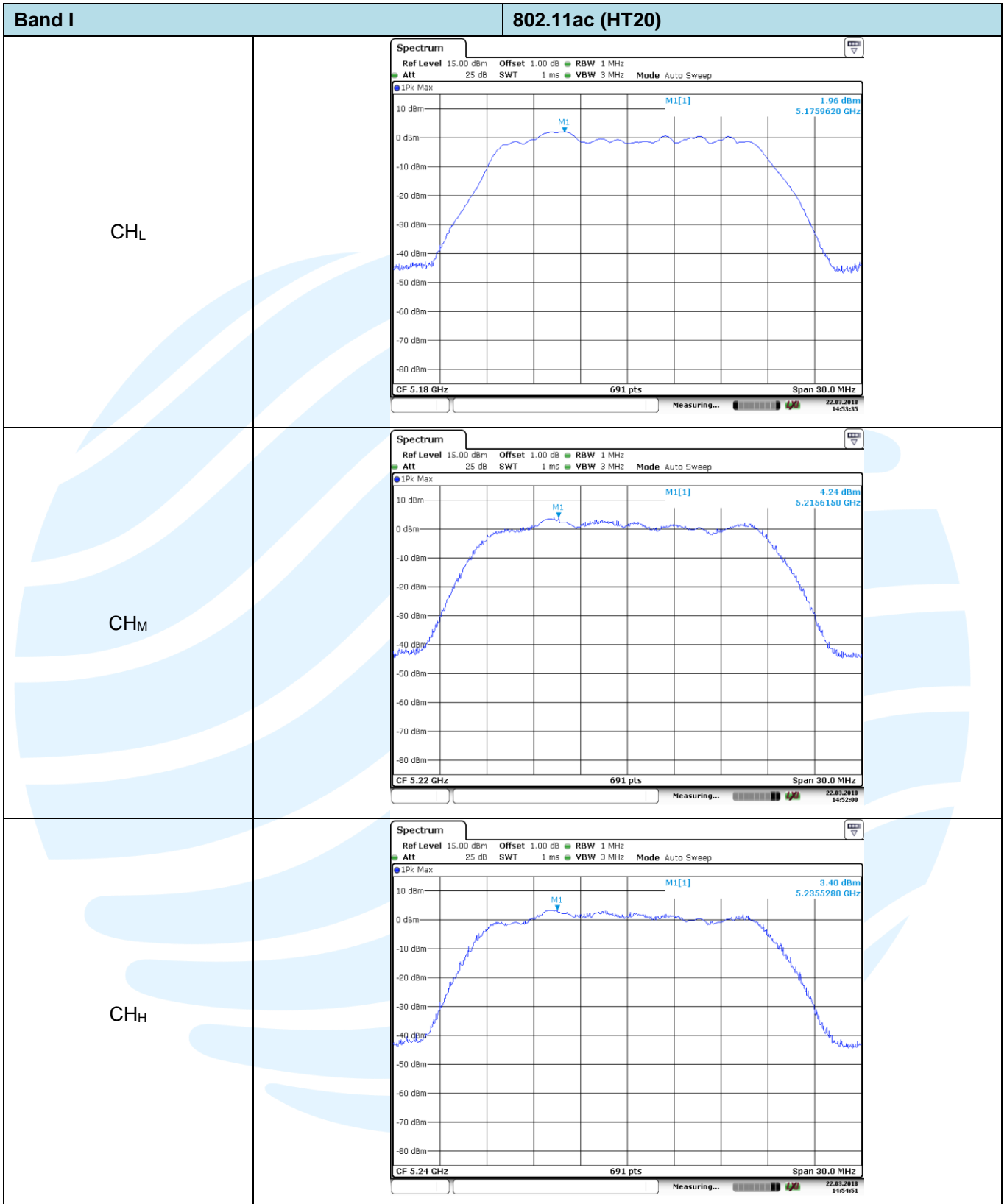

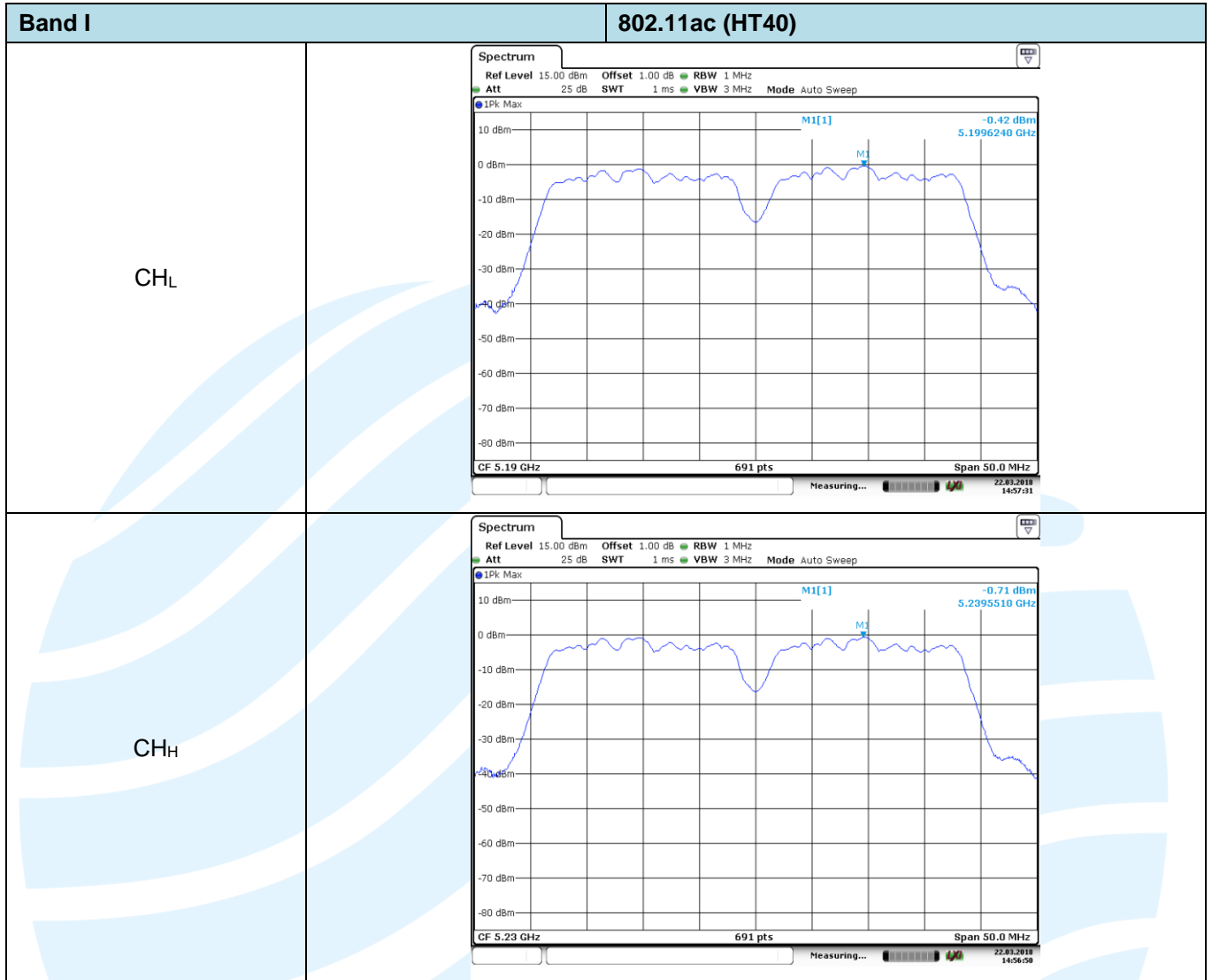

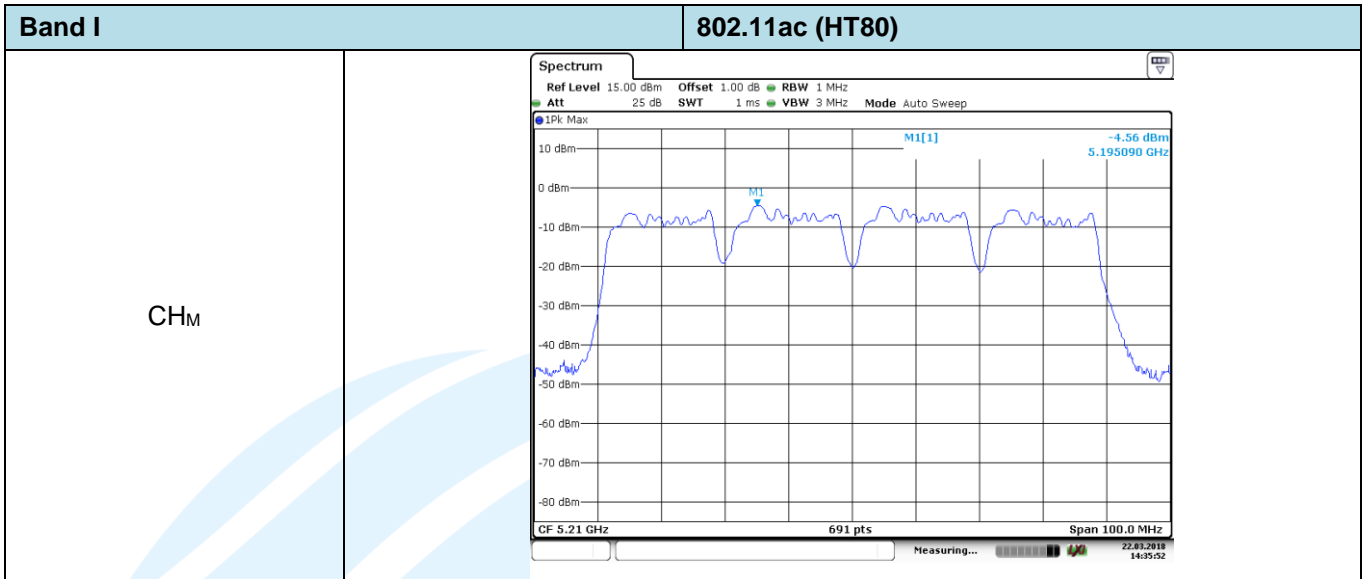

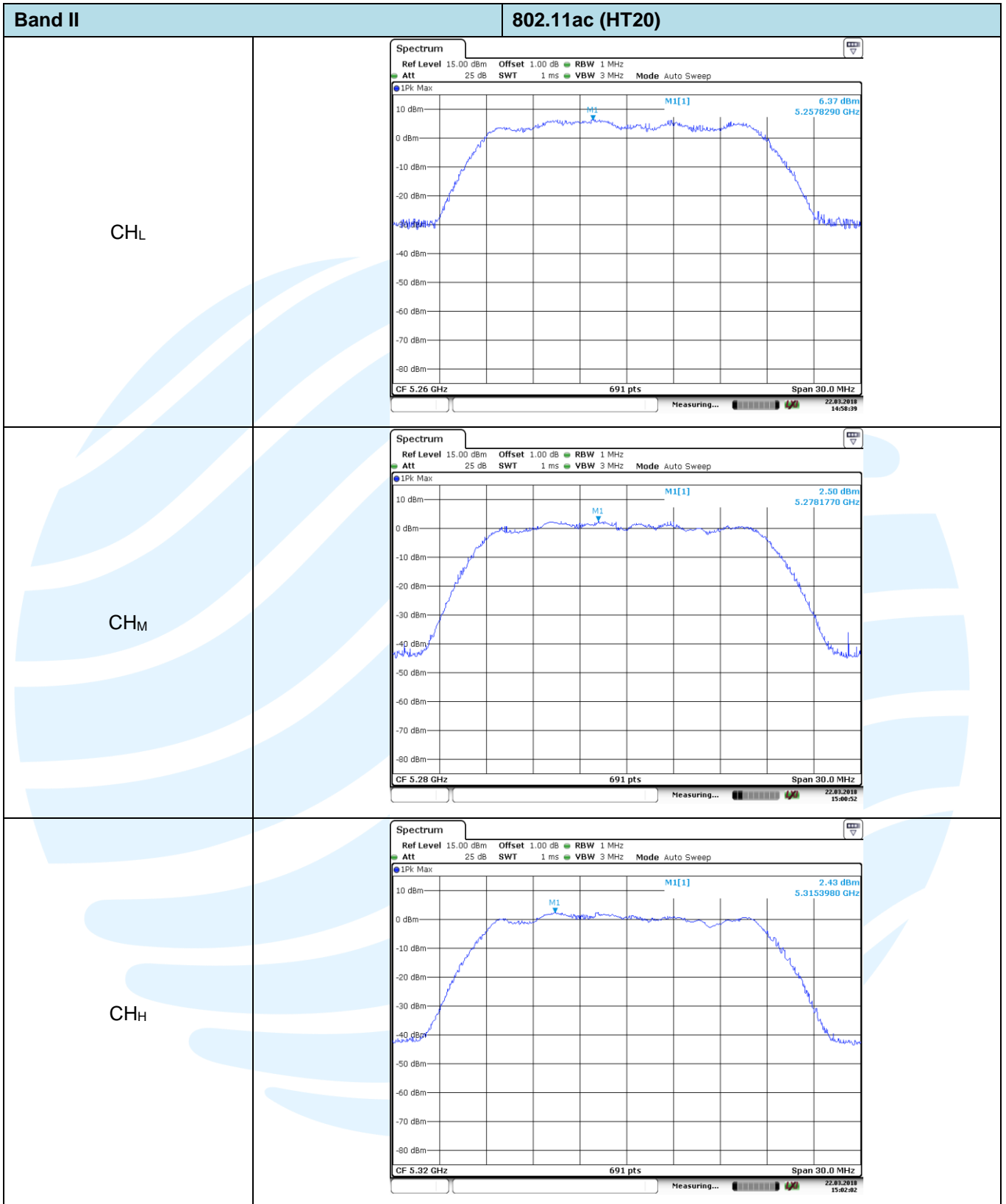

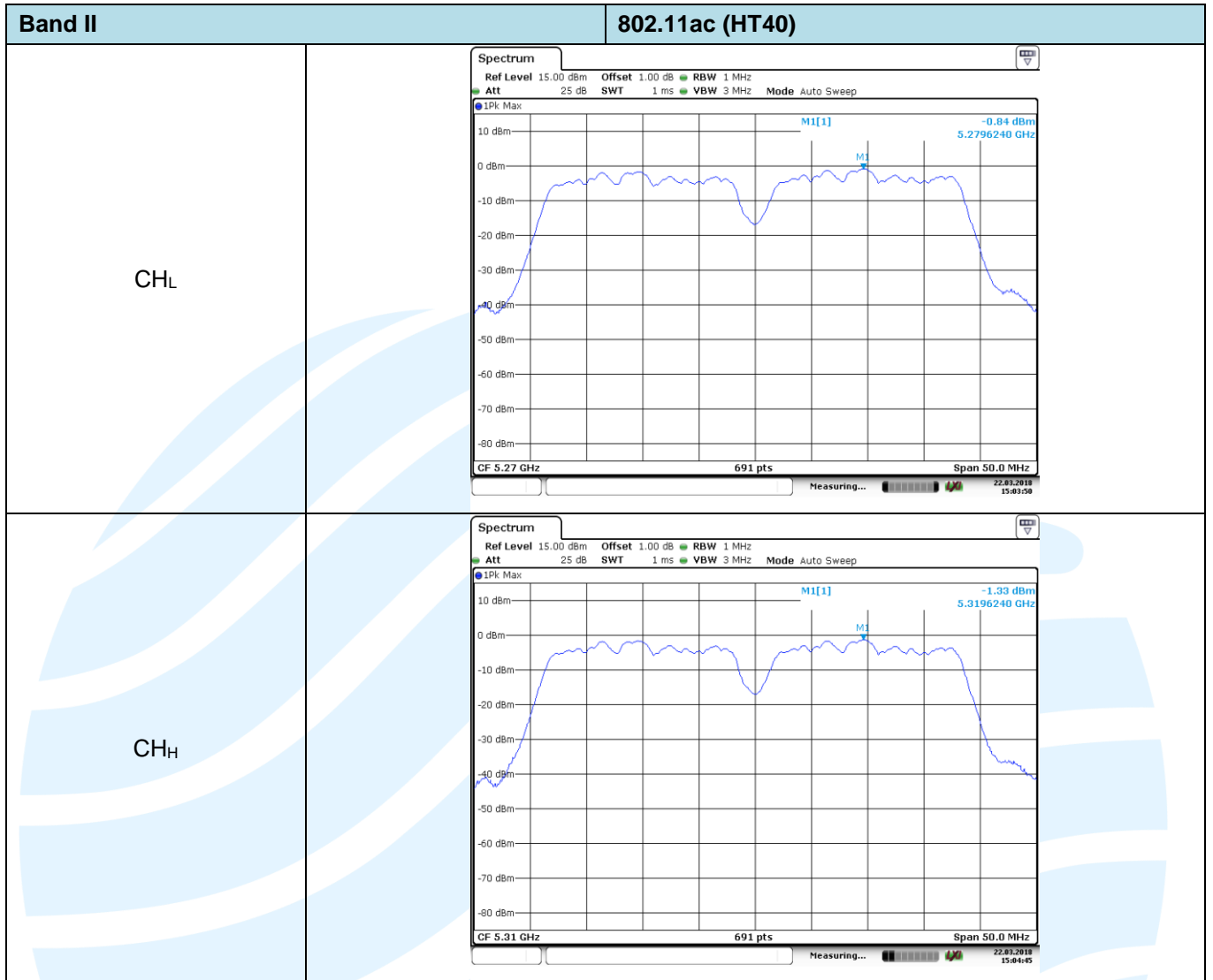

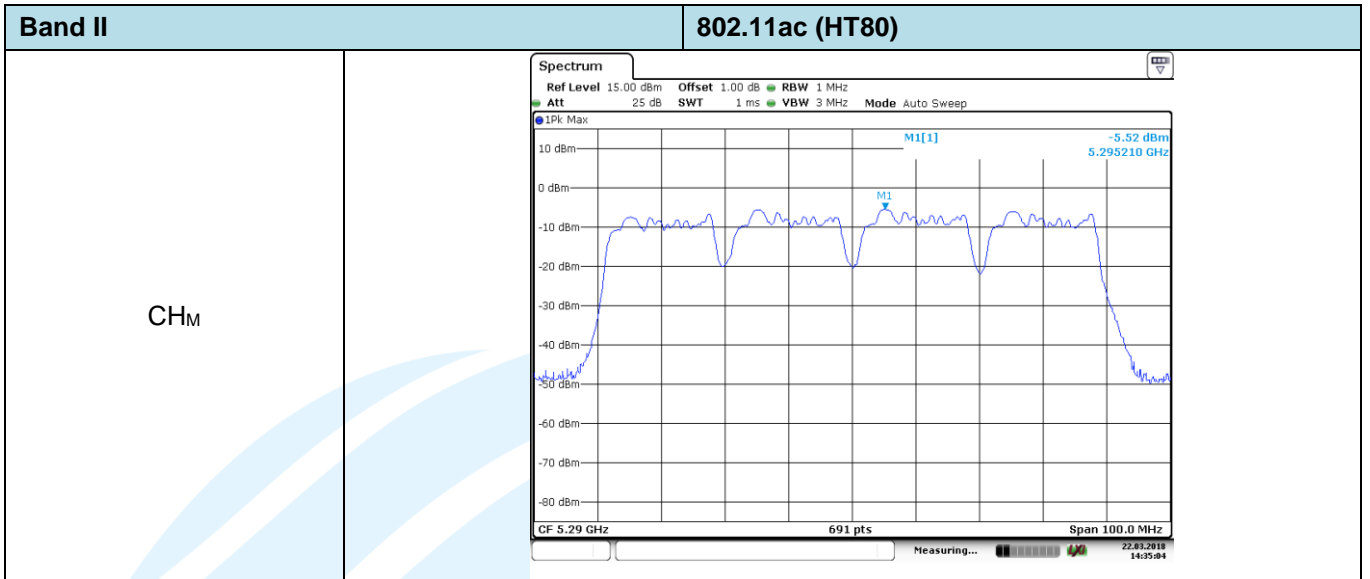

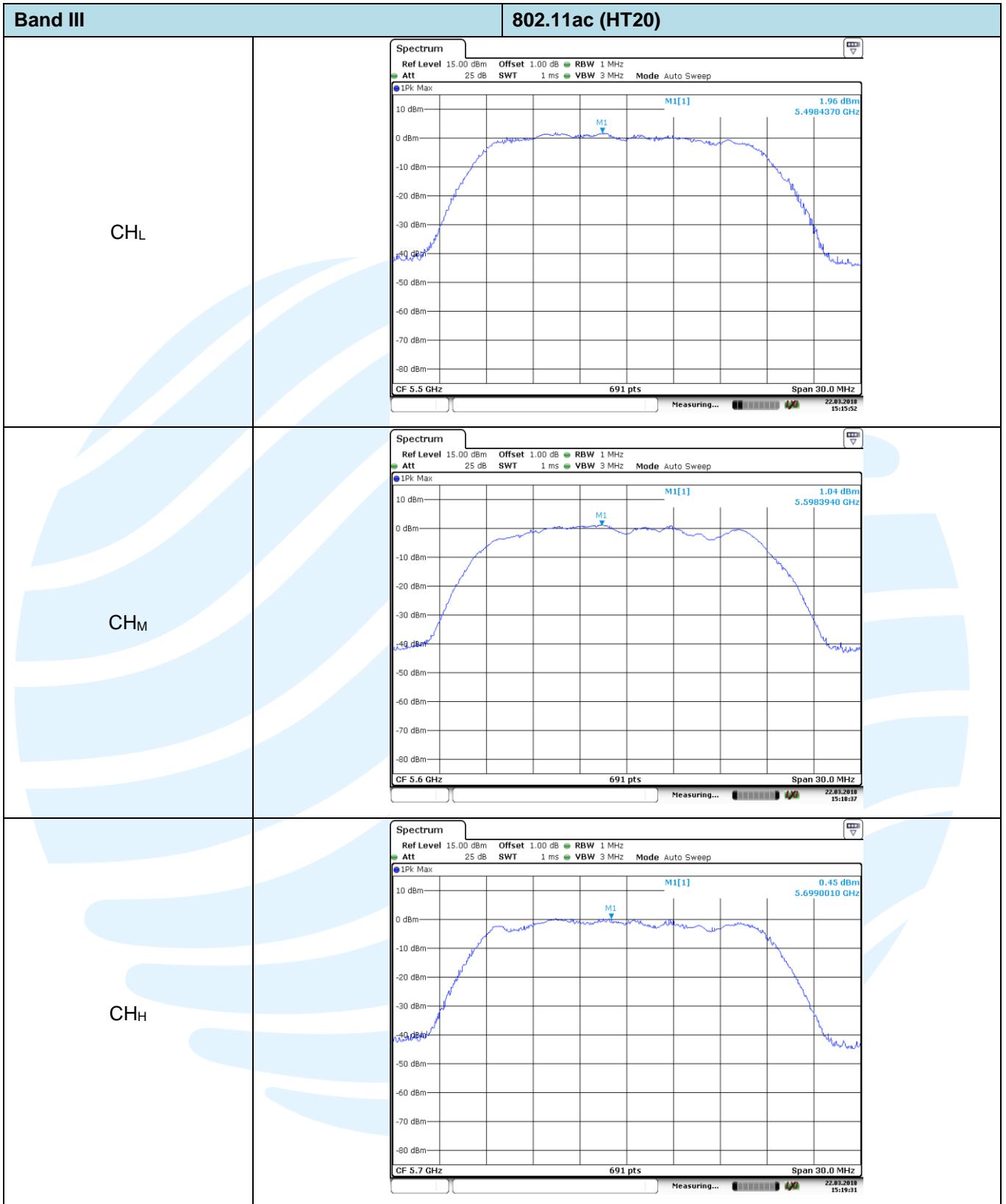

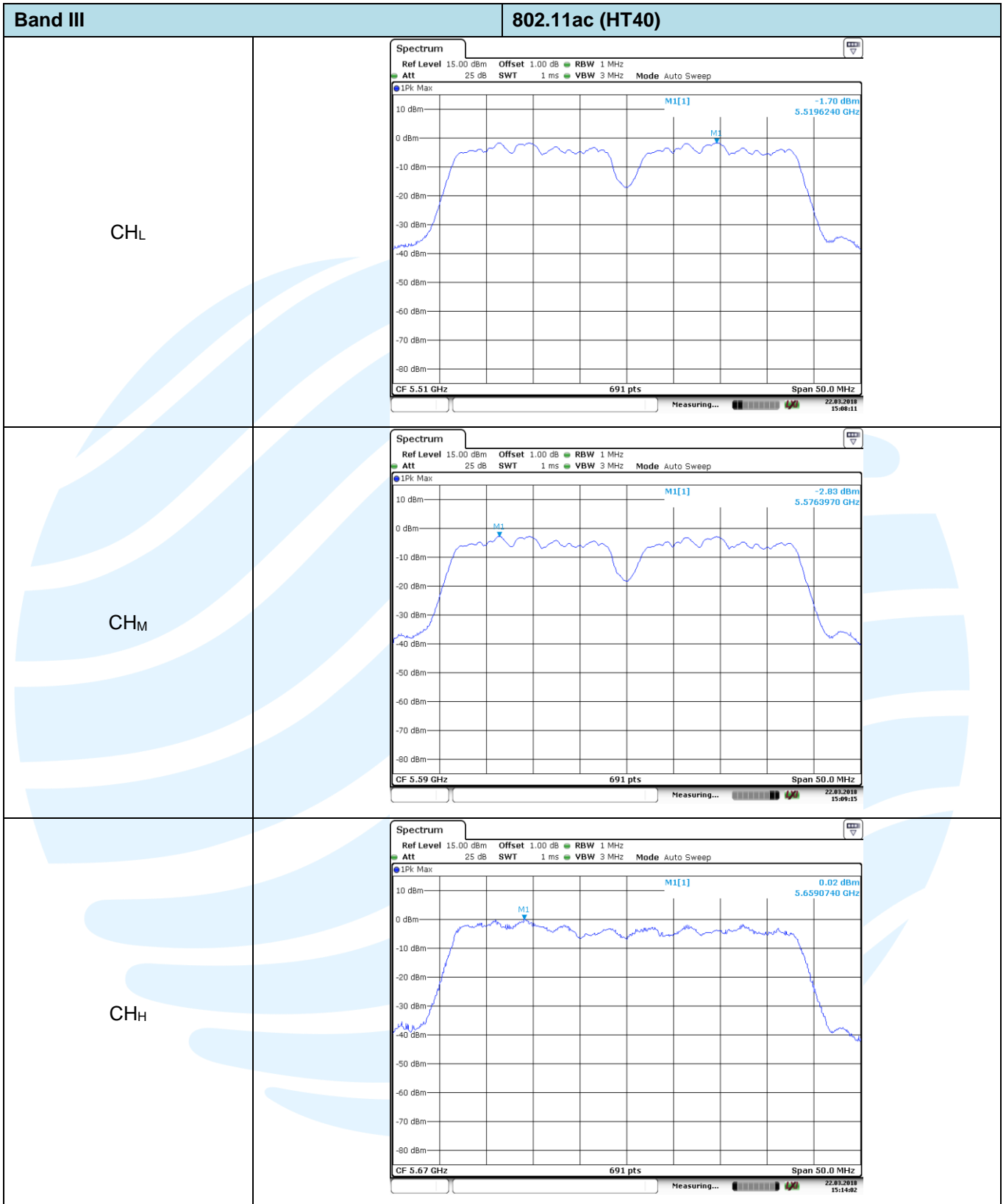

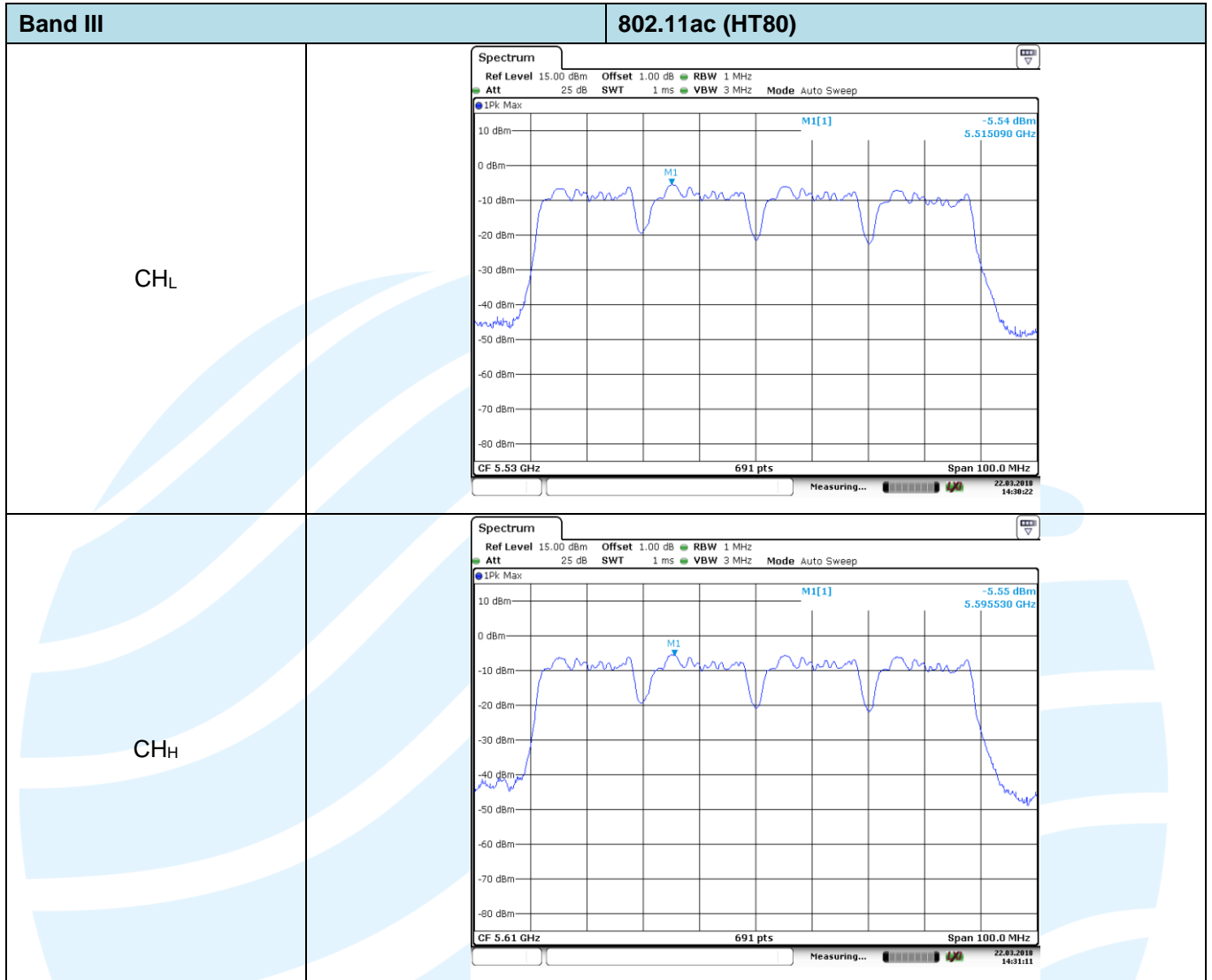

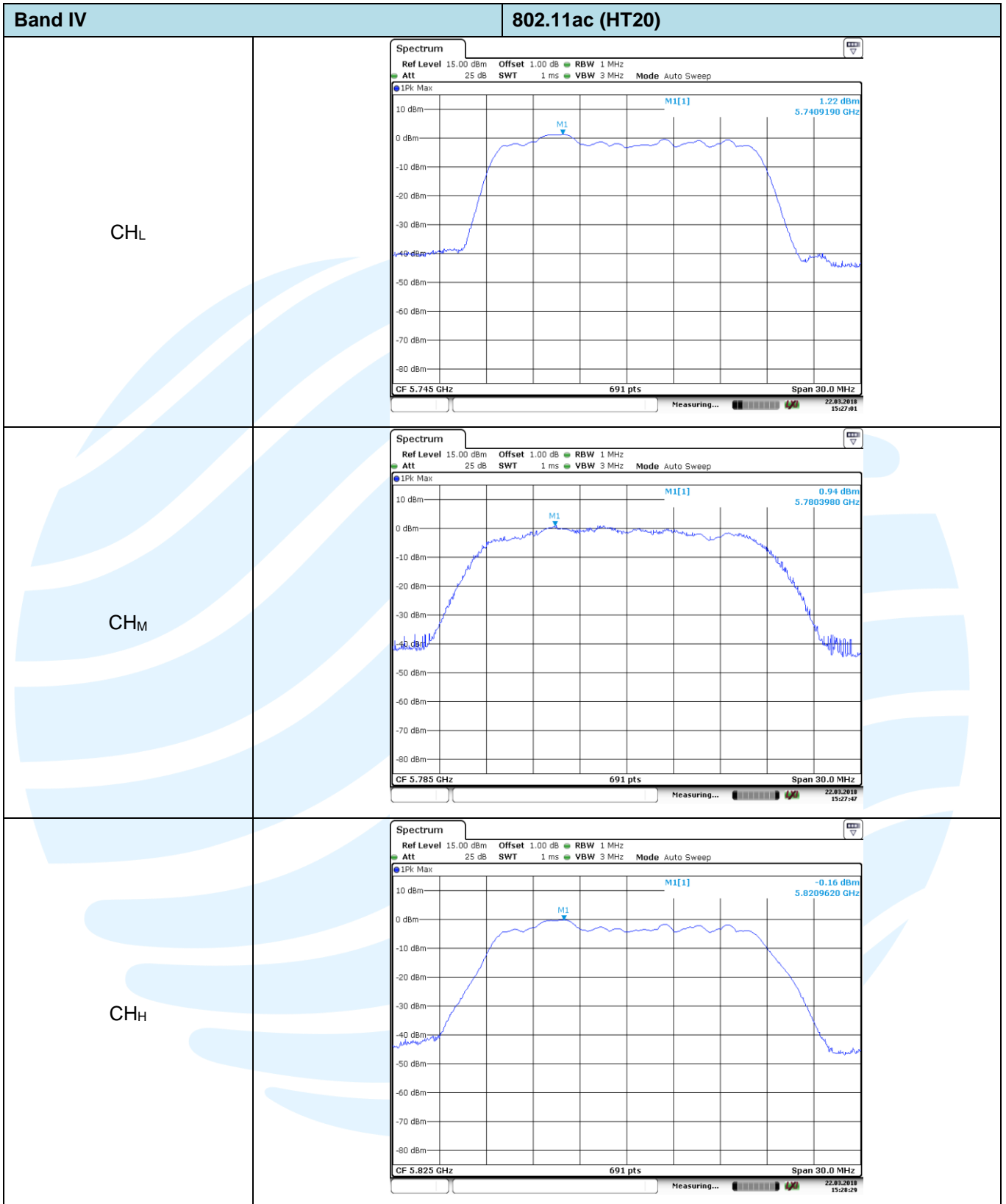

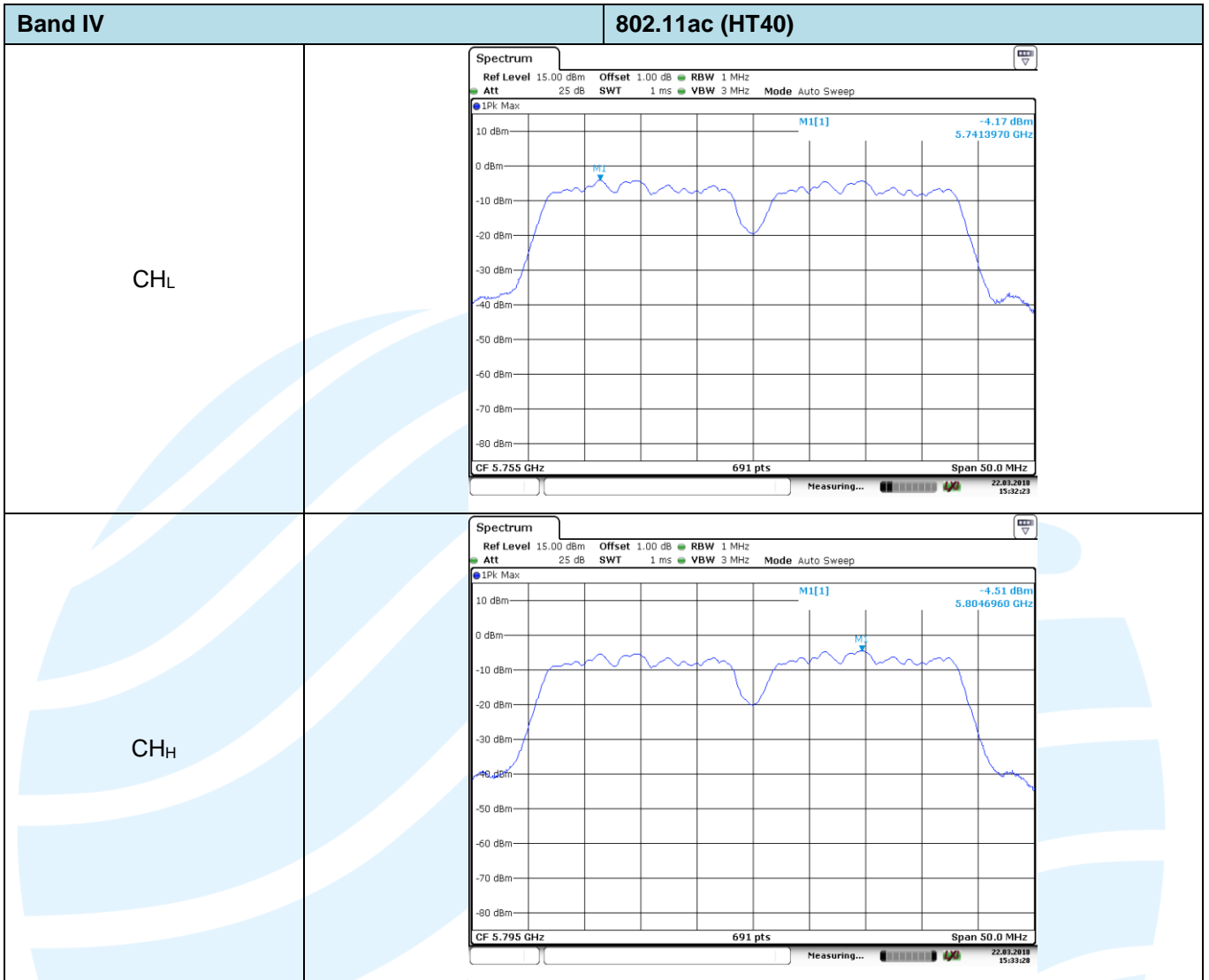

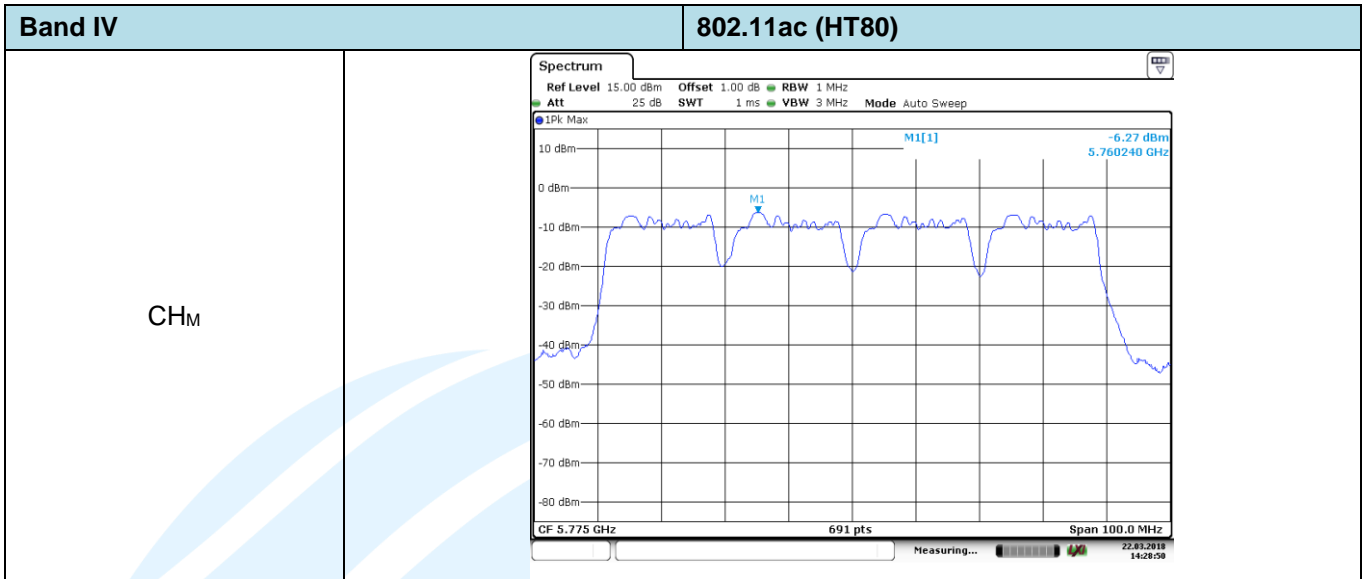

5.5. 26dB bandwidth and 99% Occupancy bandwidth

LIMIT

The bandwidth at 26dB down from the highest in-band spectral density is measured with a spectrum analyzer connected to the antenna terminal while the EUT is operating at its maximum duty cycle, at its maximum power control level, as defined in KDB 789033 D02 , and at the appropriate frequencies. The spectrum analyzer's bandwidth measurement function is configured to measure the 26dB bandwidth.

TEST CONFIGURATION

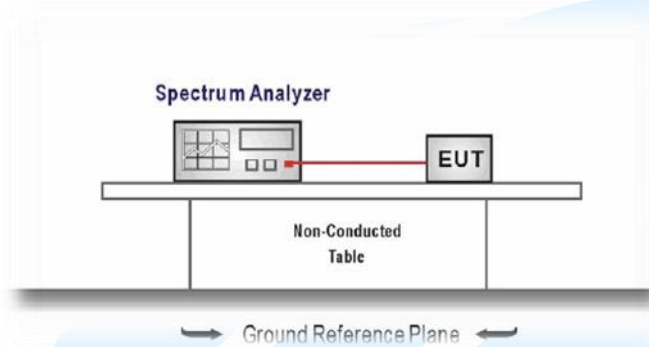

TEST PROCEDURE

1. According KDB 789033 D02 – Section C
2. Connect the antenna port(s) to the spectrum analyzer input.
3. Configure the spectrum analyzer as shown below (enter all losses between the transmitter output and the spectrum analyzer).
Center Frequency =Channel center frequency
Span=2 x emission bandwidth
RBW = 1% to 5% of the emission bandwidth
VBW>3 x RBW
Sweep time= auto couple
Detector = Peak
Trace mode = max hold
4. Place the radio in continuous transmit mode, allow the trace to stabilize, view the transmitter wave form on the spectrum analyzer.
5. Measure the maximum width of the emission that is 26 dB down from the maximum of the emission, and use the 99 % power bandwidth function of the instrument

TEST MODE:

Please refer to the clause 3.3

TEST RESULTS

Passed Not Applicable

Band	Bandwidth (MHz)	Type	Channel	99% Occupy bandwidth (MHz)	26dB bandwidth (MHz)	Result
I	20	802.11ac	CH _L	16.54	19.54	Pass
			CH _M	17.81	20.97	
			CH _H	17.76	21.01	
	40	802.11ac	CH _L	36.40	39.94	Pass
			CH _H	36.40	39.65	
	80	802.11ac	CH _M	75.83	80.32	Pass
II	20	802.11ac	CH _L	17.76	21.06	Pass
			CH _M	17.89	21.19	
			CH _H	17.63	21.14	
	40	802.11ac	CH _L	36.40	39.87	Pass
			CH _H	36.40	39.94	
	80	802.11ac	CH _M	75.83	80.75	Pass

Band	Bandwidth (MHz)	Type	Channel	99% Occupy bandwidth (MHz)	26dB bandwidth (MHz)	Result
III	20	802.11ac	CH _L	17.63	21.14	Pass
			CH _M	16.54	19.93	
			CH _H	17.84	21.32	
	40	802.11ac	CH _L	36.40	40.09	Pass
			CH _M	36.47	40.09	
			CH _H	36.47	40.23	
80	802.11ac	CH _L	75.98	84.37	Pass	
		CH _H	76.12	81.04		



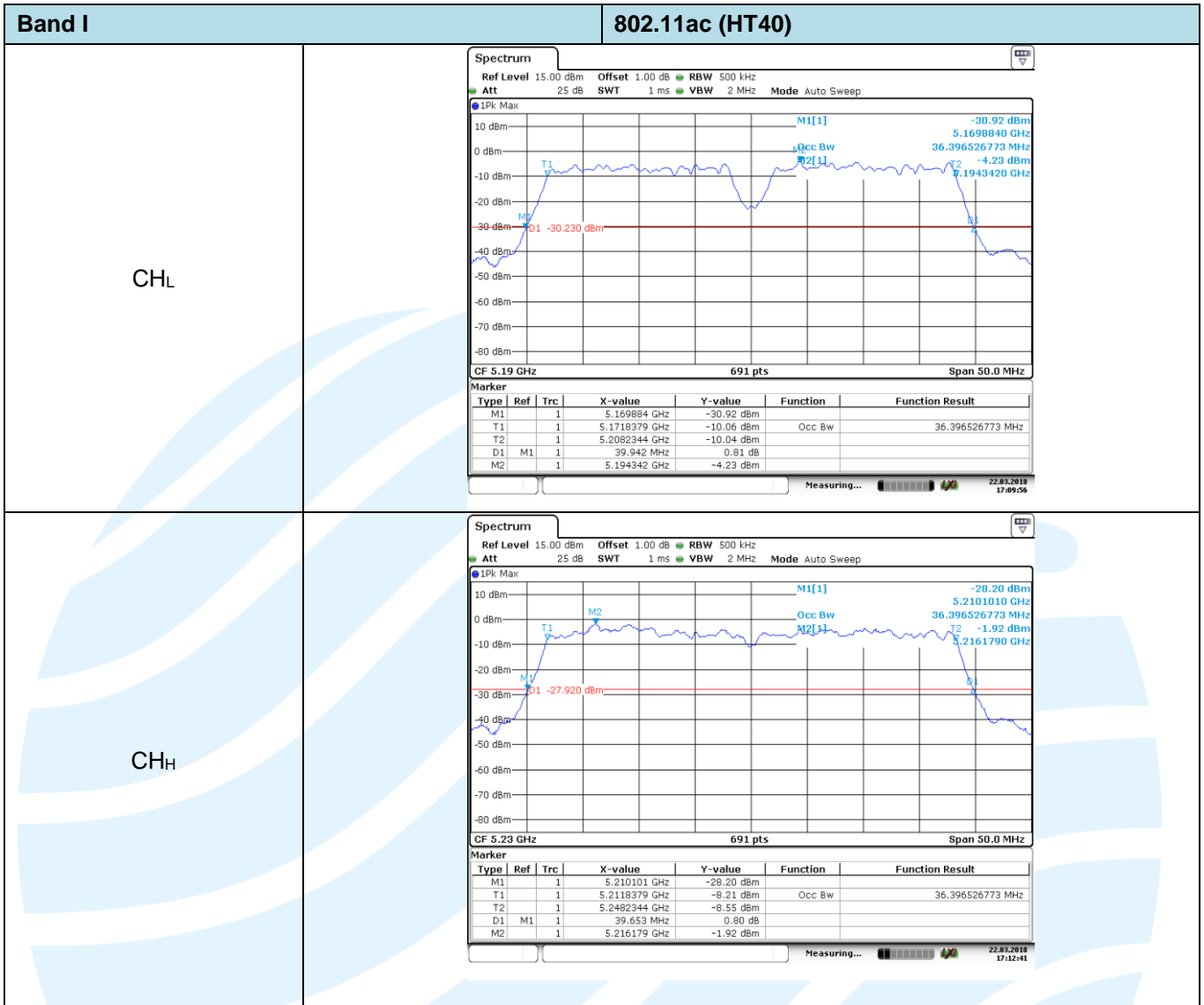

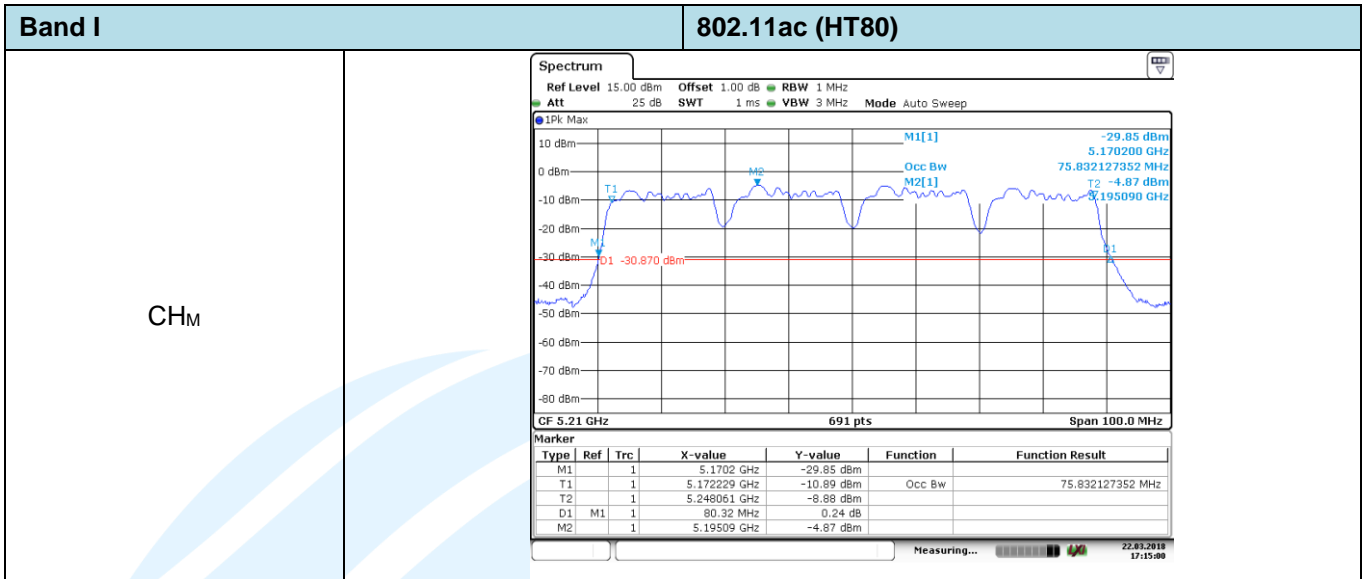

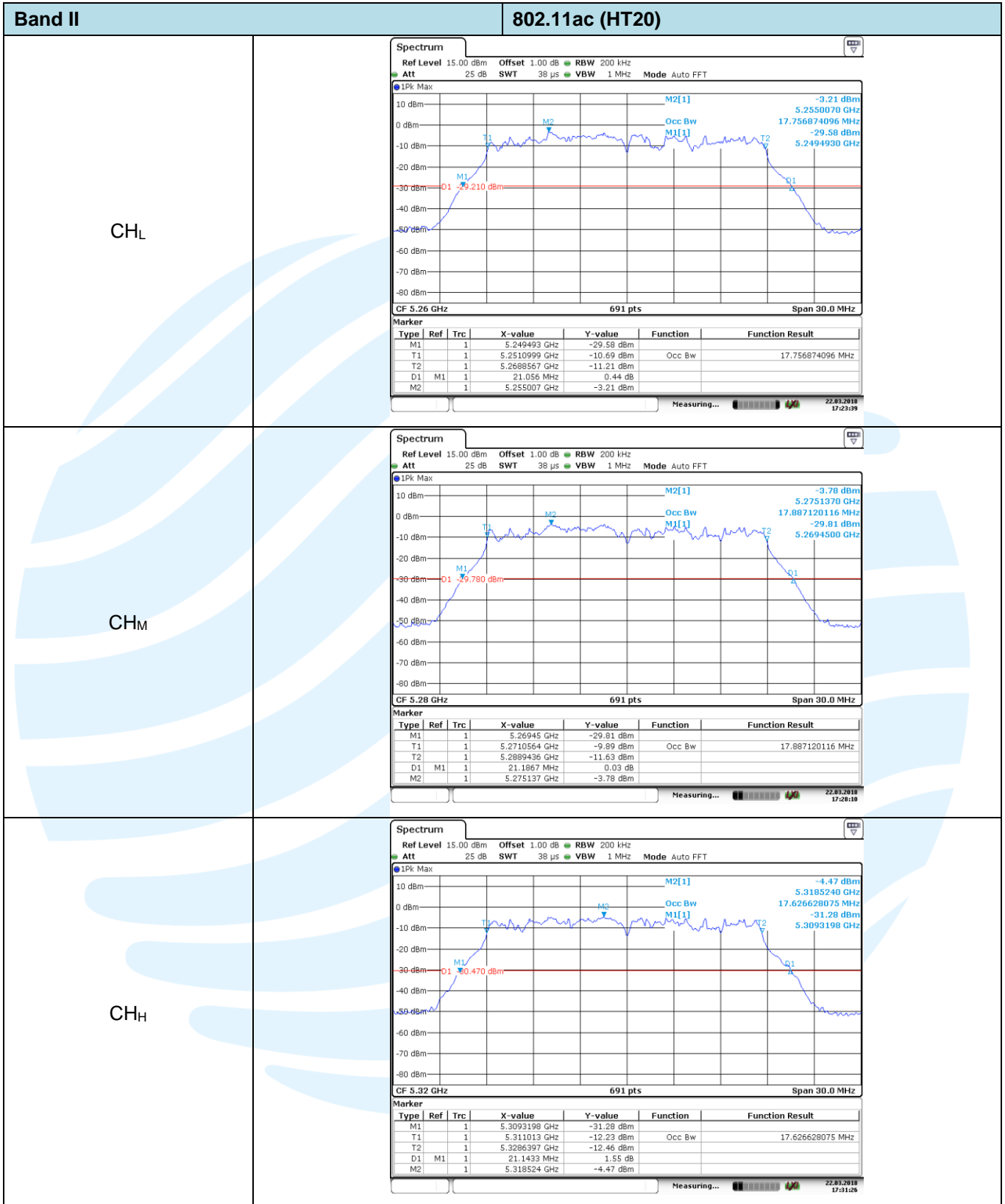

Band II **802.11ac (HT40)**

CH_L

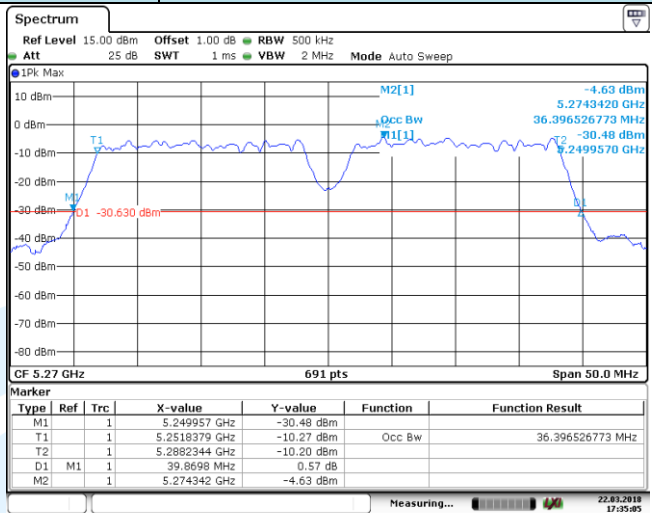

CH_H

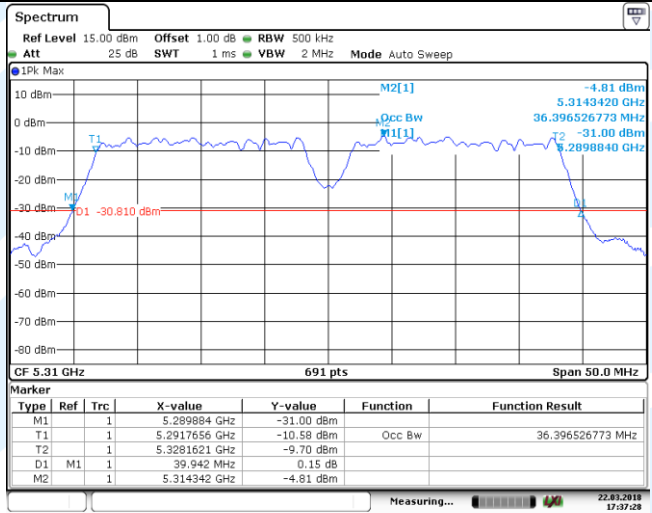

Band II

802.11ac (HT80)

CH_M

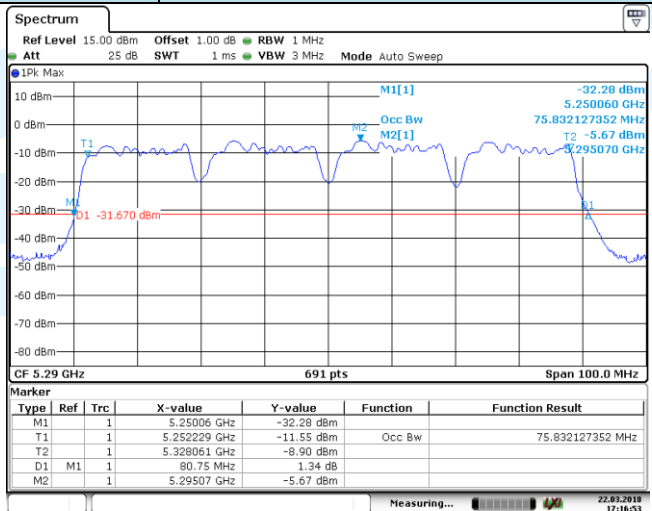

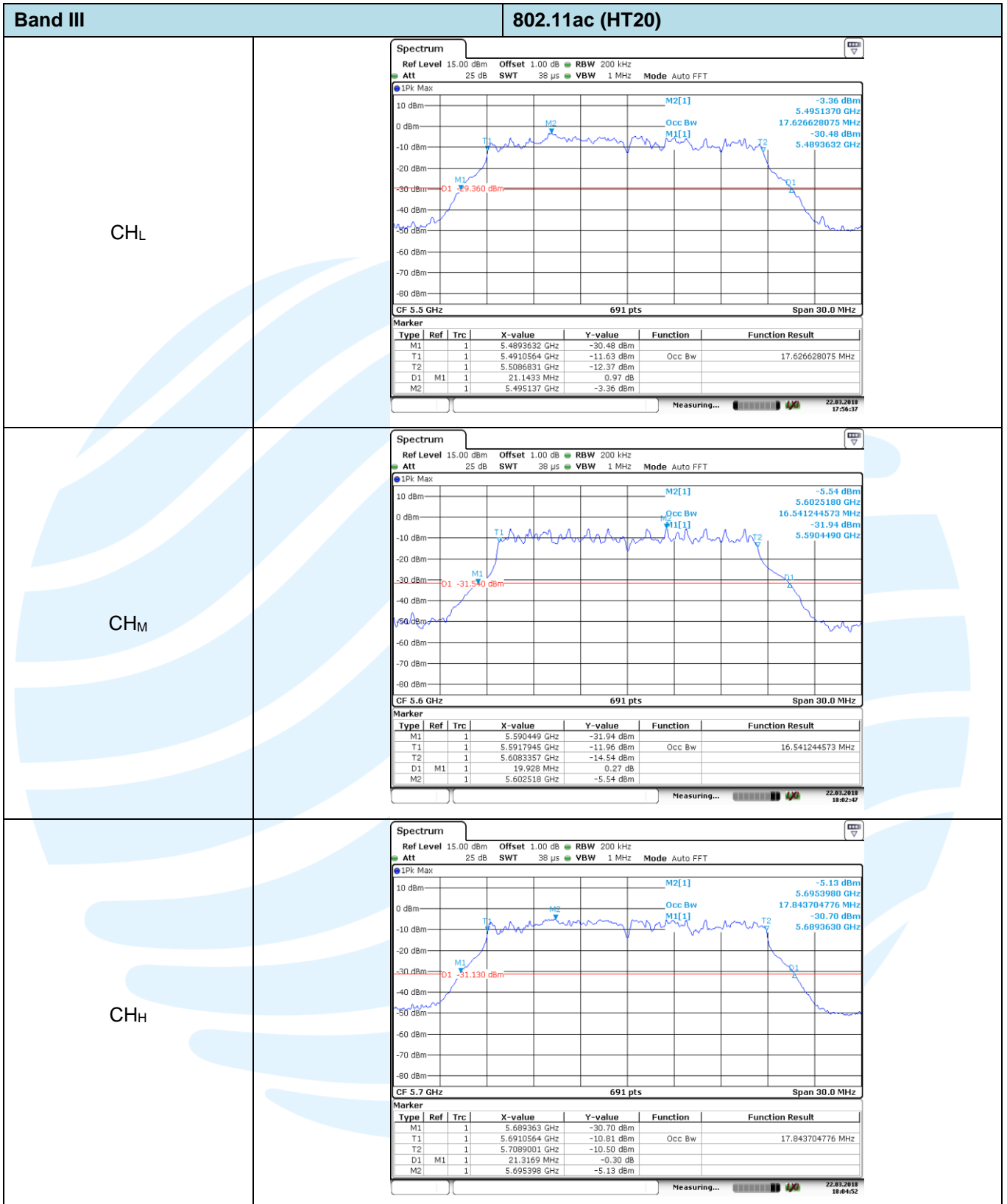



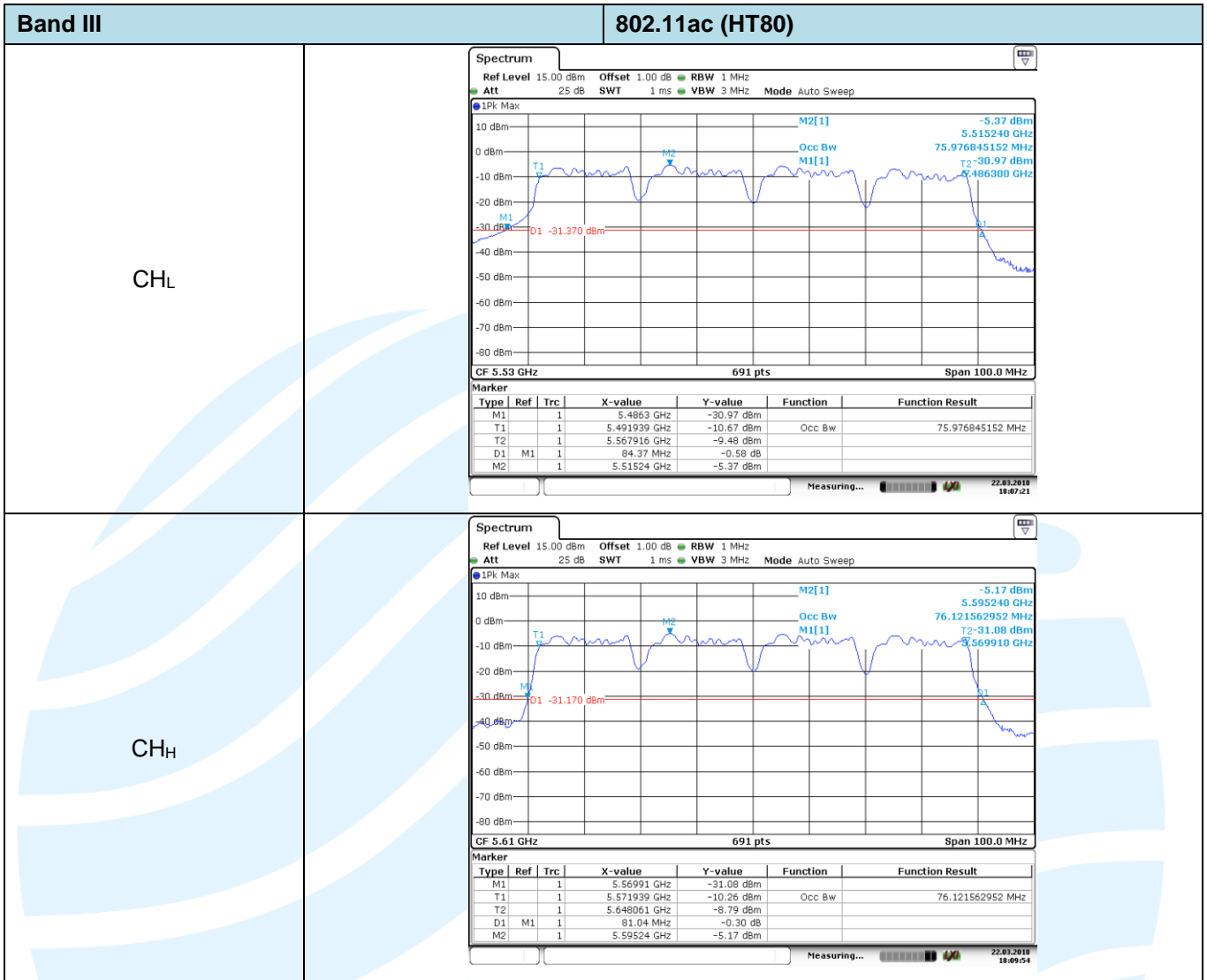

5.6. 6dB Bandwidth

LIMIT

FCC CFR Title 47 Part 15 Subpart E Section 15.407(e)

Within the 5.725-5.85 GHz band, the minimum 6 dB bandwidth of U-NII devices shall be at least 500 kHz

TEST CONFIGURATION

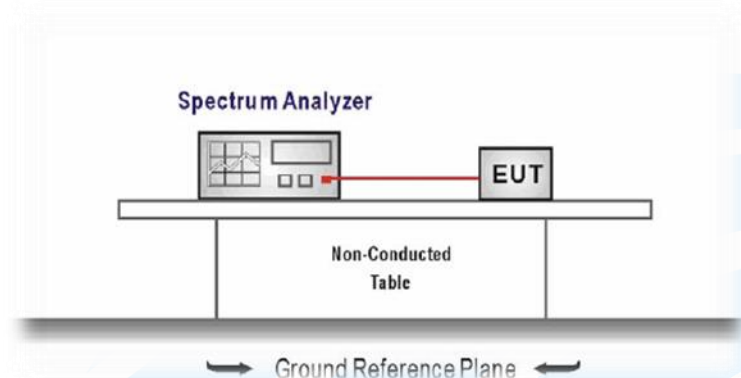

TEST PROCEDURE

1. Connect the antenna port(s) to the spectrum analyzer input.
2. Configure the spectrum analyzer as shown below (enter all losses between the transmitter output and the spectrum analyzer).
Center Frequency = test channel center frequency
Span = 2 x emission bandwidth
RBW = 100 kHz, VBW \geq 3 x RBW
Sweep time = auto couple
Detector = Peak
Trace mode = max hold
3. Place the radio in continuous transmit mode, allow the trace to stabilize, view the transmitter wave form on the spectrum analyzer.
4. Measure the maximum width of the emission that is constrained by the frequencies associated with the two outermost amplitude points (upper and lower frequencies) that are attenuated by 6 dB relative to the maximum level measured in the fundamental emission, and record the pertinent measurements.

TEST MODE:

Please refer to the clause 3.3

TEST RESULTS

Passed Not Applicable

Band	Bandwidth (MHz)	Type	Channel	6dB bandwidth (MHz)	99% Occupy bandwidth (MHz)	Result
IV	20	802.11ac	CH _L	17.06	16.72	Pass
			CH _M	18.54	18.02	
			CH _H	17.67	17.49	
	40	802.11ac	CH _L	36.47	36.69	Pass
			CH _H	36.40	36.61	
	80	802.11ac	CH _M	76.12	76.41	Pass



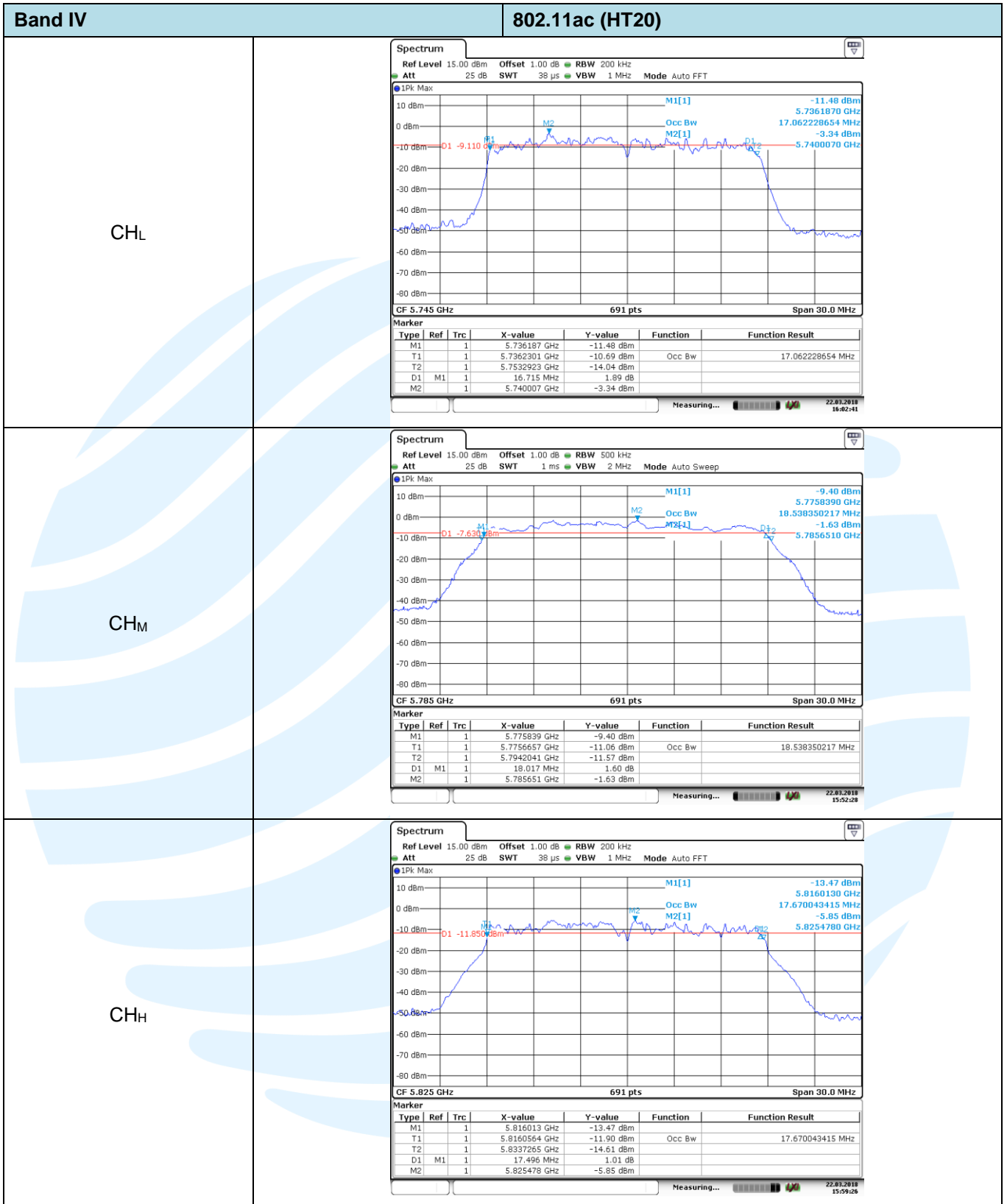

Band IV **802.11ac (HT40)**

CH_L

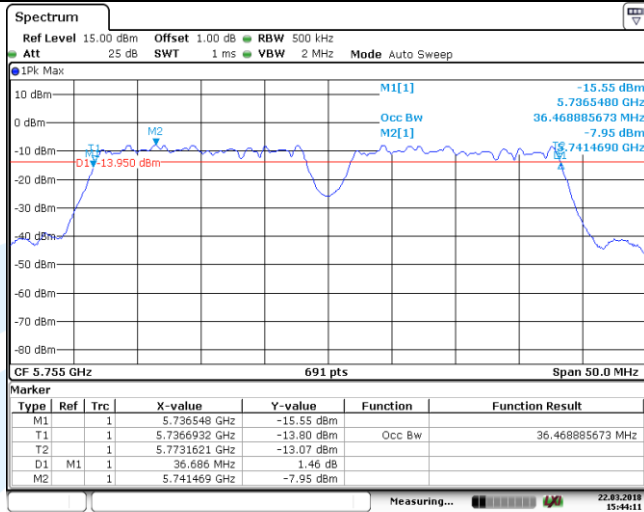

CH_H

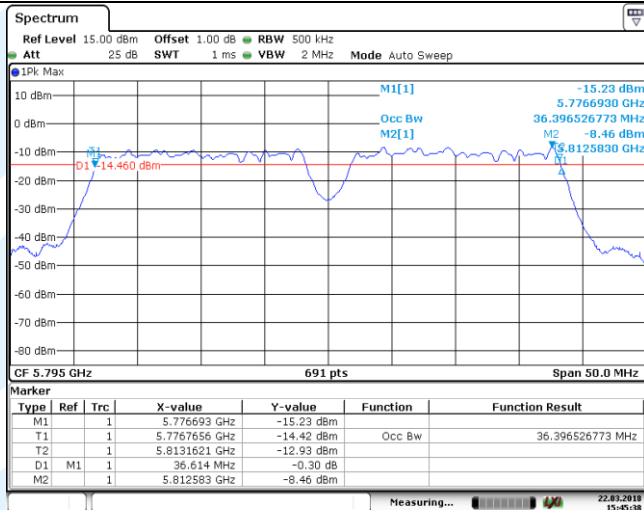

Band IV **802.11ac (HT80)**

CH_M

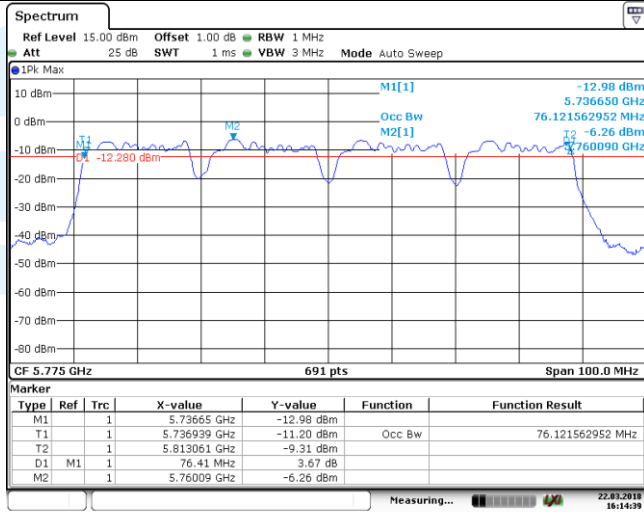

5.7. Band edge

LIMIT

FCC CFR Title 47 Part 15 Subpart E Section 15.407(b)

Un-restricted band emissions above 1GHz			
Operating Band	Frequency	EIRP Limit	Value
5150-5250MHz	Above 1GHz	-27dBm/MHz (68.2dBuV/m@3m)	Peak
5250-5350MHz	Above 1GHz	-27dBm/MHz (68.2dBuV/m@3m)	Peak
5470-5725MHz	Above 1GHz	-27dBm/MHz (68.2dBuV/m@3m)	Peak
5725-5850 MHz	1GHz-5.65GHz	-27dBm/MHz (68.2dBuV/m@3m)	Peak
	5.65GHz-5.7GHz	-27*dBm/MHz to 10dBm/MHz (68.2* dBuV/m to 105.6dBuV/m@3m)	Peak
	5.7GHz-5.72GHz	10*dBm/MHz to 15.6dBm/MHz (105.6*dBuV/m to 110.8dBuV/m@3m)	Peak
	5.72GHz-5.725GHz	15.6*dBm/MHz to 27dBm/MHz (110.8dBuV/m to * 122.2dBuV/m@3m)	Peak
	5.85GHz-5.855GHz	27dBm/MHz to 15.6*dBm/MHz (122.2dBuV/m to 110.8* dBuV/m@3m)	Peak
	5.855GHz-5.875GHz	15.6dBm/MHz to 10*dBm/MHz (110.8dBuV/m to 105.6* dBuV/m@3m)	Peak
	5.875GHz-5.925GHz	10dBm/MHz to -27*dBm/MHz (105.6dBuV/m to 68.2* dBuV/m@3m)	Peak
	Above 5.925GHz	-27dBm/MHz (68.2dBuV/m@3m)	Peak

* Increase/Decreases with the linearity of the frequency.

For emission above 1GHz and in restricted band, according to FCC KDB 789033 D02 General UNII Test Procedure, all emission that complies with both the average and peak limits of Section 15.209 is not required to satisfy the -27 dBm/MHz peak emission limit. $E[dB\mu V/m] = EIRP[dBm] + 95.2$, for $d = 3$ meters.

TEST CONFIGURATION

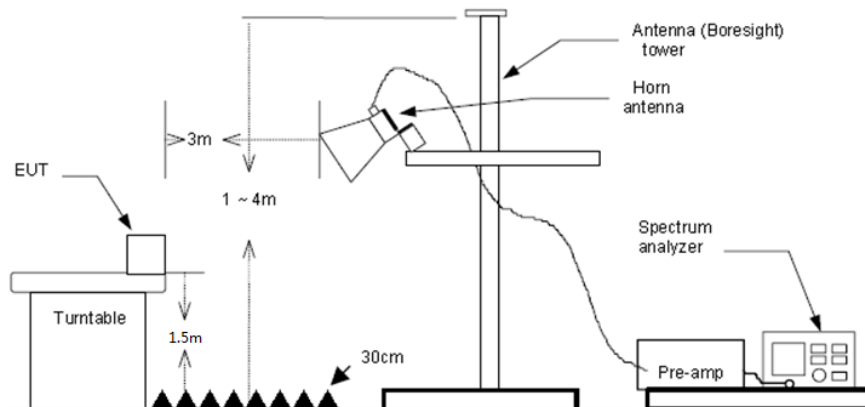

TEST PROCEDURE

1. The EUT was setup and tested according to ANSI C63.10:2013 requirements.
2. The EUT is placed on a turn table which is 1.5 meter above ground. The turn table is rotated 360 degrees to determine the position of the maximum emission level.
3. The EUT was positioned such that the distance from antenna to the EUT was 3 meters.
4. The antenna is scanned from 1 meter to 4 meters to find out the maximum emission level. This is repeated for both horizontal and vertical polarization of the antenna. In order to find the maximum emission, all of the interface cables were manipulated according to ANSI C63.10:2013 on radiated measurement.
5. The receiver set as follow:
RBW=1MHz, VBW=3MHz PEAK detector for Peak value.
RBW=1MHz, VBW=3MHz RMS detector for Average value.

TEST MODE:

Please refer to the clause 3.3

TEST RESULTS

Passed **Not Applicable**

Band: I&I Worst mode: 802.11 ac(HT20) Test channel: CH _L									
Frequency (MHz)	Read Level (dBuV)	Antenna Factor (dB/m)	Cable Loss (dB)	Preamp Factor (dB)	Level (dBuV/m)	Limit Line (dBuV/m)	Margin Limit (dB)	Polarization	Test value
5150.00	18.42	31.70	9.79	0.00	59.91	68.20	-8.29	Horizontal	Peak
5150.00	16.58	31.70	9.79	0.00	58.07	68.20	-10.13	Vertical	Peak
5150.00	8.52	31.70	9.79	0.00	50.01	54.00	-3.99	Horizontal	Average
5150.00	6.39	31.70	9.79	0.00	47.88	54.00	-6.12	Vertical	Average

Band: I&I Worst mode: 802.11 ac(HT20) Test channel: CH _H									
Frequency (MHz)	Read Level (dBuV)	Antenna Factor (dB/m)	Cable Loss (dB)	Preamp Factor (dB)	Level (dBuV/m)	Limit Line (dBuV/m)	Margin Limit (dB)	Polarization	Test value
5350.00	18.04	31.40	10.05	0.00	59.49	68.20	-8.71	Horizontal	Peak
5350.00	16.71	31.40	10.05	0.00	58.16	68.20	-10.04	Vertical	Peak
5350.00	7.51	31.40	10.05	0.00	48.96	54.00	-5.04	Horizontal	Average
5350.00	6.29	31.40	10.05	0.00	47.74	54.00	-6.26	Vertical	Average

Band: I&I Worst mode: 802.11 ac(HT40) Test channel: CH _L									
Frequency (MHz)	Read Level (dBuV)	Antenna Factor (dB/m)	Cable Loss (dB)	Preamp Factor (dB)	Level (dBuV/m)	Limit Line (dBuV/m)	Margin Limit (dB)	Polarization	Test value
5150.00	18.16	31.70	9.79	0.00	59.65	68.20	-8.55	Horizontal	Peak
5150.00	16.97	31.70	9.79	0.00	58.46	68.20	-9.74	Vertical	Peak
5150.00	8.33	31.70	9.79	0.00	49.82	54.00	-4.18	Horizontal	Average
5150.00	6.76	31.70	9.79	0.00	48.25	54.00	-5.75	Vertical	Average

Band: I&I Worst mode: 802.11 ac(HT40) Test channel: CH _H									
Frequency (MHz)	Read Level (dBuV)	Antenna Factor (dB/m)	Cable Loss (dB)	Preamp Factor (dB)	Level (dBuV/m)	Limit Line (dBuV/m)	Margin Limit (dB)	Polarization	Test value
5350.00	17.65	31.40	10.05	0.00	59.10	68.20	-9.10	Horizontal	Peak
5350.00	17.06	31.40	10.05	0.00	58.51	68.20	-9.69	Vertical	Peak
5350.00	7.21	31.40	10.05	0.00	48.66	54.00	-5.34	Horizontal	Average
5350.00	6.57	31.40	10.05	0.00	48.02	54.00	-5.98	Vertical	Average

Band: I&I Worst mode: 802.11 ac(HT80) Test channel: CH _L									
Frequency (MHz)	Read Level (dBuV)	Antenna Factor (dB/m)	Cable Loss (dB)	Preamp Factor (dB)	Level (dBuV/m)	Limit Line (dBuV/m)	Margin Limit (dB)	Polarization	Test value
5150.00	16.88	31.70	9.79	0.00	58.37	68.20	-9.83	Horizontal	Peak
5150.00	16.97	31.70	9.79	0.00	58.46	68.20	-9.74	Vertical	Peak
5150.00	7.33	31.70	9.79	0.00	48.82	54.00	-5.18	Horizontal	Average
5150.00	7.25	31.70	9.79	0.00	48.74	54.00	-5.26	Vertical	Average

Shenzhen UnionTrust Quality and Technology Co., Ltd.

 Address: 16/F, Block A, Building 6, Baoneng Science and Technology Park, Qingxiang Road No.1, Longhua New District, Shenzhen, China
 Tel: +86-755-28230888 Fax: +86-755-28230886 E-mail: info@uttlab.com [Http://www.uttlab.com](http://www.uttlab.com)

Band: I&II Worst mode: 802.11ac(HT80) Test channel: CH _H									
Frequency (MHz)	Read Level (dBuV)	Antenna Factor (dB/m)	Cable Loss (dB)	Preamp Factor (dB)	Level (dBuV/m)	Limit Line (dBuV/m)	Margin Limit (dB)	Polarization	Test value
5350.00	17.01	31.40	10.05	0.00	58.46	68.20	-9.74	Horizontal	Peak
5350.00	16.84	31.40	10.05	0.00	58.29	68.20	-9.91	Vertical	Peak
5350.00	7.21	31.40	10.05	0.00	48.66	54.00	-5.34	Horizontal	Average
5350.00	6.96	31.40	10.05	0.00	48.41	54.00	-5.59	Vertical	Average

Band: III Worst mode: 802.11ac(HT20) Test channel: CH _L									
Frequency (MHz)	Read Level (dBuV)	Antenna Factor (dB/m)	Cable Loss (dB)	Preamp Factor (dB)	Level (dBuV/m)	Limit Line (dBuV/m)	Margin Limit (dB)	Polarization	Test value
5460.00	16.85	31.74	10.17	0.00	58.76	68.20	-9.44	Horizontal	Peak
5460.00	16.68	31.74	10.17	0.00	58.59	68.20	-9.61	Vertical	Peak
5460.00	6.75	31.74	10.17	0.00	48.66	54.00	-5.34	Horizontal	Average
5460.00	6.56	31.74	10.17	0.00	48.47	54.00	-5.53	Vertical	Average

Band: III Worst mode: 802.11ac(HT20) Test channel: CH _H									
Frequency (MHz)	Read Level (dBuV)	Antenna Factor (dB/m)	Cable Loss (dB)	Preamp Factor (dB)	Level (dBuV/m)	Limit Line (dBuV/m)	Margin Limit (dB)	Polarization	Test value
5725.00	16.68	31.73	10.47	0.00	58.88	68.20	-9.32	Horizontal	Peak
5725.00	16.77	31.73	10.47	0.00	58.97	68.20	-9.23	Vertical	Peak
5725.00	7.12	31.73	10.47	0.00	49.32	54.00	-4.68	Horizontal	Average
5725.00	6.95	31.73	10.47	0.00	49.15	54.00	-4.85	Vertical	Average

Band: III Worst mode: 802.11ac(HT40) Test channel: CH _L									
Frequency (MHz)	Read Level (dBuV)	Antenna Factor (dB/m)	Cable Loss (dB)	Preamp Factor (dB)	Level (dBuV/m)	Limit Line (dBuV/m)	Margin Limit (dB)	Polarization	Test value
5460.00	16.76	31.74	10.17	0.00	58.67	68.20	-9.53	Horizontal	Peak
5460.00	16.43	31.74	10.17	0.00	58.34	68.20	-9.86	Vertical	Peak
5460.00	6.57	31.74	10.17	0.00	48.48	54.00	-5.52	Horizontal	Average
5460.00	6.43	31.74	10.17	0.00	48.34	54.00	-5.66	Vertical	Average

Band: III Worst mode: 802.11ac(HT40) Test channel: CH _H									
Frequency (MHz)	Read Level (dBuV)	Antenna Factor (dB/m)	Cable Loss (dB)	Preamp Factor (dB)	Level (dBuV/m)	Limit Line (dBuV/m)	Margin Limit (dB)	Polarization	Test value
5725.00	16.38	31.73	10.47	0.00	58.58	68.20	-9.62	Horizontal	Peak
5725.00	16.54	31.73	10.47	0.00	58.74	68.20	-9.46	Vertical	Peak
5725.00	6.68	31.73	10.47	0.00	48.88	54.00	-5.12	Horizontal	Average
5725.00	6.43	31.73	10.47	0.00	48.63	54.00	-5.37	Vertical	Average

Shenzhen UnionTrust Quality and Technology Co., Ltd.

 Address: 16/F, Block A, Building 6, Baoneng Science and Technology Park, Qingxiang Road No.1, Longhua New District, Shenzhen, China
 Tel: +86-755-28230888 Fax: +86-755-28230886 E-mail: info@uttlab.com [Http://www.uttlab.com](http://www.uttlab.com)

Band: III Worst mode: 802.11ac(HT80) Test channel: CH _L									
Frequency (MHz)	Read Level (dBuV)	Antenna Factor (dB/m)	Cable Loss (dB)	Preamp Factor (dB)	Level (dBuV/m)	Limit Line (dBuV/m)	Margin Limit (dB)	Polarization	Test value
5460.00	16.82	31.74	10.17	0.00	58.73	68.20	-9.47	Horizontal	Peak
5460.00	16.73	31.74	10.17	0.00	58.64	68.20	-9.56	Vertical	Peak
5460.00	6.77	31.74	10.17	0.00	48.68	54.00	-5.32	Horizontal	Average
5460.00	6.69	31.74	10.17	0.00	48.60	54.00	-5.40	Vertical	Average

Band: III Worst mode: 802.11ac(HT80) Test channel: CH _H									
Frequency (MHz)	Read Level (dBuV)	Antenna Factor (dB/m)	Cable Loss (dB)	Preamp Factor (dB)	Level (dBuV/m)	Limit Line (dBuV/m)	Margin Limit (dB)	Polarization	Test value
5725.00	16.59	31.73	10.47	0.00	58.79	68.20	-9.41	Horizontal	Peak
5725.00	16.84	31.73	10.47	0.00	59.04	68.20	-9.16	Vertical	Peak
5725.00	6.76	31.73	10.47	0.00	48.96	54.00	-5.04	Horizontal	Average
5725.00	6.69	31.73	10.47	0.00	48.89	54.00	-5.11	Vertical	Average

Band: IV Worst mode: 802.11ac(HT20) Test channel: CH _L									
Frequency (MHz)	Read Level (dBuV)	Antenna Factor (dB/m)	Cable Loss (dB)	Preamp Factor (dB)	Level (dBuV/m)	Limit Line (dBuV/m)	Margin Limit (dB)	Polarization	Test value
5725.00	16.25	31.73	10.47	0.00	58.45	68.20	-9.75	Horizontal	Peak
5725.00	16.13	31.73	10.47	0.00	58.33	68.20	-9.87	Vertical	Peak
5725.00	6.29	31.73	10.47	0.00	48.49	54.00	-5.51	Horizontal	Average
5725.00	6.20	31.73	10.47	0.00	48.40	54.00	-5.60	Vertical	Average

Band: IV Worst mode: 802.11ac(HT20) Test channel: CH _H									
Frequency (MHz)	Read Level (dBuV)	Antenna Factor (dB/m)	Cable Loss (dB)	Preamp Factor (dB)	Level (dBuV/m)	Limit Line (dBuV/m)	Margin Limit (dB)	Polarization	Test value
5850.00	16.32	32.20	10.61	0.00	59.13	68.20	-9.07	Horizontal	Peak
5850.00	16.38	32.20	10.61	0.00	59.19	68.20	-9.01	Vertical	Peak
5850.00	6.35	32.20	10.61	0.00	49.16	54.00	-4.84	Horizontal	Average
5850.00	6.71	32.20	10.61	0.00	49.52	54.00	-4.48	Vertical	Average

Band: IV Worst mode: 802.11ac(HT40) Test channel: CH _L									
Frequency (MHz)	Read Level (dBuV)	Antenna Factor (dB/m)	Cable Loss (dB)	Preamp Factor (dB)	Level (dBuV/m)	Limit Line (dBuV/m)	Margin Limit (dB)	Polarization	Test value
5725.00	16.35	31.73	10.47	0.00	58.55	68.20	-9.65	Horizontal	Peak
5725.00	16.42	31.73	10.47	0.00	58.62	68.20	-9.58	Vertical	Peak
5725.00	6.33	31.73	10.47	0.00	48.53	54.00	-5.47	Horizontal	Average
5725.00	6.38	31.73	10.47	0.00	48.58	54.00	-5.42	Vertical	Average

Band: IV Worst mode: 802.11ac(HT40) Test channel: CH _H									
Frequency (MHz)	Read Level (dBuV)	Antenna Factor (dB/m)	Cable Loss (dB)	Preamp Factor (dB)	Level (dBuV/m)	Limit Line (dBuV/m)	Margin Limit (dB)	Polarization	Test value
5850.00	16.43	32.20	10.61	0.00	59.24	68.20	-8.96	Horizontal	Peak
5850.00	16.58	32.20	10.61	0.00	59.39	68.20	-8.81	Vertical	Peak
5850.00	6.39	32.20	10.61	0.00	49.20	54.00	-4.80	Horizontal	Average
5850.00	6.31	32.20	10.61	0.00	49.12	54.00	-4.88	Vertical	Average

Band: IV Worst mode: 802.11ac(HT80) Test channel: CH _L									
Frequency (MHz)	Read Level (dBuV)	Antenna Factor (dB/m)	Cable Loss (dB)	Preamp Factor (dB)	Level (dBuV/m)	Limit Line (dBuV/m)	Margin Limit (dB)	Polarization	Test value
5725.00	16.45	31.73	10.47	0.00	58.65	68.20	-9.55	Horizontal	Peak
5725.00	16.59	31.73	10.47	0.00	58.79	68.20	-9.41	Vertical	Peak
5725.00	6.55	31.73	10.47	0.00	48.75	54.00	-5.25	Horizontal	Average
5725.00	6.53	31.73	10.47	0.00	48.73	54.00	-5.27	Vertical	Average

Band: IV Worst mode: 802.11ac(HT80) Test channel: CH _H									
Frequency (MHz)	Read Level (dBuV)	Antenna Factor (dB/m)	Cable Loss (dB)	Preamp Factor (dB)	Level (dBuV/m)	Limit Line (dBuV/m)	Margin Limit (dB)	Polarization	Test value
5850.00	16.63	32.20	10.61	0.00	59.44	68.20	-8.76	Horizontal	Peak
5850.00	16.52	32.20	10.61	0.00	59.33	68.20	-8.87	Vertical	Peak
5850.00	6.47	32.20	10.61	0.00	49.28	54.00	-4.72	Horizontal	Average
5850.00	6.38	32.20	10.61	0.00	49.19	54.00	-4.81	Vertical	Average

Remark:

1. Final Level = Receiver Read level + Antenna Factor + Cable Loss – Preamplifier Factor
2. The emission levels of other frequencies are very lower than the limit and not show in test report.

5.8. Radiated Spurious Emissions

LIMIT

FCC CFR Title 47 Part 15 Subpart C Section 15.209 and Part 15 Subpart E Section 15.407.

Unwanted emissions below 1GHz and Restricted band emissions above 1GHz		
Frequency	Limit (dBuV/m @3m)	Value
30MHz-88MHz	40.00	Quasi-peak
88MHz-216MHz	43.50	Quasi-peak
216MHz-960MHz	46.00	Quasi-peak
960MHz-1GHz	54.00	Quasi-peak
Above 1GHz	54.00	Average
	74.00	Peak

TEST CONFIGURATION

- 9KHz ~30MHz

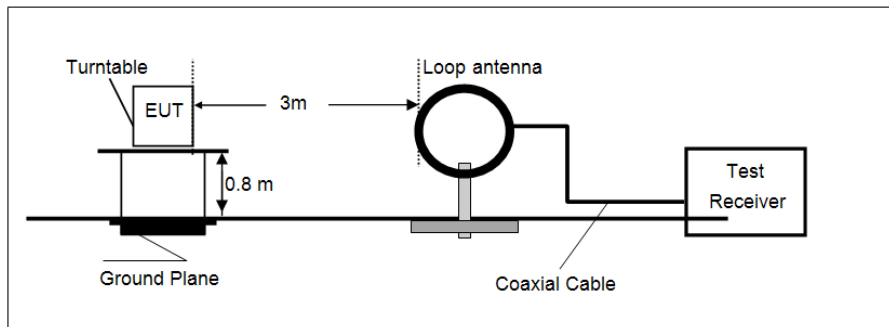

- 30MHz ~ 1GHz

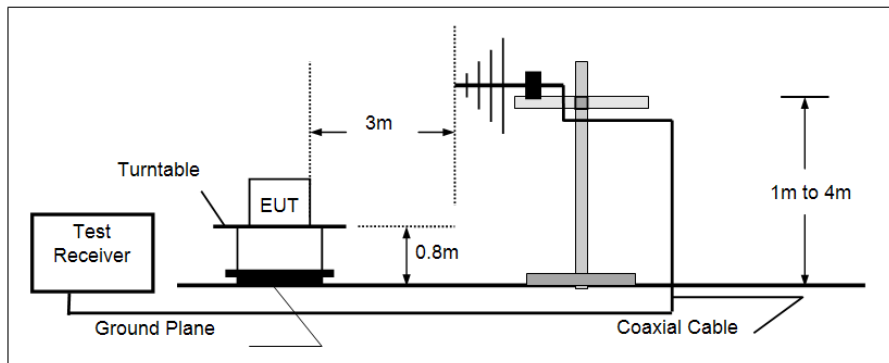

- Above 1GHz

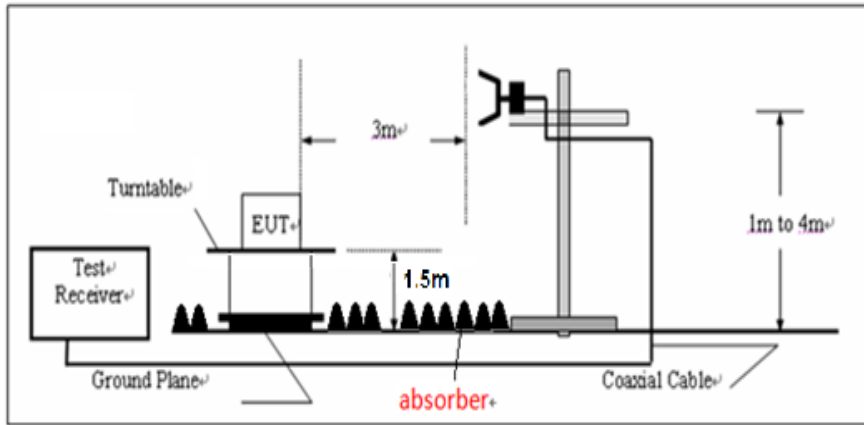

TEST PROCEDURE

1. The EUT was setup and tested according to ANSI C63.10:2013
2. The EUT is placed on a turn table which is 0.8 meter above ground for below 1 GHz, and 1.5 m for above 1 GHz. The turn table is rotated 360 degrees to determine the position of the maximum emission level.
3. The EUT was set 3 meters from the receiving antenna, which was mounted on the top of a variable height antenna tower.
4. For each suspected emission, the EUT was arranged to its worst case and then tune the Antenna tower (from 1 m to 4 m) and turntable (from 0 degree to 360 degrees) to find the maximum reading. A pre-amp and a high pass filter are used for the test in order to get better signal level to comply with the guidelines.
5. Set to the maximum power setting and enable the EUT transmit continuously.
6. Use the following spectrum analyzer settings
 - (1) Span shall wide enough to fully capture the emission being measured;
 - (2) Below 1 GHz:
 - RBW=120 kHz, VBW=300 kHz, Sweep=auto, Detector function=peak, Trace=max hold;
 - If the emission level of the EUT measured by the peak detector is 3 dB lower than the applicable limit, the peak emission level will be reported. Otherwise, the emission measurement will be repeated using the quasi-peak detector and reported.
 - (3) From 1 GHz to 10th harmonic:
 - RBW=1MHz, VBW=3MHz Peak detector for Peak value.
 - RBW=1MHz, VBW=3MHz RMS detector for Average value.

TEST MODE:

Please refer to the clause 3.3

TEST RESULTS

Passed Not Applicable

Measurement data:

■ **9kHz ~ 30MHz**

The low frequency, which started from 9 kHz to 30MHz, was pre-scanned and the result which was 20dB lower than the limit line per 15.31(o) was not reported.

Pre-scan all of the 802.11ac(HT20) /ac(HT40)/ac(HT80) mode at U-NII band I/II/III and IV. And found 802.11 ac(HT20) mode was the worst case at this four bands. So only the worst data was shown on the report.

■ **30MHz ~ 1GHz**

Horizontal

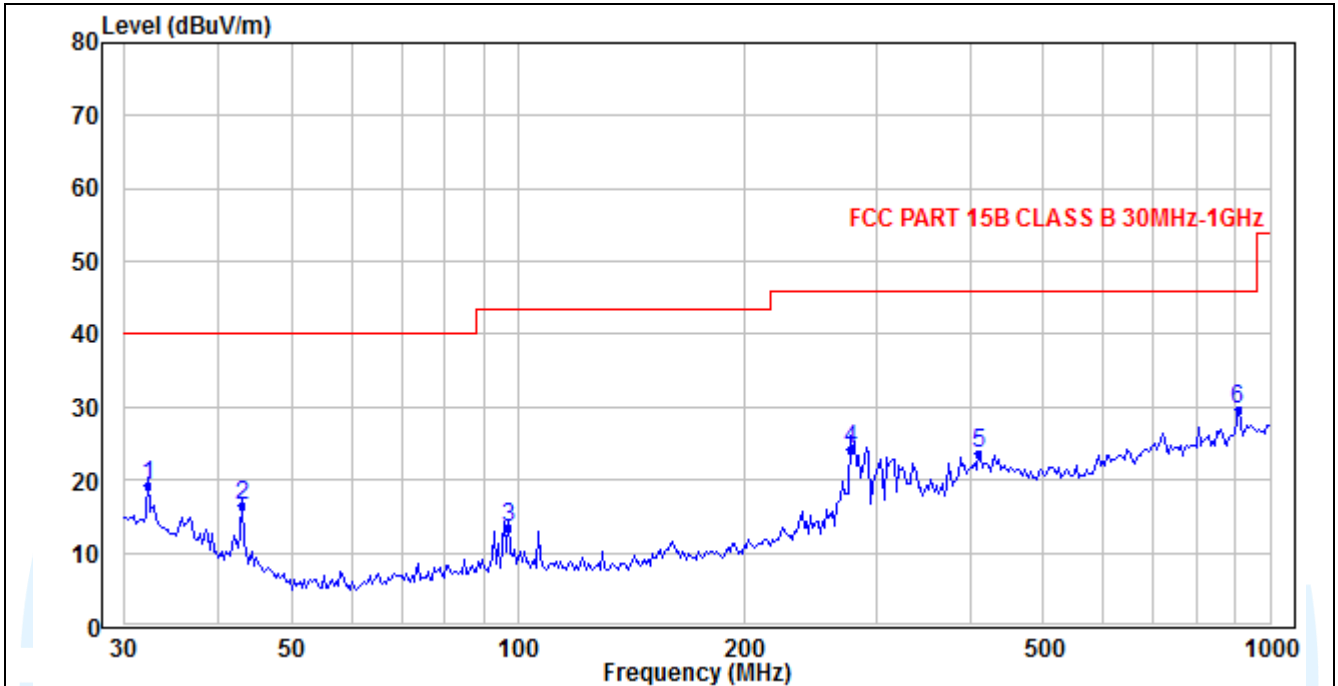

No.	Frequency (MHz)	Reading (dBuV)	Correction factor(dB/m)	Result (dBuV/m)	Limit (dBuV/m)	Margin (dB)	Remark
1	32.184	31.64	-12.37	19.27	40.00	-20.73	QP
2	42.931	34.02	-17.58	16.44	40.00	-23.56	QP
3*	97.002	31.63	-18.16	13.47	43.50	-30.03	QP
4	276.382	36.21	-11.97	24.24	46.00	-21.76	QP
5	409.651	31.82	-8.24	23.58	46.00	-22.42	QP
6	906.304	29.71	-0.06	29.65	46.00	-16.35	QP

Vertical

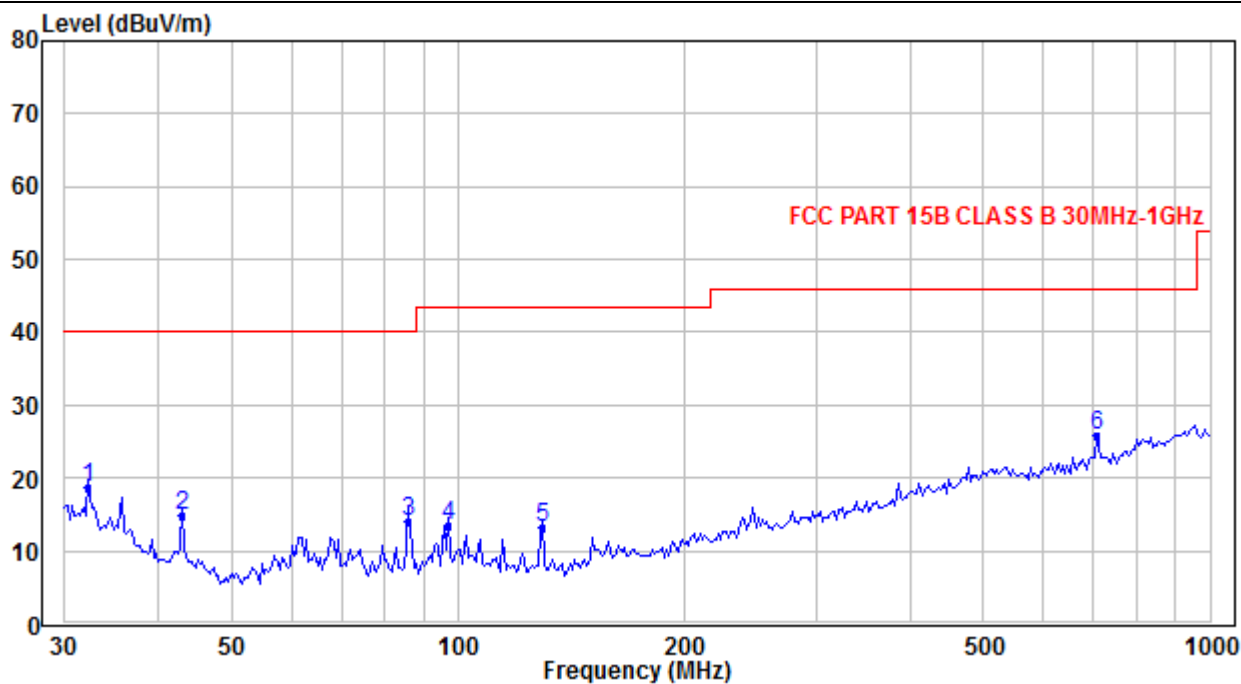

No.	Frequency (MHz)	Reading (dBuV)	Correction factor(dB/m)	Result (dBuV/m)	Limit (dBuV/m)	Margin (dB)	Remark
1	32.184	32.06	-13.35	18.71	40.00	-21.29	QP
2	42.931	33.18	-18.31	14.87	40.00	-25.13	QP
3	86.080	33.42	-19.48	13.94	40.00	-26.06	QP
4	97.002	32.56	-19.03	13.53	43.50	-29.97	QP
5*	129.392	32.43	-19.12	13.31	43.50	-30.19	QP
6	708.694	29.74	-3.92	25.82	46.00	-20.18	QP

Remark:

Margin=Limit -Level

■ Above 1GHz

Band: I Worst mode: 802.11 ac(HT20) Test channel: CH _L									
Frequency (MHz)	Read Level (dBuV)	Antenna Factor (dB/m)	Cable Loss (dB)	Preamp Factor (dB)	Level (dBuV/m)	Limit Line (dBuV/m)	Margin Limit (dB)	Polarization	Test value
3616.45	34.98	29.30	8.29	38.27	34.30	74.00	-39.70	Vertical	Peak
6412.43	31.22	33.39	11.01	35.31	40.31	68.20	-27.89	Vertical	Peak
7227.39	29.98	36.23	11.89	35.04	43.06	68.20	-25.14	Vertical	Peak
9251.58	31.87	38.91	13.55	35.71	48.62	68.20	-19.58	Vertical	Peak
3993.90	33.55	29.70	8.77	38.11	33.91	68.20	-34.29	Horizontal	Peak
6445.16	31.01	33.62	11.07	35.32	40.38	68.20	-27.82	Horizontal	Peak
9514.29	31.53	39.04	13.72	35.22	49.07	74.00	-24.93	Horizontal	Peak
11633.54	28.75	40.14	13.72	33.23	49.38	74.00	-24.62	Horizontal	Peak

Band: I Worst mode: 802.11 ac(HT20) Test channel: CH _M									
Frequency (MHz)	Read Level (dBuV)	Antenna Factor (dB/m)	Cable Loss (dB)	Preamp Factor (dB)	Level (dBuV/m)	Limit Line (dBuV/m)	Margin Limit (dB)	Polarization	Test value
2400.47	32.47	27.60	6.77	37.90	28.94	68.20	-39.26	Vertical	Peak
6511.12	31.83	34.02	11.20	35.34	41.71	68.20	-26.49	Vertical	Peak
9370.08	31.85	39.06	13.66	35.38	49.19	74.00	-24.81	Vertical	Peak
10778.21	29.71	40.18	13.58	34.48	48.99	74.00	-25.01	Vertical	Peak
2468.63	32.39	27.32	6.82	37.88	28.65	68.20	-39.55	Horizontal	Peak
6412.43	30.09	33.39	11.01	35.31	39.18	68.20	-29.02	Horizontal	Peak
9859.47	32.21	39.10	13.61	34.93	49.99	68.20	-18.21	Horizontal	Peak
10860.83	30.26	40.46	13.58	34.41	49.89	74.00	-24.11	Horizontal	Peak

Band: I Worst mode: 802.11 ac(HT20) Test channel: CH _H									
Frequency (MHz)	Read Level (dBuV)	Antenna Factor (dB/m)	Cable Loss (dB)	Preamp Factor (dB)	Level (dBuV/m)	Limit Line (dBuV/m)	Margin Limit (dB)	Polarization	Test value
3644.18	35.16	29.30	8.32	38.26	34.52	74.00	-39.48	Vertical	Peak
7470.56	32.40	36.16	12.30	34.88	45.98	74.00	-28.02	Vertical	Peak
8973.25	31.54	37.87	13.28	34.39	48.30	68.20	-19.90	Vertical	Peak
10534.09	29.39	39.98	13.59	34.01	48.95	68.20	-19.25	Vertical	Peak
3681.47	34.41	29.30	8.36	38.25	33.82	74.00	-40.18	Horizontal	Peak
7063.69	30.53	35.49	11.85	34.88	42.99	68.20	-25.21	Horizontal	Peak
7721.91	30.03	36.10	13.05	35.03	44.15	74.00	-29.85	Horizontal	Peak
9322.50	30.50	39.15	13.62	35.51	47.76	74.00	-26.24	Horizontal	Peak

Remark:

1. Final Level = Receiver Read level + Antenna Factor + Cable Loss – Pre-amplifier Factor
2. The emission levels of other frequencies are very lower than the limit and not show in test report.
3. Measuring frequencies from 1 GHz to 40GHz.

Shenzhen UnionTrust Quality and Technology Co., Ltd.

Band: II Worst mode: 802.11 ac(HT20) Test channel: CH _L									
Frequency (MHz)	Read Level (dBuV)	Antenna Factor (dB/m)	Cable Loss (dB)	Preamp Factor (dB)	Level (dBuV/m)	Limit Line (dBuV/m)	Margin Limit (dB)	Polarization	Test value
3333.55	34.61	28.20	7.88	38.43	32.26	74.00	-41.74	Vertical	Peak
5532.26	32.93	31.87	10.22	36.18	38.84	68.20	-29.36	Vertical	Peak
6696.01	31.60	34.20	11.48	35.18	42.10	68.20	-26.10	Vertical	Peak
9759.59	30.55	39.10	13.66	35.58	47.73	68.20	-20.47	Vertical	Peak
3463.29	34.42	28.71	8.06	38.46	32.73	68.20	-35.47	Horizontal	Peak
6478.05	30.71	33.85	11.13	35.33	40.36	68.20	-27.84	Horizontal	Peak
8002.06	31.18	37.10	12.30	34.53	46.05	68.20	-22.15	Horizontal	Peak
9393.97	31.42	39.01	13.68	35.32	48.79	74.00	-25.21	Horizontal	Peak

Band: II Worst mode: 802.11 ac(HT20) Test channel: CH _M									
Frequency (MHz)	Read Level (dBuV)	Antenna Factor (dB/m)	Cable Loss (dB)	Preamp Factor (dB)	Level (dBuV/m)	Limit Line (dBuV/m)	Margin Limit (dB)	Polarization	Test value
3644.18	35.16	29.30	8.32	38.26	34.52	74.00	-39.48	Vertical	Peak
7451.57	31.19	36.20	12.24	34.86	44.77	74.00	-29.23	Vertical	Peak
9042.04	32.18	38.03	13.35	34.71	48.85	74.00	-25.15	Vertical	Peak
10778.21	29.71	40.18	13.58	34.48	48.99	74.00	-25.01	Vertical	Peak
3160.03	34.77	28.80	7.67	38.21	33.03	68.20	-35.17	Horizontal	Peak
6032.40	30.87	32.50	10.73	35.42	38.68	68.20	-29.52	Horizontal	Peak
8462.98	30.90	36.79	12.86	34.34	46.21	74.00	-27.79	Horizontal	Peak
10507.31	30.05	40.00	13.59	34.33	49.31	68.20	-18.89	Horizontal	Peak

Band: II Worst mode: 802.11 ac(HT20) Test channel: CH _H									
Frequency (MHz)	Read Level (dBuV)	Antenna Factor (dB/m)	Cable Loss (dB)	Preamp Factor (dB)	Level (dBuV/m)	Limit Line (dBuV/m)	Margin Limit (dB)	Polarization	Test value
3018.50	36.74	28.64	7.50	38.23	34.65	68.20	-33.55	Vertical	Peak
3786.01	34.88	29.56	8.48	38.23	34.69	74.00	-39.31	Vertical	Peak
6203.70	31.37	32.91	11.01	35.29	40.00	68.20	-28.20	Vertical	Peak
10165.29	30.99	39.17	13.56	34.64	49.08	68.20	-19.12	Vertical	Peak
3410.80	34.95	28.29	7.98	38.53	32.69	68.20	-35.51	Horizontal	Peak
7117.84	30.96	35.71	11.86	34.96	43.57	68.20	-24.63	Horizontal	Peak
8571.38	32.18	37.19	12.88	34.48	47.77	68.20	-20.43	Horizontal	Peak
11169.24	29.21	40.30	13.50	33.44	49.57	74.00	-24.43	Horizontal	Peak

Remark:

1. Final Level = Receiver Read level + Antenna Factor + Cable Loss – Preamplifier Factor
2. The emission levels of other frequencies are very lower than the limit and not show in test report.
3. Measuring frequencies from 1 GHz to 40GHz.

Shenzhen UnionTrust Quality and Technology Co., Ltd.

Address: 16/F, Block A, Building 6, Baoneng Science and Technology Park, Qingxiang Road No.1, Longhua New District, Shenzhen, China
 Tel: +86-755-28230888 Fax: +86-755-28230886 E-mail: info@uttlab.com [Http://www.uttlab.com](http://www.uttlab.com)

Band: III Worst mode: 802.11 ac(HT20) Test channel: CH _L									
Frequency (MHz)	Read Level (dBuV)	Antenna Factor (dB/m)	Cable Loss (dB)	Preamp Factor (dB)	Level (dBuV/m)	Limit Line (dBuV/m)	Margin Limit (dB)	Polarization	Test value
2905.42	33.54	28.51	7.43	38.29	31.19	68.20	-37.01	Vertical	Peak
6903.71	30.52	34.72	11.73	34.89	42.08	68.20	-26.12	Vertical	Peak
8377.24	30.63	36.55	12.84	34.29	45.73	74.00	-28.27	Vertical	Peak
10269.32	30.79	39.27	13.57	35.18	48.45	68.20	-19.75	Vertical	Peak
3644.18	34.72	29.30	8.32	38.26	34.08	74.00	-39.92	Horizontal	Peak
6203.70	30.67	32.91	11.01	35.29	39.30	68.20	-28.90	Horizontal	Peak
8814.77	30.42	37.71	13.12	34.29	46.96	68.20	-21.24	Horizontal	Peak
9784.47	32.64	39.10	13.65	35.65	49.74	68.20	-18.46	Horizontal	Peak

Band: III Worst mode: 802.11 ac(HT20) Test channel: CH _M									
Frequency (MHz)	Read Level (dBuV)	Antenna Factor (dB/m)	Cable Loss (dB)	Preamp Factor (dB)	Level (dBuV/m)	Limit Line (dBuV/m)	Margin Limit (dB)	Polarization	Test value
3192.37	35.78	28.80	7.71	38.20	34.09	68.20	-34.11	Vertical	Peak
4117.79	35.17	29.92	8.87	37.84	36.12	74.00	-37.88	Vertical	Peak
5393.22	33.19	31.49	10.12	36.78	38.02	74.00	-35.98	Vertical	Peak
9298.80	30.75	39.19	13.59	35.58	47.95	68.20	-20.25	Vertical	Peak
2664.54	31.78	27.99	7.06	38.01	28.82	68.20	-39.38	Horizontal	Peak
6611.33	30.42	34.20	11.37	35.34	40.65	68.20	-27.55	Horizontal	Peak
9111.35	31.37	38.25	13.42	35.21	47.83	74.00	-26.17	Horizontal	Peak
11112.52	29.73	40.30	13.52	33.60	49.95	74.00	-24.05	Horizontal	Peak

Band: III Worst mode: 802.11 ac(HT20) Test channel: CH _H									
Frequency (MHz)	Read Level (dBuV)	Antenna Factor (dB/m)	Cable Loss (dB)	Preamp Factor (dB)	Level (dBuV/m)	Limit Line (dBuV/m)	Margin Limit (dB)	Polarization	Test value
2987.92	34.78	28.59	7.47	38.24	32.60	68.20	-35.60	Vertical	Peak
3854.08	34.69	29.65	8.58	38.20	34.72	74.00	-39.28	Vertical	Peak
7413.73	33.29	36.27	12.11	34.83	46.84	74.00	-27.16	Vertical	Peak
9710.03	31.47	39.10	13.68	35.45	48.80	68.20	-19.40	Vertical	Peak
2604.19	33.97	27.81	6.92	37.85	30.85	68.20	-37.35	Horizontal	Peak
3953.44	32.62	29.70	8.71	38.14	32.89	74.00	-41.11	Horizontal	Peak
6611.33	30.42	34.20	11.37	35.34	40.65	68.20	-27.55	Horizontal	Peak
9370.08	30.98	39.06	13.66	35.38	48.32	74.00	-25.68	Horizontal	Peak

Remark:

1. Final Level = Receiver Read level + Antenna Factor + Cable Loss – Pre-amplifier Factor
2. The emission levels of other frequencies are very lower than the limit and not show in test report.
3. Measuring frequencies from 1 GHz to 40GHz.

Shenzhen UnionTrust Quality and Technology Co., Ltd.

Address: 16/F, Block A, Building 6, Baoneng Science and Technology Park, Qingxiang Road No.1, Longhua New District, Shenzhen, China
 Tel: +86-755-28230888 Fax: +86-755-28230886 E-mail: info@uttlab.com [Http://www.uttlab.com](http://www.uttlab.com)

Band: IV Worst mode: 802.11 ac(HT20) Test channel: CH _L									
Frequency (MHz)	Read Level (dBuV)	Antenna Factor (dB/m)	Cable Loss (dB)	Preamp Factor (dB)	Level (dBuV/m)	Limit Line (dBuV/m)	Margin Limit (dB)	Polarization	Test value
2449.85	32.94	27.40	6.80	37.89	29.25	68.20	-38.95	Vertical	Peak
6678.99	31.19	34.20	11.45	35.21	41.63	68.20	-26.57	Vertical	Peak
9065.08	31.46	38.10	13.37	34.88	48.05	68.20	-20.15	Vertical	Peak
10321.74	31.31	39.38	13.58	35.35	48.92	68.20	-19.28	Vertical	Peak
2577.80	34.10	27.67	6.89	37.85	30.81	68.20	-37.39	Horizontal	Peak
3616.45	33.44	29.30	8.29	38.27	32.76	74.00	-41.24	Horizontal	Peak
7227.39	30.39	36.23	11.89	35.04	43.47	68.20	-24.73	Horizontal	Peak
11663.19	29.09	40.12	13.79	33.30	49.70	74.00	-24.30	Horizontal	Peak

Band: IV Worst mode: 802.11 ac(HT20) Test channel: CH _M									
Frequency (MHz)	Read Level (dBuV)	Antenna Factor (dB/m)	Cable Loss (dB)	Preamp Factor (dB)	Level (dBuV/m)	Limit Line (dBuV/m)	Margin Limit (dB)	Polarization	Test value
3128.01	36.26	28.80	7.63	38.21	34.48	68.20	-33.72	Vertical	Peak
3795.66	34.57	29.59	8.50	38.23	34.43	74.00	-39.57	Vertical	Peak
7227.39	29.98	36.23	11.89	35.04	43.06	68.20	-25.14	Vertical	Peak
9514.29	32.36	39.04	13.72	35.22	49.90	68.20	-18.3	Vertical	Peak
1823.48	33.20	25.38	6.00	37.16	27.42	68.20	-40.78	Horizontal	Peak
2584.37	34.72	27.71	6.90	37.84	31.49	68.20	-36.71	Horizontal	Peak
8042.90	32.36	37.06	12.40	34.53	47.29	74.00	-26.71	Horizontal	Peak
10295.50	30.40	39.30	13.57	35.27	48.00	68.20	-20.2	Horizontal	Peak

Band: IV Worst mode: 802.11 ac(HT20) Test channel: CH _H									
Frequency (MHz)	Read Level (dBuV)	Antenna Factor (dB/m)	Cable Loss (dB)	Preamp Factor (dB)	Level (dBuV/m)	Limit Line (dBuV/m)	Margin Limit (dB)	Polarization	Test value
2431.21	33.74	27.47	6.79	37.89	30.11	68.20	-38.09	Vertical	Peak
3534.54	34.96	29.10	8.17	38.36	33.87	68.20	-34.33	Vertical	Peak
6594.52	32.14	34.19	11.35	35.36	42.32	68.20	-25.88	Vertical	Peak
9204.60	33.03	38.63	13.50	35.84	49.32	68.20	-18.88	Vertical	Peak
1908.97	32.98	25.39	6.13	37.23	27.27	68.20	-40.93	Horizontal	Peak
3598.09	33.53	29.29	8.27	38.27	32.82	68.20	-35.38	Horizontal	Peak
6511.12	30.87	34.02	11.20	35.34	40.75	68.20	-27.45	Horizontal	Peak
9204.60	30.98	38.63	13.50	35.84	47.27	68.20	-20.93	Horizontal	Peak

Remark:

4. *Final Level = Receiver Read level + Antenna Factor + Cable Loss – Pre-amplifier Factor*
5. *The emission levels of other frequencies are very lower than the limit and not show in test report.*
6. *Measuring frequencies from 1 GHz to 40GHz.*

Shenzhen UnionTrust Quality and Technology Co., Ltd.

5.9. Dynamic Frequency Selection(DFS)

Requirement

Table 1: Applicability of DFS Requirements Prior to Use of a Channel

Requirement	Operational Mode		
	Master	Client Without Radar Detection	Client With Radar Detection
Non-Occupancy Period	Yes	Not required	Yes
DFS Detection Threshold	Yes	Not required	Yes
Channel Availability Check Time	Yes	Not required	Not required
U-NII Detection Bandwidth	Yes	Not required	Yes

Table 2: Applicability of DFS requirements during normal operation

Requirement	Operational Mode	
	Master Device or Client with Radar Detection	Client Without Radar Detection
DFS Detection Threshold	Yes	Not required
Channel Closing Transmission Time	Yes	Yes
Channel Move Time	Yes	Yes
U-NII Detection Bandwidth	Yes	Not required

Additional requirements for devices with multiple bandwidth modes	Master Device or Client with Radar Detection	Client Without Radar Detection
U-NII Detection Bandwidth and Statistical Performance Check	All BW modes must be tested	Not required
Channel Move Time and Channel Closing Transmission Time	Test using widest BW mode available	Test using the widest BW mode available for the link
All other tests	Any single BW mode	Not required

Note: Frequencies selected for statistical performance check (Section 7.8.4) should include several frequencies within the radar detection bandwidth and frequencies near the edge of the radar detection bandwidth. For 802.11 devices it is suggested to select frequencies in each of the bonded 20 MHz channels and the channel center frequency.

LIMIT

1. DFS Detection Thresholds

Table 3: DFS Detection Thresholds for Master Devices and Client Devices With Radar Detection

Maximum Transmit Power	Value (See Notes 1, 2, and 3)
EIRP ≥ 200 milliwatt	-64 dBm
EIRP < 200 milliwatt and power spectral density < 10 dBm/MHz	-62 dBm
EIRP < 200 milliwatt that do not meet the power spectral density requirement	-64 dBm

Note 1: This is the level at the input of the receiver assuming a 0 dBi receive antenna.

Note 2: Throughout these test procedures an additional 1 dB has been added to the amplitude of the test transmission waveforms to account for variations in measurement equipment. This will ensure that the test signal is at or above the detection threshold level to trigger a DFS response.

Note3: EIRP is based on the highest antenna gain. For MIMO devices refer to KDB Publication 662911 D01.

Shenzhen UnionTrust Quality and Technology Co., Ltd.

2. DFS Response Requirements

Table 4: DFS Response Requirement Values

Parameter	Value
Non-occupancy period	Minimum 30 minutes
Channel Availability Check Time	60 seconds
Channel Move Time	10 seconds See Note 1.
Channel Closing Transmission Time	200 milliseconds + an aggregate of 60 milliseconds over remaining 10 second period. See Notes 1 and 2.
U-NII Detection Bandwidth	Minimum 100% of the U-NII 99% transmission power bandwidth. See Note 3.

Note 1: Channel Move Time and the Channel Closing Transmission Time should be performed with Radar Type 0. The measurement timing begins at the end of the Radar Type 0 burst.

Note 2: The Channel Closing Transmission Time is comprised of 200 milliseconds starting at the beginning of the Channel Move Time plus any additional intermittent control signals required facilitating a Channel move (an aggregate of 60 milliseconds) during the remainder of the 10 second period. The aggregate duration of control signals will not count quiet periods in between transmissions.

Note 3: During the U-NII Detection Bandwidth detection test, radar type 0 should be used. For each frequency step the minimum percentage of detection is 90 percent. Measurements are performed with no data traffic.

RADAR TEST WAVEFORMS

This section provides the parameters for required test waveforms, minimum percentage of successful detections, and the minimum number of trials that must be used for determining DFS conformance. Step intervals of 0.1 microsecond for Pulse Width, 1 microsecond for PRI, 1 MHz for chirp width and 1 for the number of pulses will be utilized for the random determination of specific test waveforms.

Table 5 Short Pulse Radar Test Waveforms

Radar Type	Pulse Width (μsec)	PRI (μsec)	Number of Pulses	Minimum Percentage of Successful Detection	Minimum Number of Trials
0	1	1428	18	See Note 1	See Note 1
1	1	Test A: 15 unique PRI values randomly selected from the list of 23 PRI values in Table 5a	$\text{Roundup} \left\{ \begin{matrix} \left(\frac{1}{360} \right) \\ \left(\frac{19 \cdot 10^6}{\text{PRI}_{\mu\text{sec}}} \right) \end{matrix} \right\}$	60%	30
		Test B: 15 unique PRI values randomly selected within the range of 518-3066 μsec, with a minimum increment of 1 μsec, excluding PRI values selected in Test A			
2	1-5	150-230	23-29	60%	30
3	6-10	200-500	16-18	60%	30
4	11-20	200-500	12-16	60%	30

Shenzhen UnionTrust Quality and Technology Co., Ltd.

Aggregate (Radar Types 1-4)	80%	120
Note 1: Short Pulse Radar Type 0 should be used for the detection bandwidth test, channel move time, and channel closing time tests.		

A minimum of 30 unique waveforms are required for each of the Short Pulse Radar Types 2 through 4. If more than 30 waveforms are used for Short Pulse Radar Types 2 through 4, then each additional waveform must also be unique and not repeated from the previous waveforms. If more than 30 waveforms are used for Short Pulse Radar Type 1, then each additional waveform is generated with Test B and must also be unique and not repeated from the previous waveforms in Tests A or B.

For example if in Short Pulse Radar Type 1 Test B a PRI of 3066 μ sec is selected, the number of pulses

would be Round up $\left\{ \left(\frac{1}{360} \right) \cdot \left(\frac{19 \cdot 10^6}{3066} \right) \right\}$ = Round up {17.2} = 18.

Table 5a - Pulse Repetition Intervals Values for Test A

Pulse Repetition Frequency Number	Pulse Repetition Frequency (Pulses Per Second)	Pulse Repetition Interval (Microseconds)
1	1930.5	518
2	1858.7	538
3	1792.1	558
4	1730.1	578
5	1672.2	598
6	1618.1	618
7	1567.4	638
8	1519.8	658
9	1474.9	678
10	1432.7	698
11	1392.8	718
12	1355	738
13	1319.3	758
14	1285.3	778
15	1253.1	798
16	1222.5	818
17	1193.3	838
18	1165.6	858
19	1139	878
20	1113.6	898
21	1089.3	918
22	1066.1	938
23	326.2	3066

Table 6 – Long Pulse Radar Test Waveform

Radar Type	Pulse Width (μ sec)	Chirp Width (MHz)	PRI (μ sec)	Number of Pulses per Burst	Number of Bursts	Minimum Percentage of Successful Detection	Minimum Number of Trials

Shenzhen UnionTrust Quality and Technology Co., Ltd.

Address: 16/F, Block A, Building 6, Baoneng Science and Technology Park, Qingxiang Road No.1, Longhua New District, Shenzhen, China
 Tel: +86-755-28230888 Fax: +86-755-28230886 E-mail: info@uttlab.com [Http://www.uttlab.com](http://www.uttlab.com)

5	50-100	5-20	1000-2000	1-3	8-20	80%	30
---	--------	------	-----------	-----	------	-----	----

The parameters for this waveforms are randomly chosen. Thirty unique waveforms are required for the Long Pulse Radar Type waveforms. If more than 30 waveforms are used for the Long Pulse Radar Type wave forms, then each additional waveform must also be unique and not repeated from the previous waveforms.

Table 7 – Frequency Hopping Radar Test Waveform

Radar Type	Pulse Width (µsec)	PRI (µsec)	Pulses per Hop	Hopping Rate (kHz)	Hopping Sequence Length (msec)	Minimum Percentage of Successful Detection	Minimum Number of Trials
6	1	333	9	0.333	300	70%	30

For the Frequency Hopping Radar Type, the same Burst parameters are used for each wave form. The hopping sequence is different for each wave form and a 100-length segment is selected from the hopping sequence defined by the following algorithm:

The first frequency in a hopping sequence is selected randomly from the group of 475 integer frequencies from 5250–5724MHz. Next, the frequency that was just chosen is removed from the group and a frequency is randomly selected from the remaining 474 frequencies in the group. This process continues until all 475 frequencies are chosen for the set. For selection of a random frequency, the frequencies remaining within the group are always treated as equally likely.

Calibration of Radar Waveform

Radar Waveform Calibration Procedure

- 1) A 50 ohm load is connected in place of the spectrum analyzer, and the spectrum analyzer is connected to place of the master
- 2) The interference Radar Detection Threshold Level is $-62\text{dBm} + 0\text{dBi} + 1\text{dB} = -61\text{dBm}$ that had been taken into account the output power range and antenna gain.
- 3) The following equipment setup was used to calibrate the conducted radar waveform. A vector signal generator was utilized to establish the test signal level for radar type 0. During this process there were no transmissions by either the master or client device. The spectrum analyzer was switched to the zero spans (time domain) at the frequency of the radar waveform generator. Peak detection was used. The spectrum analyzer resolution bandwidth (RBW) and video bandwidth (VBW) were set to 3 MHz. The spectrum analyzer had offset -1.0dB to compensate RF cable loss 1.0dB .
- 4) The vector signal generator amplitude was set so that the power level measured at the spectrum analyzer was $-62\text{dBm} + 0\text{dBi} + 1\text{dB} = -61\text{dBm}$. Capture the spectrum analyzer plots on short pulse radar waveform.

Conducted Calibration Setup

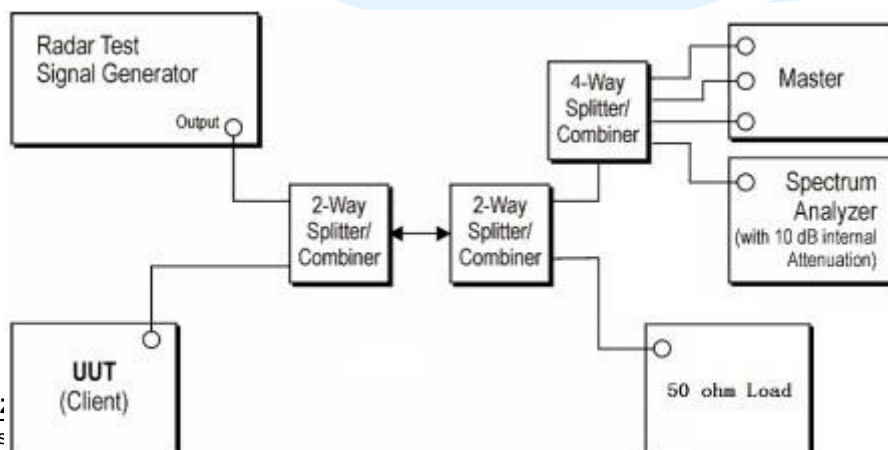

Radar Waveform Calibration Result

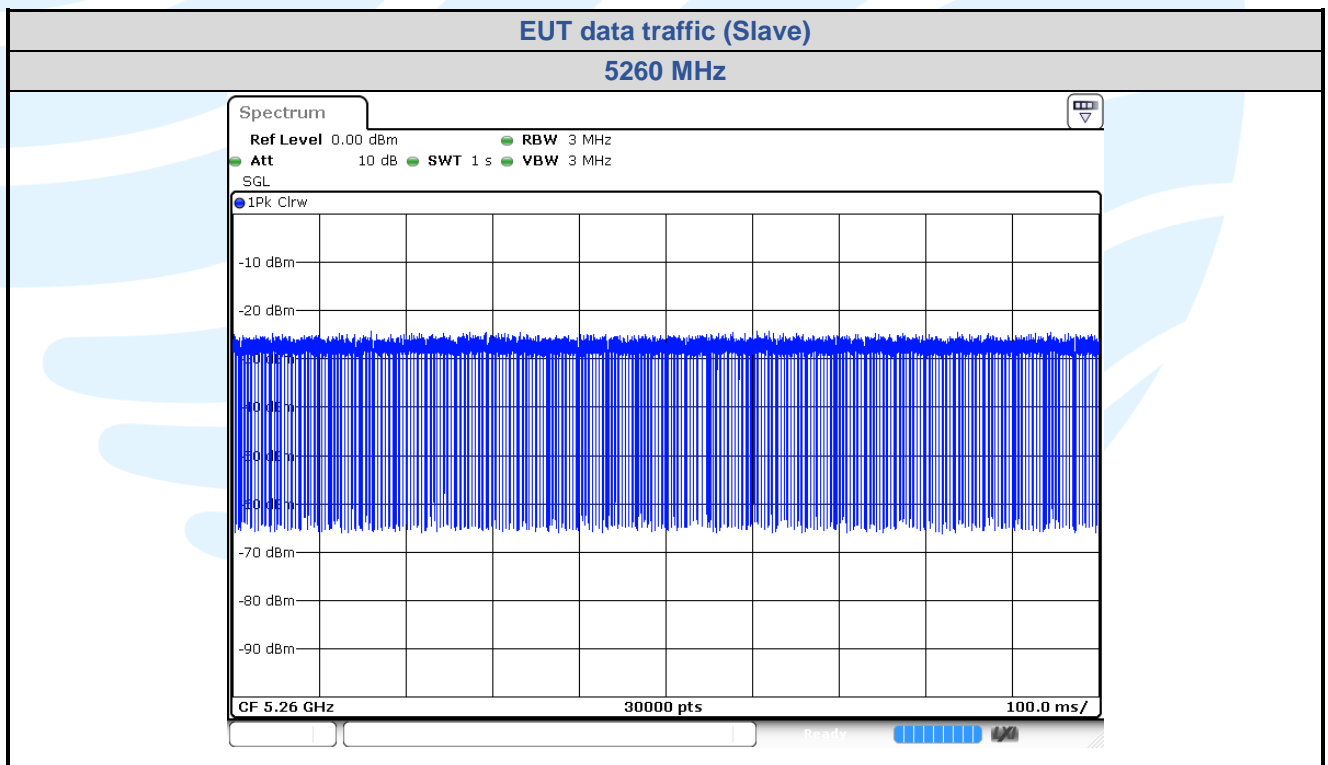
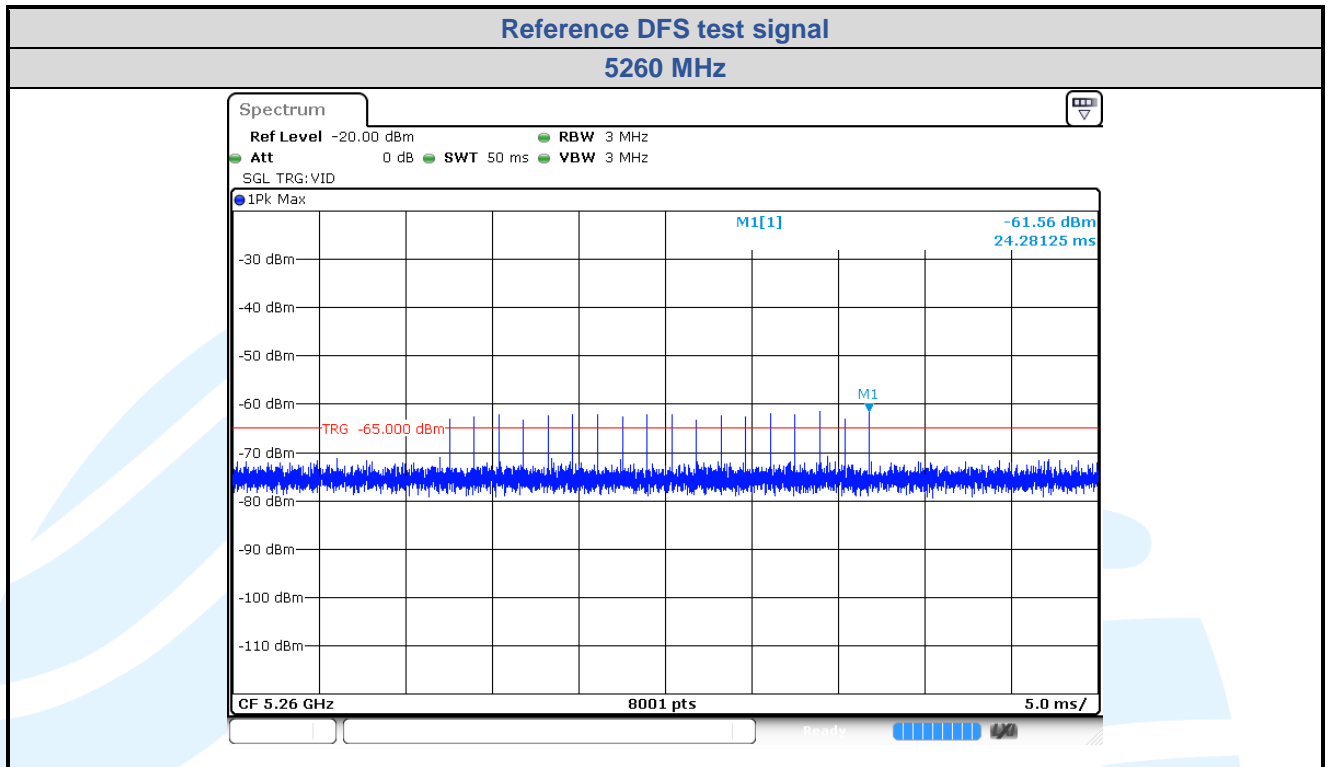

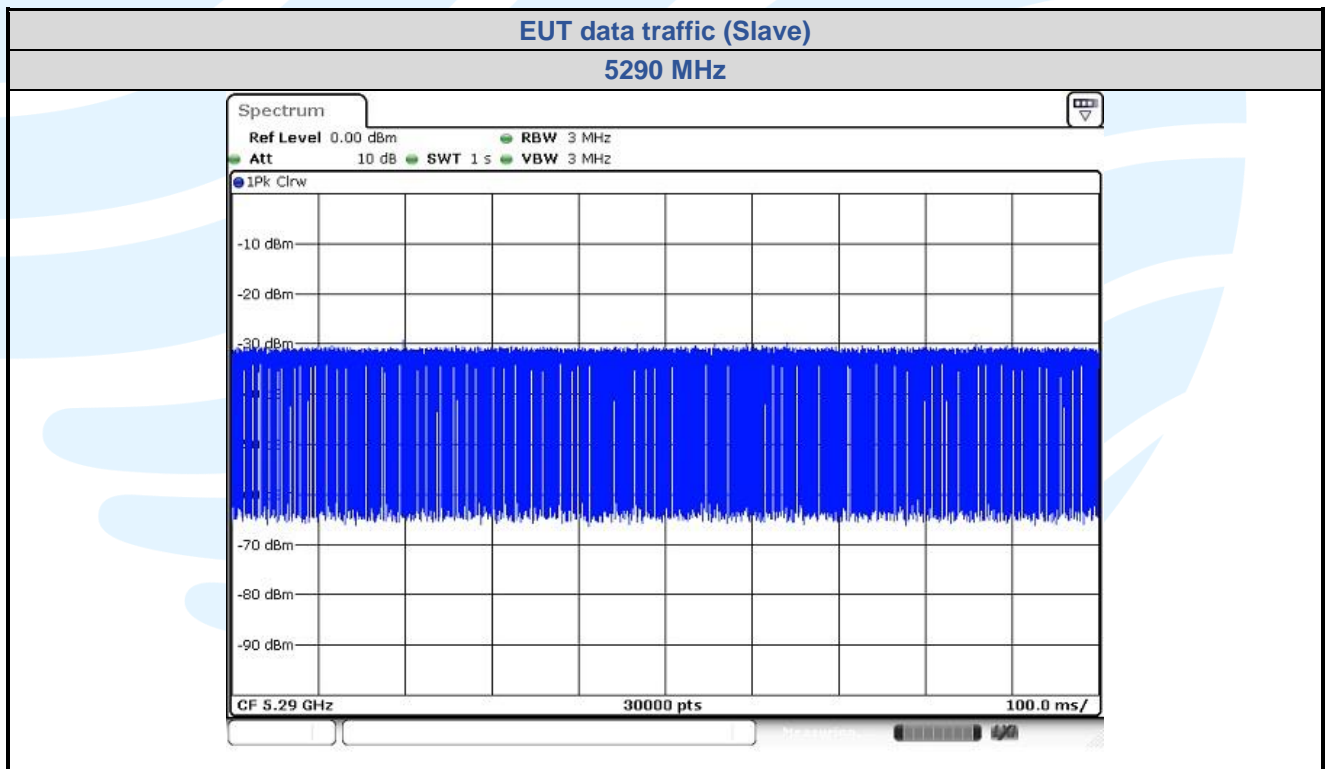
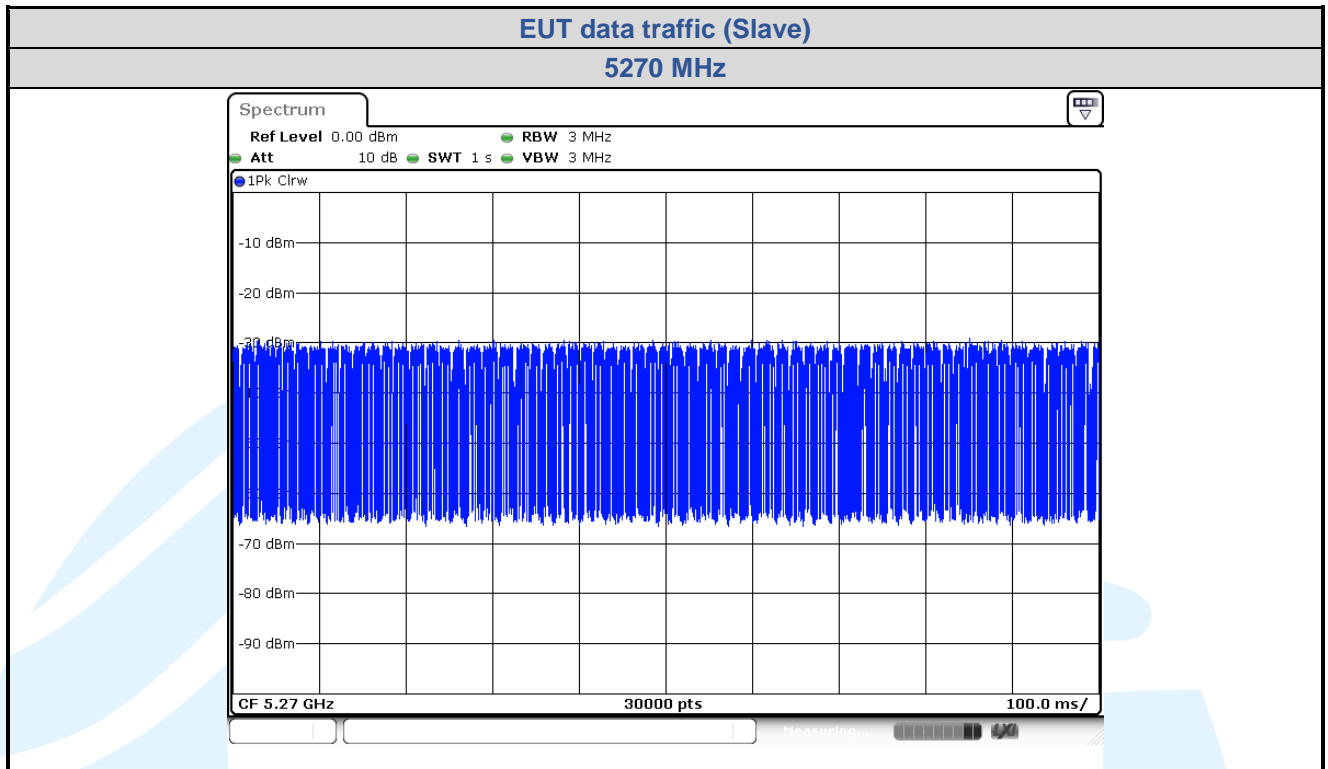

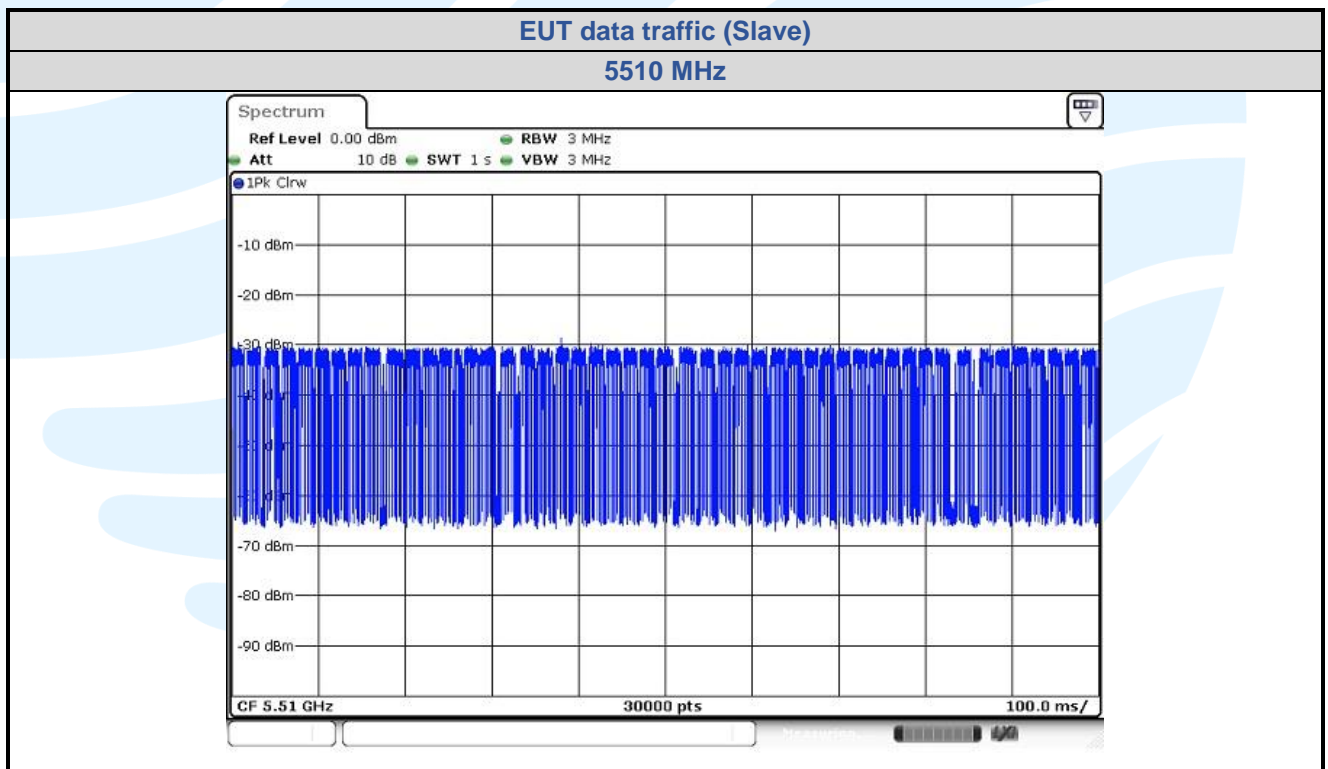
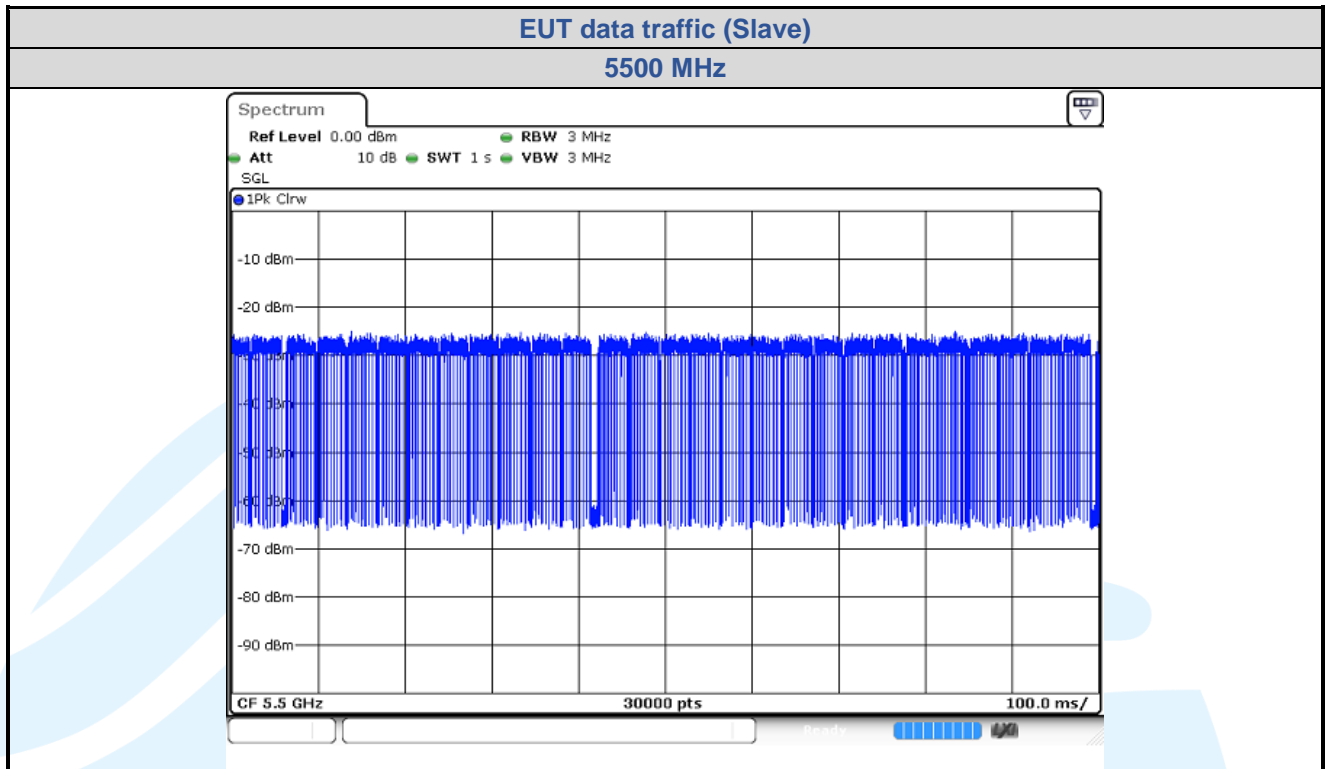

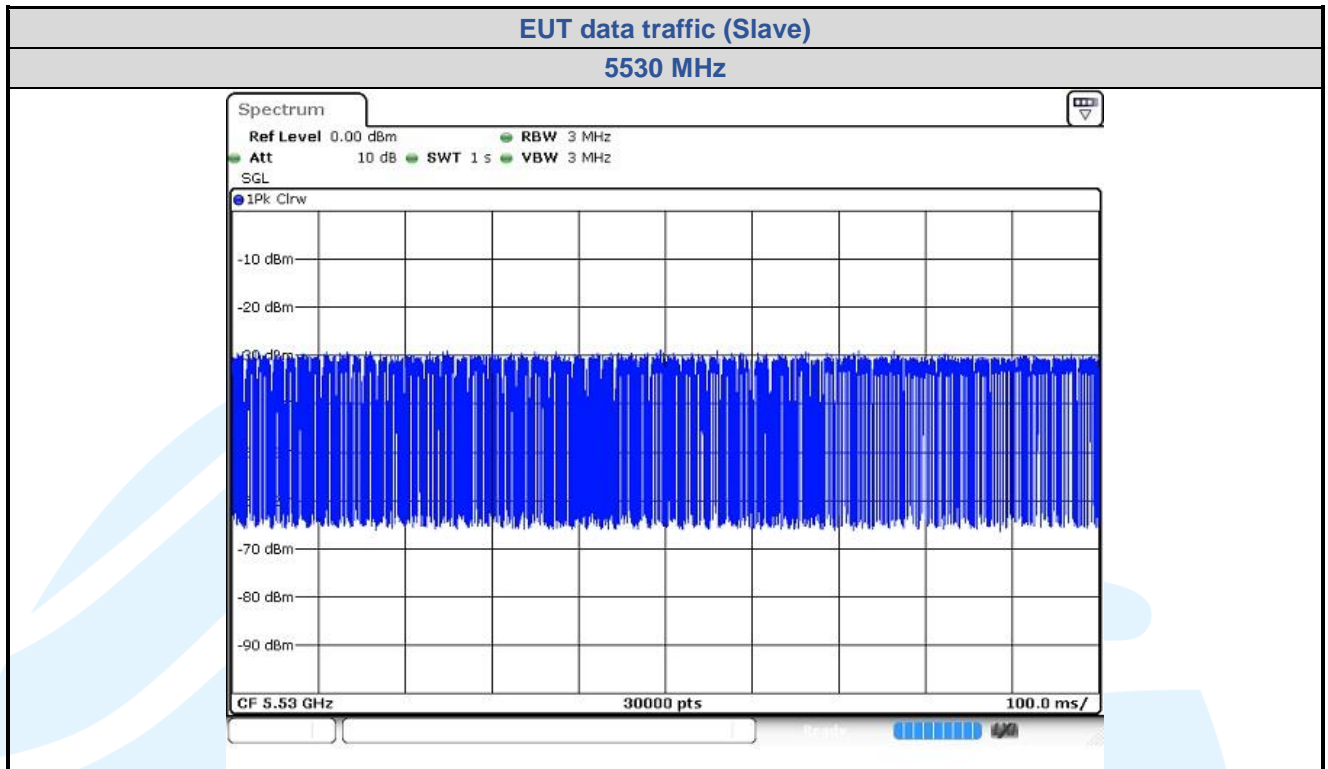

TEST CONFIGURATION

Setup for Client with injection at the Master

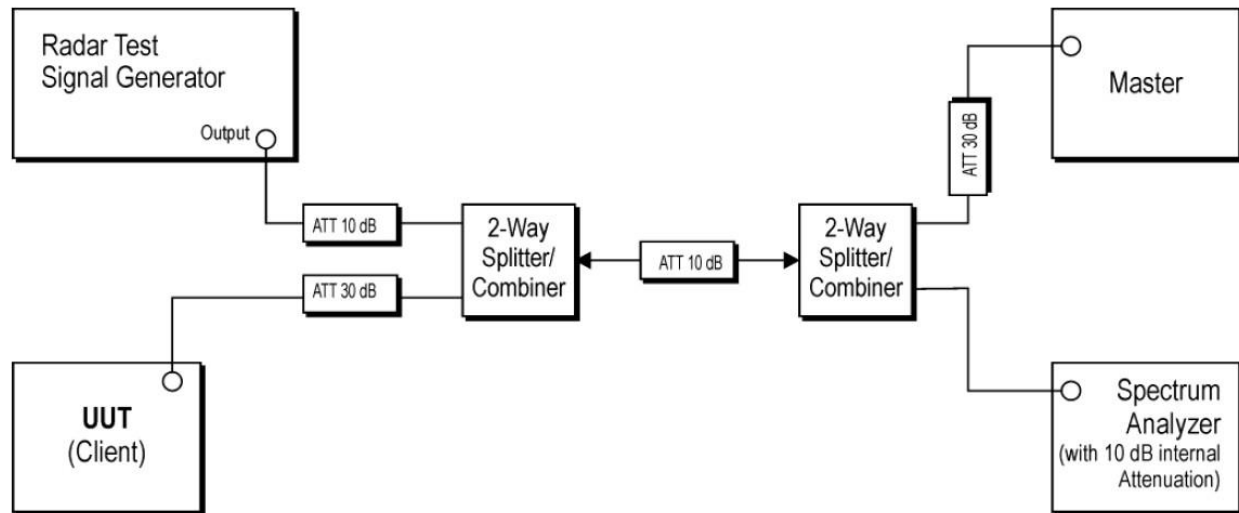

TEST PROCEDURE

1. The radar pulse generator is setup to provide a pulse at frequency that the master and client are operating. A type 0 radar pulse with a 1us pulse width and a 1428us PRI is used for the testing.
2. The vector signal generator is adjusted to provide the radar burst (18 pulses) at the level of approximately -61dBm at the antenna port of the master device
3. A trigger is provided from the pulse generator to the DFS monitoring system in order to capture the traffic and the occurrence of the radar pulse.
4. EUT will associate with the master at channel. The file "iperf.exe" specified by the FCC is streamed from the PC 2 through the master and the client device to the PC 1 and played in full motion video using Media Player Classic Ver. 6.4.8.6 in order to properly load the network for the entire period of the test.
5. When radar burst with a level equal to the DFS Detection Threshold +1dB is generated on the operating channel of the U-NII device. At time T0 the radar waveform generator sends a burst of pulse of the radar waveform at Detection Threshold +1dB.
6. Observe the transmissions of the EUT at the end of the radar Burst on the Operating Channel Measure and record the transmissions from the UUT during the observation time (Channel Move Time). One 15 seconds plot is reported for the Short Pulse Radar Type 0. The plot for the Short Pulse Radar Types start at the end of the radar burst. The Channel Move Time will be calculated based on the zoom in 600ms plot of the Short Pulse Radar Type
7. Measurement of the aggregate duration of the Channel Closed Transmission Time method. With the spectrum analyzer set to zero span tuned to the center frequency of the EUT operating channel at the radar simulated frequency, peak detection, and max hold, the dwell time per bin is given by: $Dwell (0.3ms) = S (12000ms) / B (4000)$; where Dwell is the dwell time per spectrum analyzer sampling bin, S is sweep time and B is the number of spectrum analyzer sampling bins. An upper bound of the aggregate duration of the intermittent control signals of Channel Closing Transmission Time is

Shenzhen UnionTrust Quality and Technology Co., Ltd.

calculated by: $C \text{ (ms)} = N \times \text{Dwell (0.3ms)}$; where C is the Closing Time, N is the number of spectrum analyzer sampling bins (intermittent control signals) showing a U-NII transmission and Dwell is the dwell time per bin.

8. Measurement the EUT for more than 30 minutes following the channel move time to verify that no transmission or beacons occur on this channel.

TEST MODE:

Please refer to the clause 3.3

TEST RESULTS

Passed **Not Applicable**

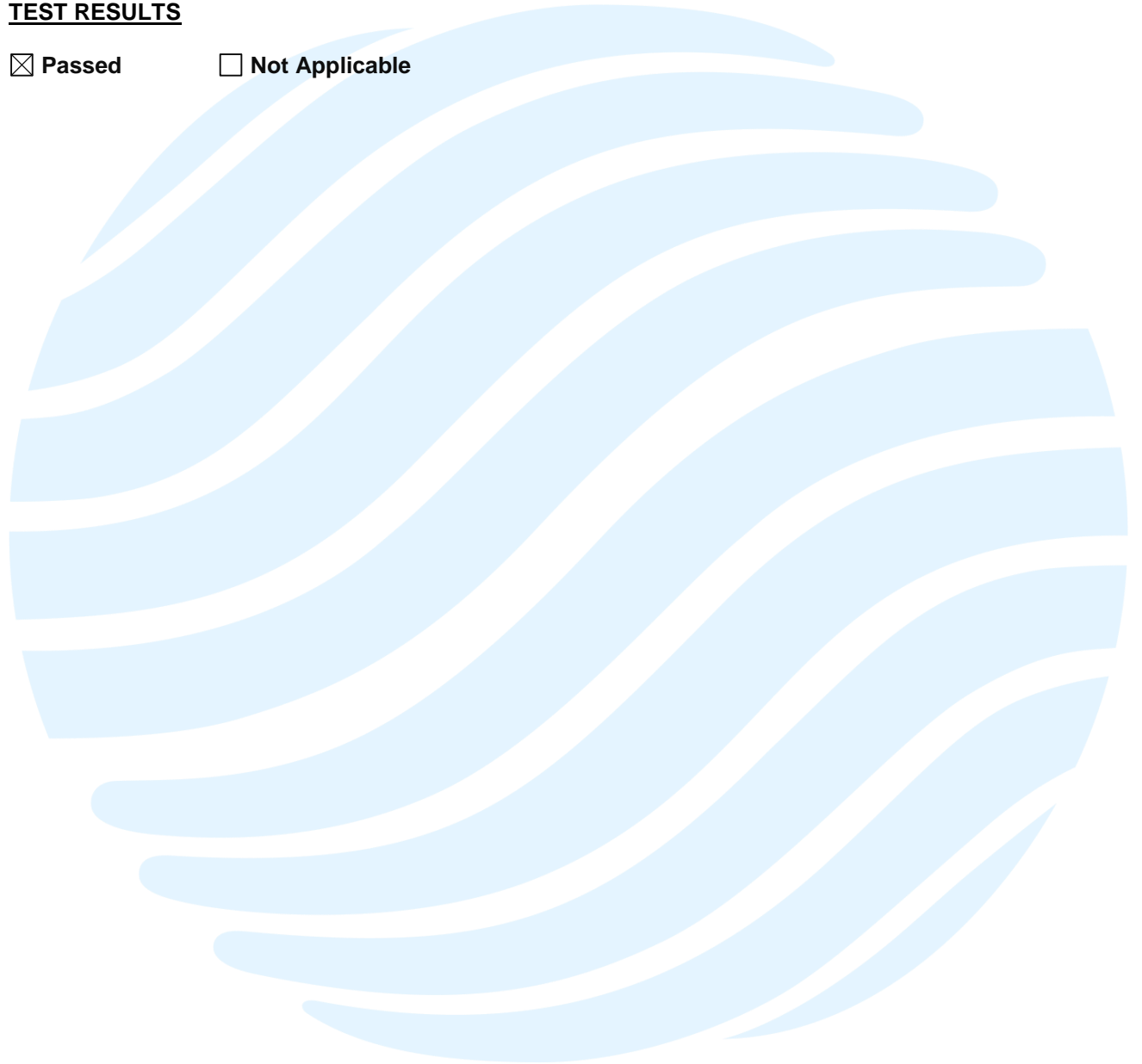

BW/Channel	Test Item	Test Result	Limit	Result
20MHz/5260MHz	Channel Move Time	3.884s	< 10s	Pass
	Channel Closing Transmission Time	0.088s	< 200+60ms	Pass
20MHz/5500MHz	Channel Move Time	3.712s	< 10s	Pass
	Channel Closing Transmission Time	0.092s	< 200+60ms	Pass
40MHz/5270MHz	Channel Move Time	3.845s	< 10s	Pass
	Channel Closing Transmission Time	0.082s	< 200+60ms	Pass
40MHz/5510MHz	Channel Move Time	4.112s	< 10s	Pass
	Channel Closing Transmission Time	0.088s	< 200+60ms	Pass
80MHz/5290MHz	Channel Move Time	4.055s	< 10s	Pass
	Channel Closing Transmission Time	0.085s	< 200+60ms	Pass
80MHz/5530MHz	Channel Move Time	3.903s	< 10s	Pass
	Channel Closing Transmission Time	0.081s	< 200+60ms	Pass

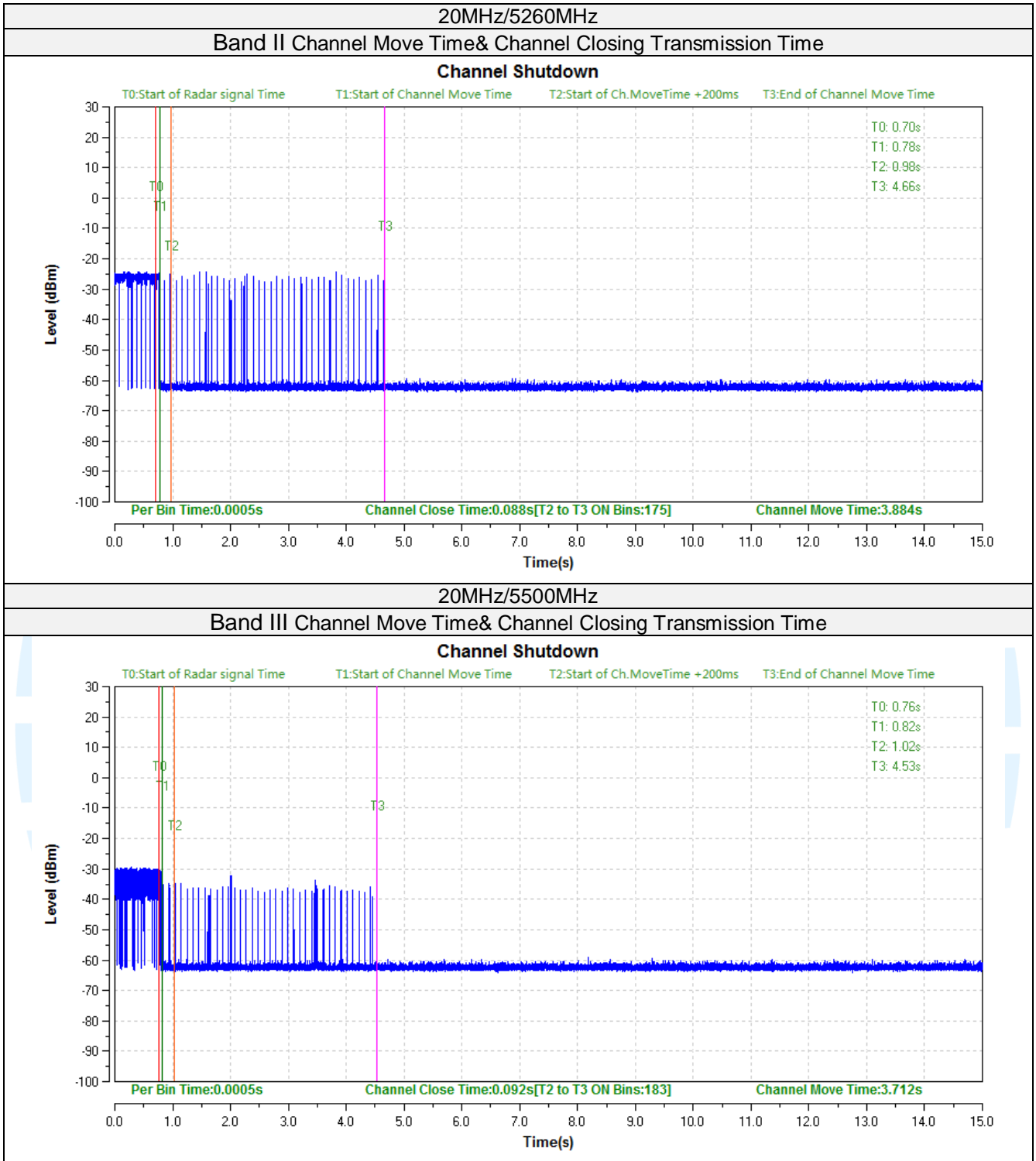

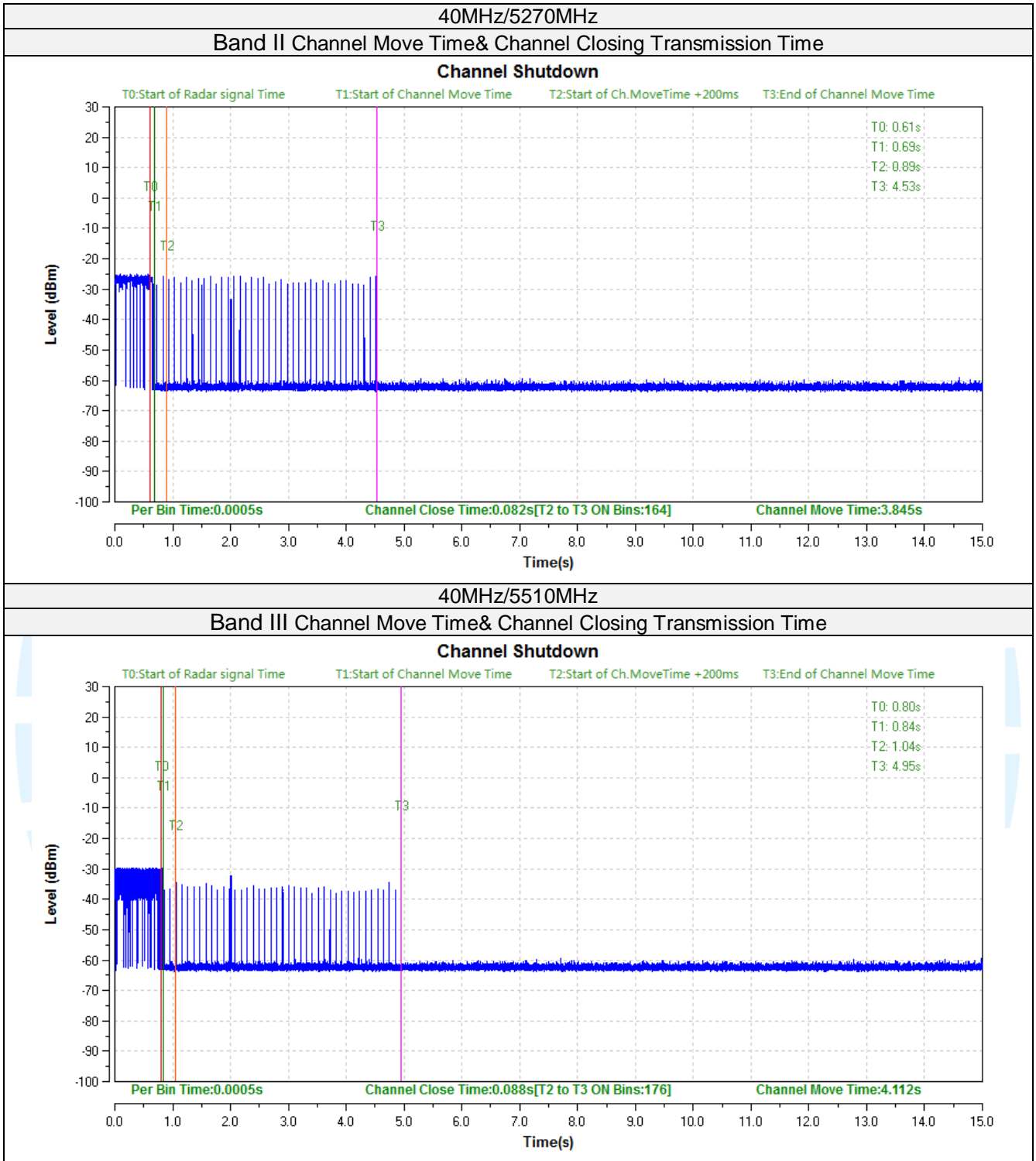

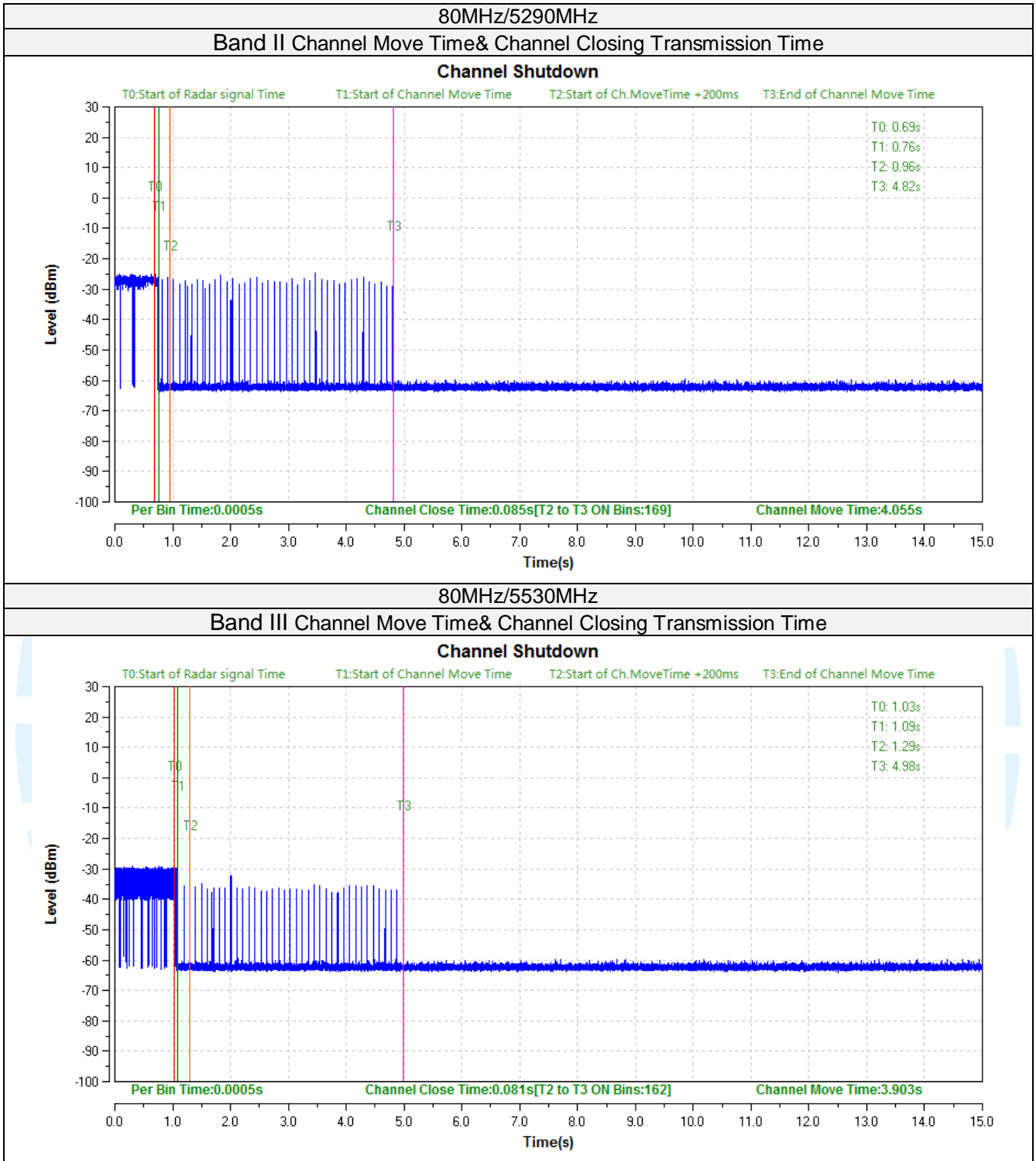

6. Test Setup Photos of the EUT

Conducted Emissions

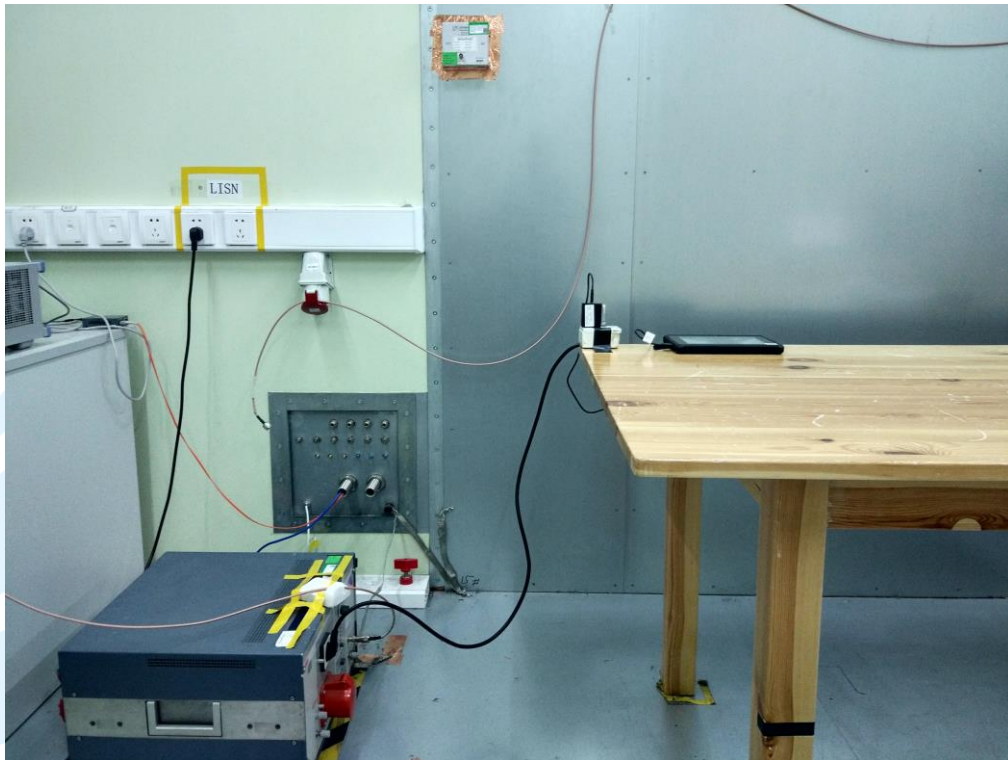

Radiated Emissions

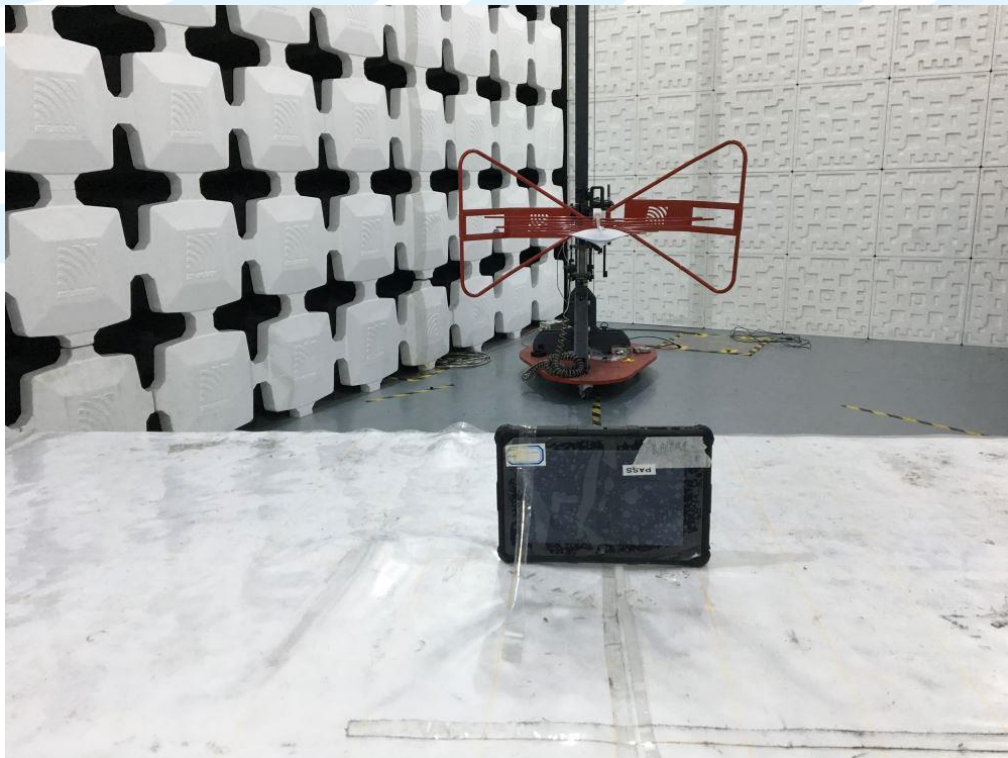

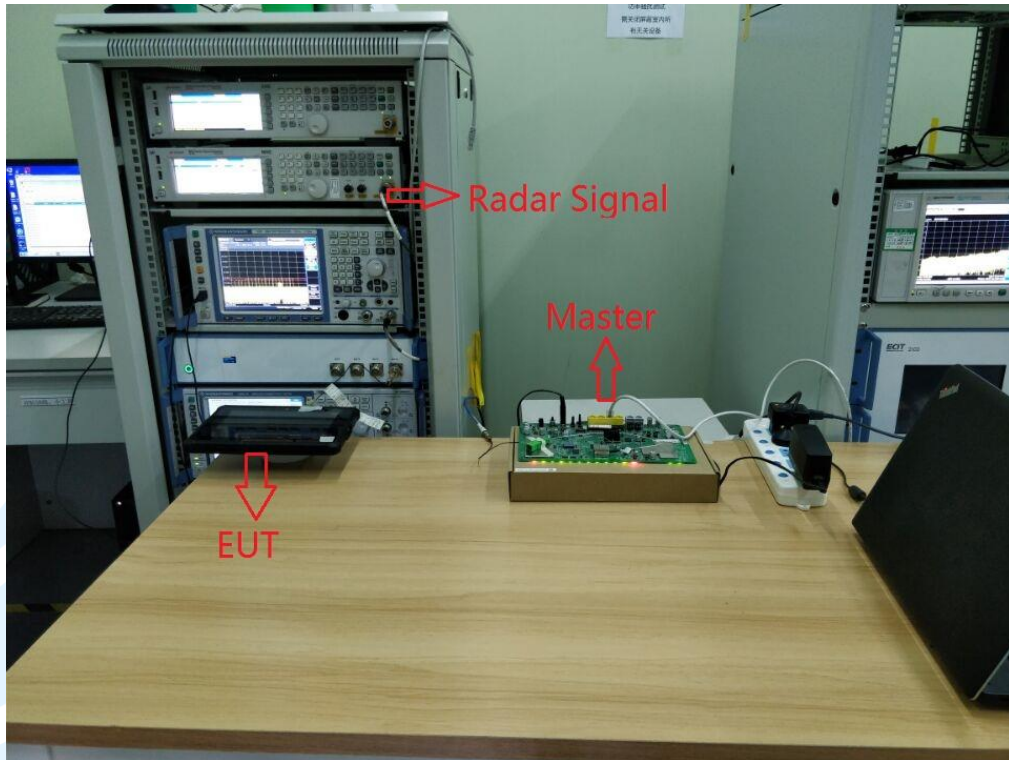

7. External and Internal Photos of the EUT

Reference to the test report No.: TRE1712001101.

-----End of Report-----

