

# SAR

*Dipole & Waveguide*

## Performance Measurement Report

ISSUED BY  
Shenzhen BALUN Technology Co., Ltd.



FOR  
Validation Dipoles & Waveguide

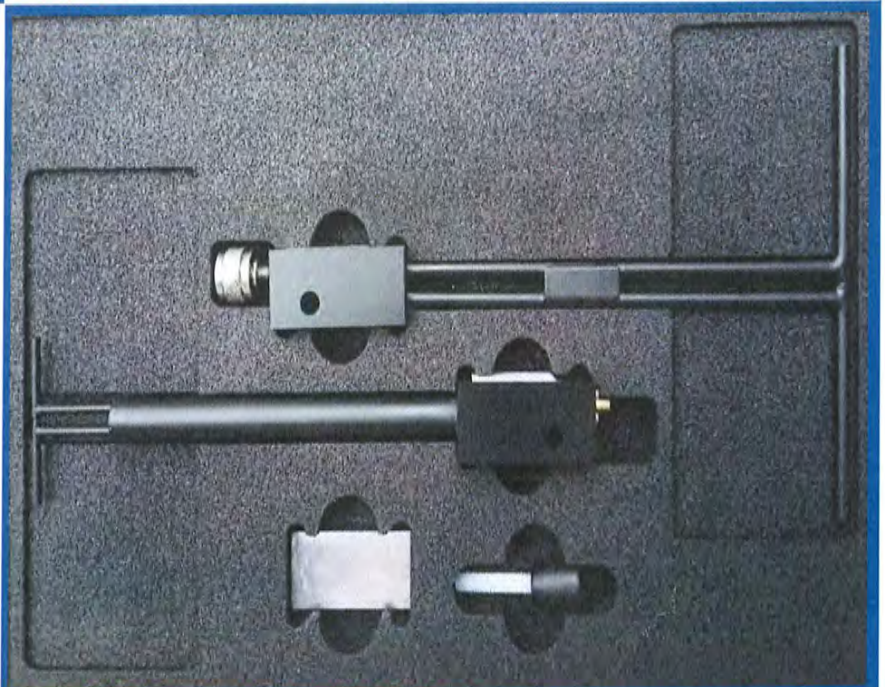

Tested by:



Tu Lang  
(Engineer)

Approved by:

Liao Jianming  
(Technical Director)

Report No.: LW-SZ15C0264-701

EUT Type: SAR Validation Dipole and Waveguide

Model Name: DIP 0G450-252, DIP 0G750-253  
DIP 0G835-246, DIP 0G900-247  
DIP 1G800-248, DIP 1G900-249  
DIP 2G000-250, DIP 2G450-251  
DIP 2G600-25, SWG5500

Brand Name: SATIMO

Test Conclusion: Pass

Test Date: Mar. 1, 2016 ~ Mar. 3, 2016

Date of Issue: Mar. 31, 2016

*NOTE: This test report can be duplicated completely for the legal use with the approval of the applicant; it shall not be reproduced except in full, without the written approval of Shenzhen BALUN Technology Co., Ltd. BALUN Laboratory. Any objections should be raised within thirty days from the date of issue. To validate the report, please visit BALUN website.*



# 1 GENERAL INFORMATION

## 1.1 Introduction

This document contains a summary of the requirements set forth by the IEEE 1528, FCC KDB 865664 D01 for reference dipoles used for SAR measurement system validations. Instead of the typical annual calibration recommended by measurement standards, the reference dipoles were demonstrated that the SAR target, impedance and return loss have remain stable, so the longer calibration interval is acceptable.

## 1.2 General Description for Equipment under Test (EUT)

Model	Frequency	Serial Number	Product Condition (New/ Used)	Last Cal. Date
<b>Dipole</b>				
DIP 0G450	450 MHz	SN 25/13 DIP 0G450-252	Used	2015/03/16
DIP 0G750	750 MHz	SN 25/13 DIP 0G750-253	Used	2015/03/16
DIP 0G835	835 MHz	SN 25/13 DIP 0G835-246	Used	2015/03/16
DIP 0G900	900 MHz	SN 25/13 DIP 0G900-247	Used	2015/03/16
DIP 1G800	1800 MHz	SN 25/13 DIP 1G900-248	Used	2015/03/16
DIP 1G900	1900 MHz	SN 25/13 DIP 1G900-249	Used	2015/03/16
DIP 2G000	2000 MHz	SN 25/13 DIP 2G000-250	Used	2015/03/16
DIP 2G450	2450 MHz	SN 25/13 DIP 2G450-251	Used	2015/03/16
DIP 2G600	2600 MHz	SN 25/13 DIP 2G600-254	Used	2015/03/16
<b>Waveguide</b>				
SWG5500	5GHz-6GHz	SN 30/13 WGA24	Used	2015/03/16

### 1.3 EUT Photos

DIP 0G450-252



DIP 0G750-253



DIP 0G835-246



DIP 0G900-247



DIP 1G800-248



DIP 1G900-249



DIP 2G000-250



DIP 2G450-251



DIP 2G600-254



Waveguide SWG5500



## 2 SIMULATING LIQUID VERIFICATION

Liquid Type	Fre. (MHz)	Meas. Conductivity ( $\sigma$ ) (S/m)	Meas. Permittivity ( $\epsilon$ )	Target Conductivity ( $\sigma$ ) (S/m)	Target Permittivity ( $\epsilon$ )	Conductivity Tolerance (%)	Permittivity Tolerance (%)
Head	450	0.89	42.87	0.87	43.50	2.30	-1.45
Body		0.96	55.70	0.94	56.70	2.13	-1.76
Head	750	0.88	41.92	0.89	41.94	-1.12	-0.05
Body		0.95	57.19	0.96	55.53	-1.04	2.99
Head	835	0.90	43.33	0.90	41.50	0.00	4.41
Body		0.99	54.65	0.97	55.20	2.06	-1.00
Head	900	0.99	41.14	0.97	41.50	2.06	-0.87
Body		1.06	54.93	1.05	55.00	0.95	-0.13
Head	1800	1.41	39.56	1.40	40.00	0.71	-1.10
Body		1.51	54.69	1.52	53.30	-0.66	2.61
Head	1900	1.42	39.40	1.40	40.00	1.43	-1.50
Body		1.53	53.16	1.52	53.30	0.66	-0.26
Head	2000	1.43	38.96	1.40	40.00	2.14	-2.60
Body		1.55	51.53	1.52	53.30	1.97	-3.32
Head	2450	1.82	38.92	1.80	39.20	1.11	-0.71
Body		1.96	52.96	1.95	52.70	0.51	0.49
Head	2600	1.98	38.10	1.96	39.01	1.02	-2.33
Body		2.15	53.51	2.16	52.51	-0.46	1.90
Head	5200	4.64	36.87	4.66	35.99	-0.43	2.45
Body		5.26	50.13	5.30	49.01	-0.75	2.29
Head	5400	4.83	36.43	4.86	35.76	-0.62	1.87
Body		5.51	50.02	5.53	48.74	-0.36	2.63
Head	5600	5.14	34.46	5.07	35.53	1.38	-3.01
Body		5.93	48.04	5.77	48.47	2.77	-0.89
Head	5800	5.31	34.33	5.27	35.30	0.76	-2.75
Body		6.07	47.14	6.00	48.20	1.17	-2.20



### 3 DIPOLE IMPEDANCE AND RETURN LOSS

The dipoles are designed to have low return loss when presented against a flat phantom at the specified distance. A Vector Network Analyzer was used to perform a return loss measurement on the specific dipole when in the measurement location against the phantom and the distance was specified by the manufacturer with a special, low loss and low relative permittivity spacer.

The impedance was measured at the SMA-connector with the network analyzer.

The measurement of verification with return loss should not deviate by more than 20% and minimum of 20 dB of the return loss, and the impedance (real or imaginary parts) should not deviate by more than 5 Ohms from the previous measurement using network analyzer.

Note:

The "Previous Meas." in the following table refer to dipoles or other equivalent RF sources calibration reports.



### 3.1 DIP 0G450

#### RETURN LOSS AND IMPEDANCE IN HEAD LIQUID

Meas. Results	Current Meas.	Previous Meas.	Max. Deviation
Return Loss (dB)	-40.92	-43.03	4.9 %
Impedance	50.7 $\Omega$ - 3.9 j $\Omega$	49.7 $\Omega$ - 0.6 j $\Omega$	3.3 $\Omega$ (Imaginary part)

#### Return Loss

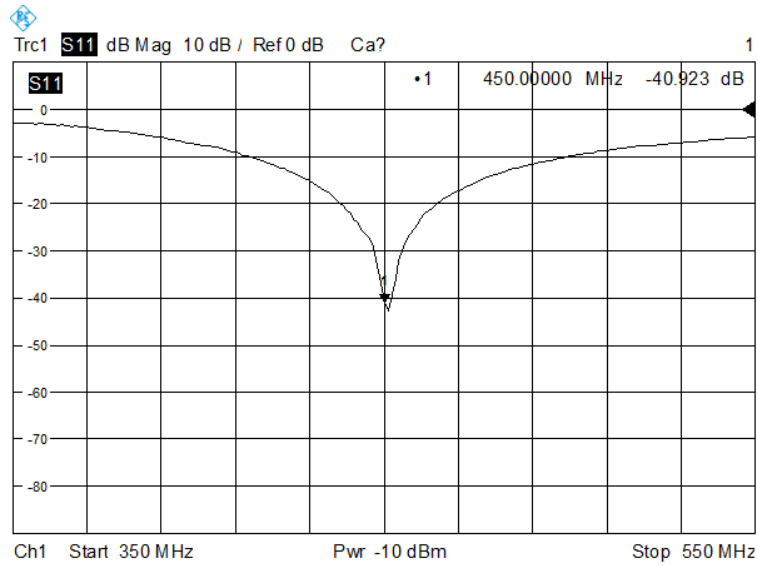

#### Impedance

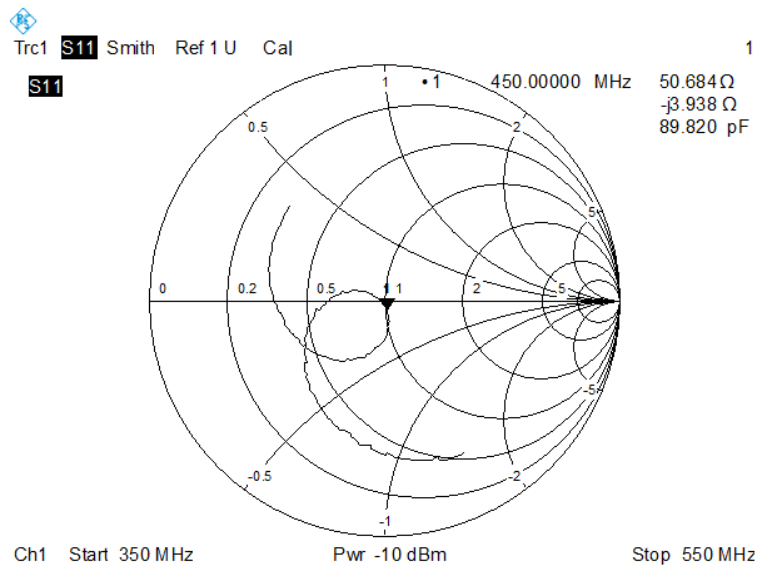





**RETURN LOSS AND IMPEDANCE IN BODY LIQUID**

Meas. Results	Current Meas.	Previous Meas.	Max. Deviation
Return Loss (dB)	-27.87	-33.70	17.3 %
Impedance	46.0 $\Omega$ - 4.99 j $\Omega$	47.6 $\Omega$ - 0.4 j $\Omega$	4.59 j $\Omega$

**Return Loss**

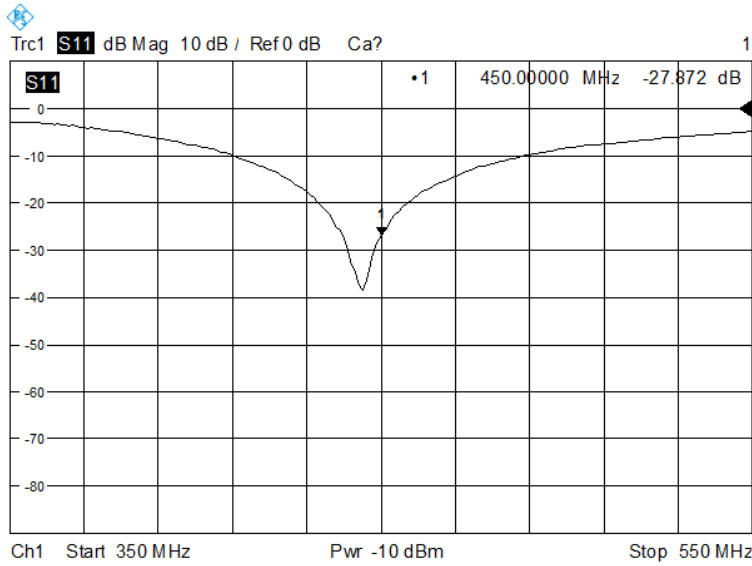

**Impedance**

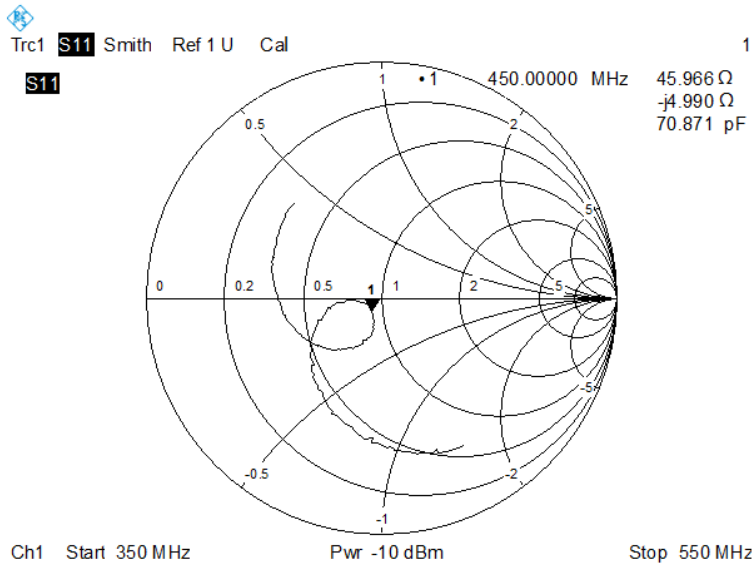



### 3.2 DIP 0G750

#### RETURN LOSS AND IMPEDANCE IN HEAD LIQUID

Meas. Results	Current Meas.	Previous Meas.	Max. Deviation
Return Loss (dB)	-24.73	-25.86	4.4 %
Impedance	56.1 $\Omega$ - 1.3 j $\Omega$	54.5 $\Omega$ - 2.7 j $\Omega$	1.6 $\Omega$ (Real part)

#### Return Loss

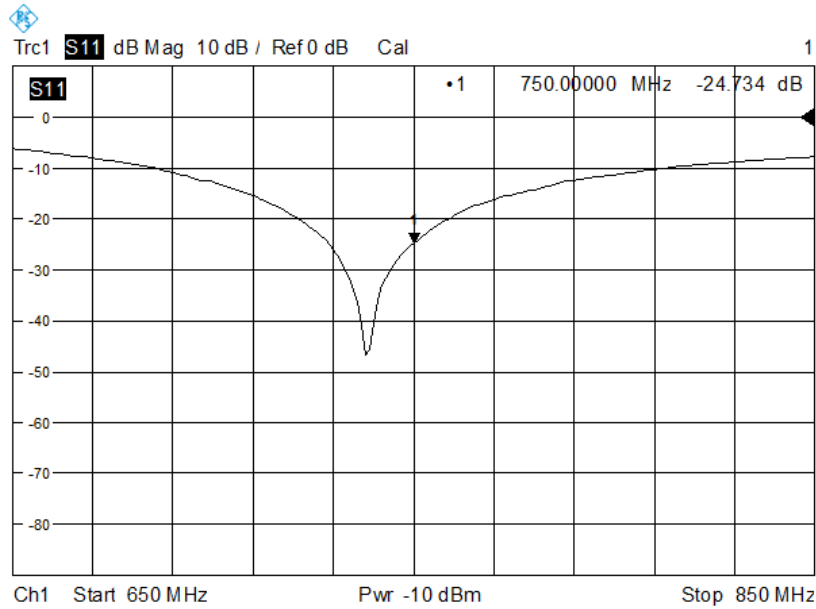

#### Impedance

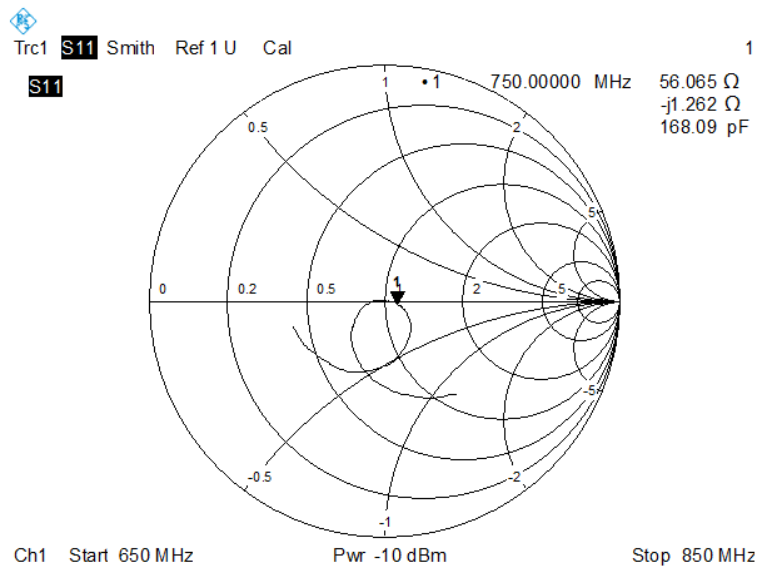



**RETURN LOSS AND IMPEDANCE IN BODY LIQUID**

Meas. Results	Current Meas.	Previous Meas.	Max. Deviation
Return Loss (dB)	-27.47	-29.45	6.7 %
Impedance	55.8 Ω + 2.6 jΩ	52.6 Ω + 2.3 jΩ	3.2 Ω (Real part)

**Return Loss**

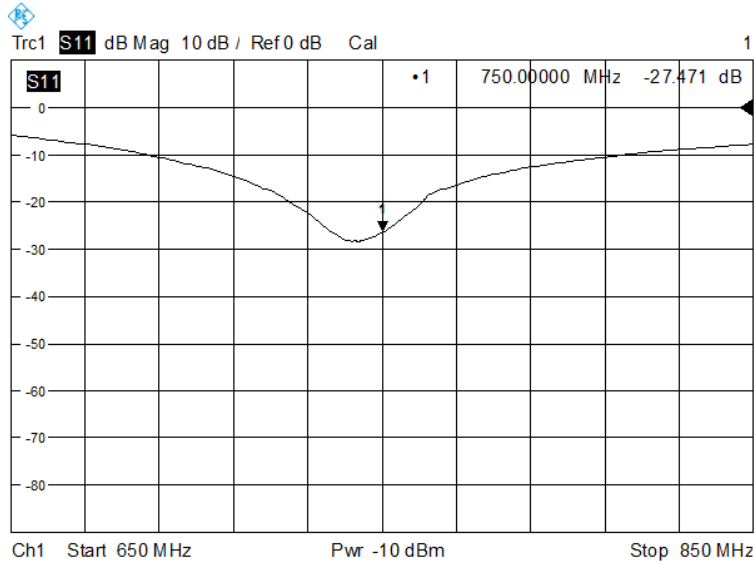

**Impedance**

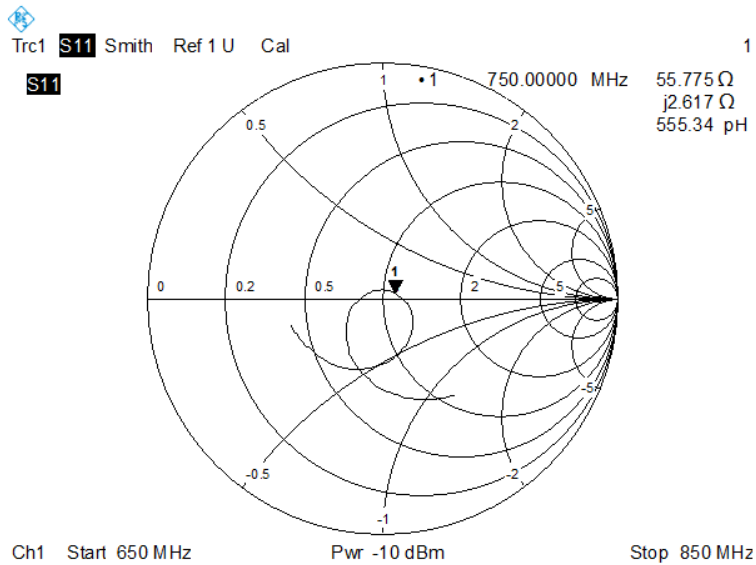



### 3.3 DIP 0G835

#### RETURN LOSS AND IMPEDANCE IN HEAD LIQUID

Meas. Results	Current Meas.	Previous Meas.	Max. Deviation
Return Loss (dB)	-25.89	-25.01	3.5 %
Impedance	55.0 $\Omega$ + 0.7 j $\Omega$	55.9 $\Omega$ + 0.9 j $\Omega$	0.9 $\Omega$ (Real part)

#### Return Loss

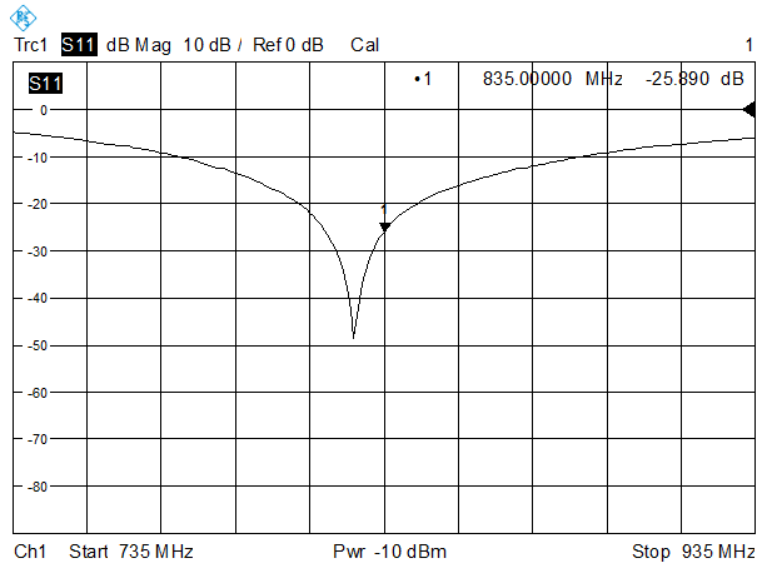

#### Impedance

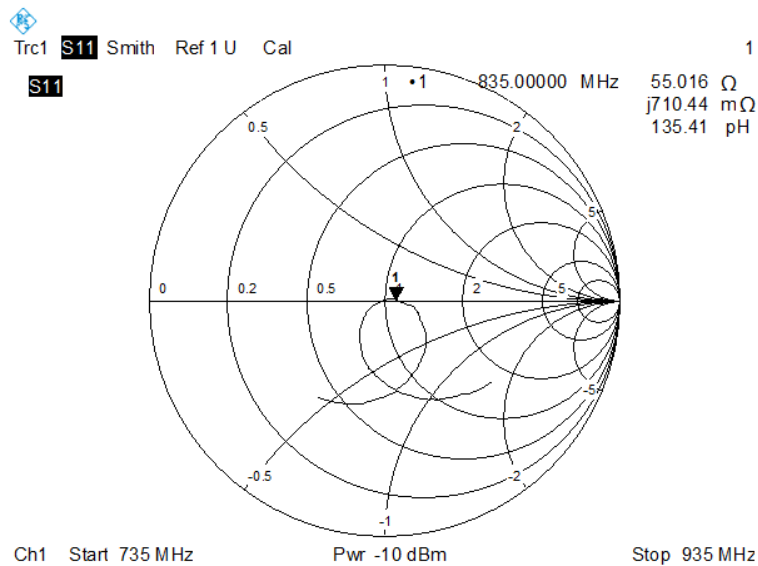



**RETURN LOSS AND IMPEDANCE IN BODY LIQUID**

Meas. Results	Current Meas.	Previous Meas.	Max. Deviation
Return Loss (dB)	-27.60	-27.41	0.7 %
Impedance	53.6 $\Omega$ + 2.5 j $\Omega$	52.1 $\Omega$ + 3.8 j $\Omega$	1.5 $\Omega$ (Real part)

**Return Loss**

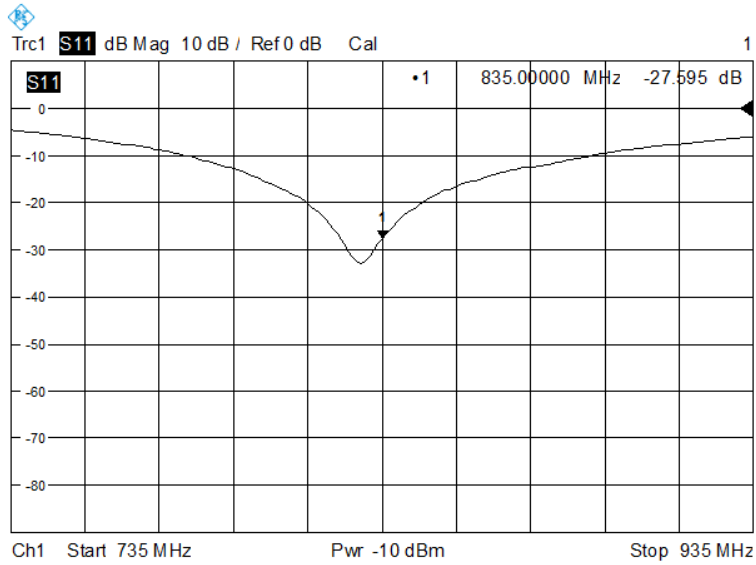

**Impedance**

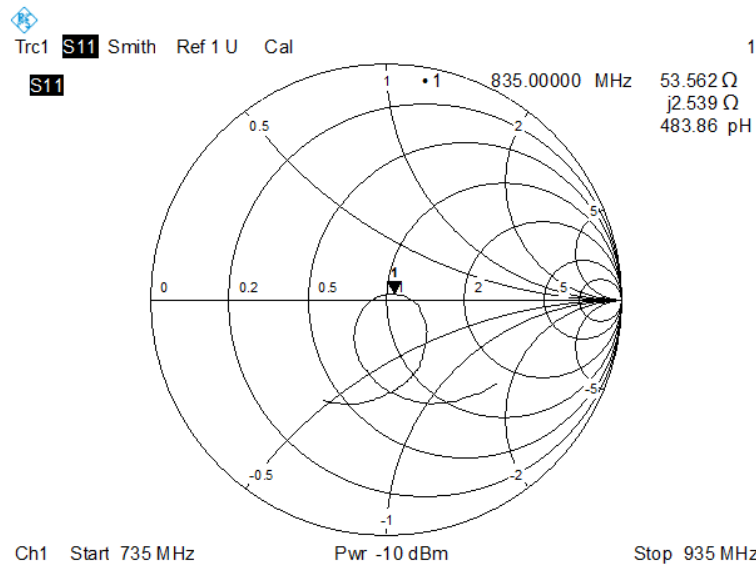



### 3.4 DIP 0G900

#### RETURN LOSS AND IMPEDANCE IN HEAD LIQUID

Meas. Results	Current Meas.	Previous Meas.	Max. Deviation
Return Loss (dB)	-31.9	-36.56	12.8 %
Impedance	53.2 $\Omega$ + 1.4 j $\Omega$	51.5 $\Omega$ + 0.1 j $\Omega$	1.7 $\Omega$ (Real part)

#### Return Loss

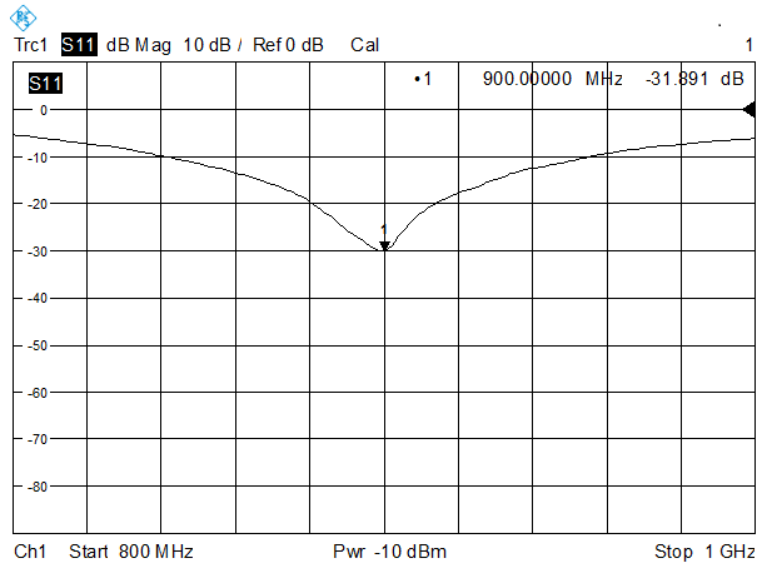

#### Impedance

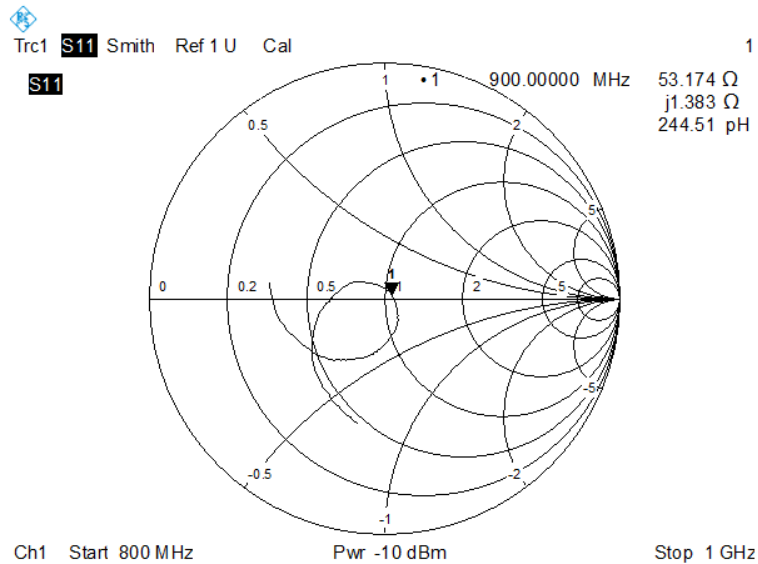

**RETURN LOSS AND IMPEDANCE IN BODY LIQUID**

Meas. Results	Current Meas.	Previous Meas.	Max. Deviation
Return Loss (dB)	-27.20	-25.36	6.8 %
Impedance	53.2 $\Omega$ + 3.2 j $\Omega$	51.9 $\Omega$ + 5.0 j $\Omega$	1.8 $\Omega$ (Imaginary part)

**Return Loss**

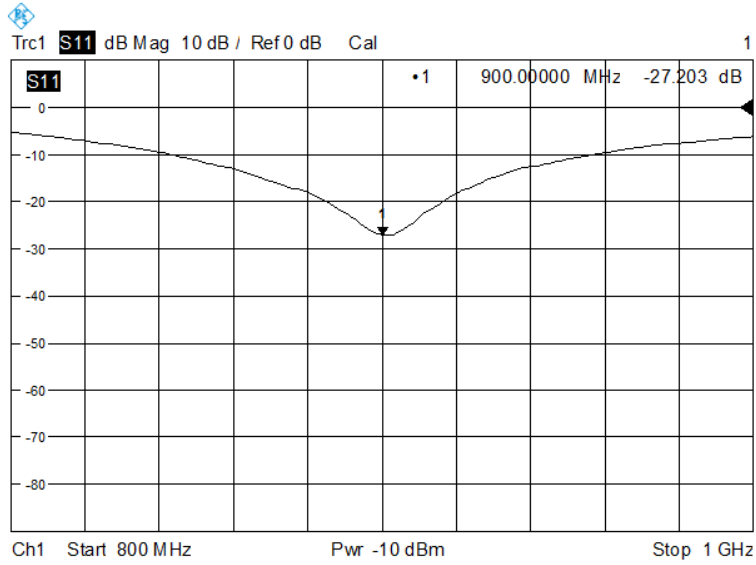

**Impedance**

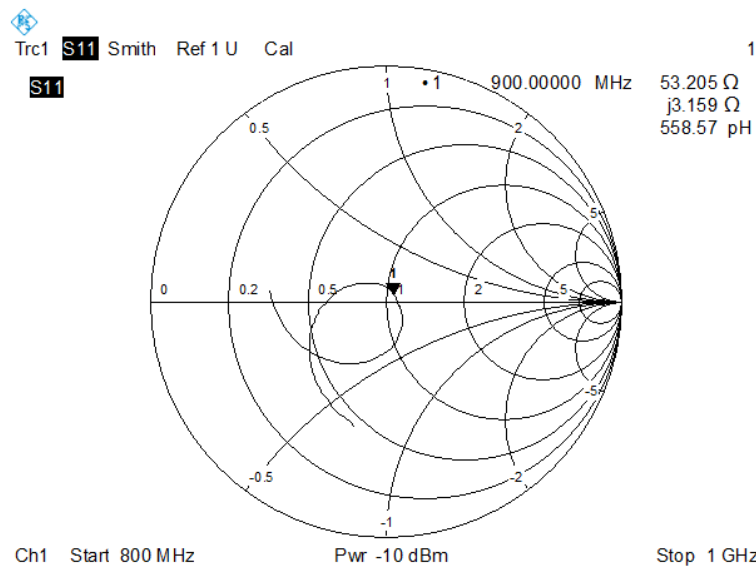



### 3.5 DIP 1G800

#### RETURN LOSS AND IMPEDANCE IN HEAD LIQUID

Meas. Results	Current Meas.	Previous Meas.	Max. Deviation
Return Loss (dB)	-22.41	-23.63	5.2 %
Impedance	42.4 Ω + 3.9 jΩ	45.1 Ω+ 4.0 jΩ	2.7 Ω (Real part)

#### Return Loss

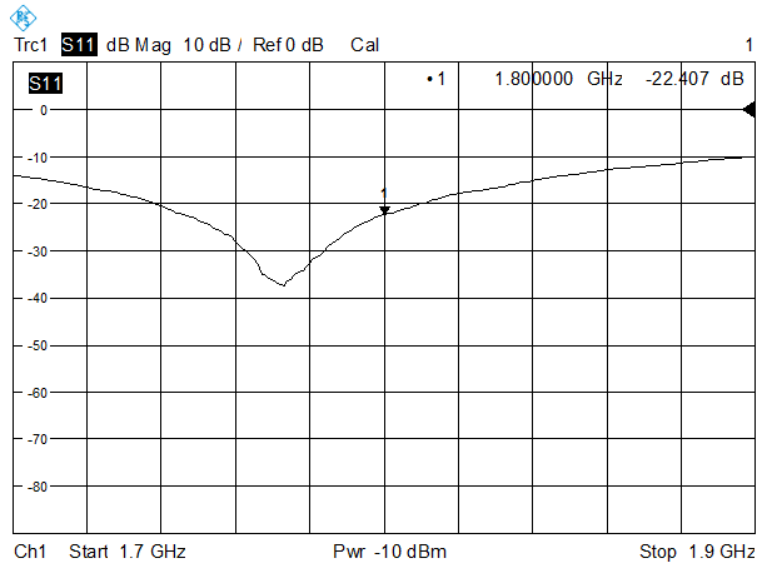

#### Impedance

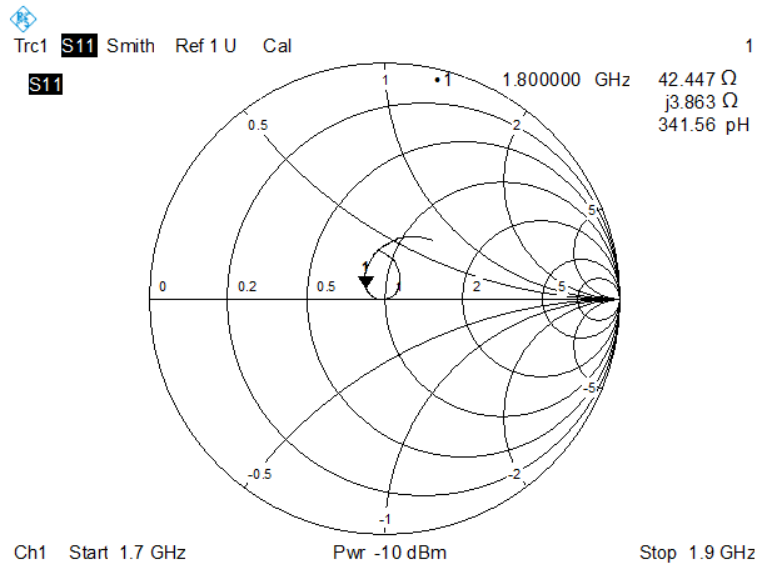





**RETURN LOSS AND IMPEDANCE IN BODY LIQUID**

Meas. Results	Current Meas.	Previous Meas.	Max. Deviation
Return Loss (dB)	-22.09	-26.47	16.5 %
Impedance	42.9 $\Omega$ + 0.7 j $\Omega$	45.5 $\Omega$ - 0.3 j $\Omega$	2.6 $\Omega$ (Real part)

**Return Loss**

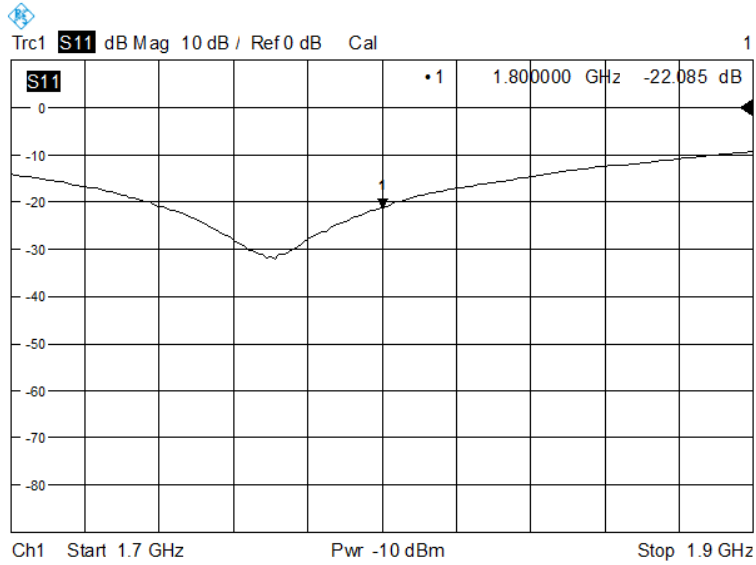

**Impedance**

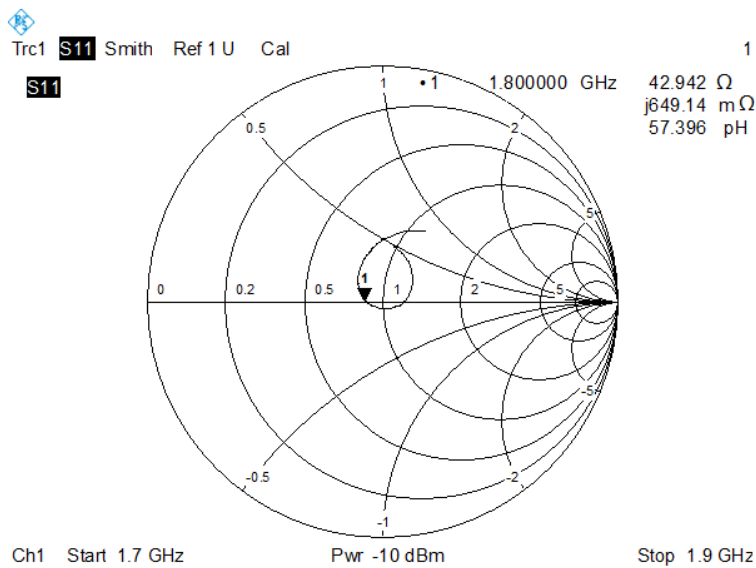



### 3.6 DIP 1G900

#### RETURN LOSS AND IMPEDANCE IN HEAD LIQUID

Meas. Results	Current Meas.	Previous Meas.	Max. Deviation
Return Loss (dB)	-20.99	-21.63	3.0 %
Impedance	56.6 $\Omega$ + 12.2 j $\Omega$	53.9 $\Omega$ + 7.7 j $\Omega$	4.5 $\Omega$ (Imaginary part)

#### Return Loss

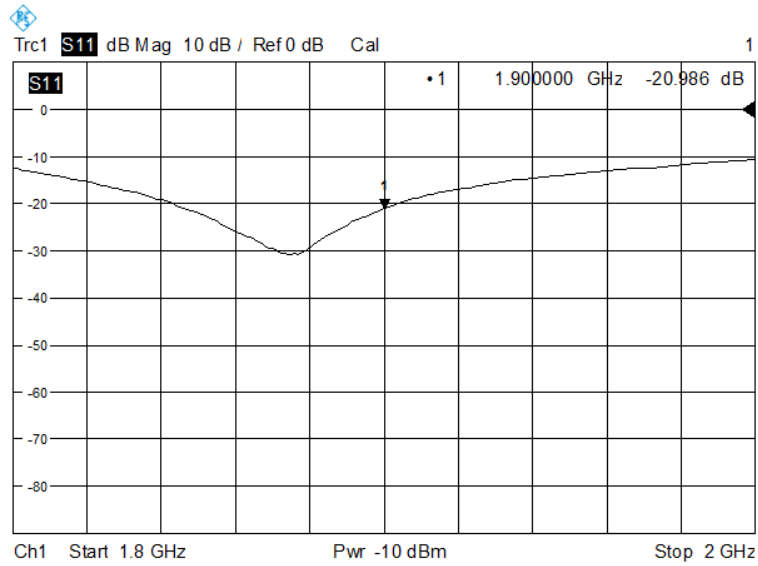

#### Impedance

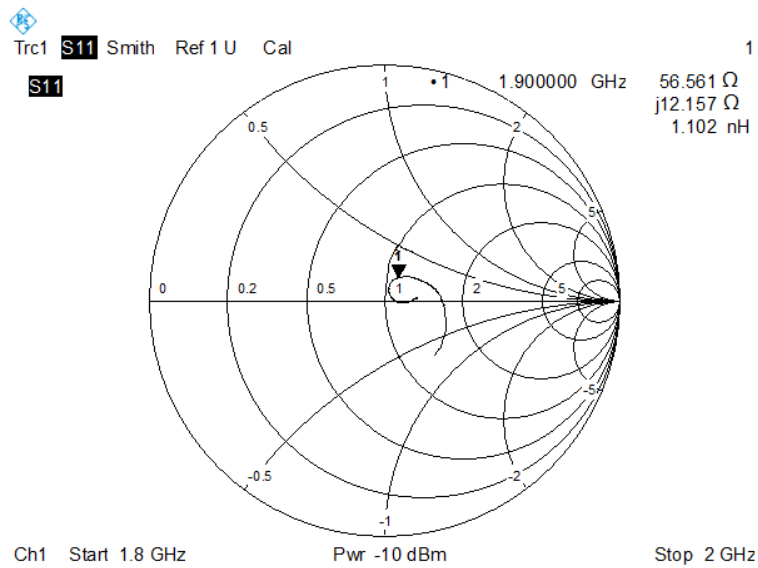



**RETURN LOSS AND IMPEDANCE IN BODY LIQUID**

Meas. Results	Current Meas.	Previous Meas.	Max. Deviation
Return Loss (dB)	-21.79	-21.47	1.5 %
Impedance	51.0 Ω + 13.2 jΩ	48.9 Ω+ 8.4 jΩ	4.8 Ω (Imaginary part)

**Return Loss**

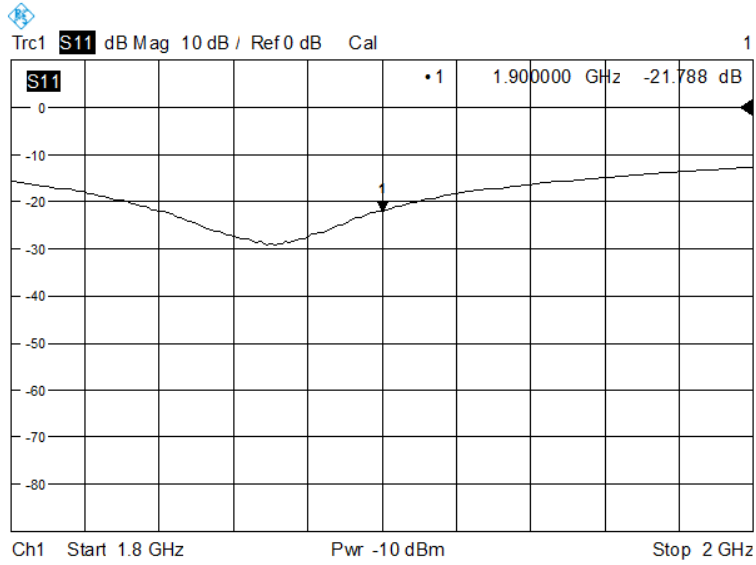

**Impedance**

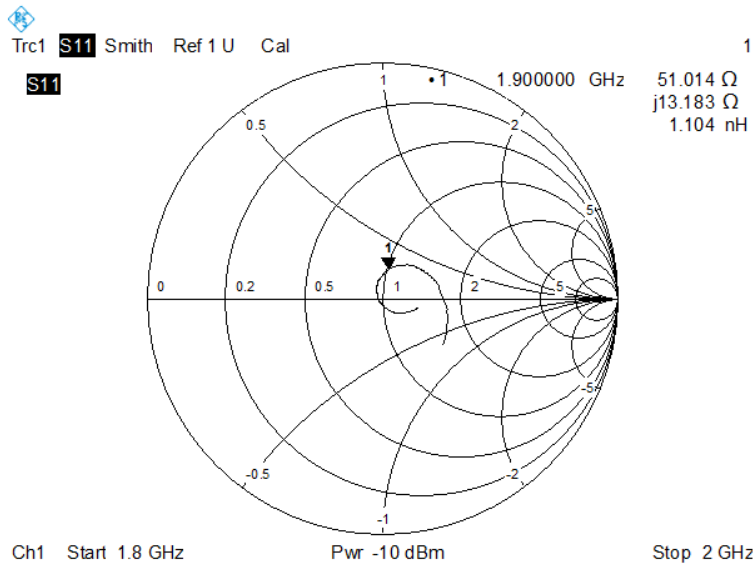

### 3.7 DIP 2G000

#### RETURN LOSS AND IMPEDANCE IN HEAD LIQUID

Meas. Results	Current Meas.	Previous Meas.	Max. Deviation
Return Loss (dB)	-25.62	-27.75	7.7%
Impedance	54.3 $\Omega$ - 4.1 j $\Omega$	54.3 $\Omega$ - 0.4 j $\Omega$	3.7 $\Omega$ (Imaginary part)

#### Return Loss

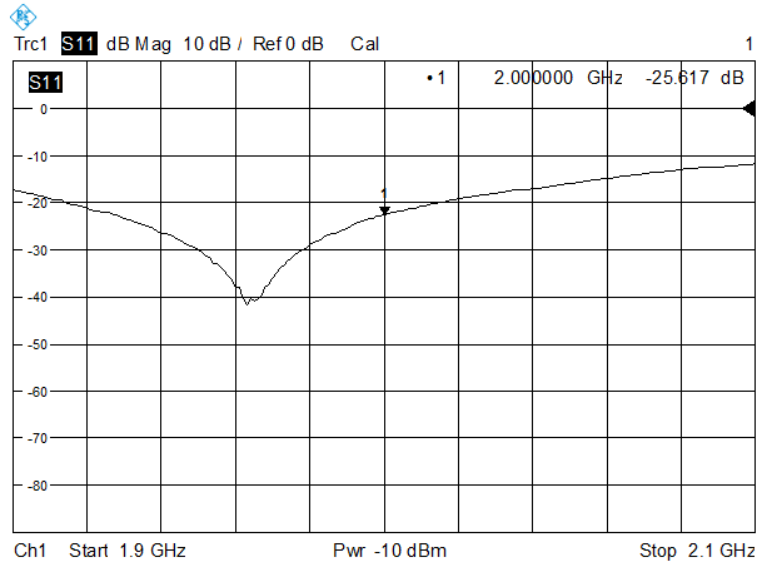

#### Impedance

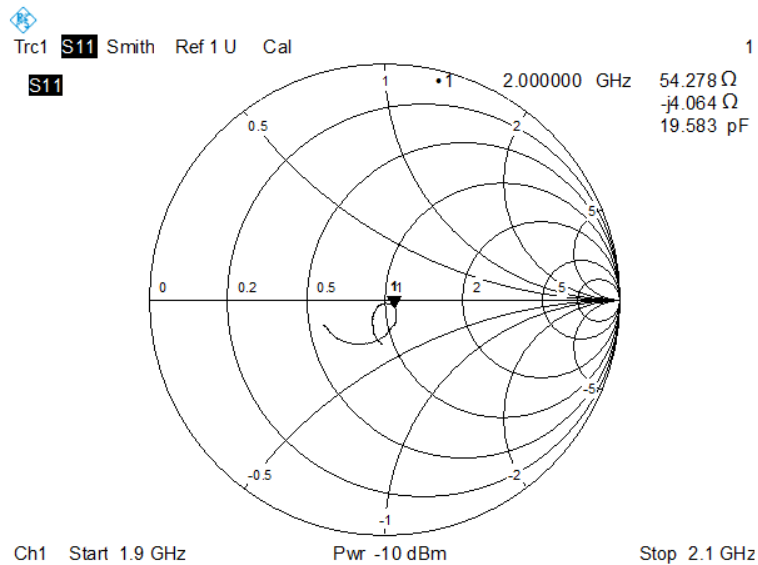



**RETURN LOSS AND IMPEDANCE IN BODY LIQUID**

Meas. Results	Current Meas.	Previous Meas.	Max. Deviation
Return Loss (dB)	-22.40	-24.04	6.8 %
Impedance	55.7 Ω + 2.61 jΩ	55.2 Ω+ 4.1 jΩ	1.49 Ω (Imaginary part)

**Return Loss**

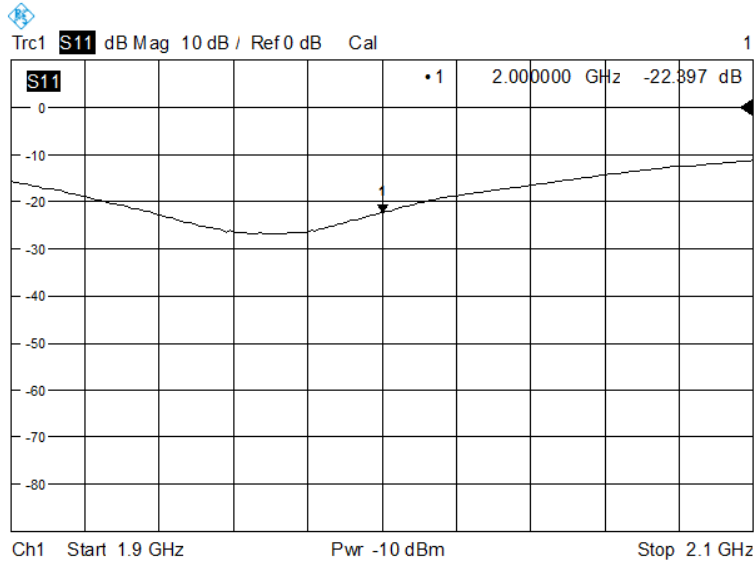

**Impedance**

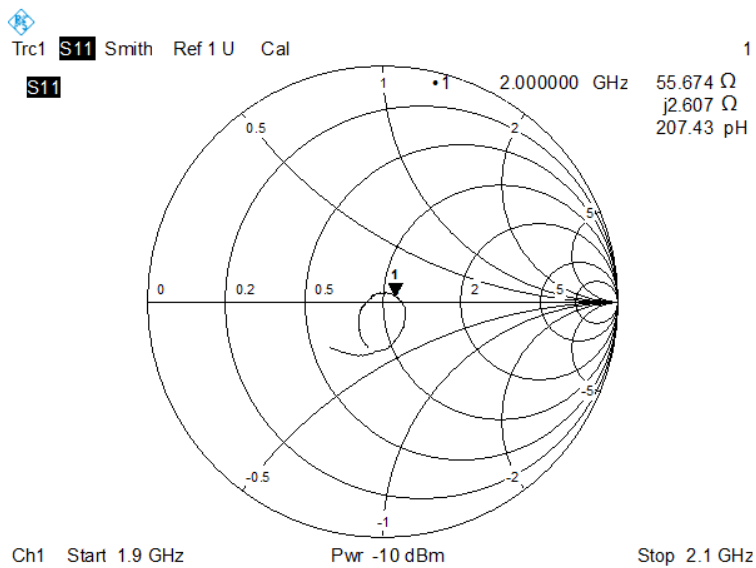



### 3.8 DIP 2G450

#### RETURN LOSS AND IMPEDANCE IN HEAD LIQUID

Meas. Results	Current Meas.	Previous Meas.	Max. Deviation
Return Loss (dB)	-23.68	-26.46	10.5 %
Impedance	47.0 $\Omega$ + 5.8 j $\Omega$	49.3 $\Omega$ - 4.7 j $\Omega$	2.3 $\Omega$ (Real part)

#### Return Loss

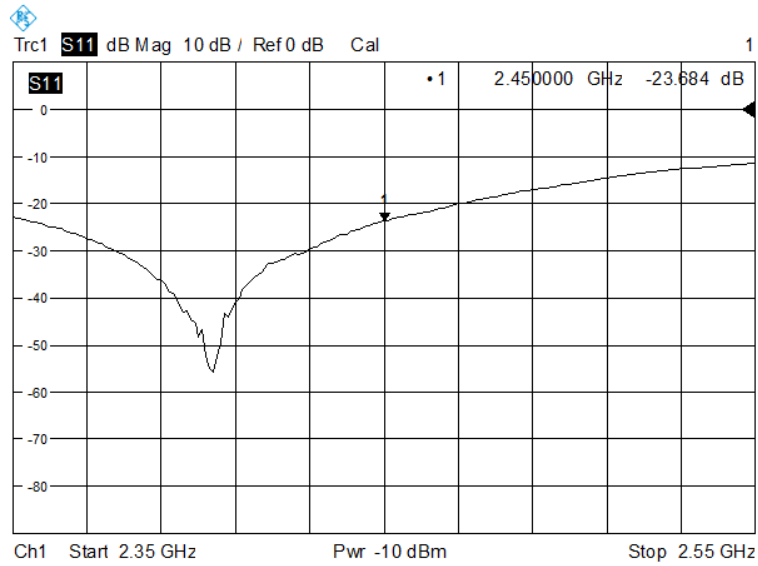

#### Impedance

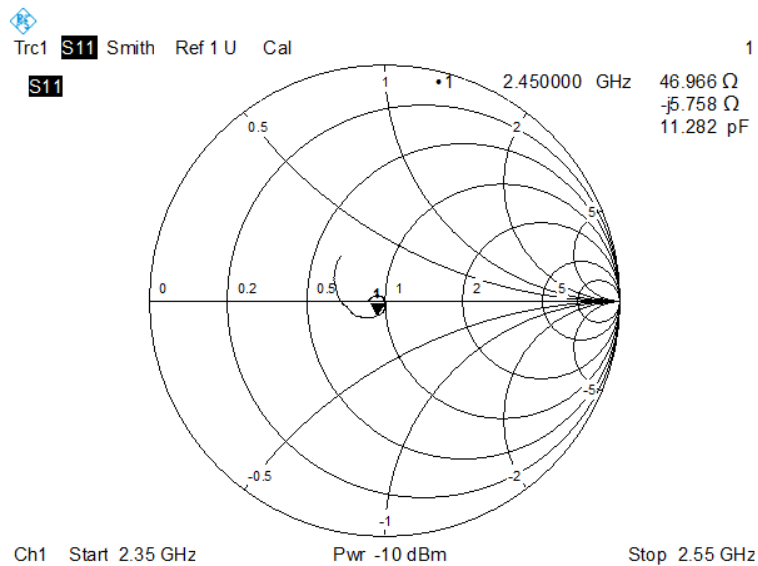



**RETURN LOSS AND IMPEDANCE IN BODY LIQUID**

Meas. Results	Current Meas.	Previous Meas.	Max. Deviation
Return Loss (dB)	-24.48	-23.34	3.5 %
Impedance	49.4 $\Omega$ – 5.9 j $\Omega$	53.4 $\Omega$ - 6.2 j $\Omega$	4.0 $\Omega$ (Real part)

**Return Loss**

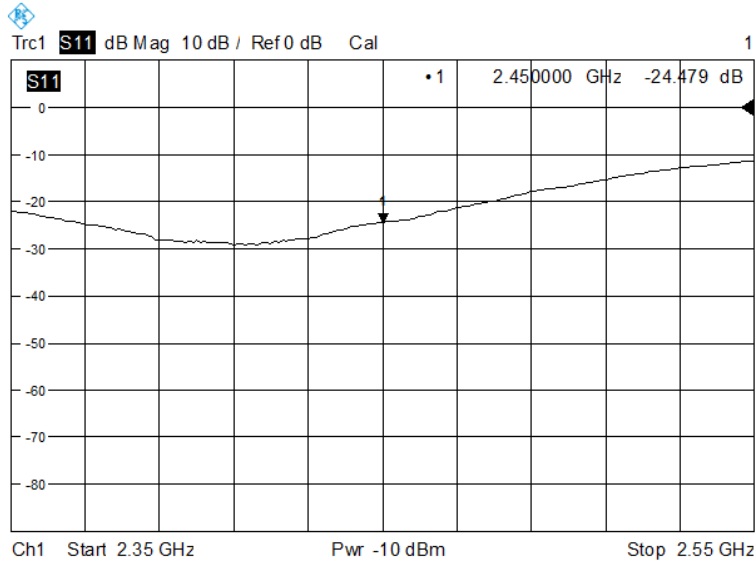

.0

**Impedance**

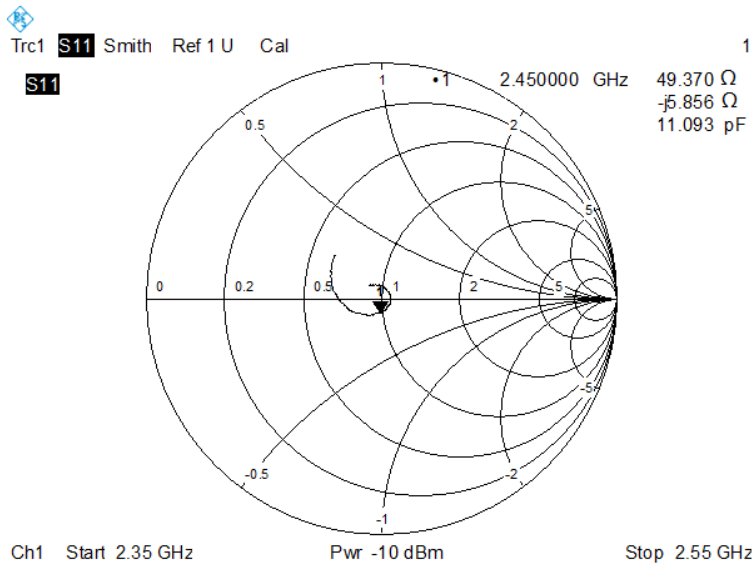

### 3.9 DIP 2G600

#### RETURN LOSS AND IMPEDANCE IN HEAD LIQUID

Meas. Results	Current Meas.	Previous Meas.	Max. Deviation
Return Loss (dB)	-20.83	-20.66	0.8 %
Impedance	51.0 $\Omega$ + 11.4 j $\Omega$	51.0 $\Omega$ + 9.4 j $\Omega$	2.0 $\Omega$ (Imaginary part)

#### Return Loss

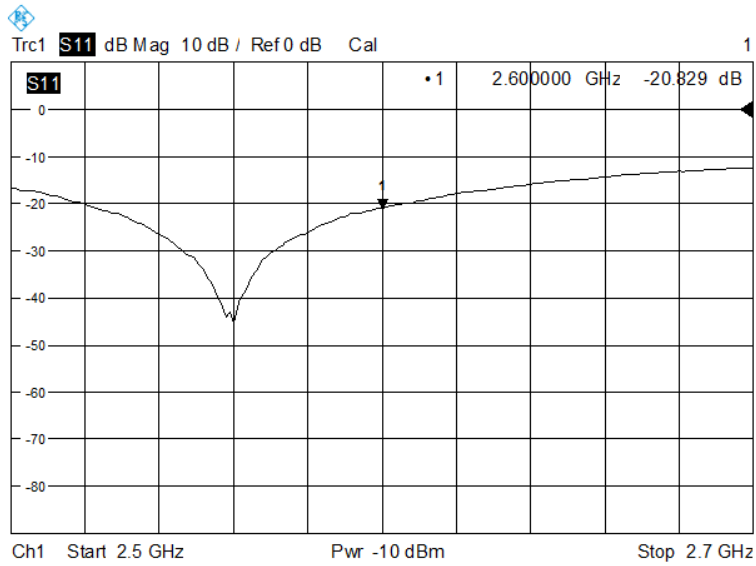

#### Impedance

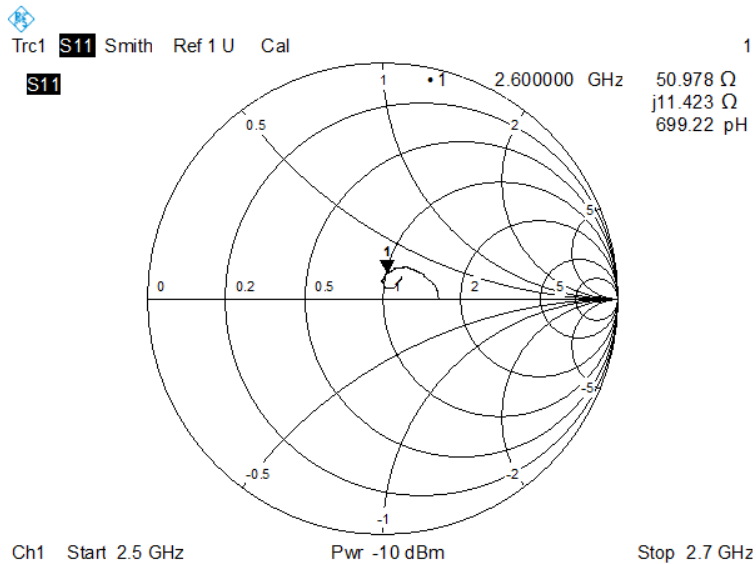



**RETURN LOSS AND IMPEDANCE IN BODY LIQUID**

Meas. Results	Current Meas.	Previous Meas.	Max. Deviation
Return Loss (dB)	-21.11	-22.17	4.8 %
Impedance	47.6 $\Omega$ + 11.1 j $\Omega$	47.9 $\Omega$ + 7.5 j $\Omega$	3.6 $\Omega$ (Imaginary part)

**Return Loss**

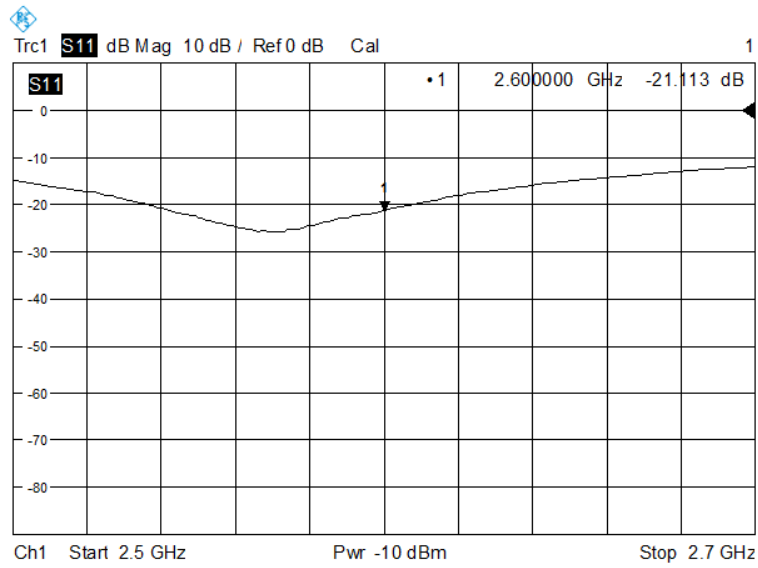

**Impedance**

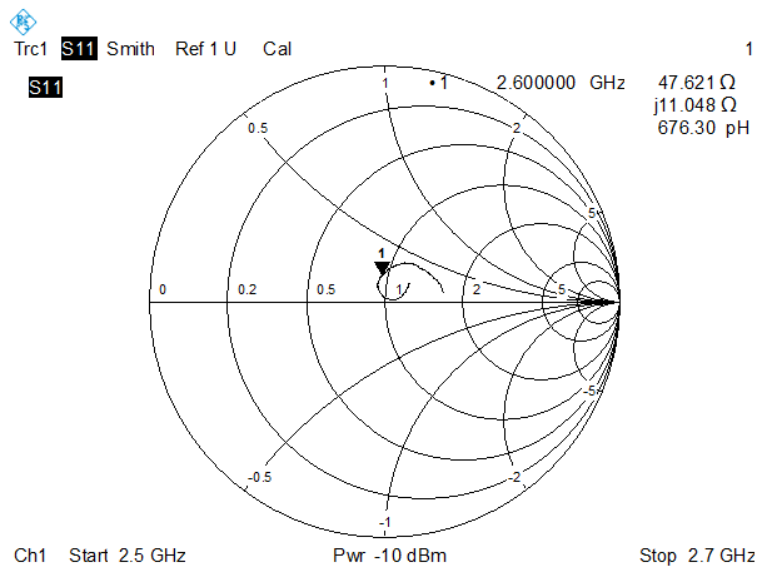

## 4 WAVEGUIDE IMPEDANCE AND RETURN LOSS

The waveguide are designed to have low return loss when presented against a flat phantom at the specified distance. A Vector Network Analyzer was used to perform a return loss measurement on the specific waveguide when in the measurement location against the phantom and the distance was specified by the manufacturer with a special, low loss and low relative permittivity spacer.

The impedance was measured at the SMA-connector with the network analyzer.

### 4.1 SWG5500

#### RETURN LOSS AND IMPEDANCE IN HEAD LIQUID

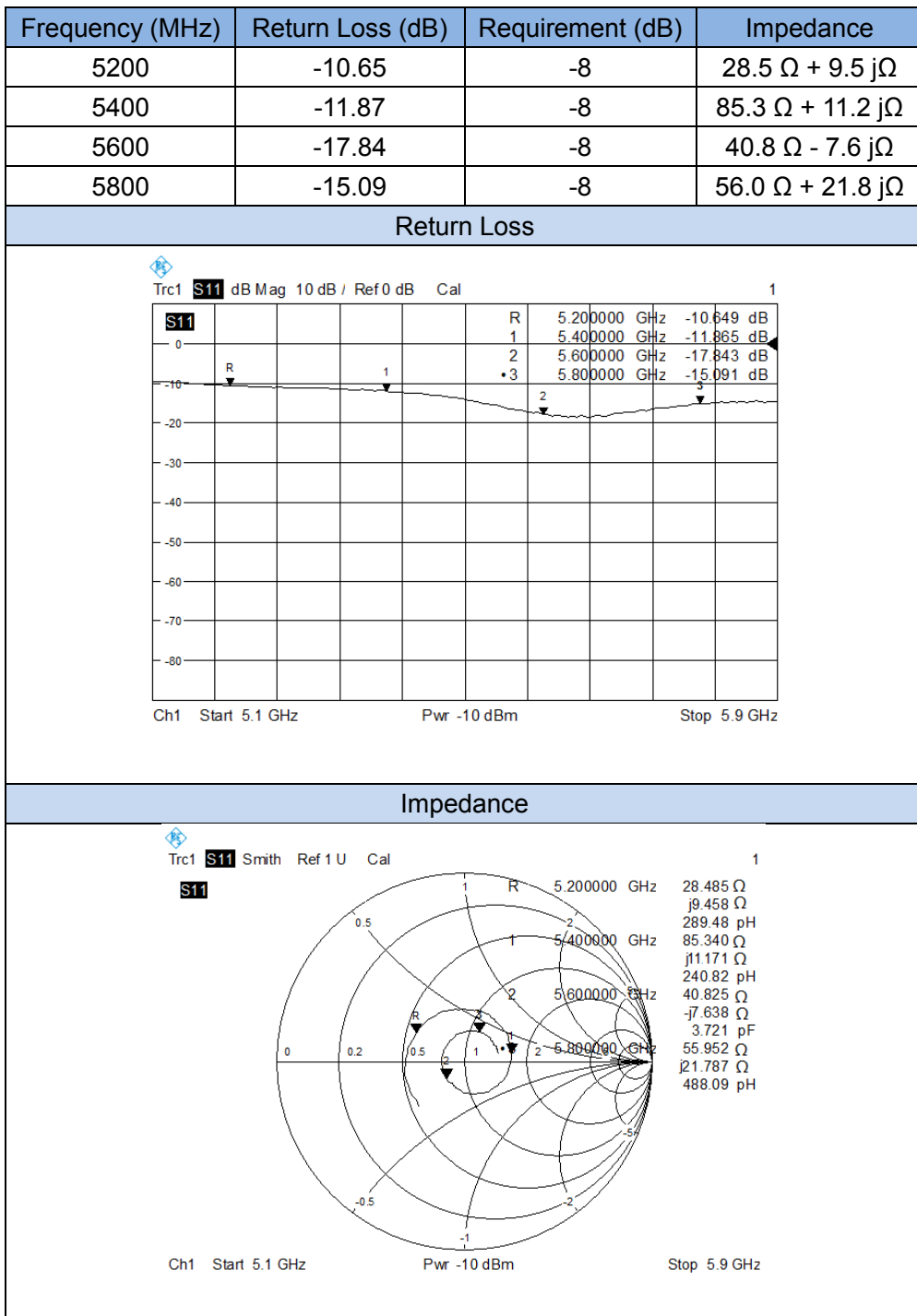



**RETURN LOSS AND IMPEDANCE IN BODY LIQUID**

Frequency (MHz)	Return Loss (dB)	Requirement (dB)	Impedance
5200	-9.50	-8	27.2 $\Omega$ + 9.2 j $\Omega$
5400	-10.10	-8	97.1 $\Omega$ + 8.3 j $\Omega$
5600	-16.60	-8	38.8 $\Omega$ - 7.6 j $\Omega$
5800	-14.14	-8	57.6 $\Omega$ + 26.4 j $\Omega$

**Return Loss**

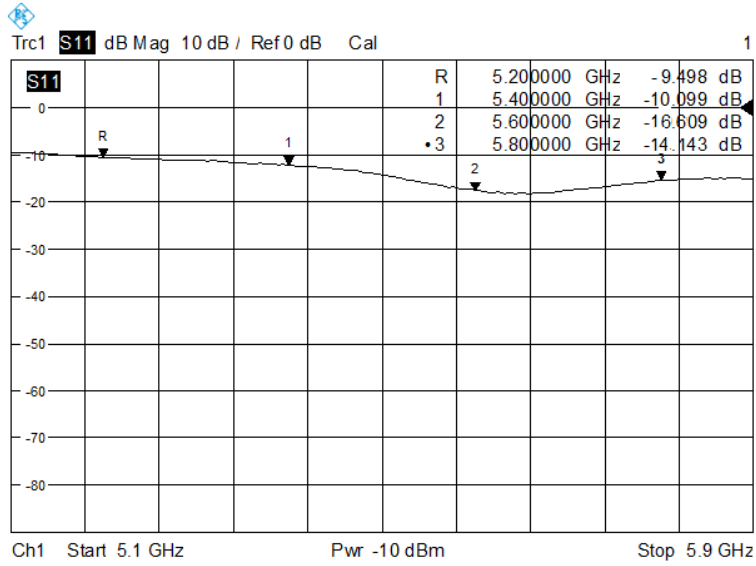

**Impedance**

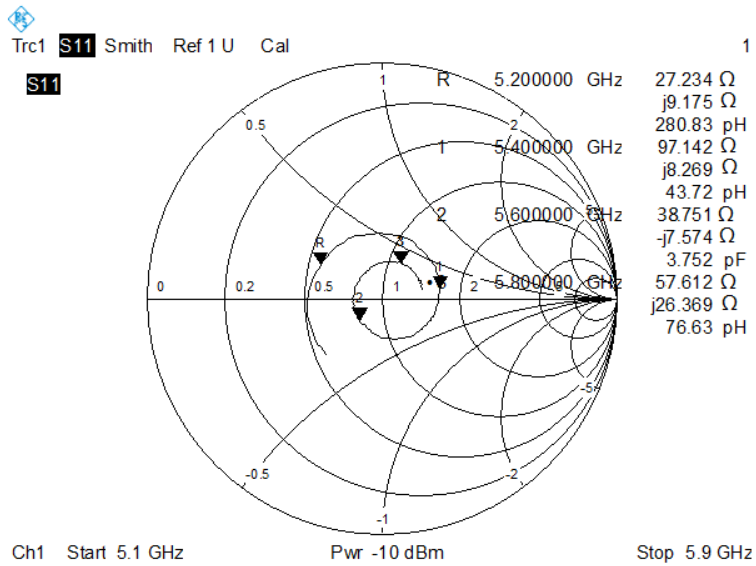

## 5 VALIDATION MEASUREMENT

The IEEE Std. 1528, FCC KDBs and CEI/IEC 62209 standards state that the system validation measurements must be performed using a reference dipole meeting the fore mentioned return loss and mechanical dimension requirements. The validation measurement must be performed against a liquid filled flat phantom, with the phantom constructed as outlined in the fore mentioned standards. Per the standards, the dipole shall be positioned below the bottom of the phantom, with the dipole length centered and parallel to the longest dimension of the flat phantom, with the top surface of the dipole at the described distance from the bottom surface of the phantom.

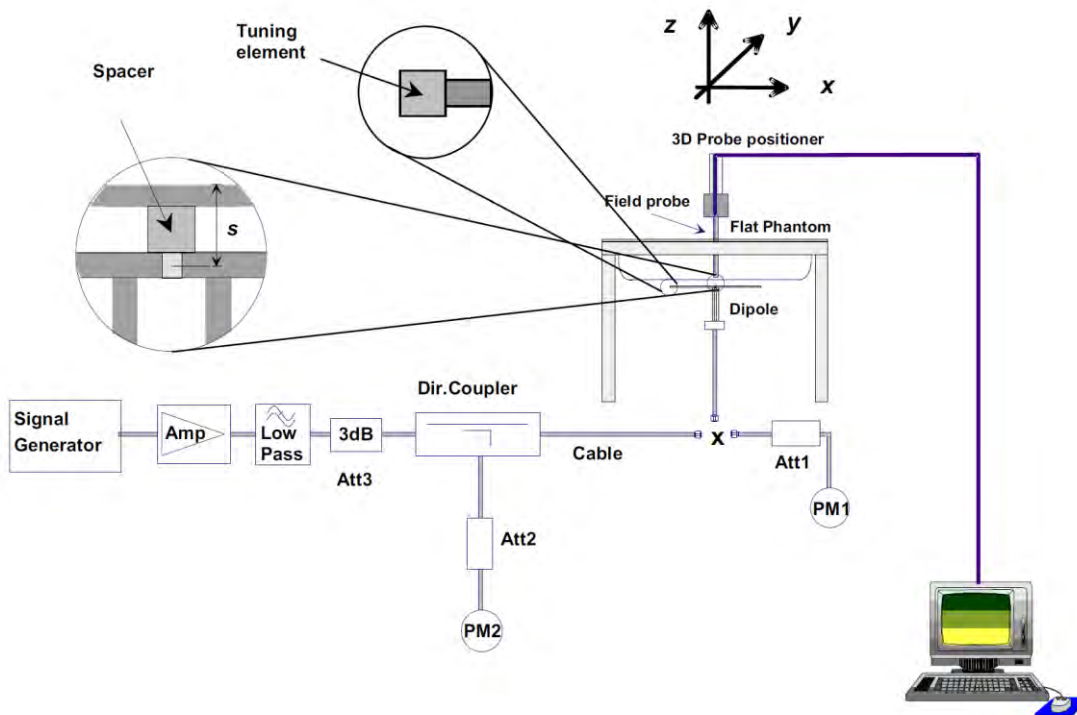



## 5.1 Dipole and Waveguide SAR Validation Measurement Result

Freq. (MHz)	Liquid Type	Power (mW)	1 g Measured SAR (W/kg)	Normalized SAR (W/kg)	10 g Measured SAR (W/kg)	Normalized SAR (W/kg)	1 g Targeted SAR (W/kg)	Tolerance (%)	10 g Targeted SAR (W/kg)	Tolerance (%)
450	Head	100	0.439	4.39	0.292	2.92	4.58	-4.15	3.06	-4.58
	Body	100	0.479	4.79	0.329	3.29	4.58	4.59	3.06	7.52
750	Head	100	0.861	8.61	0.576	5.76	8.49	1.41	5.55	3.78
	Body	100	0.879	8.79	0.592	5.92	8.49	3.53	5.55	6.67
835	Head	100	0.983	9.83	0.609	6.09	9.56	2.82	6.22	-2.09
	Body	100	1.013	10.13	0.659	6.59	9.56	5.96	6.22	5.95
900	Head	100	1.147	11.47	0.724	7.24	10.9	5.23	6.99	3.58
	Body	100	1.139	11.39	0.747	7.47	10.9	4.50	6.99	6.87
1800	Head	100	3.892	38.92	1.964	19.64	38.40	1.35	20.10	-2.29
	Body	100	3.911	39.11	1.989	19.89	38.40	1.85	20.10	-1.04
1900	Head	100	3.890	38.90	1.968	19.68	39.70	-2.02	20.50	-4.00
	Body	100	3.943	39.43	2.001	20.01	39.70	-0.68	20.50	-2.39
2000	Head	100	4.029	40.29	2.094	20.94	41.10	-1.97	21.10	-0.76
	Body	100	4.197	41.97	2.185	21.85	41.10	2.12	21.10	3.55
2450	Head	100	5.328	53.28	2.483	24.83	52.40	1.68	24.00	3.46
	Body	100	5.094	50.94	2.450	24.50	52.40	-2.79	24.00	2.08
2600	Head	100	5.323	53.23	2.515	25.15	55.30	-3.74	24.60	2.24
	Body	100	5.174	51.74	2.377	23.77	55.30	-6.44	24.60	-3.37
5200	Head	100	15.378	153.78	5.463	54.62	159.00	-3.28	56.90	-4.01
	Body	100	15.224	152.24	5.341	53.41	159.00	-4.25	56.90	-6.13
5400	Head	100	15.876	158.76	5.517	55.17	166.40	-4.59	58.43	-5.58
	Body	100	15.762	157.62	5.615	56.15	166.40	-5.28	58.43	-3.90
5600	Head	100	16.475	164.75	5.792	57.92	173.80	-5.21	59.97	-3.42
	Body	100	15.813	158.13	5.645	56.45	173.80	-9.02	59.97	-5.87
5800	Head	100	17.688	176.88	5.984	59.84	181.20	-2.38	61.50	-2.70
	Body	100	16.953	169.53	5.836	58.36	181.20	-6.44	61.50	-5.11

## 5.2 DIP 0G450

### 5.2.1 Dipole 450 MHz Validation Measurement for Head Tissue

## System Performance Check Data(450 MHz Head)

Type: Phone measurement (Complete)

E-Field Probe: SN 34/15 EPGO265

Area scan resolution: dx=8mm, dy=8mm

Zoom scan resolution: dx=8mm, dy=8mm, dz=5mm

Date of measurement: 2016.03.01

Measurement duration: 14 minutes 46 seconds

### Experimental conditions.

<b>Phantom File</b>	surf_sam_plan.txt
<b>Phantom</b>	Validation plane
<b>Band</b>	450MHz
<b>Signal</b>	CW
<b>Frequency (MHz)</b>	450.000000
<b>Relative permittivity (real part)</b>	42.872365
<b>Conductivity (S/m)</b>	0.890236
<b>Power drift (%)</b>	1.350000
<b>Ambient Temperature:</b>	21.6°C
<b>Liquid Temperature:</b>	21.1°C
<b>ConvF:</b>	1.85
<b>Crest factor:</b>	1:1

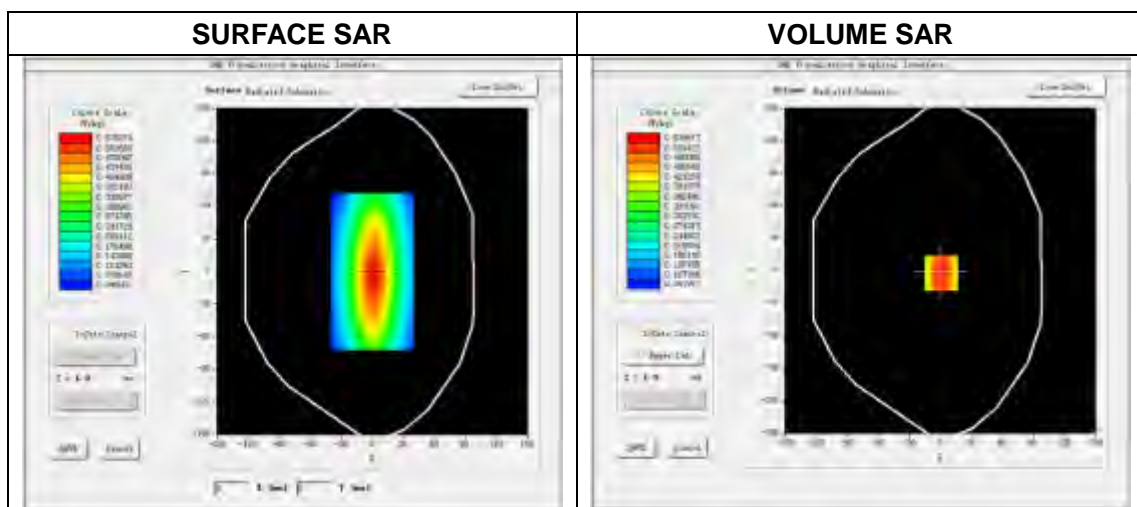

Maximum location: X=0.00, Y=0.00

SAR Peak: 0.69 W/kg

SAR 10g (W/Kg)	0.291862
SAR 1g (W/Kg)	0.439023

### Z Axis Scan

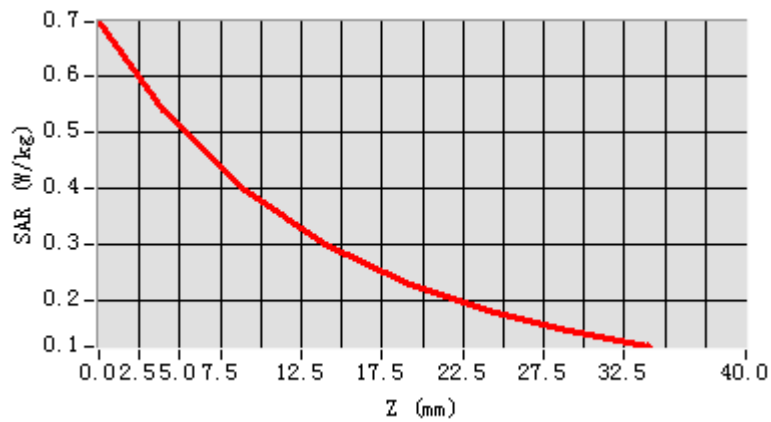

### 3D screen shot

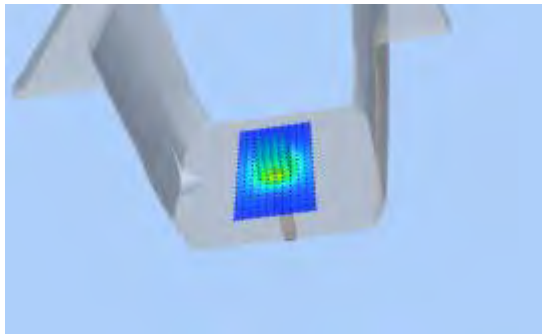

### Hot spot position

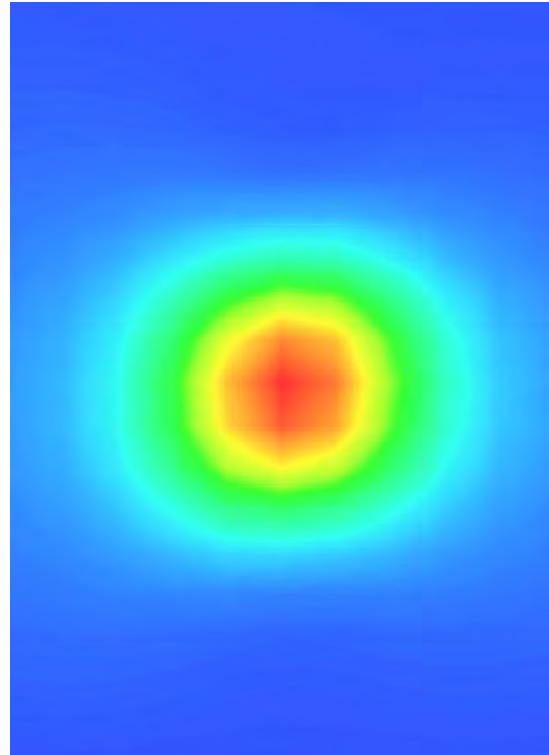

## 5.2.2 Dipole 450 MHz Validation Measurement for Body Tissue

# System Performance Check Data(450 MHz Body)

Type: Phone measurement (Complete)  
 E-Field Probe: SN 34/15 SSE2 EPGO265  
 Area scan resolution: dx=8mm,dy=8mm  
 Zoom scan resolution: dx=8mm, dy=8mm, dz=5mm  
 Date of measurement: 2016.03.01  
 Measurement duration: 13 minutes 52 seconds

### Experimental conditions.

1

<b>Phantom File</b>	surf_sam_plan.txt
<b>Phantom</b>	Validation plane
<b>Band</b>	450MHz
<b>Signal</b>	CW
<b>Frequency (MHz)</b>	450.000000
<b>Relative permittivity (real part)</b>	55.695599
<b>Conductivity (S/m)</b>	0.955490
<b>Power drift (%)</b>	-1.370000
<b>Ambient Temperature:</b>	21.6°C
<b>Liquid Temperature:</b>	21.1°C
<b>ConvF:</b>	1.90
<b>Crest factor:</b>	1:1

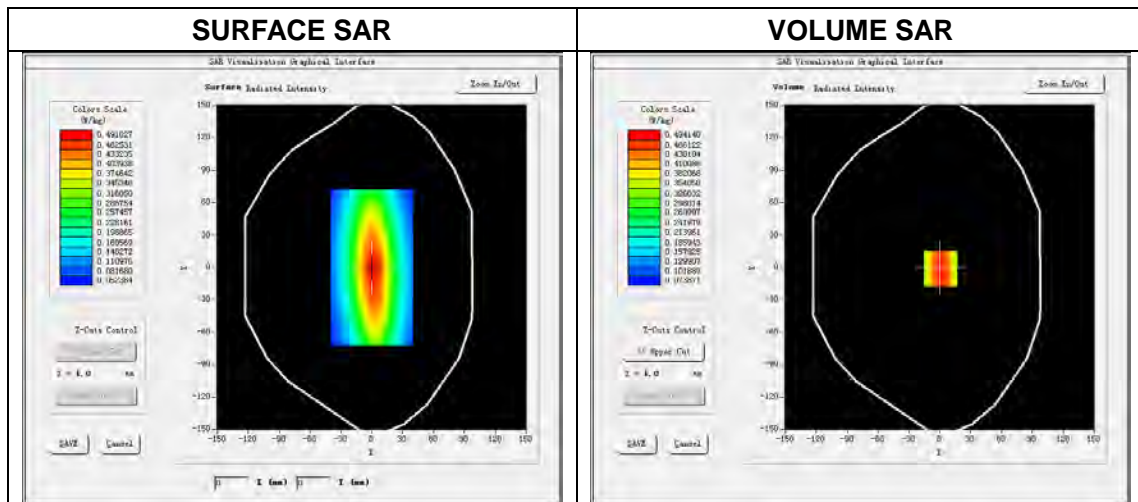



Maximum location: X=1.00, Y=-1.00

SAR Peak: 0.66 W/kg

SAR 10g (W/Kg)	0.328543
SAR 1g (W/Kg)	0.478689

### Z Axis Scan

3D scene shot

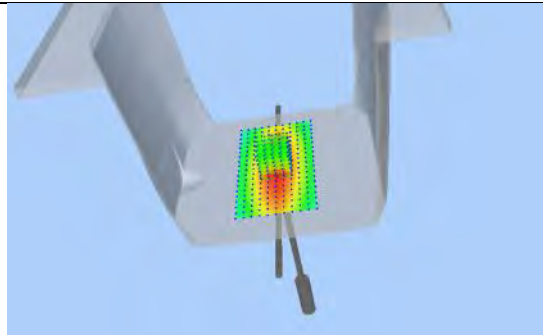

Hot spot position

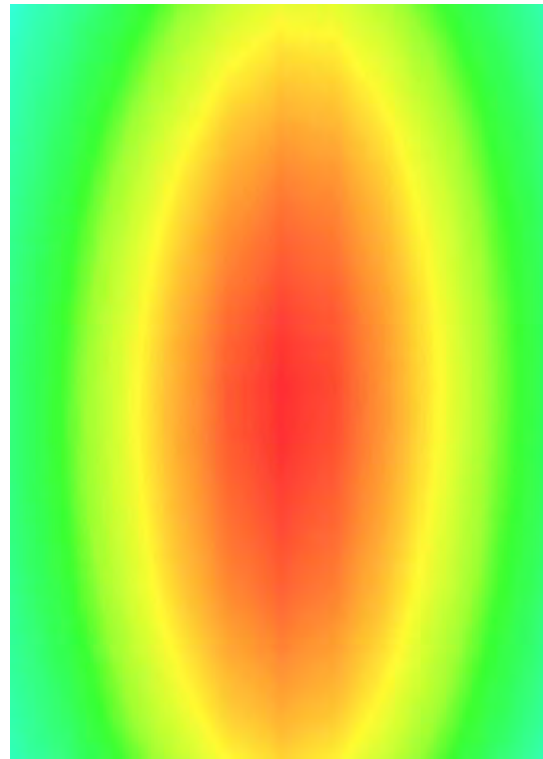

### 5.3 DIP 0G750

#### 5.3.1 Dipole 750 MHz Validation Measurement for Head Tissue

## System Performance Check Data(750 MHz Head)

Type: Phone measurement (Complete)  
 E-Field Probe: SN 34/15 SSE2 EPGO265  
 Area scan resolution: dx=8mm,dy=8mm  
 Zoom scan resolution: dx=8mm, dy=8mm, dz=5mm  
 Date of measurement: 2016.03.01  
 Measurement duration: 13 minutes 27 seconds

### Experimental conditions.

<b>Phantom File</b>	surf_sam_plan.txt
<b>Phantom</b>	Validation plane
<b>Band</b>	750MHz
<b>Signal</b>	CW
<b>Frequency (MHz)</b>	750MHz
<b>Relative permittivity (real part)</b>	41.923526
<b>Conductivity (S/m)</b>	0.883686
<b>Power drift (%)</b>	-3.100000
<b>Ambient Temperature:</b>	21.6°C
<b>Liquid Temperature:</b>	21.1°C
<b>ConvF:</b>	1.81
<b>Crest factor:</b>	1:1

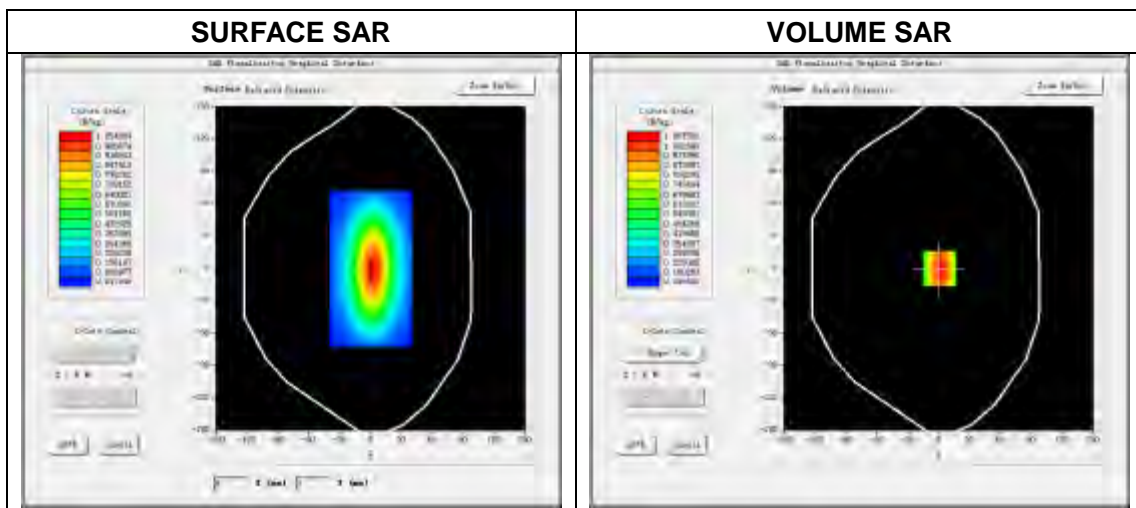

Maximum location: X=1.00, Y=0.00

SAR Peak: 1.28 W/kg

SAR 10g (W/Kg)	0.576457
SAR 1g (W/Kg)	0.861462

### Z Axis Scan

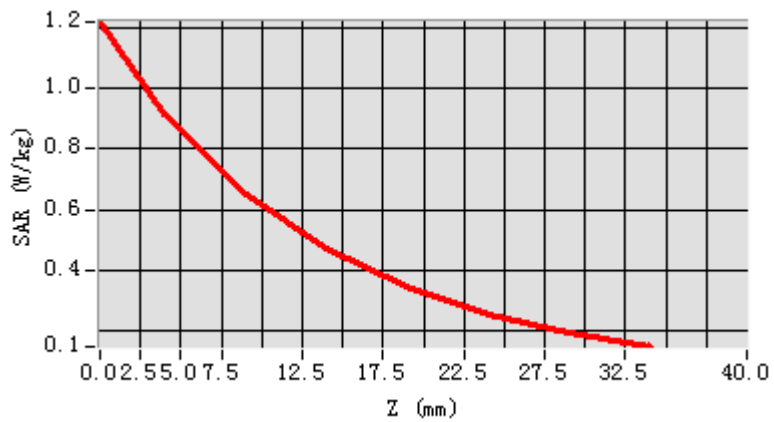

### 3D screen shot

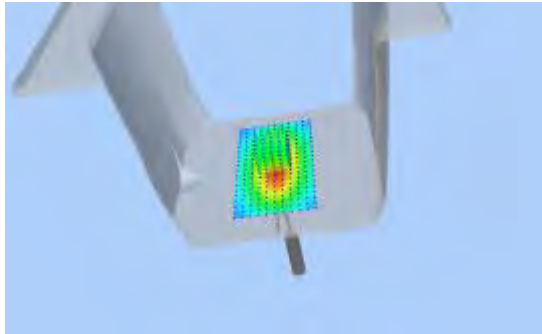

### Hot spot position

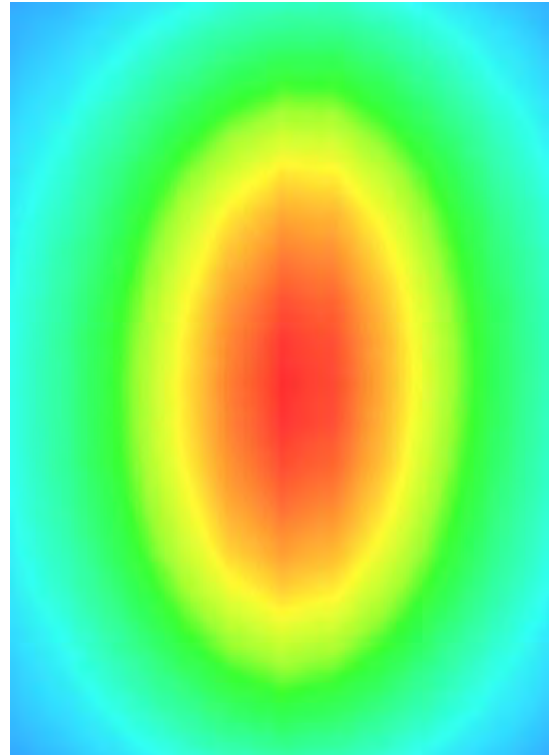

### 5.3.2 Dipole 750 MHz Validation Measurement for Body Tissue

## System Performance Check Data(750 MHz Body)

Type: Phone measurement (Complete)  
 E-Field Probe: SN 34/15 SSE2 EPGO265  
 Area scan resolution: dx=8mm,dy=8mm  
 Zoom scan resolution: dx=8mm, dy=8mm, dz=5mm  
 Date of measurement: 2016.03.01  
 Measurement duration: 13 minutes 27 seconds

### Experimental conditions.

Phantom File	surf_sam_plan.txt
Phantom	Validation plane
Band	750MHz
Signal	CW
Frequency (MHz)	750MHz
Relative permittivity (real part)	57.188739
Conductivity (S/m)	0.946268
Power drift (%)	-0.600000
Ambient Temperature:	21.6°C
Liquid Temperature:	21.1°C
ConvF:	1.88
Crest factor:	1:1

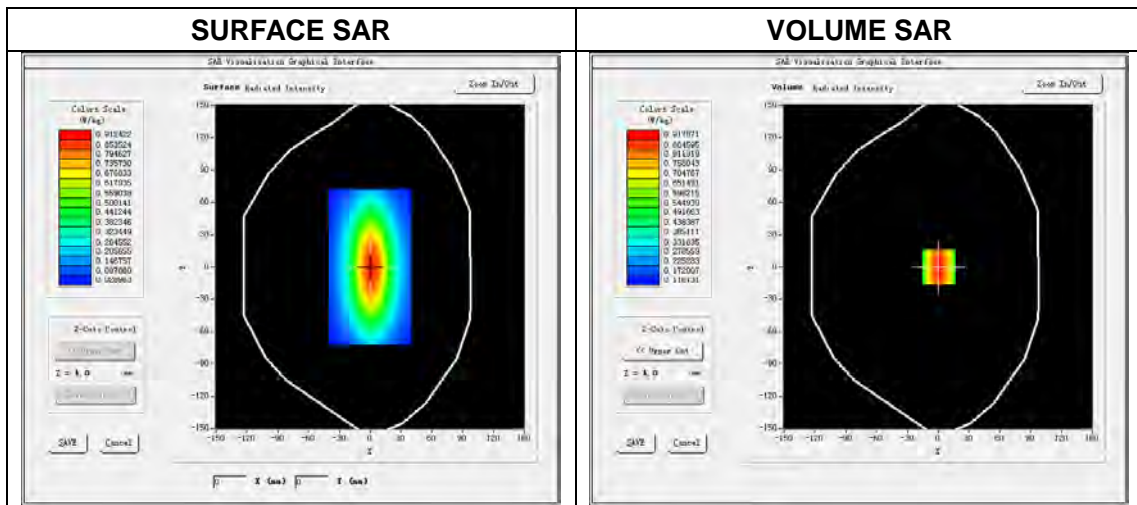

Maximum location: X=1.00, Y=0.00

SAR Peak: 1.28 W/kg

SAR 10g (W/Kg)	0.592395
SAR 1g (W/Kg)	0.878736

### Z Axis Scan

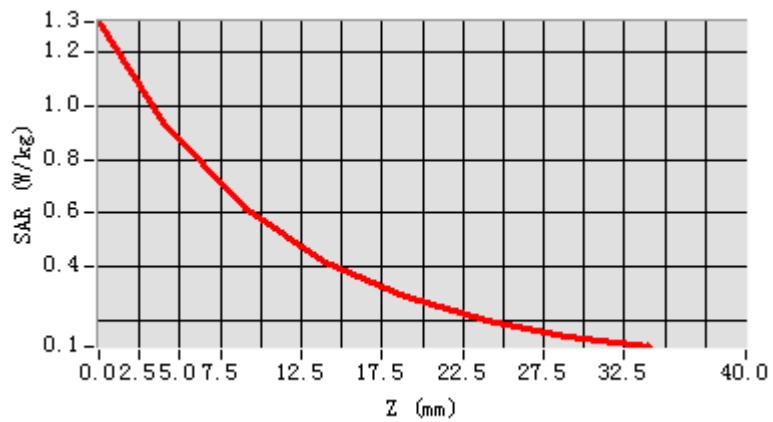

3D screen shot

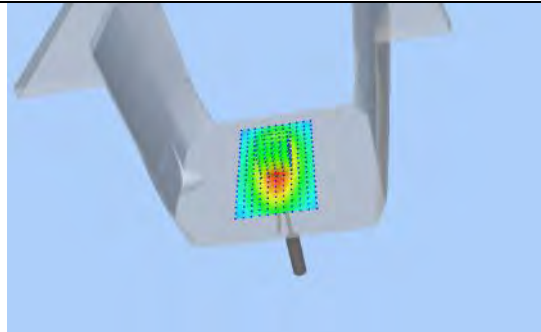

Hot spot position

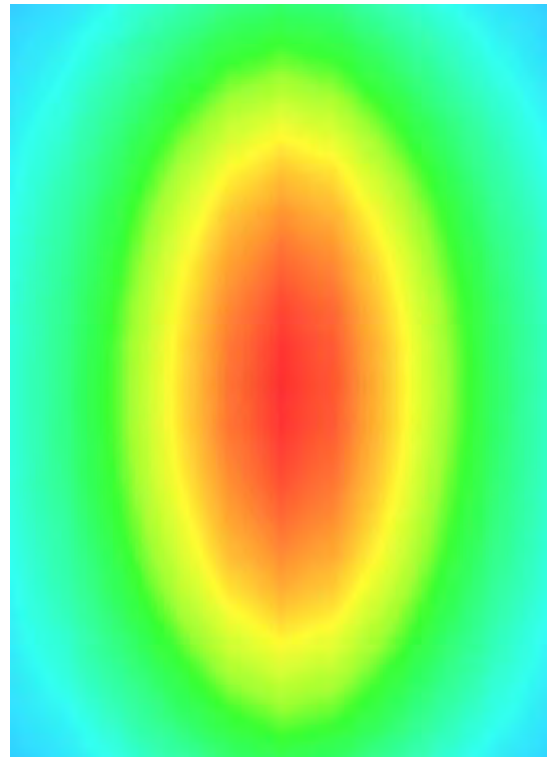

## 5.4 DIP 0G835

### 5.4.1 Dipole 835 MHz Validation Measurement for Head Tissue

# System Performance Check Data(835 MHz Head)

Type: Phone measurement (Complete)

E-Field Probe: SN 34/15 SSE2 EPGO265

Area scan resolution: dx=8 mm,dy=8 mm

Zoom scan resolution: dx=8 mm, dy=8 mm, dz=5 mm

Date of measurement: 2016.03.01

Measurement duration: 14 minutes 2 seconds

### Experimental conditions.

<b>Phantom File</b>	surf_sam_plan.txt
<b>Phantom</b>	Validation plane
<b>Band</b>	835 MHz
<b>Signal</b>	CW
<b>Frequency (MHz)</b>	835.000000
<b>Relative permittivity (real part)</b>	43.331142
<b>Conductivity (S/m)</b>	0.897827
<b>Power drift (%)</b>	-0.050000
<b>Ambient Temperature:</b>	21.6°C
<b>Liquid Temperature:</b>	21.1°C
<b>ConvF:</b>	2.04
<b>Crest factor:</b>	1:1

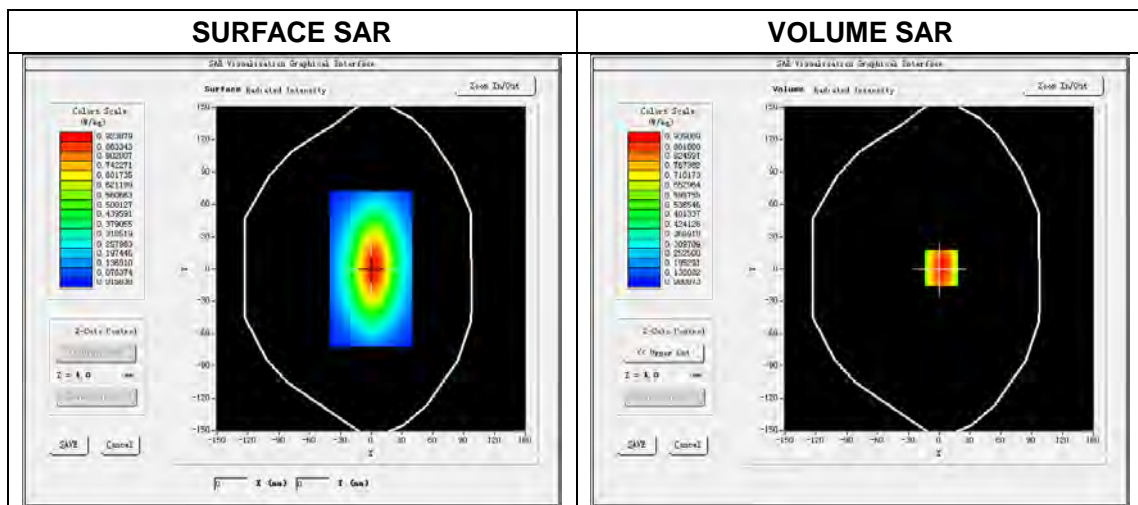

Maximum location: X=0.00, Y=0.00

SAR Peak: 1.40 W/kg

SAR 10 g (W/Kg)	0.609437
SAR 1 g (W/Kg)	0.983275

### Z Axis Scan

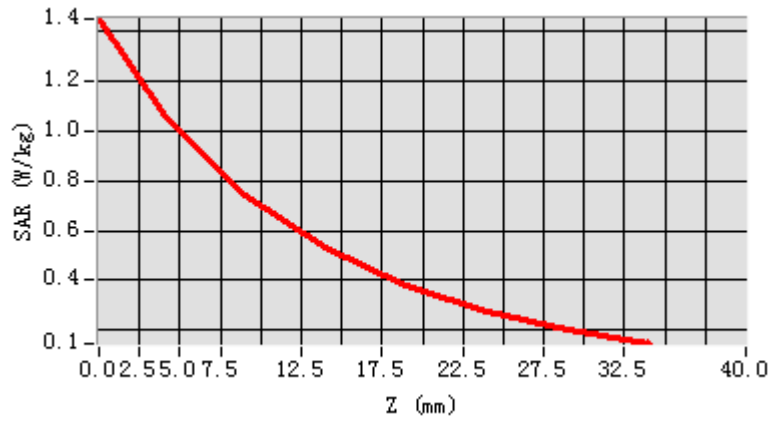

3D screen shot

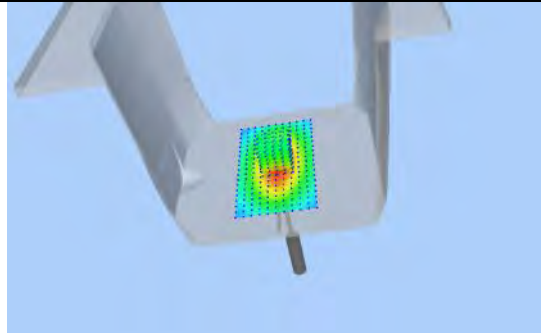

Hot spot position

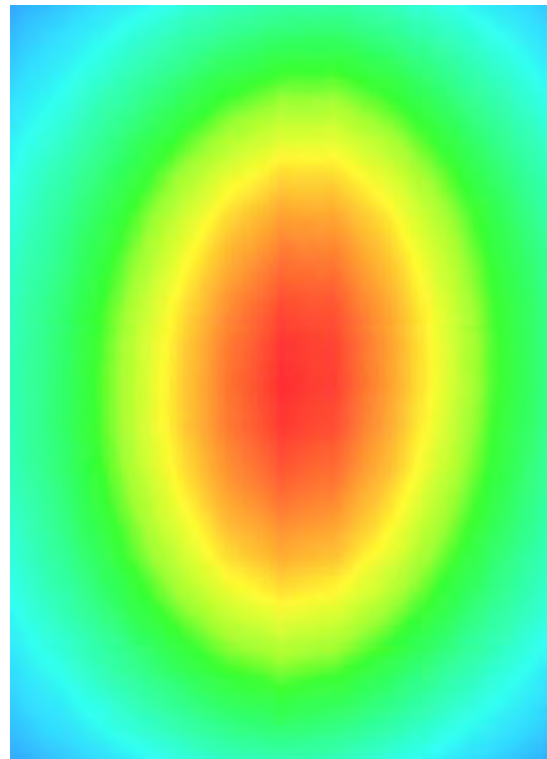

## 5.4.2 Dipole 835 MHz Validation Measurement for Body Tissue

# System Performance Check Data(835 MHz Body)

Type: Phone measurement (Complete)

E-Field Probe: SN 34/15 SSE2 EPGO265

Area scan resolution: dx=8 mm,dy=8 mm

Zoom scan resolution: dx=8 mm, dy=8 mm, dz=5 mm

Date of measurement: 2016.03.01

Measurement duration: 14 minutes 2 seconds

### Experimental conditions.

Phantom File	surf_sam_plan.txt
Phantom	Validation plane
Band	835 MHz
Signal	CW
Frequency (MHz)	835.000000
Relative permittivity (real part)	54.652059
Conductivity (S/m)	0.991147
Power drift (%)	0.390000
Ambient Temperature:	21.6°C
Liquid Temperature:	21.1°C
ConvF:	2.12
Crest factor:	1:1

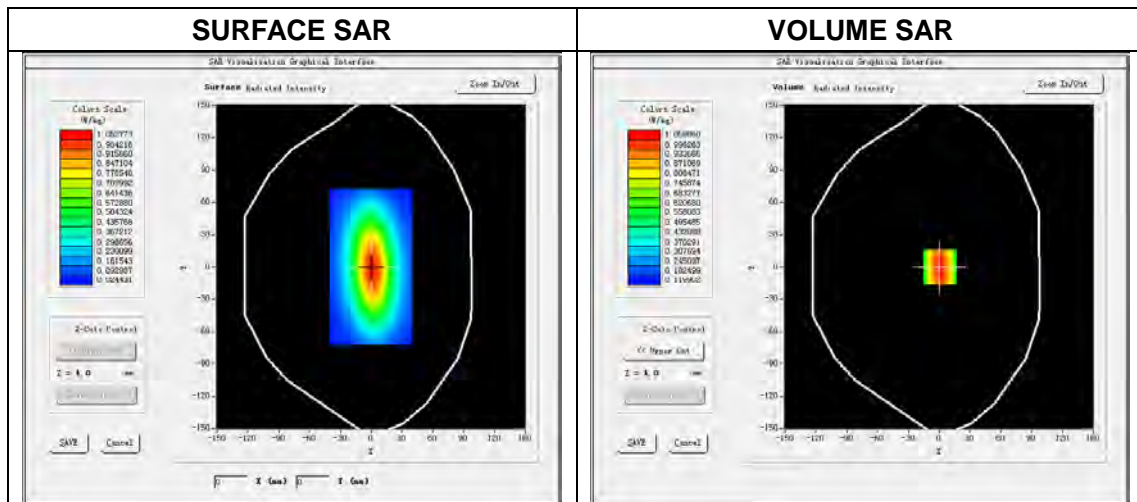



Maximum location: X=0.00, Y=0.00

SAR Peak: 1.41 W/kg

SAR 10 g (W/Kg)	0.659168
SAR 1 g (W/Kg)	1.013364

### Z Axis Scan

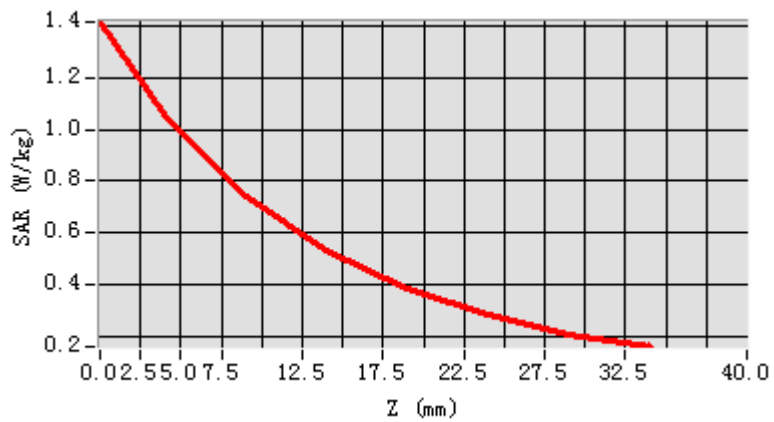

3D screen shot

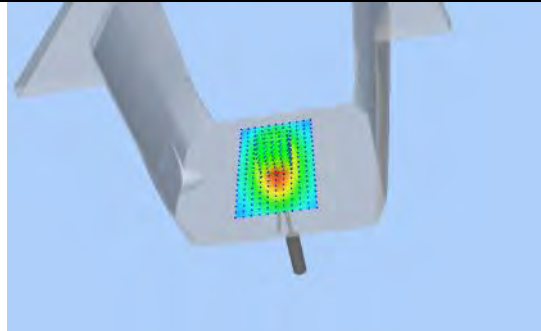

Hot spot position

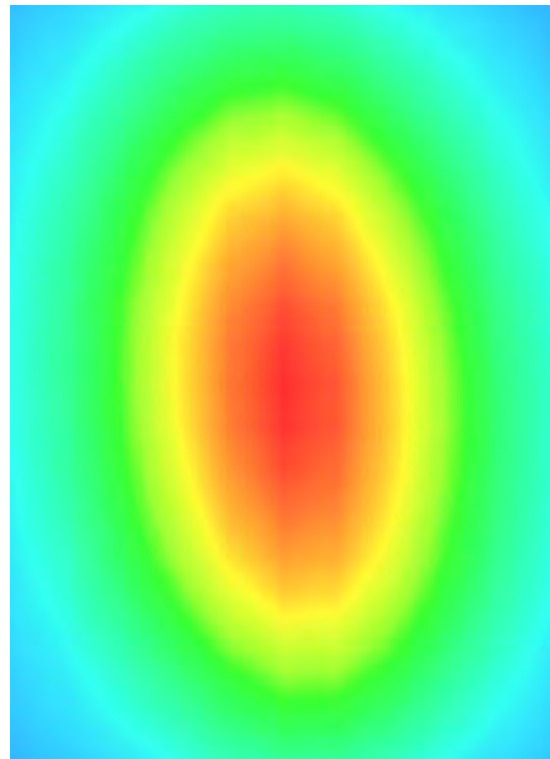

## 5.5 DIP 0G900

### 5.5.1 Dipole 900 MHz Validation Measurement for Head Tissue

# System Performance Check Data(900 MHz Head)

Type: Phone measurement (Complete)  
 E-Field Probe: SN 34/15 SSE2 EPGO265  
 Area scan resolution: dx=8 mm,dy=8 mm  
 Zoom scan resolution: dx=8 mm, dy=8 mm, dz=5 mm  
 Date of measurement: 2016.03.01  
 Measurement duration: 13 minutes 55 seconds

### Experimental conditions.

<b>Phantom File</b>	surf_sam_plan.txt
<b>Phantom</b>	Validation plane
<b>Band</b>	900 MHz
<b>Signal</b>	CW
<b>Frequency (MHz)</b>	900.000000
<b>Relative permittivity (real part)</b>	41.140601
<b>Conductivity (S/m)</b>	0.994278
<b>Power drift (%)</b>	0.420000
<b>Ambient Temperature:</b>	21.6°C
<b>Liquid Temperature:</b>	21.1°C
<b>ConvF:</b>	1.86
<b>Crest factor:</b>	1:1

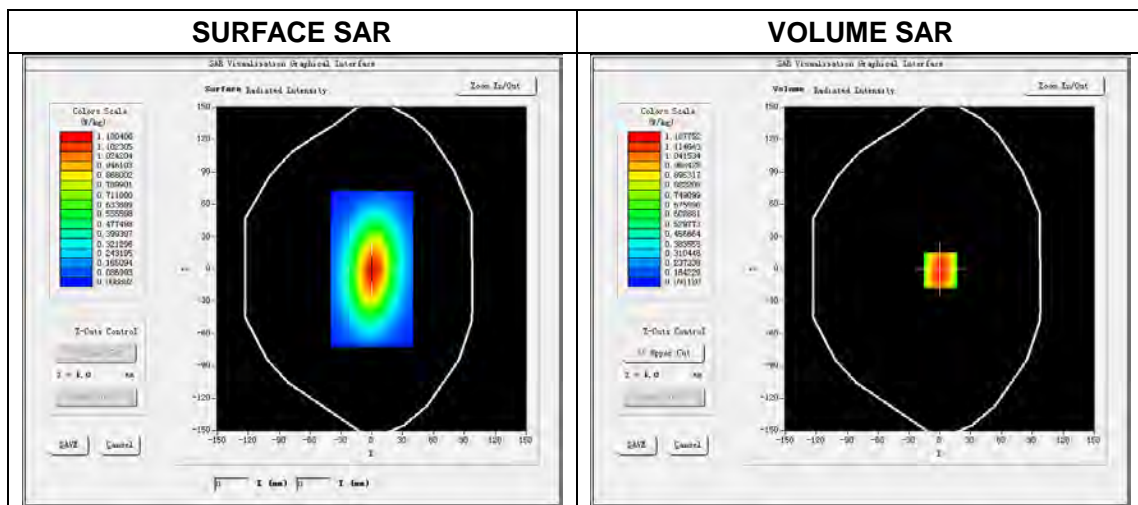

Maximum location: X=0.00, Y=0.00

SAR Peak: 1.66 W/kg

SAR 10 g (W/Kg)	0.723554
SAR 1 g (W/Kg)	1.147184

### Z Axis Scan

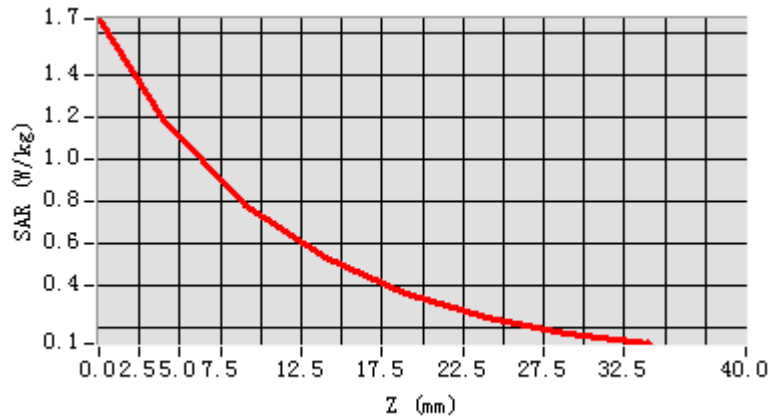

### 3D screen shot

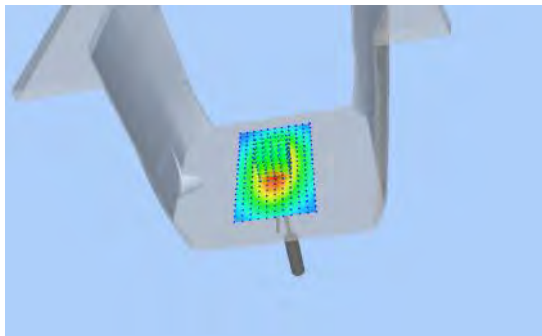

### Hot spot position

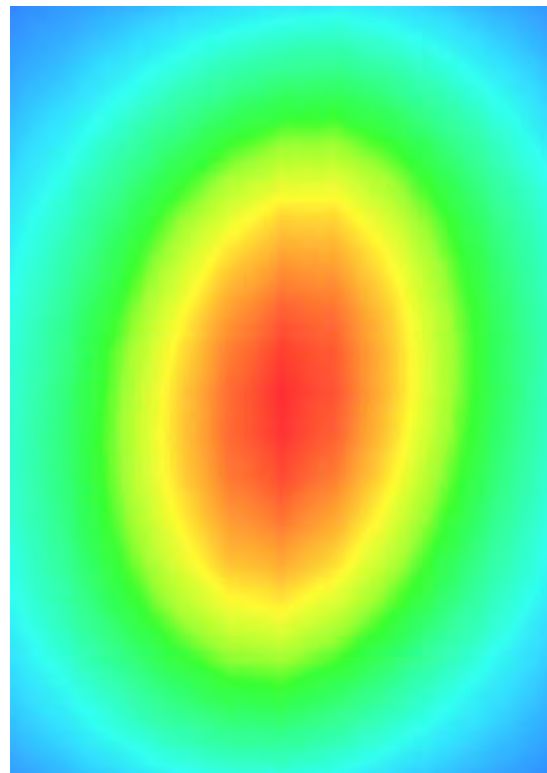

## 5.5.2 Dipole 900 MHz Validation Measurement for Body Tissue

# System Performance Check Data(900 MHz Body)

Type: Phone measurement (Complete)

E-Field Probe: SN 34/15 SSE2 EPGO265

Area scan resolution: dx=8 mm,dy=8 mm

Zoom scan resolution: dx=8 mm, dy=8 mm, dz=5 mm

Date of measurement: 2016.03.01

Measurement duration: 13 minutes 55 seconds

### Experimental conditions.

<b>Phantom File</b>	surf_sam_plan.txt
<b>Phantom</b>	Validation plane
<b>Band</b>	900 MHz
<b>Signal</b>	CW
<b>Frequency (MHz)</b>	900.000000
<b>Relative permittivity (real part)</b>	54.932917
<b>Conductivity (S/m)</b>	1.062623
<b>Power drift (%)</b>	-0.290000
<b>Ambient Temperature:</b>	21.6°C
<b>Liquid Temperature:</b>	21.1°C
<b>ConvF:</b>	1.92
<b>Crest factor:</b>	1:1

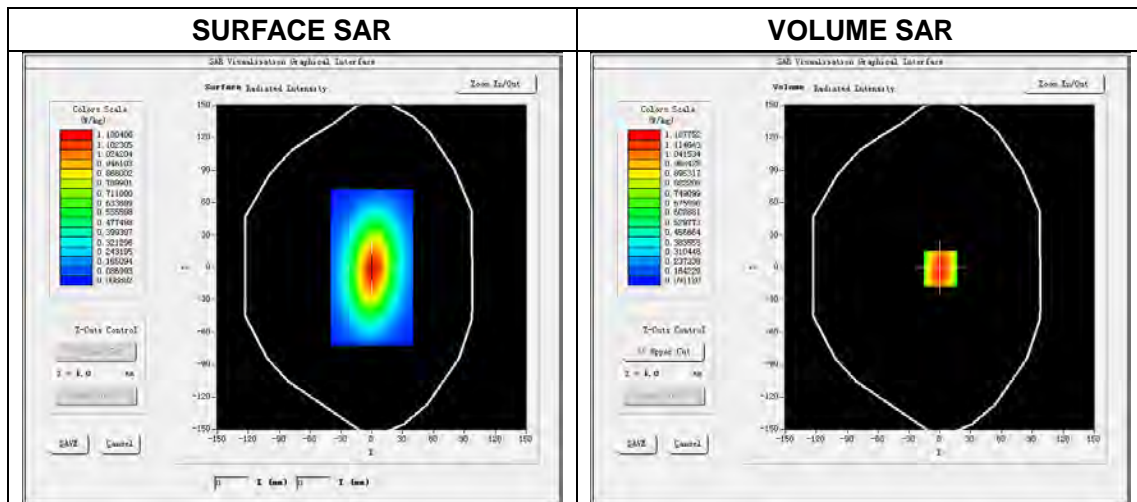

Maximum location: X=0.00, Y=0.00

SAR Peak: 1.67 W/kg

SAR 10 g (W/Kg)	0.746807
SAR 1 g (W/Kg)	1.139340

### Z Axis Scan

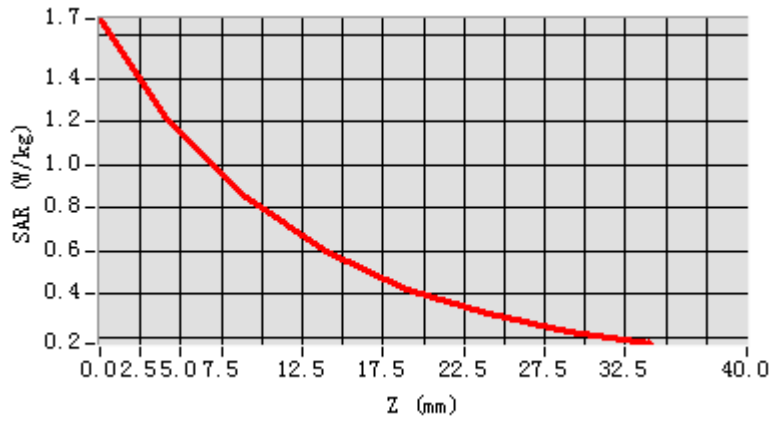

3D screen shot

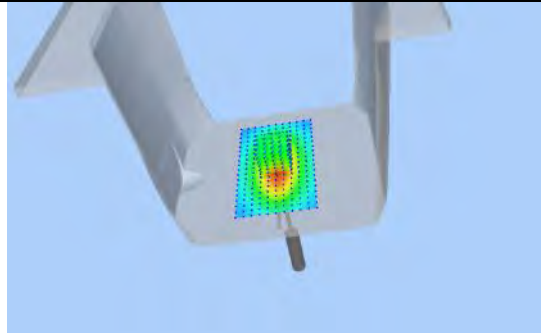

Hot spot position

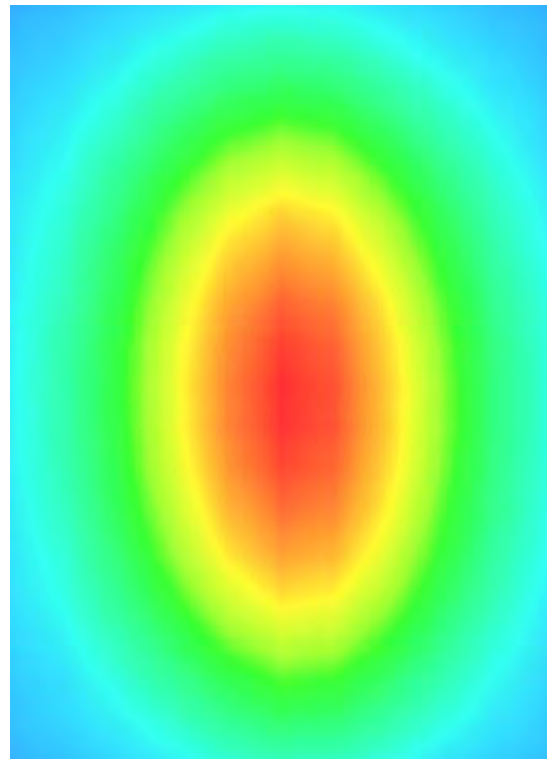

## 5.6 DIP 1G800

### 5.6.1 Dipole 1800 MHz Validation Measurement for Head Tissue

## System Performance Check Data(1800 MHz Head)

Type: Phone measurement (Complete)  
 E-Field Probe: SN 34/15 SSE2 EPGO265  
 Area scan resolution: dx=8mm,dy=8mm  
 Zoom scan resolution: dx=8mm, dy=8mm, dz=5mm  
 Date of measurement: 2016.03.02  
 Measurement duration: 13 minutes 27 seconds

### Experimental conditions.

<b>Phantom File</b>	surf_sam_plan.txt
<b>Phantom</b>	Validation plane
<b>Band</b>	1800MHz
<b>Signal</b>	CW
<b>Frequency (MHz)</b>	1800.000000
<b>Relative permittivity (real part)</b>	39.562781
<b>Conductivity (S/m)</b>	1.413274
<b>Power drift (%)</b>	1.160000
<b>Ambient Temperature:</b>	21.6°C
<b>Liquid Temperature:</b>	21.1°C
<b>ConvF:</b>	2.04
<b>Crest factor:</b>	1:1

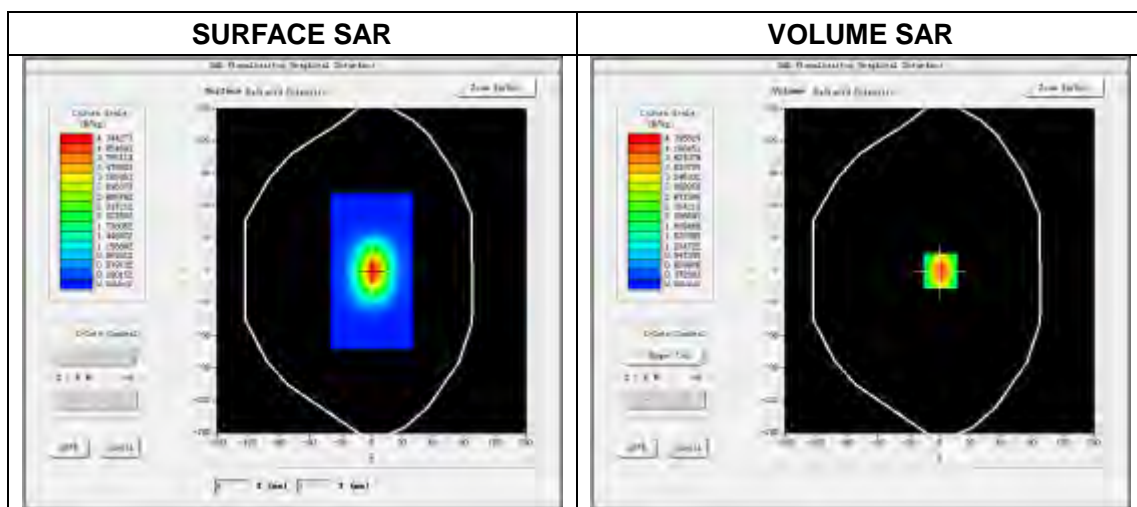

Maximum location: X=0.00, Y=0.00

SAR Peak: 6.47 W/kg

SAR 10 g (W/Kg)	1.964125
SAR 1g (W/Kg)	3.892053

### Z Axis Scan

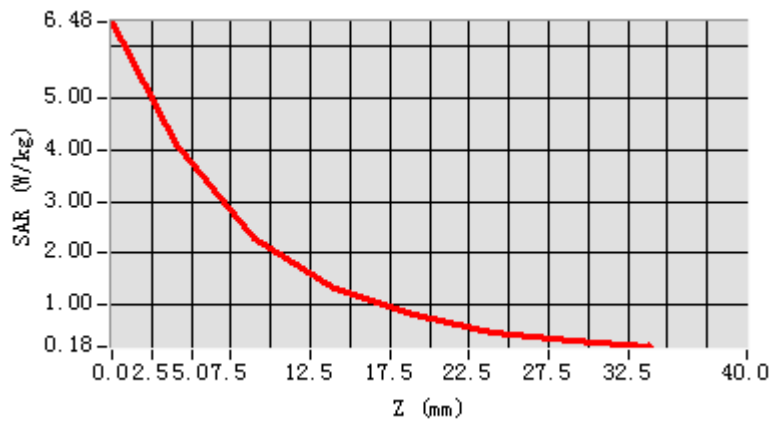

3D screen shot

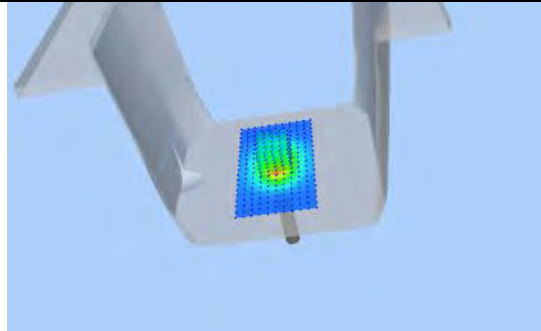

Hot spot position

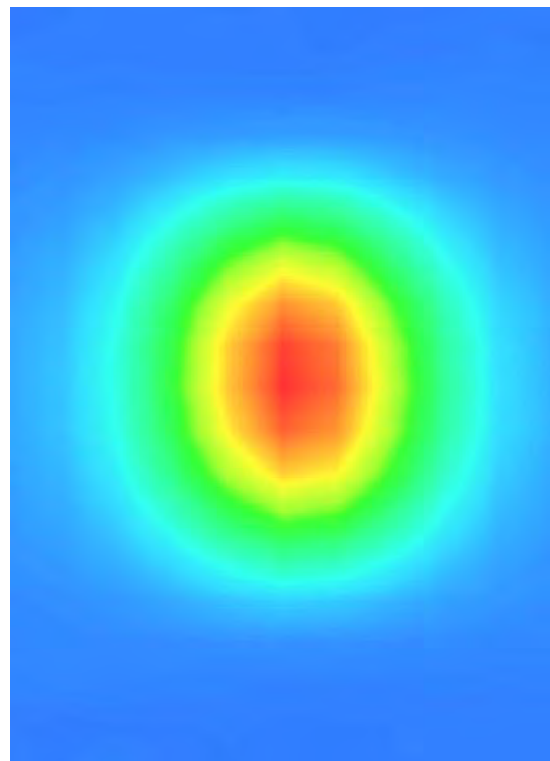

## 5.6.2 Dipole 1800 MHz Validation Measurement for Body Tissue

### System Performance Check Data(1800 MHz Body)

Type: Phone measurement (Complete)  
 E-Field Probe: SN 34/15 SSE2 EPGO265  
 Area scan resolution: dx=8mm,dy=8mm  
 Zoom scan resolution: dx=8mm, dy=8mm, dz=5mm  
 Date of measurement: 2016.03.02  
 Measurement duration: 13 minutes 27 seconds

#### Experimental conditions.

Phantom File	surf_sam_plan.txt
Phantom	Validation plane
Band	1800MHz
Signal	CW
Frequency (MHz)	1800.000000
Relative permittivity (real part)	54.685214
Conductivity (S/m)	1.508863
Power drift (%)	1.160000
Ambient Temperature:	21.6°C
Liquid Temperature:	21.1°C
ConvF:	2.08
Crest factor:	1:1

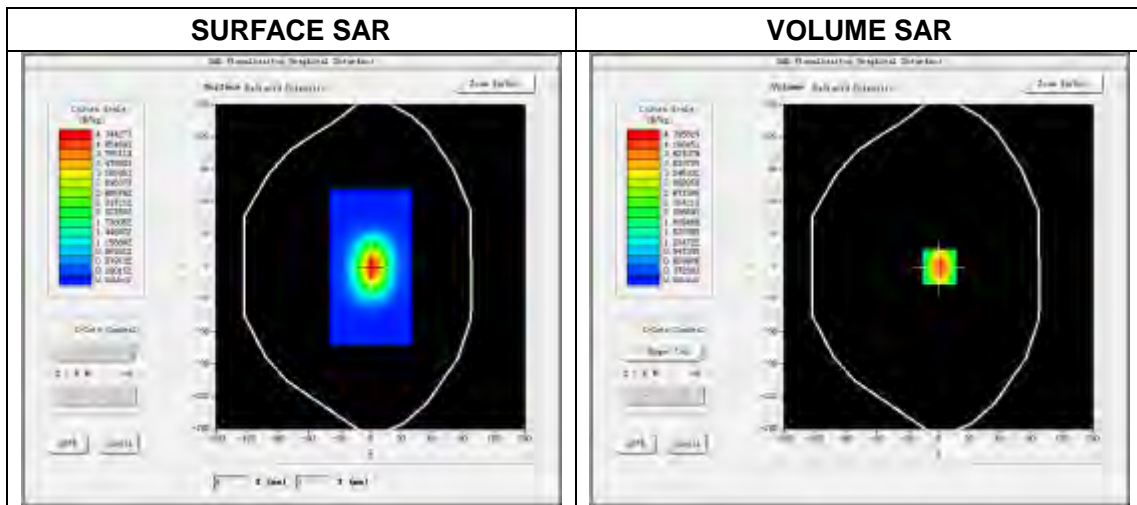



Maximum location: X=0.00, Y=0.00

SAR Peak: 6.52 W/kg

SAR 10 g (W/Kg)	1.989471
SAR 1g (W/Kg)	3.911256

### Z Axis Scan

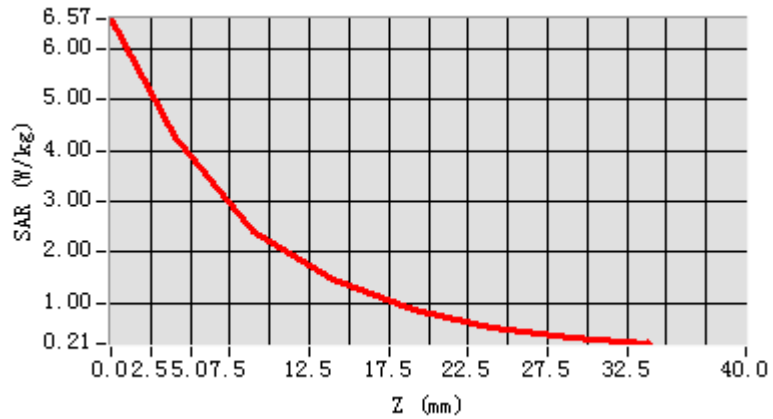

3D screen shot

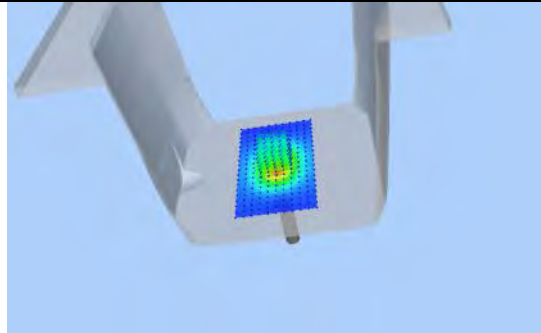

Hot spot position

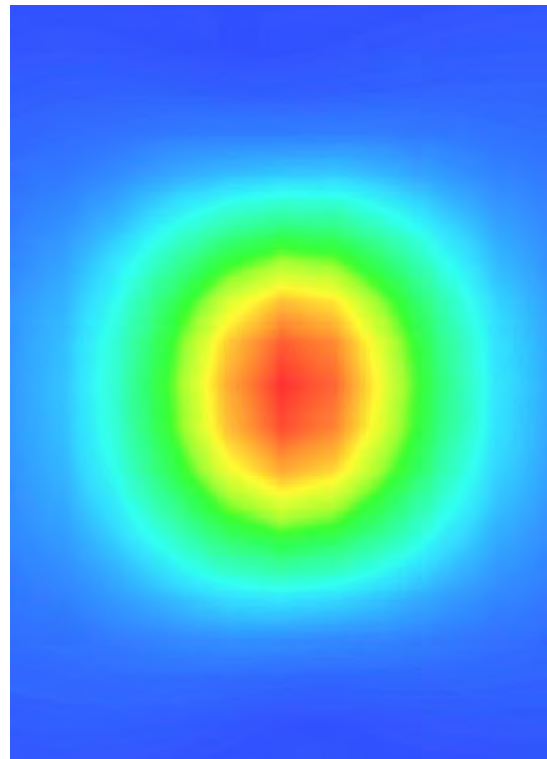

## 5.7 DIP 1G900

### 5.7.1 Dipole 1900 MHz Validation Measurement for Head Tissue

## System Performance Check Data(1900 MHz Head)

Type: Phone measurement (Complete)  
 E-Field Probe: SN 34/15 SSE2 EPGO265  
 Area scan resolution: dx=8mm,dy=8mm  
 Zoom scan resolution: dx=8mm, dy=8mm, dz=5mm  
 Date of measurement: 2016.03.02  
 Measurement duration: 13 minutes 20 seconds

### Experimental conditions.

<b>Phantom File</b>	surf_sam_plan.txt
<b>Phantom</b>	Validation plane
<b>Band</b>	1900MHz
<b>Signal</b>	CW
<b>Frequency (MHz)</b>	1900.000000
<b>Relative permittivity (real part)</b>	39.402471
<b>Conductivity (S/m)</b>	1.425793
<b>Power drift (%)</b>	1.260000
<b>Ambient Temperature:</b>	21.8°C
<b>Liquid Temperature:</b>	21.2°C
<b>ConvF:</b>	2.35
<b>Crest factor:</b>	1:1

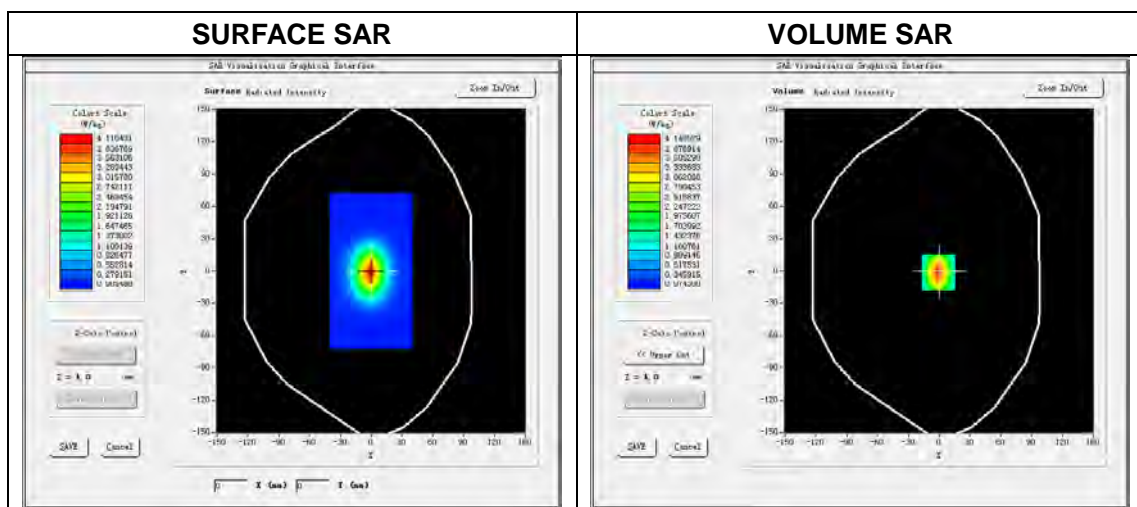

Maximum location: X=0.00, Y=0.00

SAR Peak: 6.46W/kg

SAR 10g (W/Kg)	1.967525
SAR 1g (W/Kg)	3.890170

### Z Axis Scan

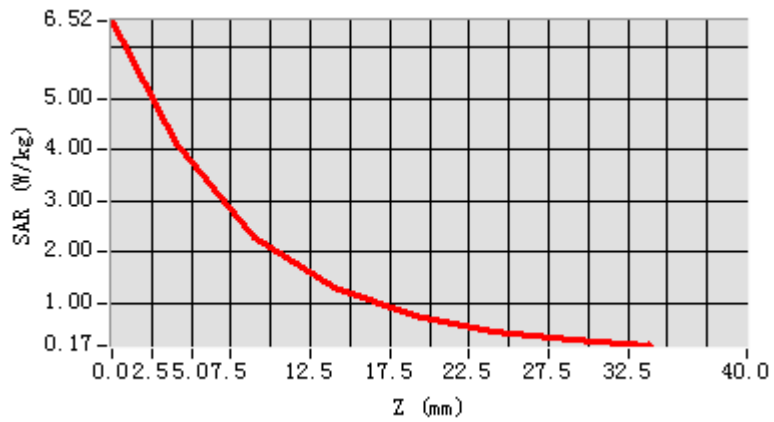

3D screen shot

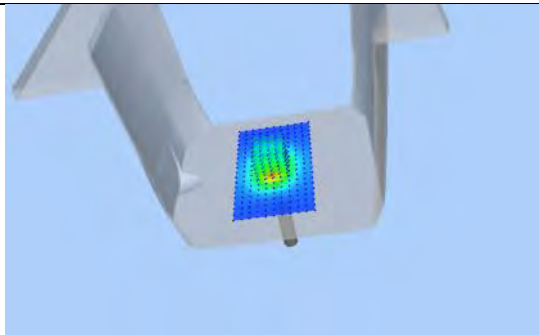

Hot spot position

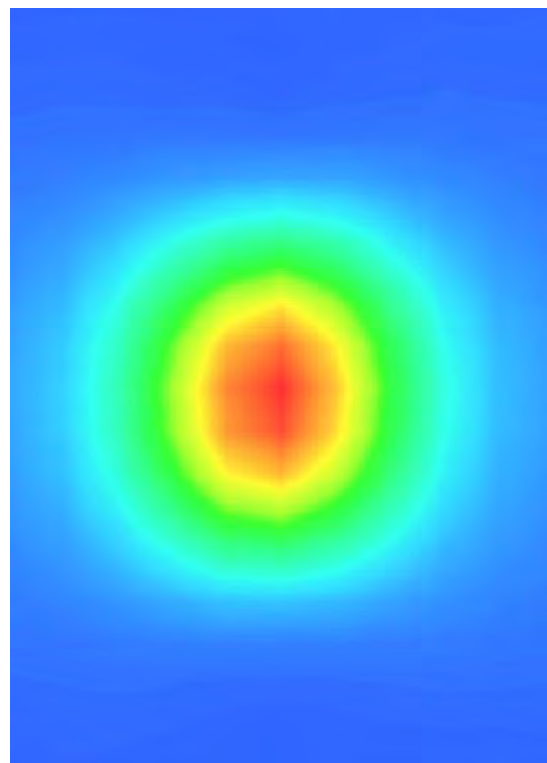

## 5.7.2 Dipole 1900 MHz Validation Measurement for Body Tissue

# System Performance Check Data(1900 MHz Body)

Type: Phone measurement (Complete)  
 E-Field Probe: SN 34/15 SSE2 EPGO265  
 Area scan resolution: dx=8mm,dy=8mm  
 Zoom scan resolution: dx=8mm, dy=8mm, dz=5mm  
 Date of measurement: 2016.03.02  
 Measurement duration: 13 minutes 20 seconds

### Experimental conditions.

<b>Phantom File</b>	surf_sam_plan.txt
<b>Phantom</b>	Validation plane
<b>Band</b>	1900 MHz
<b>Signal</b>	CW
<b>Frequency (MHz)</b>	1900.000000
<b>Relative permittivity (real part)</b>	53.158287
<b>Conductivity (S/m)</b>	1.534258
<b>Power drift (%)</b>	0.180000
<b>Ambient Temperature:</b>	21.8°C
<b>Liquid Temperature:</b>	21.2°C
<b>ConvF:</b>	2.42
<b>Crest factor:</b>	1:1

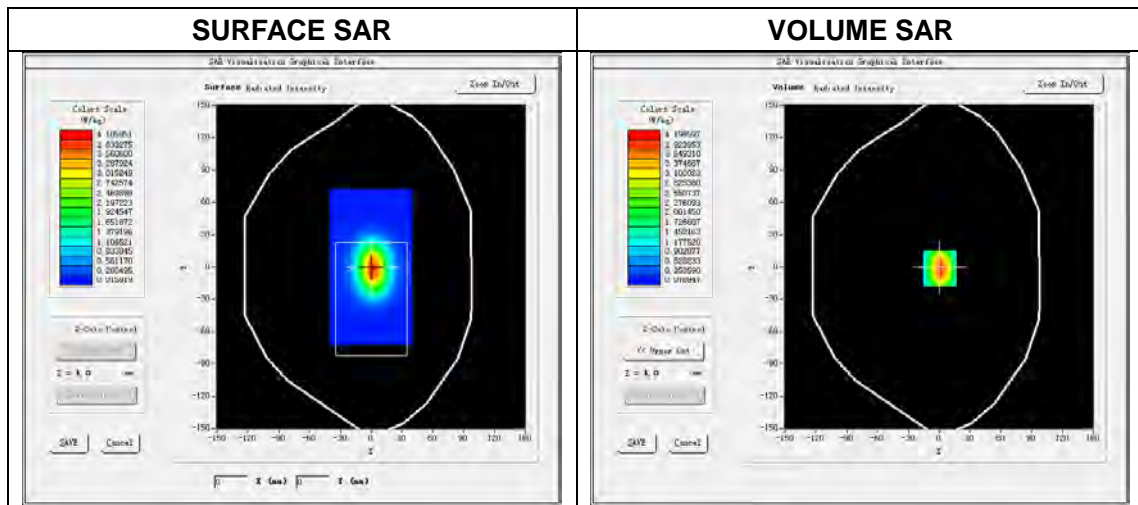

Maximum location: X=0.00, Y=0.00

SAR Peak: 6.64W/kg

SAR 10g (W/Kg)	2.001651
SAR 1g (W/Kg)	3.943225

### Z Axis Scan

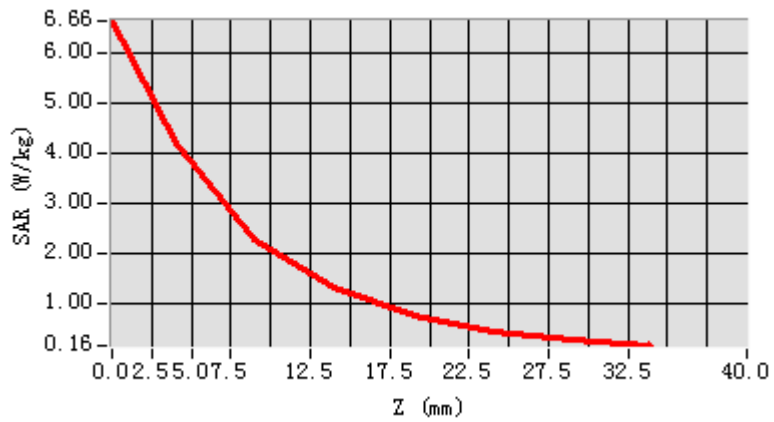

3D screen shot

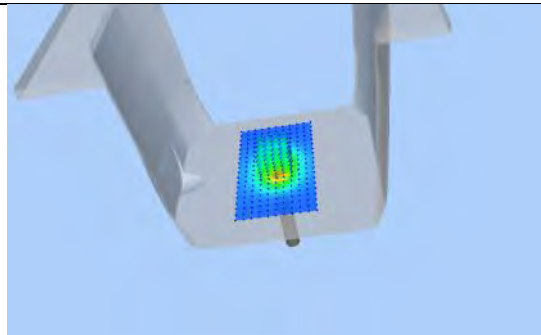

Hot spot position

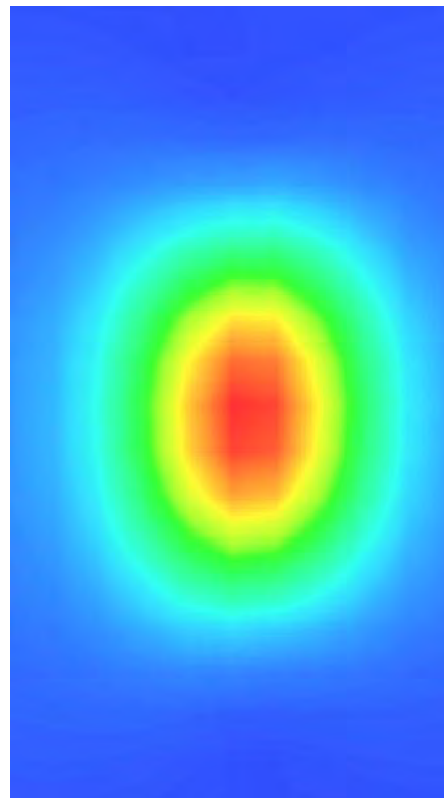

## 5.8 DIP 2G000

### 5.8.1 Dipole 2000 MHz Validation Measurement for Head Tissue

## System Performance Check Data(2000 MHz Head)

Type: Phone measurement (Complete)  
 E-Field Probe: SN 34/15 SSE2 EPGO265  
 Area scan resolution: dx=8 mm,dy=8 mm  
 Zoom scan resolution: dx=8 mm, dy=8 mm, dz=5 mm  
 Date of measurement: 2016.03.02  
 Measurement duration: 14 minutes 17 seconds

### Experimental conditions.

<b>Phantom File</b>	surf_sam_plan.txt
<b>Phantom</b>	Validation plane
<b>Band</b>	2000 MHz
<b>Signal</b>	CW
<b>Frequency (MHz)</b>	2000.000000
<b>Relative permittivity (real part)</b>	38.957269
<b>Conductivity (S/m)</b>	1.426154
<b>Power drift (%)</b>	1.20000
<b>Ambient Temperature:</b>	21.8°C
<b>Liquid Temperature:</b>	21.2°C
<b>ConvF:</b>	2.23
<b>Crest factor:</b>	1:1

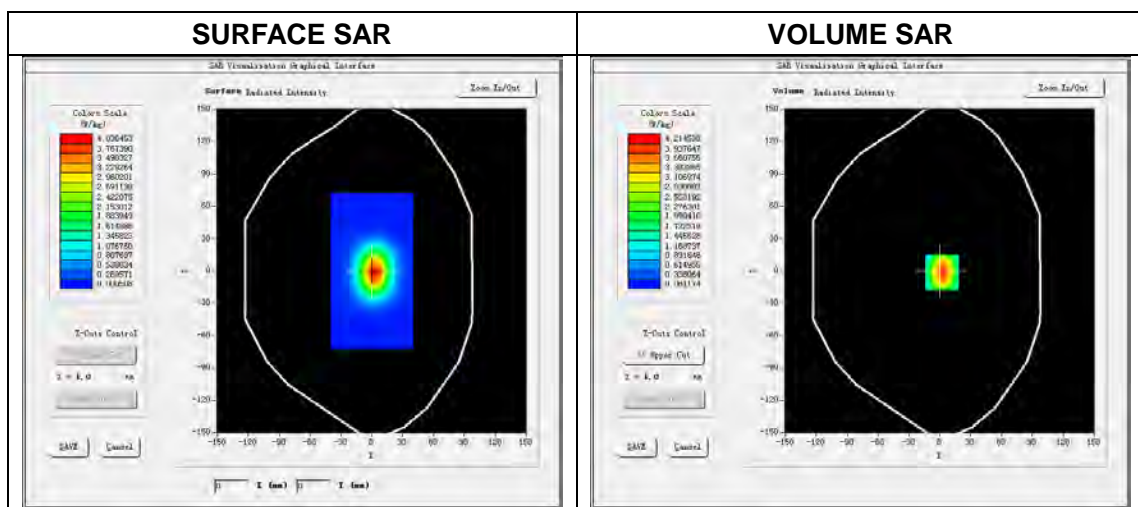

Maximum location: X=0.00, Y=0.00

SAR Peak: 6.69 W/kg

SAR 10 g (W/Kg)	2.094211
SAR 1 g (W/Kg)	4.029382

### Z Axis Scan

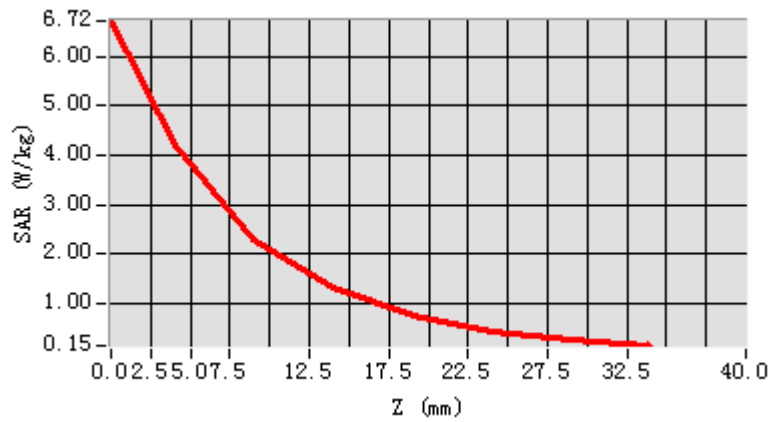

3D screen shot

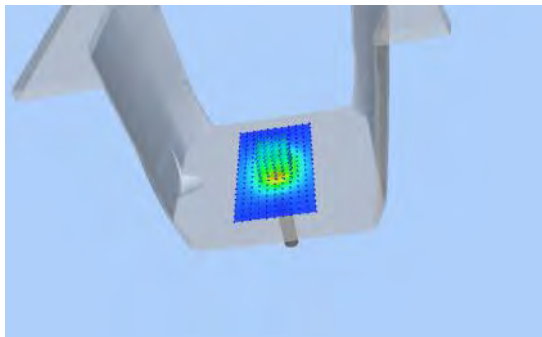

Hot spot position

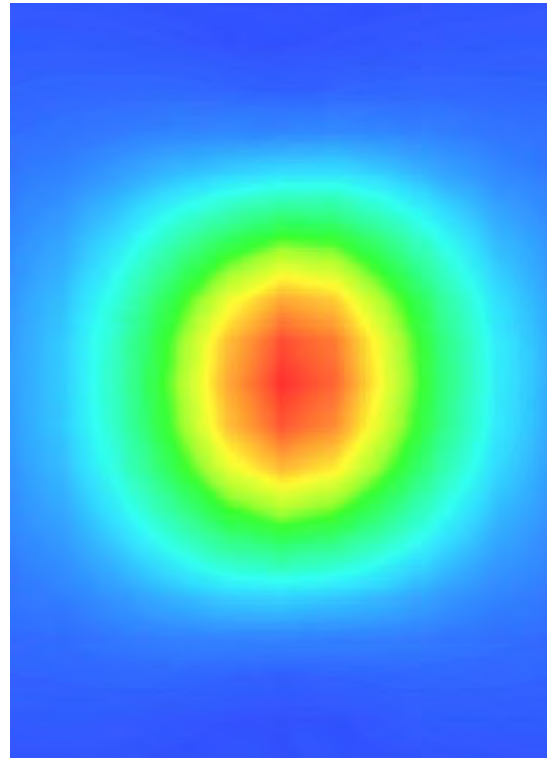

## 5.8.2 Dipole 2000 MHz Validation Measurement for Body Tissue

# System Performance Check Data(2000 MHz Body)

Type: Phone measurement (Complete)

E-Field Probe: SN 34/15 SSE2 EPGO265

Area scan resolution: dx=8 mm,dy=8 mm

Zoom scan resolution: dx=8 mm, dy=8 mm, dz=5 mm

Date of measurement: 2016.03.02

Measurement duration: 14 minutes 17 seconds

### Experimental conditions.

<b>Phantom File</b>	surf_sam_plan.txt
<b>Phantom</b>	Validation plane
<b>Band</b>	2000 MHz
<b>Signal</b>	CW
<b>Frequency (MHz)</b>	2000.000000
<b>Relative permittivity (real part)</b>	51.526653
<b>Conductivity (S/m)</b>	1.551869
<b>Power drift (%)</b>	0.380000
<b>Ambient Temperature:</b>	21.8°C
<b>Liquid Temperature:</b>	21.2°C
<b>ConvF:</b>	2.32
<b>Crest factor:</b>	1:1

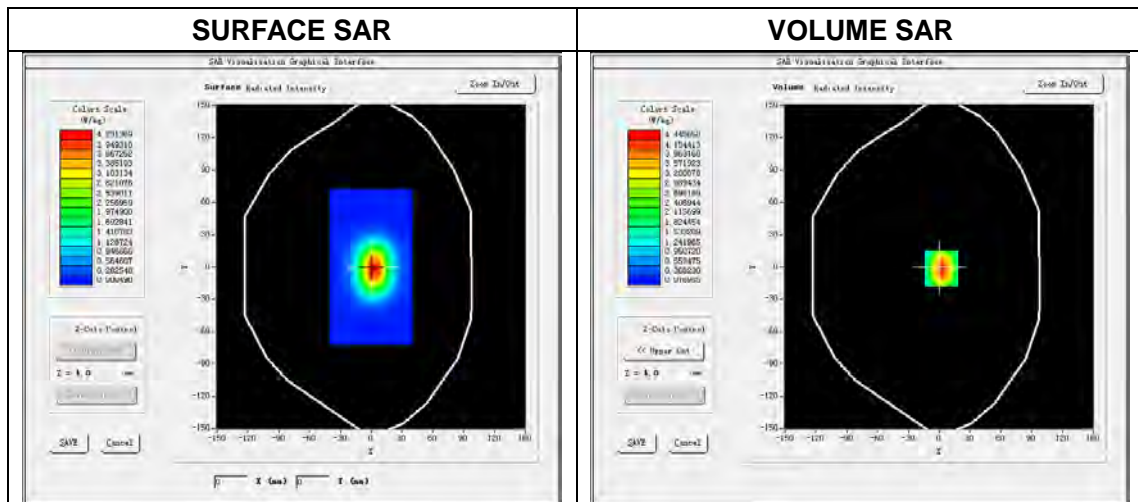



Maximum location: X=0.00, Y=0.00

SAR Peak: 6.97 W/kg

SAR 10 g (W/Kg)	2.185249
SAR 1 g (W/Kg)	4.196616

### Z Axis Scan

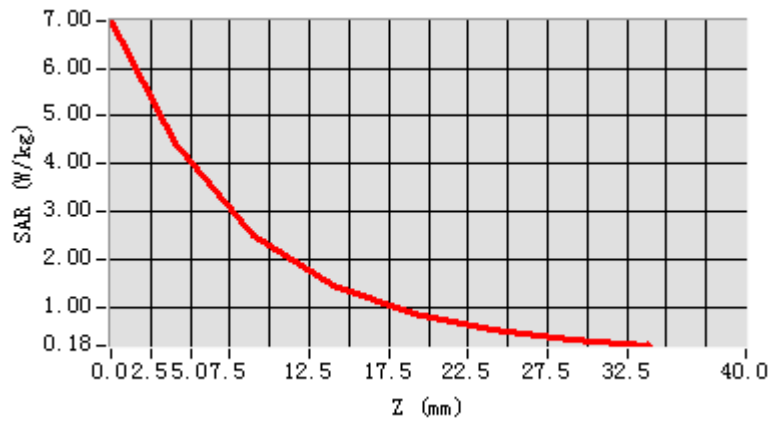

3D screen shot

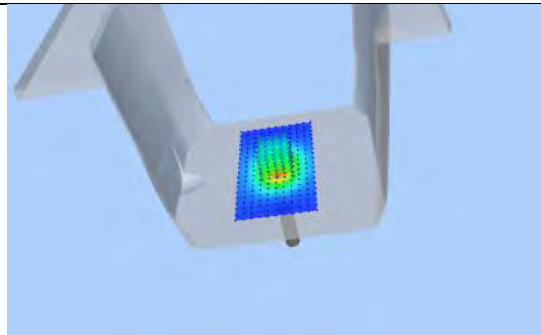

Hot spot position

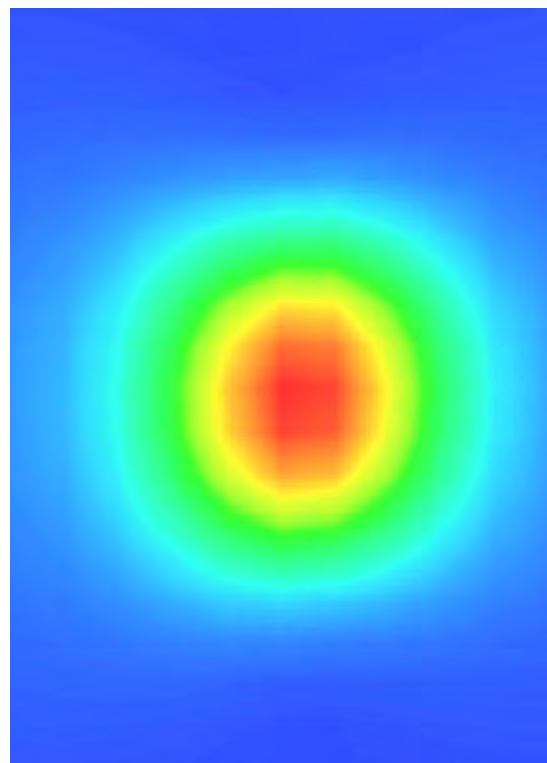

## 5.9 DIP 2G450

### 5.9.1 Dipole 2450 MHz Validation Measurement for Head Tissue

## System Performance Check Data(2450 MHz Head)

Type: Phone measurement (Complete)  
 E-Field Probe: SN 34/15 SSE2 EPGO265  
 Area scan resolution: dx=8mm,dy=8mm  
 Zoom scan resolution: dx=5mm, dy=5mm, dz=5mm  
 Date of measurement: 2016.03.02  
 Measurement duration: 18 minutes 47 seconds

### Experimental conditions.

Phantom File	surf_sam_plan.txt
Phantom	Validation plane
Band	2450MHz
Signal	CW
Frequency (MHz)	2450.000000
Relative permittivity (real part)	38.916950
Conductivity (S/m)	1.816079
Power drift (%)	2.570000
Ambient Temperature:	21.8°C
Liquid Temperature:	21.2°C
ConvF:	2.47
Crest factor:	1:1

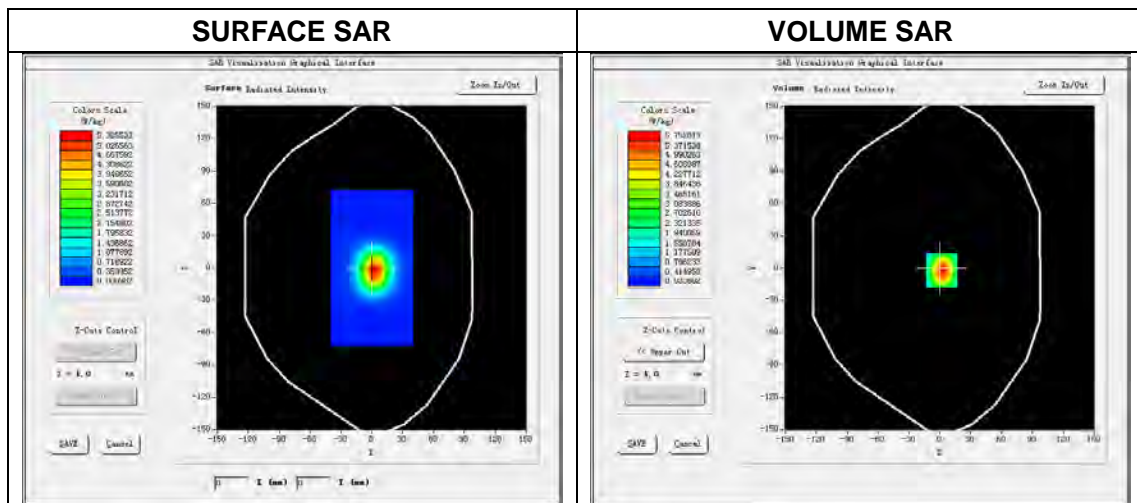

Maximum location: X=0.00, Y=0.00

SAR Peak: 9.52 W/kg

SAR 10g (W/Kg)	2.483244
SAR 1g (W/Kg)	5.328480

### Z Axis Scan

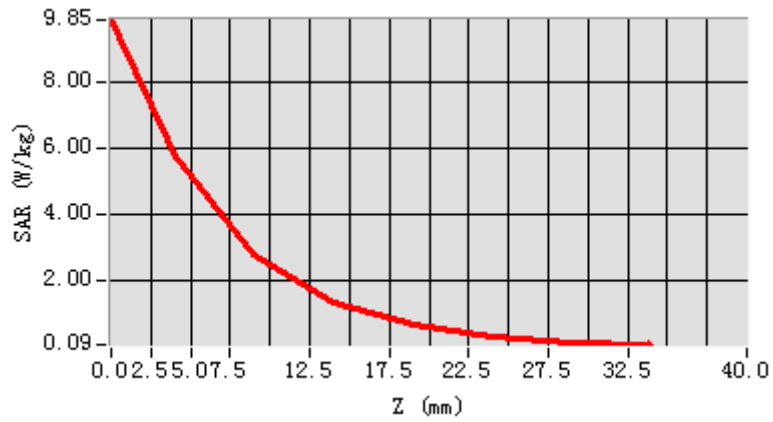

3D screen shot

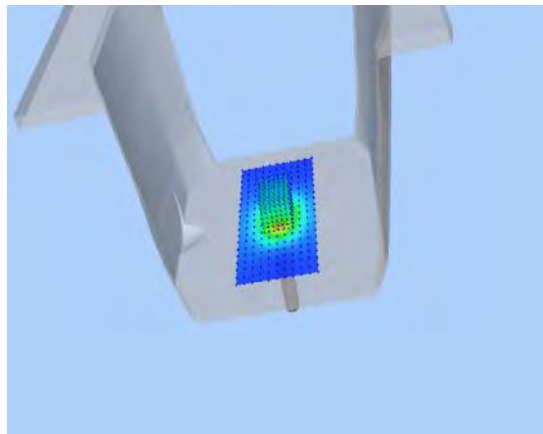

Hot spot position

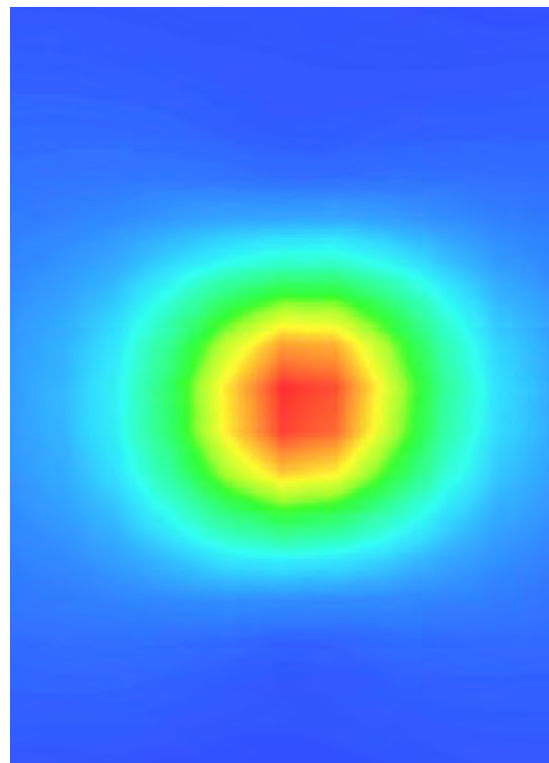

## 5.9.2 Dipole 2450 MHz Validation Measurement for Body Tissue

# System Performance Check Data(2450 MHz Body)

Type: Phone measurement (Complete)

E-Field Probe: SN 34/15 SSE2 EPGO265

Area scan resolution: dx=8 mm,dy=8 mm

Zoom scan resolution: dx=5 mm, dy=5 mm, dz=5 mm

Date of measurement: 2016.03.02

Measurement duration: 19 minutes 58 seconds

### Experimental conditions.

<b>Phantom File</b>	surf_sam_plan.txt
<b>Phantom</b>	Validation plane
<b>Band</b>	2450 MHz
<b>Signal</b>	CW
<b>Frequency (MHz)</b>	2450.000000
<b>Relative permittivity (real part)</b>	52.962515
<b>Conductivity (S/m)</b>	1.960472
<b>Power drift (%)</b>	-0.560000
<b>Ambient Temperature:</b>	21.8°C
<b>Liquid Temperature:</b>	21.2°C
<b>ConvF:</b>	2.55
<b>Crest factor:</b>	1:1

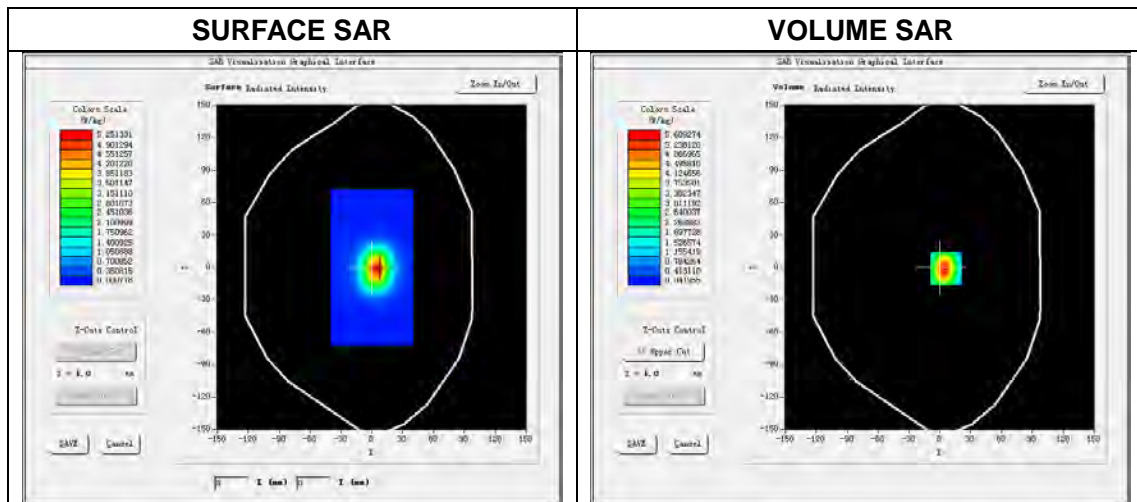

Maximum location: X=0.00, Y=0.00

SAR Peak: 9.02 W/kg

SAR 10 g (W/Kg)	2.450144
SAR 1 g (W/Kg)	5.094052

### Z Axis Scan

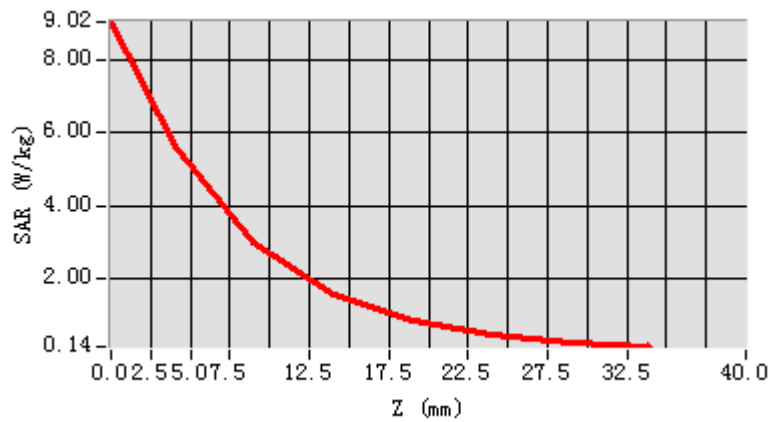

### 3D screen shot

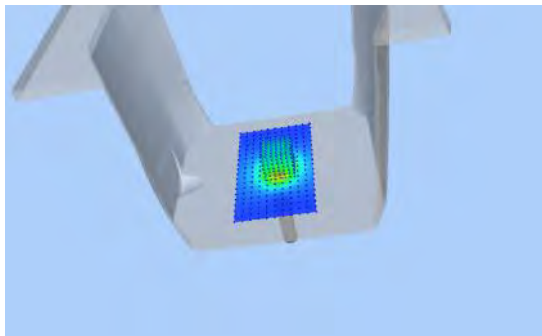

### Hot spot position

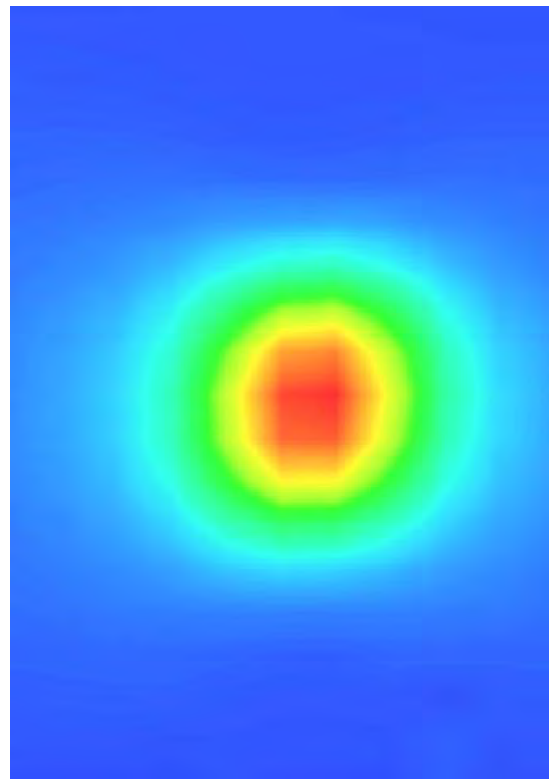

## 5.10DIP 2G600

### 5.10.1 Dipole 2600 MHz Validation Measurement for Head Tissue

# System Performance Check Data(2600 MHz Head)

Type: Phone measurement (Complete)

E-Field Probe: SN 34/15 SSE2 EPGO265

Area scan resolution: dx=8 mm,dy=8 mm

Zoom scan resolution: dx=5 mm, dy=5 mm, dz=5 mm

Date of measurement: 2016.03.03

Measurement duration: 19 minutes 3 seconds

### Experimental conditions.

<b>Phantom File</b>	surf_sam_plan.txt
<b>Phantom</b>	Validation plane
<b>Band</b>	2600 MHz
<b>Signal</b>	CW
<b>Frequency (MHz)</b>	2600.000000
<b>Relative permittivity (real part)</b>	38.097251
<b>Conductivity (S/m)</b>	1.978736
<b>Power drift (%)</b>	-0.050000
<b>Ambient Temperature:</b>	21.8°C
<b>Liquid Temperature:</b>	21.2°C
<b>ConvF:</b>	2.36
<b>Crest factor:</b>	1:1

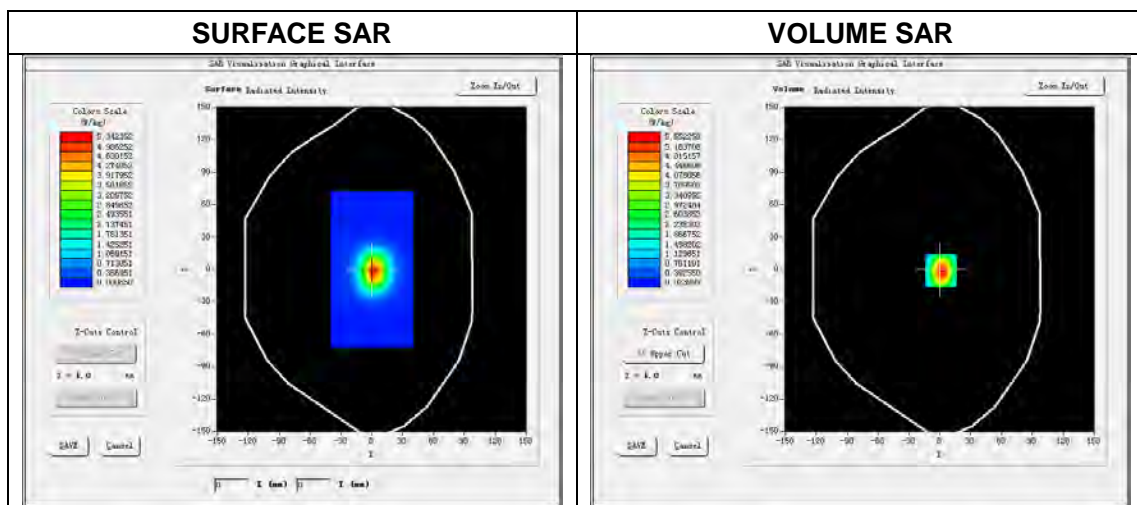

Maximum location: X=0.00, Y=0.00

SAR Peak: 9.58 W/kg

SAR 10 g (W/Kg)	2.514654
SAR 1 g (W/Kg)	5.322832

### Z Axis Scan

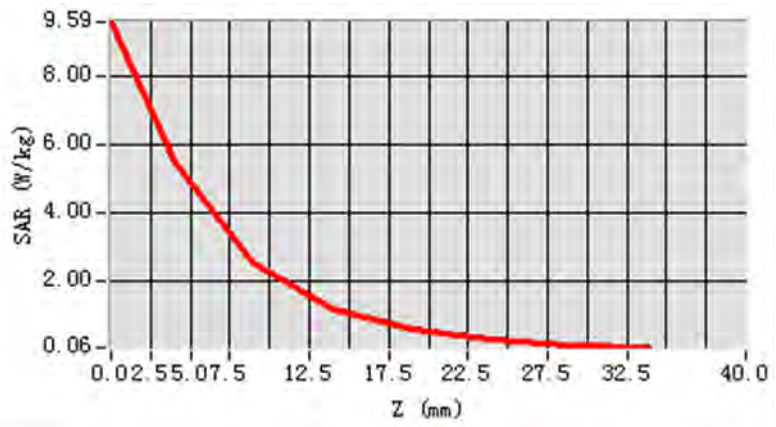

3D screen shot

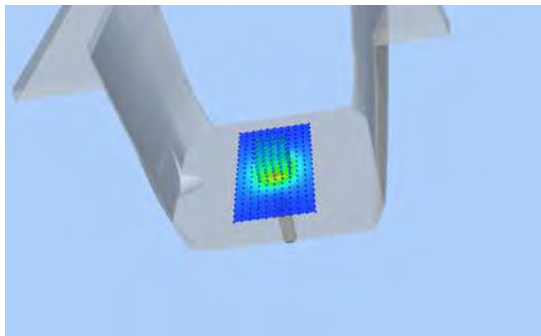

Hot spot position

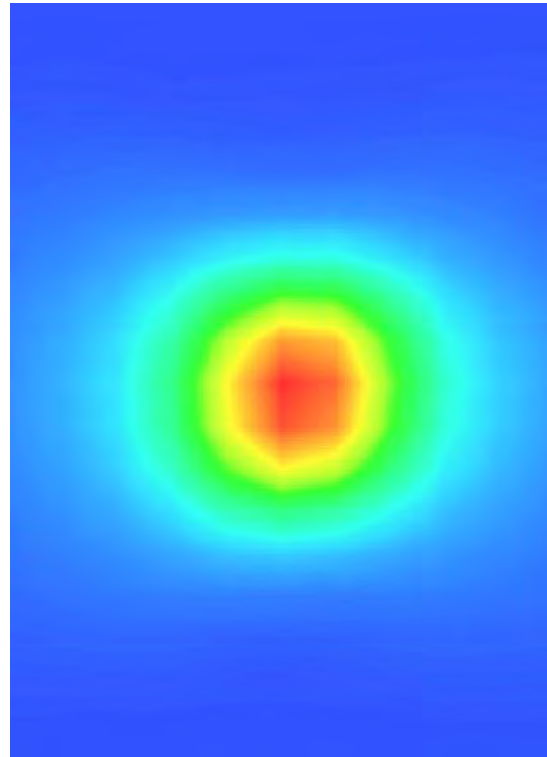

### 5.10.2 Dipole 2600 MHz Validation Measurement for Body Tissue

## System Performance Check Data(2600 MHz Body)

Type: Phone measurement (Complete)  
 E-Field Probe: SN 34/15 SSE2 EPGO265  
 Area scan resolution: dx=8 mm,dy=8 mm  
 Zoom scan resolution: dx=5 mm, dy=5 mm, dz=5 mm  
 Date of measurement: 2016.03.03  
 Measurement duration: 19 minutes 1 seconds

### Experimental conditions.

<b>Phantom File</b>	surf_sam_plan.txt
<b>Phantom</b>	Validation plane
<b>Band</b>	2600 MHz
<b>Signal</b>	CW
<b>Frequency (MHz)</b>	2600.000000
<b>Relative permittivity (real part)</b>	53.509271
<b>Conductivity (S/m)</b>	2.150646
<b>Power drift (%)</b>	0.180000
<b>Ambient Temperature:</b>	21.8°C
<b>Liquid Temperature:</b>	21.2°C
<b>ConvF:</b>	2.43
<b>Crest factor:</b>	1:1

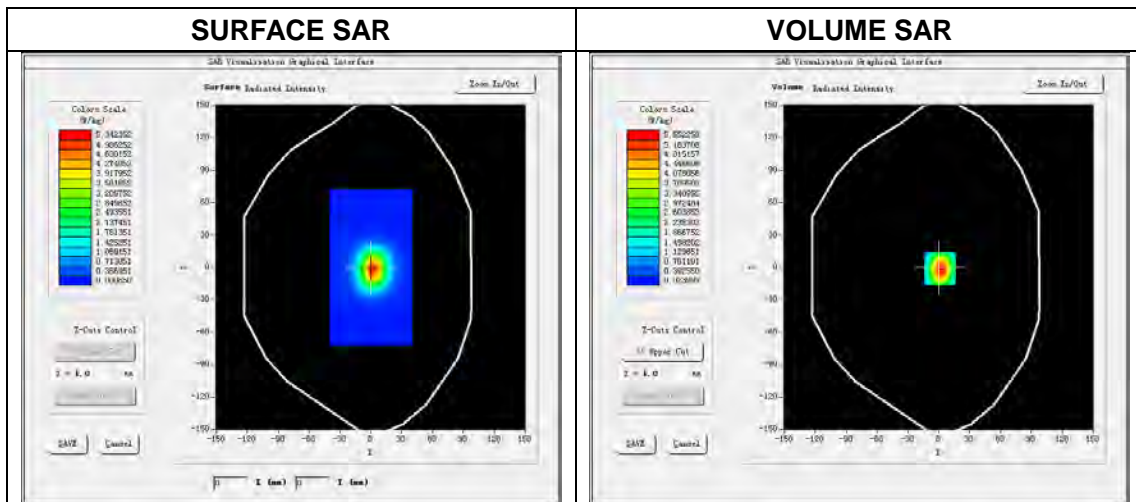



Maximum location: X=0.00, Y=0.00

SAR Peak: 9.36 W/kg

SAR 10 g (W/Kg)	2.376986
SAR 1 g (W/Kg)	5.174332

### Z Axis Scan

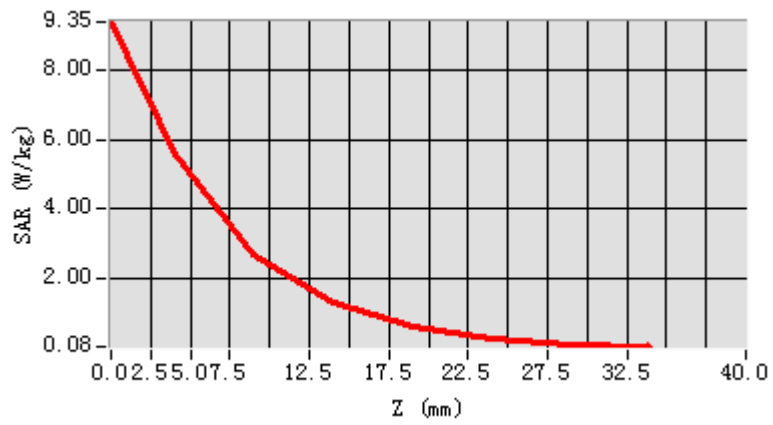

3D screen shot

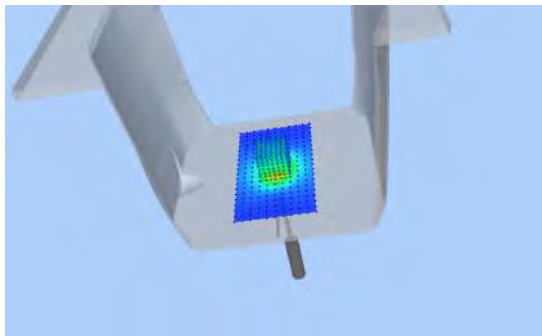

Hot spot position

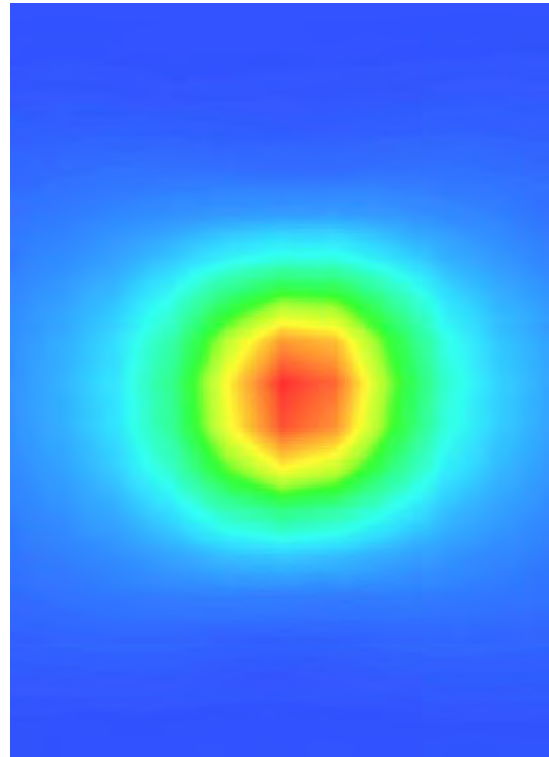

## 5.11 SWG5500

### 5.11.1 Waveguide 5 GHz Validation Measurement for Head Tissue

## System Performance Check Data(5200 MHz Head)

Type: Phone measurement (Complete)  
 E-Field Probe: SN 34/15 SSE2 EPGO265  
 Area scan resolution: dx=8mm,dy=8mm  
 Zoom scan resolution: dx=4mm, dy=4mm, dz=2mm  
 Date of measurement: 2016.03.03  
 Measurement duration: 29 minutes 32 seconds

### Experimental conditions.

<b>Phantom File</b>	surf_sam_plan.txt
<b>Phantom</b>	Validation plane
<b>Band</b>	5200 MHz
<b>Signal</b>	CW
<b>Frequency (MHz)</b>	5200.000000
<b>Relative permittivity (real part)</b>	36.867518
<b>Conductivity (S/m)</b>	4.644428
<b>Power drift (%)</b>	1.570000
<b>Ambient Temperature:</b>	21.5°C
<b>Liquid Temperature:</b>	21.0°C
<b>ConvF:</b>	1.81
<b>Crest factor:</b>	1:1

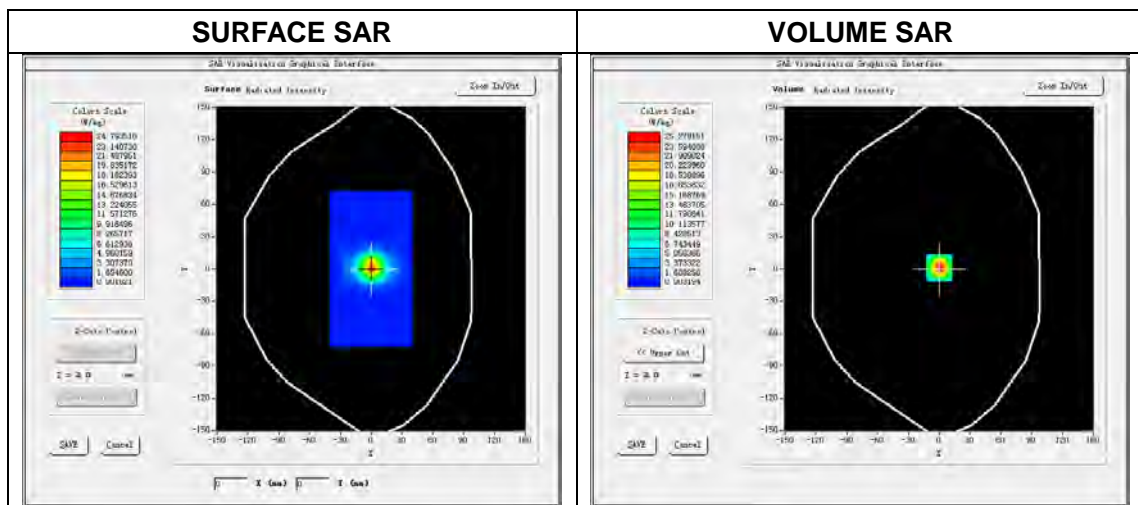

Maximum location: X=3.00, Y=1.00

SAR Peak: 42.15 W/kg

SAR 10g (W/Kg)	5.4633244
SAR 1g (W/Kg)	15.378286

### Z Axis Scan

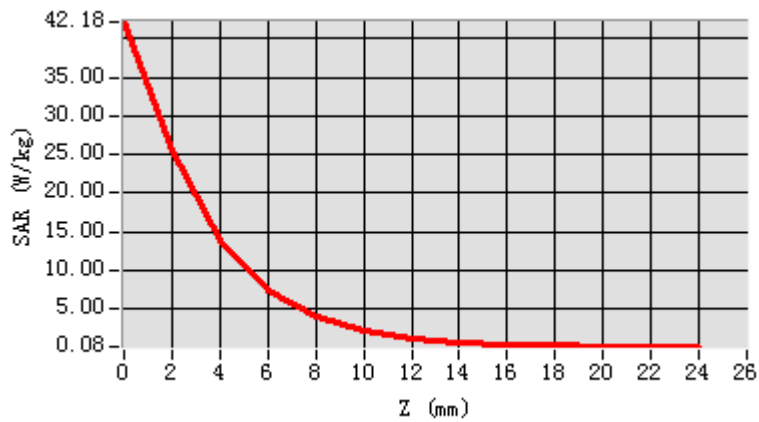

3D screen shot

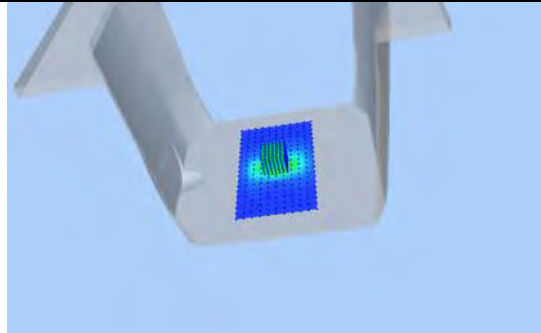

Hot spot position

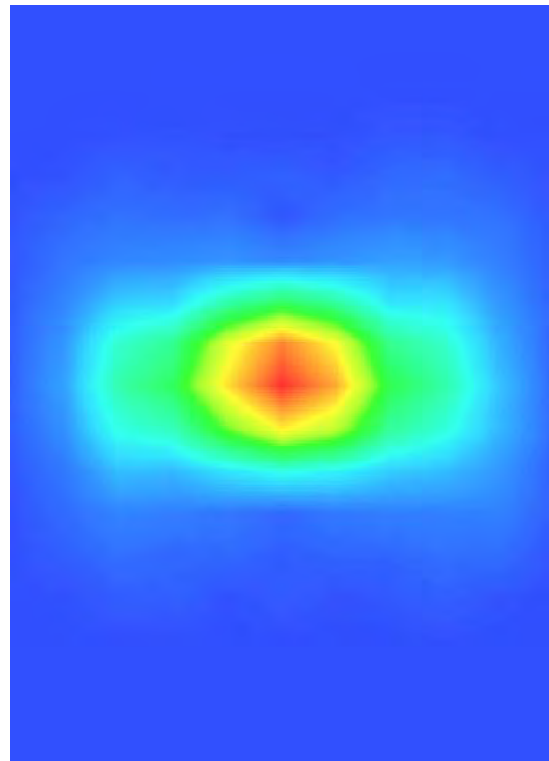

# System Performance Check Data(5400 MHz Head)

Type: Phone measurement (Complete)  
 E-Field Probe: SN 34/15 SSE2 EPGO265  
 Area scan resolution: dx=8mm,dy=8mm  
 Zoom scan resolution: dx=4mm, dy=4mm, dz=2mm  
 Date of measurement: 2016.03.03  
 Measurement duration: 29 minutes 33 seconds

## Experimental conditions.

Phantom File	surf_sam_plan.txt
Phantom	Validation plane
Band	5400 MHz
Signal	CW
Frequency (MHz)	5400.000000
Relative permittivity (real part)	36.426257
Conductivity (S/m)	4.831236
Power drift (%)	1.120000
Ambient Temperature:	21.5°C
Liquid Temperature:	21.0°C
ConvF:	2.04
Crest factor:	1:1

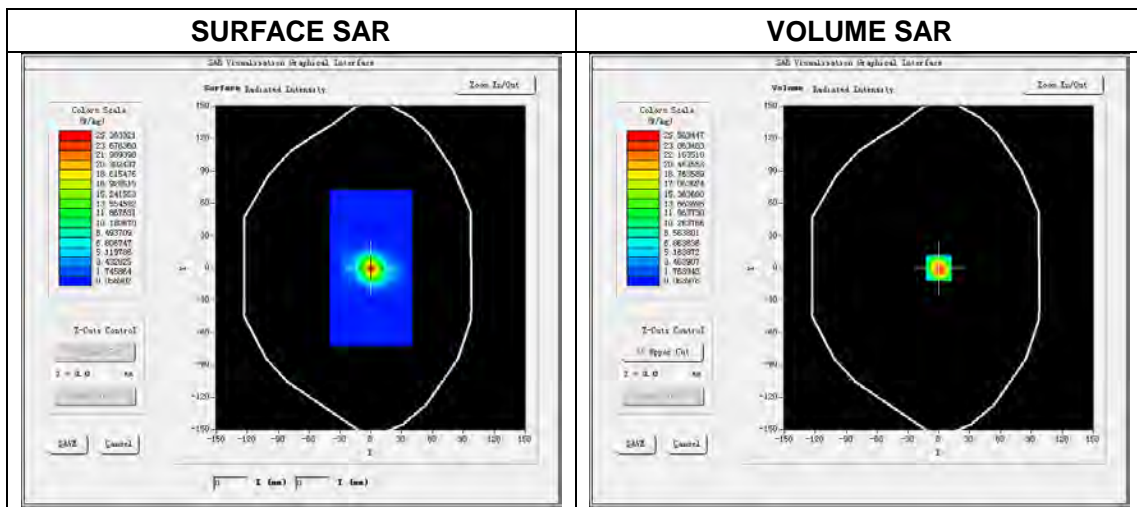

Maximum location: X=0.00, Y=0.00

SAR Peak: 44.03 W/kg

SAR 10g (W/Kg)	5.517354
SAR 1g (W/Kg)	15.876169

### Z Axis Scan

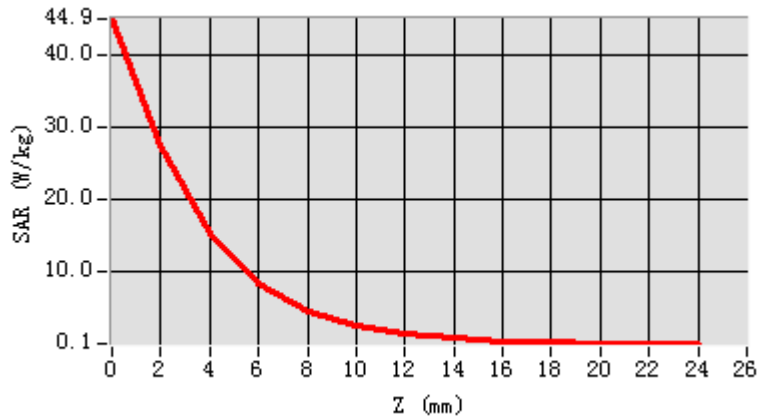

3D screen shot

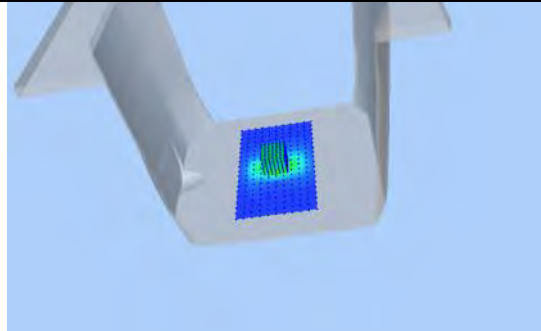

Hot spot position

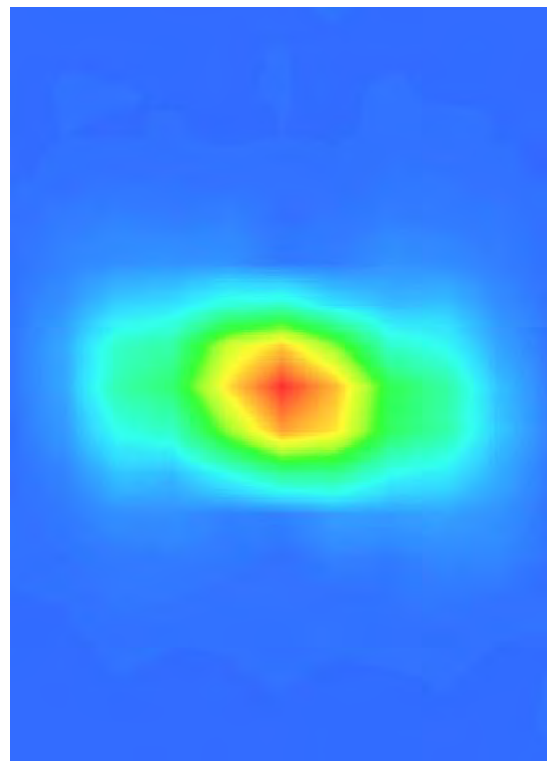

# System Performance Check Data(5600 MHz Head)

Type: Phone measurement (Complete)  
 E-Field Probe: SN 34/15 SSE2 EPGO265  
 Area scan resolution: dx=8mm,dy=8mm  
 Zoom scan resolution: dx=4mm, dy=4mm, dz=2mm  
 Date of measurement: 2016.03.03  
 Measurement duration: 29 minutes 30 seconds

## Experimental conditions.

Phantom File	surf_sam_plan.txt
Phantom	Validation plane
Band	5600 MHz
Signal	CW
Frequency (MHz)	5600.000000
Relative permittivity (real part)	34.462351
Conductivity (S/m)	5.137525
Power drift (%)	0.800000
Ambient Temperature:	21.5°C
Liquid Temperature:	21.0°C
ConvF:	2.08
Crest factor:	1:1

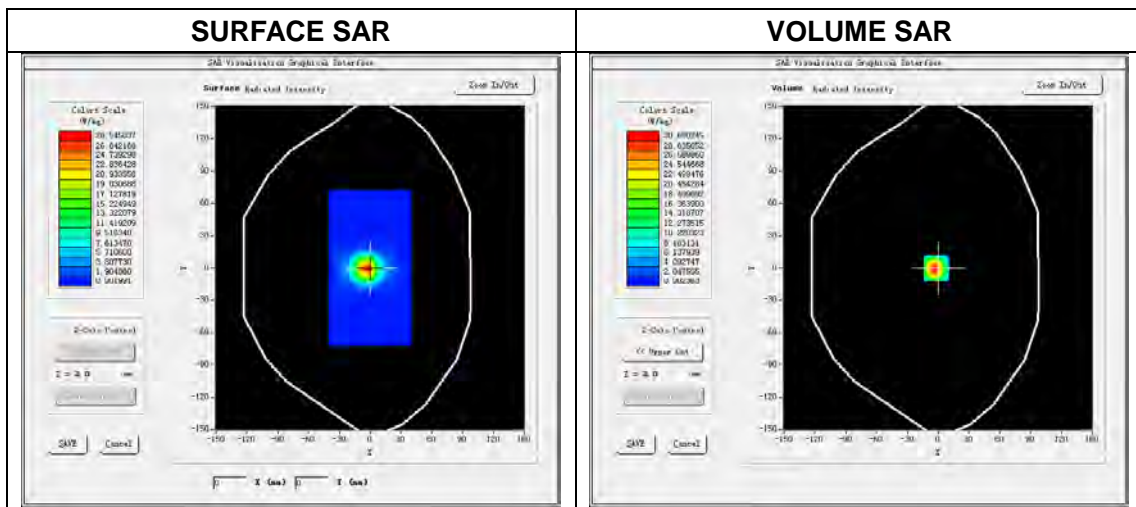

Maximum location: X=1.00, Y=1.00

SAR Peak: 49.52 W/kg

SAR 10g (W/Kg)	5.791756
SAR 1g (W/Kg)	16.475376

### Z Axis Scan

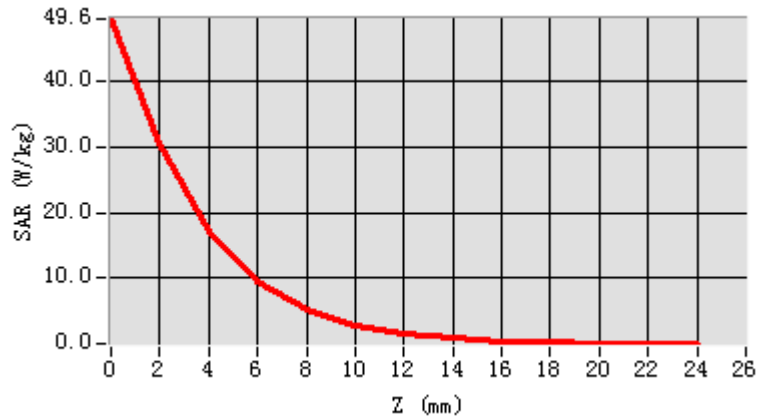

3D screen shot

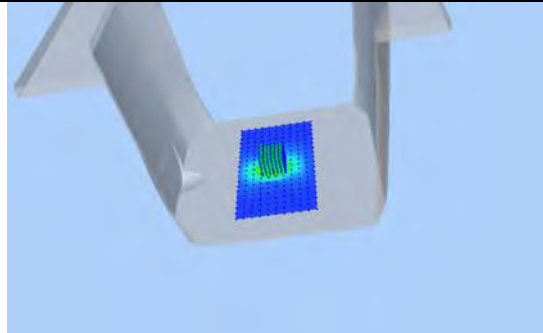

Hot spot position

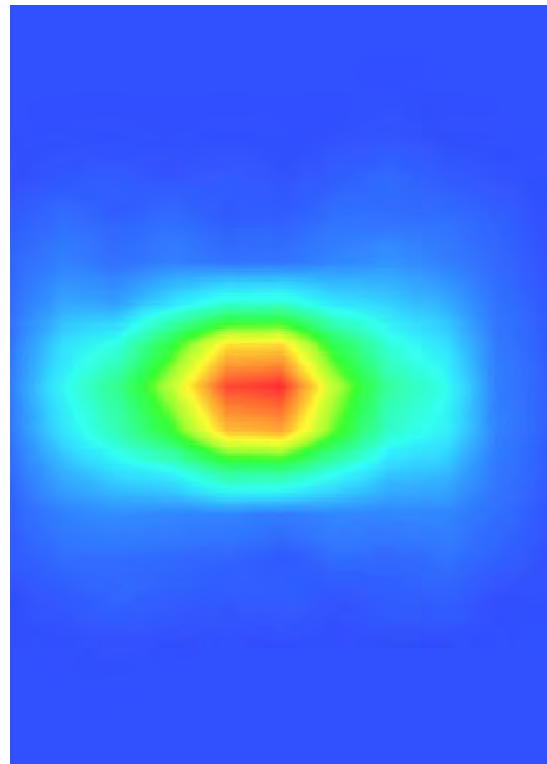

# System Performance Check Data(5800 MHz Head)

Type: Phone measurement (Complete)  
 E-Field Probe: SN 34/15 SSE2 EPGO265  
 Area scan resolution: dx=8mm,dy=8mm  
 Zoom scan resolution: dx=4mm, dy=4mm, dz=2mm  
 Date of measurement: 2016.03.03  
 Measurement duration: 29 minutes 31 seconds

## Experimental conditions.

Phantom File	surf_sam_plan.txt
Phantom	Validation plane
Band	5800 MHz
Signal	CW
Frequency (MHz)	5800.000000
Relative permittivity (real part)	34.327163
Conductivity (S/m)	5.305872
Power drift (%)	1.660000
Ambient Temperature:	21.5°C
Liquid Temperature:	21.0°C
ConvF:	1.88
Crest factor:	1:1

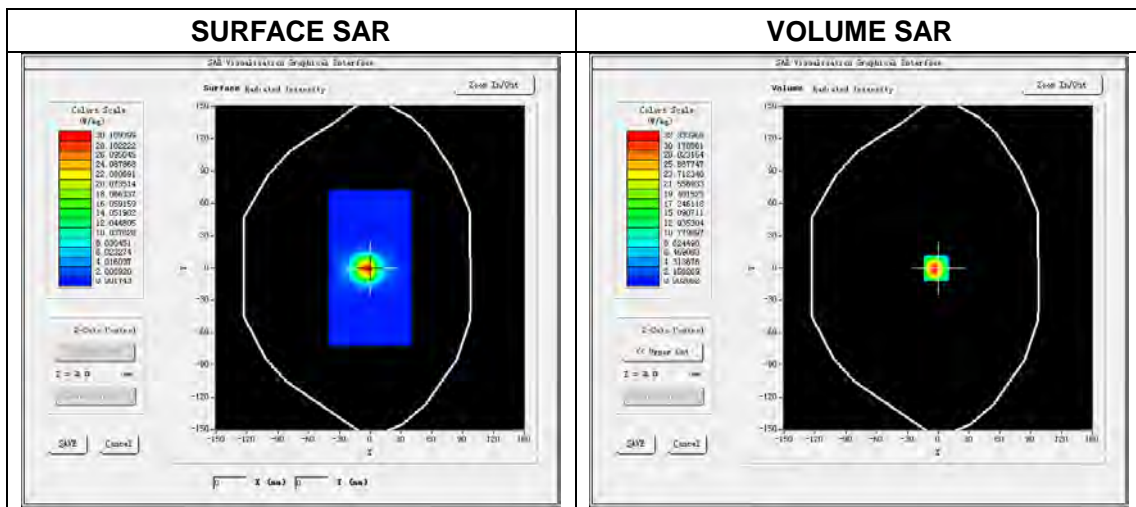



Maximum location: X=0.00, Y=0.00

SAR Peak: 51.16 W/kg

SAR 10g (W/Kg)	5.983526
SAR 1g (W/Kg)	17.687528

### Z Axis Scan

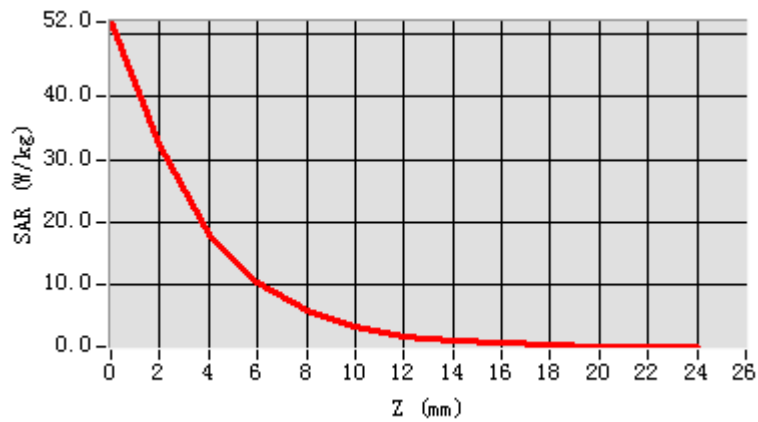

3D screen shot

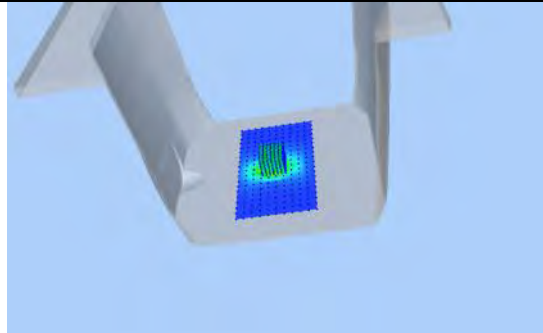

Hot spot position

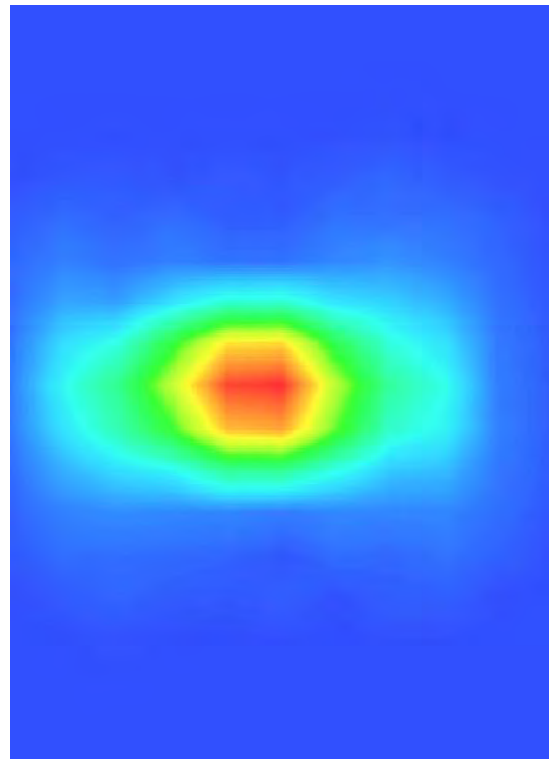

### 5.11.2 Waveguide 5 GHz Validation Measurement for Body Tissue

## System Performance Check Data(5200MHz Body)

Type: Phone measurement (Complete)  
 E-Field Probe: SN 34/15 SSE2 EPGO265  
 Area scan resolution: dx=8mm,dy=8mm  
 Zoom scan resolution: dx=4mm, dy=4mm, dz=2mm  
 Date of measurement: 2016.03.03  
 Measurement duration: 29 minutes 32 seconds

### Experimental conditions.

<b>Phantom File</b>	surf_sam_plan.txt
<b>Phantom</b>	Validation plane
<b>Band</b>	5200 MHz
<b>Signal</b>	CW
<b>Frequency (MHz)</b>	5200.000000
<b>Relative permittivity (real part)</b>	50.126533
<b>Conductivity (S/m)</b>	5.256854
<b>Power drift (%)</b>	2.320000
<b>Ambient Temperature:</b>	21.5°C
<b>Liquid Temperature:</b>	21.0°C
<b>ConvF:</b>	1.85
<b>Crest factor:</b>	1:1

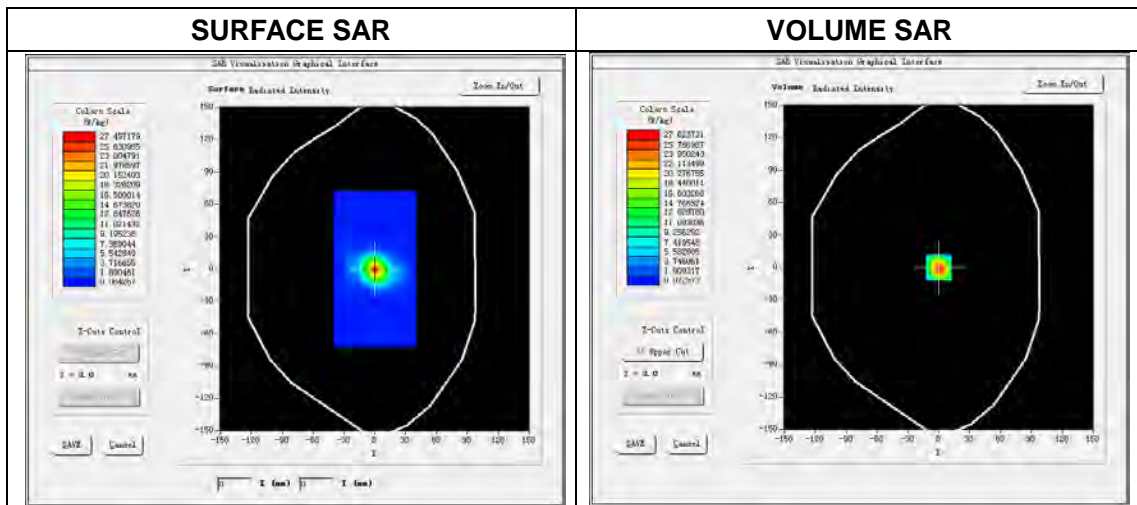

Maximum location: X=0.00, Y=0.00

SAR Peak: 40.51 W/kg

SAR 10g (W/Kg)	5.340976
SAR 1g (W/Kg)	15.223962

### Z Axis Scan

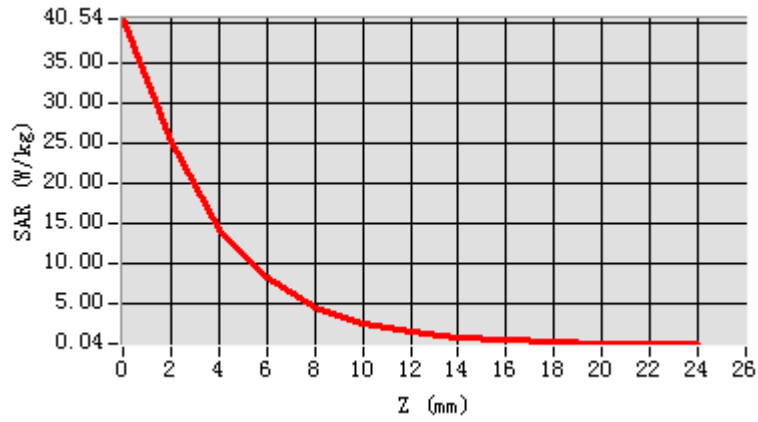

3D screen shot

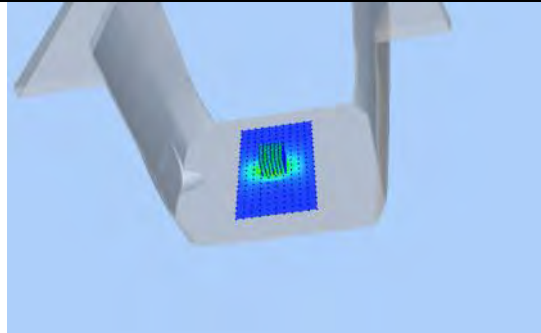

Hot spot position

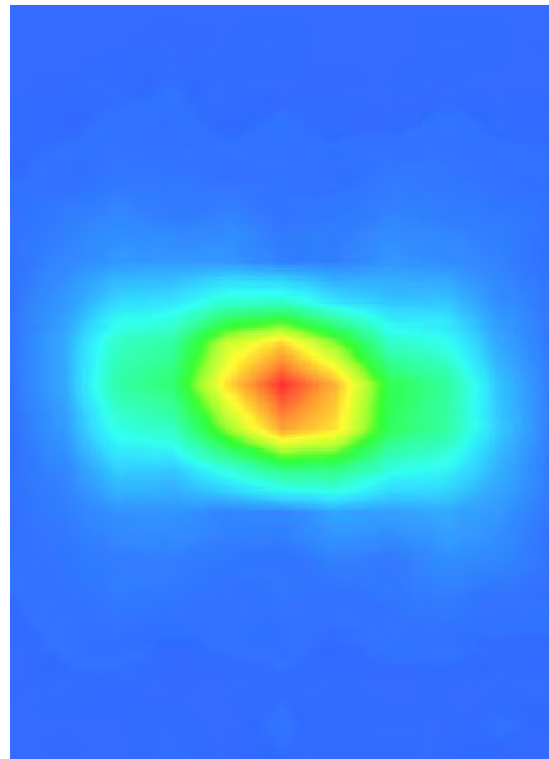

# System Performance Check Data (5400 MHz Body)

Type: Phone measurement (Complete)  
 E-Field Probe: SN 34/15 SSE2 EPGO265  
 Area scan resolution: dx=8mm,dy=8mm  
 Zoom scan resolution: dx=4mm, dy=4mm, dz=2mm  
 Date of measurement: 2016.03.03  
 Measurement duration: 29 minutes 32 seconds

## Experimental conditions.

Phantom File	surf_sam_plan.txt
Phantom	Validation plane
Band	5400 MHz
Signal	CW
Frequency (MHz)	5400.000000
Relative permittivity (real part)	50.016325
Conductivity (S/m)	5.513862
Power drift (%)	1.160000
Ambient Temperature:	21.5°C
Liquid Temperature:	21.0°C
ConvF:	2.11
Crest factor:	1:1

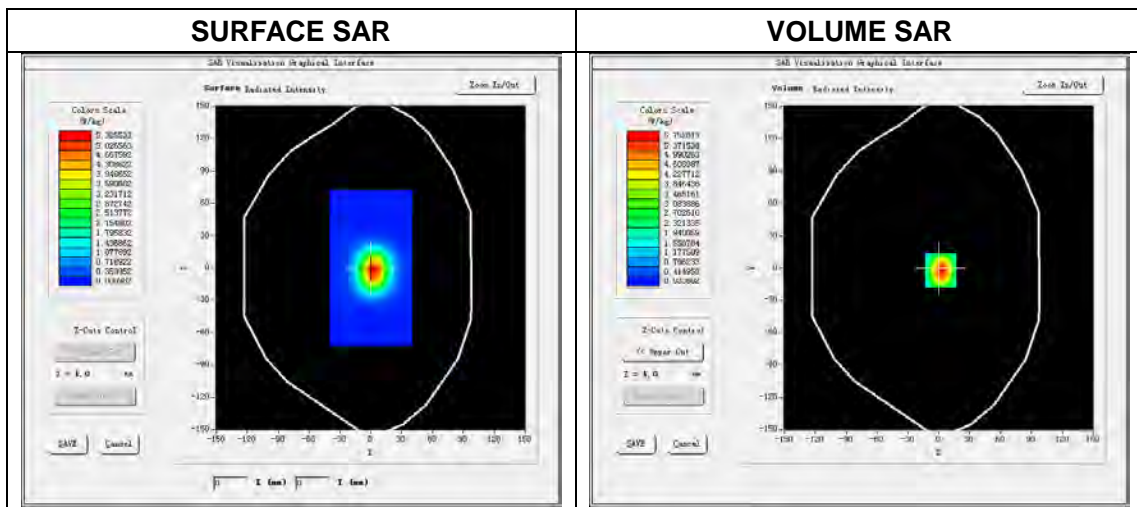

Maximum location: X=0.00, Y=0.00

SAR Peak: 43.26 W/kg

SAR 10g (W/Kg)	5.615362
SAR 1g (W/Kg)	15.762167

### Z Axis Scan

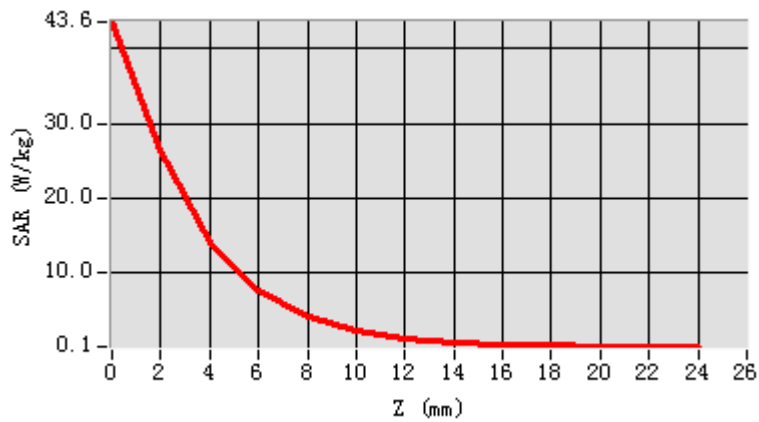

3D screen shot

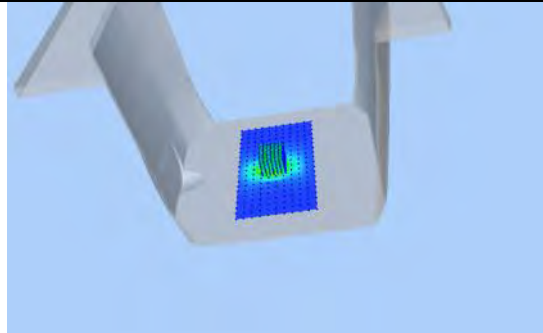

Hot spot position

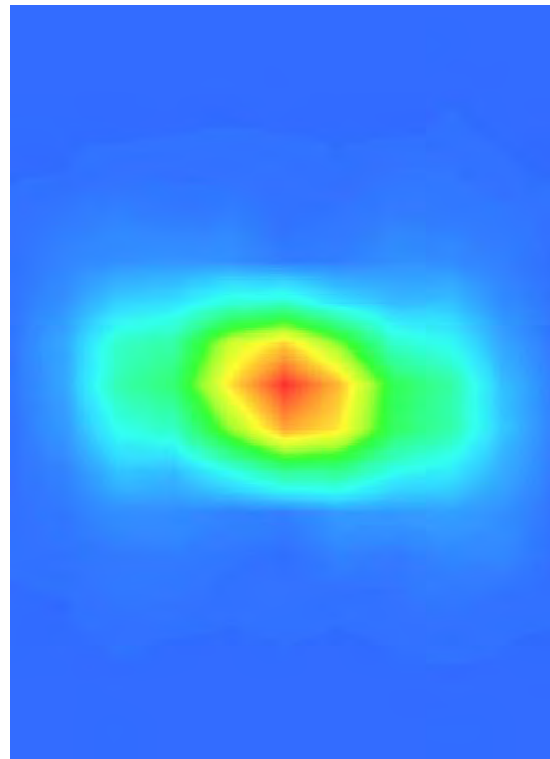

# System Performance Check Data (5600 MHz Body )

Type: Phone measurement (Complete)  
 E-Field Probe: SN 34/15 SSE2 EPGO265  
 Area scan resolution: dx=8mm,dy=8mm  
 Zoom scan resolution: dx=4mm, dy=4mm, dz=2mm  
 Date of measurement: 2016.03.03  
 Measurement duration: 29 minutes 32 seconds

## Experimental conditions.

<b>Phantom File</b>	surf_sam_plan.txt
<b>Phantom</b>	Validation plane
<b>Band</b>	5600 MHz
<b>Signal</b>	CW
<b>Frequency (MHz)</b>	5600.000000
<b>Relative permittivity (real part)</b>	48.041782
<b>Conductivity (S/m)</b>	5.932687
<b>Power drift (%)</b>	2.130000
<b>Ambient Temperature:</b>	21.5°C
<b>Liquid Temperature:</b>	21.0°C
<b>ConvF:</b>	2.15
<b>Crest factor:</b>	1:1

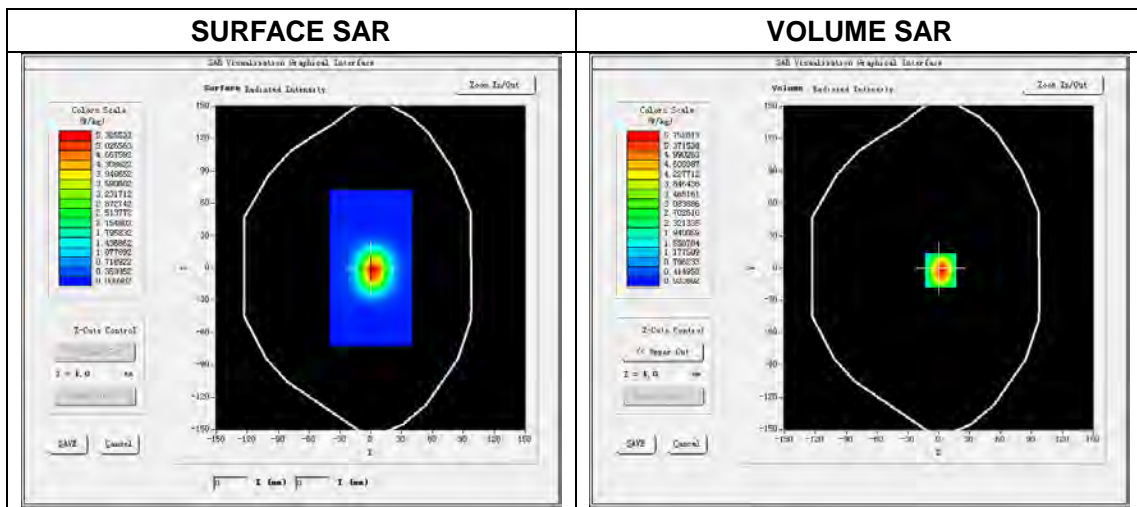

Maximum location: X=0.00, Y=0.00

SAR Peak: 52.10W/kg

SAR 10g (W/Kg)	5.645281
SAR 1g (W/Kg)	15.812583

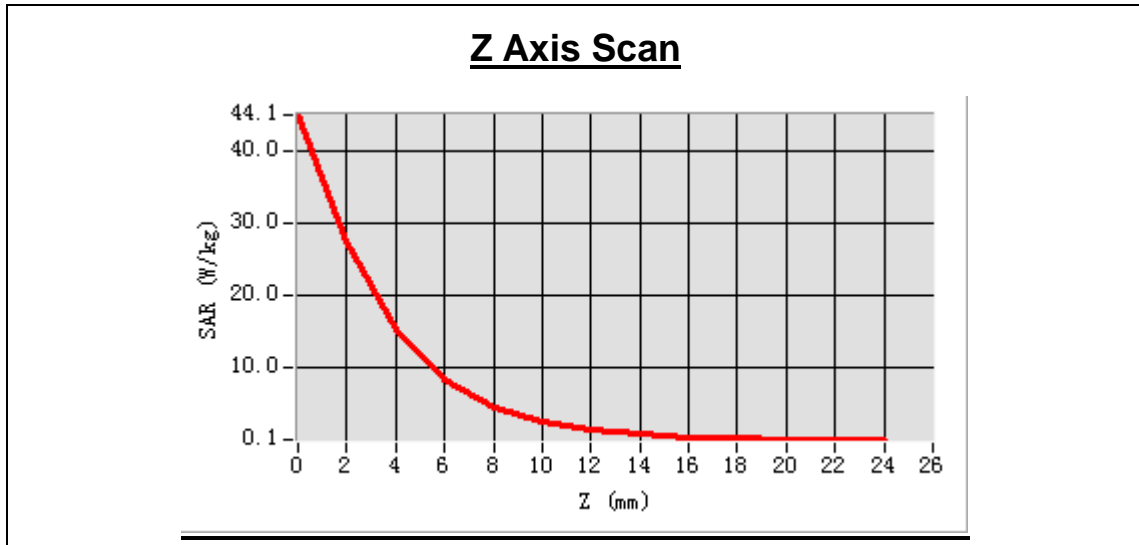

3D screen shot	Hot spot position

# System Performance Check Data (5800 MHz Body )

Type: Phone measurement (Complete)  
 E-Field Probe: SN 34/15 SSE2 EPGO265  
 Area scan resolution: dx=8mm,dy=8mm  
 Zoom scan resolution: dx=4mm, dy=4mm, dz=2mm  
 Date of measurement: 2016.03.03  
 Measurement duration: 29 minutes 32 seconds

## Experimental conditions.

<b>Phantom File</b>	surf_sam_plan.txt
<b>Phantom</b>	Validation plane
<b>Band</b>	5800 MHz
<b>Signal</b>	CW
<b>Frequency (MHz)</b>	5800.000000
<b>Relative permittivity (real part)</b>	47.135215
<b>Conductivity (S/m)</b>	6.071259
<b>Power drift (%)</b>	2.130000
<b>Ambient Temperature:</b>	21.5°C
<b>Liquid Temperature:</b>	21.0°C
<b>ConvF:</b>	1.93
<b>Crest factor:</b>	1:1

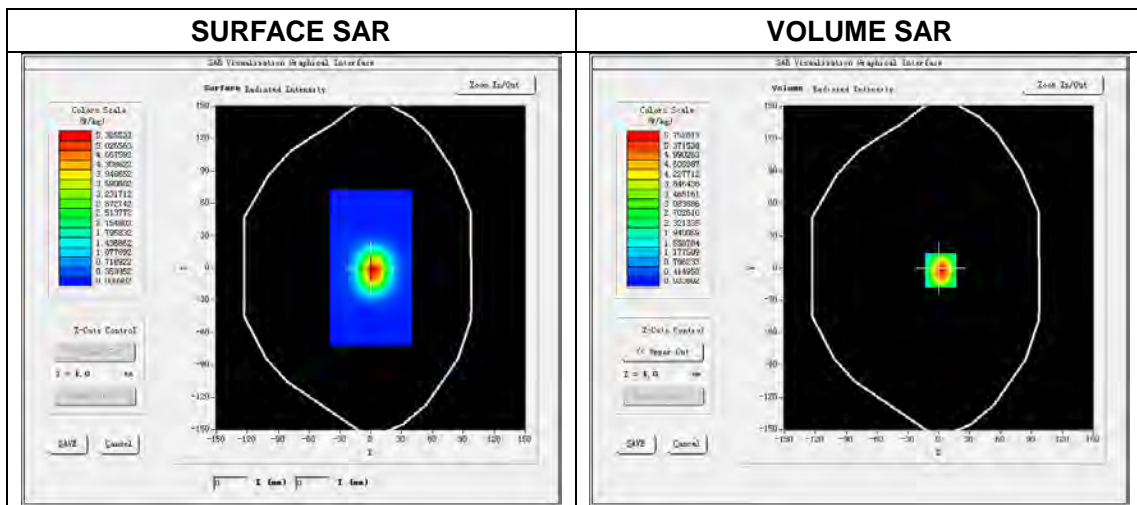



Maximum location: X=0.00, Y=0.00

SAR Peak: 50.10W/kg

SAR 10g (W/Kg)	5.836267
SAR 1g (W/Kg)	16.942574

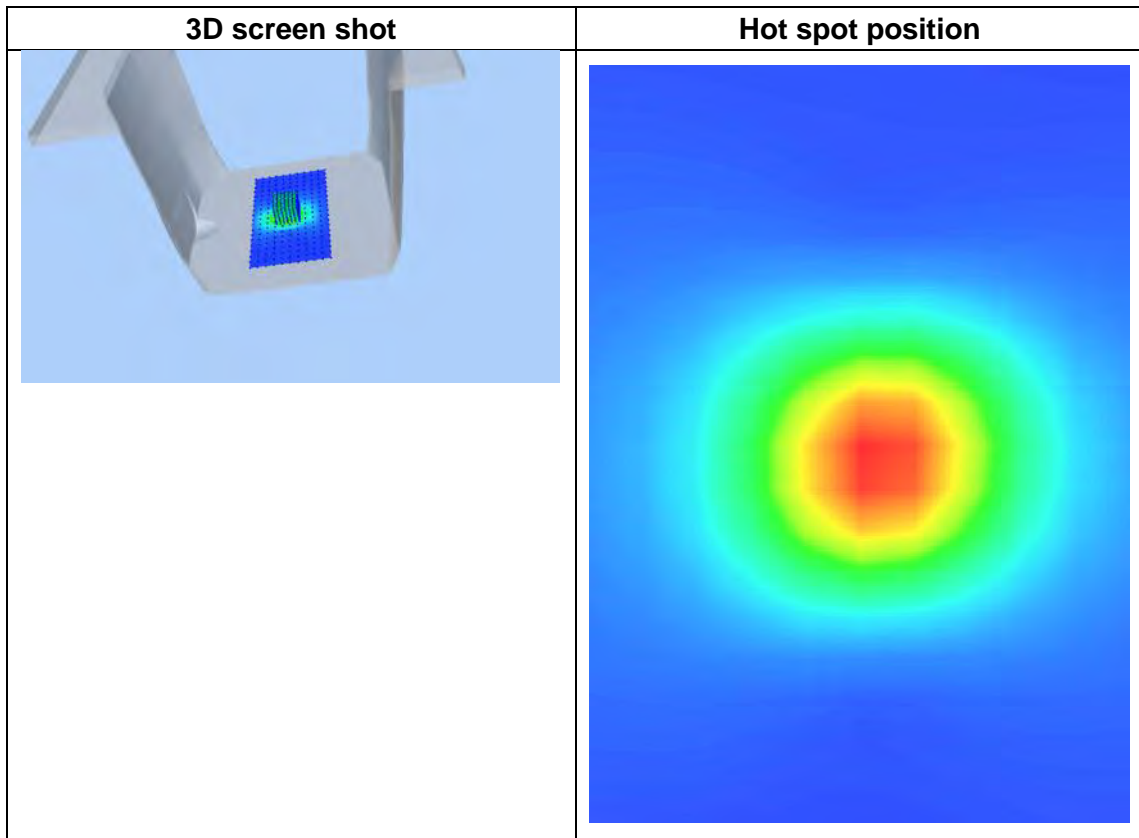
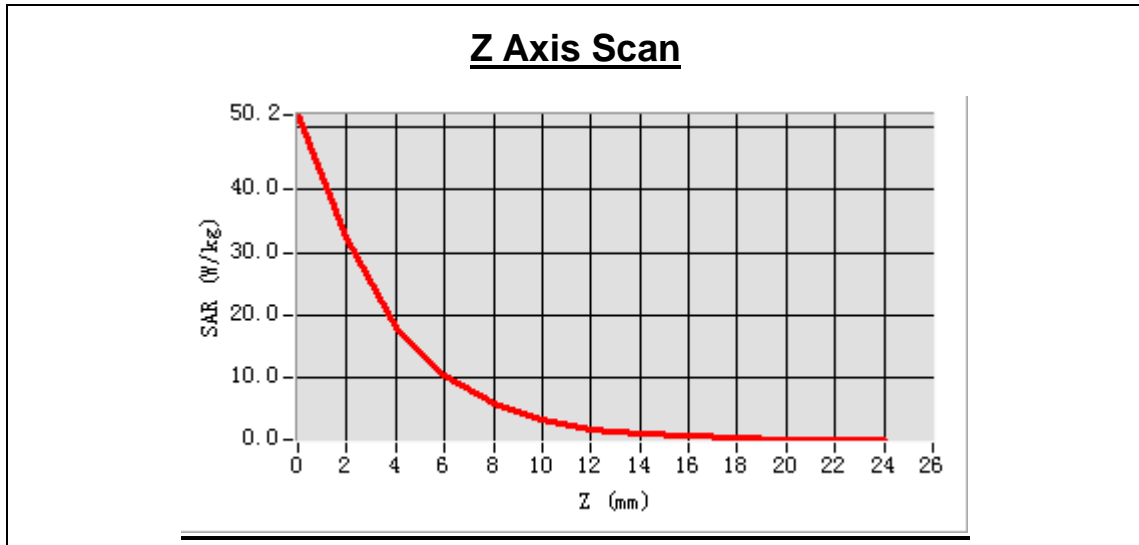

--END OF REPORT--