



Welcome to a Smarter Life

Nanoleaf Canvas

SETUP VIDEOS ONLINE:

nanoleaf.me/mycanvas

2.4GHz Radio: 2402MHz-2480MHz radio

2.4GHz WIFI : 2412MHz-2462MHz b/g/n

IMPORTANT!



Save your
pairing code:

Hardware Setup

We recommend powering on and trying different layouts on a table or other flat surface to test your hardware before mounting your Canvas Light Squares to the wall. Download the Nanoleaf App to access companion tools, like the Layout Assistant, to help plan and preview your design.

We designed the Nanoleaf Canvas to be controlled with any of several methods: the Nanoleaf App, third party voice control and apps, or with the Control Square and touch gestures on any Light Square. WiFi access is optional, as the Nanoleaf Canvas comes with hundreds of Scenes pre-loaded on your Control Square.

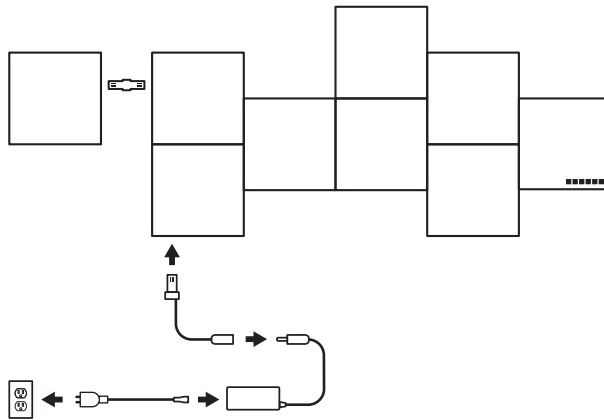



IMPORTANT INSTALLATION TIPS

Read this BEFORE installation to keep Squares from falling off the wall.

1



Clean wall/surface to be free of dust and moisture.

2

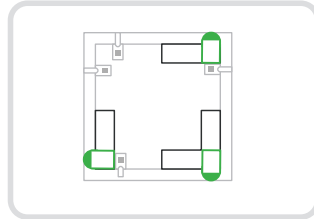

Use 3 pieces of tape per Light Square.

3



When mounting the Light Squares, apply pressure to the Squares for 30 seconds so the tape will cling to the wall firmly.

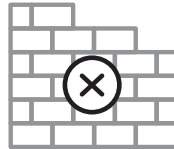

NOTE:

The included tape is NOT suitable for brick walls, wall paper and other uneven/bumpy surfaces.

Your Control Square Explained

The Control Square is the brain of the Nanoleaf Canvas system. The touch control buttons on the Control Square provide convenient shortcuts to common commands. The Control Square can draw power from any Light Square in the layout or from a power supply directly.

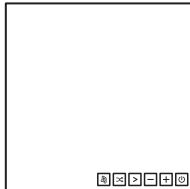

Next Rhythm Scene: Cycles through saved Rhythm Scenes



Shuffle Scenes: The Control Square comes with hundreds of Scenes, and you can use the shuffle button to cycle through them. To add a Scene to your favorites list for future use, see the instructions below. Hold the Shuffle button to return to a previous random Scene.



Next Color Scene: Cycles through your list of saved Color Scenes



Dim Brightness



Increase Brightness



Power ON/OFF

LED Statuses

There are 6 LED indicator lights on the Control Square, one behind each of the control buttons. These LEDs serve as feedback for various actions, and are also used to communicate device status.

LED Flashing Sequence	Status
Power button LED on (White)	Device is ready to be configured on WiFi
Power button LED flashing white (4s on, 4s off)	Cannot connect to configured WiFi Network
Rhythm button LED on	Rhythm Scene is active

Nanoleaf Smarter Series App

Download the App



Nanoleaf Smarter Series App

Open the Nanoleaf App when you are ready to pair to your Nanoleaf Canvas. The in-app tutorial will walk you through the basics of how to set up your Light Squares.

Available on



Pairing your Canvas

On iOS, you must configure your Canvas on WiFi within 15 minutes of connecting it to power. This setup mode is indicated by the Power LED . If the device has been on for more than 15 minutes and the Power LED has turned off, you can simply disconnect the Control Square from power to reset the timer. If the Power LED still does not come on, try the troubleshooting methods in .

Layout Assistant

The Layout Assistant is a key component of the setup process. This feature is designed to allow you to create shapes in the app, and then preview them in any room using your smartphone's camera.

iOS App

Open App > More (on the lower menu bar) > Layout Assistant

Android App

Open App > Side Menu (swipe left or tap the hamburger menu icon at the top left) > Layout Assistant



AR Layout Assistant

Click on this button to activate Augmented Reality mode and preview your design using your smartphone's camera. **Android users:** Use the QR code as a target for Augmented Reality mode. This is included in the Welcome Booklet that came in the box.

Already have our Remote ?

Pairing Your Remote

iOS

To pair with the Nanoleaf Remote in iOS, make sure the Remote lights up when you pick it up and rotate it. Open the Nanoleaf Smarter Series App and follow the in-app prompts.

Android

To pair with Android, you will need the Canvas. Make sure the Remote lights up when you pick it up and rotate it. Press the Rhythm button on Canvas until it starts flashing. Hold the Remote close to the Canvas. When pairing completes, the Canvas will flash green.

Pairing One Remote to Multiple Canvas You can pair the Remote to multiple Nanoleaf Canvas using the same pairing method mentioned under Android Users.

How to Program Your Remote

Open the Nanoleaf Smarter Series App, and go to the Remote section to start configuring different sides to different scenes.

How to Use Your Remote

To activate a programmed side of the Remote, rotate that side to the top.

1

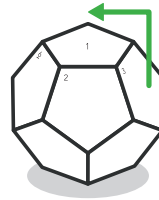

2





Online User Guide



nanoleaf.me/mycanvas

We've prepared a detailed User Guide page complete with setup videos, installation guides and troubleshooting solutions online for you, please familiarize yourself with it before you start installing your Nanoleaf Canvas to avoid common issues during setup.



Still Need Help?

nanoleaf.me/support

Design Inspirations

More design inspirations available in the Online User Guide.

9 Light Squares

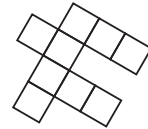
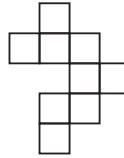
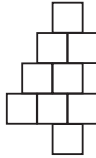

EN RF Exposure Warning

This equipment must be installed and operated in accordance with provide instruction and the antenna used for this transmitter must be installed to provide a separation distance of at least 20cm from all persons and must not be co-located or operation in conjunction with any other antenna or transmitter. End-users and installers must be provided with antenna installation instructions and transmitter operating conditions for satisfying RF exposure compliance.

FR Avertissement d'exposition RF

Cet équipement doit être installé et utilisé conformément aux instructions fournies et l'antenne utilisée pour cet émetteur doit être installée de manière à assurer une distance de séparation d'au moins 20 cm de toute personne et ne doit pas être situé au même endroit ou en liaison avec toute autre antenne ou émetteur. Les utilisateurs finaux et les installateurs doivent être informés des instructions d'installation de l'antenne et des conditions de fonctionnement de l'émetteur afin de satisfaire à la conformité d'exposition RF.

Layout Design Tool: Use the Layout Assistant in your Nanoleaf App.



Open App ► More ► Layout Assistant



Open App ► Swipe left for side menu ► Layout Assistant

Warnings and Cautions

EN NANOLEAF CANVAS IS NOT DESIGNED FOR USE IN:

Enclosed locations that limit the flow of air and/or trap excessive amounts of heat. Emergency exits or emergency lights. Conjunction with 3rd party sensors/timing devices that are not approved by Nanoleaf®. Places where there is a risk of electric shock. Outdoor areas. Wet or damp conditions. Excessively hot environments (e.g. close to ovens, radiators, heaters, etc.) Regions or countries other than that in which the product was intended for.

WHEN USING NANOLEAF CANVAS

Do not open device, as this will void the warranty. Do not allow small children to operate this device unsupervised. This device contains small parts that may be a choking hazard to small children. Do not clean the device when it is on and or connected to power. Clean the light squares with a soft dry cloth, do not use cleaning agents. Do not bend the light squares with the linker still attached. Do not attach the light squares together with anything other than its original linkers. Do not puncture the light squares with any nails or screws during installation. Do not attach the light squares to a ceiling without the Nanoleaf Canvas Screw Mounting Kit to secure the light squares from falling. Mounting Tape will not hold the Light Squares to a ceiling. Do not attach the Light Squares to the floor where it may get stepped on. Do not place the Light Squares in water, or expose the Light Squares to water. Do not use mounting tape to attach panels to dusty, moist, wallpapered or uneven surfaces such as brick, unfinished wood, or rough concrete.

Avertissements et Mises en garde

FR NANOLEAF CANVAS N'EST PAS CONÇU POUR :

Des emplacements clos qui limitent les flux d'air et/ou piègent des quantités excessives de chaleur. Des issues de secours ou éclairages d'urgence. Une utilisation avec des capteurs/timers d'autres marques non approuvées par Nanoleaf®. Les lieux où il y a un risque d'électrocution. Les espaces extérieurs. Des environnements humides. Des environnements excessivement chauds (par exemple à proximité de fours, radiateurs, etc...) Les régions ou pays autres que ceux dans lesquels le produit est destiné.

LORSQUE VOUS UTILISEZ VOTRE NANOLEAF CANVAS :

N'ouvrez pas l'appareil, car cela annulerait la garantie. Ne laissez pas les jeunes enfants utiliser cet appareil sans surveillance. Cet appareil contient de petites pièces pouvant présenter un risque d'étouffement pour les jeunes enfants. Ne nettoyez pas l'appareil lorsqu'il est allumé et ou connecté à l'alimentation. Nettoyez les panneaux avec un chiffon doux et sec, n'utilisez pas de produits nettoyants. Ne pliez pas les panneaux avec les connecteurs encore attachés. Ne connectez pas les panneaux avec autre chose que les connecteurs fournis par Nanoleaf. Ne percez pas les panneaux avec des clous ou des vis lors de l'installation. Ne fixez pas les panneaux au plafond sans utiliser le kit de montage Nanoleaf Canvas pour les sécuriser. L'adhésif double-face fourni n'est pas conçu pour maintenir les panneaux au plafond. N'installez pas les panneaux au sol où ils pourraient être piétinés. N'exposez pas les panneaux à l'eau, ne les immergez pas dans l'eau. N'utilisez pas l'adhésif double-face pour fixer les panneaux sur des surfaces poussiéreuses, humides, tapissées ou inégales telles que la brique, le bois non fini ou le béton brut.

Warnungen & Vorsichtshinweise

DE NANOLEAF CANVAS WURDE NICHT ENTWORFEN FÜR:

Geschlossenen Räume, die den Luftstrom begrenzen und/oder übermäßige Mengen von Hitze ausgesetzt sind. Notausgänge oder Notleuchten. Die Verbindung mit Drittanbieter-Sensoren / -timing Geräten, die nicht von Nanoleaf® zugelassen sind. Orte an denen die Gefahr eines elektrischen Schlages besteht. Außenbereiche. Nasse oder feuchte Bedingungen. Übermäßig warme Umgebungen (z. B. in der Nähe von Öfen, Kaminen, Heizstrahlern, etc.) Regionen oder Länder, in denen das Produkt nicht vorgesehen war.

WENN SIE NANOLEAF CANVAS VERWENDEN

Öffnen Sie das Gerät nicht, da dadurch die Garantie erlischt. Lassen Sie kleine Kinder dieses Gerät nicht unbeaufsichtigt

utilizar. Este dispositivo contiene piezas pequeñas que pueden ser un peligro de asfixia. No permita que los niños pequeños operen este dispositivo sin supervisión. Este dispositivo contiene partes de pequeñas dimensiones que pueden ser un peligro de asfixia. No limpie el dispositivo cuando está encendido o conectado a la corriente. Limpie el exterior con un paño suave y seco, no utilice agentes de limpieza. No doble los paneles de luz con el enchufador todavía conectado. No conecte los paneles de luz con otros elementos que no sean sus conectores originales. No perfora los paneles de luz con clavos o tornillos durante la instalación. No coloque los paneles de luz en el techo sin el kit de montaje de tornillos Nanoleaf Canvas para evitar que los paneles del techo se caigan. La cinta adhesiva de montaje no soportará el peso los paneles de luz situados en el techo. No coloque los paneles de luz en el suelo donde puedan pisarse. No coloque los paneles de luz en el agua ni los exponga al agua. No use cinta adhesiva de montaje para unir los paneles a superficies polvorosas, húmedas, empapeladas o irregulares, como ladrillos, madera sin pulir y tratar o concreto áspero.

Avvertenze e precauzioni

IT

NANOLEAF CANVAS NON È PROGETTATO PER L'USO IN:

Luoghi chiusi che limitino il flusso d'aria e/o contengano una quantità eccessiva di calore. Uscite di emergenza o luci di emergenza. La combinazione con sensori di terze parti / dispositivi di temporizzazione non approvati da Nanoleaf®. Luoghi in cui vi sia il rischio di scosse elettriche. Aree esterne. In presenza di acqua o umidità. Ambienti eccessivamente caldi (es. vicino a forni, radiatori, termosifoni, ecc.) Regioni o paesi diversi da quello a cui era destinato il prodotto.

QUANDO SI UTILIZZA NANOLEAF CANVAS

Non smontare il dispositivo, poiché questa azione annullerebbe la garanzia. Non consentire a bambini piccoli di utilizzare questo dispositivo senza supervisione. Questo dispositivo contiene parti di piccole dimensioni che possono costituire rischio di soffocamento per i bambini piccoli. Non pulire il dispositivo quando è acceso o collegato all'alimentazione. Pulire i pannelli con un panno morbido e asciutto, non utilizzare detersivi. Non piegare i pannelli con il connettore ancora attaccato. Non collegare i pannelli con altro che i suoi connettori di pannello originali. Non forare i pannelli con chiodi o viti durante l'installazione. Non fissare i pannelli luminosi al soffitto senza il kit di montaggio a vite di Nanoleaf Canvas per evitare che i pannelli luminosi cadano. Il nastro di montaggio non è in grado di sostenere i pannelli luminosi al soffitto. Non posizionare i pannelli luminosi sul pavimento dove potrebbero essere calpestati. Non posizionare i pannelli luminosi in acqua o esporli all'acqua. Non utilizzare il nastro di montaggio per fissare pannelli a superfici polverose, umide, tappezzate o irregolari come mattoni, legno non trattato o cemento grezzo.

Advertencias y precauciones

ES

NANOLEAF CANVAS NO ESTÁ DISEÑADO PARA SU USO EN:

Lugares cerrados que limitan el flujo de aire o almacenan un calor excesivo. Salidas de emergencia o luces de emergencia. Enlazados con sensores / temporizadores de terceros que no están aprobados por Nanoleaf®. Lugares donde existe un riesgo de descarga eléctrica. Áreas al aire libre. Condiciones húmedas o mojadas. Ambientes excesivamente caliente (p. ej. cercanas a hornos, radiadores, calefactores, etc.) Regiones o países distintos a los que se destinó el producto.

CUANDO SE UTILIZA EL CONTROL REMOTO NANOLEAF

No desmonte el dispositivo, ya que esto anulará la garantía. No permita que los niños pequeños operen este dispositivo sin supervisión. Este dispositivo contiene piezas pequeñas que pueden ser un peligro de asfixia. No limpie el dispositivo cuando está encendido o conectado a la corriente. Limpie el exterior con un paño suave y seco, no utilice agentes de limpieza. No doble los paneles de luz con el enchufador todavía conectado. No conecte los paneles de luz con otros elementos que no sean sus conectores originales. No perfora los paneles de luz con clavos o tornillos durante la instalación. No coloque los paneles de luz en el techo sin el kit de montaje de tornillos Nanoleaf Canvas para evitar que los paneles del techo se caigan. La cinta adhesiva de montaje no soportará el peso los paneles de luz situados en el techo. No coloque los paneles de luz en el suelo donde puedan pisarse. No coloque los paneles de luz en el agua ni los exponga al agua. No use cinta adhesiva de montaje para unir los paneles a superficies polvorosas, húmedas, empapeladas o irregulares, como ladrillos, madera sin pulir y tratar o concreto áspero.

Avisos e Precauções

PT

NANOLEAF CANVAS NÃO SE DESTINA A SER USADO EM:

Locais fechados onde o fluxo de ar seja limitado e/ou que armazenem quantidade excessivas de calor. Saídas de emergência ou luzes de emergência. Conjuntamente com sensores/dispositivos de temporização de terceiros que não sejam aprovados pela Nanoleaf®. Locais onde exista risco de choque elétrico. Áreas no exterior. Condições molhadas ou húmidas. Ambientes excessivamente quentes (por exemplo, perto de fornos, radiadores, aquecedores, etc.) Regiões ou países que não aqueles(as) aos(às) quais se destina o produto.

AO UTILIZAR O NANOLEAF CANVAS

Não abra o dispositivo, pois isso anulará a garantia. Não permita que crianças pequenas utilizem o dispositivo sem supervisão. Este dispositivo contém peças pequenas, que podem constituir um perigo de asfixia para crianças pequenas. Não limpe o dispositivo quando estiver ligado e/ou ligado à corrente elétrica. Limpe os quadrados iluminados com um pano macio e seco, sem usar agentes de limpeza. Não dobre os quadrados iluminados com o conector ainda colocado. Não conecte os quadrados iluminados com algo que não os seus conectores originais. Não fure os quadrados iluminados com quaisquer pregos ou parafusos durante a instalação. Não prenda os quadrados iluminados ao teto sem um Kit de Montagem com Parafusos do Nanoleaf Canvas, para impedir que os quadrados iluminados caiam. A Fita Adesiva de Montagem não conseguirá prender os Quadrados Iluminados a um teto. Não instale os Quadrados Iluminados no chão em locais onde possam ser pisados. Não coloque os Quadrados Iluminados na água, nem os exponha à água. Não utilize a fita adesiva de montagem para anexar os painéis a superfícies com pó, humidade, papel de parede ou que sejam irregulares, tais como tijolos, madeira não acabada ou betão em bruto.



FR Guide De L'utilisateur En Ligne :

Nous avons préparé en ligne une page Guide de l'utilisateur avec des vidéos de configuration, des guides d'installation et des solutions de dépannage. Veuillez vous reporter à cette page avant de commencer à installer votre Nanoleaf Canvas, afin d'éviter les problèmes les plus courants lors de l'installation.

DE Online-Benutzerhandbuch:

Wir haben eine ausführliche Handbuch-Seite mit Installationsvideos, Anleitungen und Lösungen zur Fehlerbehebung online für Sie vorbereitet. Um häufige Probleme bei der Einrichtung zu vermeiden, machen Sie sich bitte vor der Montage der Nanoleaf Canvas damit vertraut.

IT Guida Utente Online:

Abbiamo creato una pagina dettagliata della Guida per l'utente completa di video di installazione, guide di installazione e soluzioni per la risoluzione dei problemi online, prendi confidenza con questa prima di iniziare l'installazione di Nanoleaf Canvas per evitare problemi comuni durante l'installazione.

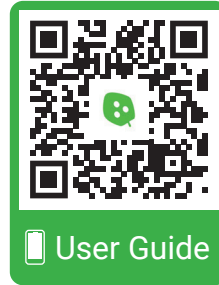

nanoleaf.me/mycanvas

ES Manual De Usuario Online:

Hemos preparado una página detallada en el Manual de Usuario con videos de instalación, guías de instalación y solución de problemas en línea, por favor familiarícese con ella antes de comenzar a instalar Nanoleaf Canvas para evitar problemas comunes durante la instalación.

PT Guia Do Utilizador Online:

Preparámos uma página com um Guia do Utilizador detalhado, que coloca videos de configuração, guias de instalação e soluções de resolução de problemas ao seu dispor online. Familiarize-se com este guia antes de iniciar a instalação do seu Nanoleaf Canvas, para evitar problemas comuns durante a configuração.



FR Besoin D'une Aide Supplémentaire ?

DE Brauchen Sie Trotzdem Noch Hilfe?

IT Ancora Bisogno Di Aiuto?

ES ¿Aún Necesitas Ayuda?

PT Ainda Precisa De Ajuda?

nanoleaf.me/support



FR

IMPORTANT: COMMENT MONTER CORRECTEMENT LES CANVAS

En suivant ces instructions simples, vous éviterez que vos Nanoleaf Canvas ne tombent

DE

WICHTIG: BRINGEN SIE DIE CANVAS LICHTQUADRATE RICHTIG AN

Wenn Sie diese einfachen Anweisungen befolgen, fallen Ihre Nanoleaf Canvas Paneele nicht herunter

IT

IMPORTANTE: MONTARE CORRETTAMENTE I QUADRATI CANVAS

Seguendo queste semplici istruzioni ti aiuteremo a evitare che i tuoi quadrati Nanoleaf Canvas cadano

ES

¡IMPORTANT! MONTE CORRECTAMENTE LOS PANELES DE NANOLEAF CANVAS

Para evitar que los paneles de Nanoleaf Canvas caigan siga estas sencillas instrucciones

PT

IMPORTANTE: MONTE DEVIDAMENTE OS QUADRADOS DO CANVAS

Seguir estas instruções simples ajudará a impedir que os seus quadrados do Nanoleaf Canvas caiam

1



FR

Nettoyez le mur / la surface pour enlever la poussière et l'humidité.

DE

Wand/Oberfläche von Staub und Feuchtigkeit befreien.

IT

Pulire la parete / la superficie in modo che risulti priva di polvere e umidità.

ES

Limpie la pared / superficie para que esté libre de polvo y humedad.

PT

Limpe a parede/superfície, para que não tenha pó e humidade.

2

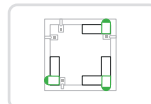

FR

Utilisez 3 bandes adhésives par carré lumineux.

DE

Verwenden Sie 3 Stück Klebeband pro Light Square.

IT

Usa 3 pezzi di nastro per quadrati Canvas.

ES

Use 3 pedazos de cinta por panelo Canvas.

PT

Utilize 3 pedaços de fita adesiva por Quadrado Iluminado.

3



FR

Lors de l'installation, appliquez une pression sur chaque carré pendant 30 secondes afin que l'adhésif adhère fermement au mur.

DE

Bei der Anbringung der Lichtquadrat sollten die Panels 30 Sekunden fest gedrückt werden, sodass sie fest an der Wand haften.

IT

Durante il montaggio dei pannelli, applicare una pressione sui pannelli per 30 secondi in modo che il nastro aderisca saldamente al muro.

ES

Al montar los paneles, aplique presión en los laterales de los paneles durante 30 segundos para que la cinta se adhiera firmemente a la pared.

PT

Ao montar os Quadrados Iluminados, faça pressão durante 30 segundos, para que a fita adesiva fique firmemente colada à parede.

FR

REMARQUE: l'adhésif fourni n'est PAS adapté pour les murs en briques, le papier peint et autres surfaces inégales.

DE

HINWEIS: Das mitgelieferte Klebeband eignet sich NICHT für Ziegelwände, Tapeten und andere unebene Oberflächen.

IT

NOTA: il nastro incluso NON è ADATTO per pareti in mattoni, carta da parati e altre superfici irregolari / sconnesse.

ES

NOTA: La cinta incluida NO ES ADECUADA para paredes de ladrillo, papel pintado y otras superficies desiguales / rugosas.

PT

NOTA: a fita adesiva incluída NÃO é adequada para usar em paredes de tijolo, papel de parede e outras superfícies irregulares/assimétricas.



FR Idées de design

DE Design-Inspirationen

IT Ispirazioni di design

ES Propuestas de diseños

PT Inspirações de Design

9 Light Squares

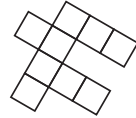
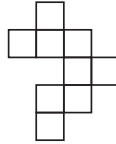
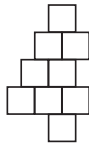

FR Si vous manquez d'inspiration, faites appel à l'assistant de mise en forme dans votre application Nanoleaf !

DE Verwenden Sie den Layout-Assistenten in Ihrer Nanoleaf-App für weitere Design-Inspirationen!

IT Per ulteriori ispirazioni di design, usa l'Assistente di layout nella tua app Nanoleaf!

ES ¡Para obtener más propuestas de diseño, utilice el Asistente de diseño de la aplicación Nanoleaf!

PT Para mais inspirações de design, utilize o Assistente de Esquema na sua Aplicação Nanoleaf!



Open App ► More ► Layout Assistant



Open App ► Swipe left for side menu ► Layout Assistant

LEAVE A REVIEW

We value your feedback. Share your thoughts with the world on the Nanoleaf Shop. Visit shop.nanoleaf.me and click on the Nanoleaf Canvas Product to leave a review.

Thanks for supporting us. You brighten our day like Nanoleaf brightens the world!



nanoleaf.me

Share your lighting masterpiece with [#mynanoleaf](https://twitter.com/nanoleaf) and tag [@nanoleaf](https://twitter.com/nanoleaf) to get featured!



[@Nanoleaf](https://twitter.com/nanoleaf)



[/thenanoleaf](https://www.facebook.com/nanoleaf)

Nanoleaf Canada
162 John St. Toronto,
ON M5V 2E5, Canada

Nanoleaf Europe SAS
11 Bis Rue Telles de La Poterie,
92130 Issy-les-Moulineaux, France

NanoGrid Limited
ROOM 1405, 135 BONHAM STRAND TRADE CENTRE,
135 BONHAM STRAND, SHEUNG WAN, HONG KONG

ISED/C warning

This device complies with Innovation, Science and Economic Development Canada Compliance licence/exempt RSS standard(s). Operation is subject to the following two conditions: (1) this device may not cause interference, and (2) this device must accept any interference, including interference that may cause undesired operation of the device.

Le présent appareil est conforme aux CNR d'Innovation, Sciences et Développement économique Canada applicables aux appareils radio exempts de licence. L'exploitation est autorisée aux deux conditions suivantes: (1) l'appareil ne doit pas produire de brouillage, et (2) l'utilisateur de l'appareil doit accepter tout brouillage radioélectrique subi, même si le brouillage est susceptible d'en compromettre le fonctionnement.

Any Changes or modifications not expressly approved by the party responsible for compliance could void the user's authority to operate the equipment. This device complies with part 15 of the FCC Rules. Operation is subject to the following two conditions:

(1) This device may not cause harmful interference, and (2) this device must accept any interference received, including interference that may cause undesired operation.

Note: This equipment has been tested and found to comply with the limits for a Class B digital device, pursuant to part 15 of the FCC Rules. These limits are designed to provide reasonable protection against harmful interference in a residential installation. This equipment generates, uses and can radiate radio frequency energy and, if not installed and used in accordance with the instructions, may cause harmful interference to radio communications. However, there is no guarantee that interference will not occur in a particular installation. If this equipment does cause harmful interference to radio or television reception, which can be determined by turning the equipment off and on, the user is encouraged to try to correct the interference by one or more of the following measures:

- Reorient or relocate the receiving antenna.
- Increase the separation between the equipment and receiver.
- Connect the equipment into an outlet on a circuit different from that to which the receiver is connected.
- Consult the dealer or an experienced radio/TV technician for help.