

User Manual

## **CHANGE THE DEFAULT PASSWORD**

Default Network Camera Account :  
Username: abc Password: 123



*The default password (123) for the abc account is for first-time log-in purposes only. You should change this default password to better protect against security risks, such as the unauthorized access by others to the product that may prevent the product from functioning properly and/or lead to other undesirable consequences.*

*For your privacy, we strongly recommend changing the password to something of your own choosing (using a minimum of 8 characters, including upper case letters, lower case letters, numbers, and special characters) in order to increase the security of your product.*

*Proper configuration of all passwords and other security settings is the responsibility of the installer and/or end-user.*

### *FCC Certification Requirements*

*Caution: Any changes or modifications in construction of this device which are not expressly approved by the party responsible for compliance could void the user's authority to operate the equipment.*

*This device complies with part 15 of the FCC Rules. Operation is subject to the following two conditions: (1) This device may not cause harmful interference, and (2) This device must accept any interference received, including interference that may cause undesired operation.*

*The manufacturer is not responsible for any radio or TV interference caused by unauthorized modifications to this equipment. Such modifications could void the user's authority to operate the equipment.*

*This equipment has been tested and found to comply with the limits for a Class B digital device, pursuant to Part 15 of the FCC Rules. These limits are designed to provide reasonable protection against harmful interference in a residential installation. This equipment generates, uses and can radiate radio frequency energy and, if not installed and used in accordance with the instructions, may cause harmful interference to radio communications. However, there is no guarantee that interference will not occur in a particular installation. If this equipment does cause harmful interference to radio or television reception, which can be determined by turning the equipment off and on, the user is encouraged to try to correct the interference by one or more of the following measures:*

- Reorient or relocate the receiving antenna.*
- Increase the separation between the equipment and receiver.*
- Connect the equipment into an outlet on a circuit different from that to which the receiver is connected.*
- Consult the dealer or an experienced radio/TV technician for help.*

*The antenna(s) used for this transmitter must be installed to provide a separation distance of at least 20 cm from all persons.*

# Contents

1.		
Introduction .....		3
1.1 Appearance and Interface .....		3
1.2 Specification .....		3
Installation.....		4
2.1 Ceiling Mounting.....		4
Network Connection .....		5
3.1 Wireless connection.....		5
3.2 Wired Connection .....		5
Preparation on Smart Phone (iOS, Android) .....		6
4.1 Get NVSIP APP .....		6
4.2 Register NVSIP Account .....		6
4.3 Power-on the Device .....		6
Add HD Cloud Camera on Phone .....		7
5.1 How to Choose Device Adding Methods.....		7
5.2 Add by Sound Wave .....		7
5.3 Add Wi-Fi Device on iPhone.....		9
5.4 Add Wi-Fi Device on Android.....		12
5.5 Add by Device ID .....		13
5.6 Scan devices in LAN.....		14

# 1

## Introduction

### 1.1 Appearance and Interface

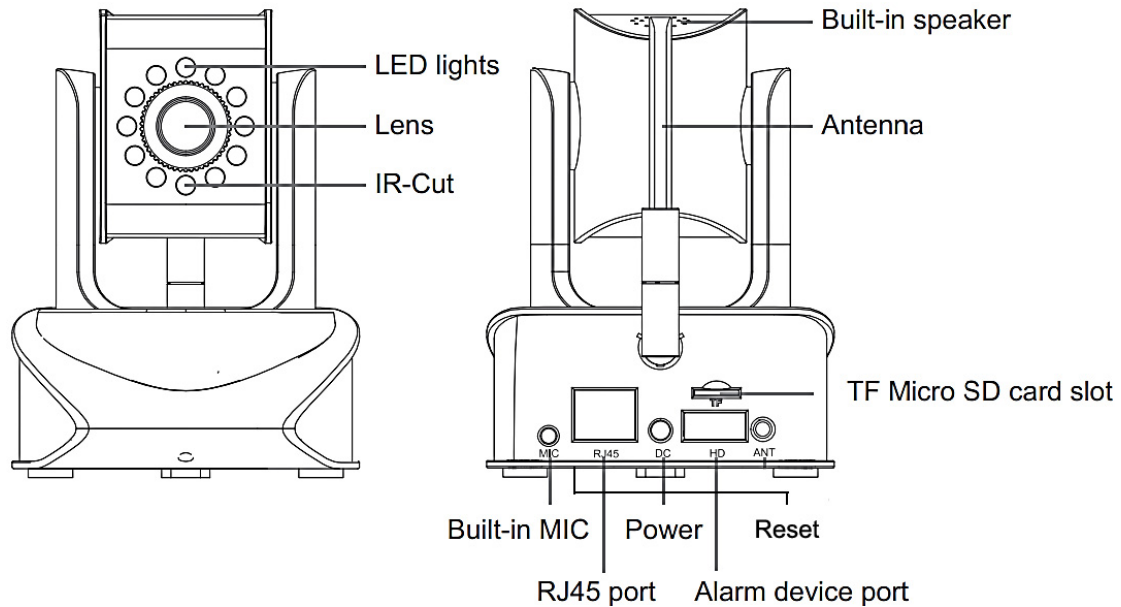

### 1.2 Specification

Image Sensor	1/4" CMOS
Resolution	1280×720
Pixel	1.0MP
Frame Rate	25fps
View Angle	71°
Focus	3.6mm Fixed
Local Storage	64G
Infrared Lamp	10 LED Lamps
IR distance (m)	10m
Best distance (m)	8m
Temperature	-20°C ~ 55°C
Humidity	10% ~ 90%
Power Supply	DC 5V/adaptor AC 120V
Power	≅ 3.2W
Material	White ABS+PC
Size(W×H×D)(mm)	95×123×122
Weight(g)	300

## 2 Installation

### 2.1 Ceiling Mounting

**Before you start:**

This camera can be installed to wall/ceiling or fixed on desktop. Ceiling mounting is taken as an example in this section; if you adopt wall mounting, you can also take below procedure as a reference.

**Steps:**

1. Attach the mounting base (not provided) to the ceiling and tighten the screws to fix it.

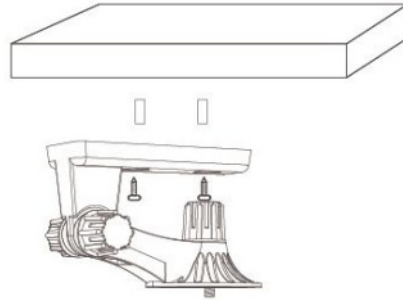

2. Use the lock screw to secure the camera on the mounting base.

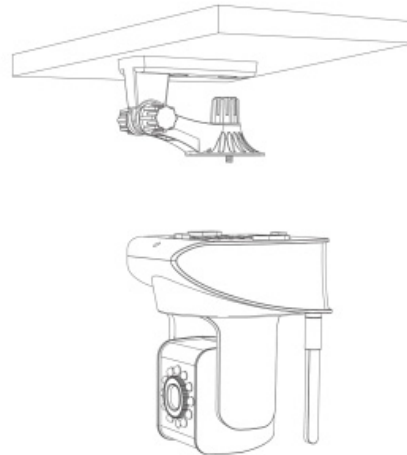

**Notes:**

Please make sure that the ceiling can support more than 50(N) Newton gravities if the camera is fixed to the ceiling.

## 3 Network Connection

### 3.1 Wireless connection

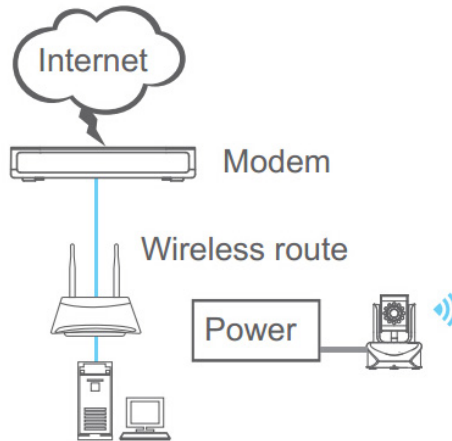

**Notes:**

With wireless connection, you can add the device by “**Add Wi-Fi Device**”, which is based on AP function. Once you connect the camera to the router with Ethernet cable, it will disable AP, which means the function mentioned above won’t work.

### 3.2 Wired Connection

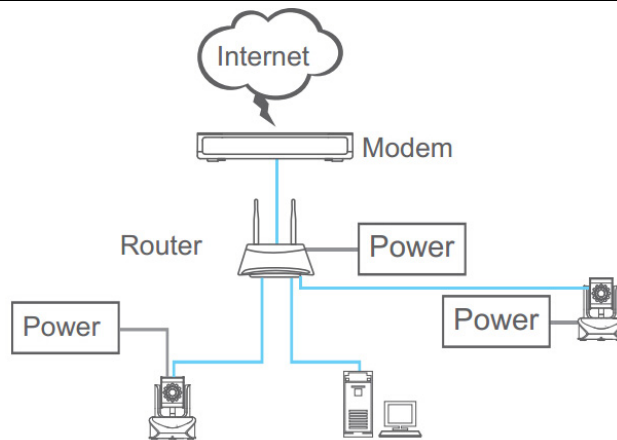

**Notes:**

“**Add Wi-Fi Device**” does not apply to wired connection.

## 4 Preparation on Smart Phone (iOS, Android)

### 4.1 Get NVSIP APP

1. Search “NVSIP” in App Store (iOS) or Google play (Android).
2. Get and install NVSIP on your smart phone.

### 4.2 Register NVSIP Account

**Notes:**

You need to register a NVSIP account before using NVSIP service which is free. Although you can use “**Visitor Login**”, but we strongly recommend that register your own account for better experience. With NVSIP service account, devices list will automatically upload and store on server, and when you login NVSIP with your account on other smart phones, you can access to all these devices without adding them again.

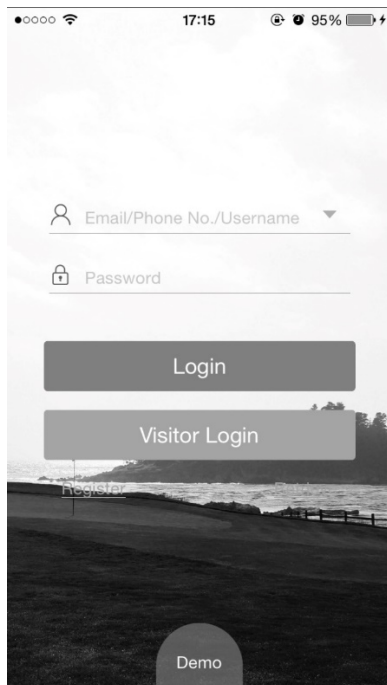

1. Open NVSIP App, and tap “**Register**” on *Login Page*.

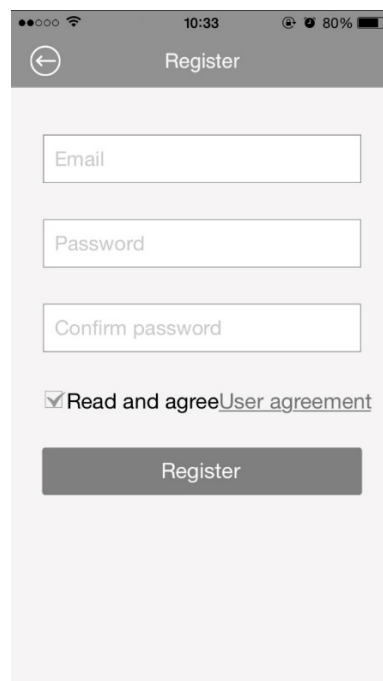

2. Input your E-mail and password, make sure the E-mail has not been registered, tap Register, account will login automatically if the register succeed.

### 4.3 Power-on the Device

Connect the camera with power adapter, the device starts self-checking, it will pan and tilt for about 10 seconds. After that, we can start.

## 5 Add HD Cloud Camera on Phone

### **Before you start:**

The device has to be configured by “**Add by Sound Wave**” or “**Add Wi-Fi Device**” for first-time use if you want to use wireless connection.

Press reset button for about 3 seconds and release to start sound wave configuration

Press reset button for about 15 seconds and release to reset the device.

### 5.1 How to Choose Device Adding Methods



Methods	Situation	Connection
Add by Device ID	The device had been connect to Internet and get device ID online.	Wireless, Ethernet Cable
Scan QR Code	The device had been connect to Internet and get device ID online.(The same as “ <b>Add by Device ID</b> ”)	Wireless, Ethernet Cable
Add Wi-Fi Device	First-time use or the device has been reset.	Wireless
Scan Devices in LAN	The device has been connected to the same network as your smart phone.	Wireless, Ethernet Cable
Add by sound wave	First-time use or the device has been reset.	Wireless

### 5.2 Add by Sound Wave

#### **Notes:**

- Set the volume of your phone to maximum level before this operation.
- Make sure there is no noise when add the device by sound wave.
- Keep the speaker of your phone close enough to the MIC of the device when sound wave is playing

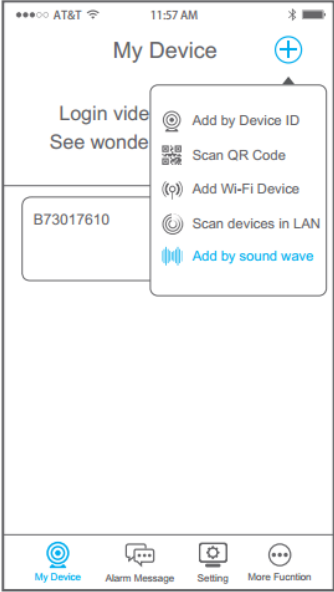
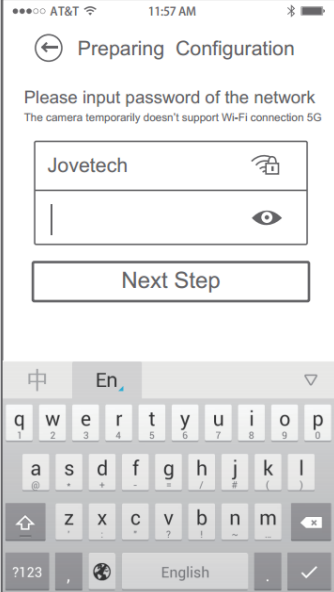
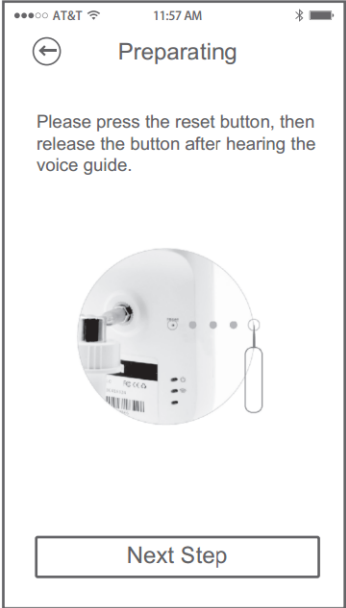

<p>①</p>  <p>Tap ⊕, and select <b>“Add by sound wave”</b></p>	<p>②</p>  <p>Select the network which your phone joined, input the password and tap <b>Next</b>.</p>
<p>③</p>  <p>Press reset button for at least 3 seconds until hear the voice <b>“Start voice configuration”</b>, then release the button and tap <b>Next</b></p>	<p>④</p>  <p>There will be a demonstration with audio instructions on how to use this function. Then close the demonstration.</p>

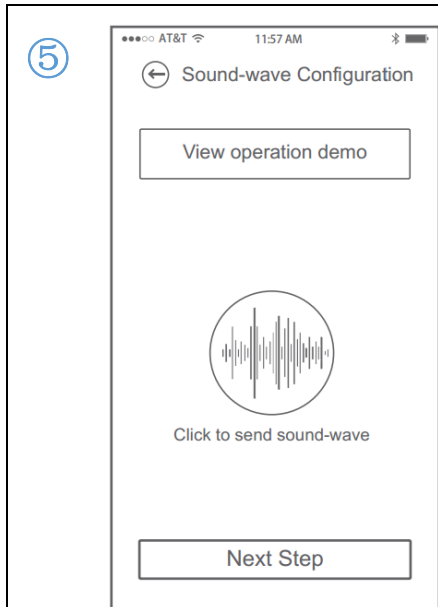

Keep the speaker of your phone close enough to the MIC of the camera, click the sound wave icon to send sound wave, you can send it for many times until hear the voice “**Receive network configuration**”, which means the device has joined the network.

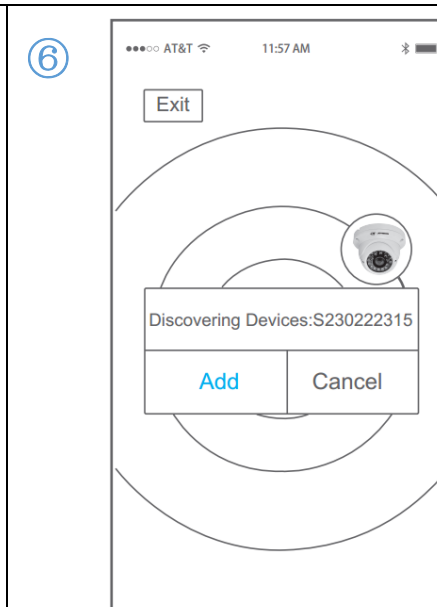

Then NVSIP starts scanning devices in the network. Choose the one you want to add, and click **Add**

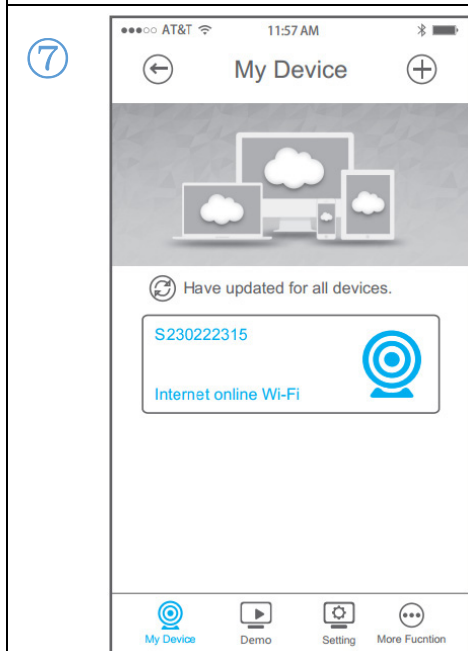

The device will be added.

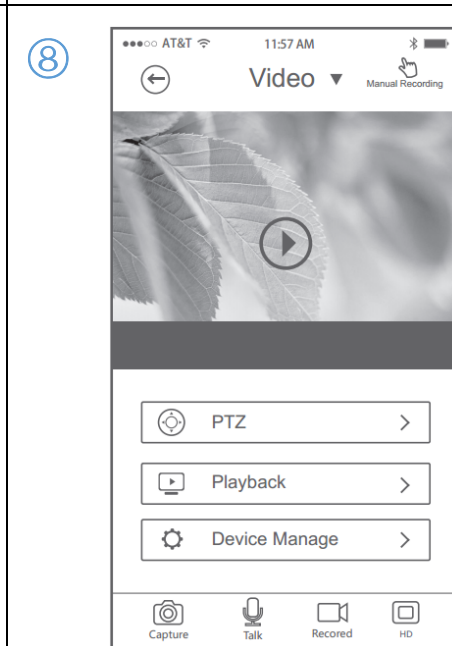

Tap the device on the list, live video will display.

### 5.3 Add Wi-Fi Device on iPhone

**Notes:**

**Do not** connect Ethernet cable before this operation.

①

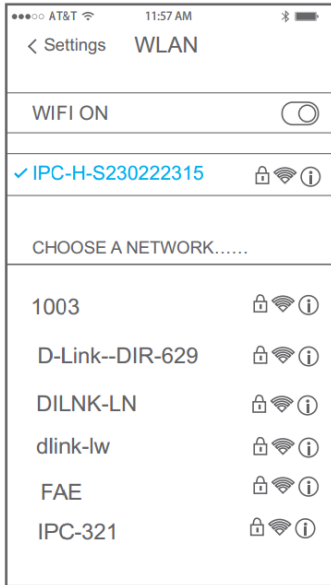

Power-on the device, wait for about 40 seconds, it will create an AP, choose this AP (IPC-H-XXXXXXX) from the WLAN settings of your iPhone, and enter the password (12345678) when prompted.

②

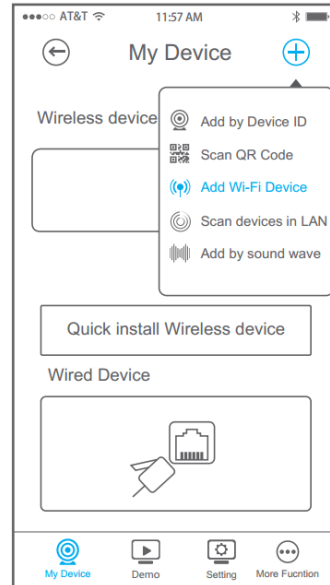

Open NVSIP App, Tap ⊕, and select “**Add Wi-Fi Device**”.

③

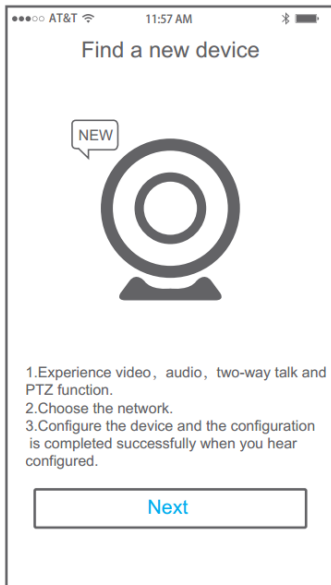

NVSIP will prompt that a new device has been found. Tap **NEXT**.

④

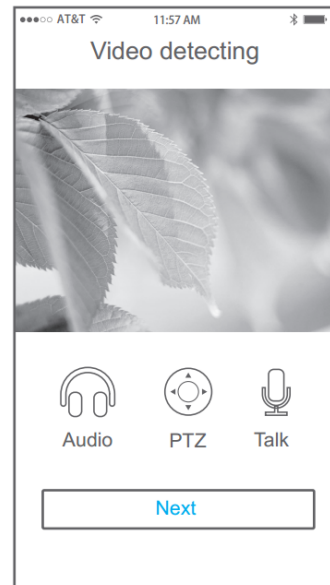

Then the live video of the device will display, you can access *Audio*, *PTZ*, *Talk* function here, but we haven't finished configuring yet, Tap **NEXT**.

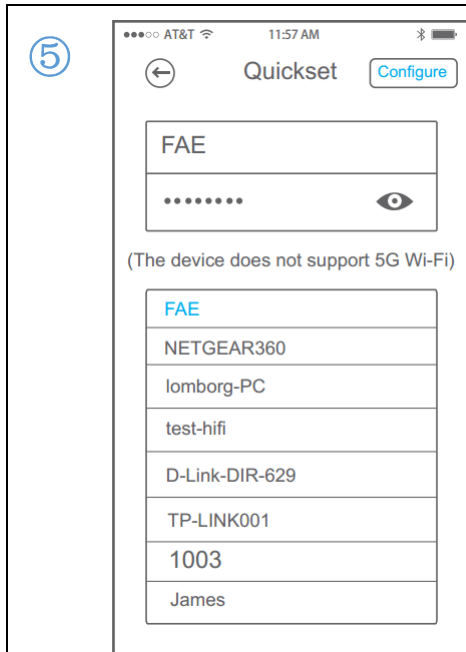

Select the Wi-Fi network for the camera and input the password, tap **Configure**. After hearing **success** from the device, you **NEED** to close the app and switch Wi-Fi network of your iPhone to the one which the camera is connected.

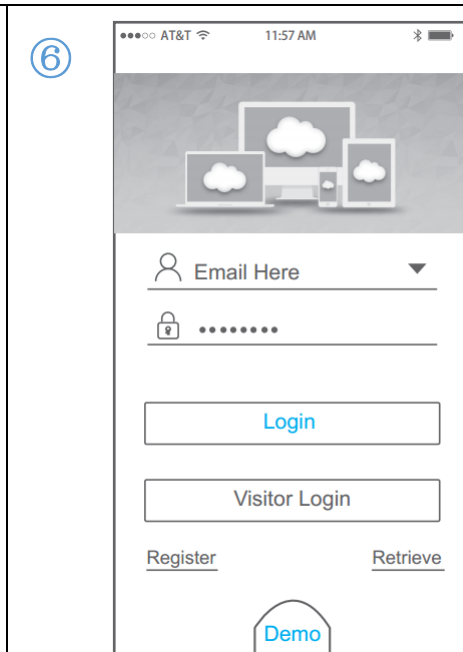

When the Wi-Fi connection is completed, Open NVSIP App again.

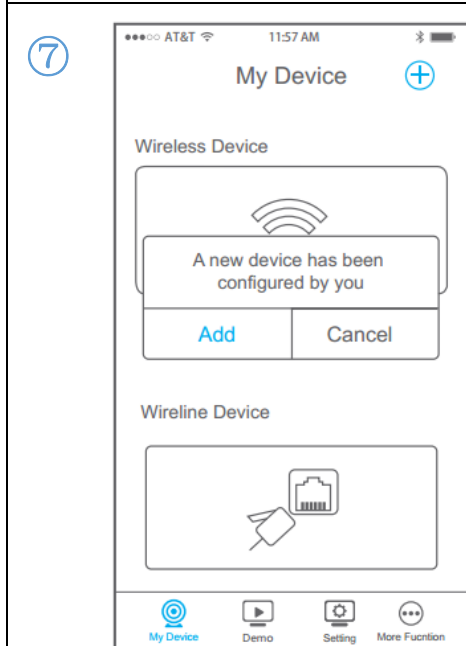

NVSIP will prompt that **“A new device has been configured by you”**, tap **Add**.



Confirm the information of the device, and tap **Save**

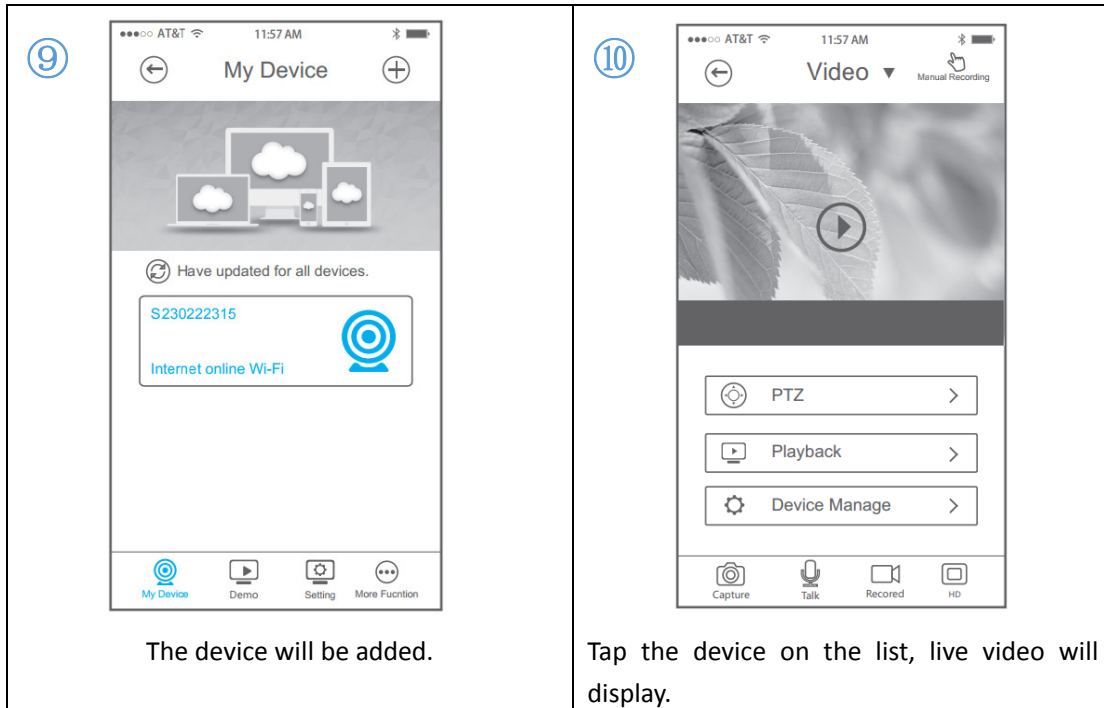

#### 5.4 Add Wi-Fi Device on Android

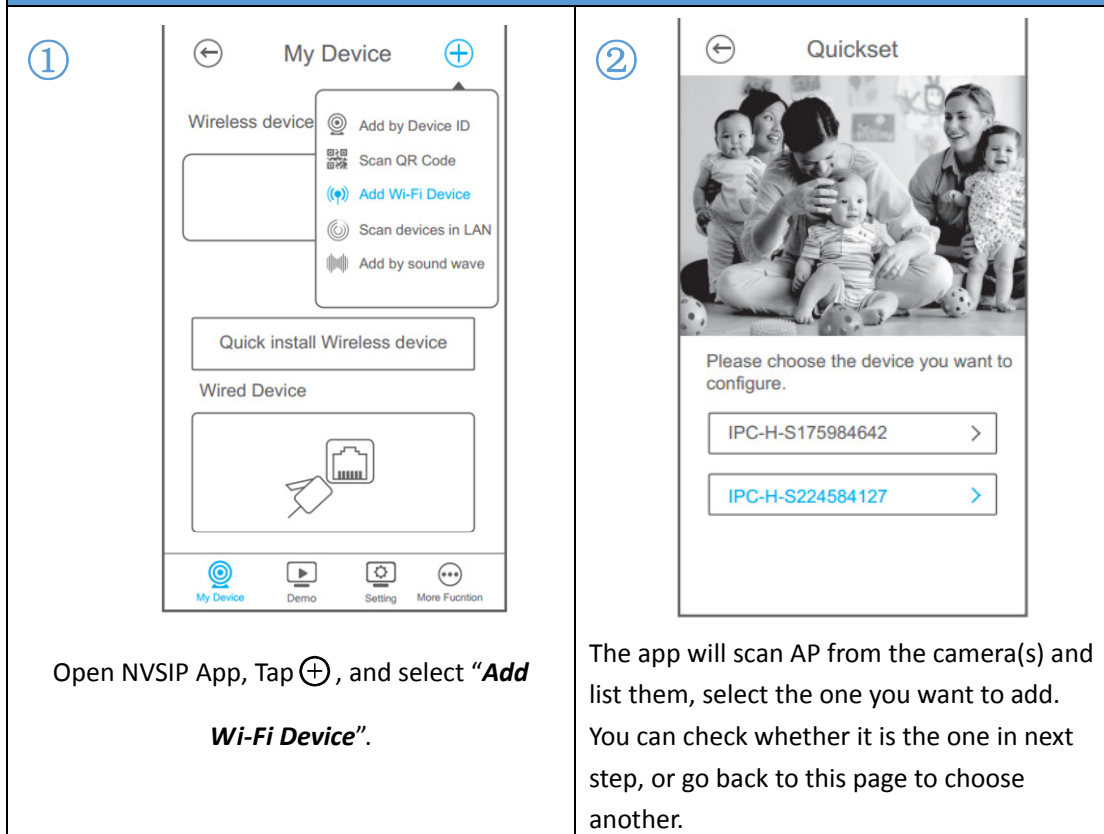

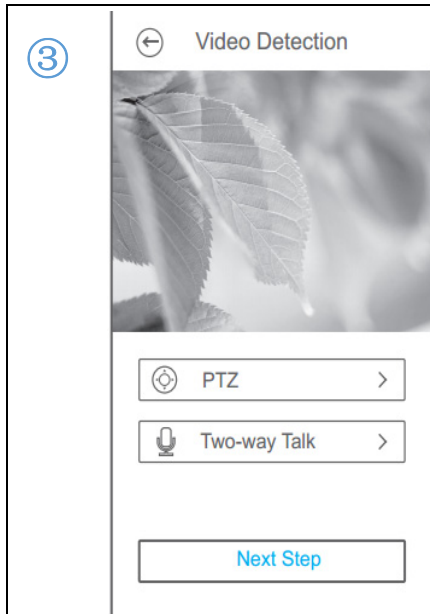

Then the live video of the device will display, check the picture and confirm you can also access *PTZ*, *Two-way Talk* function here, but we haven't finished configuring yet, Tap **NEXT**.

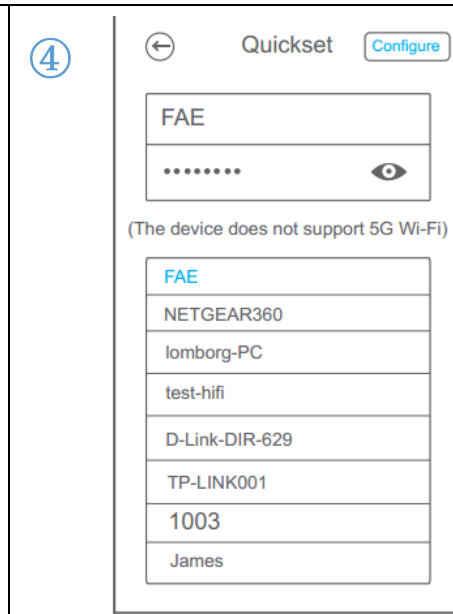

Select the Wi-Fi network for the camera and input the password, tap **Configure**.

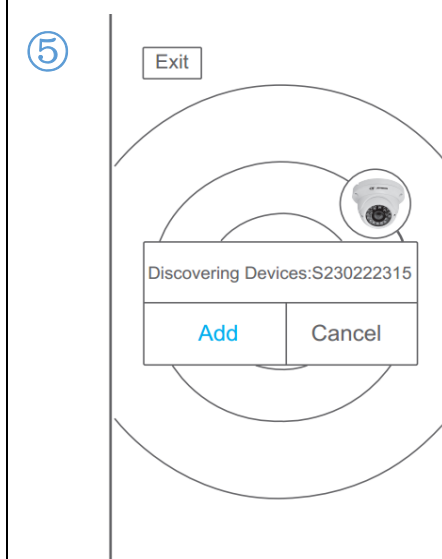

Then NVSIP will prompt that "**Discovering Device**", and click **Add**

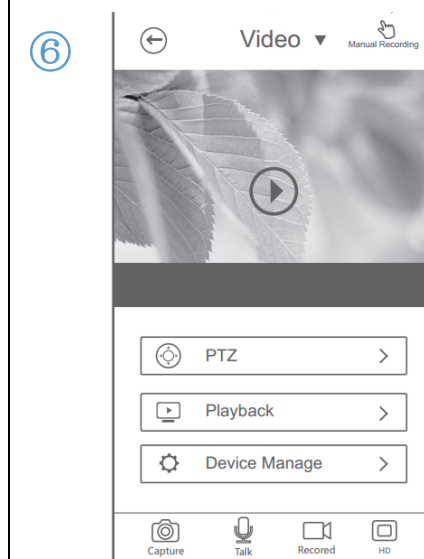



Tap the device on the list, live video will display.

### 5.5 Add by Device ID

**Notes:**

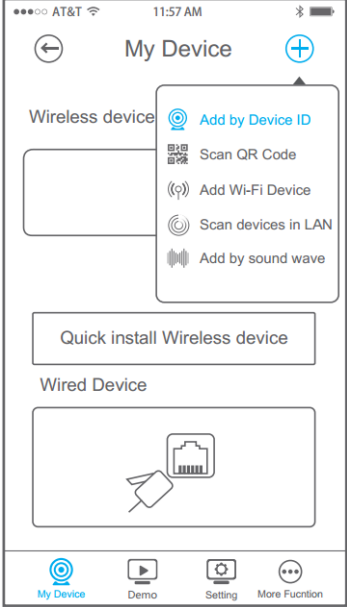
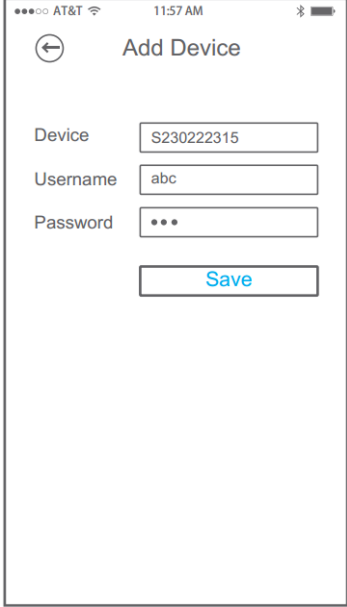
This method requires that the device be connected to Internet and get NVSIP ID online first.

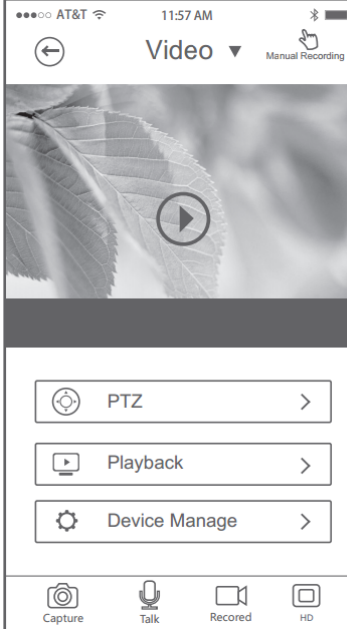
 <p>1</p> <p>Open NVSIP App, Tap ⊕, and select <b>“Add by Device ID”</b>.</p>	 <p>2</p> <p>Input <i>device ID</i>, <i>Username</i>, <i>Password</i> of the device, tap <b>Save</b></p>
 <p>3</p> <p>The device will be added.</p>	 <p>4</p> <p>Tap the device on the list, live video will display.</p>
<p><b>5.6 Scan devices in LAN</b></p>	
<p><b>Notes:</b></p> <p>This method requires that the device be connected to the <b>SAME</b> Wi-Fi network with your smart phone first.</p>	

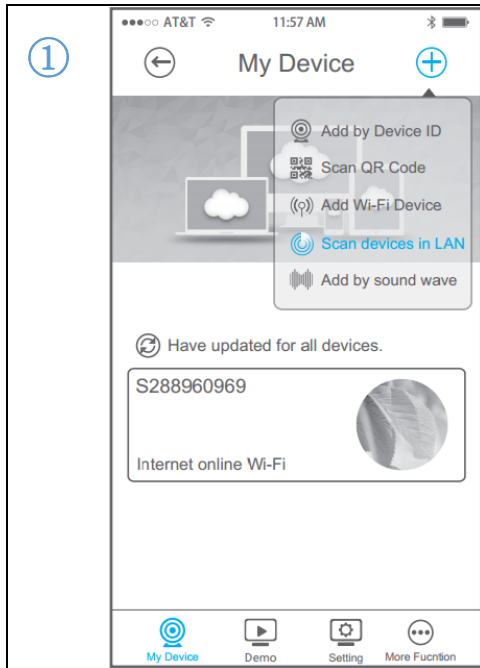

Open NVSIP App, Tap ⊕, and select “**Scan devices in LAN**”.

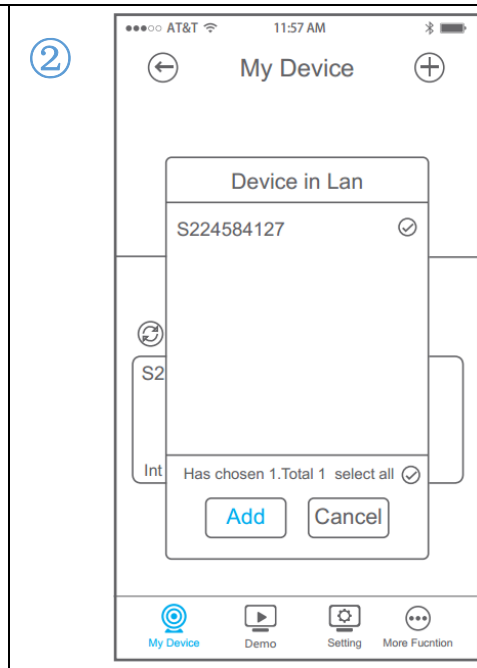

Then NVSIP will detect devices in the LAN, choose the device(s) and tap **Add**.

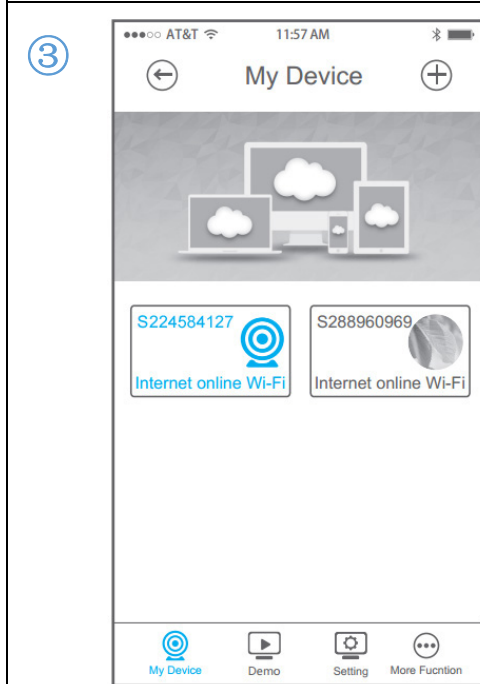

The device will be added.

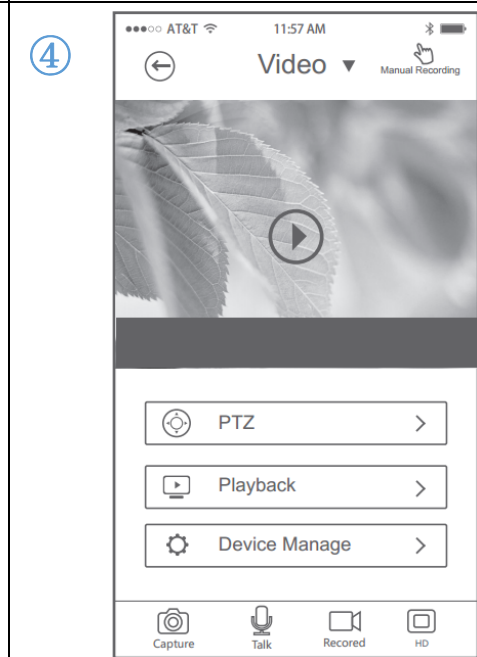

Tap the device on the list, live video will display.