



Shenzhen CTL Testing Technology Co., Ltd.  
Tel: +86-755-89486194 Fax: +86-755-26636041

# TEST REPORT

## FOR FCC PART 15 SUBPART C 15.249

Report Reference No. ....: CTL1606122153-WF

Compiled by:  
( position+printed name+signature)

Jacky Chen  
(File administrators)

*Jacky Chen*

Tested by:  
( position+printed name+signature)

Allen Wang  
(Test Engineer)

*Allen Wang*

Approved by:  
( position+printed name+signature)

Tracy Qi  
(Manager)

*Tracy Qi*

<b>Product Name</b> .....	Bluetooth Earphone
<b>Model/Type reference</b> .....	TE-P28
<b>List Model(s)</b> .....	TE-P29, TE-P30, TE-P31, TE-P32, TE-P33, TE-P34, TE-P35, TE-P36
<b>Trade Mark</b> .....	N/A
<b>FCC ID</b> .....	2AEW6-TE-P28
<b>Applicant's name</b> .....	<b>TESONIC INTERNATIONAL (HK) LTD.</b>
<b>Address of applicant</b> .....	Room 2801,the 28th Office Tower, 6007 Shennan Avenue, Shenzhen, China
<b>Test Firm</b> .....	<b>Shenzhen CTL Testing Technology Co., Ltd.</b>
<b>Address of Test Firm</b> .....	Floor 1-A, Baisha Technology Park, No.3011, Shaheci Road, Nanshan District, Shenzhen, China 518055
<b>Test specification</b> .....	
Standard.....	<b>FCC Part 15.249:</b> Operation within the bands 920-928 MHz, 2400-2483.5 MHz, 5725-5850 MHz and 24.0 - 24.25 GHz.
TRF Originator .....	Shenzhen CTL Testing Technology Co., Ltd.
Master TRF .....	Dated 2011-01
<b>Date of Receipt</b> .....	Jun. 12, 2016
<b>Date of Test Date</b> .....	Jun. 13, 2016–Jun. 21, 2016
<b>Data of Issue</b> .....	Jun. 22, 2016
<b>Result</b> .....	Pass

**Shenzhen CTL Testing Technology Co., Ltd. All rights reserved.**

This publication may be reproduced in whole or in part for non-commercial purposes as long as the Shenzhen CTL Testing Technology Co., Ltd. is acknowledged as copyright owner and source of the material. Shenzhen CTL Testing Technology Co., Ltd. takes no responsibility for and will not assume liability for damages resulting from the reader's interpretation of the reproduced material due to its placement and context.

# TEST REPORT

<b>Test Report No. :</b>	<b>CTL1606122153-WF</b>	Jun. 22, 2016
		Date of issue

Equipment under Test : Bluetooth Earphone

Model /Type : TE-P28

Listed Models : TE-P29, TE-P30, TE-P31, TE-P32, TE-P33, TE-P34,  
TE-P35, TE-P36

**Applicant** : **TESONIC INTERNATIONAL (HK) LTD.**

Address : Room 2801, the 28th Office Tower, 6007 Shennan  
Avenue, Shenzhen, China

**Manufacturer** : **TESONIC INTERNATIONAL (HK) LTD.**

Address : Room 2801, the 28th Office Tower, 6007 Shennan  
Avenue, Shenzhen, China

<b>Test result</b>	<b>Pass *</b>
--------------------	---------------

\* In the configuration tested, the EUT complied with the standards specified page 5.

The test report merely corresponds to the test sample.

It is not permitted to copy extracts of these test result without the written permission of the test laboratory.

**\*\* Modified History \*\***

Revision	Description	Issued Data	Report No.	Remark
Version 1.0	Initial Test Report Release	2016-06-22	CTL1606122153-WF	Tracy Qi



## Table of Contents

Page

<b>1. SUMMARY.....</b>	<b>5</b>
1.1. TEST STANDARDS.....	5
1.2. TEST DESCRIPTION.....	5
1.3. TEST FACILITY.....	6
1.4. STATEMENT OF THE MEASUREMENT UNCERTAINTY.....	6
<b>2. GENERAL INFORMATION.....</b>	<b>7</b>
2.1. ENVIRONMENTAL CONDITIONS.....	7
2.2. GENERAL DESCRIPTION OF EUT.....	7
2.3. DESCRIPTION OF TEST MODES AND TEST FREQUENCY.....	7
2.4. EQUIPMENTS USED DURING THE TEST.....	8
2.5. RELATED SUBMITTAL(S) / GRANT(S).....	8
2.6. MODIFICATIONS.....	8
<b>3. TEST CONDITIONS AND RESULTS.....</b>	<b>9</b>
3.1. CONDUCTED EMISSIONS TEST.....	9
3.2. RADIATED EMISSIONS AND BAND EDGE.....	12
3.3. OCCUPIED BANDWIDTH MEASUREMENT.....	18
3.4. ANTENNA REQUIREMENT.....	22
<b>4. TEST SETUP PHOTOS OF THE EUT.....</b>	<b>23</b>
<b>5. EXTERNAL AND INTERNAL PHOTOS OF THE EUT.....</b>	<b>25</b>

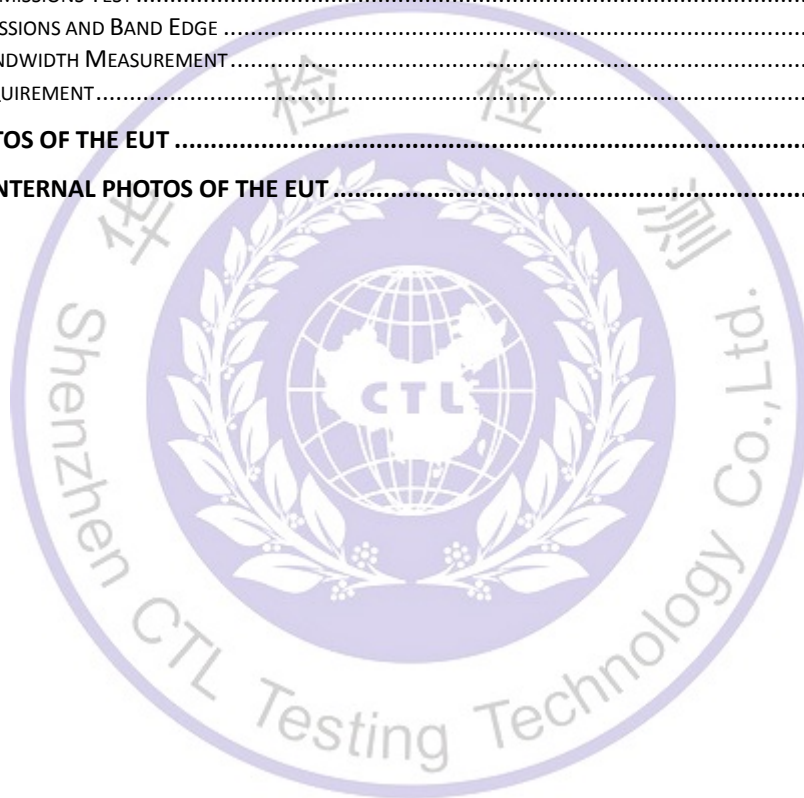

# 1. SUMMARY

## 1.1. TEST STANDARDS

The tests were performed according to following standards:

**FCC Rules Part 15.249:** Operation within the bands 902 - 928 MHz, 2400 - 2483.5 MHz, 5725 - 5875 MHz, and 24.0 - 24.25 GHz.

**ANSI C63.10:2013 :** American National Standard for Testing Unlicensed Wireless Devices

**ANSI C63.4: 2014:** –American National Standard for Methods of Measurement of Radio-Noise Emissions from Low-Voltage Electrical and Electronic Equipment in the Range of 9 kHz to 40GHz  
Range of 9 kHz to 40GHz

## 1.2. Test Description

<b>FCC PART 15.249</b>		
FCC Part 15.249(a)	Field Strength of Fundamental	PASS
FCC Part 15.209	Spurious Emission	PASS
FCC Part 15.209	Band edge	PASS
FCC Part 15.215(c)	20dB bandwidth	PASS
FCC Part 15.207	Conducted Emission	PASS
FCC Part 15.203	Antenna Requirement	PASS

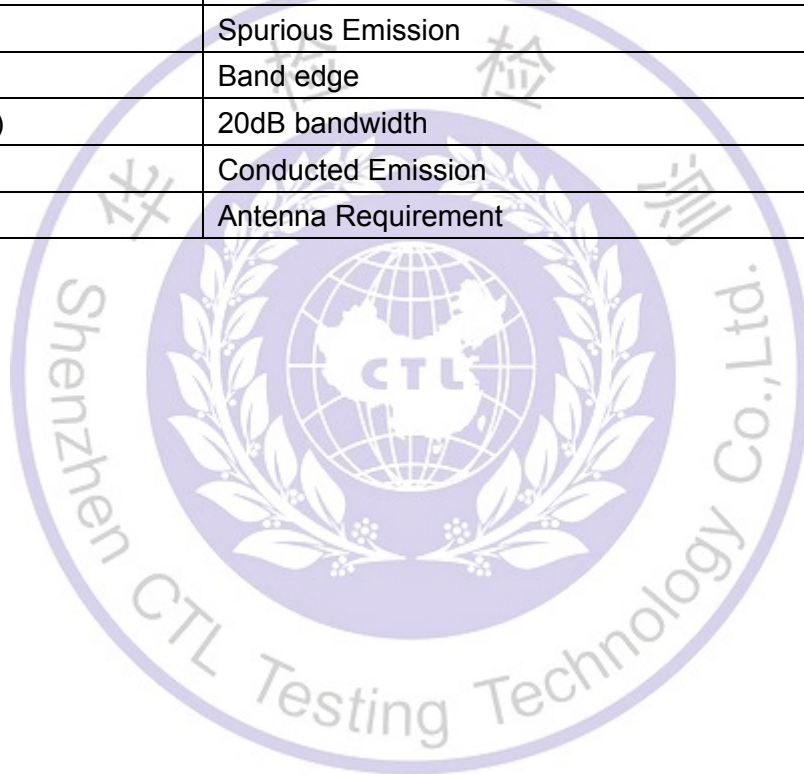



## 1.3. Test Facility

### 1.3.1 Address of the test laboratory

Shenzhen CTL Testing Technology Co., Ltd.

Floor 1-A, Baisha Technology Park, No. 3011, Shahexi Road, Nanshan, Shenzhen 518055 China

There is one 3m semi-anechoic chamber and two line conducted labs for final test. The Test Sites meet the requirements in documents ANSI C63.4 and CISPR 22/EN 55022 requirements.

### 1.3.2 Laboratory accreditation

The test facility is recognized, certified, or accredited by the following organizations:

#### IC Registration No.: 9618B

The 3m alternate test site of Shenzhen CTL Testing Technology Co., Ltd. EMC Laboratory has been registered by Certification and Engineer Bureau of Industry Canada for the performance of with Registration No.: 9618B on November 13, 2013.

#### FCC-Registration No.: 970318

Shenzhen CTL Testing Technology Co., Ltd. EMC Laboratory has been registered and fully described in a report filed with the (FCC) Federal Communications Commission. The acceptance letter from the FCC is maintained in our files. Registration 970318, December 19, 2013.

## 1.4. Statement of the measurement uncertainty

The data and results referenced in this document are true and accurate. The reader is cautioned that there may be errors within the calibration limits of the equipment and facilities. The measurement uncertainty was calculated for all measurements listed in this test report acc. to CISPR 16 - 4 „Specification for radio disturbance and immunity measuring apparatus and methods – Part 4: Uncertainty in EMC Measurements“ and is documented in the Shenzhen CTL Testing Technology Co., Ltd. quality system acc. to DIN EN ISO/IEC 17025. Furthermore, component and process variability of devices similar to that tested may result in additional deviation. The manufacturer has the sole responsibility of continued compliance of the device.

Hereafter the best measurement capability for CTL laboratory is reported:

Test	Range	Measurement Uncertainty	Notes
Radiated Emission	30~1000MHz	4.10dB	(1)
Radiated Emission	Above 1GHz	4.32dB	(1)
Conducted Disturbance	0.15~30MHz	3.20dB	(1)

(1) This uncertainty represents an expanded uncertainty expressed at approximately the 95% confidence level using a coverage factor of k=2.

## 2. GENERAL INFORMATION

### 2.1. Environmental conditions

During the measurement the environmental conditions were within the listed ranges:

Normal Temperature:	25°C
Relative Humidity:	55 %
Air Pressure:	101 kPa

### 2.2. General Description of EUT

Product Name:	Bluetooth Earphone
Model/Type reference:	TE-P28
Power supply:	DC 3.7V from battery
<b>Bluetooth</b>	
Version:	Supported BT2.1+EDR
Modulation:	GFSK, $\pi/4$ DQPSK, 8DPSK
Operation frequency:	2402MHz~2480MHz
Channel number:	79
Channel separation:	1MHz
Antenna type:	PCB Antenna
Antenna gain:	0dBi

Note: For more details, please refer to the user's manual of the EUT.

### 2.3. Description of Test Modes and Test Frequency

The Applicant provides communication tools software to control the EUT for staying in continuous transmitting (Duty Cycle more than 98%) and receiving mode for testing. There are 79 channels provided to the EUT and Channel 00/39/78 were selected for BT2.1 testing.

#### Operation Frequency BT2.1 :

Channel	Frequency (MHz)
<b>00</b>	<b>2402</b>
01	2403
⋮	⋮
38	2440
<b>39</b>	<b>2441</b>
40	2442
⋮	⋮
77	2479
<b>78</b>	<b>2480</b>

## 2.4. Equipments Used during the Test

Test Equipment	Manufacturer	Model No.	Serial No.	Calibration Date	Calibration Due Date
LISN	R&S	ENV216	3560.6550.1 2	2016/06/02	2017/06/01
LISN	R&S	ESH2-Z5	860014/010	2016/06/02	2017/06/01
Bilog Antenna	Sunol Sciences Corp.	JB1	A061713	2016/06/02	2017/06/01
EMI Test Receiver	R&S	ESCI	103710	2016/06/02	2017/06/01
Spectrum Analyzer	Agilent	E4407B	MY41440676	2016/05/21	2017/05/20
Spectrum Analyzer	Agilent	N9020	US46220290	2016/01/17	2017/01/16
Controller	EM Electronics	Controller EM 1000	N/A	2016/05/21	2017/05/20
Horn Antenna	Sunol Sciences Corp.	DRH-118	A062013	2016/05/19	2017/05/18
Active Loop Antenna	SCHWARZBECK	FMZB1519	1519-037	2016/05/19	2017/05/18
Amplifier	Agilent	8349B	3008A02306	2016/05/19	2017/05/18
Amplifier	Agilent	8447D	2944A10176	2016/05/19	2017/05/18
Temperature/Humidity Meter	Gangxing	CTH-608	02	2016/05/20	2017/05/19
High-Pass Filter	K&L	9SH10-2700/X1 2750-O/O	N/A	2016/05/20	2017/05/19
High-Pass Filter	K&L	41H10-1375/U1 2750-O/O	N/A	2016/05/20	2017/05/19
Coaxial Cables	HUBER+SUHNER	SUCOFLEX 104PEA-10M	10m	2016/06/02	2017/06/01
Coaxial Cables	HUBER+SUHNER	SUCOFLEX 104PEA-3M	3m	2016/06/02	2017/06/01
Coaxial Cables	HUBER+SUHNER	SUCOFLEX 104PEA-3M	3m	2016/06/02	2017/06/01
RF Cable	Megalon	RF-A303	N/A	2016/06/02	2017/06/01

The calibration interval was one year

## 2.5. Related Submittal(s) / Grant(s)

This submittal(s) (test report) is intended to comply with Section 15.249 of the FCC Part 15, Subpart C Rules.

## 2.6. Modifications

No modifications were implemented to meet testing criteria.



### 3. TEST CONDITIONS AND RESULTS

#### 3.1. Conducted Emissions Test

##### LIMIT

FCC CFR Title 47 Part 15 Subpart C Section 15.207

Frequency range (MHz)	Limit (dBuV)	
	Quasi-peak	Average
0.15-0.5	66 to 56*	56 to 46*
0.5-5	56	46
5-30	60	50

\* Decreases with the logarithm of the frequency.

##### TEST CONFIGURATION

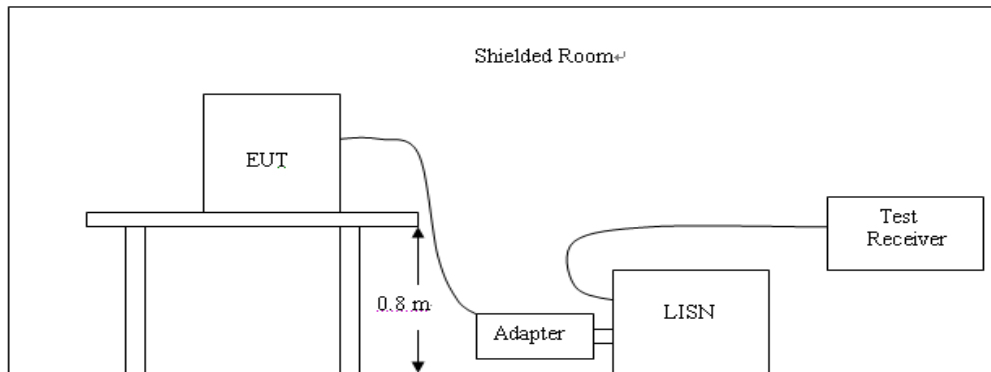

##### TEST PROCEDURE

1. The equipment was set up as per the test configuration to simulate typical actual usage per the user's manual. The EUT is a tabletop system; a wooden table with a height of 0.8 meters is used and is placed on the ground plane as per ANSI C63.10:2013.
2. Support equipment, if needed, was placed as per ANSI C63.10:2013.
3. All I/O cables were positioned to simulate typical actual usage as per ANSI C63.10:2013.
4. If a EUT received DC power from the USB Port of Notebook PC, the PC's adapter received AC120V/60Hz power through a Line Impedance Stabilization Network (LISN) which supplied power source and was grounded to the ground plane.
5. All support equipments received AC power from a second LISN, if any.
6. The EUT test program was started. Emissions were measured on each current carrying line of the EUT using a spectrum Analyzer / Receiver connected to the LISN powering the EUT. The LISN has two monitoring points: Line 1 (Hot Side) and Line 2 (Neutral Side). Two scans were taken: one with Line 1 connected to Analyzer / Receiver and Line 2 connected to a 50 ohm load; the second scan had Line 1 connected to a 50 ohm load and Line 2 connected to the Analyzer / Receiver.
7. Analyzer / Receiver scanned from 150 KHz to 30MHz for emissions in each of the test modes.
8. During the above scans, the emissions were maximized by cable manipulation.

**TEST RESULTS**

Remark: All modes of GFSK, Pi/4 DQPSK, and 8DPSK were test at Low, Middle, and High channel; only the worst result of 8DPSK High Channel was reported as below:

**SCAN TABLE: "Voltage (9K-30M) FIN"**

Short Description: 150K-30M Voltage

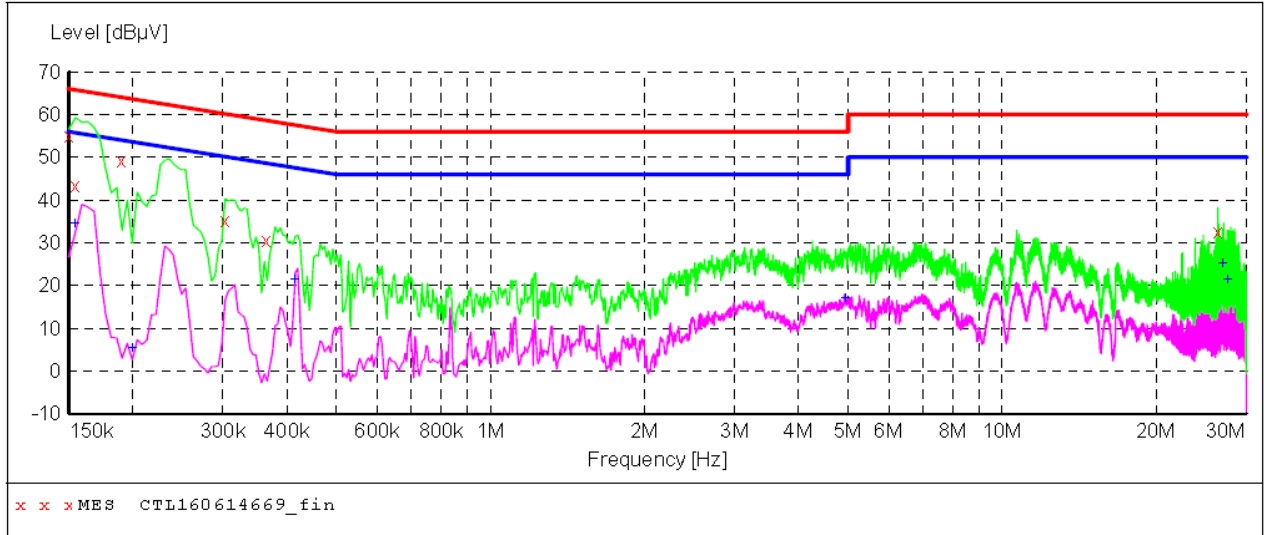

**MEASUREMENT RESULT: "CTL160614669\_fin"**

6/14/2016 7:56PM

Frequency MHz	Level dBµV	Transd dB	Limit dBµV	Margin dB	Detector	Line	PE
0.150001	54.90	10.2	66	11.1	QP	L1	GND
0.154501	43.50	10.2	66	22.3	QP	L1	GND
0.190501	49.10	10.2	64	14.9	QP	L1	GND
0.303001	35.20	10.2	60	25.0	QP	L1	GND
0.366001	30.70	10.2	59	27.9	QP	L1	GND
26.412001	32.70	11.2	60	27.3	QP	L1	GND

**MEASUREMENT RESULT: "CTL160614669\_fin2"**

6/14/2016 7:56PM

Frequency MHz	Level dBµV	Transd dB	Limit dBµV	Margin dB	Detector	Line	PE
0.154501	34.30	10.2	56	21.5	AV	L1	GND
0.199501	5.10	10.2	54	48.5	AV	L1	GND
0.415501	21.30	10.2	48	26.2	AV	L1	GND
4.942501	16.80	10.4	46	29.2	AV	L1	GND
27.015001	24.90	11.2	50	25.1	AV	L1	GND
27.676501	21.20	11.2	50	28.8	AV	L1	GND

**SCAN TABLE: "Voltage (9K-30M) FIN"**

Short Description: 150K-30M Voltage

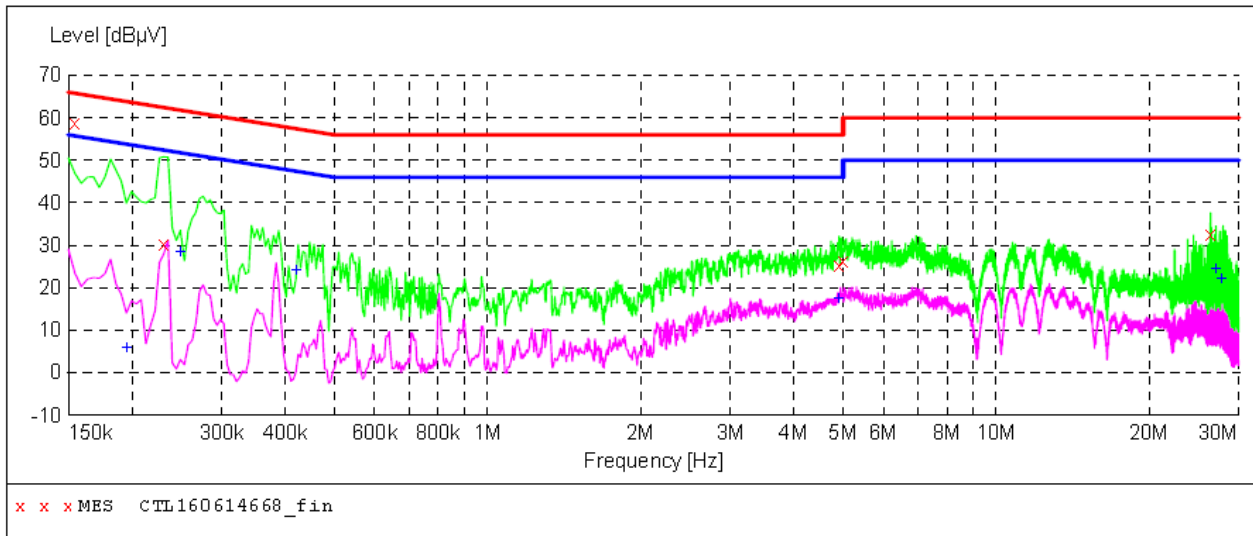

**MEASUREMENT RESULT: "CTL160614668\_fin"**

6/14/2016 7:53PM

Frequency MHz	Level dBµV	Transd dB	Limit dBµV	Margin dB	Detector	Line	PE
0.154501	58.90	10.2	66	6.9	QP	N	GND
0.231001	30.40	10.2	62	32.0	QP	N	GND
4.915501	25.30	10.4	56	30.7	QP	N	GND
4.992001	26.40	10.4	56	29.6	QP	N	GND
26.412001	32.50	11.2	60	27.5	QP	N	GND

**MEASUREMENT RESULT: "CTL160614668\_fin2"**

6/14/2016 7:53PM

Frequency MHz	Level dBµV	Transd dB	Limit dBµV	Margin dB	Detector	Line	PE
0.195001	5.80	10.2	54	48.0	AV	N	GND
0.249001	28.50	10.2	52	23.3	AV	N	GND
0.420001	24.00	10.2	47	23.4	AV	N	GND
4.902001	17.50	10.4	46	28.5	AV	N	GND
27.015001	24.40	11.2	50	25.6	AV	N	GND
27.676501	21.90	11.2	50	28.1	AV	N	GND

### 3.2. Radiated Emissions and Band Edge

#### Limit

According 15.249, the field strength of emissions from intentional radiators operated within 2400MHz-2483.5 MHz shall not exceed 94dBµV/m (50mV/m):

FCC PART 15.249(d) Emissions radiated outside of the specified frequency bands, except for harmonics, shall be attenuated by at least 50 dB below the level of the fundamental or to the general radiated emission limits in §15.209, whichever is the lesser attenuation.

In addition, radiated emissions which fall in the restricted bands, as defined in §15.205(a), must also comply with the radiated emission limits specified in §15.209(a)

Radiated emission limits

Frequency (MHz)	Distance (Meters)	Radiated (dBµV/m)	Radiated (µV/m)
0.009-0.49	3	$20\log(2400/F(\text{KHz}))+40\log(300/3)$	$2400/F(\text{KHz})$
0.49-1.705	3	$20\log(24000/F(\text{KHz}))+ 40\log(30/3)$	$24000/F(\text{KHz})$
1.705-30	3	$20\log(30)+ 40\log(30/3)$	30
30-88	3	40.0	100
88-216	3	43.5	150
216-960	3	46.0	200
Above 960	3	54.0	500

#### TEST CONFIGURATION

(A) Radiated Emission Test Set-Up, Frequency Below 30MHz

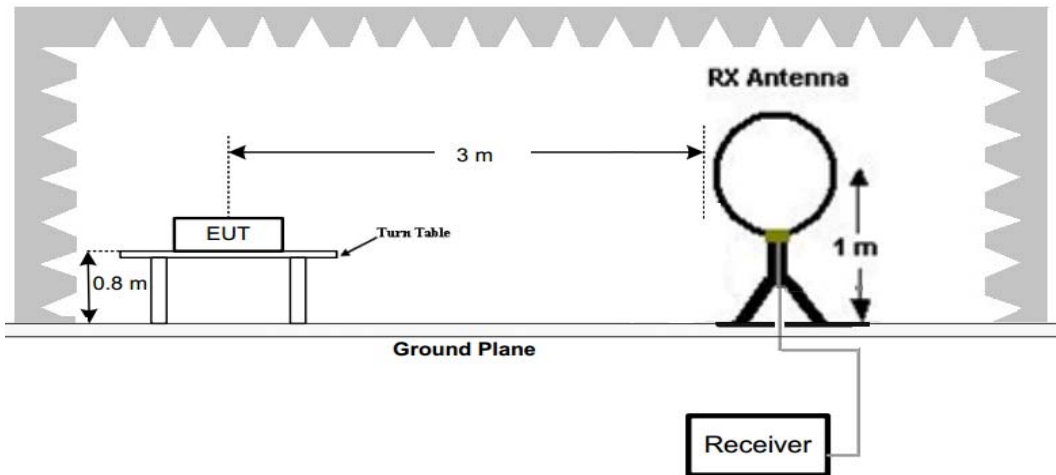

(B) Radiated Emission Test Set-Up, Frequency below 1000MHz

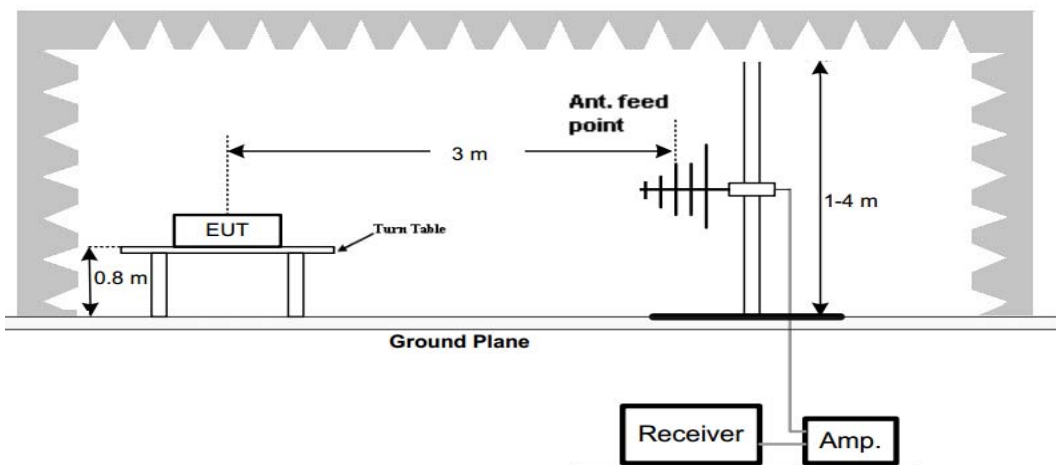

## (C) Radiated Emission Test Set-Up, Frequency above 1000MHz

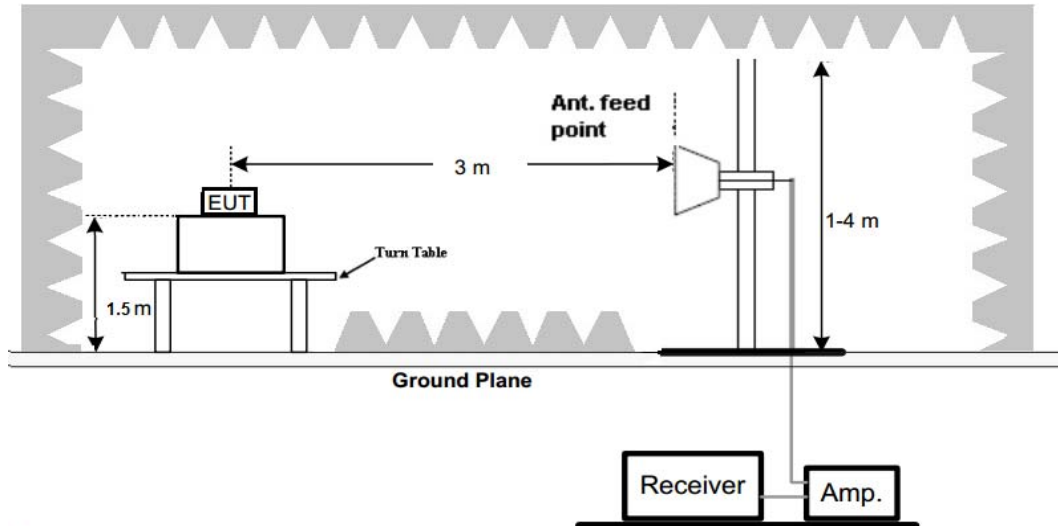
**Test Procedure**

1. Below 1GHz measurement the EUT is placed on a turntable which is 0.8m above ground plane, and above 1GHz measurement EUT was placed on a low permittivity and low loss tangent turn table which is 1.5m above ground plane.
2. Maximum procedure was performed by raising the receiving antenna from 1m to 4m and rotating the turn table from 0° to 360° to acquire the highest emissions from EUT
3. And also, each emission was to be maximized by changing the polarization of receiving antenna both horizontal and vertical.
4. Repeat above procedures until all frequency measurements have been completed.

**TEST RESULTS**

Remark:

1. We measured Radiated Emission at GFSK,  $\pi/4$  DQPSK and 8DPSK mode from 9 KHz to 25GHz and recorded worst case at GFSK DH5 mode.
2. For below 1GHz testing recorded worst at GFSK DH5 low channel.
3. Radiated emission test from 9 KHz to 10th harmonic of fundamental was verified, and no emission found except system noise floor in 9 KHz to 30MHz and not recorded in this report.



For 30MHz-1GHz

Horizontal

**SWEEP TABLE: "test (30M-1G)"**

Short Description:		Field Strength			
Start	Stop	Detector	Meas. Time	IF Bandw.	Transducer
30.0 MHz	1.0 GHz	MaxPeak	300.0 ms	120 kHz	JB1

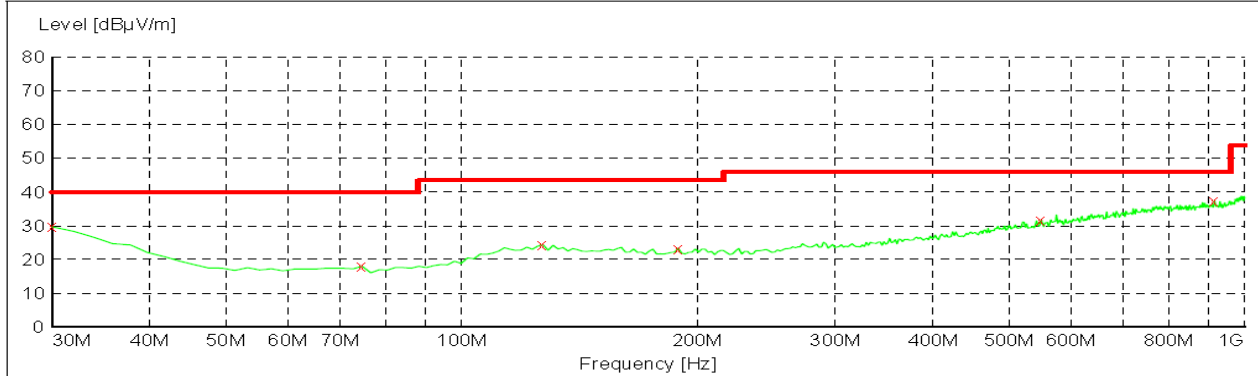

x x x MES CTL160617333\_red

**MEASUREMENT RESULT: "CTL160617333\_red"**

6/17/2016 8:55AM

Frequency MHz	Level dBµV/m	Transd dB	Limit dBµV/m	Margin dB	Det.	Height cm	Azimuth deg	Polarization
30.000000	29.70	20.8	40.0	10.3	---	0.0	0.00	HORIZONTAL
74.620000	18.00	8.3	40.0	22.0	---	0.0	0.00	HORIZONTAL
127.000000	24.40	14.6	43.5	19.1	---	0.0	0.00	HORIZONTAL
189.080000	23.30	13.1	43.5	20.2	---	0.0	0.00	HORIZONTAL
549.920000	31.80	21.0	46.0	14.2	---	0.0	0.00	HORIZONTAL
914.640000	37.50	26.1	46.0	8.5	---	0.0	0.00	HORIZONTAL

Vertical

**SWEEP TABLE: "test (30M-1G)"**

Short Description:		Field Strength			
Start	Stop	Detector	Meas. Time	IF Bandw.	Transducer
30.0 MHz	1.0 GHz	MaxPeak	300.0 ms	120 kHz	JB1

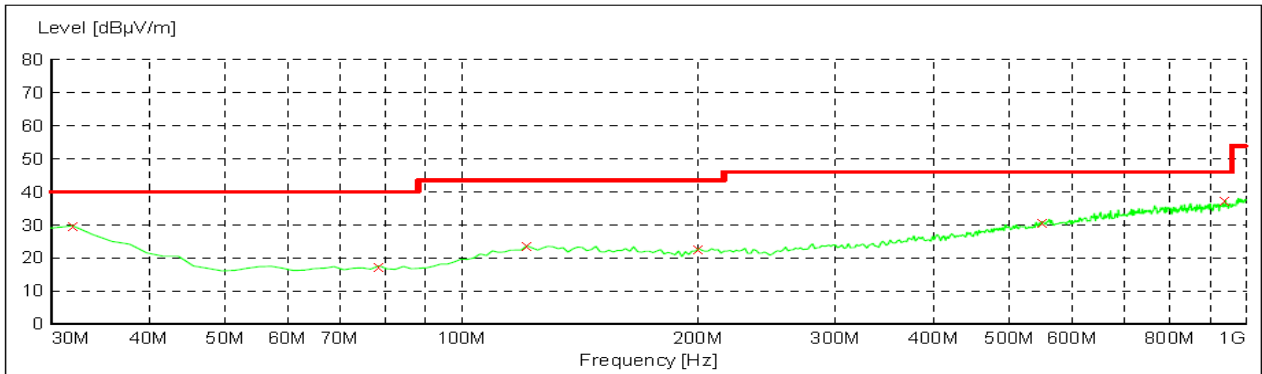

x x x MES CTL160617334\_red

**MEASUREMENT RESULT: "CTL160617334\_red"**

6/17/2016 8:56AM

Frequency MHz	Level dBµV/m	Transd dB	Limit dBµV/m	Margin dB	Det.	Height cm	Azimuth deg	Polarization
31.940000	29.70	19.2	40.0	10.3	---	0.0	0.00	VERTICAL
78.500000	17.60	8.4	40.0	22.4	---	0.0	0.00	VERTICAL
121.180000	23.70	14.7	43.5	19.8	---	0.0	0.00	VERTICAL
200.720000	22.80	14.1	43.5	20.7	---	0.0	0.00	VERTICAL
549.920000	31.00	21.0	46.0	15.0	---	0.0	0.00	VERTICAL
941.800000	37.40	26.4	46.0	8.6	---	0.0	0.00	VERTICAL

**For 1GHz to 25GHz**

Note: GFSK, Pi/4 DQPSK and 8DPSK all have been tested, only worse case GFSK is reported.

**BT2.1 GFSK Mode (above 1GHz)**

Frequency(MHz):				2402		Polarity:			HORIZONTAL	
No.	Frequency (MHz)	Emission Level (dBuV/m)		Limit (dBuV/m)	Margin (dB)	Raw Value (dBuV)	Antenna Factor (dB/m)	Cable Factor (dB)	Pre-amplifier (dB)	Correction Factor (dB/m)
1	2402.00	96.58	PK	114	17.42	63.18	28.78	4.61	0.00	33.40
1	2402.00	90.12	AV	94	3.88	56.72	28.78	4.61	0.00	33.40
2	2390.00	43.52	PK	74	30.48	10.20	28.72	4.60	0.00	33.32
2	2390.00	--	AV	54	--	--	--	--	--	--
3	2400.00	48.65	PK	74	25.35	15.26	28.78	4.61	0.00	33.39
3	2400.00	--	AV	54	--	--	--	--	--	--
4	4804.00	57.41	PK	74	16.59	52.90	33.49	6.91	35.89	4.51
4	4804.00	49.65	AV	54	4.35	45.14	33.49	6.91	35.89	4.51
5	5211.50	46.52	PK	74	27.48	39.13	34.55	7.15	34.31	7.39
5	5211.50	--	AV	54	--	--	--	--	--	--
6	7206.00	47.52	PK	74	26.48	36.41	36.95	9.18	35.03	11.11
6	7206.00	--	AV	54	--	--	--	--	--	--

Frequency(MHz):				2402		Polarity:			VERTICAL	
No.	Frequency (MHz)	Emission Level (dBuV/m)		Limit (dBuV/m)	Margin (dB)	Raw Value (dBuV)	Antenna Factor (dB/m)	Cable Factor (dB)	Pre-amplifier (dB)	Correction Factor (dB/m)
1	2402.00	96.87	PK	114	17.13	63.47	28.78	4.61	0.00	33.40
1	2402.00	90.24	AV	94	3.76	56.84	28.78	4.61	0.00	33.40
2	2390.00	43.56	PK	74	30.44	10.24	28.72	4.60	0.00	33.32
2	2390.00	--	AV	54	--	--	--	--	--	--
3	2400.00	48.87	PK	74	25.13	15.48	28.78	4.61	0.00	33.39
3	2400.00	--	AV	54	--	--	--	--	--	--
4	4804.00	56.63	PK	74	17.37	52.12	33.49	6.91	35.89	4.51
4	4804.00	48.59	AV	54	5.41	44.08	33.49	6.91	35.89	4.51
5	5275.25	46.78	PK	74	27.22	39.31	34.62	7.19	34.33	7.47
5	5275.25	--	AV	54	--	--	--	--	--	--
6	7206.00	49.31	PK	74	24.69	38.20	36.95	9.18	35.03	11.11
6	7206.00	--	AV	54	--	--	--	--	--	--

**REMARKS:**

1. Emission level (dBuV/m) =Raw Value (dBuV)+Correction Factor (dB/m)
2. Correction Factor (dB/m) = Antenna Factor (dB/m)+Cable Factor (dB)-Pre-amplifier Factor
3. Margin value = Limit value- Emission level.
4. -- Mean the PK detector measured value is below average limit.
5. The other emission levels were very low against the limit.
6. RBW1MHz VBW3MHz Peak detector is for PK value; RBW 1MHz VBW10Hz Peak detector is for AV value.
7. For fundamental frequency, RBW 3MHz VBW 3MHz Peak detector is for PK Value ; RMS detector is for AV value.

Frequency(MHz):				2441		Polarity:			HORIZONTAL	
No.	Frequency (MHz)	Emission Level (dBuV/m)		Limit (dBuV/m)	Margin (dB)	Raw Value (dBuV)	Antenna Factor (dB/m)	Cable Factor (dB)	Pre-amplifier (dB)	Correction Factor (dB/m)
1	2441.00	96.14	PK	114	17.86	62.63	28.85	4.66	0.00	33.51
1	2441.00	90.21	AV	94	3.79	56.70	28.85	4.66	0.00	33.51
2	4235.50	43.58	PK	74	30.42	38.88	32.82	6.54	34.67	4.70
2	4235.50	--	AV	54	--	--	--	--	--	--
3	4882.00	56.98	PK	74	17.02	50.72	33.60	6.95	34.30	6.26
3	4882.00	48.33	AV	54	5.67	42.07	33.60	6.95	34.30	6.26
4	5275.75	46.48	PK	74	27.52	38.75	34.62	7.19	34.07	7.73
4	5275.75	--	AV	54	--	--	--	--	--	--
5	7323.00	48.21	PK	74	25.79	36.51	37.46	9.23	35.00	11.70
5	7323.00	--	AV	54	--	--	--	--	--	--

Frequency(MHz):				2441		Polarity:			VERTICAL	
No.	Frequency (MHz)	Emission Level (dBuV/m)		Limit (dBuV/m)	Margin (dB)	Raw Value (dBuV)	Antenna Factor (dB/m)	Cable Factor (dB)	Pre-amplifier (dB)	Correction Factor (dB/m)
1	2441.00	96.55	PK	114	17.45	63.04	28.85	4.66	0.00	33.51
1	2441.00	90.21	AV	94	3.79	56.70	28.85	4.66	0.00	33.51
2	4105.50	44.25	PK	74	29.75	39.72	32.81	6.46	34.74	4.53
2	4105.50	--	AV	54	--	--	--	--	--	--
3	4882.00	56.39	PK	74	17.61	50.13	33.60	6.95	34.30	6.26
3	4882.00	47.45	AV	54	6.55	41.19	33.60	6.95	34.30	6.26
4	5105.25	42.33	PK	74	31.67	35.07	34.34	7.09	34.17	7.26
4	5105.25	--	AV	54	--	--	--	--	--	--
5	7323.00	46.95	PK	74	27.05	35.25	37.46	9.23	35.00	11.70
5	7323.00	--	AV	54	--	--	--	--	--	--

## REMARKS:

1. Emission level (dBuV/m) =Raw Value (dBuV)+Correction Factor (dB/m)
2. Correction Factor (dB/m) = Antenna Factor (dB/m)+Cable Factor (dB)-Pre-amplifier Factor
3. Margin value = Limit value- Emission level.
4. -- Mean the PK detector measured value is below average limit.
5. The other emission levels were very low against the limit.
6. RBW1MHz VBW3MHz Peak detector is for PK value; RBW 1MHz VBW10Hz Peak detector is for AV value.
7. For fundamental frequency, RBW 3MHz VBW 3MHz Peak detector is for PK Value; RMS detector is for AV value.

Frequency(MHz):				2480		Polarity:			HORIZONTAL	
No.	Frequency (MHz)	Emission Level (dBuV/m)		Limit (dBuV/m)	Margin (dB)	Raw Value (dBuV)	Antenna Factor (dB/m)	Cable Factor (dB)	Pre-amplifier (dB)	Correction Factor (dB/m)
1	2480.00	96.15	PK	114	17.85	62.53	28.92	4.70	0.00	33.62
1	2480.00	90.22	AV	94	3.78	56.60	28.92	4.70	0.00	33.62
2	2483.50	47.45	PK	74	26.55	13.82	28.93	4.70	0.00	33.63
2	2483.50	--	AV	54	--	--	--	--	--	--
3	2500.00	40.84	PK	74	33.16	7.16	28.96	4.72	0.00	33.68
3	2500.00	--	AV	54	--	--	--	--	--	--
4	4960.00	56.36	PK	74	17.64	51.44	33.84	7.00	35.92	4.92
4	4960.00	49.75	AV	54	4.25	44.83	33.84	7.00	35.92	4.92
5	5125.50	43.26	PK	74	30.74	36.05	34.38	7.10	34.28	7.21
5	5125.50	--	AV	54	--	--	--	--	--	--
6	7440.00	45.69	PK	74	28.31	33.74	37.64	9.28	34.97	11.95
6	7440.00	--	AV	54	--	--	--	--	--	--

Frequency(MHz):				2480		Polarity:			VERTICAL	
No.	Frequency (MHz)	Emission Level (dBuV/m)		Limit (dBuV/m)	Margin (dB)	Raw Value (dBuV)	Antenna Factor (dB/m)	Cable Factor (dB)	Pre-amplifier (dB)	Correction Factor (dB/m)
1	2480.00	96.41	PK	114	17.59	62.79	28.92	4.70	0.00	33.62
1	2480.00	89.25	AV	94	4.75	55.63	28.92	4.70	0.00	33.62
2	2483.50	45.36	PK	74	28.64	11.73	28.93	4.70	0.00	33.63
2	2483.50	--	AV	54	--	--	--	--	--	--
3	2500.00	40.74	PK	74	33.26	7.06	28.96	4.72	0.00	33.68
3	2500.00	--	AV	54	--	--	--	--	--	--
4	4960.00	56.69	PK	74	17.31	51.77	33.84	7.00	35.92	4.92
4	4960.00	45.41	AV	54	8.59	40.49	33.84	7.00	35.92	4.92
5	5125.75	44.33	PK	74	29.67	37.12	34.38	7.10	34.28	7.21
5	5125.75	--	AV	54	--	--	--	--	--	--
6	7440.00	46.12	PK	74	27.88	34.17	37.64	9.28	34.97	11.95
6	7440.00	--	AV	54	--	--	--	--	--	--

## REMARKS:

1. Emission level (dBuV/m) =Raw Value (dBuV)+Correction Factor (dB/m)
2. Correction Factor (dB/m) = Antenna Factor (dB/m)+Cable Factor (dB)-Pre-amplifier Factor
3. Margin value = Limit value- Emission level.
4. -- Mean the PK detector measured value is below average limit.
5. The other emission levels were very low against the limit.
6. RBW1MHz VBW3MHz Peak detector is for PK value; RBW 1MHz VBW10Hz Peak detector is for AV value.
7. For fundamental frequency, RBW 3MHz VBW 3MHz Peak detector is for PK Value; RMS detector is for AV value.

### 3.3. Occupied Bandwidth Measurement

#### Limit

N/A

#### Test Configuration

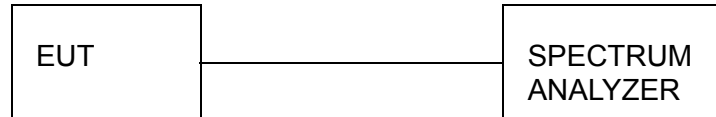

#### Test Procedure

The transmitter output was connected to the spectrum analyzer through an attenuator. The bandwidth of the fundamental frequency was measured by spectrum analyzer with 30 KHz RBW and 100 KHz VBW.

The 20dB bandwidth is defined as the total spectrum the power of which is higher than peak power minus 20dB.

#### Test Results

##### **BT2.1**

Modulation	Channel	99% OBW (MHz)	20dB bandwidth (MHz)	Result
GFSK	CH00	0.827	0.653	Pass
	CH39	0.824	0.654	
	CH78	0.841	0.655	
$\pi/4$ DQPSK	CH00	1.150	1.242	
	CH39	1.151	1.239	
	CH78	1.151	1.245	
8DPSK	CH00	1.140	1.211	
	CH39	1.139	1.207	
	CH78	1.140	1.214	

**Test plot as follows:**



**BT2.1**  
**GFSK Modulation**

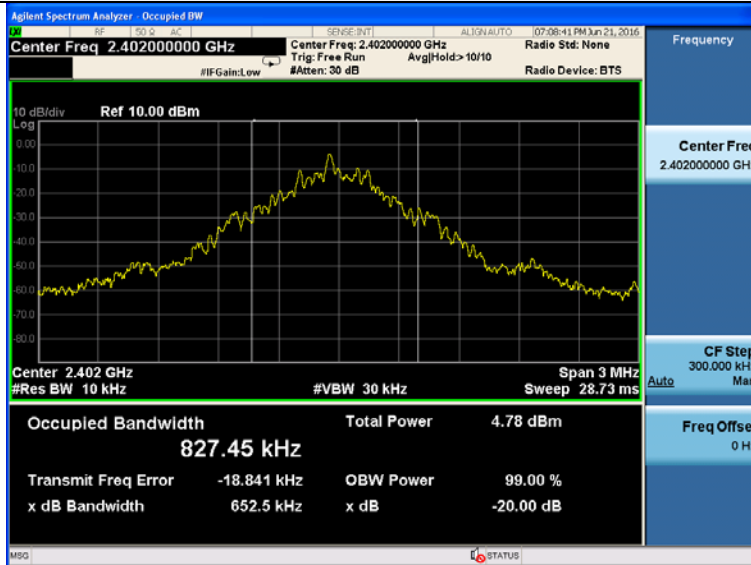

**CH00**

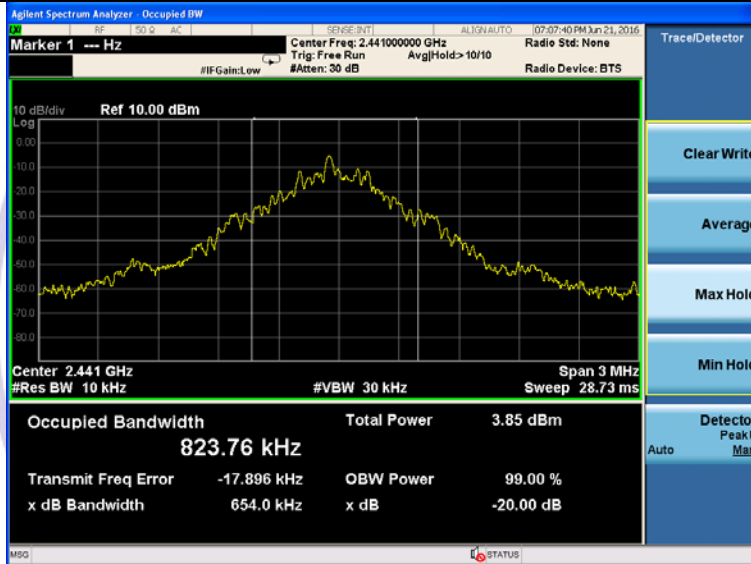

**CH39**

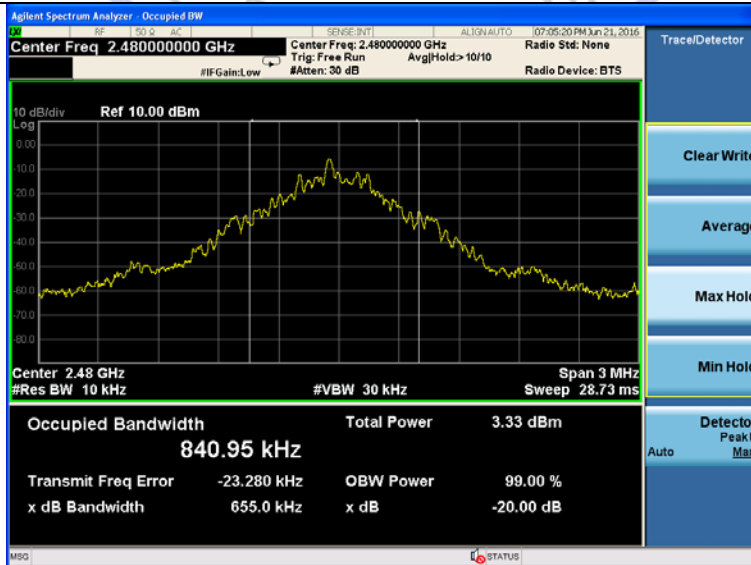

**CH78**

$\pi/4$  DQPSK Modulation

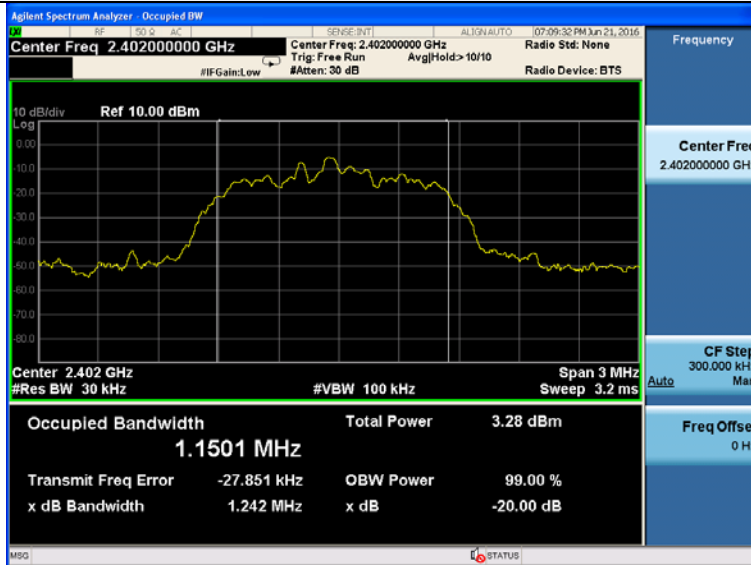

CH00

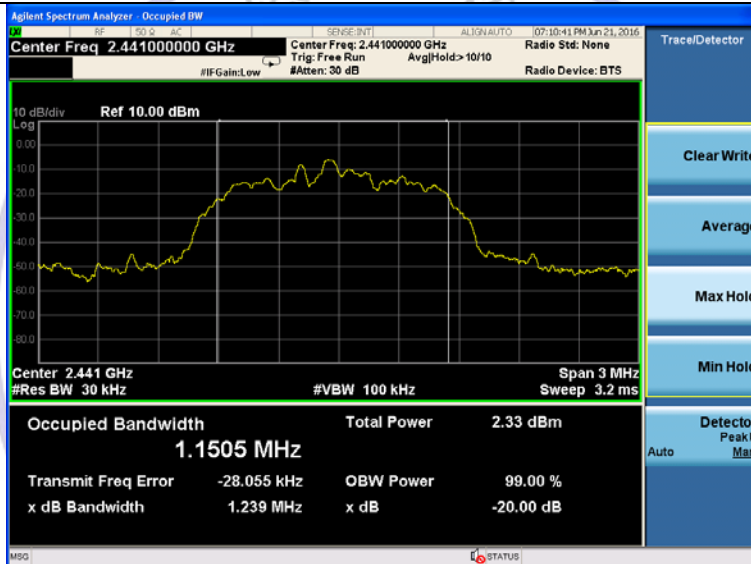

CH39

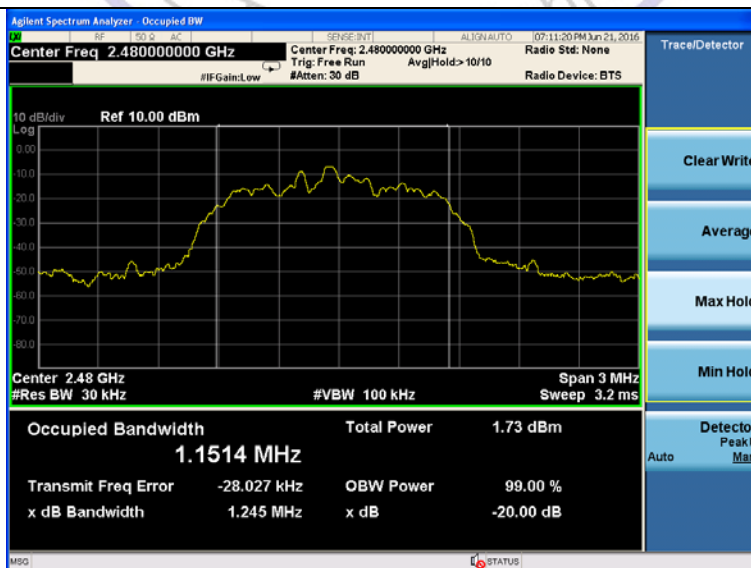

CH78

### 8DPSK Modulation



### CH00

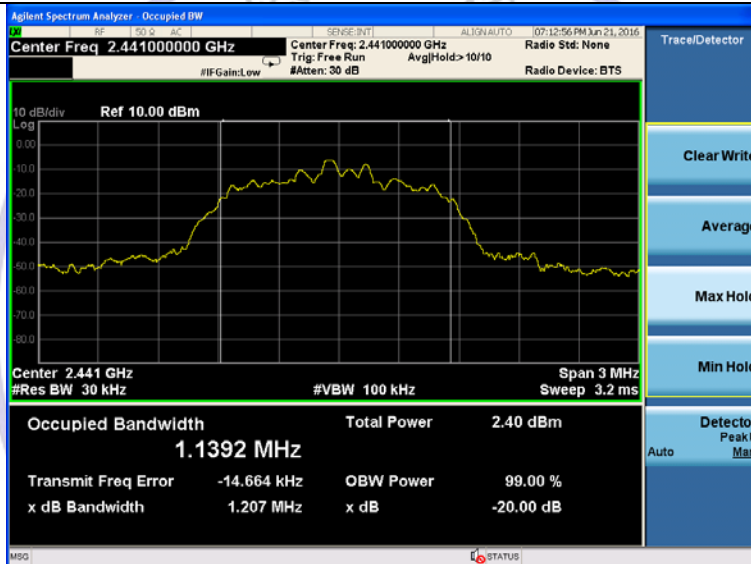

### CH39



### CH78

### 3.4. Antenna Requirement

#### Standard Applicable

For intentional device, according to FCC 47 CFR Section 15.203, an intentional radiator shall be designed to ensure that no antenna other than that furnished by the responsible party shall be used with the device.

#### **Refer to statement below for compliance.**

The manufacturer may design the unit so that the user can replace a broken antenna, but the use of a standard antenna jack or electrical connector is prohibited. Further, this requirement does not apply to intentional radiators that must be professionally installed.

#### Antenna Connected Construction

The antenna used in this product is an internal Antenna, The directional gains of antenna used for transmitting is 0dBi.

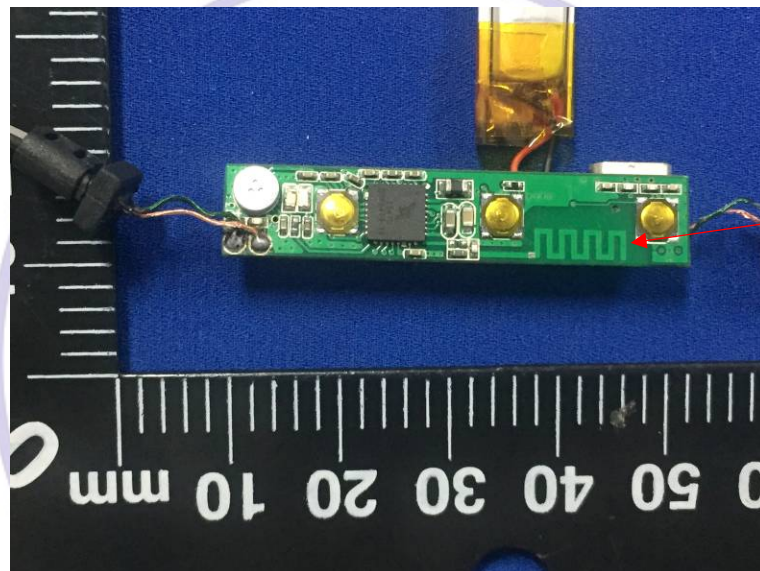

BT  
antenna

CTL Testing Technology

### 4. Test Setup Photos of the EUT

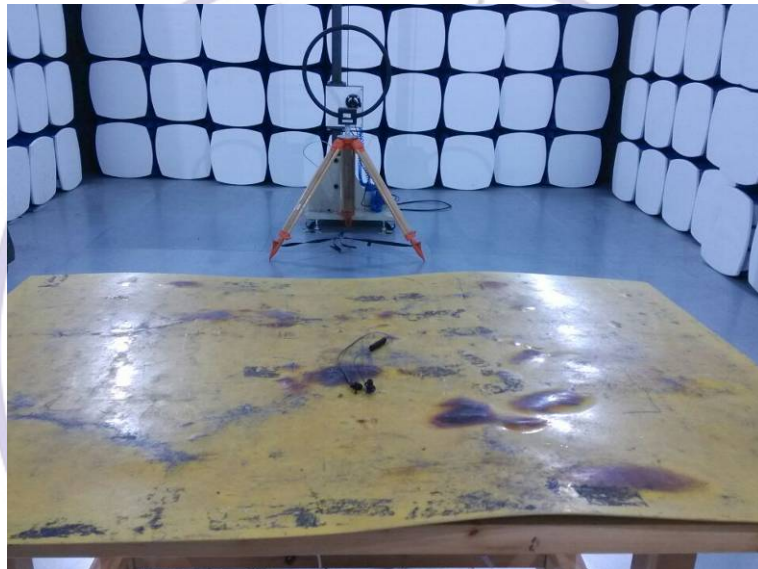



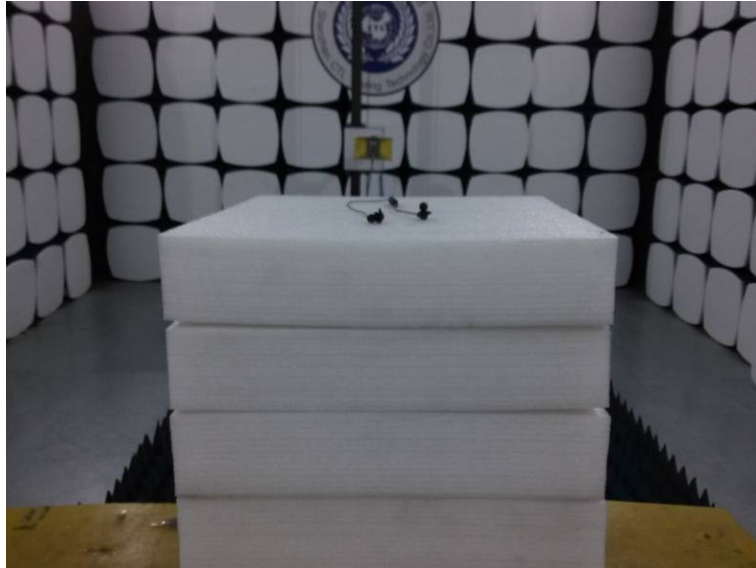

## 5. External and Internal Photos of the EUT

### External Photos of EUT



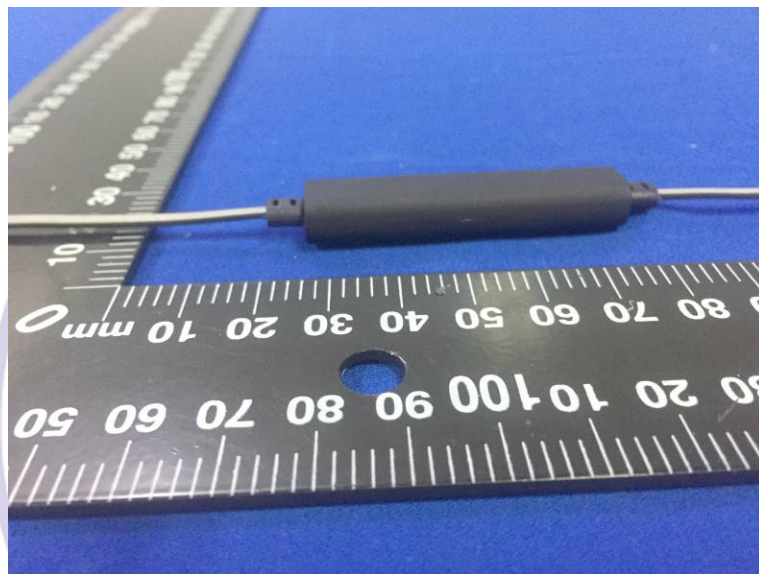
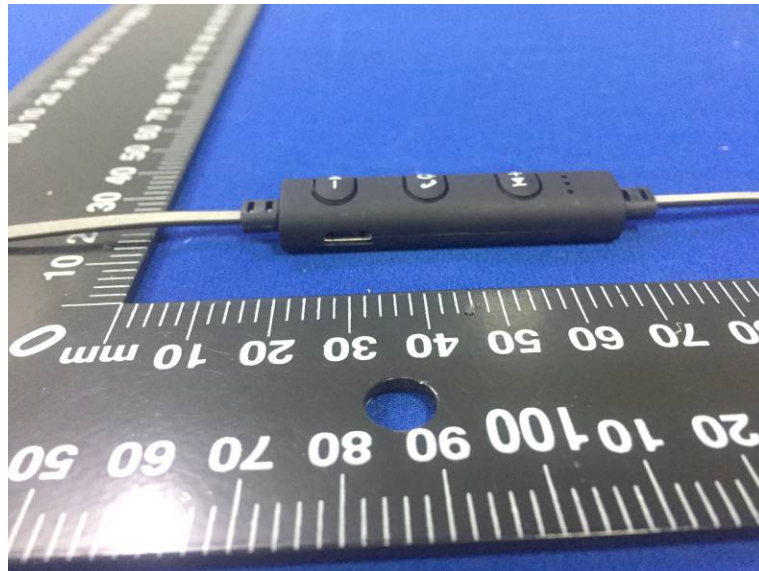





**Internal Photos of EUT**

