Antenna Test Report

Report No.: AGC08892200501PA01

PRODUCT DESIGNATION : Cronus Zen
BRAND NAME : CollectiveMinds
MODEL NAME : CM00053
APPLICANT : Collective Minds Gaming Co., Ltd
DATE OF ISSUE : May 29, 2020
REPORT VERSION : V1.0

Attestation of Global Compliance (Shenzhen) Co., Ltd

CAUTION:

This report shall not be reproduced except in full without the written permission of the test laboratory and shall not be quoted out of context.



REPORT REVISE RECORD

Report Version	Revise Time	Issued Date	Valid Version	Notes
V1.0	/	May 29, 2020	Valid	Initial release



TABLE OF CONTENTS

1. PRODUCT INFORMATON	4
2. TEST FACILITY	5
3. TEST EQUIPMENT LIST	5
4. MEASUREMENT UNCERTAINTY	5
5. TEST SUMMARY LIST	5
6. TEST SETUP	6
7. TEST RESULTS	7
7.1. VSWR.....	7
7.2. GAIN AND EFFICIENCY	8
7.3. RADIATION PATTERN.....	9
APPENDIX A: PHOTOGRAPHS OF TEST SETUP	11
APPENDIX B: PHOTOGRAPHS OF EUT	12



1. PRODUCT INFORMATION

General information	
Applicant	Collective Minds Gaming Co., Ltd
Address	5000 JEAN TALON WEST # 250, MONTREAL QUEBEC H4P 1W9, CANADA
Manufacturer	DongGuan KingSheng Electronics&Technology Co., Ltd
Address	Building 39, Arising Sun Industrial City, LinCun Village, TangXia Town, DongGuan City, China
Factory	DongGuan KingSheng Electronics&Technology Co., Ltd
Address	Building 39, Arising Sun Industrial City, LinCun Village, TangXia Town, DongGuan City, China
Product Designation	Cronus Zen
Brand Name	CollectiveMinds
Test Model	CM00053
Date of test	May 28, 2020
Report Template	AGCRT-ER-PA/V1.0
Technical information	
Frequency Range	2400-2500MHz
Test Frequencies	2400MHz, 2410MHz, 2420MHz, 2430MHz, 2440MHz, 2450MHz, 2460MHz, 2470MHz, 2480MHz, 2490MHz, 2500MHz
Antenna Type	PCB antenna
Dimensions	15mm
Impedance	50Ω
Maximum test values	Gain: 0.116dBi; Efficiency: 5.402%; VSWR: 1.159:1

The above equipment was tested by Attestation of Global Compliance (Shenzhen) Co., Ltd.
 The test results of this report relate only to the tested sample identified in this report.

Prepared By

Sky Dong

Sky Dong
 (Project Engineer)

May 28, 2020

Reviewed By

Max Zhang

Max Zhang
 (Reviewer)

May 29, 2020

Approved By

Forrest Lei

Forrest Lei
 (Authorized Officer)

May 29, 2020



2. TEST FACILITY

Test Site	Attestation of Global Compliance (Shenzhen) Co., Ltd
Location	1-2/F, Building 19, Junfeng Industrial Park, Chongqing Road, Heping Community, Fuhai Street, Bao'an District, Shenzhen, Guangdong, China

3. TEST EQUIPMENT LIST

Equipment	Manufacturer	Model	Cal. Date	Cal. Due
ANTENNA MEASUREMENT SYSTEM	ETS-Lindgren	AMS-8600	Nov. 26, 2019	Nov. 25, 2020
Network Analyzer	R&S	ZVL-6	Oct. 08, 2019	Oct. 07, 2020
Test software	ETS-Lindgren	EMQuest (Ver V1.12)	N/A	N/A

4. MEASUREMENT UNCERTAINTY

The uncertainty is calculated using the methods suggested in the "Guide to the Expression of Uncertainty in measurement" (GUM) published by CISPR and ANSI.

- Uncertainty of VSWR, $U_c = \pm 1.5\text{dB}$
- Uncertainty of Gain, $U_c = \pm 0.8\text{dB}$

5. TEST SUMMARY LIST

NO.	Test item	Remark
1	VSWR	--
2	Gain and efficiency	--
3	Radiation pattern	--



6. TEST SETUP

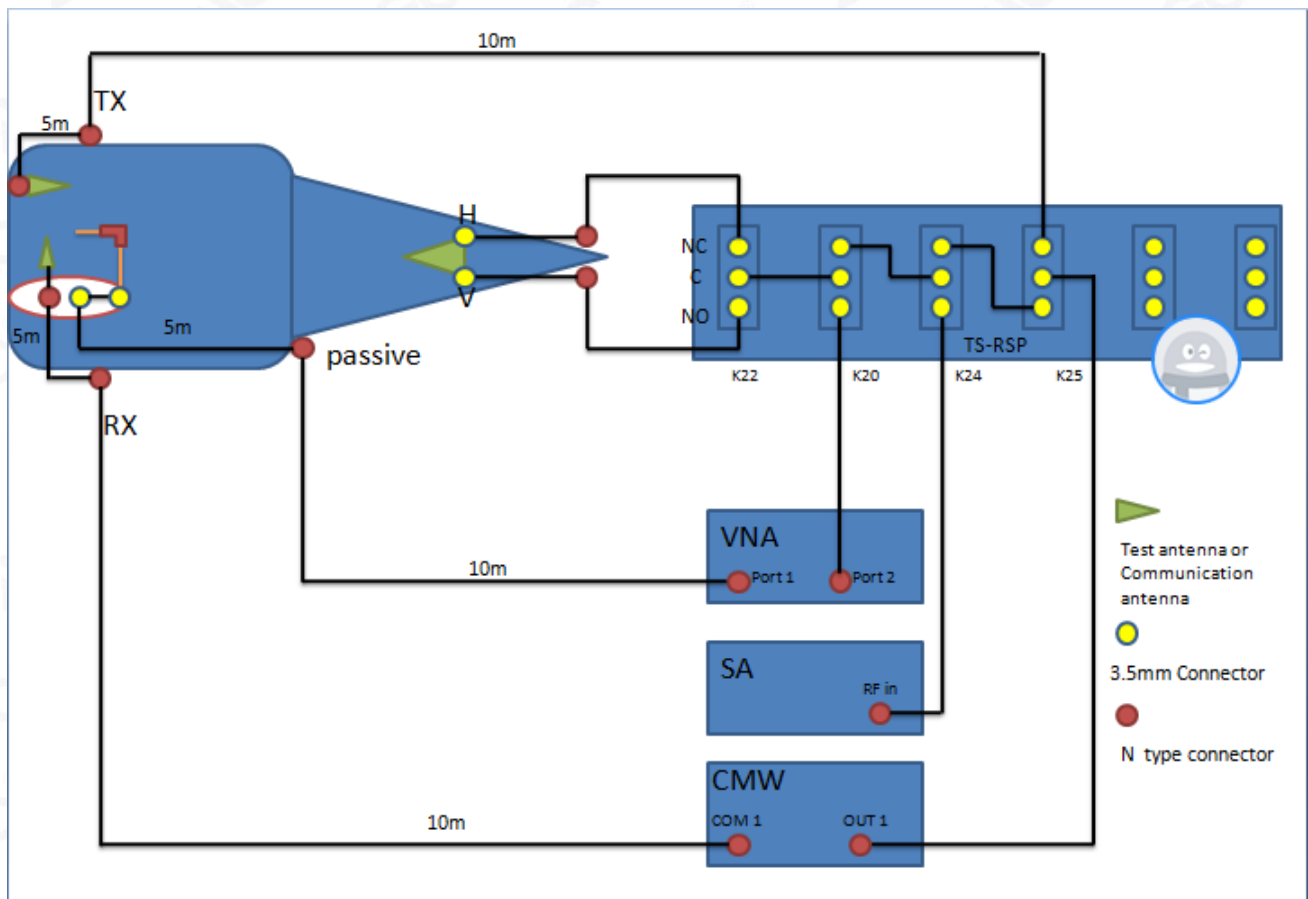
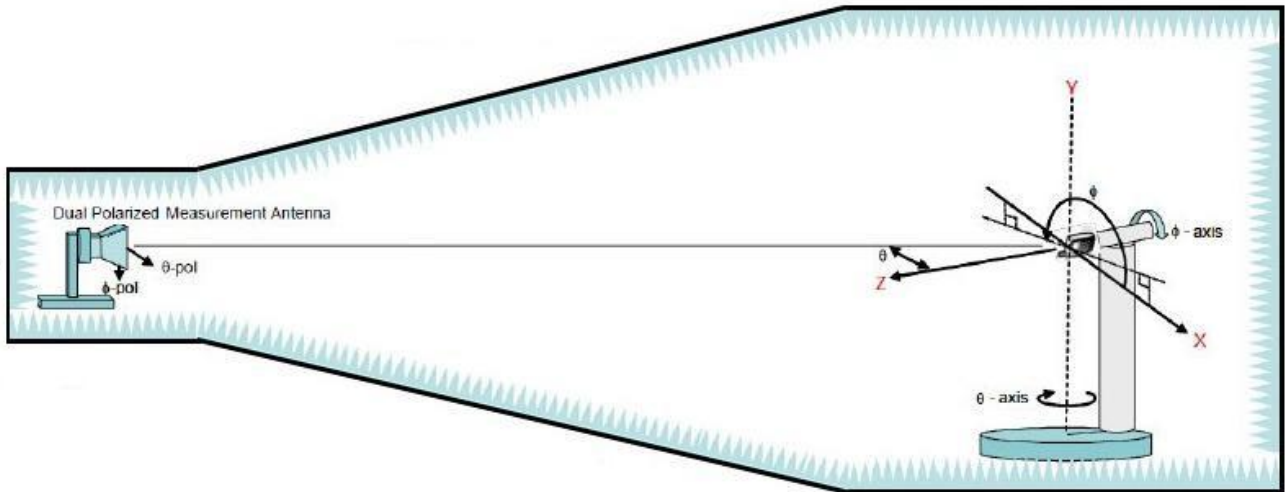

7. TEST RESULTS

7.1. VSWR

Frequency(MHz)	VSWR
2402	1:140 U
2410	1:150 U
2440	1:159 U
2450	1:147 U
2480	1:067 U

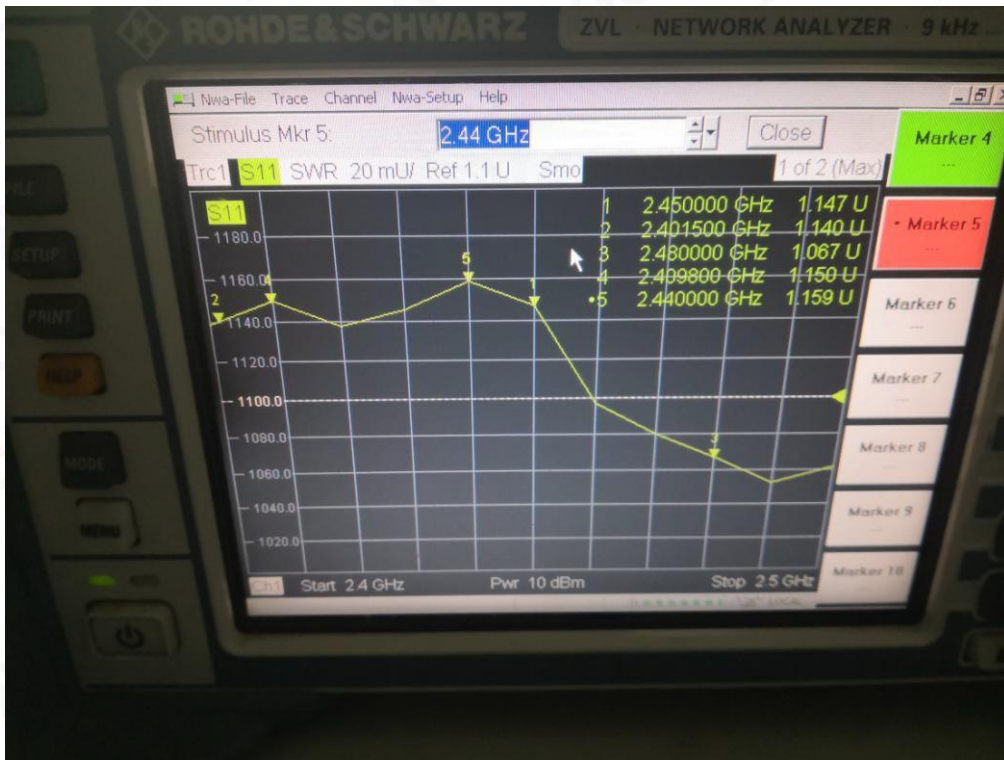

7.2. GAIN AND EFFICIENCY

Frequency(MHz)	Efficiency(dB)	Efficiency(%)	Gain(dBi)
2400	-13.410	4.559	-2.083
2410	-13.328	4.647	-1.721
2420	-13.274	4.705	-1.584
2430	-13.061	4.941	-1.224
2440	-12.927	5.096	-0.913
2450	-12.868	5.165	-0.685
2460	-12.852	5.185	-0.602
2470	-12.873	5.160	-0.523
2480	-12.674	5.402	-0.147
2490	-12.798	5.250	0.108
2500	-12.868	5.166	0.116



7.3. RADIATION PATTERN

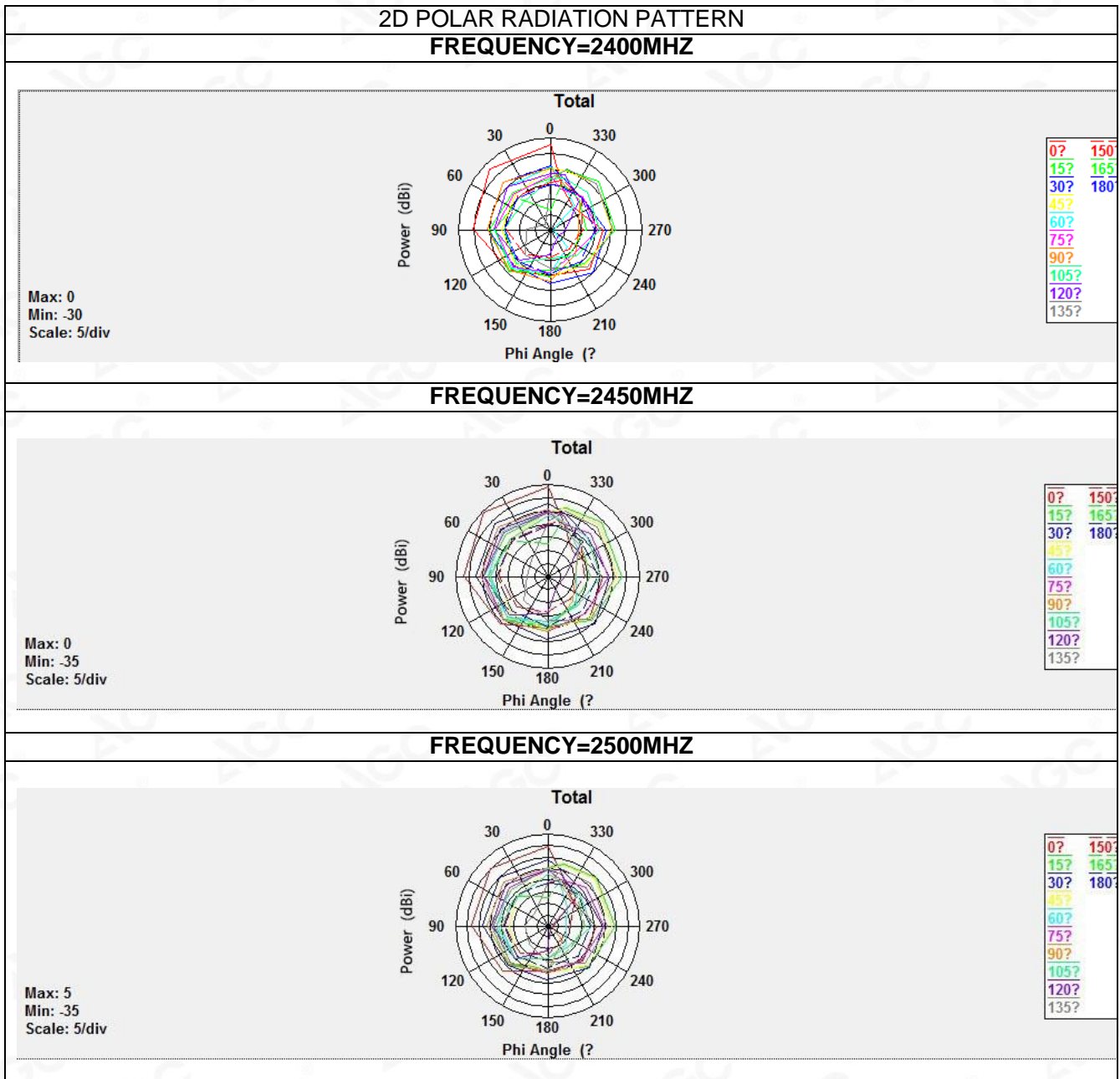

3D RADIATION PATTERN
FREQUENCY=2400MHZ

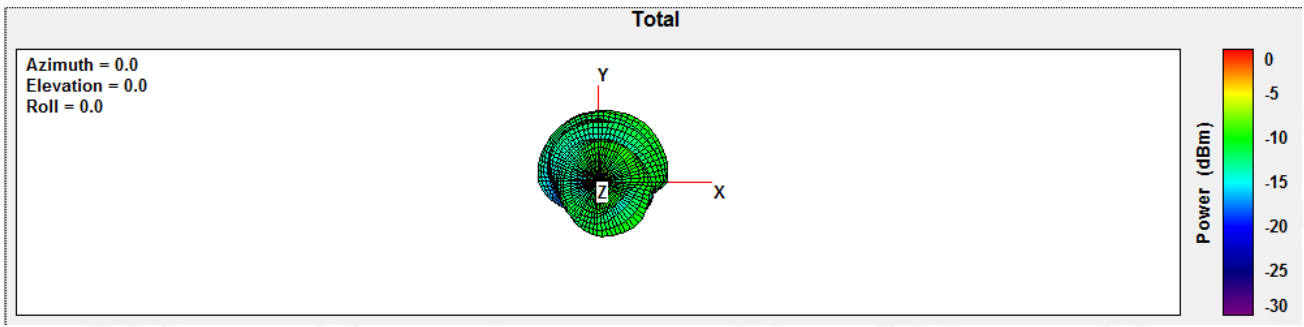

FREQUENCY=2450MHZ

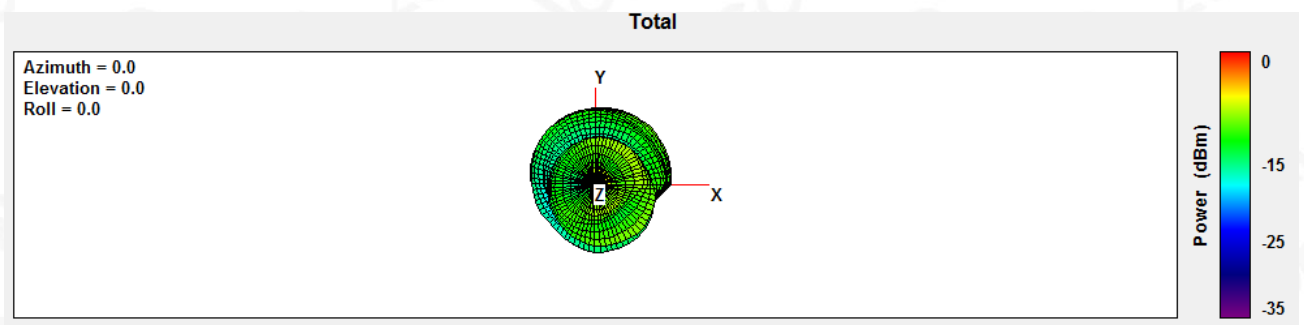

FREQUENCY=2500MHZ

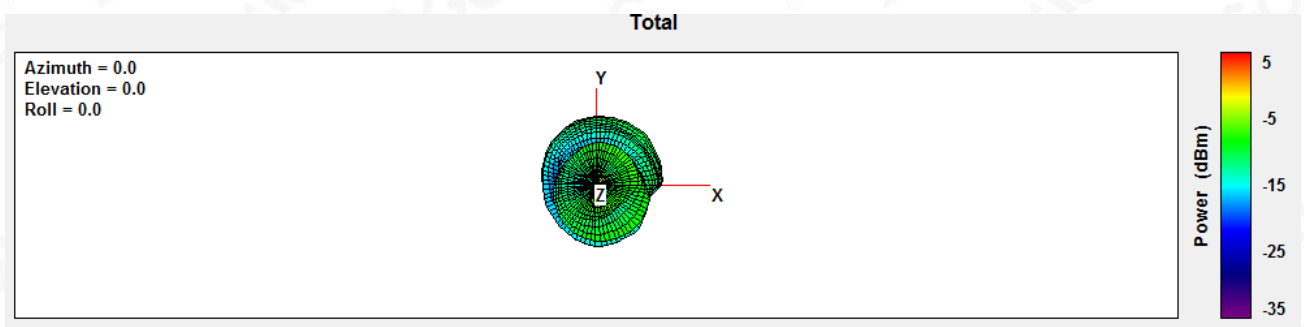

APPENDIX A: PHOTOGRAPHS OF TEST SETUP

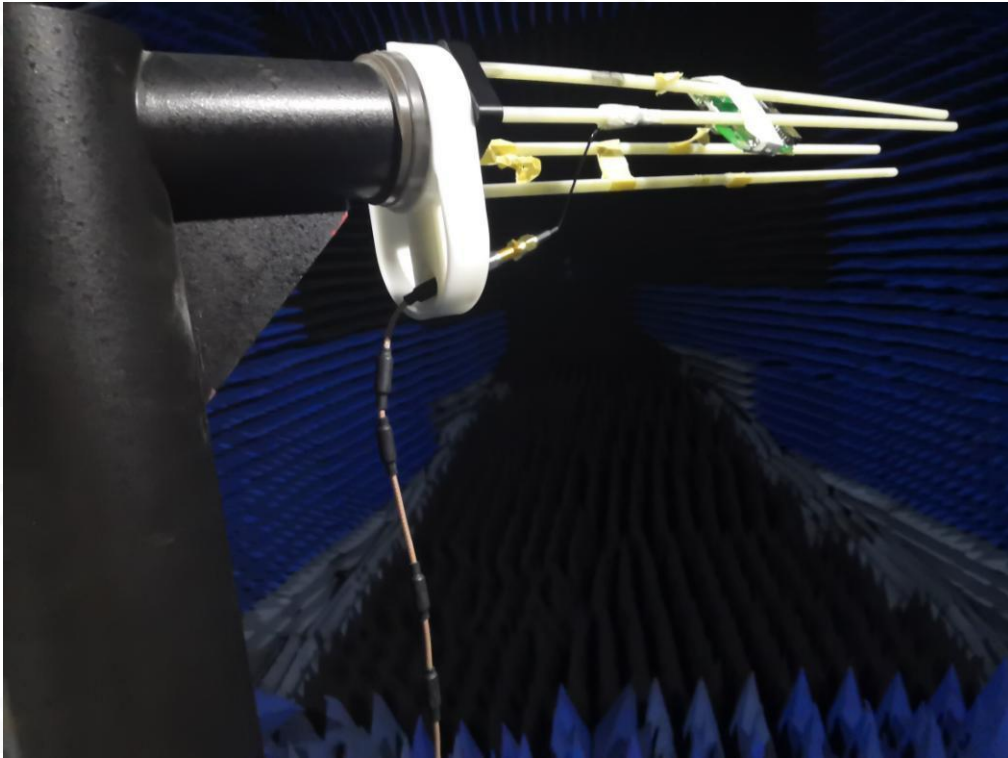

APPENDIX B: PHOTOGRAPHS OF EUT

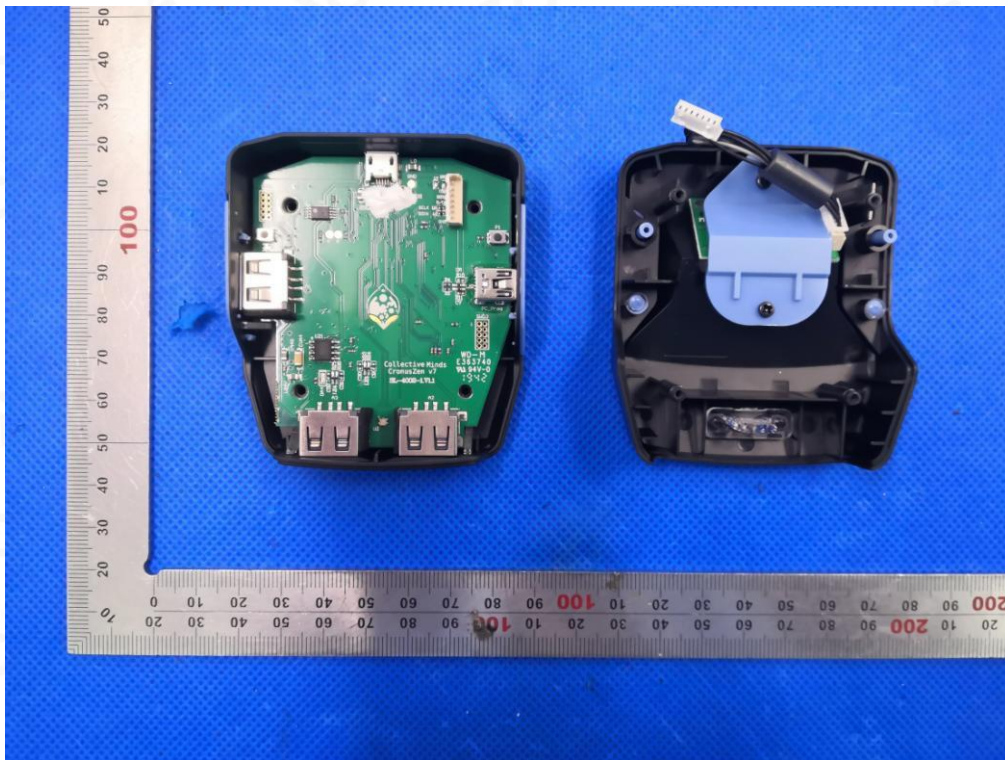

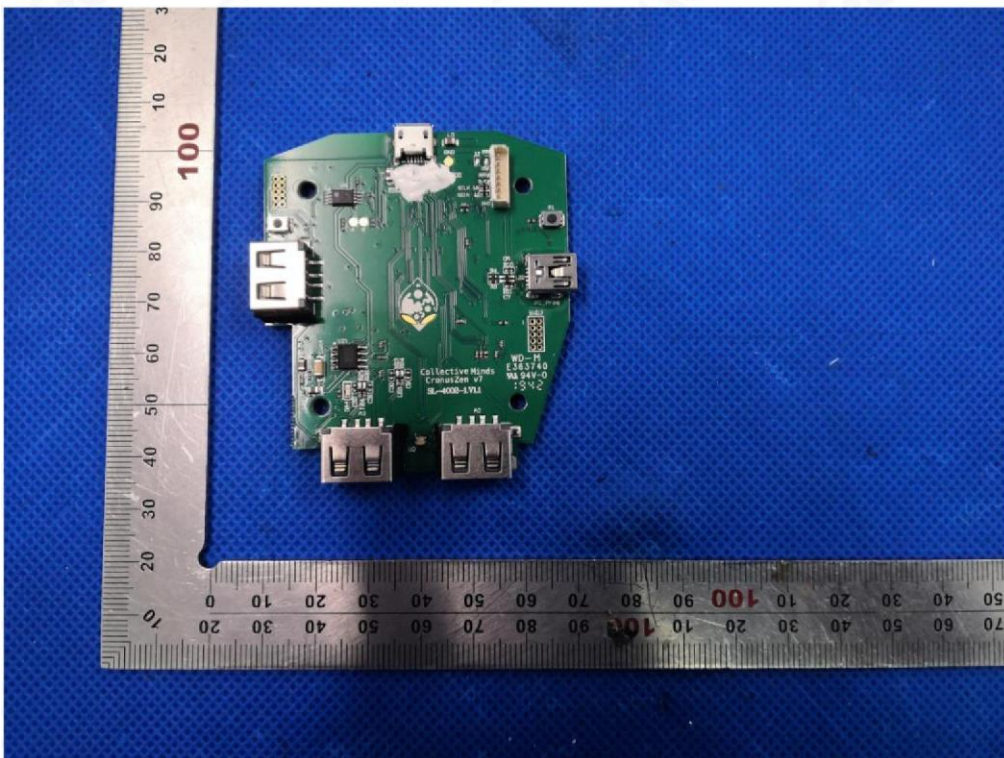
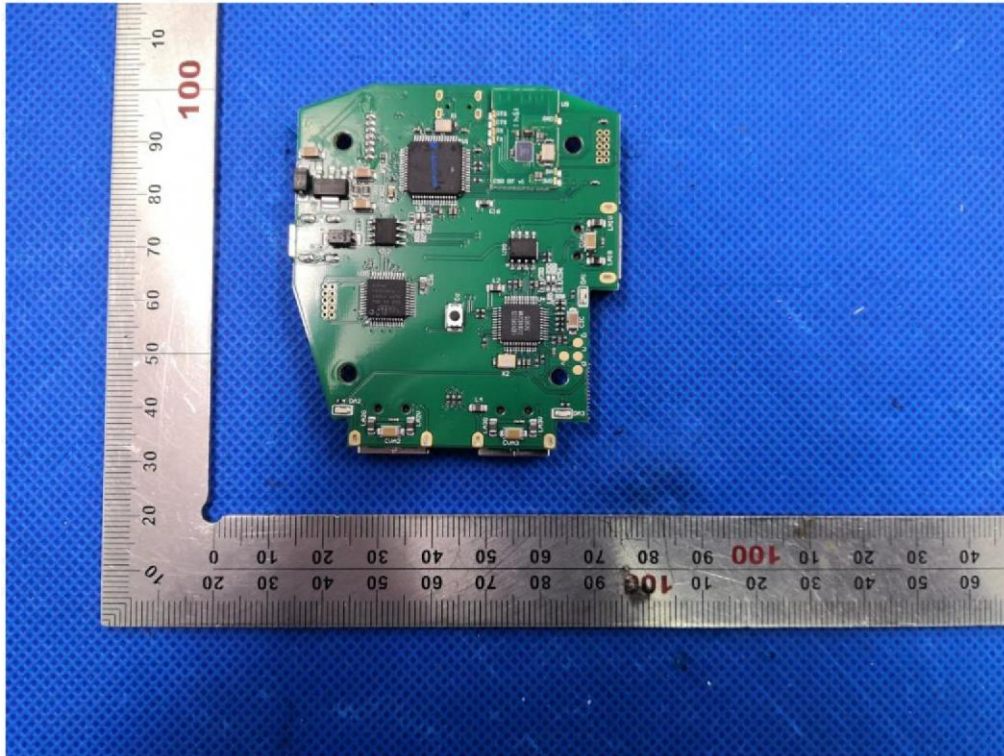

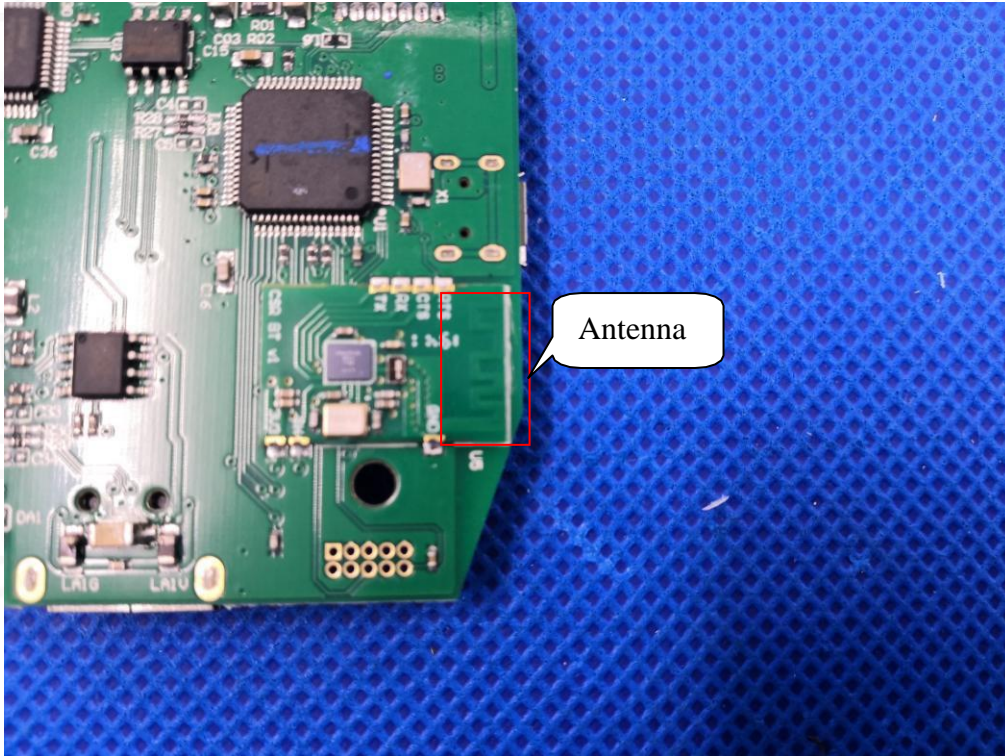

----END OF REPORT----

