



SELFIE RING LIGHT

AGES
12+

CONTENTS

- Circular Base
- Telescoping rod w/selfie light & device mount
- USB power cable (connected to circular base and telescoping rod)
- Bluetooth® remote with strap
- CR2032 3V lithium battery (installed in remote)

FEATURES

- 10 different light colors including warm, cool, and neutral white lights
- USB cable (6 ft.)
- Telescoping stand – 28 in. to 58 in.
- 180 degree of light rotation for different angles
- Lighting can be used with or without a device

ASSEMBLY

1. Remove all components from the box and remove any excess packaging material.

2. Place the circular base flat on the floor with the threaded opening pointing up.

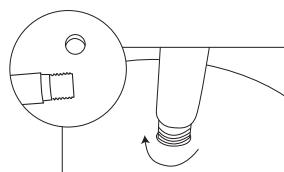

3. Secure the telescoping rod by threading it into the base and rotating clockwise until it is fully flush and will no longer rotate. Please note that the power cable may protrude from the bottom of the rod making it difficult to secure it to the base. The telescoping rod can be extended slightly which will retract the cable making securing the rod to the base easier.

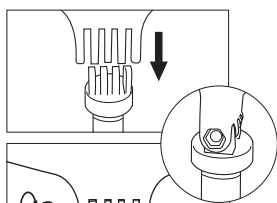

4. Mount the large circular selfie light to the top of the stand. The vertical slats will go in between those on the stand. Remove the bolt from the large plastic adjustment knob and insert it on the end with the hexagonal opening. Tighten and secure the selfie light to the stand by threading the large plastic adjustment knob on to the free end of the bolt clockwise until tight. This connection can be loosened when adjusting the angle of the selfie light and then tightened again to hold it in place.

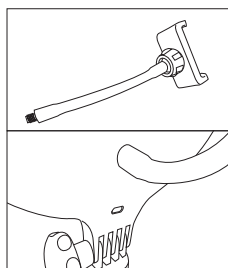

5. Attach the device mount to the back of the selfie light by threading it clockwise until tight.

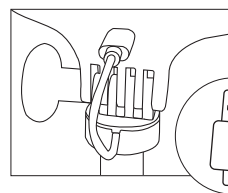

6. Secure the USB C male plug into the back of the selfie light.

7. Take the USB A male plug extending from the base and insert into a USB wall adapter. For best performance, use a 5V, 2A USB wall adapter. Plug the adapter into a wall outlet to power the Selfie Ring Light.

USING YOUR SELFIE RING LIGHT

1. To make the selfie light taller, extend the telescoping rod by gently pulling on the base of the selfie ring light. It may help to place your foot on the base as you extend the rod to prevent it from moving around.

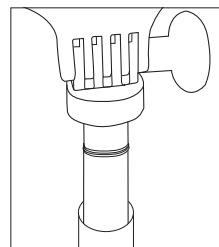

2. To adjust the angle of the light, loosen the large knob directly under the selfie light. Position the light at the desired angle, and then tighten the knob to hold it in place.
3. Place your device in the retractable device holder in the middle of the selfie light. This holder is spring loaded. Pull it apart and slide your device inside. Your phone is now secure.
4. Adjust your phone orientation and position inside the light by moving the holder to the desired position.

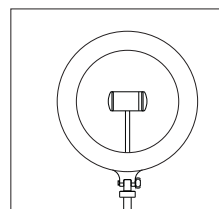

USING THE WIRELESS REMOTE

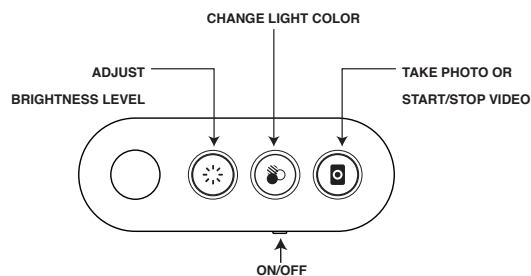

1. There are 10 brightness levels. They can be toggled through pressing the ADJUST BRIGHTNESS button.
2. There are 3 natural light settings (warm, cool, neutral) along with color light options. They can be toggled through by pressing the CHANGE LIGHT COLOR button.
3. To control your device's camera function wirelessly, you will need to connect your phone to the Bluetooth® Wireless remote:
 - a. Ensure the remote is turned on.
 - b. Ensure your device's Bluetooth® is enabled and on.
 - c. Search for the name "SelfieRingLight" in your Bluetooth® menu and select it.
 - d. Your phone is now connected to the Bluetooth® remote.
4. Switch on your device's camera function and set to photo or video.
5. The CAMERA button on the remote will now allow you to take either photos or start and stop your video camera.
6. To switch the light off, press and hold the ADJUST BRIGHTNESS button.

FCC STATEMENTS

Warning: Changes or modifications to this unit not expressly approved by the party responsible for compliance could void the user's authority to operate the equipment.

NOTE: This equipment has been tested and found to comply with the limits for a Class B digital device, pursuant to Part 15 of the FCC Rules. These limits are designed to provide reasonable protection against harmful interference in a residential installation. This equipment generates, uses and can radiate radio frequency energy and, if not installed and used in accordance with the instructions, may cause harmful interference to radio communications.

However, there is no guarantee that interference will not occur in a particular installation. If this equipment does cause harmful interference to radio or television reception, which can be determined by turning the equipment off and on, the user is encouraged to try to correct the interference by one or more of the following measures:

- Reorient or relocate the receiving antenna.
- Increase the separation between the equipment and receiver.
- Connect the equipment into an outlet on a circuit different from that to which the receiver is connected.
- Consult the dealer or an experienced radio/TV technician for help

The device must not be co-located or operating in conjunction with any other antenna or transmitter. The device has been evaluated to meet general RF exposure requirement. The device can be used in portable exposure condition without restriction.

SAFETY WARNINGS: PLEASE READ BEFORE USE

- This is not a children's product. Keep out of reach of children.
- Product is not designed for all weather use. Keep away from moisture and extreme temperatures.
- This item has no user serviceable components. Do not disassemble.
- Do not use for anything other than its intended purpose.
- Inspect the product before every use. If the product appears worn, frayed, cracked, or broken in any manner, discontinue use and discard immediately.

WARNING: This product contains a Button or Coin Cell Battery.

A swallowed Button or Coin Cell Battery can cause internal chemical burns in as little as two hours and lead to death. Dispose of used batteries immediately. Keep new and used batteries away from children. If you think batteries might have been swallowed or placed inside any part of the body, seek immediate medical attention.

WARNING:

Not intended for anyone under 14 years.
Caution: Contains small parts which can pose a choking hazard. Keep out of reach of children.

WARNING:

Contains Button or Coin Cell Battery.
Hazardous if swallowed, see instructions.

FAO® and FAO Schwarz® names and logos are trademarks or registered trademarks.

All rights reserved. www.fao.com

Distributed by and © 2021 MerchSource, LLC. Irvine, CA 92618.

For customer support please call 1-888-987-6533.

Printed in China

KEEP THIS INSTRUCTION MANUAL AS IT CONTAINS IMPORTANT INFORMATION FOR FUTURE REFERENCE.
Due to continuous product improvements, the pictures on this manual may differ slightly from the actual product.



SELFIE RING LIGHT

AGES
12+

CONTENTS

- Circular Base
- Telescoping rod w/selfie light & device mount
- USB power cable (connected to circular base and telescoping rod)
- Bluetooth® remote with strap
- CR2032 3V lithium battery (installed in remote)

FEATURES

- 10 different light colors including warm, cool, and neutral white lights
- USB cable (6 ft.)
- Telescoping stand – 28 in. to 58 in.
- 180 degree of light rotation for different angles
- Lighting can be used with or without a device

ASSEMBLY

1. Remove all components from the box and remove any excess packaging material.

2. Place the circular base flat on the floor with the threaded opening pointing up.

3. Secure the telescoping rod by threading it into the base and rotating clockwise until it is fully flush and will no longer rotate. Please note that the power cable may protrude from the bottom of the rod making it difficult to secure it to the base. The telescoping rod can be extended slightly which will retract the cable making securing the rod to the base easier.

4. Mount the large circular selfie light to the top of the stand. The vertical slats will go in between those on the stand. Remove the bolt from the large plastic adjustment knob and insert it on the end with the hexagonal opening. Tighten and secure the selfie light to the stand by threading the large plastic adjustment knob on to the free end of the bolt clockwise until tight. This connection can be loosened when adjusting the angle of the selfie light and then tightened again to hold it in place.

5. Attach the device mount to the back of the selfie light by threading it clockwise until tight.

6. Secure the USB C male plug into the back of the selfie light.

7. Take the USB A male plug extending from the base and insert into a USB wall adapter. For best performance, use a 5V, 2A USB wall adapter. Plug the adapter into a wall outlet to power the Selfie Ring Light.

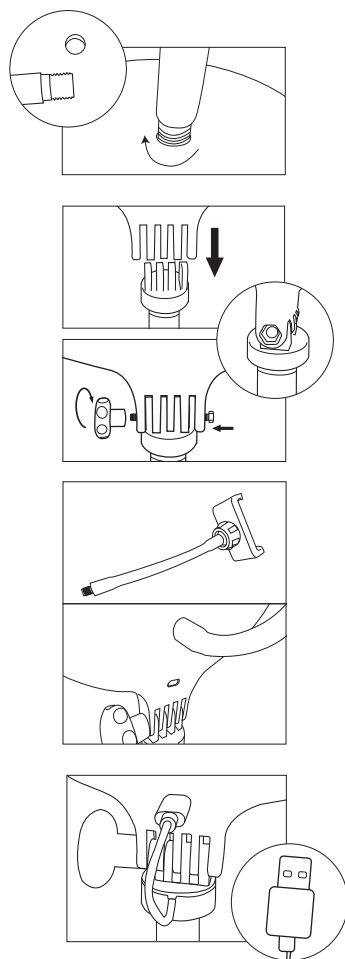

USING YOUR SELFIE RING LIGHT

1. To make the selfie light taller, extend the telescoping rod by gently pulling on the base of the selfie ring light. It may help to place your foot on the base as you extend the rod to prevent it from moving around.

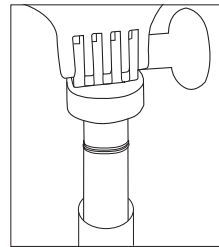

2. To adjust the angle of the light, loosen the large, knob directly under the selfie light.

Position the light at the desired angle, and then tighten the knob to hold it in place.

3. Place your device in the retractable device holder in the middle of the selfie light. This holder is spring loaded. Pull it apart and slide your device inside. Your phone is now secure.

4. Adjust your phone orientation and position inside the light by moving the holder to the desired position.

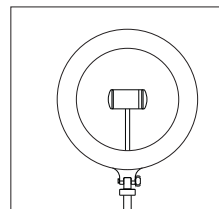

USING THE WIRELESS REMOTE

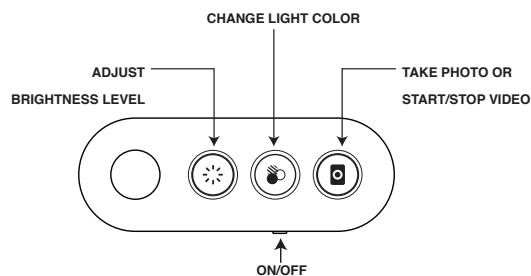

1. There are 10 brightness levels. They can be toggled through pressing the ADJUST BRIGHTNESS button.
2. There are 3 natural light settings (warm, cool, neutral) along with color light options. They can be toggled through by pressing the CHANGE LIGHT COLOR button.
3. To control your device's camera function wirelessly, you will need to connect your phone to the Bluetooth® Wireless remote:
 - a. Ensure the remote is turned on.
 - b. Ensure your device's Bluetooth® is enabled and on.
 - c. Search for the name "SelfieRingLight" in your Bluetooth® menu and select it.
 - d. Your phone is now connected to the Bluetooth® remote.
4. Switch on your device's camera function and set to photo or video.
5. The CAMERA button on the remote will now allow you to take either photos or start and stop your video camera.

FCC STATEMENTS

Warning: Changes or modifications to this unit not expressly approved by the party responsible for compliance could void the user's authority to operate the equipment.

NOTE: This equipment has been tested and found to comply with the limits for a Class B digital device, pursuant to Part 15 of the FCC Rules. These limits are designed to provide reasonable protection against harmful interference in a residential installation. This equipment generates, uses and can radiate radio frequency energy and, if not installed and used in accordance with the instructions, may cause harmful interference to radio communications.

However, there is no guarantee that interference will not occur in a particular installation. If this equipment does cause harmful interference to radio or television reception, which can be determined by turning the equipment off and on, the user is encouraged to try to correct the interference by one or more of the following measures:

- Reorient or relocate the receiving antenna.
- Increase the separation between the equipment and receiver.
- Connect the equipment into an outlet on a circuit different from that to which the receiver is connected.
- Consult the dealer or an experienced radio/TV technician for help

The device must not be co-located or operating in conjunction with any other antenna or transmitter.

The device has been evaluated to meet general RF exposure requirement. The device can be used in portable exposure condition without restriction.

SAFETY WARNINGS: PLEASE READ BEFORE USE

- This is not a children's product. Keep out of reach of children.
- Product is not designed for all weather use. Keep away from moisture and extreme temperatures.
- This item has no user serviceable components. Do not disassemble.
- Do not use for anything other than its intended purpose.
- Inspect the product before every use. If the product appears worn, frayed, cracked, or broken in any manner, discontinue use and discard immediately.

WARNING: This product contains a Button or Coin Cell Battery.

A swallowed Button or Coin Cell Battery can cause internal chemical burns in as little as two hours and lead to death. Dispose of used batteries immediately. Keep new and used batteries away from children. If you think batteries might have been swallowed or placed inside any part of the body, seek immediate medical attention.

WARNING:

Not intended for anyone under 14 years.
Caution: Contains small parts which can pose a choking hazard. Keep out of reach of children.

WARNING:

Contains Button or Coin Cell Battery.
Hazardous if swallowed, see instructions.