



FCC RF Test Report

APPLICANT : Ring LLC
EQUIPMENT : Spotlight Cam Plus
BRAND NAME : Ring
MODEL NAME : 5E82E9
FCC ID : 2AEUPBHASL001
STANDARD : FCC Part 15 Subpart C §15.247
CLASSIFICATION : (DTS) Digital Transmission System
TEST DATE(S) : Jun. 23, 2022 ~ Jul. 23, 2022

We, Sporton International Inc. (Kunshan), would like to declare that the tested sample has been evaluated in accordance with the test procedures and has been in compliance with the applicable technical standards.

The test results in this report apply exclusively to the tested model / sample. Without written approval of Sporton International Inc. (Kunshan), the test report shall not be reproduced except in full.

Jason Jia



Approved by: Jason Jia

Sporton International Inc. (Kunshan)

**No. 1098, Pengxi North Road, Kunshan Economic Development Zone Jiangsu Province 215300
People's Republic of China**



TABLE OF CONTENTS

REVISION HISTORY..... 3

SUMMARY OF TEST RESULT 4

1 GENERAL DESCRIPTION..... 5

 1.1 Applicant 5

 1.2 Manufacturer 5

 1.3 Product Feature of Equipment Under Test..... 5

 1.4 Product Specification of Equipment Under Test..... 5

 1.5 Modification of EUT 5

 1.6 Testing Location 6

 1.7 Test Software 6

 1.8 Applicable Standards..... 6

2 TEST CONFIGURATION OF EQUIPMENT UNDER TEST..... 7

 2.1 Carrier Frequency Channel 7

 2.2 Test Mode 8

 2.3 Connection Diagram of Test System 9

 2.4 Support Unit used in test configuration and system 10

 2.5 EUT Operation Test Setup 11

 2.6 Measurement Results Explanation Example..... 11

3 TEST RESULT 12

 3.1 6dB and 99% Bandwidth Measurement 12

 3.2 Output Power Measurement..... 13

 3.3 Power Spectral Density Measurement 14

 3.4 Conducted Band Edges and Spurious Emission Measurement 15

 3.5 Radiated Band Edges and Spurious Emission Measurement 16

 3.6 AC Conducted Emission Measurement..... 20

 3.7 Antenna Requirements 22

4 LIST OF MEASURING EQUIPMENT 23

5 UNCERTAINTY OF EVALUATION..... 24

APPENDIX A. CONDUCTED TEST RESULTS

APPENDIX B. AC CONDUCTED EMISSION TEST RESULT

APPENDIX C. RADIATED SPURIOUS EMISSION

APPENDIX D. DUTY CYCLE PLOTS

APPENDIX E. SETUP PHOTOGRAPHS



SUMMARY OF TEST RESULT

Report Section	FCC Rule	Description	Limit	Result	Remark
3.1	15.247(a)(2)	6dB Bandwidth	≥ 0.5MHz	Pass	-
3.1	-	99% Bandwidth	-	Report only	-
3.2	15.247(b)(3)	Peak Output Power	≤ 30dBm	Pass	-
3.3	15.247(e)	Power Spectral Density	≤ 8dBm/3kHz	Pass	-
3.4	15.247(d)	Conducted Band Edges and Spurious Emission	≤ 20dBc	Pass	-
3.5	15.247(d)	Radiated Band Edges and Spurious Emission	15.209(a) & 15.247(d)	Pass	Under limit 5.64 dB at 2483.500 MHz
3.6	15.207	AC Conducted Emission	15.207(a)	Pass	Under limit 8.57 dB at 0.255 MHz
3.7	15.203 & 15.247(b)	Antenna Requirement	15.203 & 15.247(b)	Pass	-

Declaration of Conformity:
The test results with all measurement uncertainty excluded are presented in accordance with the regulation limits or requirements declared by manufacturers.
Comments and Explanations:
The declared of product specification for EUT presented in the report are provided by the manufacturer, and the manufacturer takes all the responsibilities for the accuracy of product specification.



1 General Description

1.1 Applicant

Ring LLC
12515 Cerise Ave, Hawthorne, CA 90250 USA

1.2 Manufacturer

Goertek Inc.
No.268 Dongfang Road High-Tech Industrial Development District, Weifang Shandong, China

1.3 Product Feature of Equipment Under Test

Product Feature	
Equipment	Spotlight Cam Plus
Brand Name	Ring
Model Name	5E82E9
FCC ID	2AEUPBHASL001
SN	Radiation: G9D1UL032203001H Conducted: G9D1UL0322030019 Conduction: G9D1UL0322020008
HW Version	309000143062R0
SW Version	1.3.10500
EUT Stage	Production Unit

Remark: The above EUT's information was declared by manufacturer. Please refer to the specifications or user's manual for more detailed description.

1.4 Product Specification of Equipment Under Test

Standards-related Product Specification	
Tx/Rx Frequency Range	2402 MHz ~ 2480 MHz
Number of Channels	40
Carrier Frequency of Each Channel	40 Channel(37 hopping + 3 advertising channel)
Maximum Output Power to Antenna	Bluetooth LE 1Mbps: 3.86 dBm (0.0024 W)
99% Occupied Bandwidth	Bluetooth LE 1Mbps: 1.055 MHz
Antenna Type / Gain	PIFA Antenna type with gain 0.9 dBi
Type of Modulation	Bluetooth LE : GFSK

Note: The device supports for BLE data rate 1Mbps only.

1.5 Modification of EUT

No modifications are made to the EUT during all test items.



1.6 Testing Location

Sporton International Inc. (Kunshan) is accredited to ISO/IEC 17025:2017 by American Association for Laboratory Accreditation with Certificate Number 5145.02.

Test Firm	Sporton International Inc. (Kunshan)		
Test Site Location	No. 1098, Pengxi North Road, Kunshan Economic Development Zone Jiangsu Province 215300 People’s Republic of China TEL : +86-512-57900158 FAX : +86-512-57900958		
Test Site No.	Sporton Site No.	FCC Designation No.	FCC Test Firm Registration No.
	CO01-KS 03CH08-KS TH01-KS	CN1257	314309

1.7 Test Software

Item	Site	Manufacturer	Name	Version
1.	03CH08-KS	AUDIX	E3	6.2009-8-24al
2.	CO01-KS	AUDIX	E3	6.2009-8-24

1.8 Applicable Standards

According to the specifications of the manufacturer, the EUT must comply with the requirements of the following standards:

- 47 CFR Part 15 Subpart C §15.247
- FCC KDB 558074 D01 15.247 Meas Guidance v05r02
- ANSI C63.10-2013

Remark:

1. All test items were verified and recorded according to the standards and without any deviation during the test.
2. This EUT has also been tested and complied with the requirements of FCC Part 15, Subpart B, recorded in a separate test report.



2 Test Configuration of Equipment Under Test

2.1 Carrier Frequency Channel

Frequency Band	Channel	Freq. (MHz)	Channel	Freq. (MHz)
2400-2483.5 MHz	0	2402	21	2444
	1	2404	22	2446
	2	2406	23	2448
	3	2408	24	2450
	4	2410	25	2452
	5	2412	26	2454
	6	2414	27	2456
	7	2416	28	2458
	8	2418	29	2460
	9	2420	30	2462
	10	2422	31	2464
	11	2424	32	2466
	12	2426	33	2468
	13	2428	34	2470
	14	2430	35	2472
	15	2432	36	2474
	16	2434	37	2476
	17	2436	38	2478
	18	2438	39	2480
	19	2440	-	-
20	2442	-	-	



2.2 Test Mode

- a. The EUT has been associated with peripherals and configuration operated in a manner tended to maximize its emission characteristics in a typical application. Frequency range investigated: conduction emission (150 kHz to 30 MHz), radiation emission (9 kHz to the 10th harmonic of the highest fundamental frequency or to 40 GHz, whichever is lower). For radiated measurement, pre-scanned in three orthogonal panels, X, Y, Z. The worst cases (Y plane) were recorded in this report.
- b. AC power line Conducted Emission was tested under maximum output power.

The following summary table is showing all test modes to demonstrate in compliance with the standard.

Summary table of Test Cases	
Test Item	Data Rate / Modulation
	Bluetooth LE / GFSK
Conducted TCs	Mode 1: Bluetooth Tx CH00_2402 MHz_1Mbps Mode 2: Bluetooth Tx CH19_2440 MHz_1Mbps Mode 3: Bluetooth Tx CH39_2480 MHz_1Mbps
Radiated TCs	Mode 1: Bluetooth Tx CH00_2402 MHz_1Mbps Mode 2: Bluetooth Tx CH19_2440 MHz_1Mbps Mode 3: Bluetooth Tx CH39_2480 MHz_1Mbps
AC Conducted Emission	Mode 1: Lora Tx + Bluetooth Link + WLAN Link(2.4G) + Battery 3 + Adapter
Remark: 1. The accessories are chosen from Part 15B worst cases. 2. For Radiated Test Cases, The tests were performance with Adapter and Battery 1.	

2.3 Connection Diagram of Test System

For AC Conducted Emission:

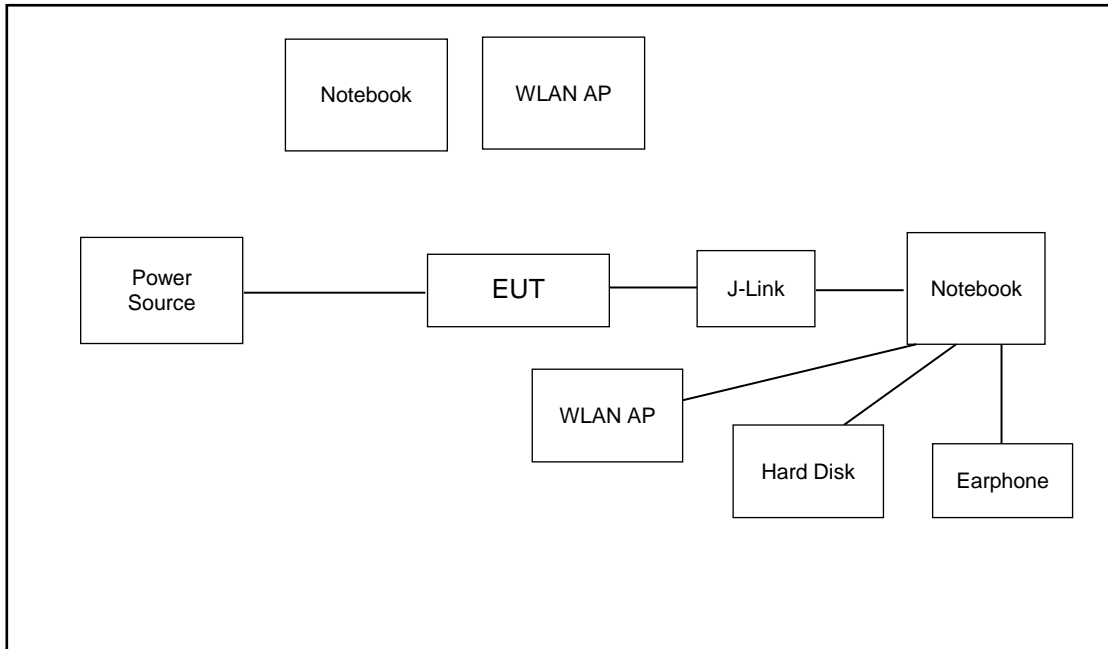

For Radiated Emission:

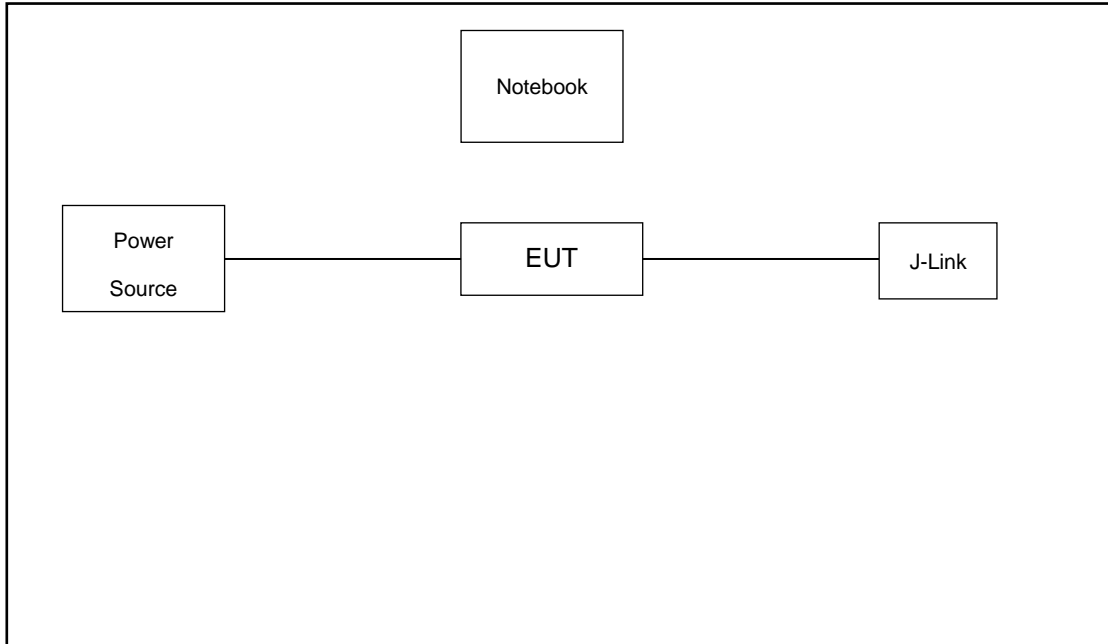



2.4 Support Unit used in test configuration and system

Item	Equipment	Trade Name	Model Name	FCC ID	Data Cable	Power Cord
1.	WLAN AP	LINKSYS	WRT1900ACSV2	N/A	N/A	Unshielded,1.8m
2.	Notebook	Honor	Magicbook 16	N/A	N/A	shielded cable DC O/P 1.8m , Unshielded AC I/P cable 1.8m
3.	USB HD	Lenovo	F310	N/A	Unshielded,1.2m	N/A
4.	J-Link	N/A	N/A	N/A	N/A	N/A
5.	Earphone	Lenovo	P121	N/A	Unshielded,1.2m	N/A



2.5 EUT Operation Test Setup

For BLE function, the engineering test program was provided and enabled to make EUT continuous transmit.

For AC power line conducted emissions, the EUT was set to connect with the WLAN AP under large package sizes transmission.

2.6 Measurement Results Explanation Example

For all conducted test items:

The offset level is set in the spectrum analyzer to compensate the RF cable loss and attenuator factor between EUT conducted output port and spectrum analyzer. With the offset compensation, the spectrum analyzer reading level is exactly the EUT RF output level.

Example :

The spectrum analyzer offset is derived from RF cable loss.

Offset = attenuator factor.

Following shows an offset computation example with cable loss 5.6 dB

$$\begin{aligned} \text{Offset(dB)} &= \text{RF cable loss(dB)} \\ &= 5.6 \end{aligned}$$

3 Test Result

3.1 6dB and 99% Bandwidth Measurement

3.1.1 Limit of 6dB and 99% Bandwidth

The minimum 6 dB bandwidth shall be at least 500 kHz.

3.1.2 Measuring Instruments

The section 4.0 of List of Measuring Equipment of this test report is used for test.

3.1.3 Test Procedures

1. The testing follows ANSI C63.10-2013 clause 11.8
2. The RF output of EUT was connected to the spectrum analyzer by RF cable and attenuator. The path loss was compensated to the results for each measurement.
3. Set to the maximum power setting and enable the EUT transmit continuously.
4. Make the measurement with the spectrum analyzer's resolution bandwidth (RBW) = 100 kHz. Set the Video bandwidth (VBW) = 300 kHz. In order to make an accurate measurement. The 6 dB bandwidth must be greater than 500 kHz.
5. For 99% Bandwidth Measurement, the spectrum analyzer's resolution bandwidth (RBW) is set 1% to 5% of the 99% OBW and the VBW is set to 3 times of the RBW.
6. Measure and record the results in the test report.

3.1.4 Test Setup



3.1.5 Test Result of 6dB Bandwidth

Please refer to Appendix A.

3.1.6 Test Result of 99% Occupied Bandwidth

Please refer to Appendix A.

3.2 Output Power Measurement

3.2.1 Limit of Output Power

For systems using digital modulation in the 2400-2483.5MHz, the limit for peak output power is 30dBm. If transmitting antenna of directional gain greater than 6dBi is used, the peak output power from the intentional radiator shall be reduced below the above stated value by the amount in dB that the directional gain of the antenna exceeds 6 dBi. In case of point-to-point operation, the limit has to be reduced by 1dB for every 3dB that the directional gain of the antenna exceeds 6dBi.

3.2.2 Measuring Instruments

The section 4.0 of List of Measuring Equipment of this test report is used for test.

3.2.3 Test Procedures

1. The testing follows the Measurement Procedure of ANSI C63.10-2013 clause 11.9.1.3 PKPM1 Peak power meter or ANSI C63.10-2013 clause 11.9.2.3.1 Method AVGPM method.
2. The RF output of EUT was connected to the power meter by RF cable and attenuator. The path loss was compensated to the results for each measurement.
3. Set to the maximum power setting and enable the EUT transmit continuously.
4. Measure the conducted output power and record the results in the test report.

3.2.4 Test Setup

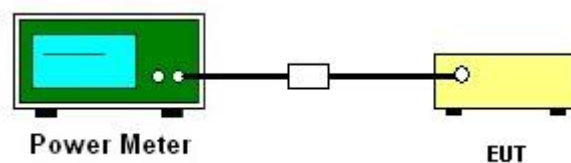

3.2.5 Test Result of Peak Output Power

Please refer to Appendix A.

3.2.6 Test Result of Average Output Power (Reporting Only)

Please refer to Appendix A.

3.3 Power Spectral Density Measurement

3.3.1 Limit of Power Spectral Density

The peak power spectral density shall not be greater than 8dBm in any 3kHz band at any time interval of continuous transmission.

3.3.2 Measuring Instruments

The section 4.0 of List of Measuring Equipment of this test report is used for test.

3.3.3 Test Procedures

1. The testing follows Measurement Procedure of ANSI C63.10-2013 clause 11.10.2 Method PKPSD.
2. The RF output of EUT was connected to the spectrum analyzer by RF cable and attenuator. The path loss was compensated to the results for each measurement.
3. Set to the maximum power setting and enable the EUT transmit continuously.
4. Make the measurement with the spectrum analyzer's resolution bandwidth (RBW) = 3 kHz. Video bandwidth VBW = 10 kHz In order to make an accurate measurement, set the span to 1.5 times DTS Channel Bandwidth. (6dB BW)
5. Detector = peak, Sweep time = auto couple, Trace mode = max hold, Allow trace to fully stabilize. Use the peak marker function to determine the maximum power level.
6. Measure and record the results in the test report.
7. The Measured power density (dBm)/ 100kHz is a reference level and used as 20dBc down limit line for Conducted Band Edges and Conducted Spurious Emission.

3.3.4 Test Setup

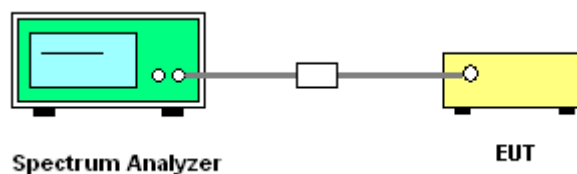

3.3.5 Test Result of Power Spectral Density

Please refer to Appendix A.

3.3.6 Test Result of Power Spectral Density Plots (100kHz)

Please refer to Appendix A.

3.3.7 Test Result of Power Spectral Density Plots (3kHz)

Please refer to Appendix A.

3.4 Conducted Band Edges and Spurious Emission Measurement

3.4.1 Limit of Conducted Band Edges and Spurious Emission

All harmonics/spurious must be at least 20 dB down from the highest emission level within the authorized band.

3.4.2 Measuring Instruments

The section 4.0 of List of Measuring Equipment of this test report is used for test.

3.4.3 Test Procedure

1. The testing follows ANSI C63.10-2013 clause 11.13
2. The RF output of EUT was connected to the spectrum analyzer by RF cable and attenuator. The path loss was compensated to the results for each measurement.
3. Set to the maximum power setting and enable the EUT transmit continuously.
4. Set RBW = 100 kHz, VBW=300 kHz, Peak Detector. Unwanted Emissions measured in any 100 kHz bandwidth outside of the authorized frequency band shall be attenuated by at least 20 dB relative to the maximum in-band peak PSD level in 100 kHz when maximum peak conducted output power procedure is used. If the transmitter complies with the conducted power limits based on the use of RMS averaging over a time interval, the attenuation required under this paragraph shall be 30 dB instead of 20 dB.
5. Measure and record the results in the test report.
6. The RF fundamental frequency should be excluded against the limit line in the operating frequency band.

3.4.4 Test Setup

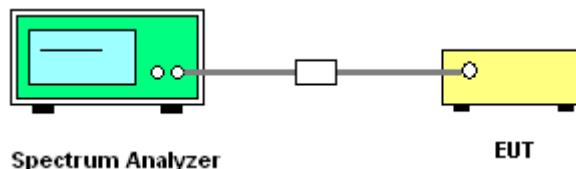

3.4.5 Test Result of Conducted Band Edges Plots

Please refer to Appendix A.



3.4.6 Test Result of Conducted Spurious Emission Plots

Please refer to Appendix A.

3.5 Radiated Band Edges and Spurious Emission Measurement

3.5.1 Limit of Radiated Band Edges and Spurious Emission

In any 100 kHz bandwidth outside the intentional radiator frequency band, all harmonics/spurious must be at least 20 dB below the highest emission level within the authorized band. If the output power of this device was measured by spectrum analyzer, the attenuation under this paragraph shall be 30 dB instead of 20 dB. In addition, radiated emissions which fall in the restricted bands must also comply with the limits as below.

Frequency (MHz)	Field Strength (microvolts/meter)	Measurement Distance (meters)
0.009 – 0.490	2400/F(kHz)	300
0.490 – 1.705	24000/F(kHz)	30
1.705 – 30.0	30	30
30 – 88	100	3
88 – 216	150	3
216 - 960	200	3
Above 960	500	3

3.5.2 Measuring Instruments

The section 4.0 of List of Measuring Equipment of this test report is used for test.



3.5.3 Test Procedures

1. The testing follows ANSI C63.10-2013 clause 11.11 & 11.12
2. The EUT was arranged to its worst case and then tune the antenna tower (from 1 m to 4 m) and turntable (from 0 degree to 360 degrees) to find the maximum reading. A pre-amp and a high pass filter are used for the test in order to get better signal level.
3. The EUT was placed on a turntable with 0.8 meter for frequency below 1GHz and 1.5 meter for frequency above 1GHz respectively above ground.
4. The EUT was set 3 meters from the interference receiving antenna, which was mounted on the top of a variable height antenna tower.
5. Corrected Reading: Antenna Factor + Cable Loss + Read Level - Preamp Factor = Level
6. For testing below 1GHz, if the emission level of the EUT in peak mode was 3 dB lower than the limit specified, then peak values of EUT will be reported, otherwise, the emissions will be repeated one by one using the CISPR quasi-peak method and reported.
7. For testing above 1GHz, the emission level of the EUT in peak mode was 20dB lower than peak limit (that means the emission level in average mode also complies with the limit in average mode), then peak values of EUT will be reported, otherwise, the emissions will be measured in average mode again and reported.
8. Use the following spectrum analyzer settings:
 - (1) Span shall wide enough to fully capture the emission being measured;
 - (2) Set RBW=100 kHz for $f < 1$ GHz; $VBW \geq RBW$; Sweep = auto; Detector function = peak; Trace = max hold;
 - (3) Set RBW = 1 MHz, VBW= 3MHz for $f \geq 1$ GHz for peak measurement.
For average measurement:
 - $VBW = 10$ Hz, when duty cycle is no less than 98 percent.
 - $VBW \geq 1/T$, when duty cycle is less than 98 percent where T is the minimum transmission duration over which the transmitter is on and is transmitting at its maximum power control level for the tested mode of operation.

3.5.4 Test Setup

For radiated emissions below 30MHz

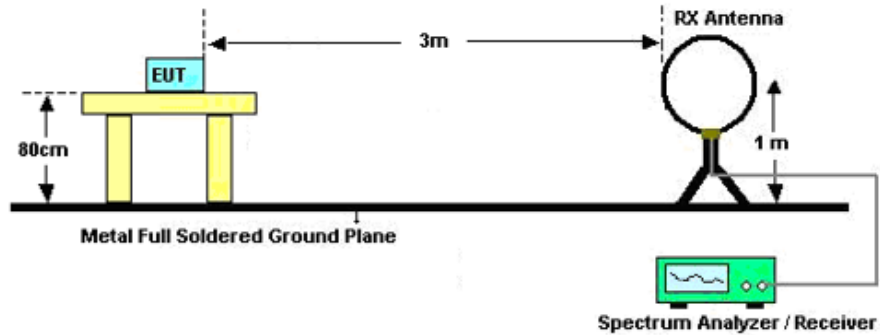

For radiated emissions from 30MHz to 1GHz

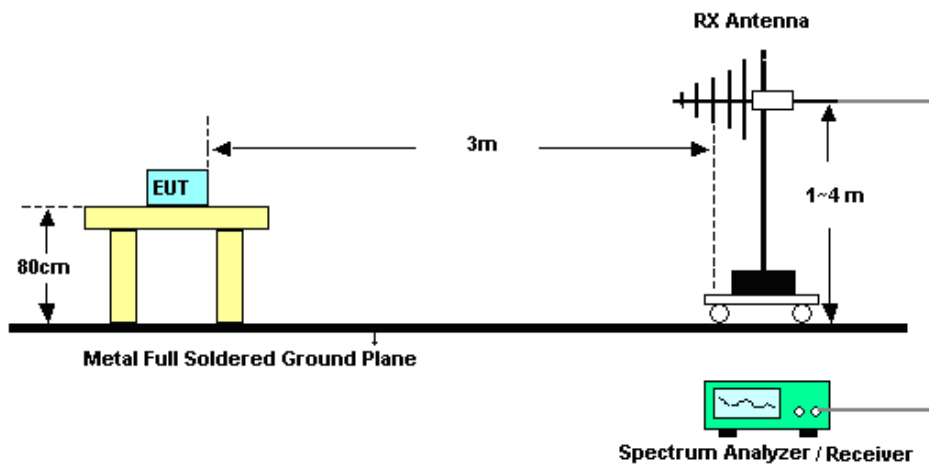

For radiated emissions above 1GHz

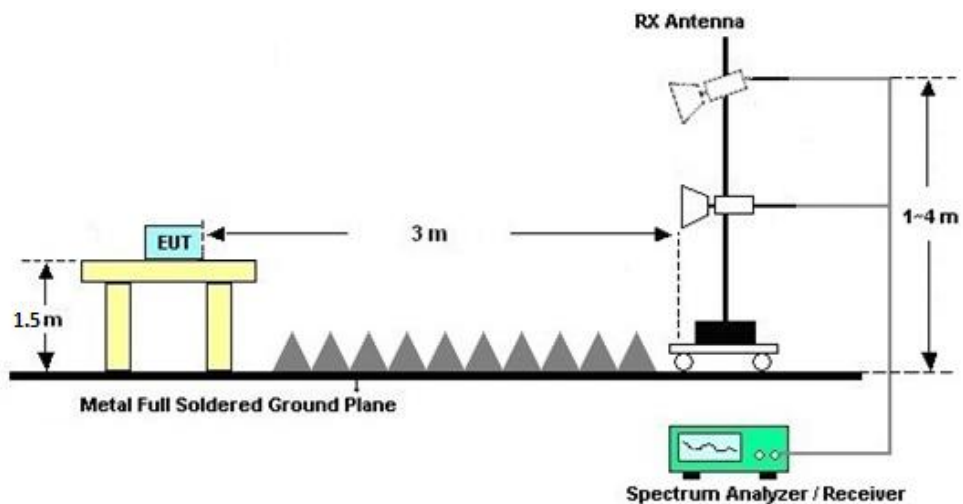



3.5.5 Test Results of Radiated Spurious Emissions (9 kHz ~ 30 MHz)

The low frequency, which started from 9 kHz to 30MHz, was pre-scanned and the result which was 20dB lower than the limit line was not reported.

There is a comparison data of both open-field test site and semi-Anechoic chamber, and the result came out very similar.

3.5.6 Test Result of Radiated Spurious at Band Edges

Please refer to Appendix C.

3.5.7 Duty Cycle

Please refer to Appendix D.

3.5.8 Test Result of Radiated Spurious Emission (30MHz ~ 10th Harmonic or 40GHz, whichever is lower)

Please refer to Appendix C.



3.6 AC Conducted Emission Measurement

3.6.1 Limit of AC Conducted Emission

For equipment that is designed to be connected to the public utility (AC) power line, the radio frequency voltage that is conducted back onto the AC power line on any frequency or frequencies within the band 150 kHz to 30 MHz shall not exceed the limits in the following table.

Frequency of emission (MHz)	Conducted limit (dBµV)	
	Quasi-peak	Average
0.15-0.5	66 to 56*	56 to 46*
0.5-5	56	46
5-30	60	50

*Decreases with the logarithm of the frequency.

3.6.2 Measuring Instruments

The section 4.0 of List of Measuring Equipment of this test report is used for test.

3.6.3 Test Procedures

1. The EUT was placed 0.4 meter from the conducting wall of the shielding room was kept at least 80 centimeters from any other grounded conducting surface.
2. Connect EUT to the power mains through a line impedance stabilization network (LISN).
3. All the support units are connecting to the other LISN.
4. The LISN provides 50 ohm coupling impedance for the measuring instrument.
5. The FCC states that a 50 ohm, 50 microhenry LISN should be used.
6. Both sides of AC line were checked for maximum conducted interference.
7. The frequency range from 150 kHz to 30 MHz was searched.
8. Set the test-receiver system to Peak Detect Function and specified bandwidth (IF Bandwidth = 9kHz) with Maximum Hold Mode. Then measurement is also conducted by Average Detector and Quasi-Peak Detector Function respectively.

3.6.4 Test Setup

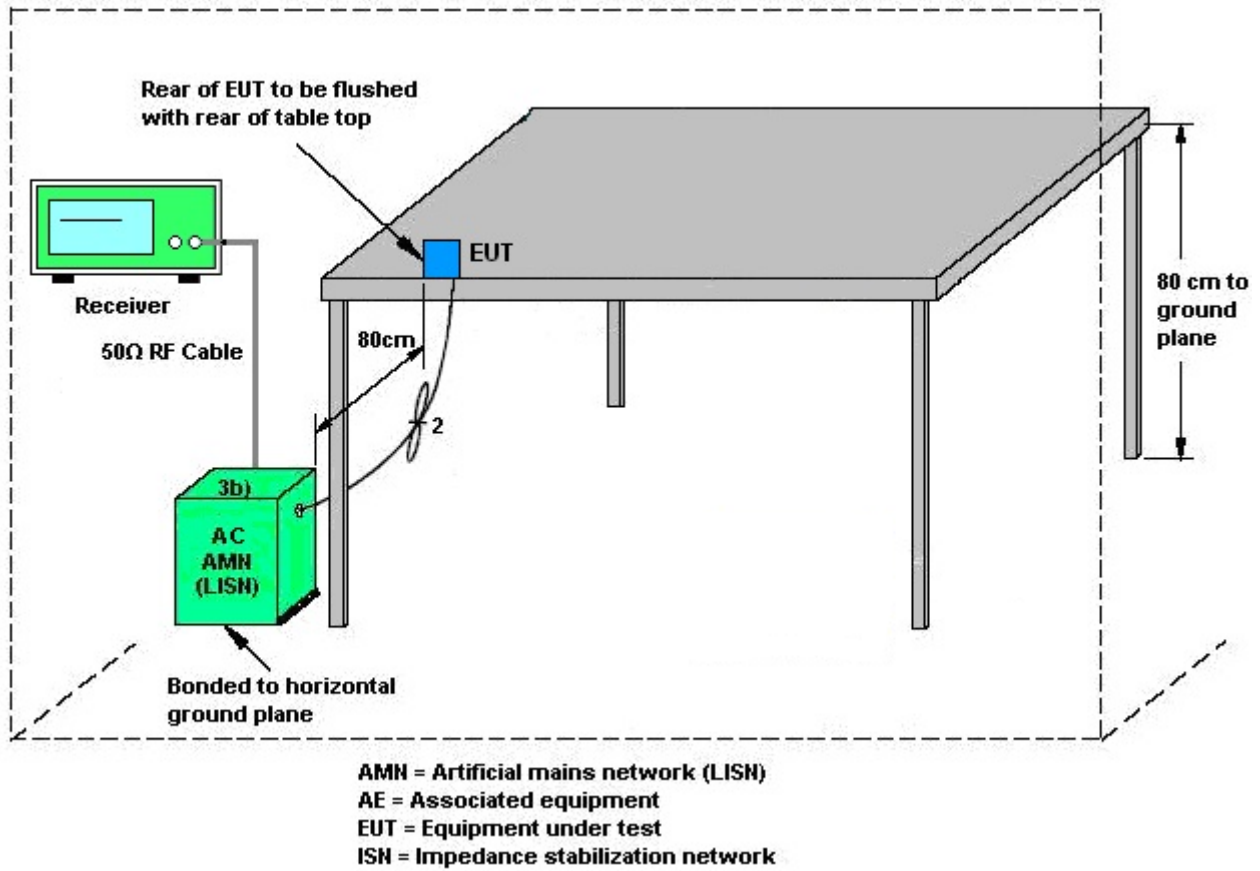

3.6.5 Test Result of AC Conducted Emission

Please refer to Appendix B.



3.7 Antenna Requirements

3.7.1 Standard Applicable

If directional gain of transmitting antennas is greater than 6dBi, the power shall be reduced by the same level in dB comparing to gain minus 6dBi. The use of a permanently attached antenna or of an antenna that uses a unique coupling to the intentional radiator shall be considered sufficient to comply with the rule.

3.7.2 Antenna Anti-Replacement Construction

An embedded-in antenna design is used.

3.7.3 Antenna Gain

The antenna peak gain of EUT is less than 6 dBi. Therefore, it is not necessary to reduce maximum peak output power limit.



4 List of Measuring Equipment

Instrument	Manufacturer	Model No.	Serial No.	Characteristics	Calibration Date	Test Date	Due Date	Remark
Spectrum Analyzer	R&S	FSV40	101040	10Hz~40GHz	Oct. 14, 2021	Jun. 23, 2022 ~Jun. 25, 2022	Oct. 13, 2022	Conducted (TH01-KS)
Pulse Power Sensor	Anritsu	MA2411B	0917070	300MHz~40GHz	Jan. 05, 2022	Jun. 23, 2022 ~Jun. 25, 2022	Jan. 04, 2023	Conducted (TH01-KS)
Power Meter	Anritsu	ML2495A	1005002	50MHz Bandwidth	Jan. 05, 2022	Jun. 23, 2022 ~Jun. 25, 2022	Jan. 04, 2023	Conducted (TH01-KS)
EMI Test Receiver	R&S	ESR7	101403	9kHz~7GHz;Max 30dBm	Oct. 16, 2021	Jul. 23, 2022	Oct. 15, 2022	Radiation (03CH08-KS)
EXA Spectrum Analyzer	Keysight	N9010B	MY574710 84	10Hz~44G,MAX 30dB	Jul. 11, 2022	Jul. 23, 2022	Jul. 10, 2023	Radiation (03CH08-KS)
Loop Antenna	R&S	HFH2-Z2	100321	9kHz~30MHz	Oct. 30, 2021	Jul. 23, 2022	Oct. 29, 2022	Radiation (03CH08-KS)
Bilog Antenna	TESEQ& VGT	CBL 61110	59915	30MHz~1GHz	Sep. 02, 2021	Jul. 23, 2022	Sep. 01, 2022	Radiation (03CH08-KS)
Double Ridge Horn Antenna	ETS-Lindgren	3117	00240138	1GHz~18GHz	Jul. 18, 2022	Jul. 23, 2022	Jul. 17, 2023	Radiation (03CH08-KS)
high gain Amplifier	MITEQ	AMF-7D-0010 1800-30-10P	2025788	1Ghz~18Ghz	Jul. 30, 2021	Jul. 23, 2022	Jul. 29, 2022	Radiation (03CH08-KS)
SHF-EHF Horn	Com-power	AH-840	101070	18GHz~40GHz	Jan. 05, 2022	Jul. 23, 2022	Jan. 04, 2023	Radiation (03CH08-KS)
Amplifier	SONOMA	310N	413741	9KHz~1GHz	Jan. 05, 2022	Jul. 23, 2022	Jan. 04, 2023	Radiation (03CH08-KS)
Amplifier	Keysight	83017A	MY532703 89	500MHz~26.5GHz	Jan. 05, 2022	Jul. 23, 2022	Jan. 04, 2023	Radiation (03CH08-KS)
Amplifier	MITEQ	EM18G40GGA	060728	18~40GHz	Jan. 05, 2022	Jul. 23, 2022	Jan. 04, 2023	Radiation (03CH08-KS)
AC Power Source	Chroma	61601	616010002 473	N/A	NCR	Jul. 23, 2022	NCR	Radiation (03CH08-KS)
Turn Table	MF	MF7802	N/A	0~360 degree	NCR	Jul. 23, 2022	NCR	Radiation (03CH08-KS)
Antenna Mast	MF	MF7802	N/A	1 m~4 m	NCR	Jul. 23, 2022	NCR	Radiation (03CH08-KS)
EMI Receiver	R&S	ESCI7	100768	9kHz~7GHz;	May 24, 2022	Jul. 21, 2022	May 23, 2023	Conduction (CO01-KS)
AC LISN (for auxiliary equipment)	MessTec	AN3016	060103	9kHz~30MHz	Oct. 14, 2021	Jul. 21, 2022	Oct. 13, 2022	Conduction (CO01-KS)
AC LISN	MessTec	AN3016	060105	9kHz~30MHz	May 24, 2022	Jul. 21, 2022	May 23, 2023	Conduction (CO01-KS)
AC Power Source	Chroma	61602	ABP000000 811	AC 0V~300V, 45Hz~1000Hz	Oct. 14, 2021	Jul. 21, 2022	Oct. 13, 2022	Conduction (CO01-KS)

NCR: No Calibration Required



5 Uncertainty of Evaluation

The measurement uncertainties shown below were calculated in accordance with the requirements of ANSI 63.10-2013. All the measurement uncertainty value were shown with a coverage K=2 to indicate 95% level of confidence. The measurement data show herein meets or exceeds the CISPR measurement uncertainty values specified in CISPR 16-4-2 and can be compared directly to specified limit to determine compliance.

Uncertainty of Conducted Measurement

Test Item	Uncertainty
Conducted Power	±0.56 dB
Conducted Emissions	±0.92 dB
Occupied Channel Bandwidth	±0.03 %
Conducted Power Spectral Density	±0.54 dB

Uncertainty of Conducted Emission Measurement (150 kHz ~ 30 MHz)

Measuring Uncertainty for a Level of Confidence of 95% (U = 2Uc(y))	2.94dB
---	--------

Uncertainty of Radiated Emission Measurement (30 MHz ~ 1000 MHz)

Measuring Uncertainty for a Level of Confidence of 95% (U = 2Uc(y))	4.9dB
---	-------

Uncertainty of Radiated Emission Measurement (1000 MHz ~ 18000 MHz)

Measuring Uncertainty for a Level of Confidence of 95% (U = 2Uc(y))	5.0dB
---	-------

Uncertainty of Radiated Emission Measurement (18000 MHz ~ 40000 MHz)

Measuring Uncertainty for a Level of Confidence of 95% (U = 2Uc(y))	5.0dB
---	-------

----- THE END -----



Appendix A. Conducted Test Results



DTS Bandwidth

Test Result

TestMode	Antenna	Frequency[MHz]	DTS BW [MHz]	FL[MHz]	FH[MHz]	Limit[MHz]	Verdict
BLE_1M	Ant1	2402	0.70	2401.66	2402.35	0.5	PASS
		2440	0.70	2439.65	2440.35	0.5	PASS
		2480	0.69	2479.66	2480.35	0.5	PASS



Test Graphs

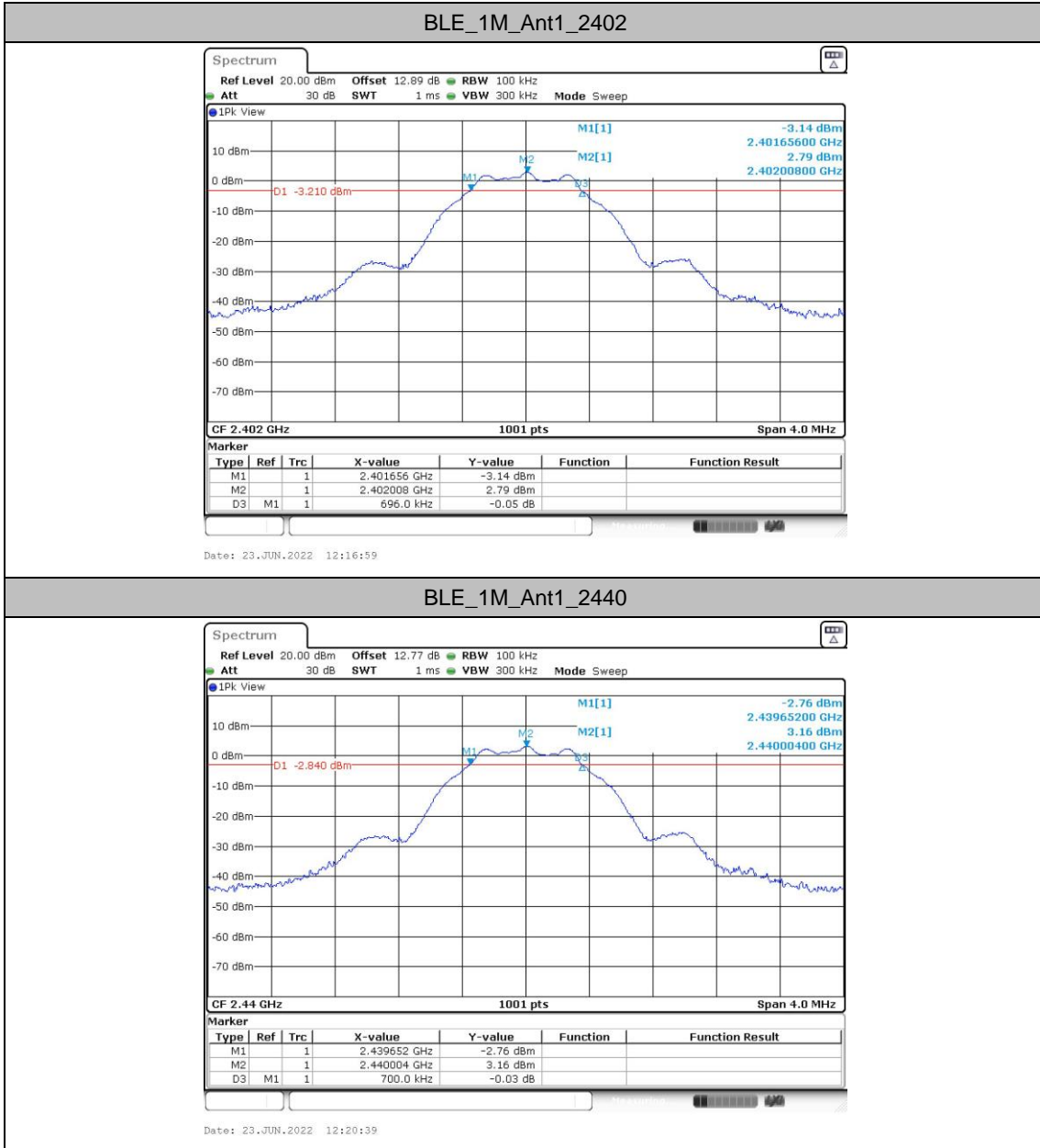

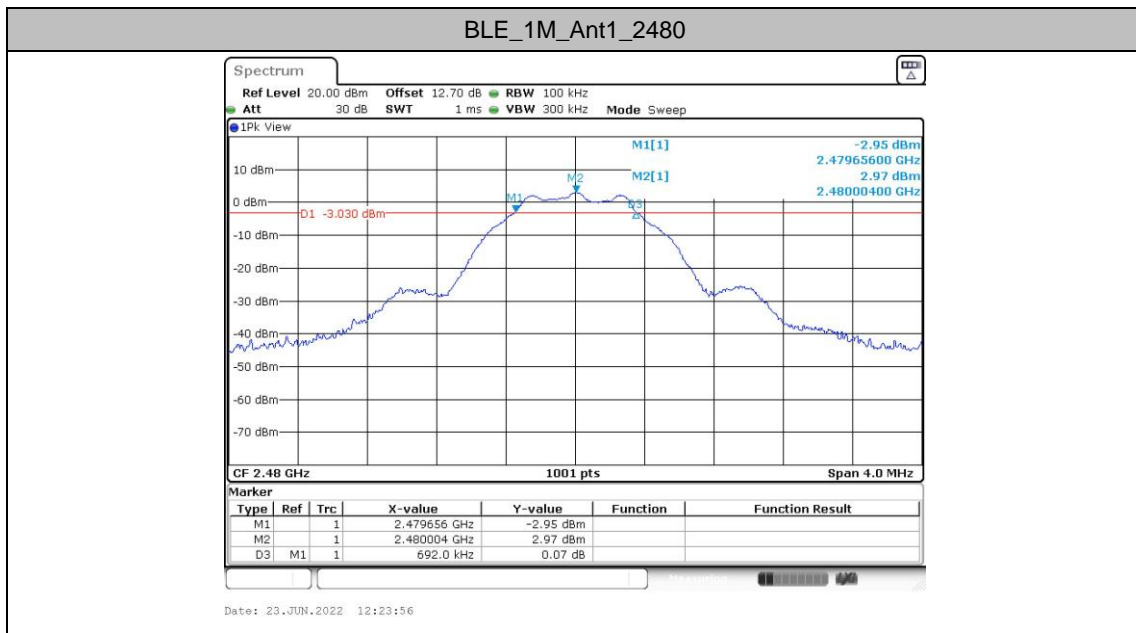



Occupied Channel Bandwidth

Test Result

TestMode	Antenna	Frequency[MHz]	OCB [MHz]	FL[MHz]	FH[MHz]	Limit[MHz]	Verdict
BLE_1M	Ant1	2402	1.051	2401.485	2402.535	---	---
		2440	1.051	2439.485	2440.535	---	---
		2480	1.055	2479.485	2480.539	---	---



Test Graphs

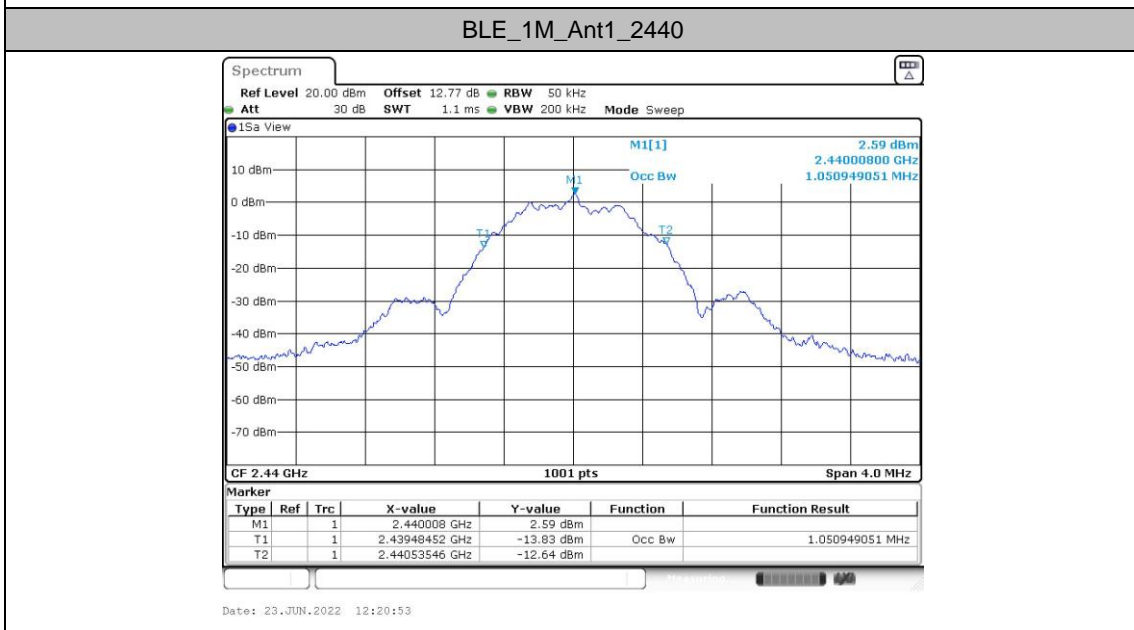
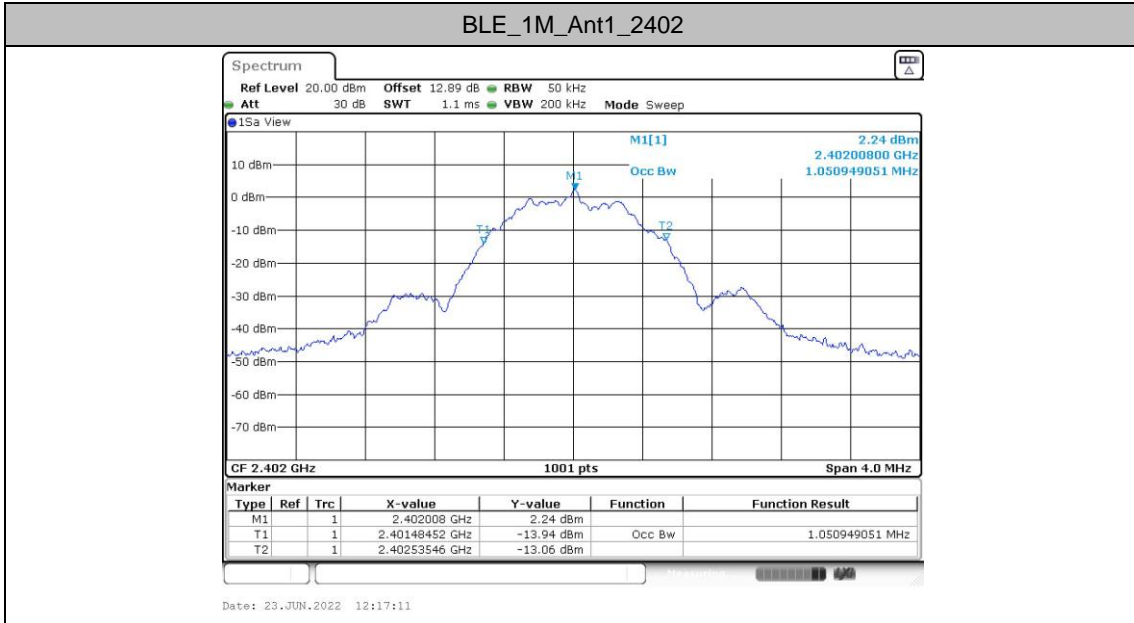

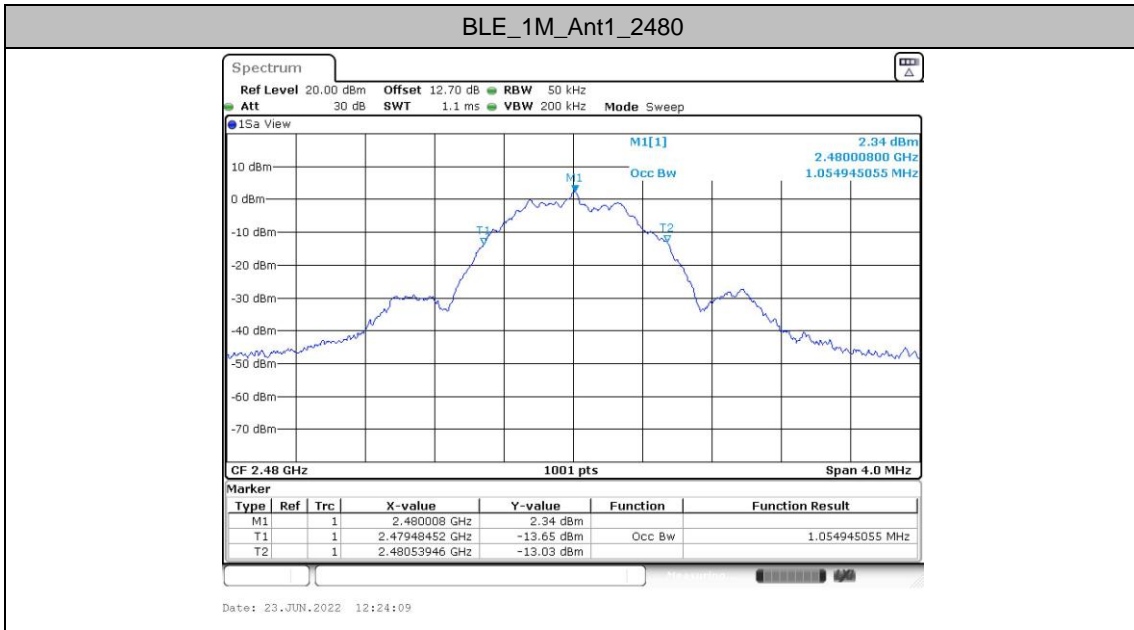



Power spectral density

Test Result

TestMode	Antenna	Frequency[MHz]	Result[dBm/3kHz]	Limit[dBm/3kHz]	Verdict
BLE_1M	Ant1	2402	-12.32	≤8.00	PASS
		2440	-11.75	≤8.00	PASS
		2480	-11.98	≤8.00	PASS



Test Graphs

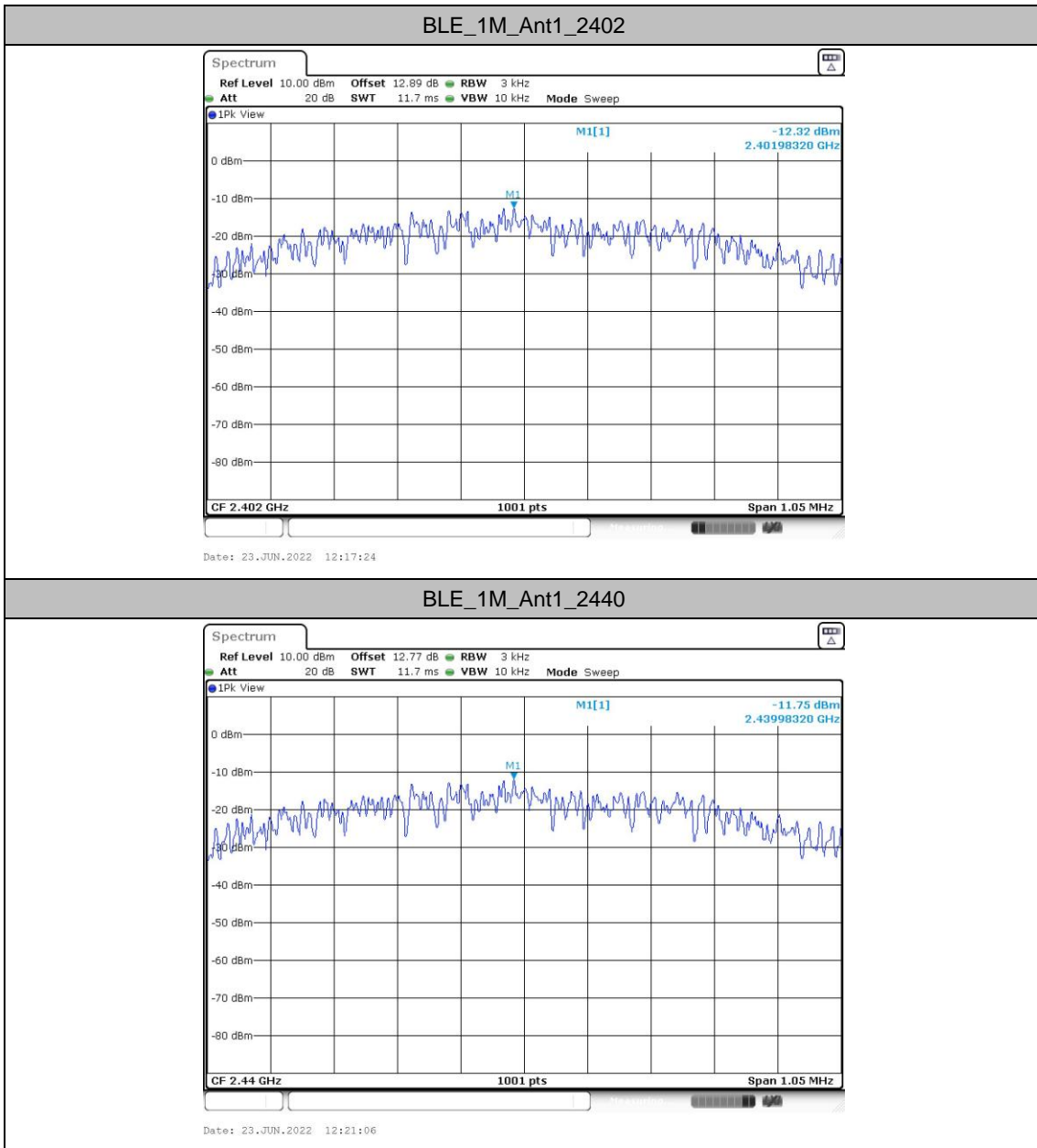

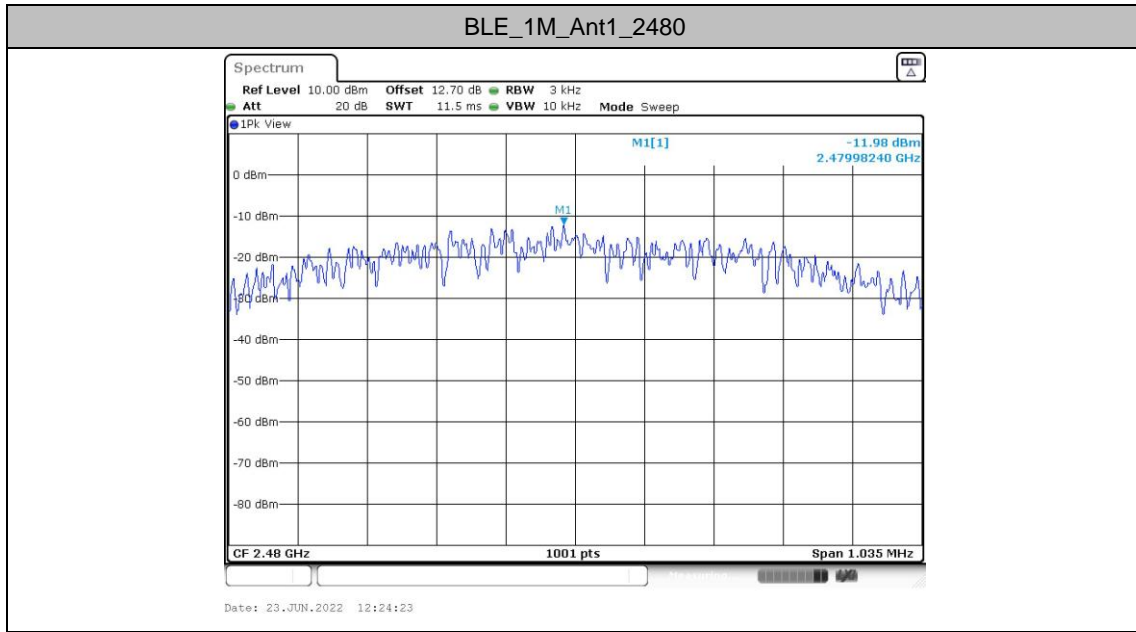



Reference level measurement

Test Result

TestMode	Antenna	Freq(MHz)	Max.Point[MHz]	Result[dBm]
BLE_1M	Ant1	2402	2402.00	2.76
		2440	2440.00	3.11
		2480	2480.00	2.91



Test Graphs



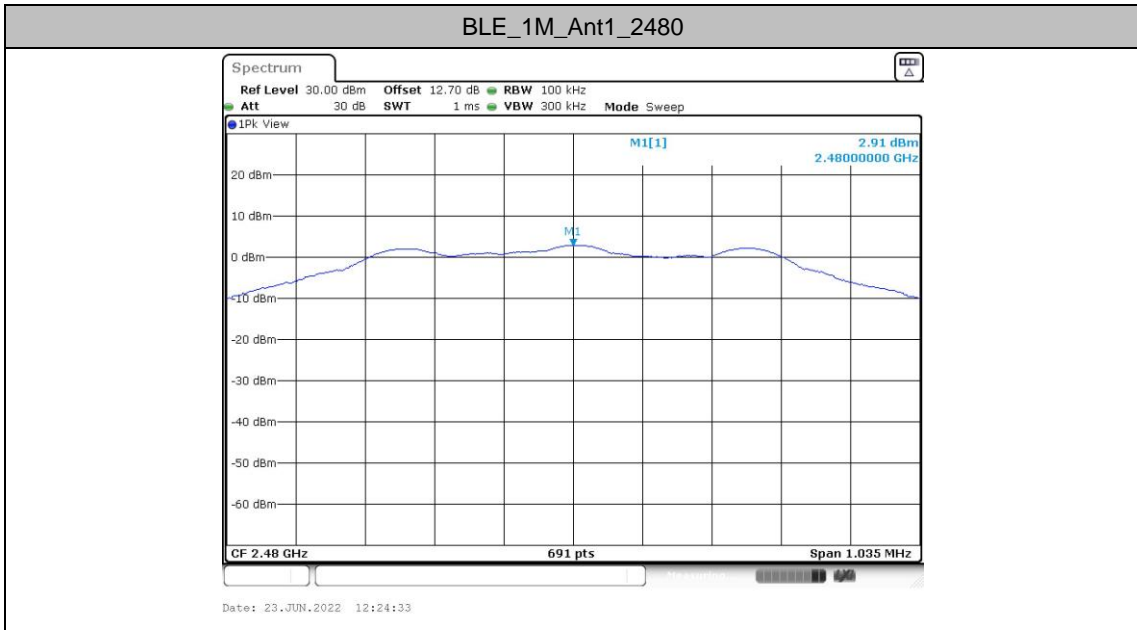



Band edge measurements

Test Result

TestMode	Antenna	Channel	Frequency[MHz]	RefLevel[dBm]	Result[dBm]	Limit[dBm]	Verdict
BLE_1M	Ant1	Low	2402	2.76	-43.14	≤-17.24	PASS
		High	2480	2.91	-42.89	≤-17.09	PASS



Test Graphs

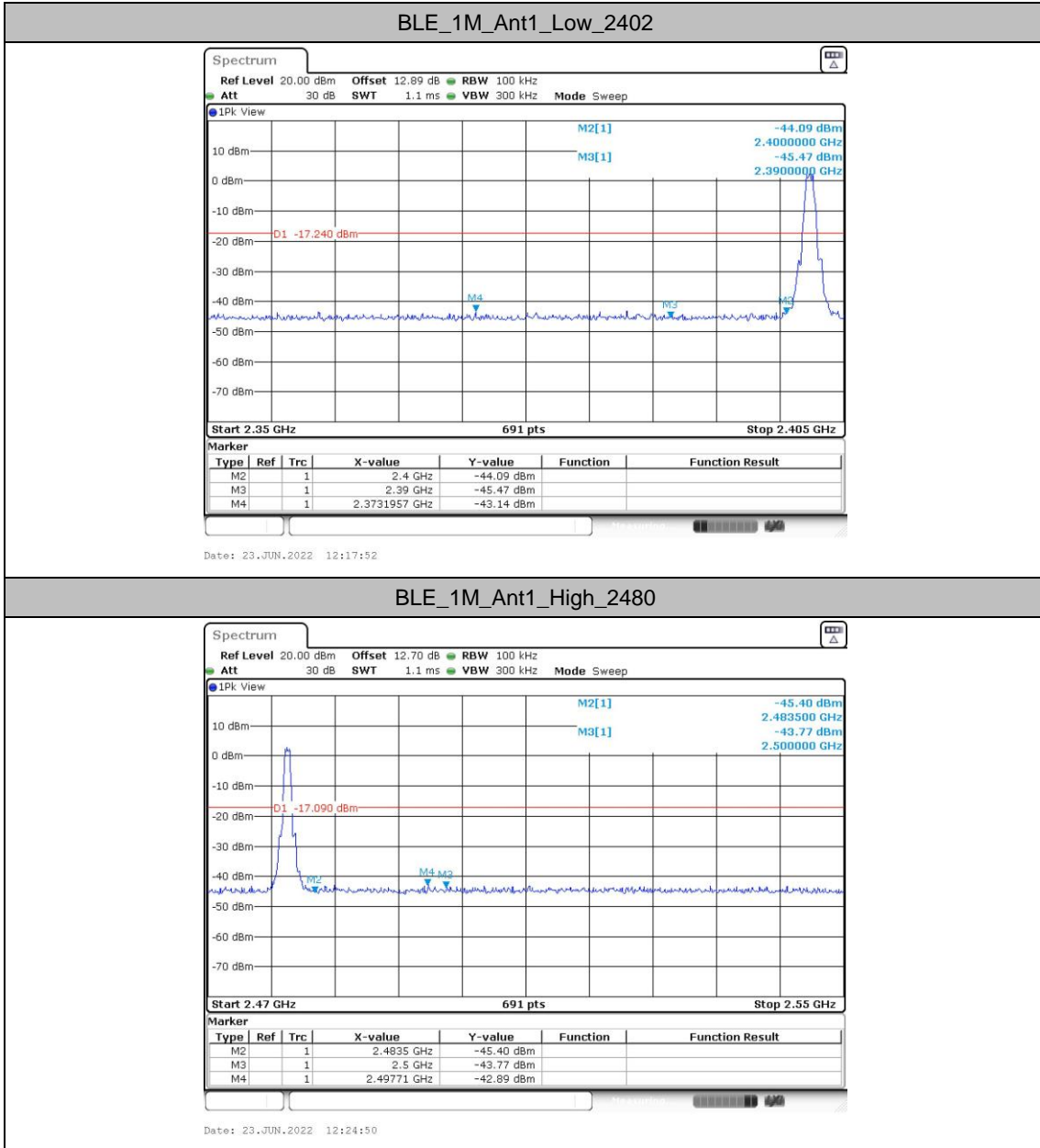



Conducted Spurious Emission

Test Result

TestMod e	Antenn a	Frequency[M Hz]	FreqRange [MHz]	RefLeve l [dBm]	Result[dBm]	Limit[dBm]	Verdic t
BLE_1M	Ant1	2402	30~1000	2.76	-54.13	≤-17.24	PASS
			1000~26500	2.76	-45.4	≤-17.24	PASS
		2440	30~1000	3.11	-55.18	≤-16.89	PASS
			1000~26500	3.11	-45.58	≤-16.89	PASS
		2480	30~1000	2.91	-54.86	≤-17.09	PASS
			1000~26500	2.91	-45.4	≤-17.09	PASS



Test Graphs

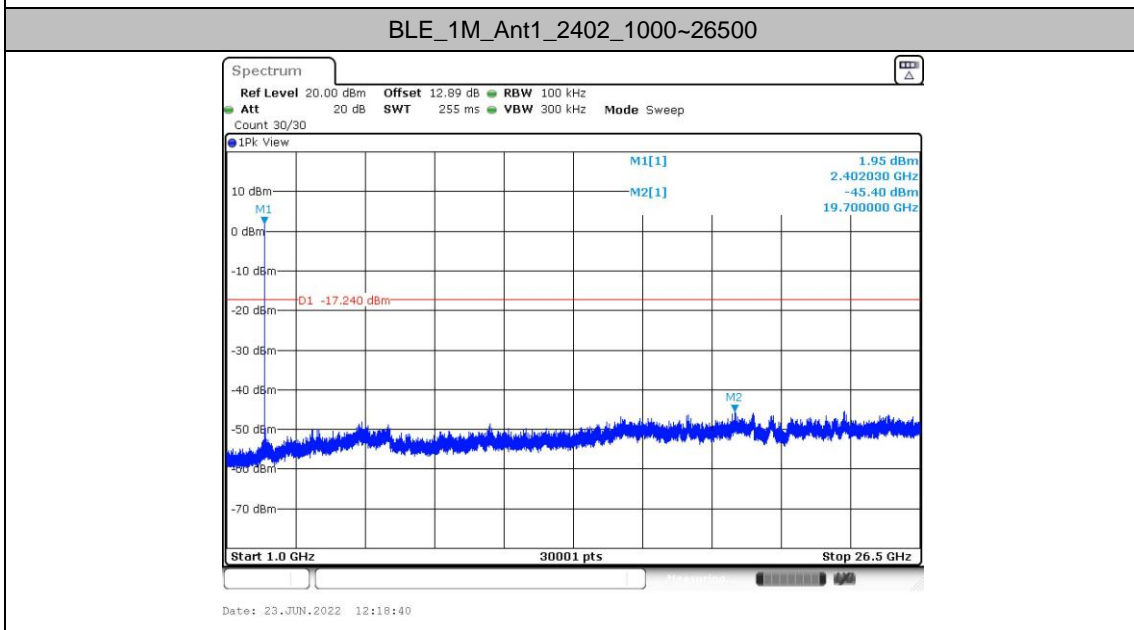
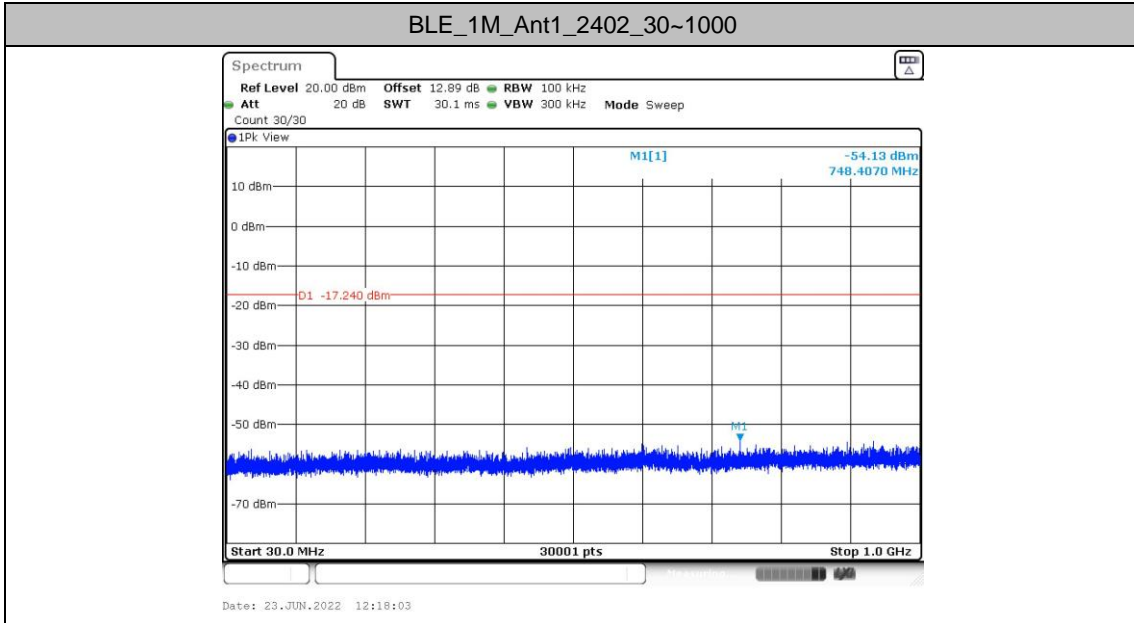



BLE_1M_Ant1_2440_30~1000

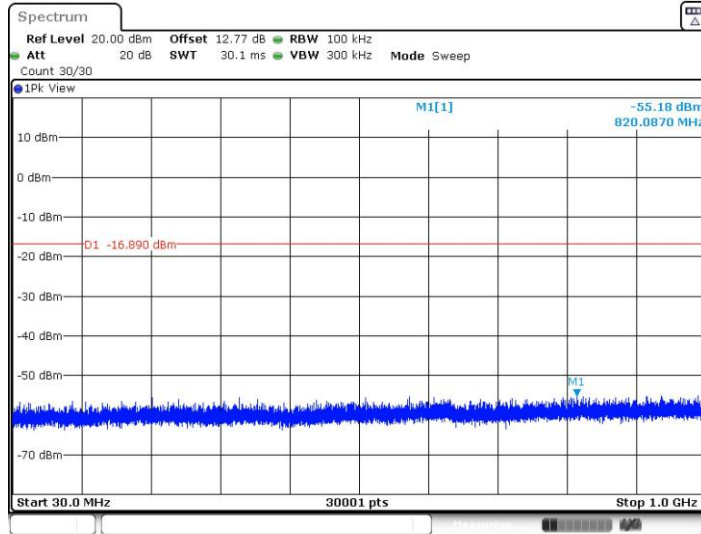

Date: 23 JUN. 2022 12:21:24

BLE_1M_Ant1_2440_1000~26500

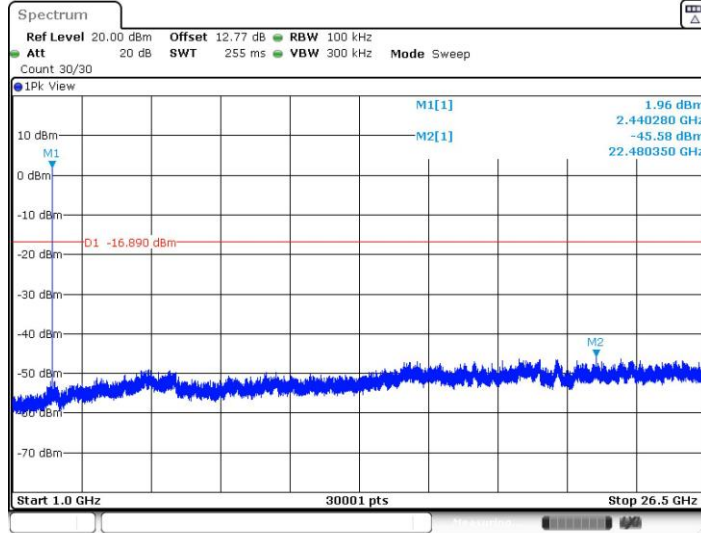

Date: 23 JUN. 2022 12:22:01



BLE_1M_Ant1_2480_30~1000

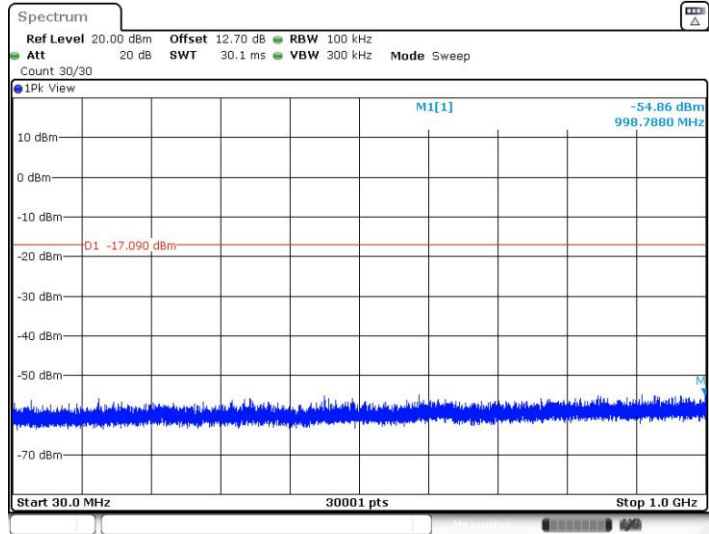

Date: 23 JUN. 2022 12:24:59

BLE_1M_Ant1_2480_1000~26500

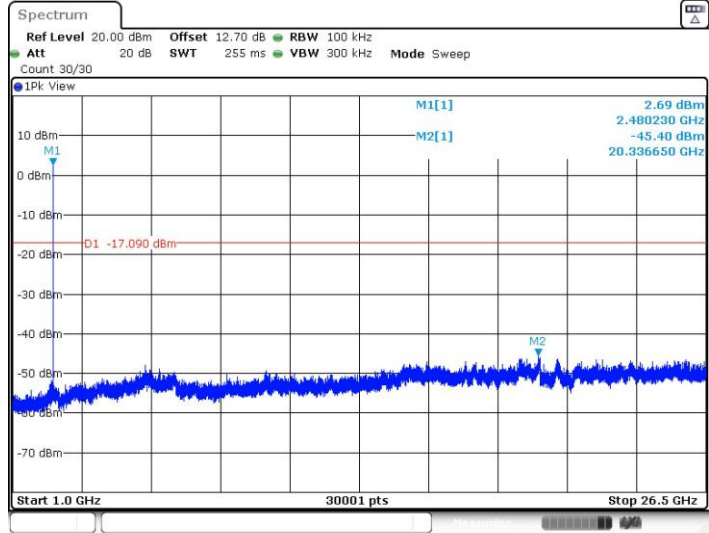

Date: 23 JUN. 2022 12:25:36



Maximum Output Power

Test Result

Mod.	Data Rate	NTX	CH.	Freq. (MHz)	Peak Conducted Power (dBm)	Conducted Power Limit (dBm)	DG (dBi)	EIRP Power (dBm)	EIRP Power Limit (dBm)	Pass /Fail
BLE	1Mbps	1	0	2402	3.75	30.00	0.90	4.65	36.00	Pass
BLE	1Mbps	1	19	2440	3.57	30.00	0.90	4.47	36.00	Pass
BLE	1Mbps	1	39	2480	3.86	30.00	0.90	4.76	36.00	Pass

Average Power

Test Result

Mod.	Data Rate	NTX	CH.	Freq. (MHz)	Duty Factor (dB)	Average Conducted Power (dBm)
BLE	1Mbps	1	0	2402	2.04	3.72
BLE	1Mbps	1	19	2440	2.04	3.49
BLE	1Mbps	1	39	2480	2.04	3.81



Appendix B. AC Conducted Emission Test Results

Test Engineer :	Amos Zhang	Temperature :	24.2~25.6°C
		Relative Humidity :	37~39%
Test Voltage :	120Vac / 60Hz	Phase :	Line
Remark :	All emissions not reported here are more than 10 dB below the prescribed limit.		

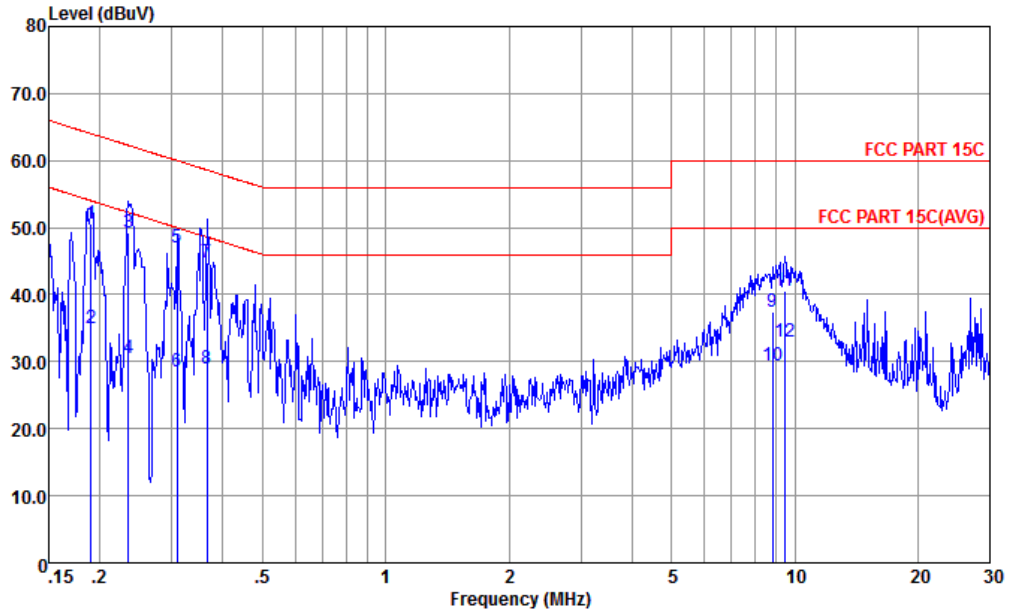

Site : CO01-KS
 Condition : FCC PART 15C LISN-060105-L LINE

	Freq	Level	Over	Limit	Read	LISN	Cable	Remark
	MHz	dBuV	Limit	Line	Level	Factor	Loss	
			dB	dBuV	dBuV	dB	dB	
1	0.190	50.62	-13.40	64.02	40.20	0.04	10.38	QP
2	0.190	35.02	-19.00	54.02	24.60	0.04	10.38	Average
3 *	0.235	49.29	-12.97	62.26	38.90	0.05	10.34	QP
4	0.235	30.59	-21.67	52.26	20.20	0.05	10.34	Average
5	0.308	46.97	-13.05	60.02	36.60	0.07	10.30	QP
6	0.308	28.57	-21.45	50.02	18.20	0.07	10.30	Average
7	0.365	44.86	-13.75	58.61	34.50	0.08	10.28	QP
8	0.365	28.86	-19.75	48.61	18.50	0.08	10.28	Average
9	8.822	37.34	-22.66	60.00	26.80	0.21	10.33	QP
10	8.822	29.34	-20.66	50.00	18.80	0.21	10.33	Average
11	9.451	40.45	-19.55	60.00	29.89	0.22	10.34	QP
12	9.451	33.05	-16.95	50.00	22.49	0.22	10.34	Average



Test Engineer :	Amos Zhang	Temperature :	24.2~25.6°C
		Relative Humidity :	37~39%
Test Voltage :	120Vac / 60Hz	Phase :	Neutral
Remark :	All emissions not reported here are more than 10 dB below the prescribed limit.		

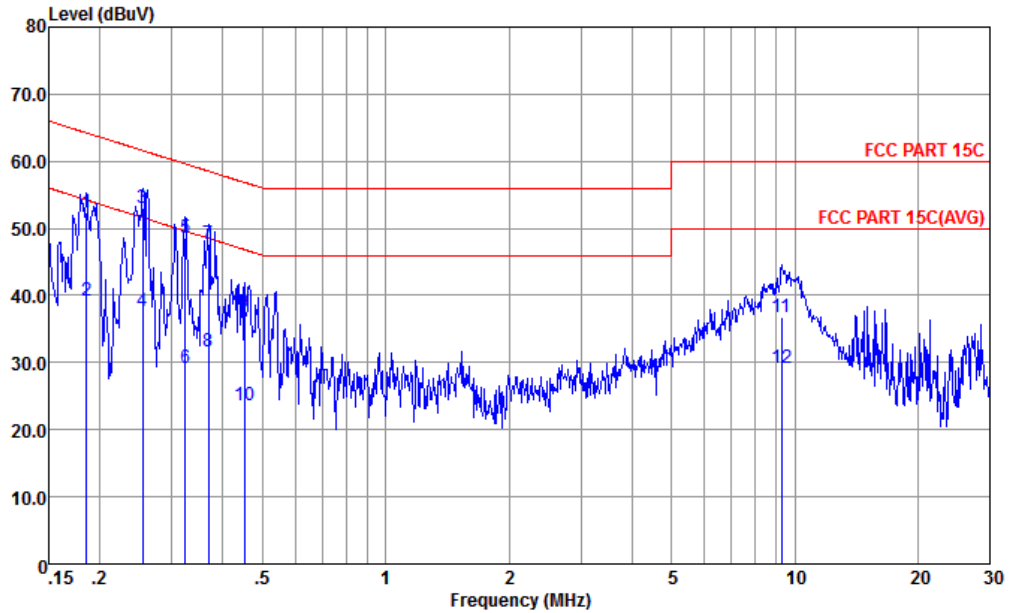

Site : CO01-KS
 Condition : FCC PART 15C LISN-060105-N NEUTRAL

	Freq	Level	Over	Limit	Read	LISN	Cable	Remark
	MHz	dBuV	Limit	Line	Level	Factor	Loss	
			dB	dBuV	dBuV	dB	dB	
1	0.185	52.30	-11.94	64.24	41.81	0.10	10.39	QP
2	0.185	39.30	-14.94	54.24	28.81	0.10	10.39	Average
3 *	0.255	53.03	-8.57	61.60	42.60	0.10	10.33	QP
4	0.255	37.63	-13.97	51.60	27.20	0.10	10.33	Average
5	0.323	48.60	-11.02	59.62	38.20	0.10	10.30	QP
6	0.323	29.20	-20.42	49.62	18.80	0.10	10.30	Average
7	0.369	47.58	-10.94	58.52	37.20	0.10	10.28	QP
8	0.369	31.68	-16.84	48.52	21.30	0.10	10.28	Average
9	0.452	37.46	-19.39	56.85	27.10	0.11	10.25	QP
10	0.452	23.66	-23.19	46.85	13.30	0.11	10.25	Average
11	9.302	36.76	-23.24	60.00	26.21	0.22	10.33	QP
12	9.302	29.16	-20.84	50.00	18.61	0.22	10.33	Average

Note:

- Level(dBμV) = Read Level(dBμV) + LISN Factor(dB) + Cable Loss(dB)
- Over Limit(dB) = Level(dBμV) – Limit Line(dBμV)



Appendix C. Radiated Spurious Emission Test Data

Test Engineer :	Carry Xu	Relative Humidity :	41~42%
Test Data :	2022/7/23	Temperature :	22~23°C

Mode	Band (MHz)	Antenna	Modulation	Channel	Frequency	Data Rate	RU	Remark
Mode 1	2400-2483.5	SISO	Bluetooth-LE_GSKF	00	2402	1Mbps	-	-
Mode 2	2400-2483.5	SISO	Bluetooth-LE_GSKF	19	2440	1Mbps	-	-
Mode 3	2400-2483.5	SISO	Bluetooth-LE_GSKF	39	2480	1Mbps	-	-

Summary of each worse mode

Mode	Modulation	Ch.	Freq. (MHz)	Level (dBuV/m)	Limit (dBuV/m)	Margin (dB)	Pol.	Peak Avg.	Result	Remark
1	Bluetooth-LE_GSKF	00	2388.26	46.85	54.00	-7.15	H	AVERAGE	Pass	Band Edge
2	Bluetooth-LE_GSKF	19	7320.00	43.18	74.00	-30.82	V	PEAK	Pass	Harmonic
3	Bluetooth-LE_GSKF	39	2483.50	48.36	54.00	-5.64	H	AVERAGE	Pass	Band Edge



Mode	1																																																																																															
	Band Edge																																																																																															
	2400-2483.5_Bluetooth-LE_GSKF_CH00_2402MHz																																																																																															
ANT	SISO																																																																																															
Pol.	Horizontal	Fundamental																																																																																														
Peak	<table border="1"> <thead> <tr> <th>Limit</th> <th>Read</th> <th>Ant</th> <th>Cable</th> <th>Aux</th> <th>APos</th> <th>TPos</th> <th>Remark</th> </tr> <tr> <th>Freq</th> <th>Level</th> <th>Line</th> <th>Margin</th> <th>Level</th> <th>Factor</th> <th>Loss</th> <th>Factor</th> <th>Factor</th> <th>Factor</th> <th>cm</th> <th>deg</th> <th>Remark</th> </tr> <tr> <th>MHz</th> <th>dBuV/m</th> <th>dBuV/m</th> <th>dB</th> <th>dBuV</th> <th>dB/m</th> <th>dB</th> <th>dB</th> <th>dB</th> <th>dB</th> <th>cm</th> <th>deg</th> <th>Remark</th> </tr> </thead> <tbody> <tr> <td>1</td> <td>2357.97</td> <td>56.10</td> <td>74.00</td> <td>-17.90</td> <td>43.97</td> <td>31.90</td> <td>7.11</td> <td>32.88</td> <td>6.00</td> <td>300</td> <td>348</td> <td>PEAK</td> </tr> </tbody> </table>	Limit	Read	Ant	Cable	Aux	APos	TPos	Remark	Freq	Level	Line	Margin	Level	Factor	Loss	Factor	Factor	Factor	cm	deg	Remark	MHz	dBuV/m	dBuV/m	dB	dBuV	dB/m	dB	dB	dB	dB	cm	deg	Remark	1	2357.97	56.10	74.00	-17.90	43.97	31.90	7.11	32.88	6.00	300	348	PEAK	<table border="1"> <thead> <tr> <th>Limit</th> <th>Read</th> <th>Ant</th> <th>Cable</th> <th>Aux</th> <th>APos</th> <th>TPos</th> <th>Remark</th> </tr> <tr> <th>Freq</th> <th>Level</th> <th>Line</th> <th>Margin</th> <th>Level</th> <th>Factor</th> <th>Loss</th> <th>Factor</th> <th>Factor</th> <th>Factor</th> <th>cm</th> <th>deg</th> <th>Remark</th> </tr> <tr> <th>MHz</th> <th>dBuV/m</th> <th>dBuV/m</th> <th>dB</th> <th>dBuV</th> <th>dB/m</th> <th>dB</th> <th>dB</th> <th>dB</th> <th>dB</th> <th>cm</th> <th>deg</th> <th>Remark</th> </tr> </thead> <tbody> <tr> <td>1</td> <td>2402.00</td> <td>89.16</td> <td>-----</td> <td>-----</td> <td>76.81</td> <td>32.00</td> <td>7.19</td> <td>32.84</td> <td>6.00</td> <td>300</td> <td>348</td> <td>PEAK</td> </tr> </tbody> </table>	Limit	Read	Ant	Cable	Aux	APos	TPos	Remark	Freq	Level	Line	Margin	Level	Factor	Loss	Factor	Factor	Factor	cm	deg	Remark	MHz	dBuV/m	dBuV/m	dB	dBuV	dB/m	dB	dB	dB	dB	cm	deg	Remark	1	2402.00	89.16	-----	-----	76.81	32.00	7.19	32.84	6.00	300	348	PEAK
	Limit	Read	Ant	Cable	Aux	APos	TPos	Remark																																																																																								
Freq	Level	Line	Margin	Level	Factor	Loss	Factor	Factor	Factor	cm	deg	Remark																																																																																				
MHz	dBuV/m	dBuV/m	dB	dBuV	dB/m	dB	dB	dB	dB	cm	deg	Remark																																																																																				
1	2357.97	56.10	74.00	-17.90	43.97	31.90	7.11	32.88	6.00	300	348	PEAK																																																																																				
Limit	Read	Ant	Cable	Aux	APos	TPos	Remark																																																																																									
Freq	Level	Line	Margin	Level	Factor	Loss	Factor	Factor	Factor	cm	deg	Remark																																																																																				
MHz	dBuV/m	dBuV/m	dB	dBuV	dB/m	dB	dB	dB	dB	cm	deg	Remark																																																																																				
1	2402.00	89.16	-----	-----	76.81	32.00	7.19	32.84	6.00	300	348	PEAK																																																																																				
Avg	<table border="1"> <thead> <tr> <th>Limit</th> <th>Read</th> <th>Ant</th> <th>Cable</th> <th>Aux</th> <th>APos</th> <th>TPos</th> <th>Remark</th> </tr> <tr> <th>Freq</th> <th>Level</th> <th>Line</th> <th>Margin</th> <th>Level</th> <th>Factor</th> <th>Loss</th> <th>Factor</th> <th>Factor</th> <th>Factor</th> <th>cm</th> <th>deg</th> <th>Remark</th> </tr> <tr> <th>MHz</th> <th>dBuV/m</th> <th>dBuV/m</th> <th>dB</th> <th>dBuV</th> <th>dB/m</th> <th>dB</th> <th>dB</th> <th>dB</th> <th>dB</th> <th>cm</th> <th>deg</th> <th>Remark</th> </tr> </thead> <tbody> <tr> <td>1</td> <td>2388.26</td> <td>46.85</td> <td>54.00</td> <td>-7.15</td> <td>34.57</td> <td>31.97</td> <td>7.16</td> <td>32.85</td> <td>6.00</td> <td>300</td> <td>348</td> <td>AVERAGE</td> </tr> </tbody> </table>	Limit	Read	Ant	Cable	Aux	APos	TPos	Remark	Freq	Level	Line	Margin	Level	Factor	Loss	Factor	Factor	Factor	cm	deg	Remark	MHz	dBuV/m	dBuV/m	dB	dBuV	dB/m	dB	dB	dB	dB	cm	deg	Remark	1	2388.26	46.85	54.00	-7.15	34.57	31.97	7.16	32.85	6.00	300	348	AVERAGE	<table border="1"> <thead> <tr> <th>Limit</th> <th>Read</th> <th>Ant</th> <th>Cable</th> <th>Aux</th> <th>APos</th> <th>TPos</th> <th>Remark</th> </tr> <tr> <th>Freq</th> <th>Level</th> <th>Line</th> <th>Margin</th> <th>Level</th> <th>Factor</th> <th>Loss</th> <th>Factor</th> <th>Factor</th> <th>Factor</th> <th>cm</th> <th>deg</th> <th>Remark</th> </tr> <tr> <th>MHz</th> <th>dBuV/m</th> <th>dBuV/m</th> <th>dB</th> <th>dBuV</th> <th>dB/m</th> <th>dB</th> <th>dB</th> <th>dB</th> <th>dB</th> <th>cm</th> <th>deg</th> <th>Remark</th> </tr> </thead> <tbody> <tr> <td>1</td> <td>2402.00</td> <td>88.66</td> <td>-----</td> <td>-----</td> <td>76.33</td> <td>31.99</td> <td>7.18</td> <td>32.84</td> <td>6.00</td> <td>300</td> <td>348</td> <td>AVERAGE</td> </tr> </tbody> </table>	Limit	Read	Ant	Cable	Aux	APos	TPos	Remark	Freq	Level	Line	Margin	Level	Factor	Loss	Factor	Factor	Factor	cm	deg	Remark	MHz	dBuV/m	dBuV/m	dB	dBuV	dB/m	dB	dB	dB	dB	cm	deg	Remark	1	2402.00	88.66	-----	-----	76.33	31.99	7.18	32.84	6.00	300	348	AVERAGE
Limit	Read	Ant	Cable	Aux	APos	TPos	Remark																																																																																									
Freq	Level	Line	Margin	Level	Factor	Loss	Factor	Factor	Factor	cm	deg	Remark																																																																																				
MHz	dBuV/m	dBuV/m	dB	dBuV	dB/m	dB	dB	dB	dB	cm	deg	Remark																																																																																				
1	2388.26	46.85	54.00	-7.15	34.57	31.97	7.16	32.85	6.00	300	348	AVERAGE																																																																																				
Limit	Read	Ant	Cable	Aux	APos	TPos	Remark																																																																																									
Freq	Level	Line	Margin	Level	Factor	Loss	Factor	Factor	Factor	cm	deg	Remark																																																																																				
MHz	dBuV/m	dBuV/m	dB	dBuV	dB/m	dB	dB	dB	dB	cm	deg	Remark																																																																																				
1	2402.00	88.66	-----	-----	76.33	31.99	7.18	32.84	6.00	300	348	AVERAGE																																																																																				



Mode	1																																																																																	
	Band Edge																																																																																	
	2400-2483.5_Bluetooth-LE_GSKF_CH00_2402MHz																																																																																	
ANT	SISO																																																																																	
Pol.	Vertical	Fundamental																																																																																
Peak	<table border="1"> <thead> <tr> <th>Limit</th> <th>Read</th> <th>Ant</th> <th>Cable</th> <th>Preamp</th> <th>Aux</th> <th>APos</th> <th>TPos</th> <th>Remark</th> </tr> <tr> <th>Freq</th> <th>Level</th> <th>Line Margin</th> <th>Level Factor</th> <th>Loss Factor</th> <th>Loss Factor</th> <th>Factor</th> <th></th> <th></th> </tr> <tr> <th>MHz</th> <th>dBuV/m</th> <th>dBuV/m</th> <th>dB</th> <th>dBuV</th> <th>dB/m</th> <th>dB</th> <th>dB</th> <th>cm</th> <th>deg</th> </tr> </thead> <tbody> <tr> <td>1</td> <td>2383.45</td> <td>55.93</td> <td>74.00</td> <td>-18.07</td> <td>43.67</td> <td>31.96</td> <td>7.15</td> <td>32.85</td> <td>6.00</td> <td>300</td> <td>339</td> <td>PEAK</td> </tr> </tbody> </table>	Limit	Read	Ant	Cable	Preamp	Aux	APos	TPos	Remark	Freq	Level	Line Margin	Level Factor	Loss Factor	Loss Factor	Factor			MHz	dBuV/m	dBuV/m	dB	dBuV	dB/m	dB	dB	cm	deg	1	2383.45	55.93	74.00	-18.07	43.67	31.96	7.15	32.85	6.00	300	339	PEAK	<table border="1"> <thead> <tr> <th>Limit</th> <th>Read</th> <th>Ant</th> <th>Cable</th> <th>Preamp</th> <th>Aux</th> <th>APos</th> <th>TPos</th> <th>Remark</th> </tr> <tr> <th>Freq</th> <th>Level</th> <th>Line Margin</th> <th>Level Factor</th> <th>Loss Factor</th> <th>Loss Factor</th> <th>Factor</th> <th></th> <th></th> </tr> <tr> <th>MHz</th> <th>dBuV/m</th> <th>dBuV/m</th> <th>dB</th> <th>dBuV</th> <th>dB/m</th> <th>dB</th> <th>dB</th> <th>cm</th> <th>deg</th> </tr> </thead> <tbody> <tr> <td>1</td> <td>2402.00</td> <td>90.00</td> <td>77.65</td> <td>32.00</td> <td>7.19</td> <td>32.84</td> <td>6.00</td> <td>300</td> <td>339</td> <td>PEAK</td> </tr> </tbody> </table>	Limit	Read	Ant	Cable	Preamp	Aux	APos	TPos	Remark	Freq	Level	Line Margin	Level Factor	Loss Factor	Loss Factor	Factor			MHz	dBuV/m	dBuV/m	dB	dBuV	dB/m	dB	dB	cm	deg	1	2402.00	90.00	77.65	32.00	7.19	32.84	6.00	300	339	PEAK
Limit	Read	Ant	Cable	Preamp	Aux	APos	TPos	Remark																																																																										
Freq	Level	Line Margin	Level Factor	Loss Factor	Loss Factor	Factor																																																																												
MHz	dBuV/m	dBuV/m	dB	dBuV	dB/m	dB	dB	cm	deg																																																																									
1	2383.45	55.93	74.00	-18.07	43.67	31.96	7.15	32.85	6.00	300	339	PEAK																																																																						
Limit	Read	Ant	Cable	Preamp	Aux	APos	TPos	Remark																																																																										
Freq	Level	Line Margin	Level Factor	Loss Factor	Loss Factor	Factor																																																																												
MHz	dBuV/m	dBuV/m	dB	dBuV	dB/m	dB	dB	cm	deg																																																																									
1	2402.00	90.00	77.65	32.00	7.19	32.84	6.00	300	339	PEAK																																																																								
Avg	<table border="1"> <thead> <tr> <th>Limit</th> <th>Read</th> <th>Ant</th> <th>Cable</th> <th>Preamp</th> <th>Aux</th> <th>APos</th> <th>TPos</th> <th>Remark</th> </tr> <tr> <th>Freq</th> <th>Level</th> <th>Line Margin</th> <th>Level Factor</th> <th>Loss Factor</th> <th>Loss Factor</th> <th>Factor</th> <th></th> <th></th> </tr> <tr> <th>MHz</th> <th>dBuV/m</th> <th>dBuV/m</th> <th>dB</th> <th>dBuV</th> <th>dB/m</th> <th>dB</th> <th>dB</th> <th>cm</th> <th>deg</th> </tr> </thead> <tbody> <tr> <td>1</td> <td>2375.26</td> <td>46.78</td> <td>54.00</td> <td>-7.22</td> <td>34.56</td> <td>31.94</td> <td>7.14</td> <td>32.86</td> <td>6.00</td> <td>300</td> <td>339</td> <td>AVERAGE</td> </tr> </tbody> </table>	Limit	Read	Ant	Cable	Preamp	Aux	APos	TPos	Remark	Freq	Level	Line Margin	Level Factor	Loss Factor	Loss Factor	Factor			MHz	dBuV/m	dBuV/m	dB	dBuV	dB/m	dB	dB	cm	deg	1	2375.26	46.78	54.00	-7.22	34.56	31.94	7.14	32.86	6.00	300	339	AVERAGE	<table border="1"> <thead> <tr> <th>Limit</th> <th>Read</th> <th>Ant</th> <th>Cable</th> <th>Preamp</th> <th>Aux</th> <th>APos</th> <th>TPos</th> <th>Remark</th> </tr> <tr> <th>Freq</th> <th>Level</th> <th>Line Margin</th> <th>Level Factor</th> <th>Loss Factor</th> <th>Loss Factor</th> <th>Factor</th> <th></th> <th></th> </tr> <tr> <th>MHz</th> <th>dBuV/m</th> <th>dBuV/m</th> <th>dB</th> <th>dBuV</th> <th>dB/m</th> <th>dB</th> <th>dB</th> <th>cm</th> <th>deg</th> </tr> </thead> <tbody> <tr> <td>1</td> <td>2402.00</td> <td>89.50</td> <td>77.17</td> <td>31.99</td> <td>7.18</td> <td>32.84</td> <td>6.00</td> <td>300</td> <td>339</td> <td>AVERAGE</td> </tr> </tbody> </table>	Limit	Read	Ant	Cable	Preamp	Aux	APos	TPos	Remark	Freq	Level	Line Margin	Level Factor	Loss Factor	Loss Factor	Factor			MHz	dBuV/m	dBuV/m	dB	dBuV	dB/m	dB	dB	cm	deg	1	2402.00	89.50	77.17	31.99	7.18	32.84	6.00	300	339	AVERAGE
Limit	Read	Ant	Cable	Preamp	Aux	APos	TPos	Remark																																																																										
Freq	Level	Line Margin	Level Factor	Loss Factor	Loss Factor	Factor																																																																												
MHz	dBuV/m	dBuV/m	dB	dBuV	dB/m	dB	dB	cm	deg																																																																									
1	2375.26	46.78	54.00	-7.22	34.56	31.94	7.14	32.86	6.00	300	339	AVERAGE																																																																						
Limit	Read	Ant	Cable	Preamp	Aux	APos	TPos	Remark																																																																										
Freq	Level	Line Margin	Level Factor	Loss Factor	Loss Factor	Factor																																																																												
MHz	dBuV/m	dBuV/m	dB	dBuV	dB/m	dB	dB	cm	deg																																																																									
1	2402.00	89.50	77.17	31.99	7.18	32.84	6.00	300	339	AVERAGE																																																																								



Mode	1																																																																																			
	Harmonic																																																																																			
	2400-2483.5_Bluetooth-LE_GSKF_CH00_2402MHz																																																																																			
ANT	SISO																																																																																			
Pol.	Horizontal	Vertical																																																																																		
Peak Avg	<table border="1"> <thead> <tr> <th>Limit</th> <th>Read</th> <th>Ant</th> <th>Cable</th> <th>Preamp</th> <th>Aux</th> <th>APos</th> <th>TPos</th> <th>Remark</th> </tr> <tr> <th>Freq</th> <th>Level</th> <th>Line Margin</th> <th>Level Factor</th> <th>Loss Factor</th> <th>Factor</th> <th></th> <th></th> <th></th> </tr> <tr> <th>MHz</th> <th>dBuV/m</th> <th>dBuV/m</th> <th>dB</th> <th>dBuV</th> <th>dB/m</th> <th>dB</th> <th>dB</th> <th>cm</th> <th>deg</th> </tr> </thead> <tbody> <tr> <td>1</td> <td>4804.00</td> <td>39.25</td> <td>74.00</td> <td>-34.75</td> <td>68.34</td> <td>34.07</td> <td>10.27</td> <td>65.43</td> <td>0.00</td> <td>166</td> <td>0</td> <td>PEAK</td> </tr> </tbody> </table>	Limit	Read	Ant	Cable	Preamp	Aux	APos	TPos	Remark	Freq	Level	Line Margin	Level Factor	Loss Factor	Factor				MHz	dBuV/m	dBuV/m	dB	dBuV	dB/m	dB	dB	cm	deg	1	4804.00	39.25	74.00	-34.75	68.34	34.07	10.27	65.43	0.00	166	0	PEAK	<table border="1"> <thead> <tr> <th>Limit</th> <th>Read</th> <th>Ant</th> <th>Cable</th> <th>Preamp</th> <th>Aux</th> <th>APos</th> <th>TPos</th> <th>Remark</th> </tr> <tr> <th>Freq</th> <th>Level</th> <th>Line Margin</th> <th>Level Factor</th> <th>Loss Factor</th> <th>Factor</th> <th></th> <th></th> <th></th> </tr> <tr> <th>MHz</th> <th>dBuV/m</th> <th>dBuV/m</th> <th>dB</th> <th>dBuV</th> <th>dB/m</th> <th>dB</th> <th>dB</th> <th>cm</th> <th>deg</th> </tr> </thead> <tbody> <tr> <td>1</td> <td>4804.00</td> <td>38.81</td> <td>74.00</td> <td>-35.19</td> <td>59.90</td> <td>34.07</td> <td>10.27</td> <td>65.43</td> <td>0.00</td> <td>100</td> <td>0</td> <td>PEAK</td> </tr> </tbody> </table>	Limit	Read	Ant	Cable	Preamp	Aux	APos	TPos	Remark	Freq	Level	Line Margin	Level Factor	Loss Factor	Factor				MHz	dBuV/m	dBuV/m	dB	dBuV	dB/m	dB	dB	cm	deg	1	4804.00	38.81	74.00	-35.19	59.90	34.07	10.27	65.43	0.00	100	0	PEAK
	Limit	Read	Ant	Cable	Preamp	Aux	APos	TPos	Remark																																																																											
Freq	Level	Line Margin	Level Factor	Loss Factor	Factor																																																																															
MHz	dBuV/m	dBuV/m	dB	dBuV	dB/m	dB	dB	cm	deg																																																																											
1	4804.00	39.25	74.00	-34.75	68.34	34.07	10.27	65.43	0.00	166	0	PEAK																																																																								
Limit	Read	Ant	Cable	Preamp	Aux	APos	TPos	Remark																																																																												
Freq	Level	Line Margin	Level Factor	Loss Factor	Factor																																																																															
MHz	dBuV/m	dBuV/m	dB	dBuV	dB/m	dB	dB	cm	deg																																																																											
1	4804.00	38.81	74.00	-35.19	59.90	34.07	10.27	65.43	0.00	100	0	PEAK																																																																								
Peak Avg																																																																																				



Mode	2																																																																																																													
	Harmonic																																																																																																													
	2400-2483.5_Bluetooth-LE_GSKF_CH19_2440MHz																																																																																																													
ANT	SISO																																																																																																													
Pol.	Horizontal	Vertical																																																																																																												
Peak Avg	<table border="1"> <thead> <tr> <th>Limit</th> <th>Read</th> <th>Ant</th> <th>Cable</th> <th>Preamp</th> <th>Aux</th> <th>APos</th> <th>TPos</th> <th>Remark</th> </tr> <tr> <th>Freq</th> <th>Level</th> <th>Line Margin</th> <th>Level Factor</th> <th>Loss Factor</th> <th>Factor</th> <th></th> <th></th> <th></th> </tr> <tr> <th>MHz</th> <th>dBuV/m</th> <th>dBuV/m</th> <th>dB</th> <th>dBuV</th> <th>dB/m</th> <th>dB</th> <th>dB</th> <th>cm</th> <th>deg</th> </tr> </thead> <tbody> <tr> <td>1</td> <td>4880.00</td> <td>39.85</td> <td>74.00</td> <td>-34.15</td> <td>60.81</td> <td>34.13</td> <td>10.35</td> <td>65.44</td> <td>0.00</td> <td>300</td> <td>360</td> <td>PEAK</td> </tr> <tr> <td>2</td> <td>7320.00</td> <td>43.14</td> <td>74.00</td> <td>-30.86</td> <td>60.19</td> <td>35.41</td> <td>12.79</td> <td>65.25</td> <td>0.00</td> <td>300</td> <td>259</td> <td>PEAK</td> </tr> </tbody> </table>	Limit	Read	Ant	Cable	Preamp	Aux	APos	TPos	Remark	Freq	Level	Line Margin	Level Factor	Loss Factor	Factor				MHz	dBuV/m	dBuV/m	dB	dBuV	dB/m	dB	dB	cm	deg	1	4880.00	39.85	74.00	-34.15	60.81	34.13	10.35	65.44	0.00	300	360	PEAK	2	7320.00	43.14	74.00	-30.86	60.19	35.41	12.79	65.25	0.00	300	259	PEAK	<table border="1"> <thead> <tr> <th>Limit</th> <th>Read</th> <th>Ant</th> <th>Cable</th> <th>Preamp</th> <th>Aux</th> <th>APos</th> <th>TPos</th> <th>Remark</th> </tr> <tr> <th>Freq</th> <th>Level</th> <th>Line Margin</th> <th>Level Factor</th> <th>Loss Factor</th> <th>Factor</th> <th></th> <th></th> <th></th> </tr> <tr> <th>MHz</th> <th>dBuV/m</th> <th>dBuV/m</th> <th>dB</th> <th>dBuV</th> <th>dB/m</th> <th>dB</th> <th>dB</th> <th>cm</th> <th>deg</th> </tr> </thead> <tbody> <tr> <td>1</td> <td>4880.00</td> <td>38.01</td> <td>74.00</td> <td>-35.99</td> <td>58.97</td> <td>34.13</td> <td>10.35</td> <td>65.44</td> <td>0.00</td> <td>100</td> <td>199</td> <td>PEAK</td> </tr> <tr> <td>2</td> <td>7320.00</td> <td>43.18</td> <td>74.00</td> <td>-30.82</td> <td>60.23</td> <td>35.41</td> <td>12.79</td> <td>65.25</td> <td>0.00</td> <td>300</td> <td>251</td> <td>PEAK</td> </tr> </tbody> </table>	Limit	Read	Ant	Cable	Preamp	Aux	APos	TPos	Remark	Freq	Level	Line Margin	Level Factor	Loss Factor	Factor				MHz	dBuV/m	dBuV/m	dB	dBuV	dB/m	dB	dB	cm	deg	1	4880.00	38.01	74.00	-35.99	58.97	34.13	10.35	65.44	0.00	100	199	PEAK	2	7320.00	43.18	74.00	-30.82	60.23	35.41	12.79	65.25	0.00	300	251	PEAK
	Limit	Read	Ant	Cable	Preamp	Aux	APos	TPos	Remark																																																																																																					
Freq	Level	Line Margin	Level Factor	Loss Factor	Factor																																																																																																									
MHz	dBuV/m	dBuV/m	dB	dBuV	dB/m	dB	dB	cm	deg																																																																																																					
1	4880.00	39.85	74.00	-34.15	60.81	34.13	10.35	65.44	0.00	300	360	PEAK																																																																																																		
2	7320.00	43.14	74.00	-30.86	60.19	35.41	12.79	65.25	0.00	300	259	PEAK																																																																																																		
Limit	Read	Ant	Cable	Preamp	Aux	APos	TPos	Remark																																																																																																						
Freq	Level	Line Margin	Level Factor	Loss Factor	Factor																																																																																																									
MHz	dBuV/m	dBuV/m	dB	dBuV	dB/m	dB	dB	cm	deg																																																																																																					
1	4880.00	38.01	74.00	-35.99	58.97	34.13	10.35	65.44	0.00	100	199	PEAK																																																																																																		
2	7320.00	43.18	74.00	-30.82	60.23	35.41	12.79	65.25	0.00	300	251	PEAK																																																																																																		
Peak Avg																																																																																																														

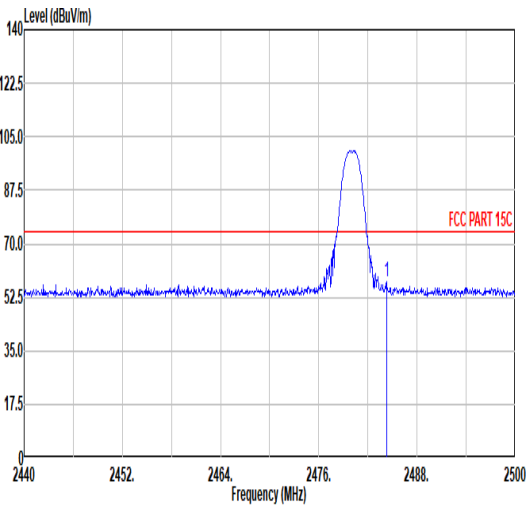
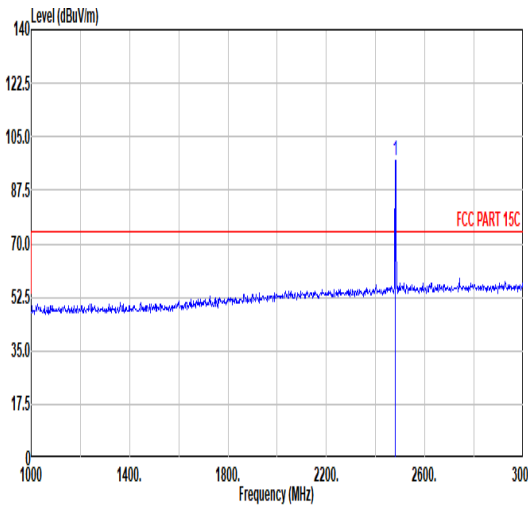
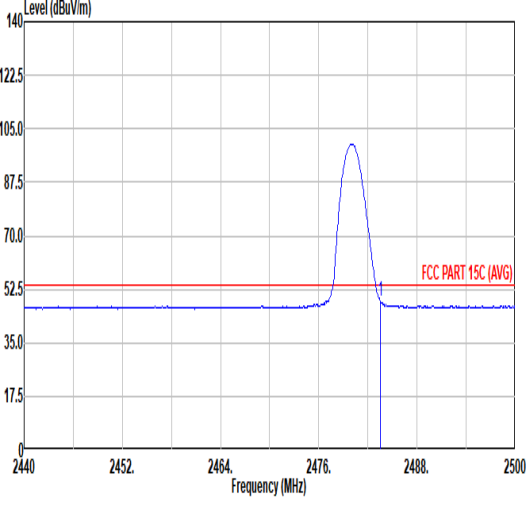
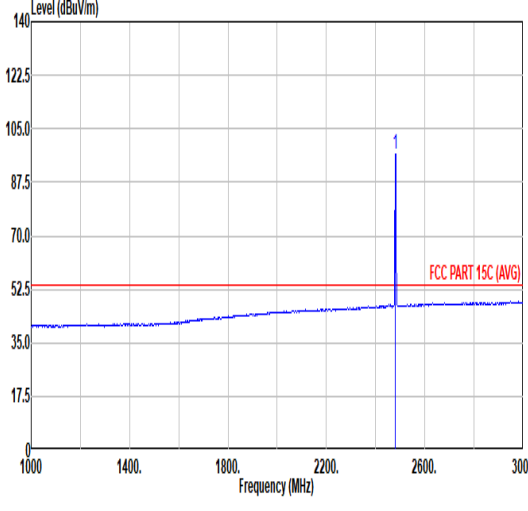

Mode	3																																																																															
	Band Edge																																																																															
	2400-2483.5_Bluetooth-LE_GSKF_CH39_2480MHz																																																																															
ANT	SISO																																																																															
Pol.	Horizontal	Fundamental																																																																														
Peak	 <table border="1" data-bbox="268 1131 774 1254"> <thead> <tr> <th>Limit</th> <th>Read</th> <th>Ant</th> <th>Cable</th> <th>Preamp</th> <th>Aux</th> <th>APos</th> <th>TPos</th> <th>Remark</th> </tr> <tr> <th>Freq</th> <th>Level</th> <th>Line Margin</th> <th>Level Factor</th> <th>Loss Factor</th> <th>Factor</th> <th></th> <th></th> <th></th> </tr> <tr> <th>MHz</th> <th>dBuV/m</th> <th>dBuV/m</th> <th>dB</th> <th>dBuV</th> <th>dB/m</th> <th>dB</th> <th>dB</th> <th>cm</th> <th>deg</th> </tr> </thead> <tbody> <tr> <td>1 2484.28</td> <td>57.43</td> <td>74.00</td> <td>-16.57</td> <td>44.75</td> <td>32.16</td> <td>7.33</td> <td>32.81</td> <td>6.00</td> <td>300</td> <td>265 PEAK</td> </tr> </tbody> </table>	Limit	Read	Ant	Cable	Preamp	Aux	APos	TPos	Remark	Freq	Level	Line Margin	Level Factor	Loss Factor	Factor				MHz	dBuV/m	dBuV/m	dB	dBuV	dB/m	dB	dB	cm	deg	1 2484.28	57.43	74.00	-16.57	44.75	32.16	7.33	32.81	6.00	300	265 PEAK	 <table border="1" data-bbox="906 1131 1412 1254"> <thead> <tr> <th>Limit</th> <th>Read</th> <th>Ant</th> <th>Cable</th> <th>Preamp</th> <th>Aux</th> <th>APos</th> <th>TPos</th> <th>Remark</th> </tr> <tr> <th>Freq</th> <th>Level</th> <th>Line Margin</th> <th>Level Factor</th> <th>Loss Factor</th> <th>Factor</th> <th></th> <th></th> <th></th> </tr> <tr> <th>MHz</th> <th>dBuV/m</th> <th>dBuV/m</th> <th>dB</th> <th>dBuV</th> <th>dB/m</th> <th>dB</th> <th>dB</th> <th>cm</th> <th>deg</th> </tr> </thead> <tbody> <tr> <td>1 2480.00</td> <td>97.30</td> <td>-----</td> <td>-----</td> <td>84.64</td> <td>32.15</td> <td>7.33</td> <td>32.82</td> <td>6.00</td> <td>145</td> <td>0 PEAK</td> </tr> </tbody> </table>	Limit	Read	Ant	Cable	Preamp	Aux	APos	TPos	Remark	Freq	Level	Line Margin	Level Factor	Loss Factor	Factor				MHz	dBuV/m	dBuV/m	dB	dBuV	dB/m	dB	dB	cm	deg	1 2480.00	97.30	-----	-----	84.64	32.15	7.33	32.82	6.00	145	0 PEAK
Limit	Read	Ant	Cable	Preamp	Aux	APos	TPos	Remark																																																																								
Freq	Level	Line Margin	Level Factor	Loss Factor	Factor																																																																											
MHz	dBuV/m	dBuV/m	dB	dBuV	dB/m	dB	dB	cm	deg																																																																							
1 2484.28	57.43	74.00	-16.57	44.75	32.16	7.33	32.81	6.00	300	265 PEAK																																																																						
Limit	Read	Ant	Cable	Preamp	Aux	APos	TPos	Remark																																																																								
Freq	Level	Line Margin	Level Factor	Loss Factor	Factor																																																																											
MHz	dBuV/m	dBuV/m	dB	dBuV	dB/m	dB	dB	cm	deg																																																																							
1 2480.00	97.30	-----	-----	84.64	32.15	7.33	32.82	6.00	145	0 PEAK																																																																						
Avg	 <table border="1" data-bbox="268 1818 774 1942"> <thead> <tr> <th>Limit</th> <th>Read</th> <th>Ant</th> <th>Cable</th> <th>Preamp</th> <th>Aux</th> <th>APos</th> <th>TPos</th> <th>Remark</th> </tr> <tr> <th>Freq</th> <th>Level</th> <th>Line Margin</th> <th>Level Factor</th> <th>Loss Factor</th> <th>Factor</th> <th></th> <th></th> <th></th> </tr> <tr> <th>MHz</th> <th>dBuV/m</th> <th>dBuV/m</th> <th>dB</th> <th>dBuV</th> <th>dB/m</th> <th>dB</th> <th>dB</th> <th>cm</th> <th>deg</th> </tr> </thead> <tbody> <tr> <td>1 2483.50</td> <td>48.36</td> <td>54.00</td> <td>-5.64</td> <td>35.69</td> <td>32.16</td> <td>7.33</td> <td>32.82</td> <td>6.00</td> <td>300</td> <td>265 AVERAGE</td> </tr> </tbody> </table>	Limit	Read	Ant	Cable	Preamp	Aux	APos	TPos	Remark	Freq	Level	Line Margin	Level Factor	Loss Factor	Factor				MHz	dBuV/m	dBuV/m	dB	dBuV	dB/m	dB	dB	cm	deg	1 2483.50	48.36	54.00	-5.64	35.69	32.16	7.33	32.82	6.00	300	265 AVERAGE	 <table border="1" data-bbox="906 1818 1412 1942"> <thead> <tr> <th>Limit</th> <th>Read</th> <th>Ant</th> <th>Cable</th> <th>Preamp</th> <th>Aux</th> <th>APos</th> <th>TPos</th> <th>Remark</th> </tr> <tr> <th>Freq</th> <th>Level</th> <th>Line Margin</th> <th>Level Factor</th> <th>Loss Factor</th> <th>Factor</th> <th></th> <th></th> <th></th> </tr> <tr> <th>MHz</th> <th>dBuV/m</th> <th>dBuV/m</th> <th>dB</th> <th>dBuV</th> <th>dB/m</th> <th>dB</th> <th>dB</th> <th>cm</th> <th>deg</th> </tr> </thead> <tbody> <tr> <td>1 2480.00</td> <td>96.82</td> <td>-----</td> <td>-----</td> <td>84.17</td> <td>32.15</td> <td>7.32</td> <td>32.82</td> <td>6.00</td> <td>145</td> <td>0 AVERAGE</td> </tr> </tbody> </table>	Limit	Read	Ant	Cable	Preamp	Aux	APos	TPos	Remark	Freq	Level	Line Margin	Level Factor	Loss Factor	Factor				MHz	dBuV/m	dBuV/m	dB	dBuV	dB/m	dB	dB	cm	deg	1 2480.00	96.82	-----	-----	84.17	32.15	7.32	32.82	6.00	145	0 AVERAGE
Limit	Read	Ant	Cable	Preamp	Aux	APos	TPos	Remark																																																																								
Freq	Level	Line Margin	Level Factor	Loss Factor	Factor																																																																											
MHz	dBuV/m	dBuV/m	dB	dBuV	dB/m	dB	dB	cm	deg																																																																							
1 2483.50	48.36	54.00	-5.64	35.69	32.16	7.33	32.82	6.00	300	265 AVERAGE																																																																						
Limit	Read	Ant	Cable	Preamp	Aux	APos	TPos	Remark																																																																								
Freq	Level	Line Margin	Level Factor	Loss Factor	Factor																																																																											
MHz	dBuV/m	dBuV/m	dB	dBuV	dB/m	dB	dB	cm	deg																																																																							
1 2480.00	96.82	-----	-----	84.17	32.15	7.32	32.82	6.00	145	0 AVERAGE																																																																						



Mode	3																																																																																																																	
	Band Edge																																																																																																																	
	2400-2483.5_Bluetooth-LE_GSKF_CH39_2480MHz																																																																																																																	
ANT	SISO																																																																																																																	
Pol.	Vertical	Fundamental																																																																																																																
Peak	<table border="1"> <thead> <tr> <th>Limit</th> <th>Read</th> <th>Ant</th> <th>Cable</th> <th>Preamp</th> <th>Aux</th> <th>APos</th> <th>TPos</th> </tr> <tr> <th>Freq</th> <th>Level</th> <th>Line Margin</th> <th>Level Factor</th> <th>Loss Factor</th> <th>Factor</th> <th></th> <th>Remark</th> </tr> <tr> <th>MHz</th> <th>dBuV/m</th> <th>dBuV/m</th> <th>dB</th> <th>dBuV</th> <th>dB/m</th> <th>dB</th> <th>dB</th> </tr> </thead> <tbody> <tr> <td>1 2486.44</td> <td>56.55</td> <td>74.00</td> <td>-17.45</td> <td>43.86</td> <td>32.16</td> <td>7.34</td> <td>32.81</td> </tr> <tr> <td></td> <td></td> <td></td> <td></td> <td></td> <td></td> <td></td> <td>6.00</td> </tr> <tr> <td></td> <td></td> <td></td> <td></td> <td></td> <td></td> <td></td> <td>145</td> </tr> <tr> <td></td> <td></td> <td></td> <td></td> <td></td> <td></td> <td></td> <td>0 PEAK</td> </tr> </tbody> </table>	Limit	Read	Ant	Cable	Preamp	Aux	APos	TPos	Freq	Level	Line Margin	Level Factor	Loss Factor	Factor		Remark	MHz	dBuV/m	dBuV/m	dB	dBuV	dB/m	dB	dB	1 2486.44	56.55	74.00	-17.45	43.86	32.16	7.34	32.81								6.00								145								0 PEAK	<table border="1"> <thead> <tr> <th>Limit</th> <th>Read</th> <th>Ant</th> <th>Cable</th> <th>Preamp</th> <th>Aux</th> <th>APos</th> <th>TPos</th> </tr> <tr> <th>Freq</th> <th>Level</th> <th>Line Margin</th> <th>Level Factor</th> <th>Loss Factor</th> <th>Factor</th> <th></th> <th>Remark</th> </tr> <tr> <th>MHz</th> <th>dBuV/m</th> <th>dBuV/m</th> <th>dB</th> <th>dBuV</th> <th>dB/m</th> <th>dB</th> <th>dB</th> </tr> </thead> <tbody> <tr> <td>1 2480.00</td> <td>100.41</td> <td>74.00</td> <td>26.41</td> <td>87.75</td> <td>32.15</td> <td>7.33</td> <td>32.82</td> </tr> <tr> <td></td> <td></td> <td></td> <td></td> <td></td> <td></td> <td></td> <td>6.00</td> </tr> <tr> <td></td> <td></td> <td></td> <td></td> <td></td> <td></td> <td></td> <td>300</td> </tr> <tr> <td></td> <td></td> <td></td> <td></td> <td></td> <td></td> <td></td> <td>265 PEAK</td> </tr> </tbody> </table>	Limit	Read	Ant	Cable	Preamp	Aux	APos	TPos	Freq	Level	Line Margin	Level Factor	Loss Factor	Factor		Remark	MHz	dBuV/m	dBuV/m	dB	dBuV	dB/m	dB	dB	1 2480.00	100.41	74.00	26.41	87.75	32.15	7.33	32.82								6.00								300								265 PEAK
Limit	Read	Ant	Cable	Preamp	Aux	APos	TPos																																																																																																											
Freq	Level	Line Margin	Level Factor	Loss Factor	Factor		Remark																																																																																																											
MHz	dBuV/m	dBuV/m	dB	dBuV	dB/m	dB	dB																																																																																																											
1 2486.44	56.55	74.00	-17.45	43.86	32.16	7.34	32.81																																																																																																											
							6.00																																																																																																											
							145																																																																																																											
							0 PEAK																																																																																																											
Limit	Read	Ant	Cable	Preamp	Aux	APos	TPos																																																																																																											
Freq	Level	Line Margin	Level Factor	Loss Factor	Factor		Remark																																																																																																											
MHz	dBuV/m	dBuV/m	dB	dBuV	dB/m	dB	dB																																																																																																											
1 2480.00	100.41	74.00	26.41	87.75	32.15	7.33	32.82																																																																																																											
							6.00																																																																																																											
							300																																																																																																											
							265 PEAK																																																																																																											
Avg	<table border="1"> <thead> <tr> <th>Limit</th> <th>Read</th> <th>Ant</th> <th>Cable</th> <th>Preamp</th> <th>Aux</th> <th>APos</th> <th>TPos</th> </tr> <tr> <th>Freq</th> <th>Level</th> <th>Line Margin</th> <th>Level Factor</th> <th>Loss Factor</th> <th>Factor</th> <th></th> <th>Remark</th> </tr> <tr> <th>MHz</th> <th>dBuV/m</th> <th>dBuV/m</th> <th>dB</th> <th>dBuV</th> <th>dB/m</th> <th>dB</th> <th>dB</th> </tr> </thead> <tbody> <tr> <td>1 2483.50</td> <td>47.55</td> <td>54.00</td> <td>-6.45</td> <td>34.88</td> <td>32.16</td> <td>7.33</td> <td>32.82</td> </tr> <tr> <td></td> <td></td> <td></td> <td></td> <td></td> <td></td> <td></td> <td>6.00</td> </tr> <tr> <td></td> <td></td> <td></td> <td></td> <td></td> <td></td> <td></td> <td>145</td> </tr> <tr> <td></td> <td></td> <td></td> <td></td> <td></td> <td></td> <td></td> <td>0 AVERAGE</td> </tr> </tbody> </table>	Limit	Read	Ant	Cable	Preamp	Aux	APos	TPos	Freq	Level	Line Margin	Level Factor	Loss Factor	Factor		Remark	MHz	dBuV/m	dBuV/m	dB	dBuV	dB/m	dB	dB	1 2483.50	47.55	54.00	-6.45	34.88	32.16	7.33	32.82								6.00								145								0 AVERAGE	<table border="1"> <thead> <tr> <th>Limit</th> <th>Read</th> <th>Ant</th> <th>Cable</th> <th>Preamp</th> <th>Aux</th> <th>APos</th> <th>TPos</th> </tr> <tr> <th>Freq</th> <th>Level</th> <th>Line Margin</th> <th>Level Factor</th> <th>Loss Factor</th> <th>Factor</th> <th></th> <th>Remark</th> </tr> <tr> <th>MHz</th> <th>dBuV/m</th> <th>dBuV/m</th> <th>dB</th> <th>dBuV</th> <th>dB/m</th> <th>dB</th> <th>dB</th> </tr> </thead> <tbody> <tr> <td>1 2480.00</td> <td>99.89</td> <td>54.00</td> <td>45.89</td> <td>87.24</td> <td>32.15</td> <td>7.32</td> <td>32.82</td> </tr> <tr> <td></td> <td></td> <td></td> <td></td> <td></td> <td></td> <td></td> <td>6.00</td> </tr> <tr> <td></td> <td></td> <td></td> <td></td> <td></td> <td></td> <td></td> <td>300</td> </tr> <tr> <td></td> <td></td> <td></td> <td></td> <td></td> <td></td> <td></td> <td>265 AVERAGE</td> </tr> </tbody> </table>	Limit	Read	Ant	Cable	Preamp	Aux	APos	TPos	Freq	Level	Line Margin	Level Factor	Loss Factor	Factor		Remark	MHz	dBuV/m	dBuV/m	dB	dBuV	dB/m	dB	dB	1 2480.00	99.89	54.00	45.89	87.24	32.15	7.32	32.82								6.00								300								265 AVERAGE
Limit	Read	Ant	Cable	Preamp	Aux	APos	TPos																																																																																																											
Freq	Level	Line Margin	Level Factor	Loss Factor	Factor		Remark																																																																																																											
MHz	dBuV/m	dBuV/m	dB	dBuV	dB/m	dB	dB																																																																																																											
1 2483.50	47.55	54.00	-6.45	34.88	32.16	7.33	32.82																																																																																																											
							6.00																																																																																																											
							145																																																																																																											
							0 AVERAGE																																																																																																											
Limit	Read	Ant	Cable	Preamp	Aux	APos	TPos																																																																																																											
Freq	Level	Line Margin	Level Factor	Loss Factor	Factor		Remark																																																																																																											
MHz	dBuV/m	dBuV/m	dB	dBuV	dB/m	dB	dB																																																																																																											
1 2480.00	99.89	54.00	45.89	87.24	32.15	7.32	32.82																																																																																																											
							6.00																																																																																																											
							300																																																																																																											
							265 AVERAGE																																																																																																											



Mode	3																																																																																																													
	Harmonic																																																																																																													
	2400-2483.5_Bluetooth-LE_GFSK_CH39_2480MHz																																																																																																													
ANT	SISO																																																																																																													
Pol.	Horizontal	Vertical																																																																																																												
Peak Avg	<table border="1"> <thead> <tr> <th>Limit</th> <th>Read</th> <th>Ant</th> <th>Cable</th> <th>Preamp</th> <th>Aux</th> <th>APos</th> <th>TPos</th> <th>Remark</th> </tr> <tr> <th>Freq</th> <th>Level</th> <th>Line Margin</th> <th>Level Factor</th> <th>Loss Factor</th> <th>Factor</th> <th>Factor</th> <th>Factor</th> <th></th> </tr> <tr> <th>MHz</th> <th>dBuV/m</th> <th>dBuV/m</th> <th>dB</th> <th>dBuV</th> <th>dB/m</th> <th>dB</th> <th>dB</th> <th>cm</th> <th>deg</th> </tr> </thead> <tbody> <tr> <td>1</td> <td>4960.00</td> <td>39.75</td> <td>74.00</td> <td>-34.25</td> <td>60.56</td> <td>34.20</td> <td>10.44</td> <td>65.45</td> <td>0.00</td> <td>100</td> <td>113</td> <td>PEAK</td> </tr> <tr> <td>2</td> <td>7440.00</td> <td>43.37</td> <td>74.00</td> <td>-30.63</td> <td>60.35</td> <td>35.42</td> <td>12.93</td> <td>65.33</td> <td>0.00</td> <td>222</td> <td>360</td> <td>PEAK</td> </tr> </tbody> </table>	Limit	Read	Ant	Cable	Preamp	Aux	APos	TPos	Remark	Freq	Level	Line Margin	Level Factor	Loss Factor	Factor	Factor	Factor		MHz	dBuV/m	dBuV/m	dB	dBuV	dB/m	dB	dB	cm	deg	1	4960.00	39.75	74.00	-34.25	60.56	34.20	10.44	65.45	0.00	100	113	PEAK	2	7440.00	43.37	74.00	-30.63	60.35	35.42	12.93	65.33	0.00	222	360	PEAK	<table border="1"> <thead> <tr> <th>Limit</th> <th>Read</th> <th>Ant</th> <th>Cable</th> <th>Preamp</th> <th>Aux</th> <th>APos</th> <th>TPos</th> <th>Remark</th> </tr> <tr> <th>Freq</th> <th>Level</th> <th>Line Margin</th> <th>Level Factor</th> <th>Loss Factor</th> <th>Factor</th> <th>Factor</th> <th>Factor</th> <th></th> </tr> <tr> <th>MHz</th> <th>dBuV/m</th> <th>dBuV/m</th> <th>dB</th> <th>dBuV</th> <th>dB/m</th> <th>dB</th> <th>dB</th> <th>cm</th> <th>deg</th> </tr> </thead> <tbody> <tr> <td>1</td> <td>4960.00</td> <td>39.52</td> <td>74.00</td> <td>-34.48</td> <td>60.33</td> <td>34.20</td> <td>10.44</td> <td>65.45</td> <td>0.00</td> <td>100</td> <td>316</td> <td>PEAK</td> </tr> <tr> <td>2</td> <td>7440.00</td> <td>45.05</td> <td>74.00</td> <td>-28.95</td> <td>62.03</td> <td>35.42</td> <td>12.93</td> <td>65.33</td> <td>0.00</td> <td>100</td> <td>70</td> <td>PEAK</td> </tr> </tbody> </table>	Limit	Read	Ant	Cable	Preamp	Aux	APos	TPos	Remark	Freq	Level	Line Margin	Level Factor	Loss Factor	Factor	Factor	Factor		MHz	dBuV/m	dBuV/m	dB	dBuV	dB/m	dB	dB	cm	deg	1	4960.00	39.52	74.00	-34.48	60.33	34.20	10.44	65.45	0.00	100	316	PEAK	2	7440.00	45.05	74.00	-28.95	62.03	35.42	12.93	65.33	0.00	100	70	PEAK
	Limit	Read	Ant	Cable	Preamp	Aux	APos	TPos	Remark																																																																																																					
Freq	Level	Line Margin	Level Factor	Loss Factor	Factor	Factor	Factor																																																																																																							
MHz	dBuV/m	dBuV/m	dB	dBuV	dB/m	dB	dB	cm	deg																																																																																																					
1	4960.00	39.75	74.00	-34.25	60.56	34.20	10.44	65.45	0.00	100	113	PEAK																																																																																																		
2	7440.00	43.37	74.00	-30.63	60.35	35.42	12.93	65.33	0.00	222	360	PEAK																																																																																																		
Limit	Read	Ant	Cable	Preamp	Aux	APos	TPos	Remark																																																																																																						
Freq	Level	Line Margin	Level Factor	Loss Factor	Factor	Factor	Factor																																																																																																							
MHz	dBuV/m	dBuV/m	dB	dBuV	dB/m	dB	dB	cm	deg																																																																																																					
1	4960.00	39.52	74.00	-34.48	60.33	34.20	10.44	65.45	0.00	100	316	PEAK																																																																																																		
2	7440.00	45.05	74.00	-28.95	62.03	35.42	12.93	65.33	0.00	100	70	PEAK																																																																																																		
Peak Avg																																																																																																														



Worse Mode	RE																																																																																																																																																																																							
	2400-2483.5_Bluetooth-LE_GSKF_CH39_2480MHz																																																																																																																																																																																							
	SISO																																																																																																																																																																																							
ANT	SISO																																																																																																																																																																																							
Pol.	Horizontal	Vertical																																																																																																																																																																																						
Peak QP	<p>Data: 1</p> <table border="1"> <thead> <tr> <th>Peak</th> <th>Freq (MHz)</th> <th>Level (dBuV/m)</th> <th>Over Limit (dB)</th> <th>Limit (dBuV/m)</th> <th>ReadAntenna Level (dBuV/m)</th> <th>Antenna Factor (dB)</th> <th>Cable Loss (dB)</th> <th>Preamp Gain (dB)</th> <th>A/Pos (cm)</th> <th>T/Pos (deg)</th> <th>Remark</th> <th>Pol/Phas</th> </tr> </thead> <tbody> <tr><td>1</td><td>53.28</td><td>27.05</td><td>-12.95</td><td>40.00</td><td>46.26</td><td>12.90</td><td>1.01</td><td>33.12</td><td>---</td><td>---</td><td>Peak</td><td>HORIZONTAL</td></tr> <tr><td>2</td><td>88.20</td><td>23.32</td><td>-26.18</td><td>43.50</td><td>48.48</td><td>11.20</td><td>1.34</td><td>32.48</td><td>---</td><td>---</td><td>Peak</td><td>HORIZONTAL</td></tr> <tr><td>3</td><td>142.52</td><td>26.77</td><td>-16.73</td><td>43.50</td><td>48.53</td><td>12.30</td><td>1.78</td><td>32.82</td><td>---</td><td>---</td><td>Peak</td><td>HORIZONTAL</td></tr> <tr><td>4</td><td>265.71</td><td>26.40</td><td>-19.40</td><td>46.00</td><td>37.61</td><td>19.80</td><td>2.23</td><td>33.04</td><td>---</td><td>---</td><td>Peak</td><td>HORIZONTAL</td></tr> <tr><td>5</td><td>384.05</td><td>27.49</td><td>-18.51</td><td>46.00</td><td>36.24</td><td>21.16</td><td>2.92</td><td>32.83</td><td>---</td><td>---</td><td>Peak</td><td>HORIZONTAL</td></tr> <tr><td>6</td><td>469.41</td><td>33.75</td><td>-12.25</td><td>46.00</td><td>40.07</td><td>23.28</td><td>3.14</td><td>32.74</td><td>---</td><td>---</td><td>Peak</td><td>HORIZONTAL</td></tr> </tbody> </table>	Peak	Freq (MHz)	Level (dBuV/m)	Over Limit (dB)	Limit (dBuV/m)	ReadAntenna Level (dBuV/m)	Antenna Factor (dB)	Cable Loss (dB)	Preamp Gain (dB)	A/Pos (cm)	T/Pos (deg)	Remark	Pol/Phas	1	53.28	27.05	-12.95	40.00	46.26	12.90	1.01	33.12	---	---	Peak	HORIZONTAL	2	88.20	23.32	-26.18	43.50	48.48	11.20	1.34	32.48	---	---	Peak	HORIZONTAL	3	142.52	26.77	-16.73	43.50	48.53	12.30	1.78	32.82	---	---	Peak	HORIZONTAL	4	265.71	26.40	-19.40	46.00	37.61	19.80	2.23	33.04	---	---	Peak	HORIZONTAL	5	384.05	27.49	-18.51	46.00	36.24	21.16	2.92	32.83	---	---	Peak	HORIZONTAL	6	469.41	33.75	-12.25	46.00	40.07	23.28	3.14	32.74	---	---	Peak	HORIZONTAL	<p>Data: 2</p> <table border="1"> <thead> <tr> <th>Peak</th> <th>Freq (MHz)</th> <th>Level (dBuV/m)</th> <th>Over Limit (dB)</th> <th>Limit (dBuV/m)</th> <th>ReadAntenna Level (dBuV/m)</th> <th>Antenna Factor (dB)</th> <th>Cable Loss (dB)</th> <th>Preamp Gain (dB)</th> <th>A/Pos (cm)</th> <th>T/Pos (deg)</th> <th>Remark</th> <th>Pol/Phas</th> </tr> </thead> <tbody> <tr><td>1</td><td>52.31</td><td>31.18</td><td>-8.82</td><td>40.00</td><td>50.05</td><td>13.20</td><td>1.01</td><td>33.08</td><td>---</td><td>---</td><td>Peak</td><td>VERTICAL</td></tr> <tr><td>2</td><td>94.99</td><td>33.89</td><td>-9.61</td><td>43.50</td><td>50.12</td><td>15.10</td><td>1.37</td><td>32.70</td><td>---</td><td>---</td><td>Peak</td><td>VERTICAL</td></tr> <tr><td>3</td><td>234.67</td><td>33.10</td><td>-12.90</td><td>46.00</td><td>47.51</td><td>16.60</td><td>2.09</td><td>33.10</td><td>---</td><td>---</td><td>Peak</td><td>VERTICAL</td></tr> <tr><td>4</td><td>265.71</td><td>36.37</td><td>-9.23</td><td>46.00</td><td>47.98</td><td>19.80</td><td>2.23</td><td>33.04</td><td>---</td><td>---</td><td>Peak</td><td>VERTICAL</td></tr> <tr><td>5</td><td>316.15</td><td>31.41</td><td>-14.59</td><td>46.00</td><td>42.89</td><td>19.30</td><td>2.62</td><td>32.90</td><td>---</td><td>---</td><td>Peak</td><td>VERTICAL</td></tr> <tr><td>6</td><td>470.38</td><td>36.08</td><td>-9.92</td><td>46.00</td><td>42.38</td><td>23.30</td><td>3.14</td><td>32.74</td><td>---</td><td>---</td><td>Peak</td><td>VERTICAL</td></tr> </tbody> </table>	Peak	Freq (MHz)	Level (dBuV/m)	Over Limit (dB)	Limit (dBuV/m)	ReadAntenna Level (dBuV/m)	Antenna Factor (dB)	Cable Loss (dB)	Preamp Gain (dB)	A/Pos (cm)	T/Pos (deg)	Remark	Pol/Phas	1	52.31	31.18	-8.82	40.00	50.05	13.20	1.01	33.08	---	---	Peak	VERTICAL	2	94.99	33.89	-9.61	43.50	50.12	15.10	1.37	32.70	---	---	Peak	VERTICAL	3	234.67	33.10	-12.90	46.00	47.51	16.60	2.09	33.10	---	---	Peak	VERTICAL	4	265.71	36.37	-9.23	46.00	47.98	19.80	2.23	33.04	---	---	Peak	VERTICAL	5	316.15	31.41	-14.59	46.00	42.89	19.30	2.62	32.90	---	---	Peak	VERTICAL	6	470.38	36.08	-9.92	46.00	42.38	23.30	3.14	32.74	---	---	Peak	VERTICAL
Peak	Freq (MHz)	Level (dBuV/m)	Over Limit (dB)	Limit (dBuV/m)	ReadAntenna Level (dBuV/m)	Antenna Factor (dB)	Cable Loss (dB)	Preamp Gain (dB)	A/Pos (cm)	T/Pos (deg)	Remark	Pol/Phas																																																																																																																																																																												
1	53.28	27.05	-12.95	40.00	46.26	12.90	1.01	33.12	---	---	Peak	HORIZONTAL																																																																																																																																																																												
2	88.20	23.32	-26.18	43.50	48.48	11.20	1.34	32.48	---	---	Peak	HORIZONTAL																																																																																																																																																																												
3	142.52	26.77	-16.73	43.50	48.53	12.30	1.78	32.82	---	---	Peak	HORIZONTAL																																																																																																																																																																												
4	265.71	26.40	-19.40	46.00	37.61	19.80	2.23	33.04	---	---	Peak	HORIZONTAL																																																																																																																																																																												
5	384.05	27.49	-18.51	46.00	36.24	21.16	2.92	32.83	---	---	Peak	HORIZONTAL																																																																																																																																																																												
6	469.41	33.75	-12.25	46.00	40.07	23.28	3.14	32.74	---	---	Peak	HORIZONTAL																																																																																																																																																																												
Peak	Freq (MHz)	Level (dBuV/m)	Over Limit (dB)	Limit (dBuV/m)	ReadAntenna Level (dBuV/m)	Antenna Factor (dB)	Cable Loss (dB)	Preamp Gain (dB)	A/Pos (cm)	T/Pos (deg)	Remark	Pol/Phas																																																																																																																																																																												
1	52.31	31.18	-8.82	40.00	50.05	13.20	1.01	33.08	---	---	Peak	VERTICAL																																																																																																																																																																												
2	94.99	33.89	-9.61	43.50	50.12	15.10	1.37	32.70	---	---	Peak	VERTICAL																																																																																																																																																																												
3	234.67	33.10	-12.90	46.00	47.51	16.60	2.09	33.10	---	---	Peak	VERTICAL																																																																																																																																																																												
4	265.71	36.37	-9.23	46.00	47.98	19.80	2.23	33.04	---	---	Peak	VERTICAL																																																																																																																																																																												
5	316.15	31.41	-14.59	46.00	42.89	19.30	2.62	32.90	---	---	Peak	VERTICAL																																																																																																																																																																												
6	470.38	36.08	-9.92	46.00	42.38	23.30	3.14	32.74	---	---	Peak	VERTICAL																																																																																																																																																																												



Appendix D. Duty Cycle Plots

Band	Duty Cycle(%)	T(ms)	1/T(kHz)	VBW Setting
Bluetooth LE 1Mbps	62.50	0.391	2.556	2.7KHz

Bluetooth LE 1Mbps

