



FCC RF Test Report

APPLICANT : Ring LLC
EQUIPMENT : Spotlight Cam Plus
BRAND NAME : Ring
MODEL NAME : 5E82E9
FCC ID : 2AEUPBHASL001
STANDARD : FCC Part 15 Subpart C §15.247
CLASSIFICATION : (DSS) Spread Spectrum Transmitter
TEST DATE(S) : Jun. 26, 2022 ~ Jul. 23, 2022

We, Sporton International Inc. (Kunshan), would like to declare that the tested sample has been evaluated in accordance with the test procedures and has been in compliance with the applicable technical standards.

The test results in this report apply exclusively to the tested model / sample. Without written approval of Sporton International Inc. (Kunshan), the test report shall not be reproduced except in full.

Jason Jia



Approved by: Jason Jia

Sporton International Inc. (Kunshan)

**No. 1098, Pengxi North Road, Kunshan Economic Development Zone Jiangsu Province 215300
People's Republic of China**



TABLE OF CONTENTS

REVISION HISTORY..... 3

SUMMARY OF TEST RESULT 4

1 GENERAL DESCRIPTION..... 5

 1.1 Applicant 5

 1.2 Manufacturer 5

 1.3 Product Feature of Equipment Under Test..... 5

 1.4 Product Specification of Equipment Under Test..... 5

 1.5 Modification of EUT 5

 1.6 Testing Location 6

 1.7 Test Software..... 6

 1.8 Applicable Standards..... 6

2 TEST CONFIGURATION OF EQUIPMENT UNDER TEST..... 7

 2.1 Carrier Frequency Channel 7

 2.2 Test Mode..... 9

 2.3 Connection Diagram of Test System..... 10

 2.4 Support Unit used in test configuration and system 11

 2.5 EUT Operation Test Setup 11

 2.6 Measurement Results Explanation Example..... 11

3 TEST RESULT 12

 3.1 Number of Channel Measurement 12

 3.2 Hopping Channel Separation Measurement 15

 3.3 Dwell Time Measurement..... 21

 3.4 20dB and 99% Bandwidth Measurement 24

 3.5 Output Power Measurement..... 35

 3.6 Conducted Band Edges Measurement..... 36

 3.7 Conducted Spurious Emission Measurement 43

 3.8 Radiated Band Edges and Spurious Emission Measurement 53

 3.9 AC Conducted Emission Measurement..... 57

 3.10 Antenna Requirements 59

4 LIST OF MEASURING EQUIPMENT..... 60

5 UNCERTAINTY OF EVALUATION..... 61

APPENDIX A. CONDUCTED TEST RESULTS

APPENDIX B. AC CONDUCTED EMISSION TEST RESULT

APPENDIX C. RADIATED SPURIOUS EMISSION

APPENDIX D. SETUP PHOTOGRAPHS



REVISION HISTORY

REPORT NO.	VERSION	DESCRIPTION	ISSUED DATE
FR251809E	Rev. 01	Initial issue of report	Sep. 02, 2022



SUMMARY OF TEST RESULT

Report Section	FCC Rule	Description	Limit	Result	Remark
3.1	15.247(a)(1)(i)	Number of Channels	15.247(a)(1)(i)	Pass	-
3.2	15.247(a)(1)	Hopping Channel Separation	20dB Bandwidth	Pass	-
3.3	15.247(a)(1)(i)	Dwell Time of Each Channel	15.247(a)(1)(i)	Pass	-
3.4	15.247(a)(1)(i)	20dB Bandwidth	≤ 500 kHz	Pass	-
3.4	-	99% Bandwidth	-	Pass	-
3.5	15.247(b)(2)	Peak Output Power	15.247(b)(2)	Pass	-
3.6	15.247(d)	Conducted Band Edges	≤ 20dBc	Pass	-
3.7	15.247(d)	Conducted Spurious Emission	≤ 20dBc	Pass	-
3.8	15.247(d)	Radiated Band Edges and Radiated Spurious Emission	15.209(a) & 15.247(d)	Pass	Under limit 12.74 dB at 971.870 MHz
3.9	15.207	AC Conducted Emission	15.207(a)	Pass	Under limit 8.57 dB at 0.255 MHz
3.10	15.203 & 15.247(b)	Antenna Requirement	N/A	Pass	-

Declaration of Conformity:
The test results with all measurement uncertainty excluded are presented in accordance with the regulation limits or requirements declared by manufacturers.

Comments and Explanations:
The declared of product specification for EUT presented in the report are provided by the manufacturer, and the manufacturer takes all the responsibilities for the accuracy of product specification.



1 General Description

1.1 Applicant

Ring LLC
12515 Cerise Ave, Hawthorne, CA 90250 USA

1.2 Manufacturer

Goertek Inc.
No.268 Dongfang Road High-Tech Industrial Development District, Weifang Shandong, China

1.3 Product Feature of Equipment Under Test

Product Feature	
Equipment	Spotlight Cam Plus
Brand Name	Ring
Model Name	5E82E9
FCC ID	2AEUPBHASL001
SN	Radiation: G9D1UL032203001H Conducted: G9D1UL0322030019 Conduction: G9D1UL0322020008
HW Version	309000143062R0
SW Version	1.3.10500
EUT Stage	Production Unit

Remark: The above EUT's information was declared by manufacturer. Please refer to the specifications or user's manual for more detailed description.

1.4 Product Specification of Equipment Under Test

Standards-related Product Specification	
Tx/Rx Frequency Range	902 MHz ~ 928 MHz
Number of Channels / Data Rate	129 chs for 50kbps 64 chs for 150kbps 51 chs for 250kbps
Maximum Output Power to Antenna	Data Rate 50kbps : 21.99 dBm (0.1581 W) Data Rate 150kbps : 21.91 dBm (0.1552 W) Data Rate 250kbps : 21.99 dBm (0.1581 W)
99% Occupied Bandwidth	Data Rate 50kbps : 0.104 MHz Data Rate 150kbps : 0.159 MHz Data Rate 250kbps : 0.255 MHz
Antenna Type / Gain	PIFA Antenna with gain -1.81 dBi
Type of Modulation	FSK

1.5 Modification of EUT

No modifications are made to the EUT during all test items.



1.6 Testing Location

Sporton International Inc. (Kunshan) is accredited to ISO/IEC 17025:2017 by American Association for Laboratory Accreditation with Certificate Number 5145.02.

Test Firm	Sporton International Inc. (Kunshan)		
Test Site Location	No. 1098, Pengxi North Road, Kunshan Economic Development Zone Jiangsu Province 215300 People's Republic of China TEL : +86-512-57900158 FAX : +86-512-57900958		
Test Site No.	Sporton Site No.	FCC Designation No.	FCC Test Firm Registration No.
	CO01-KS 03CH08-KS TH01-KS	CN1257	314309

1.7 Test Software

Item	Site	Manufacture	Name	Version
1.	03CH08-KS	AUDIX	E3	6.2009-8-24
2.	CO01-KS	AUDIX	E3	6.2009-8-24

1.8 Applicable Standards

According to the specifications of the manufacturer, the EUT must comply with the requirements of the following standards:

- 47 CFR Part 15 Subpart C §15.247
- FCC KDB 558074 D01 15.247 Meas Guidance v05r02
- ANSI C63.10-2013

Remark:

1. All test items were verified and recorded according to the standards and without any deviation during the test.
2. This EUT has also been tested and complied with the requirements of FCC Part 15, Subpart B, recorded in a separate test report.



2 Test Configuration of Equipment Under Test

2.1 Carrier Frequency Channel

Frequency Band	Channel	Freq. (MHz)	Channel	Freq. (MHz)	Channel	Freq. (MHz)
902-928 MHz (50Kbps)	1	902.2	44	910.8	87	919.4
	2	902.4	45	911	88	919.6
	3	902.6	46	911.2	89	919.8
	4	902.8	47	911.4	90	920
	5	903	48	911.6	91	920.2
	6	903.2	49	911.8	92	920.4
	7	903.4	50	912	93	920.6
	8	903.6	51	912.2	94	920.8
	9	903.8	52	912.4	95	921
	10	904	53	912.6	96	921.2
	11	904.2	54	912.8	97	921.4
	12	904.4	55	913	98	921.6
	13	904.6	56	913.2	99	921.8
	14	904.8	57	913.4	100	922
	15	905	58	913.6	101	922.2
	16	905.2	59	913.8	102	922.4
	17	905.4	60	914	103	922.6
	18	905.6	61	914.2	104	922.8
	19	905.8	62	914.4	105	923
	20	906	63	914.6	106	923.2
	21	906.2	64	914.8	107	923.4
	22	906.4	65	915	108	923.6
	23	906.6	66	915.2	109	923.8
	24	906.8	67	915.4	110	924
	25	907	68	915.6	111	924.2
	26	907.2	69	915.8	112	924.4
	27	907.4	70	916	113	924.6
	28	907.6	71	916.2	114	924.8
	29	907.8	72	916.4	115	925
	30	908	73	916.6	116	925.2
	31	908.2	74	916.8	117	925.4
	32	908.4	75	917	118	925.6
	33	908.6	76	917.2	119	925.8
	34	908.8	77	917.4	120	926
	35	909	78	917.6	121	926.2
	36	909.2	79	917.8	122	926.4
	37	909.4	80	918	123	926.6
	38	909.6	81	918.2	124	926.8
	39	909.8	82	918.4	125	927
	40	910	83	918.6	126	927.2
	41	910.2	84	918.8	127	927.4
	42	910.4	85	919	128	927.6
	43	910.6	86	919.2	129	927.8

Note: The above EUT's information was declared by manufacturer.



Frequency Band	Channel	Freq. (MHz)	Channel	Freq. (MHz)	Channel	Freq. (MHz)
902-928 MHz (150Kbps)	1	902.4	23	911.2	45	920
	2	902.8	24	911.6	46	920.4
	3	903.2	25	912	47	920.8
	4	903.6	26	912.4	48	921.2
	5	904	27	912.8	49	921.6
	6	904.4	28	913.2	50	922
	7	904.8	29	913.6	51	922.4
	8	905.2	30	914	52	922.8
	9	905.6	31	914.4	53	923.2
	10	906	32	914.8	54	923.6
	11	906.4	33	915.2	55	924
	12	906.8	34	915.6	56	924.4
	13	907.2	35	916	57	924.8
	14	907.6	36	916.4	58	925.2
	15	908	37	916.8	59	925.6
	16	908.4	38	917.2	60	926
	17	908.8	39	917.6	61	926.4
	18	909.2	40	918	62	926.8
	19	909.6	41	918.4	63	927.2
	20	910	42	918.8	64	927.6
	21	910.4	43	919.2		
	22	910.8	44	919.6		

Note: The above EUT's information was declared by manufacturer.

Frequency Band	Channel	Freq. (MHz)	Channel	Freq. (MHz)	Channel	Freq. (MHz)
902-928 MHz (250Kbps)	1	902.5	18	911.0	35	919.5
	2	903.0	19	911.5	36	920.0
	3	903.5	20	912.0	37	920.5
	4	904.0	21	912.5	38	921.0
	5	904.5	22	913.0	39	921.5
	6	905.0	23	913.5	40	922.0
	7	905.5	24	914.0	41	922.5
	8	906.0	25	914.5	42	923.0
	9	906.5	26	915.0	43	923.5
	10	907.0	27	915.5	44	924.0
	11	907.5	28	916.0	45	924.5
	12	908.0	29	916.5	46	925.0
	13	908.5	30	917.0	47	925.5
	14	909.0	31	917.5	48	926.0
	15	909.5	32	918.0	49	926.5
	16	910.0	33	918.5	50	927.0
	17	910.5	34	919.0	51	927.5

Note: The above EUT's information was declared by manufacturer.

2.2 Test Mode

- a. The EUT has been associated with peripherals and configuration operated in a manner tended to maximize its emission characteristics in a typical application. Frequency range investigated: conduction emission (150 kHz to 30 MHz), radiation emission (9 kHz to the 10th harmonic of the highest fundamental frequency or to 40 GHz, whichever is lower) For radiated measurement, pre-scanned in three orthogonal panels, X, Y, Z. The worst cases (Y plane) were recorded in this report,
- b. AC power line Conducted Emission was tested under maximum output power.

The following summary table is showing all test modes to demonstrate in compliance with the standard.

Summary table of Test Cases			
Test Item	Modulation / Data Rate		
	FSK FHSS / 50kbps	FSK FHSS / 150kbps	FSK FHSS / 250kbps
Conducted Test Cases	Low: 902.2 MHz Mid: 915 MHz High: 927.8 MHz	Low: 902.4 MHz Mid: 914.8 MHz High: 927.6 MHz	Low: 902.5 MHz Mid: 915 MHz High: 927.5 MHz
Radiated Test Cases	Low: 902.2 MHz Mid: 915 MHz High: 927.8 MHz	Low: 902.4 MHz Mid: 914.8 MHz High: 927.6 MHz	Low: 902.5 MHz Mid: 915 MHz High: 927.5 MHz
AC Conducted Emission	Mode 1: Lora Tx + Bluetooth Link + WLAN Link(2.4G) + Adapter + Battery 3		

Note: The accessories are chosen from Part 15B worst cases.

2.3 Connection Diagram of Test System

For AC Conducted Emission:

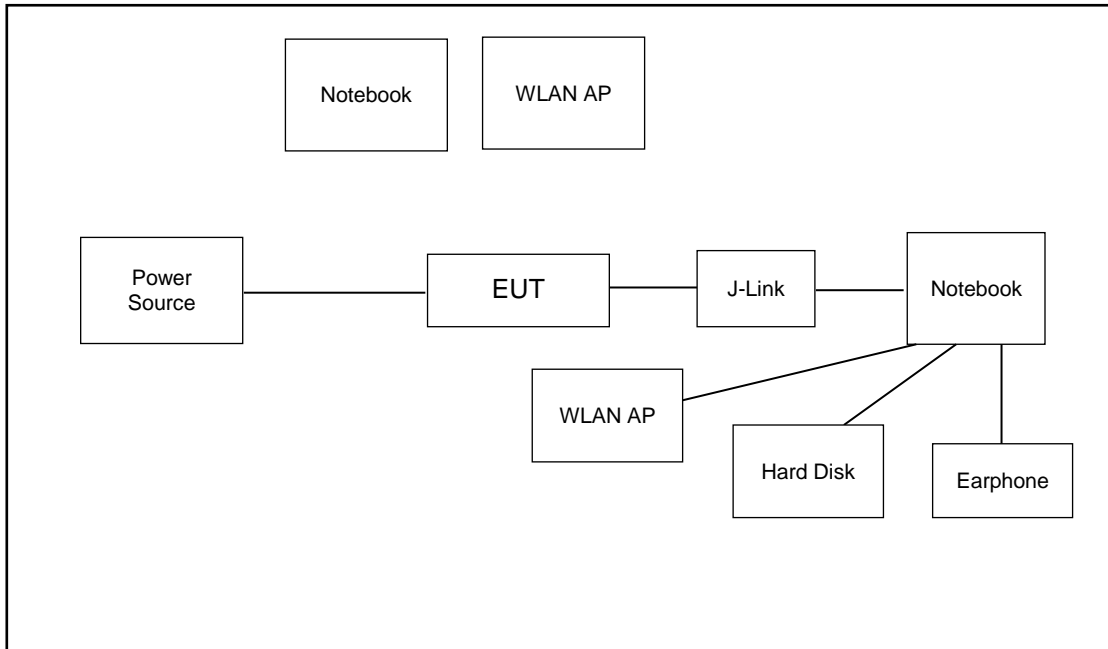

For Radiated Emission:

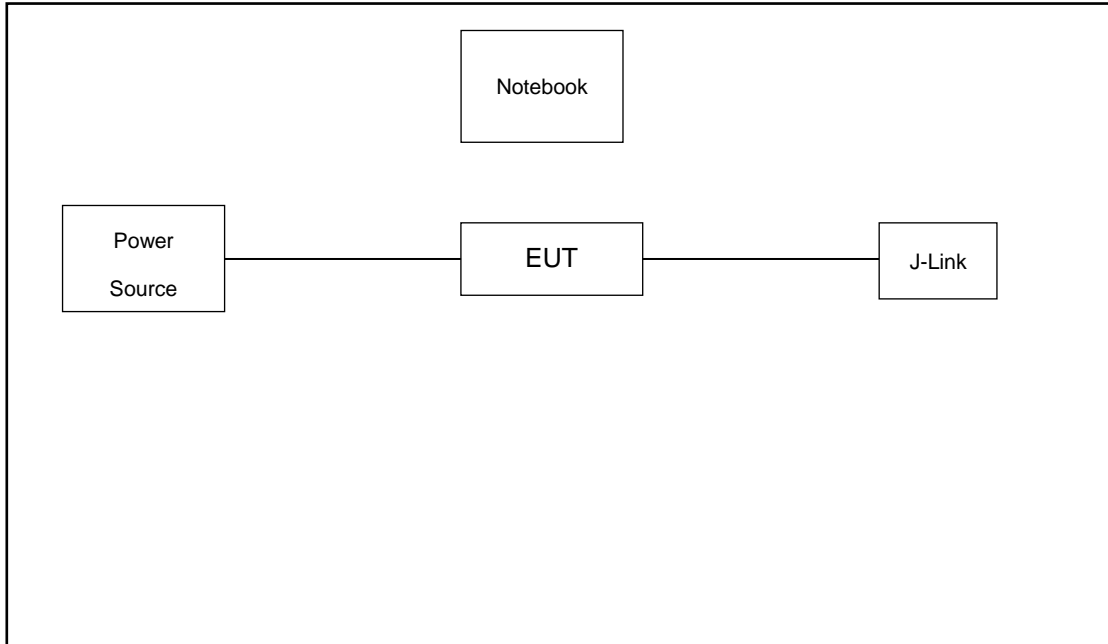

2.4 Support Unit used in test configuration and system

Item	Equipment	Trade Name	Model Name	FCC ID	Data Cable	Power Cord
1.	WLAN AP	LINKSYS	WRT1900ACSV2	N/A	N/A	Unshielded,1.8m
2.	Notebook	Honor	Magicbook 16	N/A	N/A	AC I/P: Unshielded, 1.8 m DC O/P: Shielded, 1.8 m
3.	Earphone	Lenovo	P121	N/A	N/A	Unshielded,1.2m
4.	Hard Disk	Lenovo	F310	DoC	Shielded, 1.2m	N/A
5.	J-Link	N/A	N/A	N/A	N/A	N/A

2.5 EUT Operation Test Setup

For FSK FHSS function, the engineering test program was provided and enabled to make EUT continuous transmit/receive.

For AC power line conducted emissions, the EUT was set to connect with the WLAN AP under large package sizes transmission.

2.6 Measurement Results Explanation Example

For all conducted test items:

The offset level is set in the spectrum analyzer to compensate the RF cable loss and attenuator factor between EUT conducted output port and spectrum analyzer. With the offset compensation, the spectrum analyzer reading level is exactly the EUT RF output level.

Example:

The spectrum analyzer offset is derived from RF cable loss and attenuator factor.

Offset = RF cable loss + attenuator factor.

Following shows an offset computation example with cable loss 5.0 dB and 10dB attenuator.

$$\begin{aligned}
 \text{Offset(dB)} &= \text{RF cable loss(dB)} + \text{attenuator factor(dB)}. \\
 &= 5.0 + 10 = 15.0 \text{ (dB)}
 \end{aligned}$$

3 Test Result

3.1 Number of Channel Measurement

3.1.1 Limits of Number of Hopping Frequency

For frequency hopping systems operating in the 902-928 MHz band: if the 20 dB bandwidth of the hopping channel is less than 250 kHz, the system shall use at least 50 hopping frequencies and the average time of occupancy on any frequency shall not be greater than 0.4 seconds within a 20 second period; if the 20 dB bandwidth of the hopping channel is 250 kHz or greater, the system shall use at least 25 hopping frequencies and the average time of occupancy on any frequency shall not be greater than 0.4 seconds within a 10 second period.

3.1.2 Measuring Instruments

The measuring equipment is listed in the section 4 of this test report.

3.1.3 Test Procedure

1. The testing follows ANSI C63.10-2013 clause 7.8.3.
2. The RF output of EUT was connected to the spectrum analyzer by RF cable and attenuator. The path loss was compensated to the results for each measurement.
3. Set to the maximum power setting and enable the EUT transmit continuously.
4. Enable the EUT hopping function.
5. Use the following spectrum analyzer settings: Span = the frequency band of operation;
RBW = 50kHz, VBW = 200kHz (for 50kbps);
RBW = 100kHz, VBW = 300kHz (for 150kbps);
RBW = 100kHz, VBW = 300kHz (for 250kbps);
Sweep = auto; Detector function = peak; Trace = max hold.
6. The number of hopping frequency used is defined as the number of total channel.
7. Record the measurement data derived from spectrum analyzer.

3.1.4 Test Setup

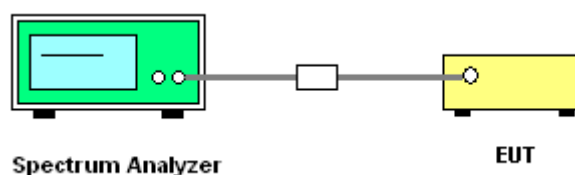



3.1.5 Test Result of Number of Hopping Frequency

Please refer to Appendix A.

Number of Hopping Channel Plot (Data Rate 50kbps)

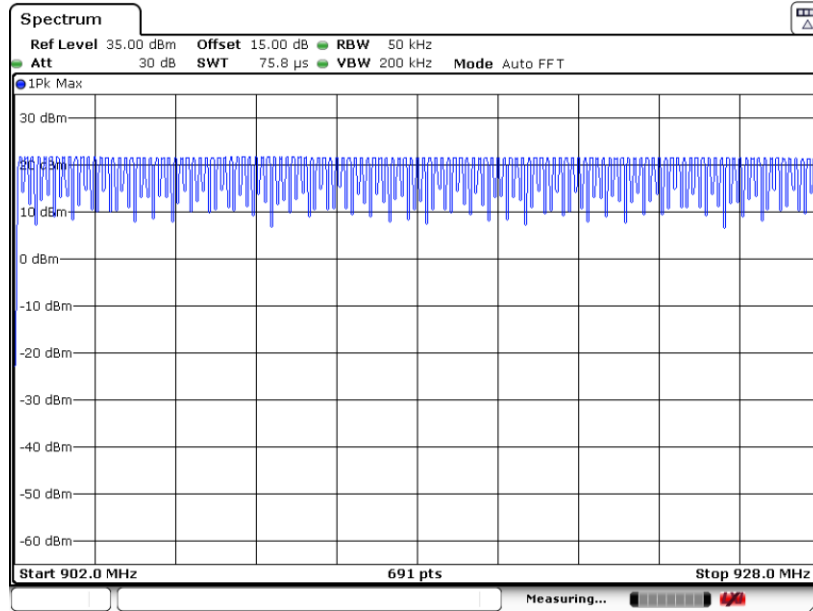

Number of Hopping Channel Plot (Data Rate 150kbps)

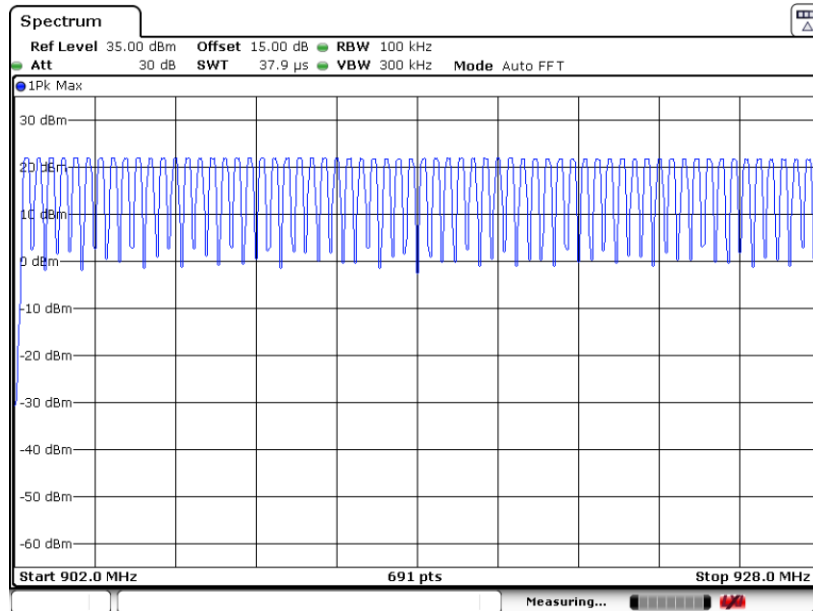



Number of Hopping Channel Plot (Data Rate 250kbps)

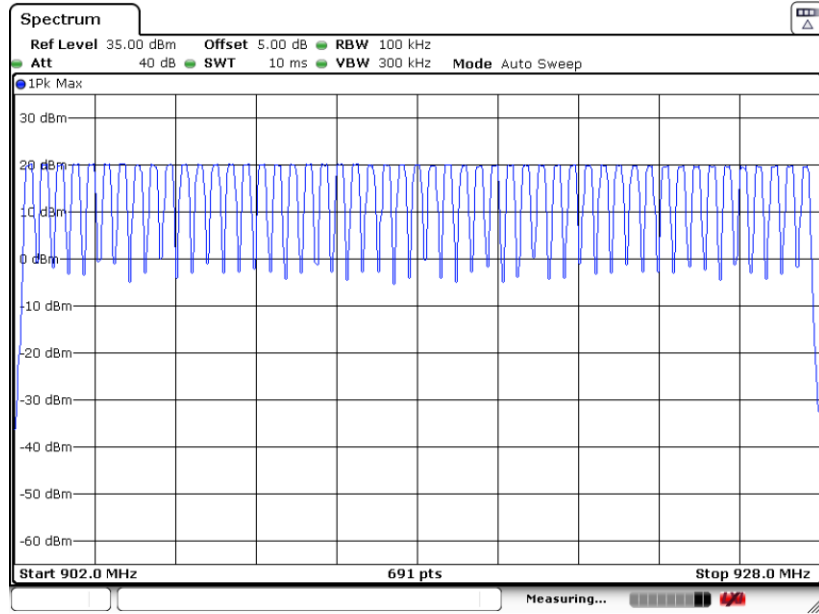

Date: 18 JUL 2022 14:33:02

3.2 Hopping Channel Separation Measurement

3.2.1 Limit of Hopping Channel Separation

Frequency hopping systems shall have hopping channel carrier frequencies separated by a minimum of 25 kHz or the 20 dB bandwidth of the hopping channel, whichever is greater.

3.2.2 Measuring Instruments

The measuring equipment is listed in the section 4 of this test report.

3.2.3 Test Procedures

1. The testing follows ANSI C63.10-2013 clause 7.8.2.
2. The RF output of EUT was connected to the spectrum analyzer by RF cable and attenuator. The path loss was compensated to the results for each measurement.
3. Set to the maximum power setting and enable the EUT transmit continuously.
4. Enable the EUT hopping function.
5. Use the following spectrum analyzer settings:
 - Span = wide enough to capture the peaks of two adjacent channels;
 - RBW = 50kHz, VBW = 200kHz (for 50kbps);
 - RBW = 100kHz, VBW = 300kHz (for 150kbps);
 - RBW = 200kHz, VBW = 500kHz (for 250kbps);
 - Sweep = auto; Detector function = peak; Trace = max hold.
6. Measure and record the results in the test report.

3.2.4 Test Setup

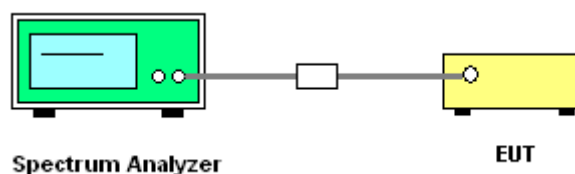

3.2.5 Test Result of Hopping Channel Separation

Please refer to Appendix A.



<Data Rate 50kbps>

Channel Separation Plot on Low CH

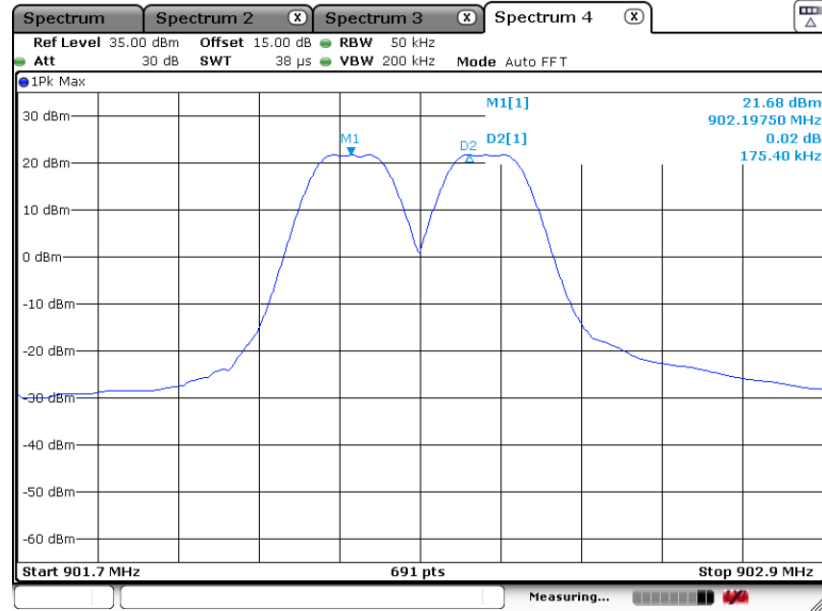

Channel Separation Plot on Mid CH

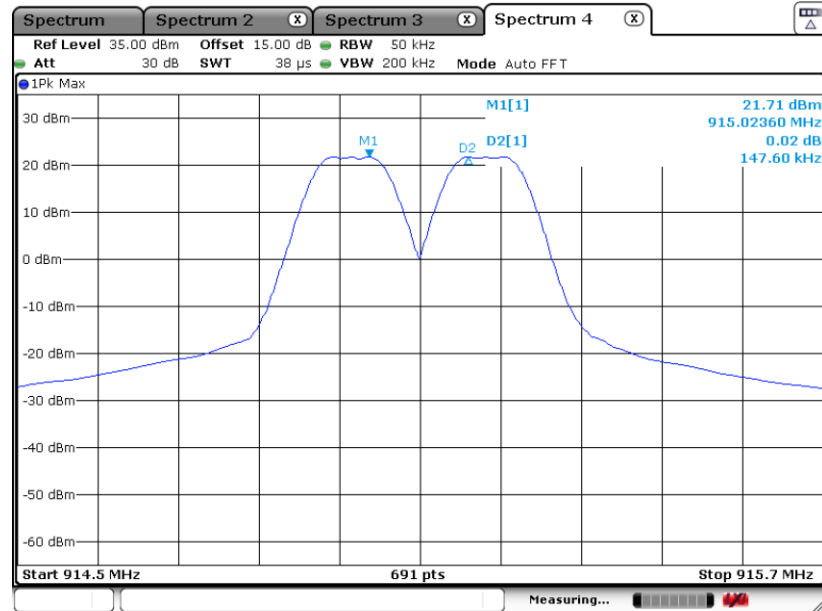



Channel Separation Plot on High CH

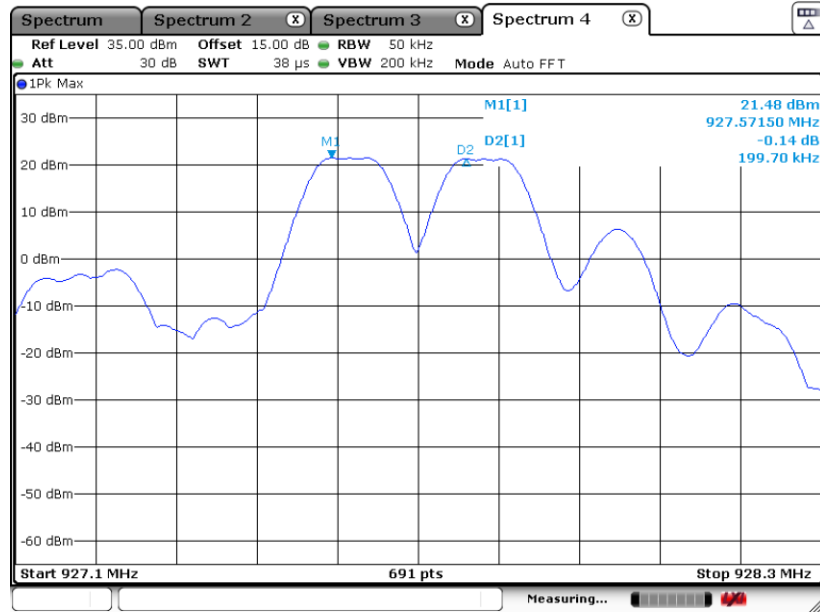

Date: 27.JUN.2022 04:04:14

<Data Rate 150kbps>

Channel Separation Plot on Low CH

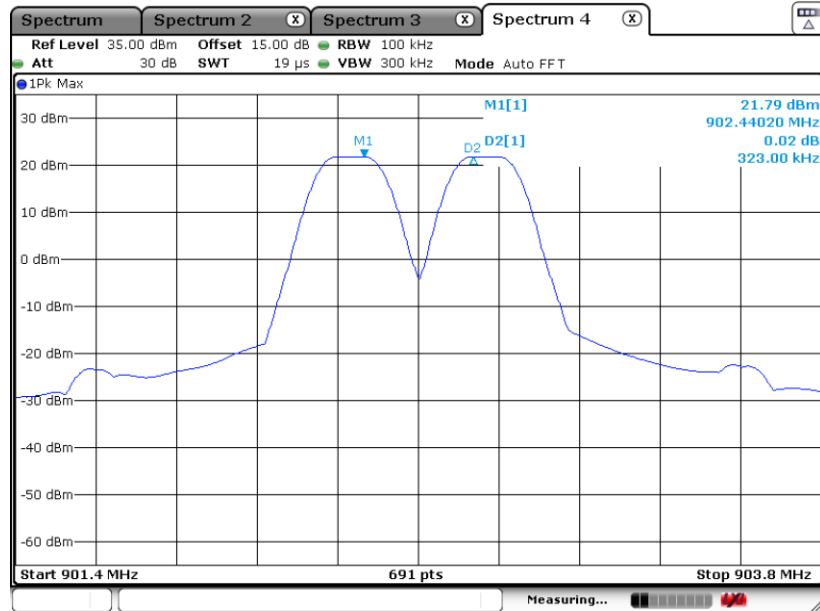

Date: 27.JUN.2022 04:44:37



Channel Separation Plot on Mid CH

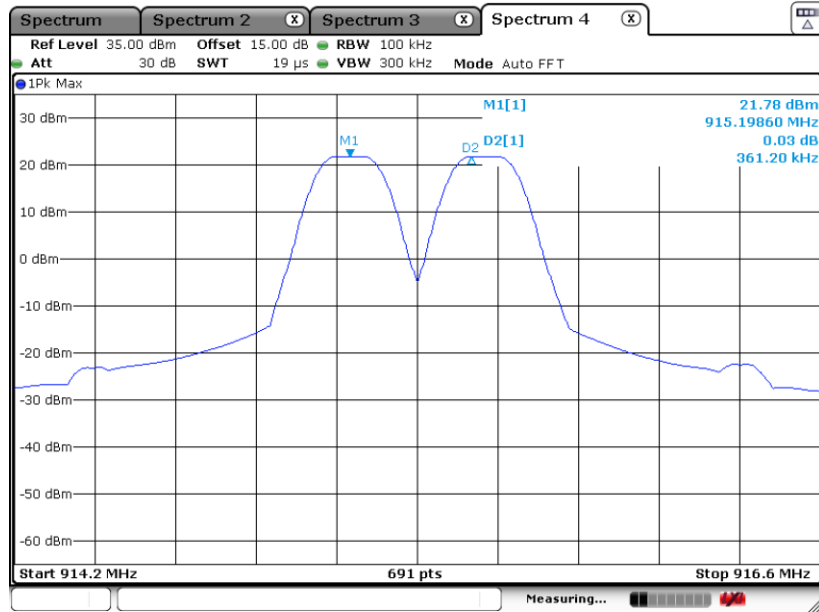

Date: 27.JUN.2022 05:12:49

Channel Separation Plot on High CH

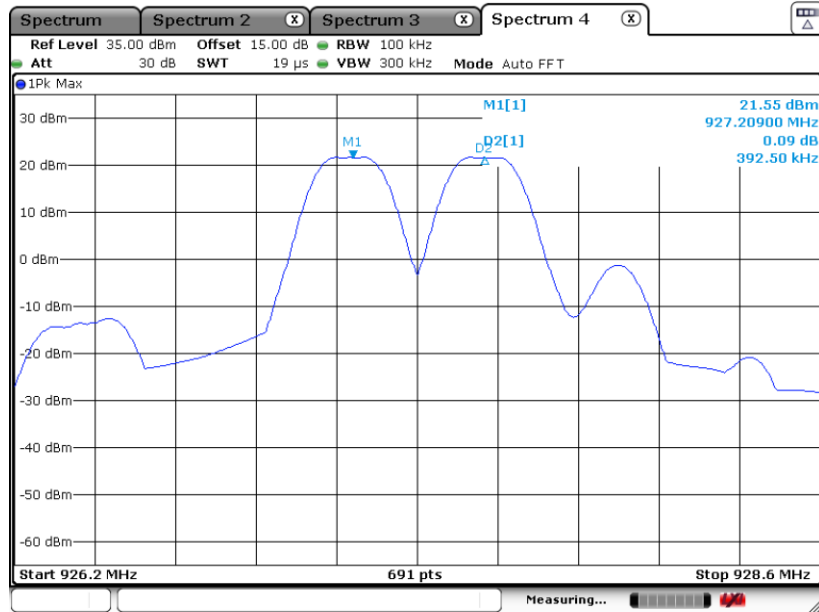

Date: 27.JUN.2022 05:15:29



<Data Rate 250kbps>

Channel Separation Plot on Low CH

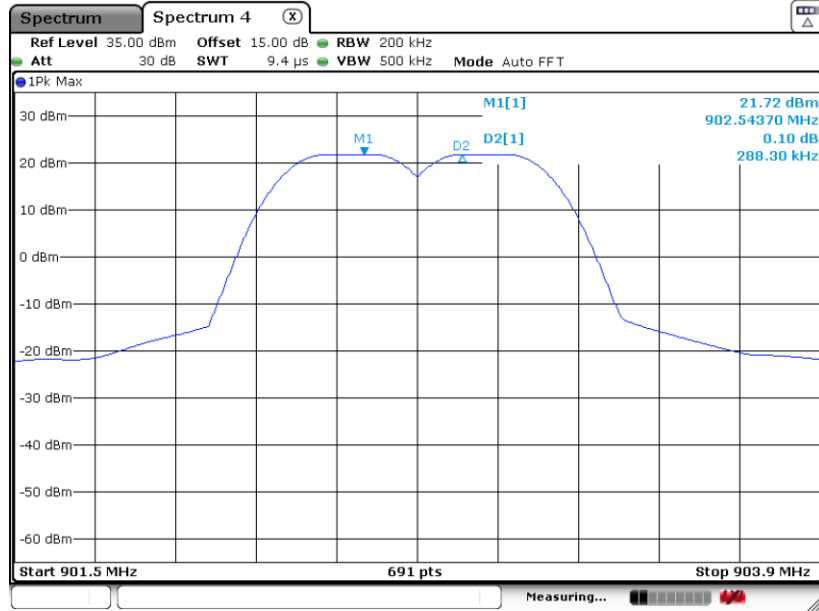

Channel Separation Plot on Mid CH

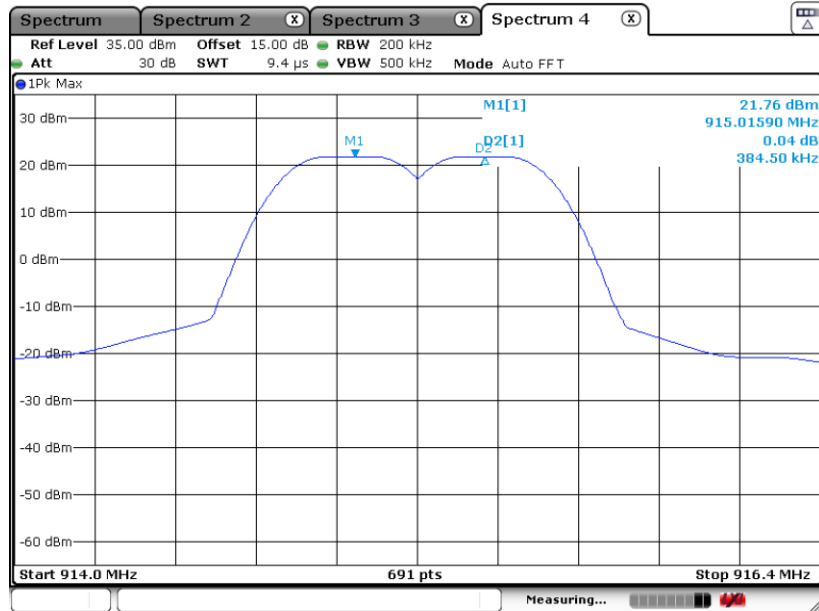



Channel Separation Plot on High CH

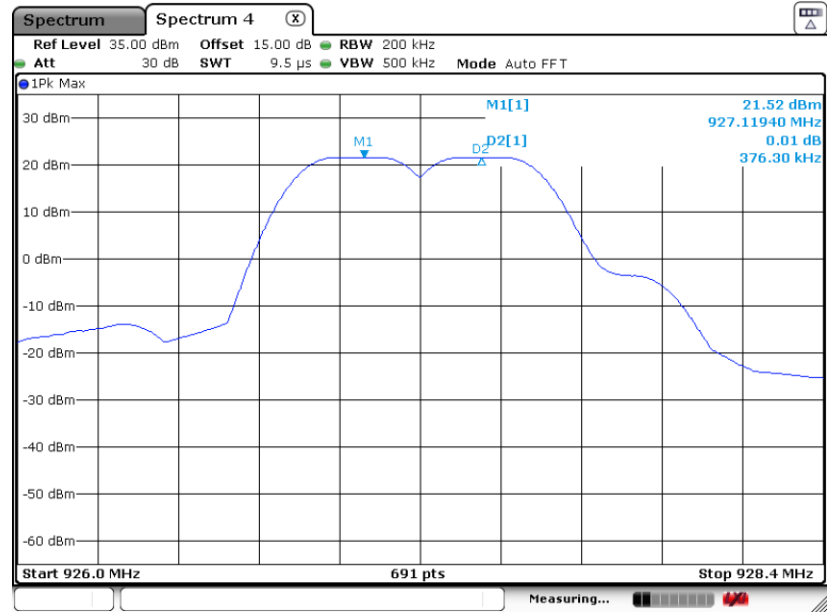

Date: 27.JUN.2022 06:31:18

3.3 Dwell Time Measurement

3.3.1 Limit of Dwell Time

For frequency hopping systems operating in the 902-928 MHz band: if the 20 dB bandwidth of the hopping channel is less than 250 kHz, the system shall use at least 50 hopping frequencies and the average time of occupancy on any frequency shall not be greater than 0.4 seconds within a 20 second period; if the 20 dB bandwidth of the hopping channel is 250 kHz or greater, the system shall use at least 25 hopping frequencies and the average time of occupancy on any frequency shall not be greater than 0.4 seconds within a 10 second period.

3.3.2 Measuring Instruments

The measuring equipment is listed in the section 4 of this test report.

3.3.3 Test Procedures

1. The testing follows ANSI C63.10-2013 clause 7.8.4.
2. The RF output of EUT was connected to the spectrum analyzer by RF cable and attenuator. The path loss was compensated to the results for each measurement.
3. Set to the maximum power setting and enable the EUT transmit continuously.
4. Enable the EUT hopping function.
5. Use the following spectrum analyzer settings: Span = zero span, centered on a hopping channel; RBW = 20 KHz; VBW = 20 KHz; Sweep = as necessary to capture the entire dwell time per hopping channel; Detector function = peak; Trace = max hold.
6. Measure and record the results in the test report.

3.3.4 Test Setup

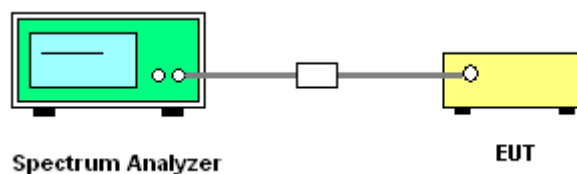



3.3.5 Test Result of Dwell Time

Please refer to Appendix A.

DT on-time and Hops over 20 sec period for Data Rate 50kbps

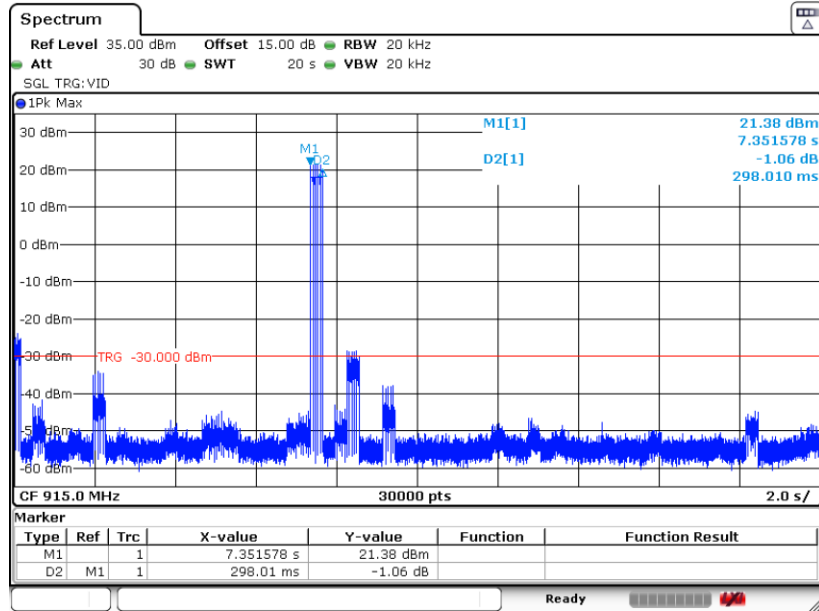

Remark:

$$\begin{aligned}
 \text{Dwell Time(s)} &= \text{Hops Over Occupancy Time (hops)} \times \text{Package Transfer Time} \\
 &= 1 \text{ (hop)} \times 298.01 \text{ (ms)} \\
 &= 0.298 \text{ (sec)}
 \end{aligned}$$



DT on-time and Hops over 20 sec period for Data Rate 150kbps

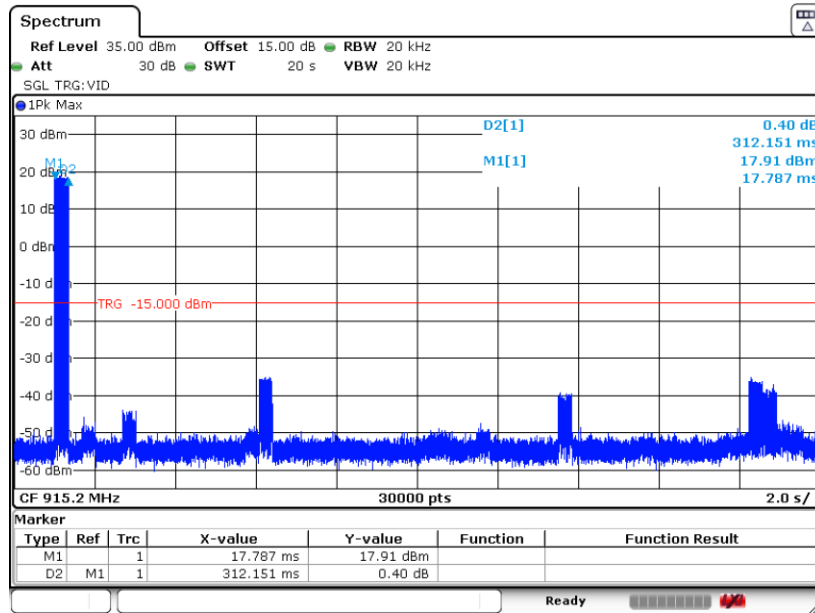

Date: 11.JUL.2022 16:51:29

Remark:

$$\begin{aligned} \text{Dwell Time(s)} &= \text{Hops Over Occupancy Time (hops)} \times \text{Package Transfer Time} \\ &= 1 \text{ (hop)} \times 312.151 \text{ (ms)} \\ &= 0.312 \text{ (sec)} \end{aligned}$$

DT on-time and Hops over 10 sec period for Data Rate 250kbps

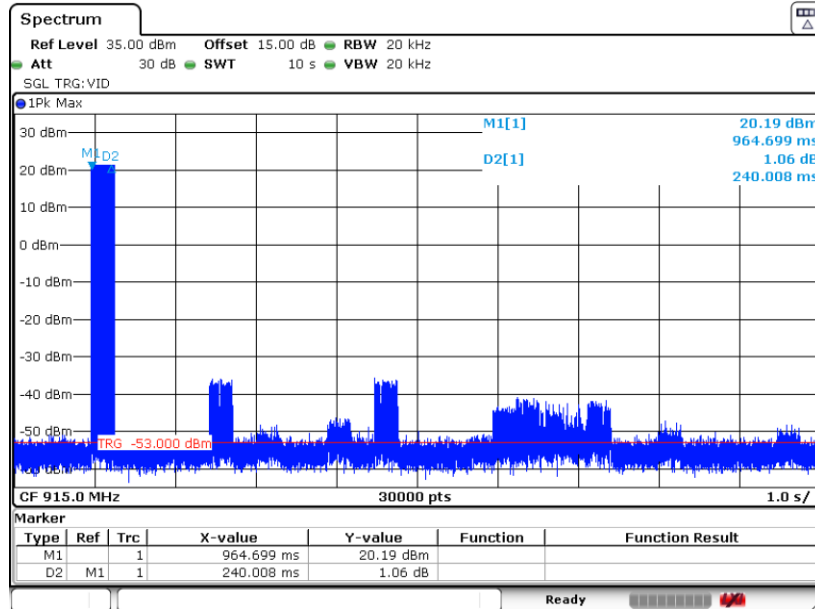

Date: 27.JUN.2022 06:51:52

Remark:

$$\begin{aligned} \text{Dwell Time(s)} &= \text{Hops Over Occupancy Time (hops)} \times \text{Package Transfer Time} \\ &= 1 \text{ (hop)} \times 240.008 \text{ (ms)} \\ &= 0.240 \text{ (sec)} \end{aligned}$$

3.4 20dB and 99% Bandwidth Measurement

3.4.1 Limit of 20dB and 99% Bandwidth

The maximum allowed 20 dB bandwidth of the hopping channel is 500 kHz.

3.4.2 Measuring Instruments

The measuring equipment is listed in the section 4 of this test report.

3.4.3 Test Procedures

1. The testing follows ANSI C63.10-2013 clause 6.9.2 and 6.9.3.
2. The RF output of EUT was connected to the spectrum analyzer by RF cable and attenuator. The path loss was compensated to the results for each measurement.
3. Set to the maximum power setting and enable the EUT transmit continuously.
4. Use the following spectrum analyzer settings for 20dB Bandwidth measurement.
Span = approximately 2 to 5 times the 20 dB bandwidth, centered on a hopping channel;
RBW \geq 1% of the 20 dB bandwidth; VBW \geq RBW; Sweep = auto; Detector function = peak;
Trace = max hold.
5. Use the following spectrum analyzer settings for 99 % Bandwidth measurement.
Span = approximately 1.5 to 5 times the 99% bandwidth, centered on a hopping channel;
RBW \geq 1% of the 99% bandwidth; VBW \geq RBW; Sweep = auto; Detector function = sample;
Trace = max hold.
6. Measure and record the results in the test report.

3.4.4 Test Setup

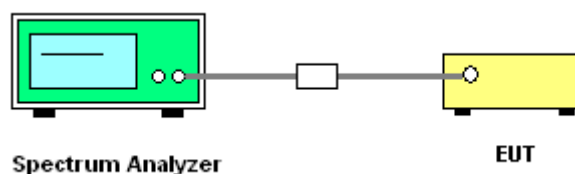

3.4.5 Test Result of 20dB Bandwidth

Please refer to Appendix A.



<Data Rate 50kbps>

20 dB Bandwidth Plot on Low Channel

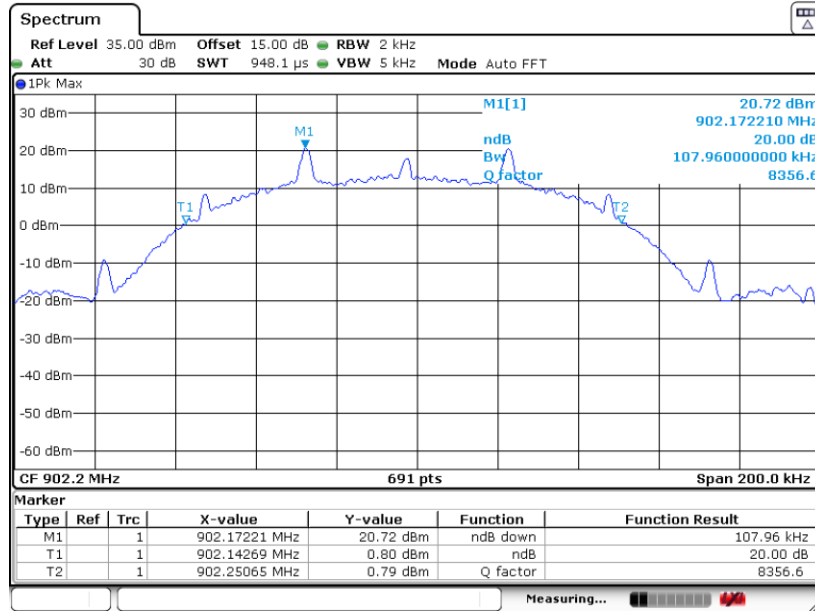

Date: 26 JUN.2022 14:16:05

20 dB Bandwidth Plot on Mid Channel

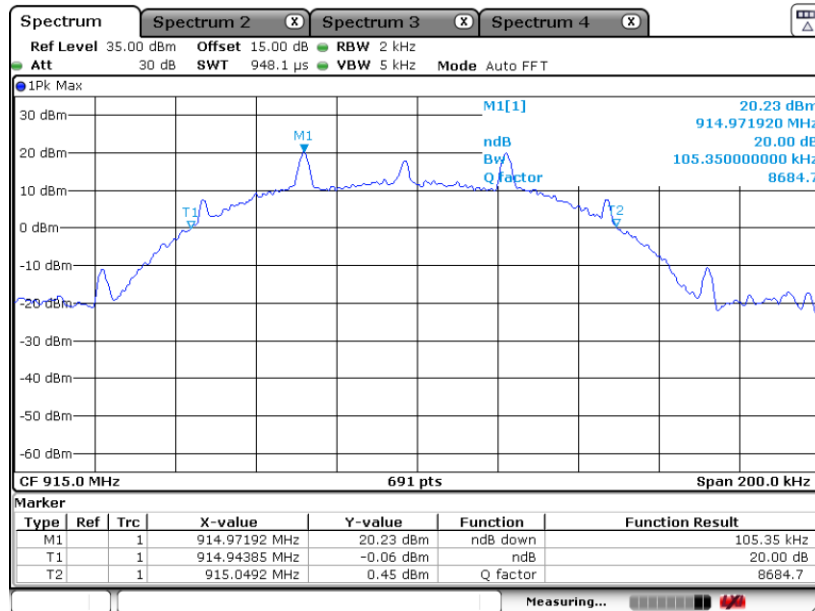

Date: 27 JUN.2022 03:48:14



20 dB Bandwidth Plot on High Channel

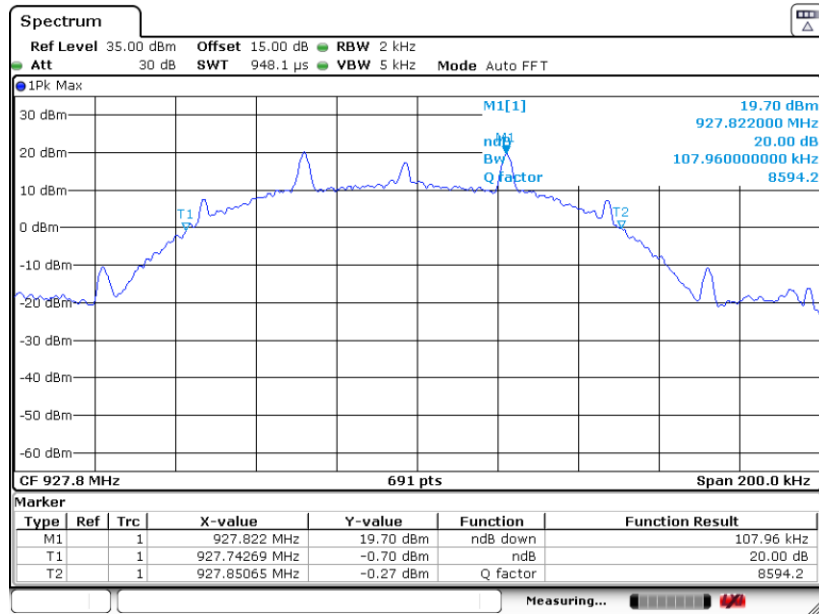

Date: 27.JUN.2022 03:59:27

<Data Rate 150kbps>

20 dB Bandwidth Plot on Low Channel

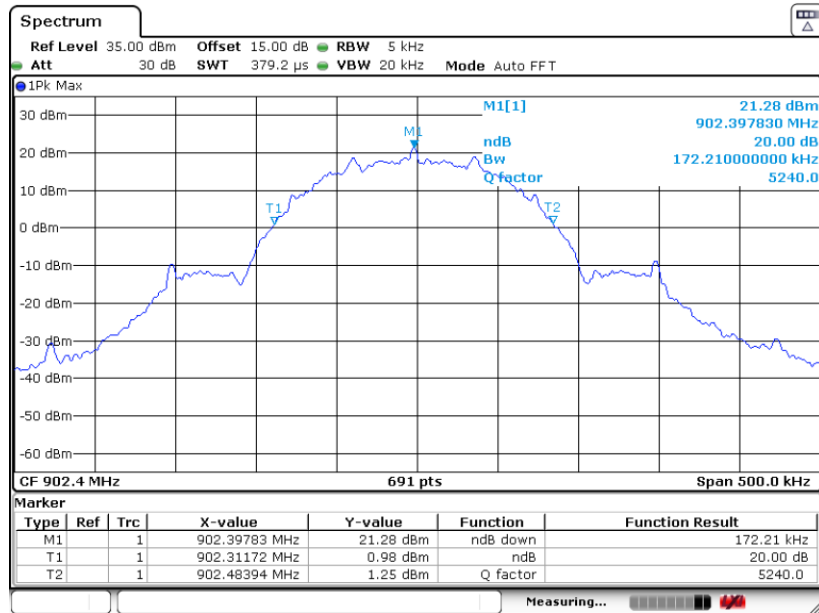

Date: 27.JUN.2022 04:36:23



20 dB Bandwidth Plot on Mid Channel

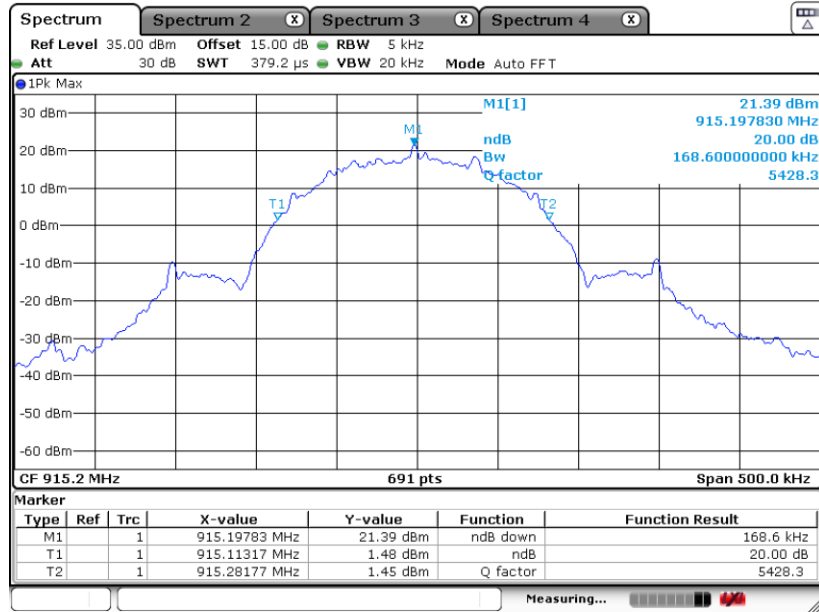

Date: 27.JUN.2022 05:09:47

20 dB Bandwidth Plot on High Channel

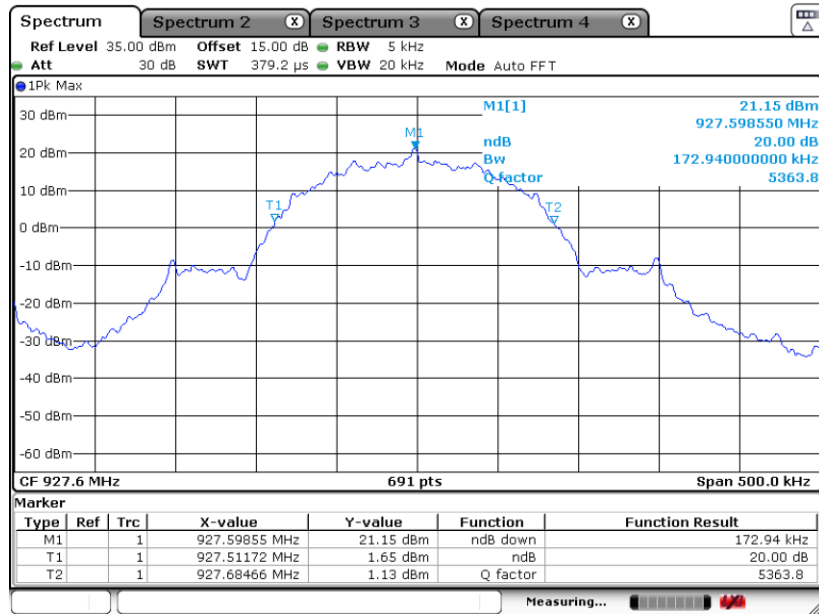

Date: 27.JUN.2022 05:17:19



<Data Rate 250kbps>

20 dB Bandwidth Plot on Low Channel

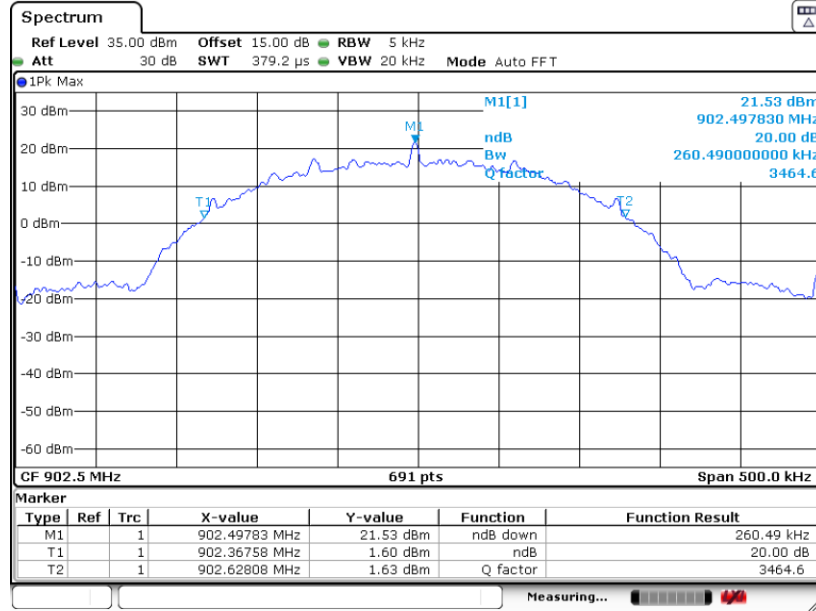

20 dB Bandwidth Plot on Mid Channel

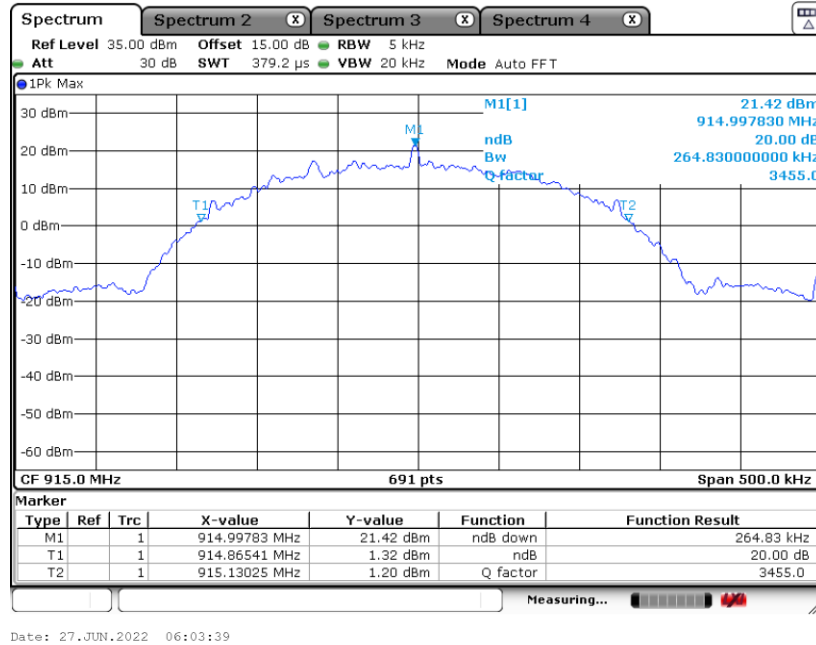



20 dB Bandwidth Plot on High Channel

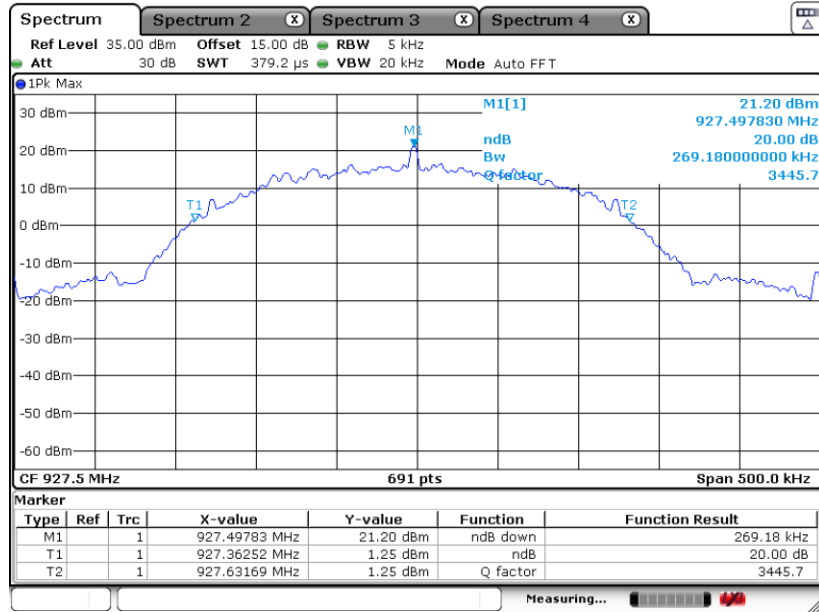

Date: 27.JUN.2022 06:19:43



3.4.6 Test Result of 99% Occupied Bandwidth

Please refer to Appendix A.

<Data Rate 50kbps>

99% Occupied Bandwidth Plot on Low Channel

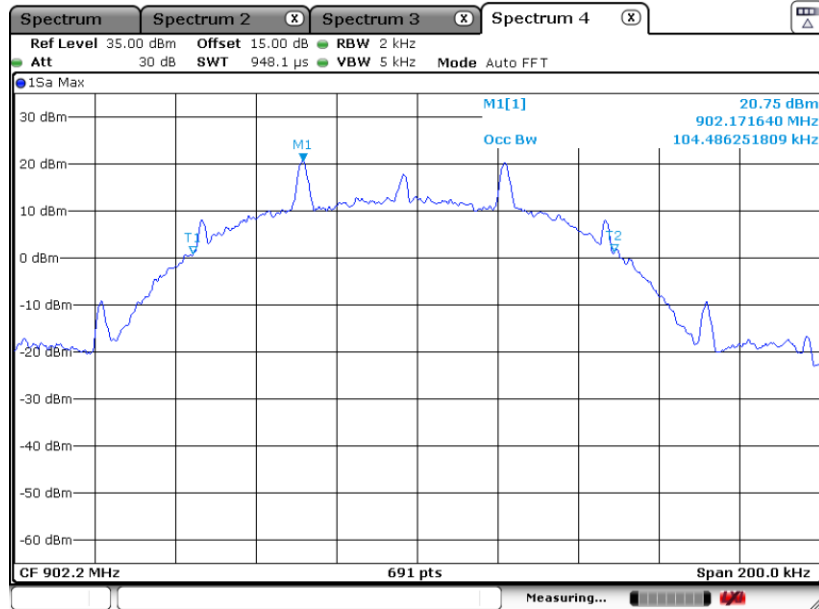

99% Occupied Bandwidth Plot on Mid Channel

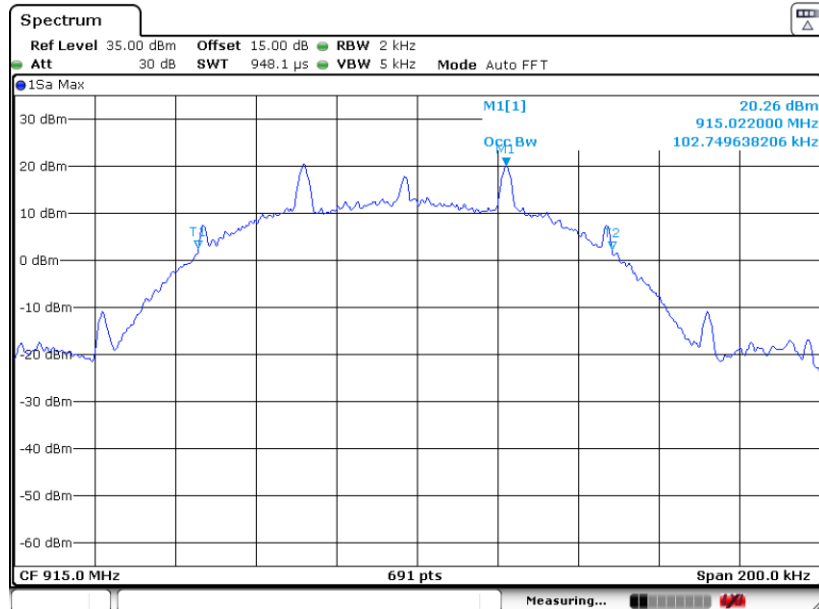



99% Occupied Bandwidth Plot on High Channel

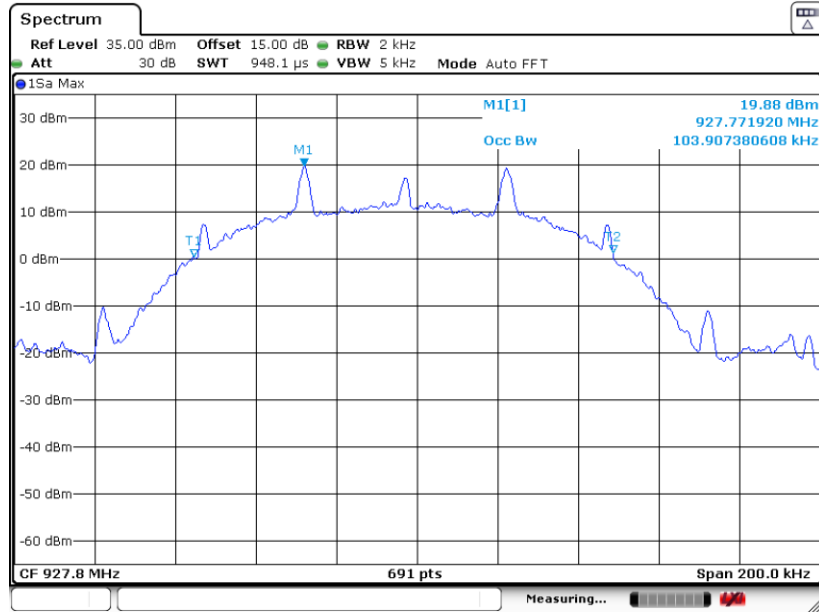

Date: 27.JUN.2022 03:58:52

<Data Rate 150kbps>

99% Occupied Bandwidth Plot on Low Channel

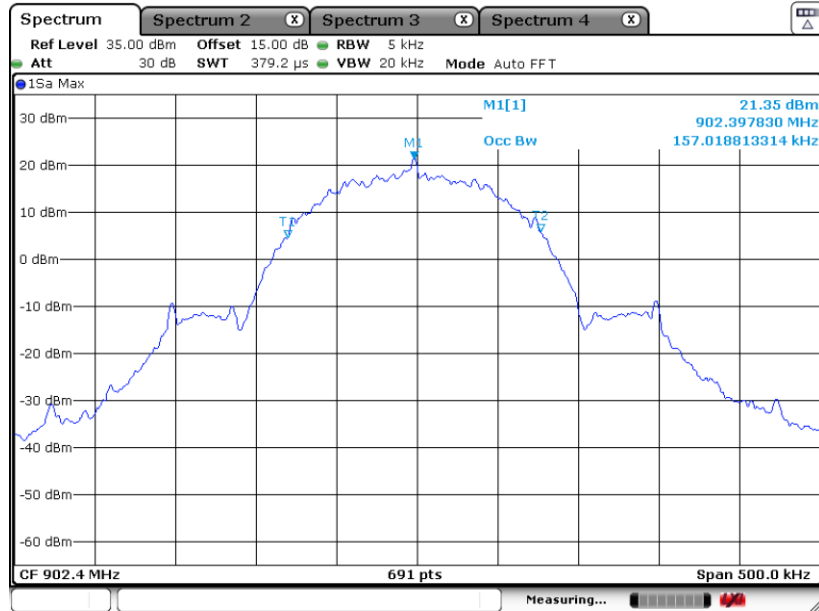

Date: 27.JUN.2022 04:46:07



99% Occupied Bandwidth Plot on Mid Channel

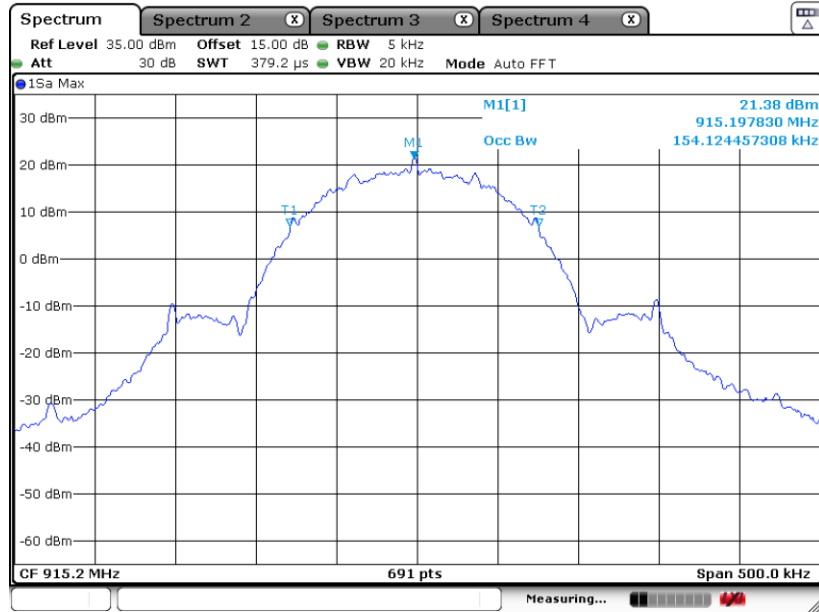

Date: 27.JUN.2022 05:08:51

99% Occupied Bandwidth Plot on High Channel

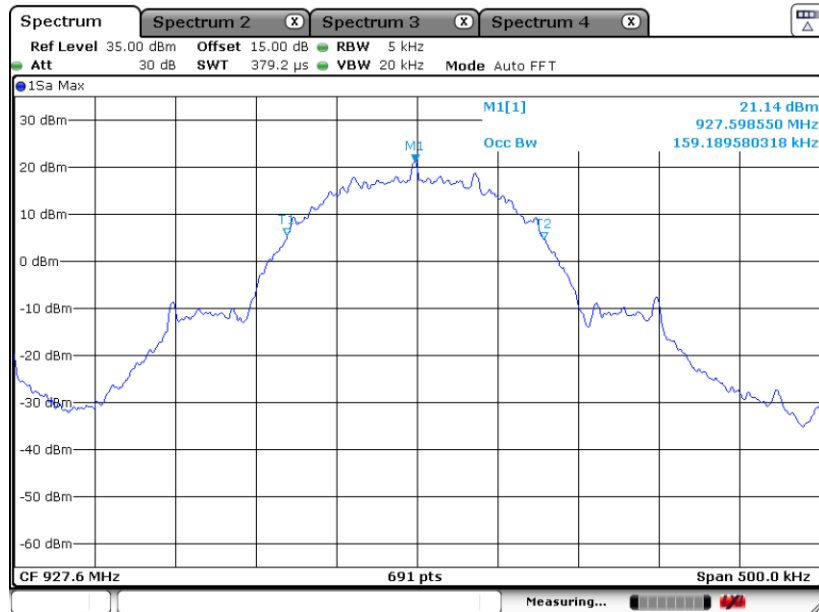

Date: 27.JUN.2022 05:16:35



<Data Rate 250kbps>

99% Occupied Bandwidth Plot on Low Channel

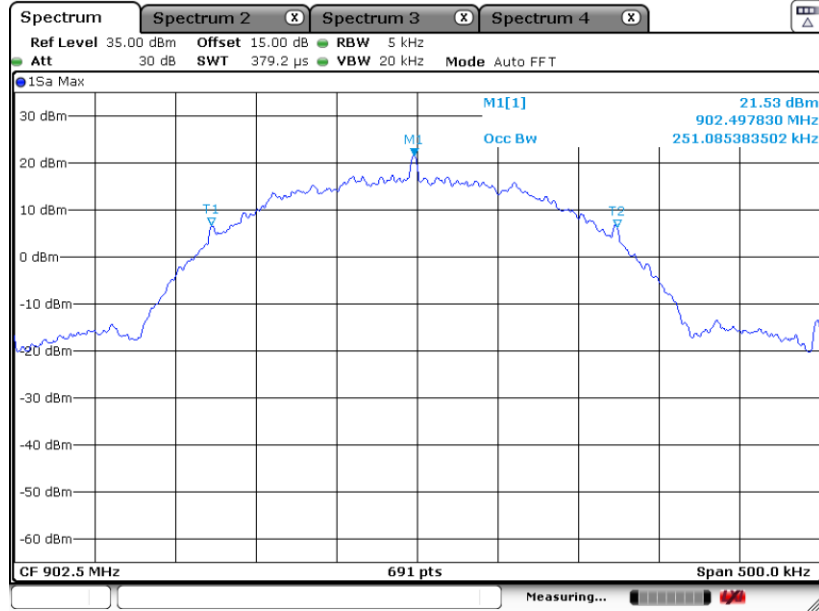

Date: 27.JUN.2022 06:01:03

99% Occupied Bandwidth Plot on Mid Channel

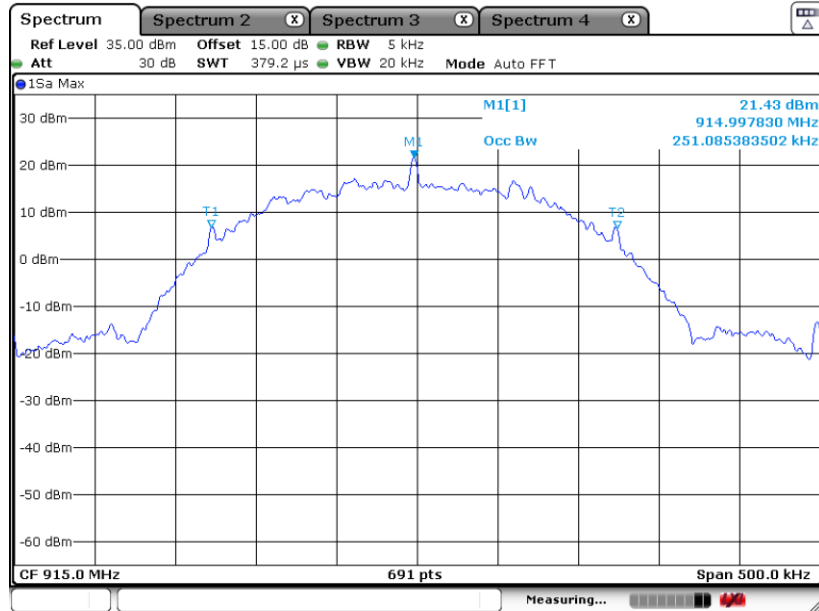

Date: 27.JUN.2022 06:02:53



99% Occupied Bandwidth Plot on High Channel

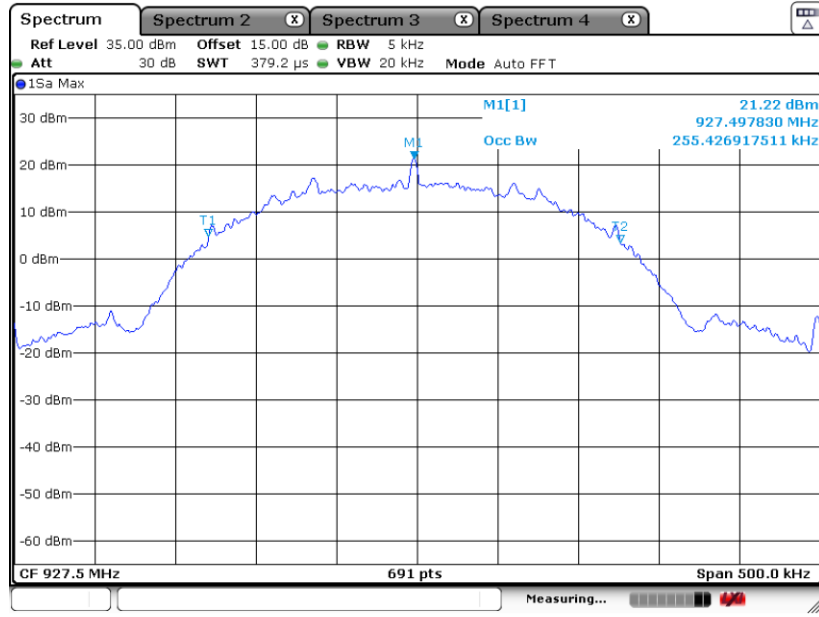

Date: 27.JUN.2022 06:16:38

Note : The occupied channel bandwidth is maintained within the band of operation for all of the modulations.

3.5 Output Power Measurement

3.5.1 Limit of Output Power

The maximum peak conducted output power of the intentional radiator shall not exceed the following:
For frequency hopping systems operating in the 902-928 MHz band: 1 watt for systems employing at least 50 hopping channels; and, 0.25 watts for systems employing less than 50 hopping channels, but at least 25 hopping channels, as permitted under paragraph (a)(1)(i) of this section.

3.5.2 Measuring Instruments

The measuring equipment is listed in the section 4 of this test report.

3.5.3 Test Procedures

1. The testing follows ANSI C63.10-2013 clause 7.8.5.
2. The RF output of EUT was connected to the power meter by RF cable and attenuator. The path loss was compensated to the results for each measurement.
3. Set to the maximum power setting and enable the EUT transmit continuously.
4. Measure the conducted output power with cable loss and record the results in the test report.
5. Measure and record the results in the test report.

3.5.4 Test Setup

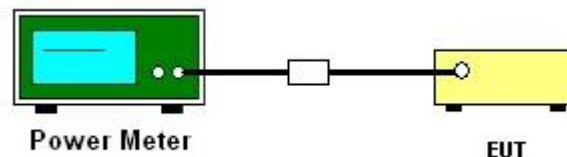

3.5.5 Test Result of Peak Output Power

Please refer to Appendix A.

3.6 Conducted Band Edges Measurement

3.6.1 Limit of Band Edges

In any 100 kHz bandwidth outside the intentional radiation frequency band, the radio frequency power shall be at least 20 dB below the highest level of the radiated power. In addition, radiated emissions which fall in the restricted bands must also comply with the radiated emission limits.

3.6.2 Measuring Instruments

The measuring equipment is listed in the section 4 of this test report.

3.6.3 Test Procedures

1. The testing follows ANSI C63.10-2013 clause 7.8.6.
2. Set to the maximum power setting and enable the EUT transmit continuously.
3. Set RBW = 100kHz, VBW = 300kHz. Band edge emissions must be at least 20 dB down from the highest emission level within the authorized band as measured with a 100kHz RBW. The attenuation shall be 30 dB instead of 20 dB when RMS conducted output power procedure is used.
4. Enable hopping function of the EUT and then repeat step 2. and 3.
5. Measure and record the results in the test report.

3.6.4 Test Setup





3.6.5 Test Result of Conducted Band Edges

<Data Rate 50kbps>

Low Band Edge Plot

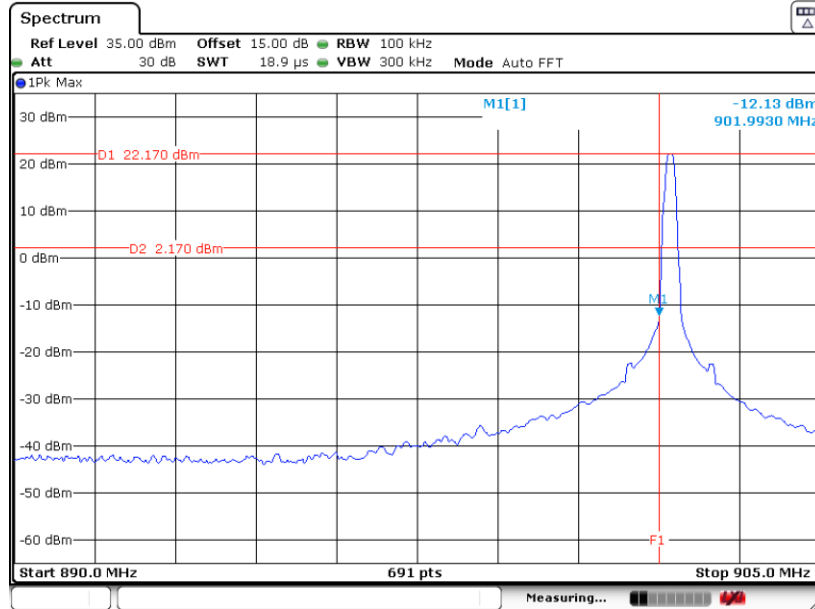

Date: 26 JUN 2022 14:18:14

High Band Edge Plot

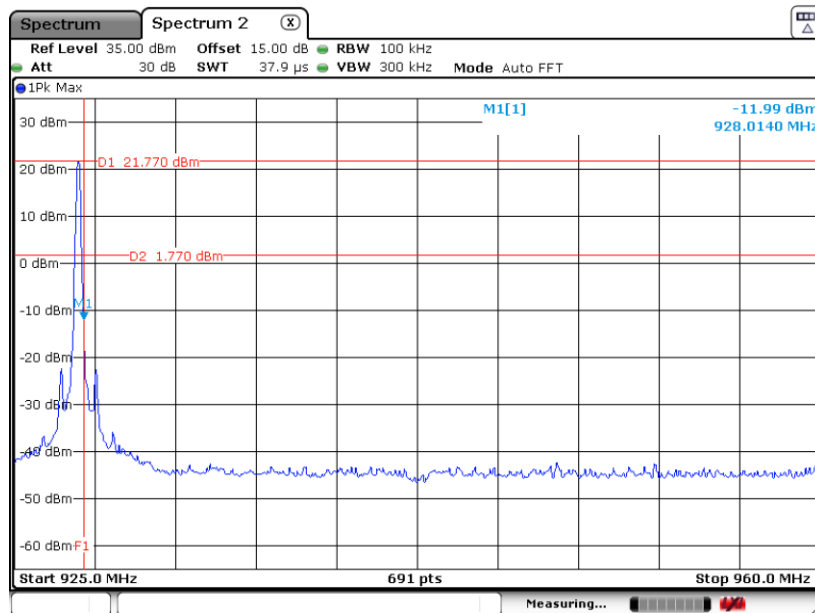

Date: 2 JUL 2022 21:53:36



<Data Rate 150kbps>

Low Band Edge Plot

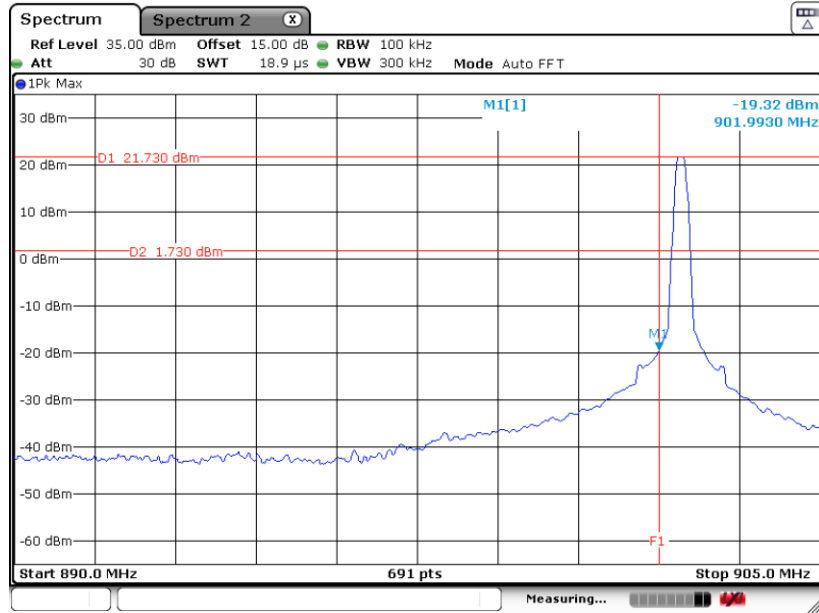

High Band Edge Plot

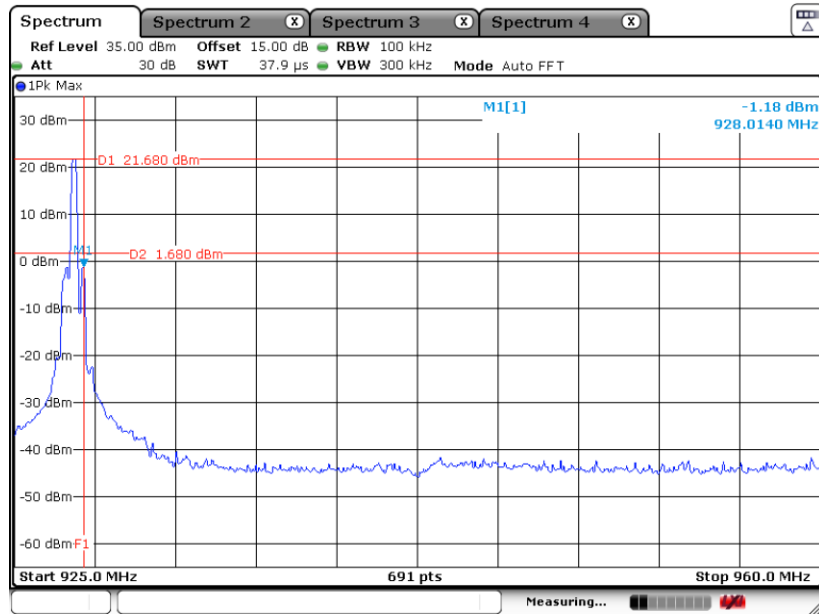



<Data Rate 250kbps>

Low Band Edge Plot

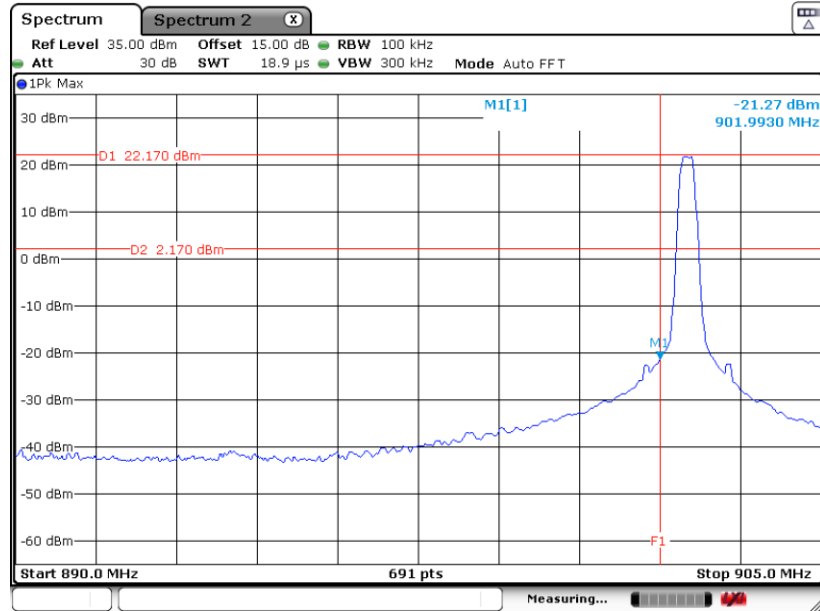

High Band Edge Plot

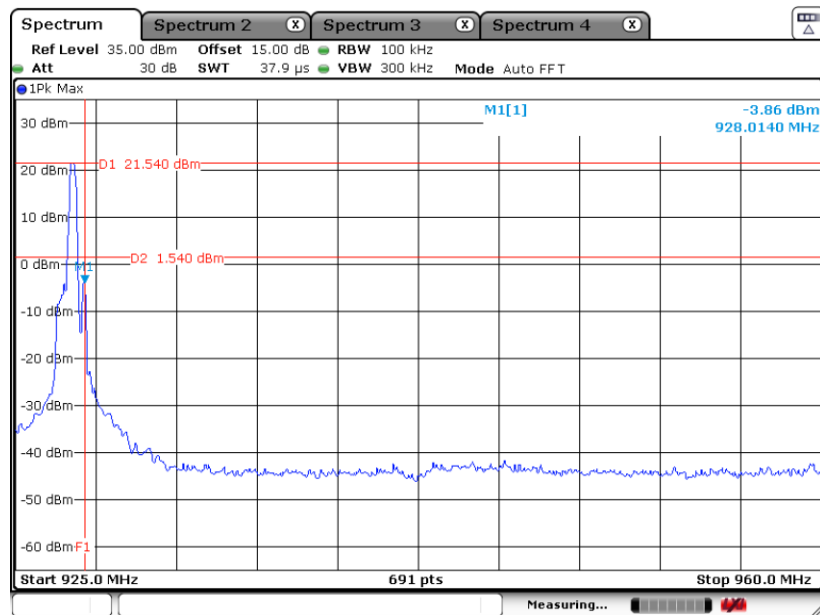



3.6.6 Test Result of Conducted Hopping Mode Band Edges

<Data Rate 50kbps>

Hopping Mode Low Band Edge Plot

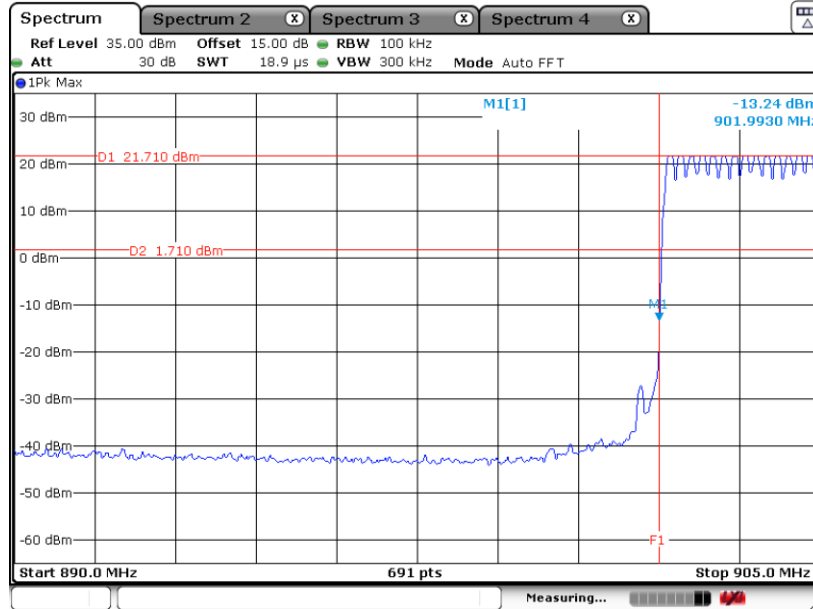

Hopping Mode High Band Edge Plot

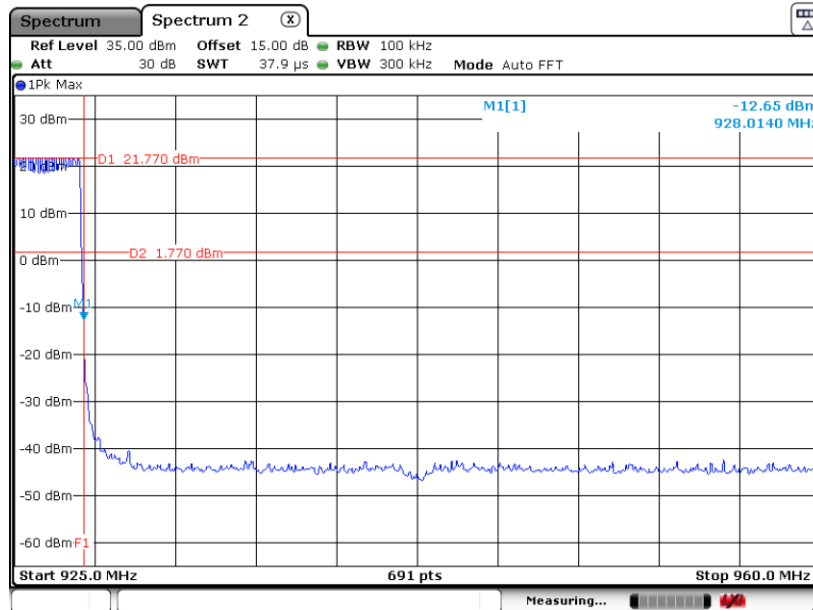



<Data Rate 150kbps>

Hopping Mode Low Band Edge Plot

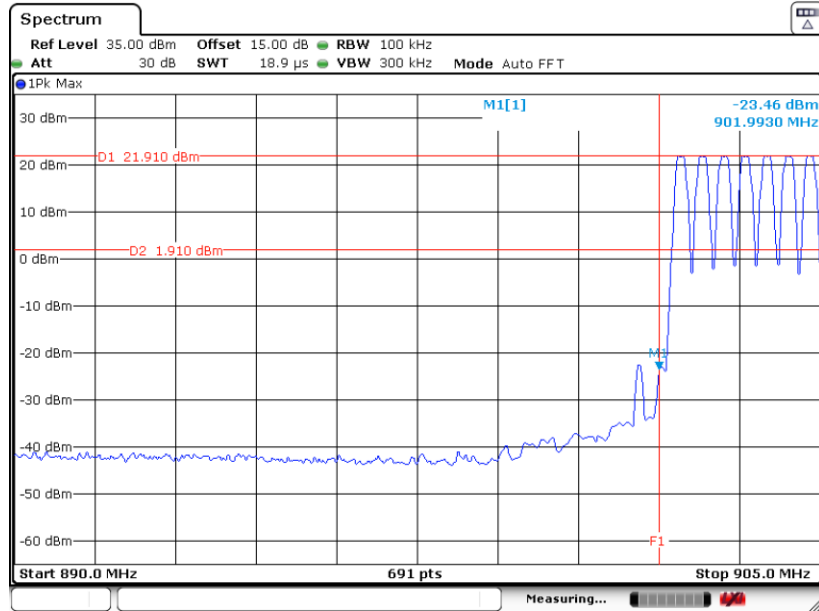

Date: 27.JUN.2022 05:34:00

Hopping Mode High Band Edge Plot

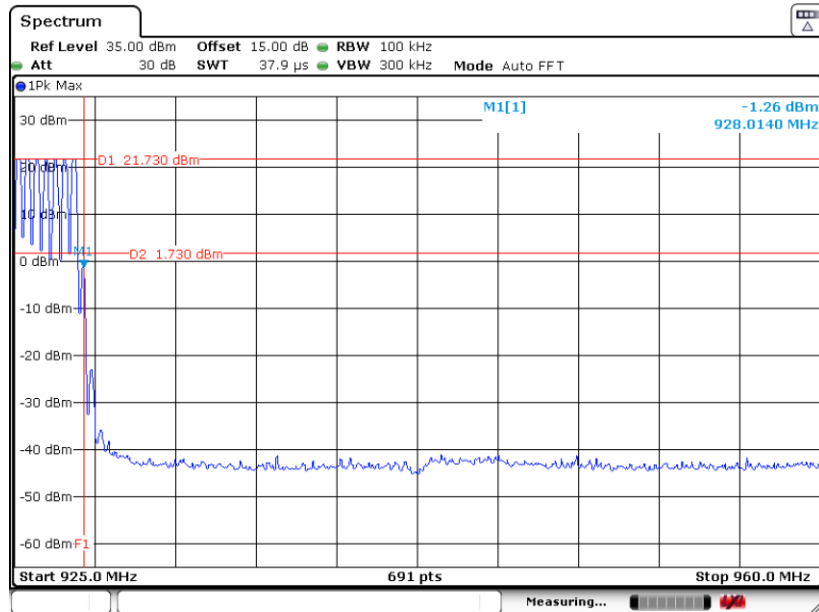

Date: 27.JUN.2022 05:32:21



<Data Rate 250kbps>

Hopping Mode Low Band Edge Plot

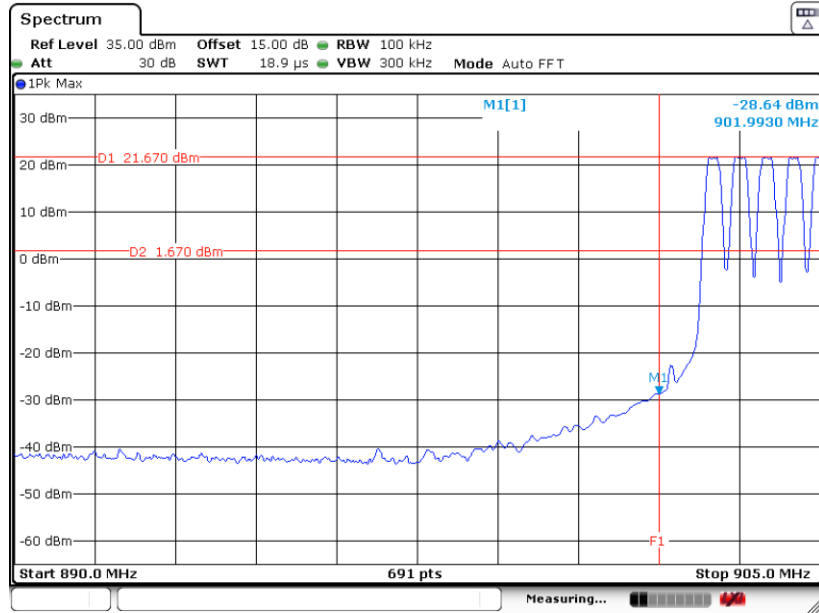

Hopping Mode High Band Edge Plot

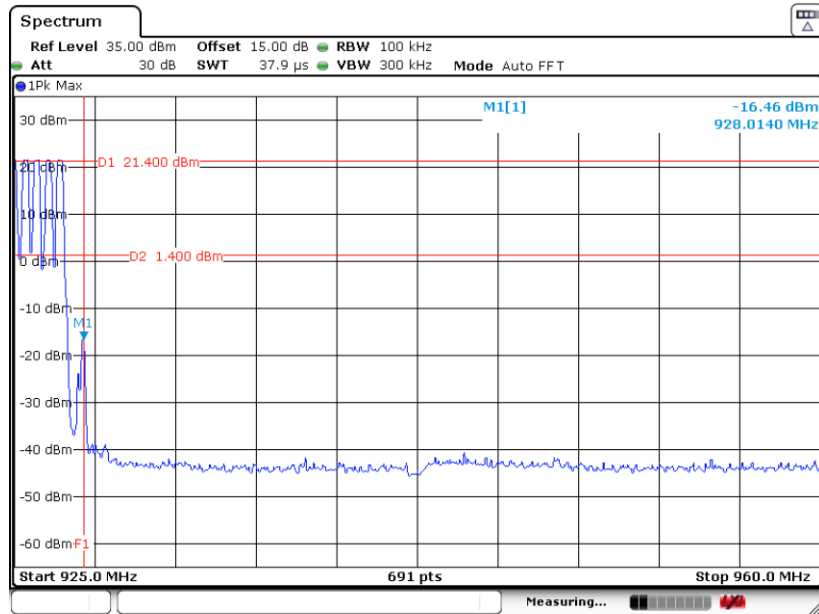

3.7 Conducted Spurious Emission Measurement

3.7.1 Limit of Spurious Emission Measurement

In any 100 kHz bandwidth outside the intentional radiation frequency band, the radio frequency power shall be at least 20 dB below the highest level of the radiated power. In addition, radiated emissions which fall in the restricted bands must also comply with the radiated emission limits.

3.7.2 Measuring Instruments

The measuring equipment is listed in the section 4 of this test report.

3.7.3 Test Procedure

1. The testing follows ANSI C63.10-2013 clause 7.8.8.
2. The RF output of EUT was connected to the spectrum analyzer by RF cable and attenuator. The path loss was compensated to the results for each measurement.
3. Set to the maximum power setting and enable the EUT transmit continuously.
4. Set RBW = 100 kHz, VBW = 300kHz, scan up through 10th harmonic. All harmonics / spurs must be at least 20 dB down from the highest emission level within the authorized band as measured with a 100 kHz RBW.
5. Measure and record the results in the test report.
6. The RF fundamental frequency should be excluded against the limit line in the operating frequency band.

3.7.4 Test Setup

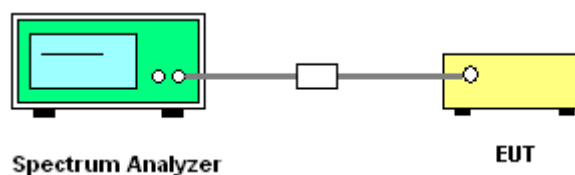



3.7.5 Test Result of Conducted Spurious Emission

<Data Rate 50kbps>

Low CH CSE Plot between 30MHz ~ 1 GHz

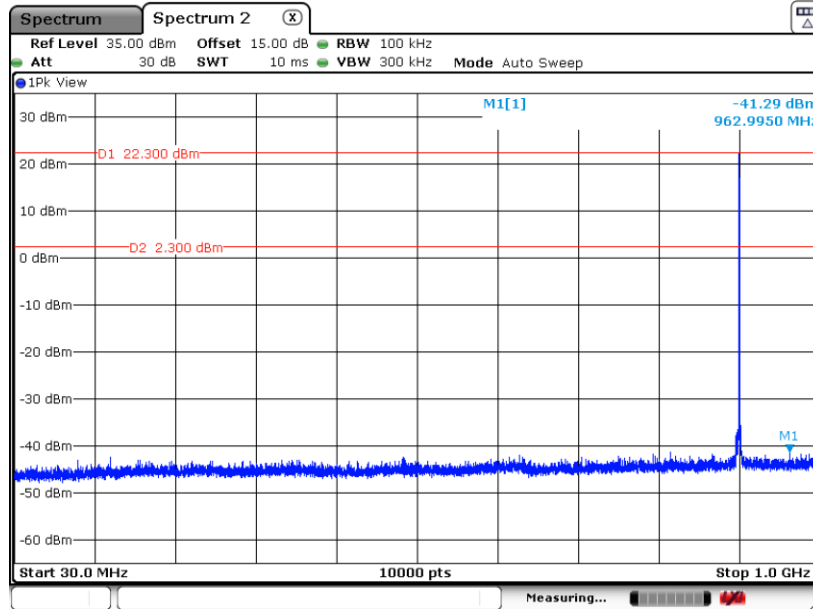

Low CH CSE Plot between 800 MHz ~ 10 GHz

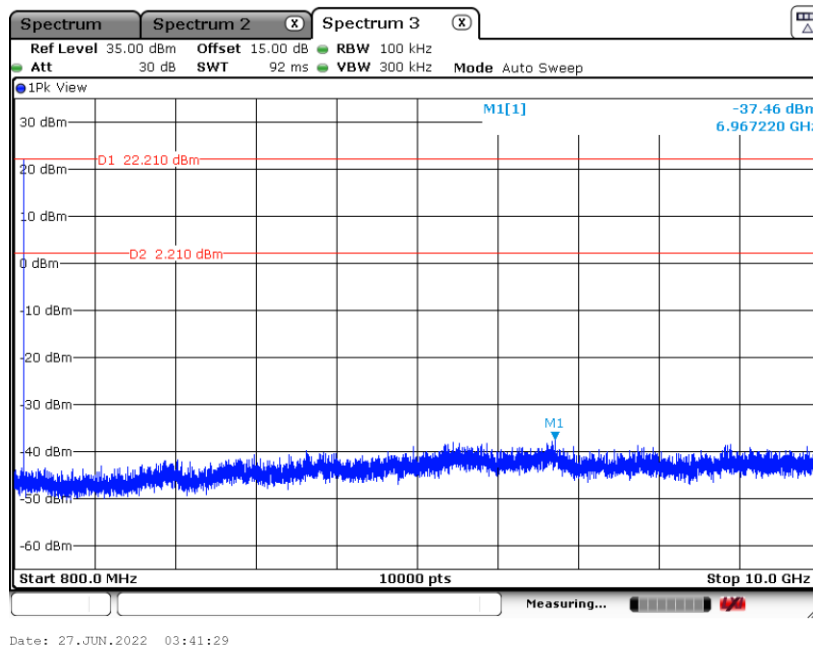



Mid CH CSE Plot between 30MHz ~ 1 GHz

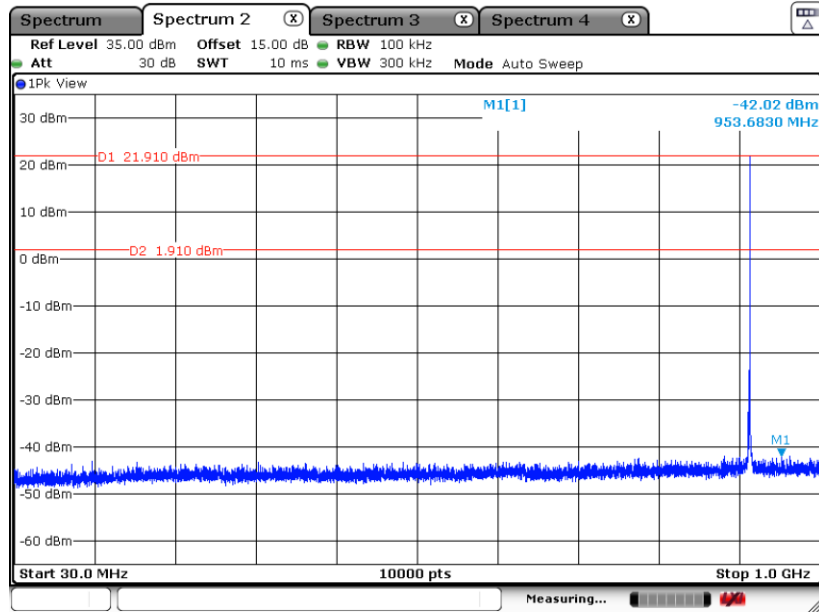

Mid CH CSE Plot between 800 MHz ~ 10 GHz

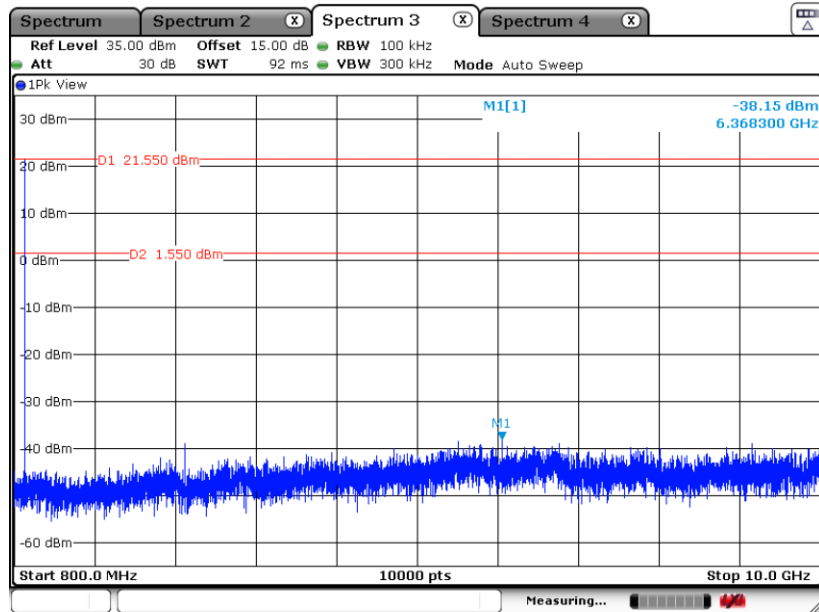



High CH CSE Plot between 30MHz ~ 1 GHz

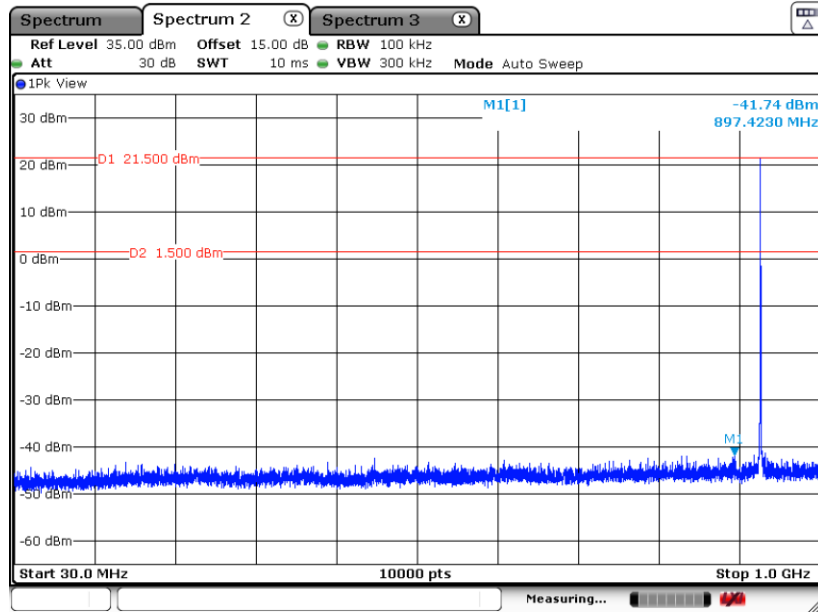

Date: 27.JUN.2022 04:01:43

High CH CSE Plot between 800 MHz ~ 10 GHz

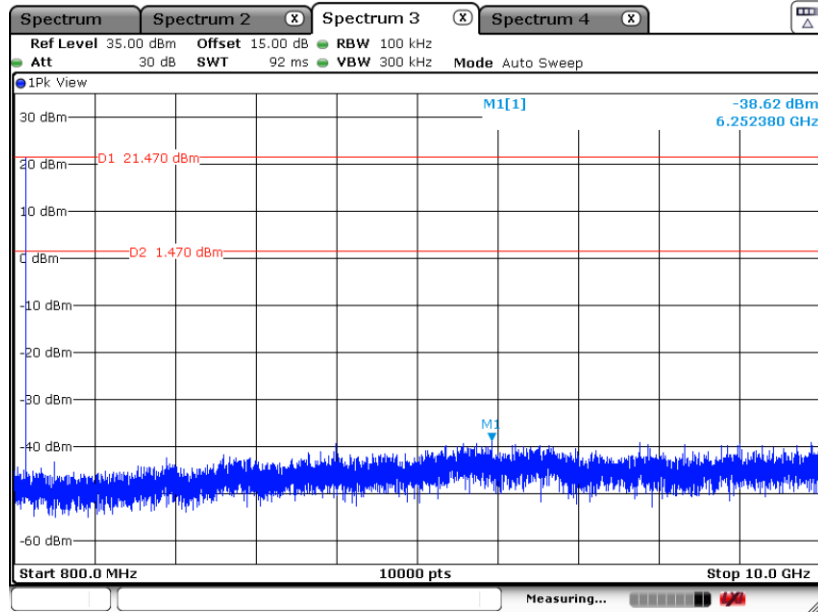

Date: 27.JUN.2022 04:02:32



<Data Rate 150kbps>

Low CH CSE Plot between 30MHz ~ 1 GHz

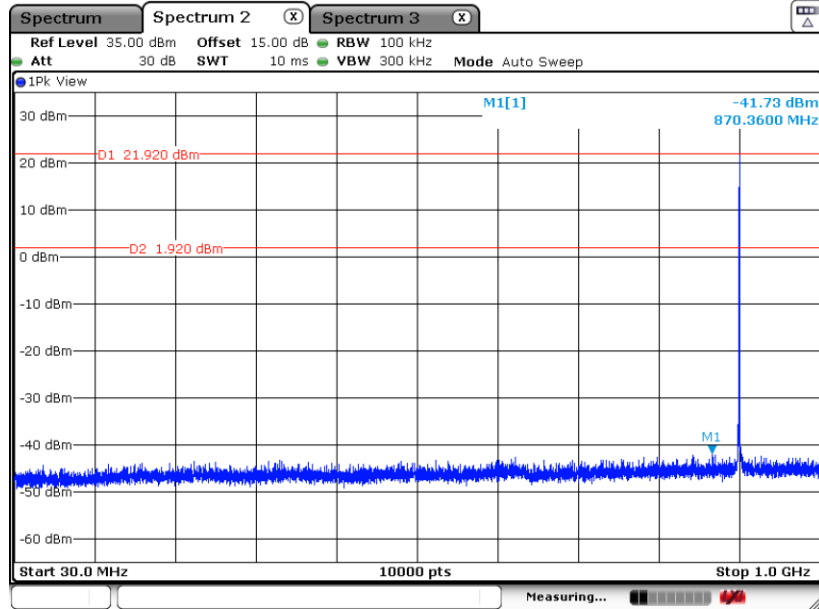

Low CH CSE Plot between 800 MHz ~ 10 GHz

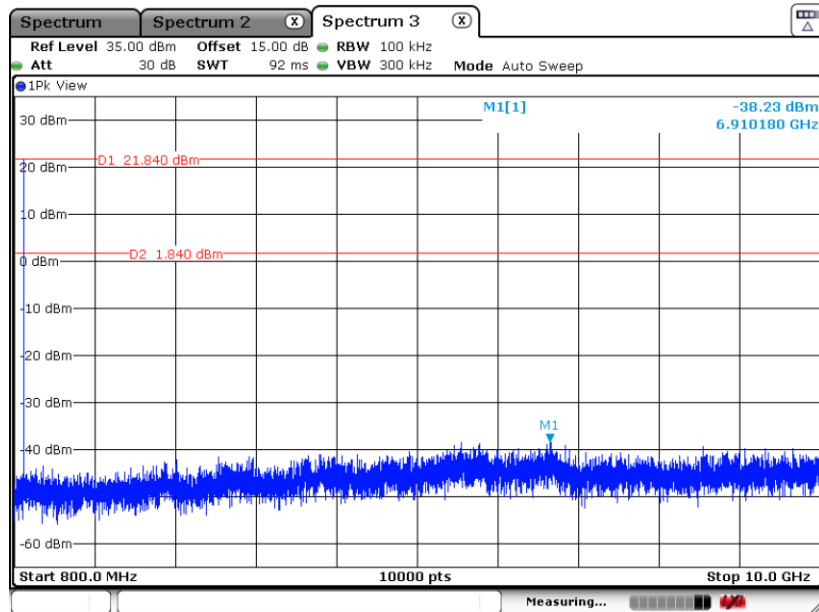



Mid CH CSE Plot between 30MHz ~ 1 GHz

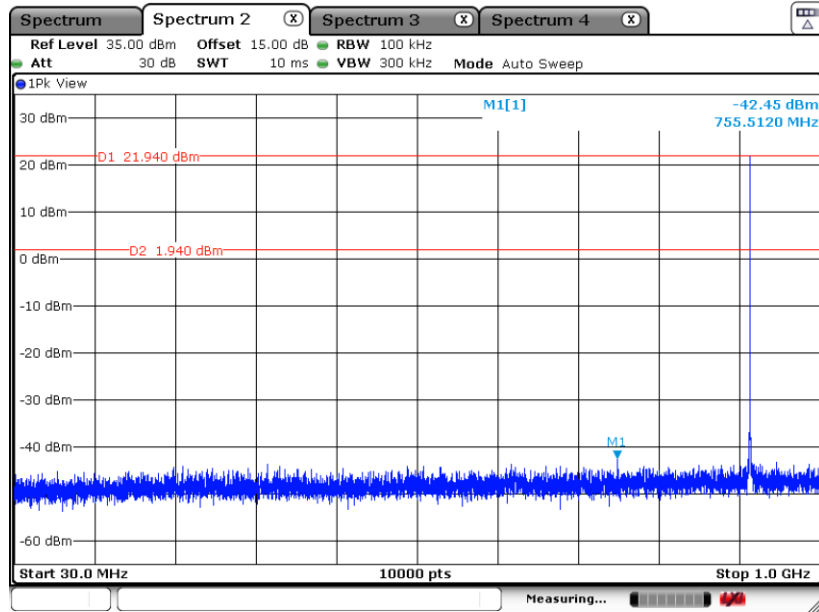

Date: 27.JUN.2022 05:10:23

Mid CH CSE Plot between 800 MHz ~ 10 GHz

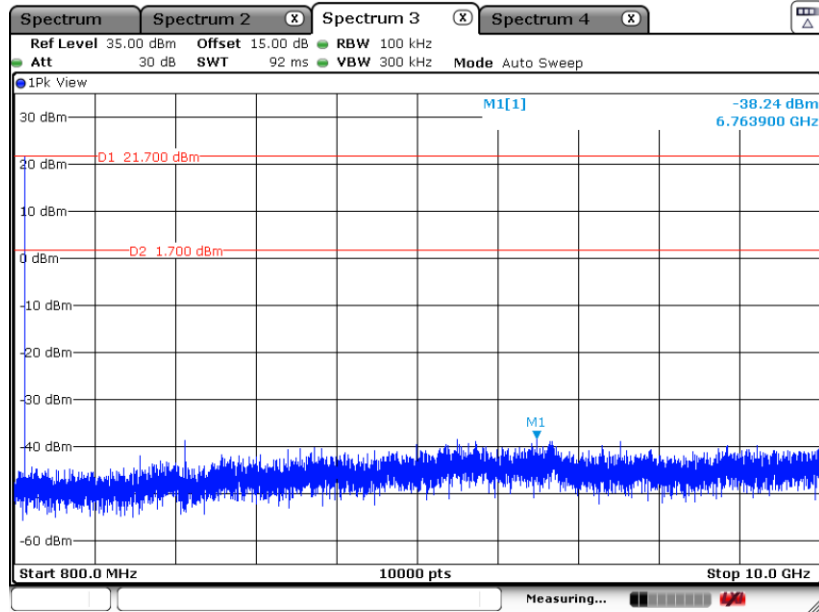

Date: 27.JUN.2022 05:10:57



High CH CSE Plot between 30MHz ~ 1 GHz

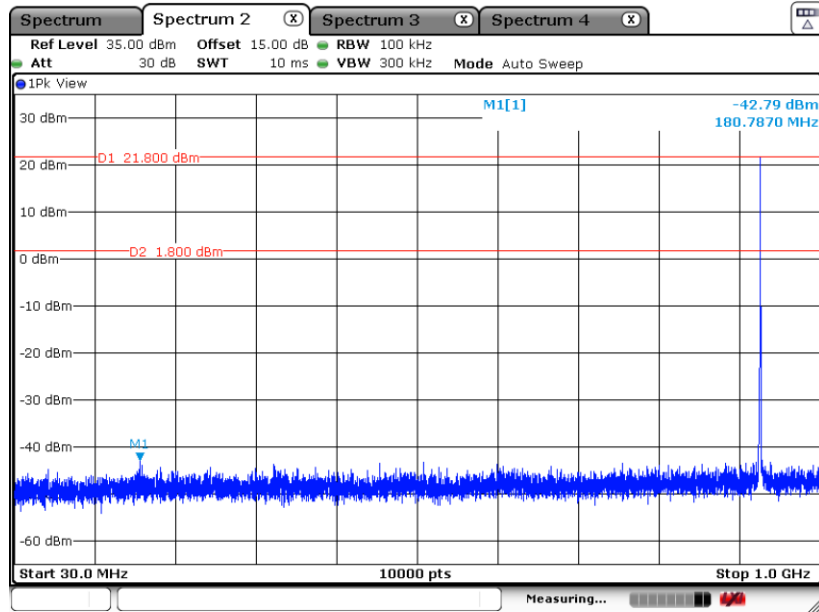

High CH CSE Plot between 800 MHz ~ 10 GHz

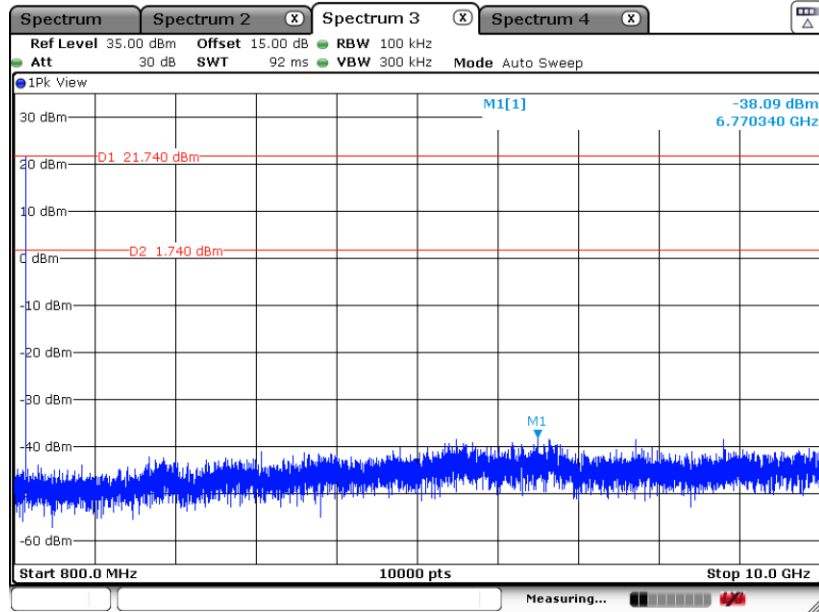



<Data Rate 250kbps>

Low CH CSE Plot between 30MHz ~ 1 GHz

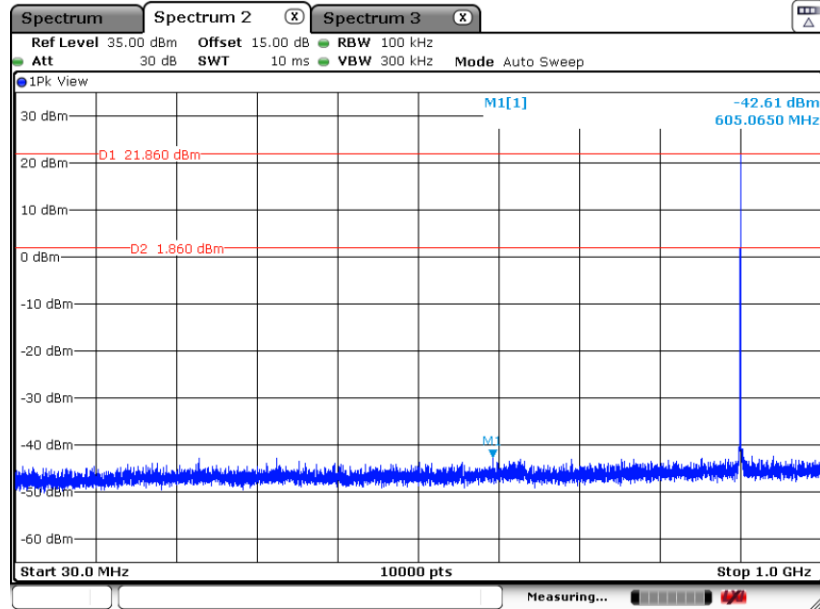

Low CH CSE Plot between 800 MHz ~ 10 GHz

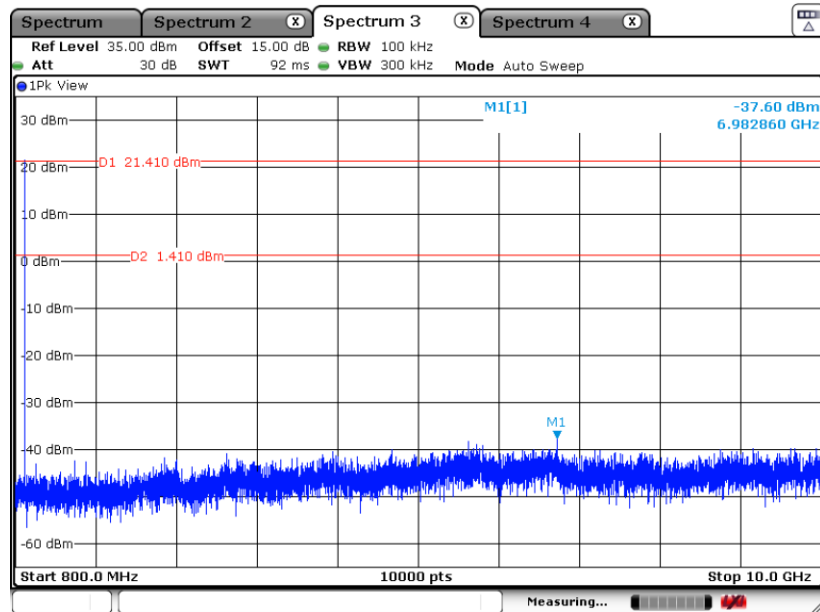



Mid CH CSE Plot between 30MHz ~ 1 GHz

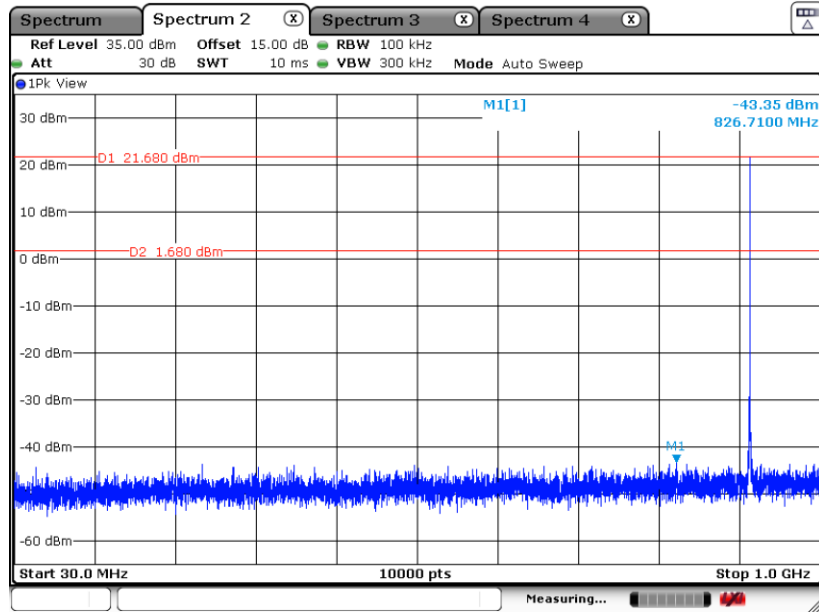

Mid CH CSE Plot between 800 MHz ~ 10 GHz

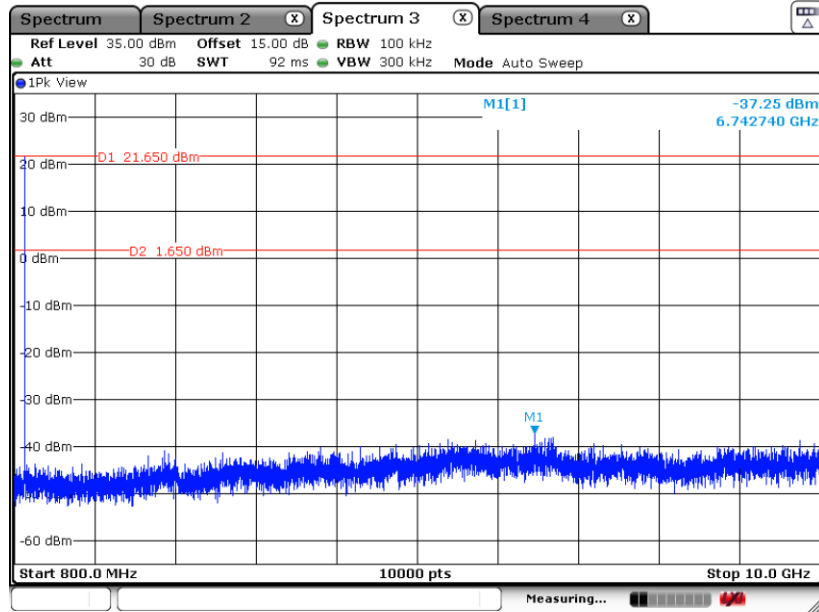



High CH CSE Plot between 30MHz ~ 1 GHz

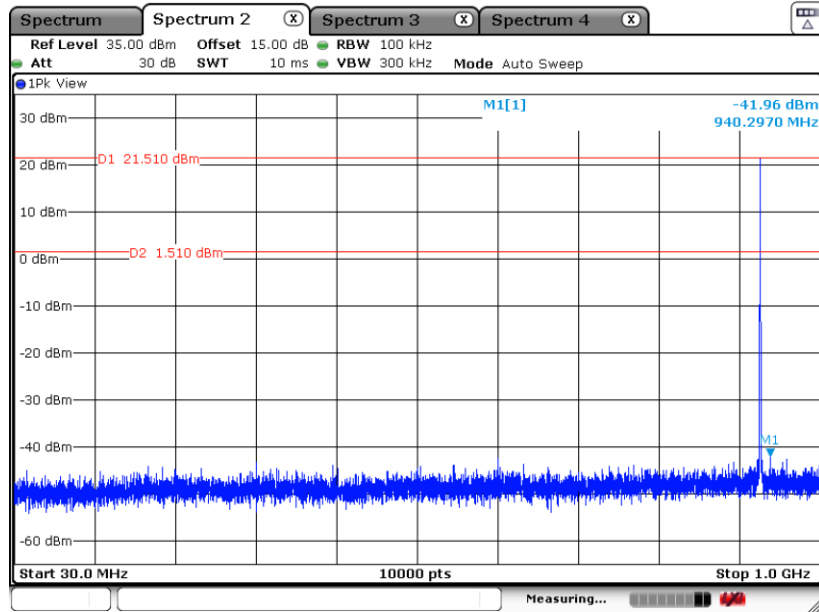

High CH CSE Plot between 800 MHz ~ 10 GHz

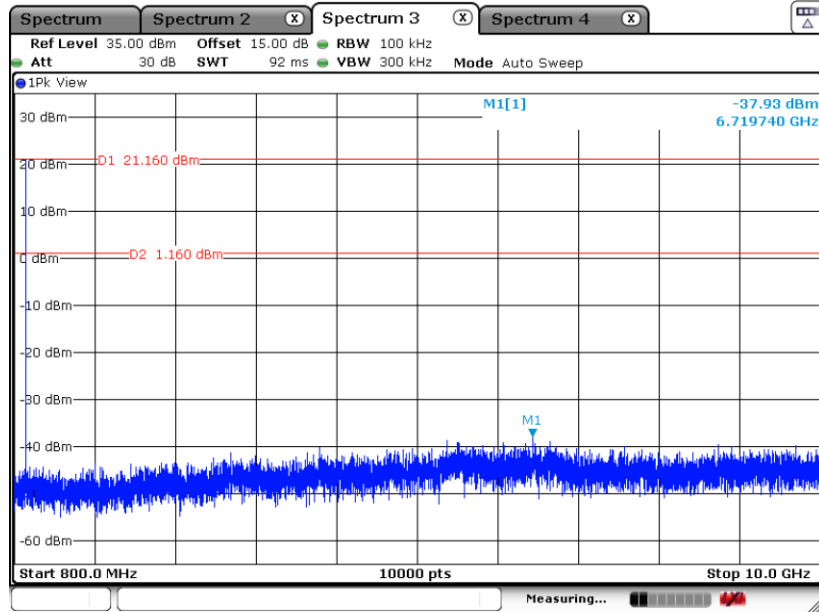



3.8 Radiated Band Edges and Spurious Emission Measurement

3.8.1 Limit of Radiated Band Edges and Spurious Emission

In any 100 kHz bandwidth outside the intentional radiator frequency band, all harmonics/spurious must be at least 20 dB below the highest emission level within the authorized band. In addition, radiated emissions which fall in the restricted bands must also comply with the limits as below.

Frequency (MHz)	Field Strength (microvolts/meter)	Measurement Distance (meters)
0.009 – 0.490	2400/F(kHz)	300
0.490 – 1.705	24000/F(kHz)	30
1.705 – 30.0	30	30
30 – 88	100	3
88 – 216	150	3
216 - 960	200	3
Above 960	500	3

3.8.2 Measuring Instruments

The measuring equipment is listed in the section 4 of this test report.



3.8.3 Test Procedures

1. The EUT was placed on a turntable with 0.8 meter for frequency below 1GHz and 1.5 meter for frequency above 1GHz respectively above ground.
2. The EUT was set 3 meters from the interference receiving antenna, which was mounted on the top of a variable height antenna tower.
3. For each suspected emission, the EUT was arranged to its worst case and then tune the Antenna tower (from 1 m to 4 m) and turntable (from 0 degree to 360 degrees) to find the maximum reading. A pre-amp and a high pass filter are used for the test in order to get better signal level to comply with the guidelines.
4. Set to the maximum power setting and enable the EUT transmit continuously.
5. Use the following spectrum analyzer settings:
 - (1) Span shall wide enough to fully capture the emission being measured;
 - (2) Set RBW=100 kHz for $f < 1$ GHz, RBW=1MHz for $f > 1$ GHz ; VBW \geq RBW; Sweep = auto; Detector function = peak; Trace = max hold for peak
6. Corrected Reading: Antenna Factor + Cable Loss + Read Level - Preamp Factor = Level
7. For testing below 1GHz, if the emission level of the EUT in peak mode was 3 dB lower than the limit specified, then peak values of EUT will be reported, otherwise, the emissions will be repeated one by one using the CISPR quasi-peak method and reported.
8. For testing above 1GHz, the emission level of the EUT in peak mode was 20dB lower than average limit (that means the emission level in average mode also complies with the limit in average mode), then peak values of EUT will be reported, otherwise, the emissions will be measured in average mode again and reported.

3.8.4 Test Setup

For radiated emissions below 30MHz

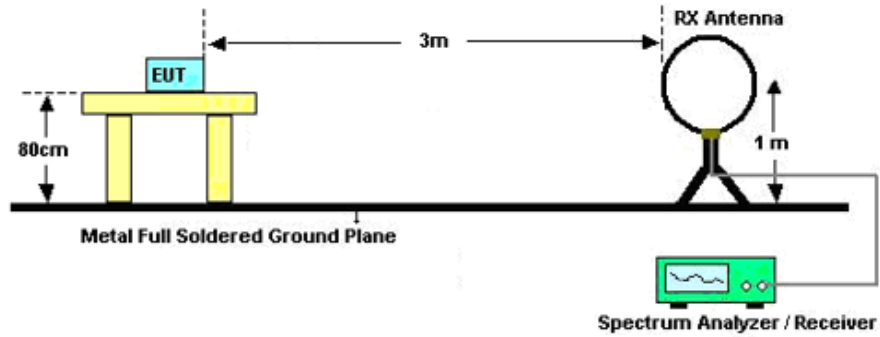

For radiated emissions from 30MHz to 1GHz

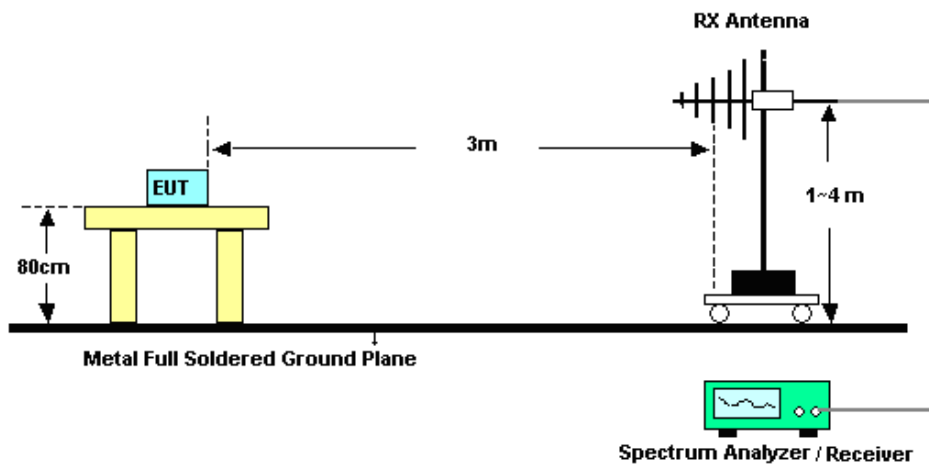

For radiated emissions above 1GHz

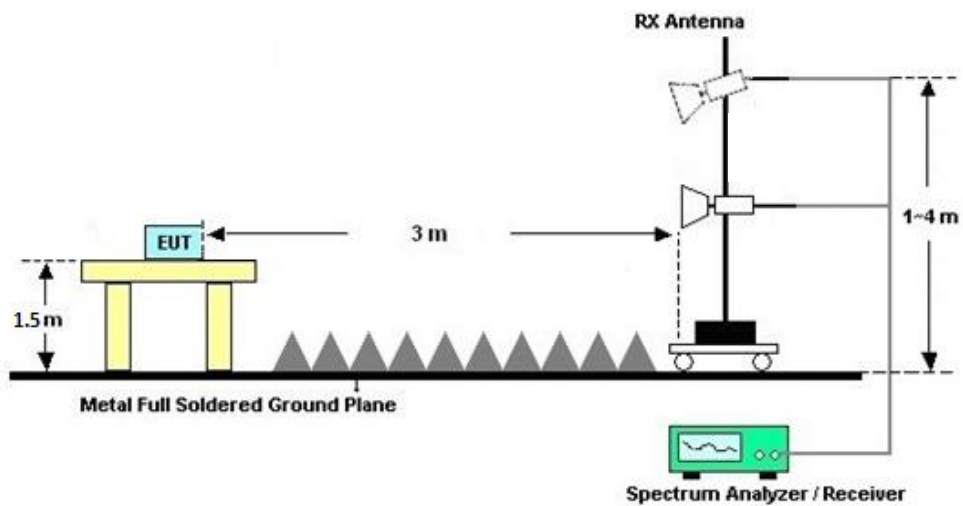



3.8.5 Test Results of Radiated Spurious Emissions (9 kHz ~ 30 MHz)

The low frequency, which started from 9 kHz to 30MHz, was pre-scanned and the result which was 20dB lower than the limit line was not reported.

There is a comparison data of both open-field test site and semi-Anechoic chamber, and the result came out very similar.

3.8.6 Test Result of Radiated Spurious at Band Edges

Please refer to Appendix C.

3.8.7 Test Result of Radiated Spurious Emission (30MHz ~ 10th Harmonic)

Please refer to Appendix C.



3.9 AC Conducted Emission Measurement

3.9.1 Limit of AC Conducted Emission

For equipment that is designed to be connected to the public utility (AC) power line, the radio frequency voltage that is conducted back onto the AC power line on any frequency or frequencies within the band 150 kHz to 30 MHz shall not exceed the limits in the following table.

Frequency of emission (MHz)	Conducted limit (dBµV)	
	Quasi-peak	Average
0.15-0.5	66 to 56*	56 to 46*
0.5-5	56	46
5-30	60	50

*Decreases with the logarithm of the frequency.

3.9.2 Measuring Instruments

The measuring equipment is listed in the section 4 of this test report.

3.9.3 Test Procedures

1. The EUT was placed 0.4 meter from the conducting wall of the shielding room was kept at least 80 centimeters from any other grounded conducting surface.
2. Connect EUT to the power mains through a line impedance stabilization network (LISN).
3. All the support units are connecting to the other LISN.
4. The LISN provides 50 ohm coupling impedance for the measuring instrument.
5. The FCC states that a 50 ohm, 50 microhenry LISN should be used.
6. Both sides of AC line were checked for maximum conducted interference.
7. The frequency range from 150 kHz to 30 MHz was searched.
8. Set the test-receiver system to Peak Detect Function and specified bandwidth (IF Bandwidth = 9kHz) with Maximum Hold Mode. Then measurement is also conducted by Average Detector and Quasi-Peak Detector Function respectively.

3.9.4 Test Setup

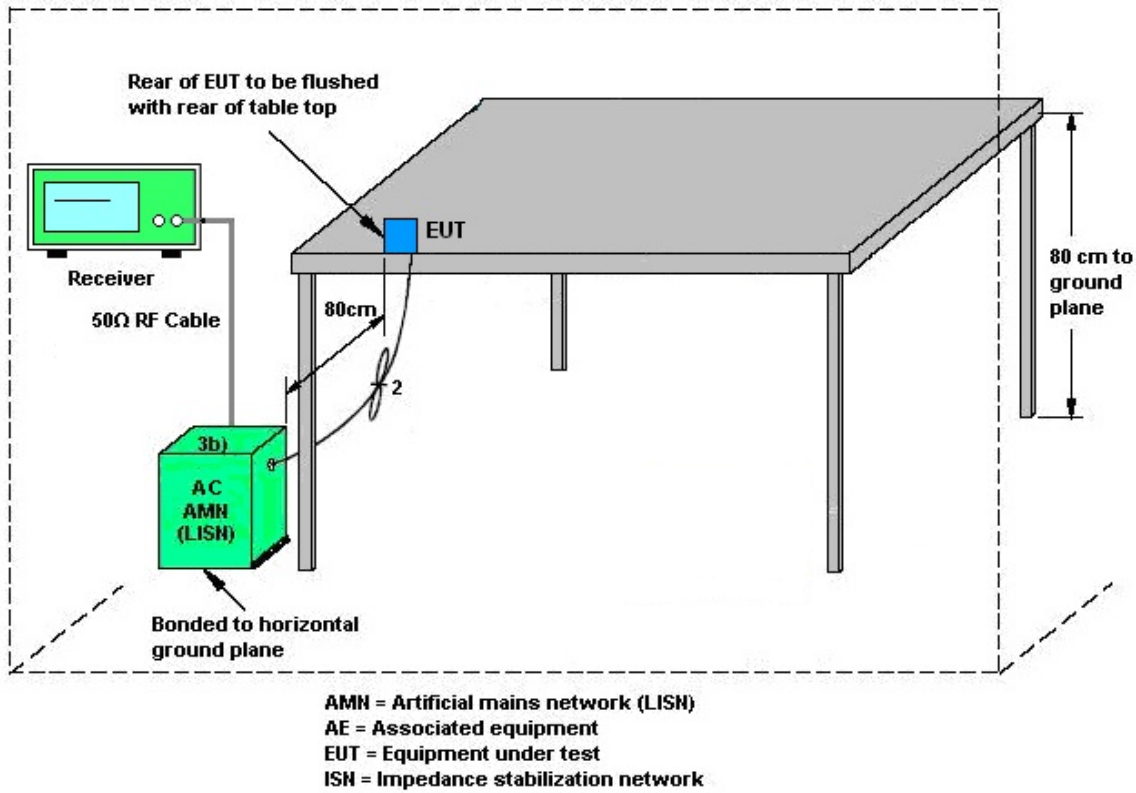

3.9.5 Test Result of AC Conducted Emission

Please refer to Appendix B.



3.10 Antenna Requirements

3.10.1 Standard Applicable

If directional gain of transmitting antennas is greater than 6dBi, the power shall be reduced by the same level in dB comparing to gain minus 6dBi. The use of a permanently attached antenna or of an antenna that uses a unique coupling to the intentional radiator shall be considered sufficient to comply with the rule.

3.10.2 Antenna Anti-Replacement Construction

An embedded-in antenna design is used.

3.10.3 Antenna Gain

The antenna peak gain of EUT is less than 6 dBi. Therefore, it is not necessary to reduce maximum peak output power limit.



4 List of Measuring Equipment

Instrument	Manufacturer	Model No.	Serial No.	Characteristics	Calibration Date	Test Date	Due Date	Remark
Spectrum Analyzer	R&S	FSV40	101040	10Hz~40GHz	Oct. 14, 2021	Jun. 26, 2022~ Jul. 18, 2022	Oct. 13, 2022	Conducted (TH01-KS)
Pulse Power Sensor	Anritsu	MA2411B	0917070	300MHz~40GHz	Jan. 05, 2022	Jun. 26, 2022~ Jul. 18, 2022	Jan. 04, 2023	Conducted (TH01-KS)
Power Meter	Anritsu	ML2495A	1005002	50MHz Bandwidth	Jan. 05, 2022	Jun. 26, 2022~ Jul. 18, 2022	Jan. 04, 2023	Conducted (TH01-KS)
EMI Test Receiver	R&S	ESR7	101403	9kHz~7GHz;Max x 30dBm	Oct. 16, 2021	Jul. 23, 2022	Oct. 15, 2022	Radiation (03CH08-KS)
EXA Spectrum Analyzer	Keysight	N9010B	MY574710 84	10Hz-44G,MAX 30dB	Jul. 11, 2022	Jul. 23, 2022	Jul. 10, 2023	Radiation (03CH08-KS)
Loop Antenna	R&S	HFH2-Z2	100321	9kHz~30MHz	Oct. 30, 2021	Jul. 23, 2022	Oct. 29, 2022	Radiation (03CH08-KS)
Bilog Antenna	TESEQ& VGT	CBL 61110	59915	30MHz-1GHz	Sep. 02, 2021	Jul. 23, 2022	Sep. 01, 2022	Radiation (03CH08-KS)
Double Ridge Horn Antenna	ETS-Lindgren	3117	00240138	1GHz~18GHz	Jul. 18, 2022	Jul. 23, 2022	Jul. 17, 2023	Radiation (03CH08-KS)
high gain Amplifier	MITEQ	AMF-7D-0010 1800-30-10P	2025788	1Ghz-18Ghz	Jul. 30, 2021	Jul. 23, 2022	Jul. 29, 2022	Radiation (03CH08-KS)
SHF-EHF Horn	Com-power	AH-840	101070	18GHz~40GHz	Jan. 05, 2022	Jul. 23, 2022	Jan. 04, 2023	Radiation (03CH08-KS)
Amplifier	SONOMA	310N	413741	9KHz-1GHz	Jan. 05, 2022	Jul. 23, 2022	Jan. 04, 2023	Radiation (03CH08-KS)
Amplifier	Keysight	83017A	MY532703 89	500MHz~26.5GHz	Jan. 05, 2022	Jul. 23, 2022	Jan. 04, 2023	Radiation (03CH08-KS)
Amplifier	MITEQ	EM18G40GG A	060728	18~40GHz	Jan. 05, 2022	Jul. 23, 2022	Jan. 04, 2023	Radiation (03CH08-KS)
AC Power Source	Chroma	61601	616010002 473	N/A	NCR	Jul. 23, 2022	NCR	Radiation (03CH08-KS)
Turn Table	MF	MF7802	N/A	0~360 degree	NCR	Jul. 23, 2022	NCR	Radiation (03CH08-KS)
Antenna Mast	MF	MF7802	N/A	1 m~4 m	NCR	Jul. 23, 2022	NCR	Radiation (03CH08-KS)
EMI Receiver	R&S	ESCI7	100768	9kHz~7GHz;	May 24, 2022	Jul. 21, 2022	May 23, 2023	Conduction (CO01-KS)
AC LISN (for auxiliary equipment)	MessTec	AN3016	060103	9kHz~30MHz	Oct. 14, 2021	Jul. 21, 2022	Oct. 13, 2022	Conduction (CO01-KS)
AC LISN	MessTec	AN3016	060105	9kHz~30MHz	May 24, 2022	Jul. 21, 2022	May 23, 2023	Conduction (CO01-KS)
AC Power Source	Chroma	61602	ABP00000 0811	AC 0V~300V, 45Hz~1000Hz	Oct. 14, 2021	Jul. 21, 2022	Oct. 13, 2022	Conduction (CO01-KS)

NCR: No Calibration Required.



5 Uncertainty of Evaluation

The measurement uncertainties shown below were calculated in accordance with the requirements of ANSI 63.10-2013. All the measurement uncertainty value were shown with a coverage K=2 to indicate 95% level of confidence. The measurement data show herein meets or exceeds the CISPR measurement uncertainty values specified in CISPR 16-4-2 and can be compared directly to specified limit to determine compliance.

Uncertainty of Conducted Measurement

Test Item	Uncertainty
Conducted Power	±0.56 dB
Conducted Emissions	±0.92 dB
Occupied Channel Bandwidth	±0.03 %
Conducted Power Spectral Density	±0.54 dB

Uncertainty of Conducted Emission Measurement (150kHz ~ 30MHz)

Measuring Uncertainty for a Level of Confidence of 95% (U = 2Uc(y))	2.94dB
---	--------

Uncertainty of Radiated Emission Measurement (30 MHz ~ 1000 MHz)

Measuring Uncertainty for a Level of Confidence of 95% (U = 2Uc(y))	4.9dB
---	-------

Uncertainty of Radiated Emission Measurement (1000 MHz ~ 18000 MHz)

Measuring Uncertainty for a Level of Confidence of 95% (U = 2Uc(y))	5.0dB
---	-------



Appendix A. Conducted Test Results

Test Engineer:	Albert shi	Temperature:	20~26	°C
Test Date:	2022/6/26~2022/7/18	Relative Humidity:	40~51	%

FSK-FHSS-50Kbps**TEST RESULTS DATA****20dB and 99% Occupied Bandwidth and Hopping Channel Separation**

Mod.	Data Rate	NTX	CH.	Freq. (MHz)	20db BW (MHz)	99% Bandwidth (MHz)	Hopping Channel Separation Measurement (KHz)	Hopping Channel Separation Measurement Limit (KHz)	Pass/Fail
FSK	50Kbps	1	1	902.2	0.108	0.104	175.400	107.960	Pass
FSK	50Kbps	1	65	915	0.105	0.103	147.600	105.350	Pass
FSK	50Kbps	1	129	927.8	0.108	0.104	199.700	107.960	Pass

TEST RESULTS DATA**Dwell Time**

Mod.	CH.	DT On-time per hop (ms)	Total hops over 20sec	Dwell Time (sec)	Limits (sec)	Pass/Fail
FSK50	hopping	298.01	1.00	0.30	0.4	Pass

TEST RESULTS DATA**Peak Power Table**

mode	Freq. (MHz)	NTX	Peak Power (dBm)	Power Limit (dBm)	Test Result
FSK50	902.2	1	21.97	30.00	Pass
	915	1	21.95	30.00	Pass
	927.8	1	21.99	30.00	Pass

TEST RESULTS DATA**Number of Hopping Frequency**

Number of Hopping (Channel)	Limits (Channel)	Pass/Fail
129	> 50	Pass

FSK-FHSS-150Kbps**TEST RESULTS DATA****20dB and 99% Occupied Bandwidth and Hopping Channel Separation**

Mod.	Data Rate	NTX	Freq. (MHz)	20db BW (MHz)	99% Bandwidth (MHz)	Hopping Channel Separation Measurement (MHz)	Hopping Channel Separation Measurement Limit (MHz)	Pass/Fail
FSK	150Kbps	1	902.4	0.172	0.157	0.323	0.172	Pass
FSK	150Kbps	1	915.2	0.169	0.154	0.361	0.169	Pass
FSK	150Kbps	1	927.6	0.173	0.159	0.393	0.173	Pass

TEST RESULTS DATA**Dwell Time**

Mod.	CH.	DT On-time per hop (ms)	Total hops over 20sec	Dwell Time (sec)	Limits (sec)	Pass/Fail
FSK 150K	hopping	312.151	1.00	0.31	0.4	Pass

TEST RESULTS DATA**Peak Power Table**

mode	Freq. (MHz)	NTX	Peak Power (dBm)	Power Limit (dBm)	Test Result
FSK 150K	902.4	1	21.91	30.00	Pass
	915.2	1	21.89	30.00	Pass
	927.6	1	21.89	30.00	Pass

TEST RESULTS DATA**Number of Hopping Frequency**

Number of Hopping (Channel)	Limits (Channel)	Pass/Fail
64	> 50	Pass

FSK-FHSS-250Kbps**TEST RESULTS DATA****20dB and 99% Occupied Bandwidth and Hopping Channel Separation**

Mod.	Data Rate	NTX	Freq. (MHz)	20db BW (MHz)	99% Bandwidth (MHz)	Hopping Channel Separation Measurement (MHz)	Hopping Channel Separation Measurement Limit (MHz)	Pass/Fail
FSK	250Kbps	1	902.5	0.260	0.251	0.288	0.260	Pass
FSK	250Kbps	1	915	0.265	0.251	0.385	0.265	Pass
FSK	250Kbps	1	927.5	0.269	0.255	0.376	0.269	Pass

TEST RESULTS DATA**Dwell Time**

Mod.	CH.	DT On-time per hop (ms)	Total hops over 20sec	Dwell Time (sec)	Limits (sec)	Pass/Fail
FSK250	hopping	240.008	1.00	0.24	0.4	Pass

TEST RESULTS DATA**Peak Power Table**

mode	Freq. (MHz)	NTX	Peak Power (dBm)	Power Limit (dBm)	Test Result
FSK250	902.5	1	21.95	30.00	Pass
	915	1	21.91	30.00	Pass
	927.5	1	21.99	30.00	Pass

TEST RESULTS DATA**Number of Hopping Frequency**

Number of Hopping (Channel)	Limits (Channel)	Pass/Fail
51	> 25	Pass



Appendix B. AC Conducted Emission Test Results

Test Engineer :	Amos Zhang	Temperature :	24.2~25.6°C
		Relative Humidity :	37~39%
Test Voltage :	120Vac / 60Hz	Phase :	Line

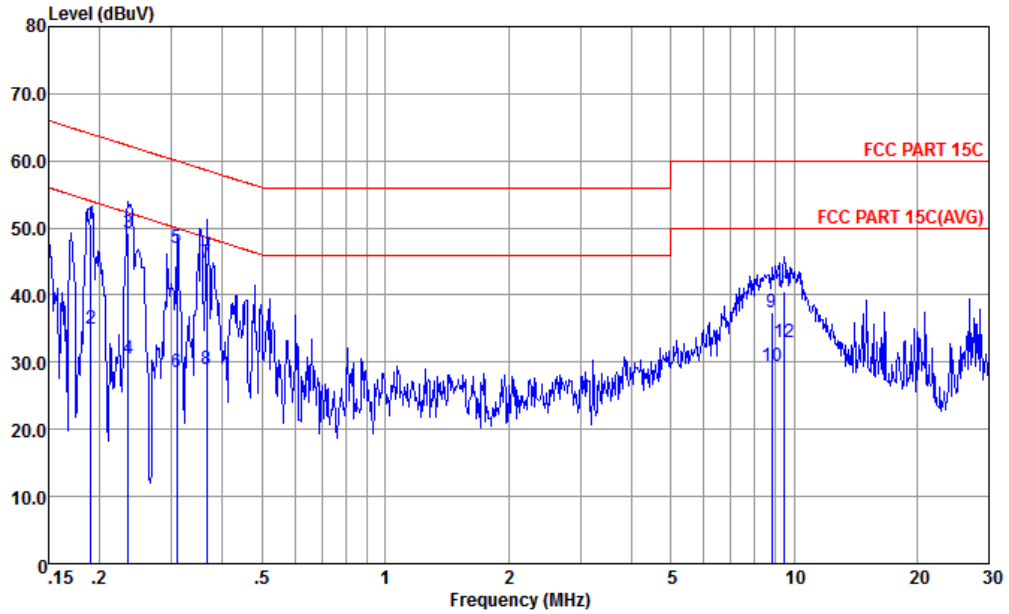

Site : CO01-KS
Condition : FCC PART 15C LISN-060105-L LINE

	Freq	Level	Over	Limit	Read	LISN	Cable	Remark
	MHz	dBuV	Limit	Line	Level	Factor	Loss	
			dB	dBuV	dBuV	dB	dB	
1	0.190	50.62	-13.40	64.02	40.20	0.04	10.38	QP
2	0.190	35.02	-19.00	54.02	24.60	0.04	10.38	Average
3 *	0.235	49.29	-12.97	62.26	38.90	0.05	10.34	QP
4	0.235	30.59	-21.67	52.26	20.20	0.05	10.34	Average
5	0.308	46.97	-13.05	60.02	36.60	0.07	10.30	QP
6	0.308	28.57	-21.45	50.02	18.20	0.07	10.30	Average
7	0.365	44.86	-13.75	58.61	34.50	0.08	10.28	QP
8	0.365	28.86	-19.75	48.61	18.50	0.08	10.28	Average
9	8.822	37.34	-22.66	60.00	26.80	0.21	10.33	QP
10	8.822	29.34	-20.66	50.00	18.80	0.21	10.33	Average
11	9.451	40.45	-19.55	60.00	29.89	0.22	10.34	QP
12	9.451	33.05	-16.95	50.00	22.49	0.22	10.34	Average



Test Engineer :	Amos Zhang	Temperature :	24.2~25.6°C
		Relative Humidity :	37~39%
Test Voltage :	120Vac / 60Hz	Phase :	Neutral

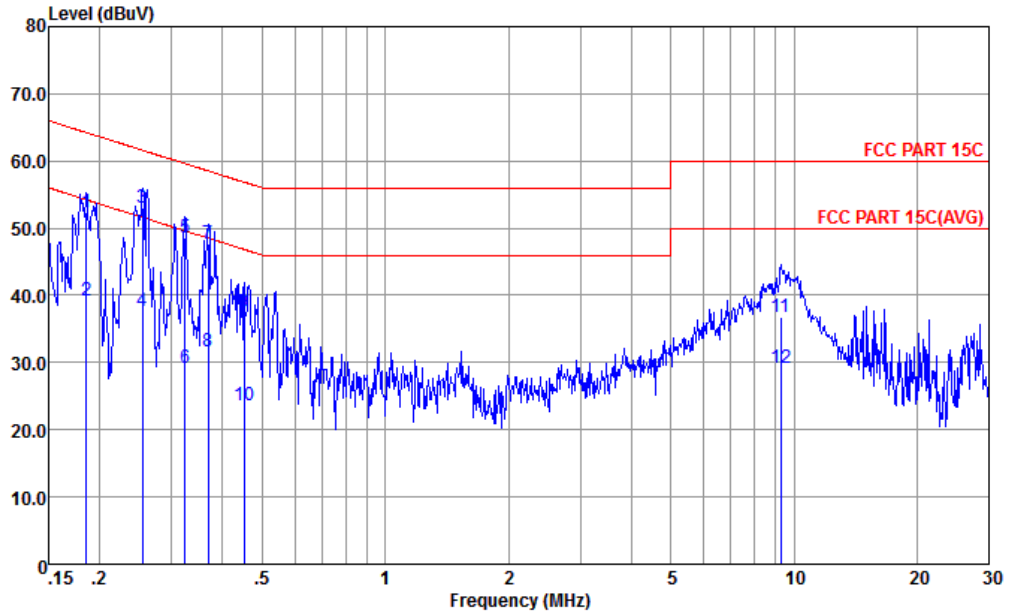

Site : CO01-KS
 Condition : FCC PART 15C LISN-060105-N NEUTRAL

	Freq	Level	Over	Limit	Read	LISN	Cable	Remark
	MHz	dBuV	Limit	Line	Level	Factor	Loss	
			dB	dBuV	dBuV	dB	dB	
1	0.185	52.30	-11.94	64.24	41.81	0.10	10.39	QP
2	0.185	39.30	-14.94	54.24	28.81	0.10	10.39	Average
3 *	0.255	53.03	-8.57	61.60	42.60	0.10	10.33	QP
4	0.255	37.63	-13.97	51.60	27.20	0.10	10.33	Average
5	0.323	48.60	-11.02	59.62	38.20	0.10	10.30	QP
6	0.323	29.20	-20.42	49.62	18.80	0.10	10.30	Average
7	0.369	47.58	-10.94	58.52	37.20	0.10	10.28	QP
8	0.369	31.68	-16.84	48.52	21.30	0.10	10.28	Average
9	0.452	37.46	-19.39	56.85	27.10	0.11	10.25	QP
10	0.452	23.66	-23.19	46.85	13.30	0.11	10.25	Average
11	9.302	36.76	-23.24	60.00	26.21	0.22	10.33	QP
12	9.302	29.16	-20.84	50.00	18.61	0.22	10.33	Average

Note:

- Level(dBμV) = Read Level(dBμV) + LISN Factor(dB) + Cable Loss(dB)
- Over Limit(dB) = Level(dBμV) – Limit Line(dBμV)



Appendix C. Radiated Spurious Emission

902~928MHz

FSK 50K (Band Edge @ 3m)

Note	Frequency (MHz)	Level (dBμV/m)	Over Limit (dB)	Limit Line (dBμV/m)	Read Level (dBμV)	Antenna Factor (dB/m)	Cable Loss (dB)	Preamp Factor (dB)	Ant Pos (cm)	Table Pos (deg)	Peak Avg. (P/A)	Pol. (H/V)
902.2MHz	902.03	119.35	-	-	117.88	29.06	4.78	32.37	200	0	P	H
	962.17	39.8	-14.2	54	36.07	30.52	4.94	31.73	200	0	P	H
	902.03	116.97	-	-	115.5	29.06	4.78	32.37	100	0	P	V
	971.87	41.26	-12.74	54	37.45	30.47	4.97	31.63	100	0	P	V
915MHz	914.64	119.43	-	-	117.37	29.47	4.82	32.23	200	0	P	H
	983.51	40.29	-13.71	54	36.41	30.4	5	31.52	200	0	P	H
	914.64	115.67	-	-	113.61	29.47	4.82	32.23	100	0	P	V
	962.17	40.03	-13.97	54	36.3	30.52	4.94	31.73	100	0	P	V
927.8MHz	927.25	119.19	-	-	116.56	29.88	4.85	32.1	200	0	P	H
	977.69	38.83	-15.17	54	35	30.43	4.98	31.58	200	0	P	H
	927.25	114.31	-	-	111.68	29.88	4.85	32.1	100	0	P	V
	973.81	39.86	-14.14	54	36.04	30.46	4.97	31.61	100	0	P	V
Remark	<ol style="list-style-type: none"> No other spurious found. All results are PASS against Peak and Average limit line. Non-restricted band limit is 100kHz-PSD down 20dB. 											



FSK 50K (Harmonic @ 3m)

	Note	Frequency	Level	Over Limit	Limit Line	Read Level	Antenna Factor	Cable Loss	Preamp Factor	Ant Pos	Table Pos	Peak Avg.	Pol.
		(MHz)	(dBμV/m)	(dB)	(dBμV/m)	(dBμV)	(dB/m)	(dB)	(dB)	(cm)	(deg)	(P/A)	(H/V)
902.4MHz		1801	36.1	-63.25	99.35	65.19	28.86	6.77	64.72	300	0	P	H
		2706.6	40.32	-33.68	74	65.99	31.07	8.35	65.09	300	0	P	H
		1801	35.49	-61.48	96.97	64.58	28.86	6.77	64.72	100	0	P	V
		2706.6	39.24	-34.76	74	64.91	31.07	8.35	65.09	100	0	P	V
914.8MHz		1828	34.26	-65.17	99.43	63.09	29.05	6.84	64.72	300	360	P	H
		2745	40.84	-33.16	74	66.48	31.04	8.43	65.11	300	360	P	H
		1828	35.24	-60.43	95.67	64.07	29.05	6.84	64.72	100	360	P	V
		2746	38.83	-35.17	74	64.47	31.04	8.43	65.11	100	360	P	V
927.6MHz		1855	34.81	-64.38	99.19	63.51	29.15	6.87	64.72	300	360	P	H
		2783.4	39.35	-34.65	74	64.97	31.01	8.49	65.12	300	360	P	H
		1855	35.99	-58.32	94.31	64.69	29.15	6.87	64.72	100	360	P	V
		2783.4	39.69	-34.31	74	65.31	31.01	8.49	65.12	100	360	P	V
Remark	1. No other spurious found. 2. All results are PASS against Peak and Average limit line. 3. Non-restricted band limit is 100kHz-PSD down 20dB.												



FSK 150K (Band Edge @ 3m)

	Note	Frequency	Level	Over Limit	Limit Line	Read Level	Antenna Factor	Cable Loss	Preamp Factor	Ant Pos	Table Pos	Peak Avg.	Pol.
		(MHz)	(dBμV/m)	(dB)	(dBμV/m)	(dBμV)	(dB/m)	(dB)	(dB)	(cm)	(deg)	(P/A)	(H/V)
902.4MHz		902.03	119.27	-	-	117.8	29.06	4.78	32.37	200	0	P	H
		985.45	39.37	-14.63	54	35.47	30.39	5.01	31.5	200	0	P	H
		902.03	116.91	-	-	115.44	29.06	4.78	32.37	100	0	P	V
		974.78	40.87	-13.13	54	37.04	30.45	4.98	31.6	100	0	P	V
914.8MHz		914.64	119.48	-	-	117.42	29.47	4.82	32.23	200	0	P	H
		982.54	40.47	-13.53	54	36.6	30.4	5	31.53	200	0	P	H
		914.64	115.63	-	-	113.57	29.47	4.82	32.23	100	0	P	V
		970.9	40.45	-13.55	54	36.66	30.47	4.96	31.64	100	0	P	V
927.6MHz		927.25	119.27	-	-	116.64	29.88	4.85	32.1	200	0	P	H
		970.9	39.74	-14.26	54	35.95	30.47	4.96	31.64	200	0	P	H
		927.25	114.35	-	-	111.72	29.88	4.85	32.1	100	0	P	V
		988.36	39.6	-14.4	54	35.68	30.37	5.02	31.47	100	0	P	V
Remark	<ol style="list-style-type: none"> No other spurious found. All results are PASS against Peak and Average limit line. Non-restricted band limit is 100kHz-PSD down 20dB. 												



FSK 150K (Harmonic @ 3m)

	Note	Frequency	Level	Over Limit	Limit Line	Read Level	Antenna Factor	Cable Loss	Preamp Factor	Ant Pos	Table Pos	Peak Avg.	Pol.
		(MHz)	(dBμV/m)	(dB)	(dBμV/m)	(dBμV)	(dB/m)	(dB)	(dB)	(cm)	(deg)	(P/A)	(H/V)
902.4MHz		1801	35	-64.27	99.27	64.09	28.86	6.77	64.72	100	360	P	H
		2710	41.17	-32.83	74	66.83	31.06	8.38	65.1	100	360	P	H
		1801	35.38	-61.53	96.91	64.47	28.86	6.77	64.72	300	360	P	V
		2707.2	40.88	-33.12	74	66.55	31.07	8.35	65.09	300	360	P	V
914.8MHz		1828	35.35	-64.13	99.48	64.18	29.05	6.84	64.72	200	0	P	H
		2746	37.21	-36.79	74	62.85	31.04	8.43	65.11	200	0	P	H
		1828	35.6	-60.03	95.63	64.43	29.05	6.84	64.72	100	0	P	V
		2746	37.02	-36.98	74	62.66	31.04	8.43	65.11	100	0	P	V
927.6MHz		1855	35.48	-63.79	99.27	64.18	29.15	6.87	64.72	300	0	P	H
		2782	37.09	-36.91	74	62.71	31.01	8.49	65.12	300	0	P	H
		1855	35.29	-59.06	94.35	63.99	29.15	6.87	64.72	100	0	P	V
		2782	36.89	-37.11	74	62.51	31.01	8.49	65.12	100	0	P	V
Remark	<ol style="list-style-type: none"> No other spurious found. All results are PASS against Peak and Average limit line. Non-restricted band limit is 100kHz-PSD down 20dB. 												



FSK 250K (Band Edge @ 3m)

	Note	Frequency	Level	Over Limit	Limit Line	Read Level	Antenna Factor	Cable Loss	Preamp Factor	Ant Pos	Table Pos	Peak Avg.	Pol.
		(MHz)	(dBμV/m)	(dB)	(dBμV/m)	(dBμV)	(dB/m)	(dB)	(dB)	(cm)	(deg)	(P/A)	(H/V)
902.5MHz		902.03	119.25	-	-	117.78	29.06	4.78	32.37	200	0	P	H
		982.54	39.81	-14.19	54	35.94	30.4	5	31.53	200	0	P	H
		902.03	116.84	-	-	115.37	29.06	4.78	32.37	100	0	P	V
		983.51	39.91	-14.09	54	36.03	30.4	5	31.52	100	0	P	V
915MHz		914.64	119.48	-	-	117.42	29.47	4.82	32.23	200	0	P	H
		978.66	39.75	-14.25	54	35.9	30.43	4.99	31.57	200	0	P	H
		914.64	115.64	-	-	113.58	29.47	4.82	32.23	100	0	P	V
		978.66	40.61	-13.39	54	36.76	30.43	4.99	31.57	100	0	P	V
927.5MHz		927.25	119.23	-	-	116.6	29.88	4.85	32.1	200	0	P	H
		987.39	39.14	-14.86	54	35.23	30.38	5.01	31.48	200	0	P	H
		927.25	114.27	-	-	111.64	29.88	4.85	32.1	100	0	P	V
		975.75	39.37	-14.63	54	35.55	30.44	4.98	31.6	100	0	P	V
Remark	<ol style="list-style-type: none"> No other spurious found. All results are PASS against Peak and Average limit line. Non-restricted band limit is 100kHz-PSD down 20dB. 												



FSK 250K (Harmonic @ 3m)

	Note	Frequency	Level	Over Limit	Limit Line	Read Level	Antenna Factor	Cable Loss	Preamp Factor	Ant Pos	Table Pos	Peak Avg.	Pol.
		(MHz)	(dBμV/m)	(dB)	(dBμV/m)	(dBμV)	(dB/m)	(dB)	(dB)	(cm)	(deg)	(P/A)	(H/V)
902.5MHz		1801	37.24	-62.01	99.25	66.33	28.86	6.77	64.72	300	0	P	H
		2710	42.87	-31.13	74	68.53	31.06	8.38	65.1	300	0	P	H
		1801	35.83	-61.01	96.84	64.92	28.86	6.77	64.72	100	0	P	V
		2710	42.29	-31.71	74	67.95	31.06	8.38	65.1	100	0	P	V
915MHz		1828	35.83	-63.65	99.48	64.66	29.05	6.84	64.72	300	0	P	H
		2746	42.16	-31.84	74	67.8	31.04	8.43	65.11	300	0	P	H
		1828	36.58	-59.06	95.64	65.41	29.05	6.84	64.72	100	0	P	V
		2746	41.26	-32.74	74	66.9	31.04	8.43	65.11	100	0	P	V
927.5MHz		1855	35.31	-63.92	99.23	64.08	29.52	6.43	64.72	100	0	P	H
		2782	43.15	-30.85	74	69.24	31.01	8.02	65.12	100	0	P	H
		1855	36.29	-57.98	94.27	65.06	29.52	6.43	64.72	100	0	P	V
		2782	40.95	-33.05	74	67.04	31.01	8.02	65.12	100	0	P	V
Remark	1. No other spurious found. 2. All results are PASS against Peak and Average limit line. 3. Non-restricted band limit is 100kHz-PSD down 20dB.												



Note symbol

*	Fundamental Frequency which can be ignored. However, the level of any unwanted emissions shall not exceed the level of the fundamental frequency.
!	Test result is over limit line.
P/A	Peak or Average
H/V	Horizontal or Vertical



A calculation example for radiated spurious emission is shown as below:

BLE	Note	Frequency (MHz)	Level (dBμV/m)	Over Limit (dB)	Limit Line (dBμV/m)	Read Level (dBμV)	Antenna Factor (dB/m)	Path Loss (dB)	Preamp Factor (dB)	Ant Pos (cm)	Table Pos (deg)	Peak Avg. (P/A)	Pol. (H/V)
BLE CH 00		2390	55.45	-18.55	74	54.51	32.22	4.58	35.86	103	308	P	H
2402MHz		2390	43.54	-10.46	54	42.6	32.22	4.58	35.86	103	308	A	H

1. Path Loss(dB) = Cable loss(dB) + Filter loss(dB) + Attenuator loss(dB)
2. Level(dBμV/m) =
Antenna Factor(dB/m) + Path Loss(dB) + Read Level(dBμV) - Preamp Factor(dB)
3. Over Limit(dB) = Level(dBμV/m) – Limit Line(dBμV/m)

For Peak Limit @ 2390MHz:

1. Level(dBμV/m)
= Antenna Factor(dB/m) + Path Loss(dB) + Read Level(dBμV) - Preamp Factor(dB)
= 32.22(dB/m) + 4.58(dB) + 54.51(dBμV) – 35.86 (dB)
= 55.45 (dBμV/m)
2. Over Limit(dB)
= Level(dBμV/m) – Limit Line(dBμV/m)
= 55.45(dBμV/m) – 74(dBμV/m)
= -18.55(dB)

For Average Limit @ 2390MHz:

1. Level(dBμV/m)
= Antenna Factor(dB/m) + Path Loss(dB) + Read Level(dBμV) - Preamp Factor(dB)
= 32.22(dB/m) + 4.58(dB) + 42.6(dBμV) – 35.86 (dB)
= 43.54 (dBμV/m)
2. Over Limit(dB)
= Level(dBμV/m) – Limit Line(dBμV/m)
= 43.54(dBμV/m) – 54(dBμV/m)
= -10.46(dB)

Both peak and average measured complies with the limit line, so test result is “PASS”.